

THE
ENCYCLOPEDIA
BRITANNICA

ELIVENTH
EDITION

VOL. X
EVA TO FRA



THE
ENCYCLOPÆDIA BRITANNICA
 ELEVENTH EDITION

FIRST	edition, published in three	volumes,	1768—1771.
SECOND	„ „ ten	„	1777—1784.
THIRD	„ „ eighteen	„	1788—1797.
FOURTH	„ „ twenty	„	1801—1810.
FIFTH	„ „ twenty	„	1815—1817.
SIXTH	„ „ twenty	„	1823—1824.
SEVENTH	„ „ twenty-one	„	1830—1842.
EIGHTH	„ „ twenty-two	„	1853—1860.
NINTH	„ „ twenty-five	„	1875—1889.
TENTH	„ ninth edition and eleven		
	supplementary volumes,		1902—1903.
ELEVENTH	„ published in twenty-nine volumes,		1910—1911.

COPYRIGHT
in all countries subscribing to the
Bern Convention
by
THE CHANCELLOR, MASTERS AND SCHOLARS
of the
UNIVERSITY OF CAMBRIDGE

All rights reserved

THE
ENCYCLOPÆDIA BRITANNICA

A
DICTIONARY
OF
ARTS, SCIENCES, LITERATURE AND GENERAL
INFORMATION

ELEVENTH EDITION

VOLUME X
EVANGELICAL CHURCH to FRANCIS JOSEPH



Cambridge, England:
at the University Press
New York, 35 West 32nd Street
1910

AE 5
E 3
NR

Copyright, in the United States of America, 1910,
by
The Encyclopædia Britannica Company

WABLL LHM
UAR THAS

INITIALS USED IN VOLUME X. TO IDENTIFY INDIVIDUAL
CONTRIBUTORS,¹ WITH THE HEADINGS OF THE
ARTICLES IN THIS VOLUME SO SIGNED.

A. B. R.	ALFRED BARTON RENDLE, M.A., D.Sc., F.R.S., F.L.S. Keeper, Department of Botany, British Museum. Author of <i>Text Book on Classification of Flowering Plants</i> ; &c.	} Flower.
A. D.	AUSTIN DOBSON, LL.D. See the biographical article: DOBSON, H. AUSTIN.	} Fielding, Henry.
A. F. B.	ALDRED FARRER BARKER, M.Sc. Professor of Textile Industries at Bradford Technical College.	} Felt.
A. F. P.	ALBERT FREDERICK POLLARD, M.A., F.R.HIST.SOC. Professor of English History in the University of London. Fellow of All Souls' College, Oxford. Assistant Editor of the <i>Dictionary of National Biography</i> , 1893-1901. Lothian Prizeman, Oxford, 1892; Arnold Prizeman, 1898. Author of <i>England under Protector Somerset</i> ; <i>Henry VIII.</i> ; <i>Life of Thomas Cranmer</i> ; &c.	} Ferrar, Bishop; } Fox, Edward; } Fox, Richard.
A. G.	MAJOR ARTHUR GEORGE FREDERICK GRIFFITHS (d. 1908). H.M. Inspector of Prisons, 1878-1896. Author of <i>The Chronicles of Newgate</i> ; <i>Secrets of the Prison House</i> ; &c.	} Finger Prints.
A. Go.*	REV. ALEXANDER GORDON, M.A. Lecturer on Church History in the University of Manchester.	} Faber, Basil, Jacobus and } Johann; } Familists; Farel, G.; Flacius.
A. H.-S.	SIR A. HOUTUM-SCHINDLER, C.I.E. General in the Persian Army. Author of <i>Eastern Persian Irak</i> .	} Fars; } Firuzabad.
A. L.	ANDREW LANG. See the biographical article: LANG, ANDREW.	} Falry; } Family.
A. L. B.	ALFRED LYS BALDRY. Art Critic of the <i>Globe</i> , 1893-1908. Author of <i>Modern Mural Decoration</i> and biographies of Albert Moore, Sir H. von Herkomer, R.A., Sir J. E. Millais, P.R.A., Marcus Stone, R.A., and G. H. Boughton, R.A.	} Fortuny.
A. N.	ALFRED NEWTON, F.R.S. See the biographical article: NEWTON, ALFRED.	} Falcon; Fieldfare; Finch } Flycatcher; Fowl.
A. S.	ARTHUR SMITHELLS, F.R.S. Professor of Chemistry in the University of Leeds. Author of <i>Scientific Papers on Flame and Spectrum Analysis</i> .	} Flame.
A. M. C.	AGNES MARY CLERKE. See the biographical article: CLERKE, A. M.	} Flamsteed.
A. W.	ARTHUR WATSON. Secretary in the Academic Department, University of London.	} Examinations (<i>in part</i>)
A. W. R.	ALEXANDER WOOD RENTON, M.A., LL.B. Puisne Judge of the Supreme Court of Ceylon. Editor of <i>Encyclopaedia of the Laws of England</i> .	} Fixtures; } Flat.
A. W. W.	ADOLPHUS WILLIAM WARD, D.LITT., LL.D. See the biographical article: WARD, A. W.	} Foote, Samuel; } Ford, John.
C. El.	SIR CHARLES NORTON EDGCUMBE ELIOT, K.C.M.G., C.B., M.A., LL.D., D.C.L. Vice-Chancellor of Sheffield University. Formerly Fellow of Trinity College, Oxford. H.M.'s Commissioner and Commander-in-Chief for the British East Africa Protectorate; Agent and Consul-General at Zanzibar; Consul-General for German East Africa, 1900-1904.	} Finno-Ugrian.
C. F. B.	CHARLES FRANCIS BASTABLE, M.A., LL.D. Regius Professor of Laws and Professor of Political Economy in the University of Dublin. Author of <i>Public Finance</i> ; <i>Commerce of Nations</i> ; <i>Theory of International Trade</i> ; &c.	} Finance.
C. F. C.	C. F. CROSS, B.Sc. (Lond.), F.C.S., F.I.C. Analytical and Consulting Chemist.	} Fibres.

¹ A complete list, showing all individual contributors, appears in the final volume.

INITIALS AND HEADINGS OF ARTICLES

- C. F. R.** CHARLES FRANCIS RICHARDSON, A.M., PH.D.
Professor of English at Dartmouth College, Hanover, New Hampshire, U.S.A.
Author of *A Story of English Rhyme*; *A History of American Literature*; &c. { **Fiske, John.**
- C. H. T.*** CRAWFORD HOWELL TOY, A.M.
See the biographical article: TOY, CRAWFORD HOWELL. { **Ezekiel.**
- C. J.** CHARLES JOINSON, M.A.
Clerk in H.M. Public Record Office. Joint Editor of the *Domesday Survey* for the
Victoria County History: Norfolk. { **Exchequer (in part).**
- C. J. B. M.** CHARLES JOHN BRUCE MARRIOTT, M.A.
Clare College, Cambridge. Secretary of the Rugby Football Union. { **Football: Rugby (in part).**
- C. J. N. F.** CHARLES JAMES NICOL FLEMING.
H.M. Inspector of Schools, Scotch Education Department. { **Football: Rugby (in part).**
- C. L. K.** CHARLES LETHBRIDGE KINGSFORD, M.A., F.R.HIST.SOC., F.S.A.
Assistant Secretary to the Board of Education. Author of *Life of Henry V.* Editor
of *Chronicles of London* and *Stow's Survey of London.* { **Fabyan;
Fastoff.**
- C. P. I.** SIR COURTENAY PEREGRINE ILBERT, K.C.B., K.C.S.I., C.I.E.
Clerk of the House of Commons. Chairman of Statute Law Committee. Parli-
amentary Counsel to the Treasury, 1899-1901. Legal Member of Council of Govern-
ment-General of India, 1882-1886; President, 1886. Fellow of the British Academy.
Formerly Fellow and Tutor of Balliol College, Oxford. Author of *The Government
of India*; *Legislative Method and Forms.* { **Evidence.**
- C. W. A.** CHARLES WILLIAM ALCOCK (d. 1907).
Formerly Secretary of the Football Association, London. { **Football: Association (in part).**
- D. H.** DAVID HANNAY.
Formerly British Vice-Consul at Barcelona. Author of *Short History of the Royal
Navy*; *Life of Emilio Castelar*; &c. { **First of June, Battle of the;
Fox, Charles James.**
- D. Mn.** REV. DUGALD MACFADYEN, M.A.
Minister of South Grove Congregational Church, Highgate. Director of the London
Missionary Society. { **Excommunication.**
- D. N. P.** DIARMID NOEL PATON, M.D., F.R.C.P. (Edin.).
Regius Professor of Physiology in the University of Glasgow. Formerly Super-
intendent of Research Laboratory of Royal College of Physicians, Edinburgh.
Biological Fellow of Edinburgh University, 1884. Author of *Essentials of Human
Physiology*; &c. { **Fever.**
- D. S. M.*** DAVID SAMUEL MARGOLIOUTH, M.A., D.LITT.
Laudian Professor of Arabic, Oxford. Fellow of New College. Author of *Arabic
Papyri of the Bodleian Library*; *Mohammed and the Rise of Islam*; *Cairo, Jerusalem
and Damascus.* { **Fatimites.**
- E. B.** EDWARD BRECK, M.A., PH.D.
Formerly Foreign Correspondent of the *New York Herald* and the *New York Times*.
Author of *Fencing*; *Wilderness Pets*; *Sporting in Nova Scotia*; &c. { **Foll-fencing;
Football: American (in part).**
- E. Ca.** EGERTON CASTLE, M.A., F.S.A.
Trinity College, Cambridge. Author of *Schools and Masters of Fence*; &c. { **Fencing.**
- Ed. C.*** THE HON. EDWARD EVAN CHARTERIS.
Barrister-at-Law, Inner Temple. { **Fair (in part).**
- E. C. B.** RT. REV. EDWARD CUTHBERT BUTLER, O.S.B., M.A., D.LITT.
Abbot of Downside Abbey, Bath. Author of "The Lausiac History of Palladius,"
in *Cambridge Texts and Studies*, vol. vi. { **Fontevrault;
Francis of Assisi, St;
Francis of Paola, St.**
- E. C. Q.** EDMUND CROSBY QUIGGIN, M.A.
Fellow and Lecturer in Modern Languages and Monro Lecturer in Celtic,
Gonville and Caius College, Cambridge. { **Finn mac Cool.**
- E. D. R.** LIEUT.-COLONEL EMILIUS C. DELMÉ RADCLIFFE.
Author of *Falconry: Notes on the Falconidae used in India in Falconry.* { **Falconry.**
- E. E. A.** ERNEST E. AUSTEN.
Assistant in Department of Zoology, Natural History Museum, South Kensington. { **Flea.**
- E. E. H.** REV. EDWARD EVERETT HALE.
See the biographical article: HALE, E. E. { **Everett, Edward.**
- E. G.** EDMUND GOSSE, LL.D.
See the biographical article: GOSSE, EDMUND. { **Ewald, Johannes; Fabliau;
Fabre, Ferdinand; Feuillet;
Finland: Literature;
FitzGerald, Edward; Flaubert;
Flemish Literature; Forssell.**
- E. H. P.** EDWARD HENRY PALMER, M.A.
See the biographical article: PALMER, E. H. { **Firdousi (in part).**
- E. K.** EDMUND KNECHT, PH.D., M.SC.TECH. (Manchester), F.I.C.
Professor of Technological Chemistry, Manchester University. Head of Chemical
Department, Municipal School of Technology, Manchester. Examiner in Dyeing,
City and Guilds of London Institute. Author of *A Manual of Dyeing*; &c. Editor
of *Journal of the Society of Dyers and Colourists.* { **Finishing.**
- E. M. Ha.** ERNEST MAES HARVEY.
Partner in Messrs. Allen Harvey & Ross, Bullion Brokers, London. { **Exchange.**

- E. O.*** EDMUND OWEN, M.B., F.R.C.S., LL.D., D.Sc.
Consulting Surgeon to St Mary's Hospital, London, and to the Children's Hospital, Great Ormond Street, London. Chevalier of the Legion of Honour. Late Examiner in Surgery at the University of Cambridge, London and Durham. Author of *A Manual of Anatomy for Senior Students*. } **Fistula.**
- E. O. S.** EDWIN OTHO SACHS, F.R.S. (Edin.), A.M.INST.M.E.
Chairman of the British Fire Prevention Committee. Vice-President, National Fire Brigades Union. Vice-President, International Fire Service Council. Author of *Fires and Public Entertainments*; &c. } **Fire and Fire Extinction.**
- E. Pr.** EDGAR PRESTAGE.
Special Lecturer in Portuguese Literature at the University of Manchester. Comendador, Portuguese Order of S. Thiago. Corresponding Member of Lisbon Royal Academy of Sciences and Lisbon Geographical Society. } **Falcao;
Ferreira.**
- E. Re.** ELISÉE RECLUS.
See the biographical article: RECLUS, J. J. E. } **Fire.**
- E. Tn.** REV. ETHELRED LEONARD TAUNTON, (d. 1907).
Author of *The English Black Monks of St Benedict*; *History of the Jesuits in England*. } **Feckenham;
Fisher, John.**
- E. W. H.** ERNEST WILLIAM HOBSON, M.A., D.Sc., F.R.S., F.R.A.S.
Fellow and Tutor in Mathematics, Christ's College, Cambridge. Stokes Lecturer in Mathematics in the University. } **Fourier's Series.**
- F. C. C.** FREDERICK CORNWALLIS CONYBEARE, M.A., D.TH. (Giessen).
Fellow of the British Academy. Formerly Fellow of University College, Oxford. Author of *The Ancient Armenian Texts of Aristotle*; *Myth, Magic and Morals*; &c. } **Extreme Unction.**
- F. G. P.** FREDERICK GYMER PARSONS, F.R.C.S., F.Z.S., F.R.ANTHROP.INST.
Vice-President, Anatomical Society of Great Britain and Ireland. Lecturer on Anatomy at St Thomas's Hospital and the London School of Medicine for Women. Formerly Hunterian Professor at the Royal College of Surgeons. } **Eye: Anatomy.**
- F. J. H.** FRANCIS JOHN HAVERFIELD, M.A., LL.D., F.S.A.
Camden Professor of Ancient History in the University of Oxford. Fellow of Brasenose College. Ford's Lecturer, 1906-1907. Fellow of the British Academy. Author of Monographs on Roman History, especially Roman Britain; &c. } **Fosse.**
- F. J. W.** FREDERICK JOSEPH WALL, F.C.S.
Secretary to the Football Association. } **Football: Association (in part).**
- F. R. C.** FRANK R. CANA.
Author of *South Africa from the Great Trek to the Union*. } **France: Colonies.**
- F. S.** FRANCIS STORR, M.A.
Editor of the *Journal of Education*, London. Officier d'Académie, Paris. } **Fable.**
- G. A. B.** GEORGE A. BOULENGER, D.Sc., PH.D., F.R.S.
In charge of the Collections of Reptiles and Fishes, Department of Zoology, British Museum. Vice-President of the Zoological Society of London. } **Flat-fish.**
- G. A. Be.** GEORGE ANDREAS BERRY, M.B., F.R.C.S., F.R.S. (Edin.).
Hon. Surgeon Oculist to His Majesty in Scotland. Formerly Senior Ophthalmic Surgeon, Edinburgh Royal Infirmary, and Lecturer on Ophthalmology in the University of Edinburgh. Vice-President, Ophthalmological Society. Author of *Diseases of the Eye*; *The Elements of Ophthalmoscopic Diagnosis*; *Subjective Symptoms in Eye Diseases*; &c. } **Eye: Diseases.**
- G. B. A.** GEORGE BURTON ADAMS, A.M., B.D., PH.D., LITT.D.
Professor of History, Yale University. Editor of *American Historical Review*. Author of *Civilization during the Middle Ages*; *Political History of England, 1066-1216*; &c. } **Feudalism.**
- G. C. L.** GEORGE COLLINS LEVEY, C.M.G.
Member of Board of Advice to Agent-General of Victoria. Formerly Editor and Proprietor of the *Melbourne Herald*. Secretary, Colonial Committee of Royal Commission to Paris Exhibition, 1900. Secretary, Adelaide Exhibition, 1887. Secretary, Royal Commission, Hobart Exhibition, 1894-1895. Secretary to Commissioners for Victoria at the Exhibitions in London, Paris, Vienna, Philadelphia and Melbourne, 1873, 1876, 1878, 1880-1881. } **Exhibition.**
- G. E.** REV. GEORGE EDMUNDSON, M.A., F.R.HIST.S.
Formerly Fellow and Tutor of Brasenose College, Oxford. Ford's Lecturer, 1909. Hon. Member, Dutch Historical Society, and Foreign Member, Netherlands Association of Literature. } **Flanders.**
- G. F. Z.** GEORGE FREDERICK ZIMMER, A.M.INST.C.E.
Author of *Mechanical Handling of Material*. } **Flour and Flour Manufacture.**
- G. G. P.*** GEORGE GRENVILLE PHILLIMORE, M.A., B.C.L.
Christ Church, Oxford. Barrister-at-Law, Middle Temple. } **Fishery, Law of.**
- G. P.** GIFFORD PINCHOT, A.M., D.Sc., LL.D.
Professor of Forestry, Yale University. Formerly Chief Forester, U.S.A. President of the National Conservation Association. Member of the Society of American Foresters, Royal English Arboricultural Society, &c. Author of *The White Pine*; *A Primer of Forestry*; &c. } **Forests and Forestry:
United States.**
- G. W. T.** REV. GRIFFITHS WHEELER THATCHER, M.A., B.D.
Warden of Camden College, Sydney, N.S.W. Formerly Tutor in Hebrew and Old Testament History at Mansfield College, Oxford. } **Fairūzābādī;
Fakhr ud-Dīn Rāzī;
Fārābī; Farazdaq.**

INITIALS AND HEADINGS OF ARTICLES

- C. F. R.** CHARLES FRANCIS RICHARDSON, A.M., PH.D.
Professor of English at Dartmouth College, Hanover, New Hampshire, U.S.A.
Author of *A Story of English Rhyme*; *A History of American Literature*; &c. { **Fiske, John.**
- C. H. T.*** CRAWFORD HOWELL TOY, A.M.
See the biographical article: TOY, CRAWFORD HOWELL. { **Ezekiel.**
- C. J.** CHARLES JOHNSON, M.A.
Clerk in H.M. Public Record Office. Joint Editor of the *Domesday Survey* for the
Victoria County History: Norfolk. { **Exchequer (in part).**
- C. J. B. M.** CHARLES JOHN BRUCE MARRIOTT, M.A.
Clare College, Cambridge. Secretary of the Rugby Football Union. { **Football: Rugby (in part).**
- C. J. N. F.** CHARLES JAMES NICOL FLEMING.
H.M. Inspector of Schools, Scotch Education Department. { **Football: Rugby (in part).**
- C. L. K.** CHARLES LETHBRIDGE KINGSFORD, M.A., F.R.HIST.SOC., F.S.A.
Assistant Secretary to the Board of Education. Author of *Life of Henry V.* Editor
of *Chronicles of London* and *Stow's Survey of London.* { **Fabyan;
Fastolf.**
- C. P. I.** SIR COURTENAY PEREGRINE ILBERT, K.C.B., K.C.S.I., C.I.E.
Clerk of the House of Commons. Chairman of Statute Law Committee. Parlia-
mentary Counsel to the Treasury, 1899-1901. Legal Member of Council of Govern-
ment of India, 1882-1886; President, 1886. Fellow of the British Academy.
Formerly Fellow and Tutor of Balliol College, Oxford. Author of *The Government
of India*; *Legislative Method and Forms.* { **Evidence.**
- C. W. A.** CHARLES WILLIAM ALCOCK (d. 1907).
Formerly Secretary of the Football Association, London. { **Football: Association (in part).**
- D. H.** DAVID HANNAY.
Formerly British Vice-Consul at Barcelona. Author of *Short History of the Royal
Navy*; *Life of Emilio Castelar*; &c. { **First of June, Battle of the;
Fox, Charles James.**
- D. Mn.** REV. DUGALD MACFADYEN, M.A.
Minister of South Grove Congregational Church, Highgate. Director of the London
Missionary Society. { **Excommunication.**
- D. N. P.** DIARMID NOEL PATON, M.D., F.R.C.P. (Edin.).
Regius Professor of Physiology in the University of Glasgow. Formerly Super-
intendent of Research Laboratory of Royal College of Physicians, Edinburgh.
Biological Fellow of Edinburgh University, 1884. Author of *Essentials of Human
Physiology*; &c. { **Fever.**
- D. S. M.*** DAVID SAMUEL MARGOLIOUTH, M.A., D.LITT.
Laudian Professor of Arabic, Oxford. Fellow of New College. Author of *Arabic
Papyri of the Bodleian Library*; *Mohammed and the Rise of Islam*; *Cairo, Jerusalem
and Damascus.* { **Fatimites.**
- E. B.** EDWARD BRECK, M.A., PH.D.
Formerly Foreign Correspondent of the *New York Herald* and the *New York Times*.
Author of *Fencing*; *Wilderness Pets*; *Sporting in Nova Scotia*; &c. { **Foil-fencing;
Football: American (in part).**
- E. Ca.** EGERTON CASTLE, M.A., F.S.A.
Trinity College, Cambridge. Author of *Schools and Masters of Fence*; &c. { **Fencing.**
- Ed. C.*** THE HON. EDWARD EVAN CHARTERIS.
Barrister-at-Law, Inner Temple. { **Fair (in part).**
- E. C. B.** RT. REV. EDWARD CUTHBERT BUTLER, O.S.B., M.A., D.LITT.
Abbot of Downside Abbey, Bath. Author of "The Lausiac History of Palladius,"
in *Cambridge Texts and Studies*, vol. vi. { **Fontevrault;
Francis of Assisi, St;
Francis of Paola, St.**
- E. C. Q.** EDMUND CROSBY QUIGGIN, M.A.
Fellow and Lecturer in Modern Languages and Monro Lecturer in Celtic,
Gonville and Caius College, Cambridge. { **Finn mac Cool.**
- E. D. R.** LIEUT.-COLONEL EMILIUS C. DELMÉ RADCLIFFE.
Author of *Falconry: Notes on the Falconidae used in India in Falconry.* { **Falconry.**
- E. E. A.** ERNEST E. AUSTEN.
Assistant in Department of Zoology, Natural History Museum, South Kensington. { **Flea.**
- E. E. H.** REV. EDWARD EVERETT HALE.
See the biographical article: HALE, E. E. { **Everett, Edward.**
- E. G.** EDMUND GOSSE, LL.D.
See the biographical article: GOSSE, EDMUND. { **Ewald, Johannes; Fabliau;
Fabre, Ferdinand; Feuillet;
Finland: Literature;
FitzGerald, Edward; Flaubert;
Flemish Literature; Forssell.**
- E. H. P.** EDWARD HENRY PALMER, M.A.
See the biographical article: PALMER, E. H. { **Firdousi (in part).**
- E. K.** EDMUND KNECHT, PH.D., M.Sc.TECH. (Manchester), F.I.C.
Professor of Technological Chemistry, Manchester University. Head of Chemical
Department, Municipal School of Technology, Manchester. Examiner in Dyeing,
City and Guilds of London Institute. Author of *A Manual of Dyeing*; &c. Editor
of *Journal of the Society of Dyers and Colourists.* { **Finishng.**
- E. M. Ha.** ERNEST MAES HARVEY.
Partner in Messrs. Allen Harvey & Ross, Bullion Brokers, London. { **Exchange.**

- E. O.*** EDMUND OWEN, M.B., F.R.C.S., LL.D., D.Sc.
Consulting Surgeon to St Mary's Hospital, London, and to the Children's Hospital, Great Ormond Street, London. Chevalier of the Legion of Honour. Late Examiner in Surgery at the University of Cambridge, London and Durham. Author of *A Manual of Anatomy for Senior Students*. { **Fistula.**
- E. O. S.** EDWIN OTHO SACHS, F.R.S. (Edin.), A.M.INST.M.E.
Chairman of the British Fire Prevention Committee. Vice-President, National Fire Brigades Union. Vice-President, International Fire Service Council. Author of *Fires and Public Entertainments*; &c. { **Fire and Fire Extinction.**
- E. Pr.** EDGAR PRESTAGE.
Special Lecturer in Portuguese Literature at the University of Manchester. Comendador, Portuguese Order of S. Thiago. Corresponding Member of Lisbon Royal Academy of Sciences and Lisbon Geographical Society. { **Falcao;**
Ferreira.
- E. Re.** ELISÉE RECLUS.
See the biographical article: RECLUS, J. J. E. { **Fire.**
- E. Th.** REV. ETHELRED LEONARD TAUNTON, (d. 1907).
Author of *The English Black Monks of St Benedict; History of the Jesuits in England*. { **Feckenham;**
Fisher, John.
- E. W. H.** ERNEST WILLIAM HOBSON, M.A., D.Sc., F.R.S., F.R.A.S.
Fellow and Tutor in Mathematics, Christ's College, Cambridge. Stokes Lecturer in Mathematics in the University. { **Fourier's Series.**
- F. C. C.** FREDERICK CORNWALLIS CONYBEARE, M.A., D.Th. (Giessen).
Fellow of the British Academy. Formerly Fellow of University College, Oxford. Author of *The Ancient Armenian Texts of Aristotle; Myth, Magic and Morals*; &c. { **Extreme Unction.**
- F. G. P.** FREDERICK GYMER PARSONS, F.R.C.S., F.Z.S., F.R.A.NTHROP.INST.
Vice-President, Anatomical Society of Great Britain and Ireland. Lecturer on Anatomy at St Thomas's Hospital and the London School of Medicine for Women. Formerly Hunterian Professor at the Royal College of Surgeons. { **Eye: Anatomy.**
- F. J. H.** FRANCIS JOHN HAVERFIELD, M.A., LL.D., F.S.A.
Camden Professor of Ancient History in the University of Oxford. Fellow of Brasenose College. Ford's Lecturer, 1906-1907. Fellow of the British Academy. Author of Monographs on Roman History, especially Roman Britain; &c. { **Fosse.**
- F. J. W.** FREDERICK JOSEPH WALL, F.C.S.
Secretary to the Football Association. { **Football: Association (in pari).**
- F. R. C.** FRANK R. CANA.
Author of *South Africa from the Great Trek to the Union*. { **France: Colonies.**
- F. S.** FRANCIS STORR, M.A.
Editor of the *Journal of Education*, London. Officier d'Académie, Paris. { **Fable.**
- G. A. B.** GEORGE A. BOULENGER, D.Sc., PH.D., F.R.S.
In charge of the Collections of Reptiles and Fishes, Department of Zoology, British Museum. Vice-President of the Zoological Society of London. { **Flat-fish.**
- G. A. Be.** GEORGE ANDREAS BERRY, M.B., F.R.C.S., F.R.S. (Edin.).
Hon. Surgeon Oculist to His Majesty in Scotland. Formerly Senior Ophthalmic Surgeon, Edinburgh Royal Infirmary, and Lecturer on Ophthalmology in the University of Edinburgh. Vice-President, Ophthalmological Society. Author of *Diseases of the Eye; The Elements of Ophthalmoscopic Diagnosis; Subjective Symptoms in Eye Diseases*; &c. { **Eye: Diseases.**
- G. B. A.** GEORGE BURTON ADAMS, A.M., B.D., PH.D., LITT.D.
Professor of History, Yale University. Editor of *American Historical Review*. Author of *Civilization during the Middle Ages; Political History of England, 1066-1216*; &c. { **Feudalism.**
- G. C. L.** GEORGE COLLINS LEVEY, C.M.G.
Member of Board of Advice to Agent-General of Victoria. Formerly Editor and Proprietor of the *Melbourne Herald*. Secretary, Colonial Committee of Royal Commission to Paris Exhibition, 1900. Secretary, Adelaide Exhibition, 1887. Secretary, Royal Commission, Hobart Exhibition, 1894-1895. Secretary to Commissioners for Victoria at the Exhibitions in London, Paris, Vienna, Philadelphia and Melbourne, 1873, 1876, 1878, 1880-1881. { **Exhibition.**
- G. E.** REV. GEORGE EDMUNDSON, M.A., F.R.HIST.S.
Formerly Fellow and Tutor of Brasenose College, Oxford. Ford's Lecturer, 1909. Hon. Member, Dutch Historical Society, and Foreign Member, Netherlands Association of Literature. { **Flanders.**
- G. F. Z.** GEORGE FREDERICK ZIMMER, A.M.INST.C.E.
Author of *Mechanical Handling of Material*. { **Flour and Flour Manufacture.**
- G. G. P.*** GEORGE GRENVILLE PHILLIMORE, M.A., B.C.L.
Christ Church, Oxford. Barrister-at-Law, Middle Temple. { **Fishery, Law of.**
- G. P.** GIFFORD PINCHOT, A.M., D.Sc., LL.D.
Professor of Forestry, Yale University. Formerly Chief Forester, U.S.A. President of the National Conservation Association. Member of the Society of American Foresters, Royal English Arboricultural Society, &c. Author of *The White Pine; A Primer of Forestry*; &c. { **Forests and Forestry:**
United States.
- G. W. T.** REV. GRIFFITHS WHEELER THATCHER, M.A., B.D.
Warden of Camden College, Sydney, N.S.W. Formerly Tutor in Hebrew and Old Testament History at Mansfield College, Oxford. { **Fairūzābādī;**
Fakhr ud-Din Rāzi;
Fārābī; Farazdaq.

- H. B. S.** REV. HENRY BARCLAY SWETE, M.A., D.D., LITT.D.
Regius Professor of Divinity, Cambridge University. Fellow of Gonville and Caius College, Cambridge. Fellow of King's College, London. Fellow of British Academy. Hon. Canon of Ely Cathedral. Author of *The Holy Spirit in the New Testament*; &c. } **Fathers of the Church.**
- H. Ch.** HUGH CHISHOLM, M.A.
Formerly Scholar of Corpus Christi College, Oxford. Editor of the 11th Edition of the *Encyclopaedia Britannica*; Co-Editor of the 10th edition. } **Forster.**
- H. De.** HIPPOLYTE DELEHAYE, S.J.
Assistant in the compilation of the Bollandist publications: *Analecta Bollandiana* and *Acta Sanctorum*. } **Fiacre, Saint;
Florlan, Saint.**
- H. F. G.** HANS FRIEDRICH GADOW, F.R.S., PH.D.
Strickland Curator and Lecturer on Zoology in the University of Cambridge. Author of "Amphibia and Reptiles," in the *Cambridge Natural History*. } **Flamingo.**
- H. L. S.** H. LAWRENCE SWINBURNE (d. 1909). } **Flag.**
- H. St.** HENRY STURT, M.A.
Author of *Idola Theatri*; *The Idea of a Free Church*; *Personal Idealism*. } **Fechner;
Feuerbach, Ludwig A.**
- H. W. C. D.** HENRY WILLIAM CARLESS DAVIS, M.A.
Fellow and Tutor of Balliol College, Oxford. Fellow of All Souls' College, Oxford, 1895-1902. Author of *England under the Normans and Angevins*; *Charlemagne*. } **Fitz Neal;
Fitz Peter, Geoffrey;
Fitz Stephen, William;
Fitz Thedmar; Flambar; Florence of Worcester.**
- H. W. S.** H. WICKHAM STEED.
Correspondent of *The Times* at Vienna. Correspondent of *The Times* at Rome, 1897-1902. } **Fabrizi.**
- I. A.** ISRAEL ABRAHAMS, M.A.
Reader in Talmudic and Rabbinic Literature, University of Cambridge. President, Jewish Historical Society of England. Author of *A Short History of Jewish Literature*; *Jewish Life in the Middle Ages*. } **Exllarch;
Eybeschutz.**
- J. A. C.** SIR JOSEPH ARCHER CROWE, K.C.M.G.
See the biographical article: CROWE, SIR JOSEPH A. } **Eyck, Van.**
- J. A. H.** JOHN ALLEN HOWE, B.Sc.
Curator and Librarian of the Museum of Practical Geology, London. Author of *The Geology of Building Stones*. } **France: Geology.**
- J. A. S.** JOHN ADDINGTON SYMONDS, LL.D.
See the biographical article: SYMONDS, JOHN A. } **Ficino;
Filelfo.**
- J. B.*** JOSEPH BURTON.
Partner in Pilkington's Tile and Pottery Co., Clifton Junction, Manchester. } **Flebrick (in part).**
- J. B. P.** JAMES BELL PETTIGREW, M.D., LL.D., F.R.S., F.R.C.P. (Edin.) (1834-1908).
Chandos Professor of Medicine and Anatomy, University of St Andrews, 1875-1908. Author of *Animal Locomotion*; &c. } **Flight and Flying (in part).**
- J. Bt.** JAMES BARTLETT.
Lecturer on Construction, Architecture, Sanitation, Quantities, &c., at King's College, London. Member of Society of Architects. Member of Institute of Junior Engineers. } **Foundations.**
- J. C. M.** JAMES CLERK MAXWELL, LL.D.
See the biographical article: MAXWELL, JAMES CLERK. } **Faraday.**
- J. E. C. B.** JOHN EDWARD COURTENAY BODLEY, M.A.
Balliol College, Oxford. Corresponding Member of the Institute of France. Author of *France*; *The Coronation of Edward VII.*; &c. } **France: History, 1870-1910.**
- J. E. P. W.** JOHN EDWARD POWER WALLIS, M.A.
Puisne Judge, Madras. Vice-Chancellor of Madras University. Inns of Court Reader in Constitutional Law, 1892-1897. Formerly Editor of *State Trials*. } **Extradition.**
- J. F. St.** JOHN FREDERICK STENNING, M.A.
Dean and Fellow of Wadham College, Oxford. University Lecturer in Aramaic. Lecturer in Divinity and Hebrew at Wadham College. } **Exodus, Book of.**
- J. G. H.** JOSEPH G. HORNER, A.M.I.MECH.E.
Author of *Plating and Boiler Making*; *Practical Metal Turning*; &c. } **Forging;
Founding.**
- J. G. R.** JOHN GEORGE ROBERTSON, M.A., PH.D.
Professor of German at the University of London. Formerly Lecturer on the English Language, Strassburg University. Author of *History of German Literature*; &c. } **Fouqué, Baron.**
- J. H. P.*** JOHN HUNGERFORD POLLEN, M.A. (d. 1908).
Formerly Professor of Fine Arts in Catholic University of Dublin. Fellow of Merton College, Oxford. Cantor Lecturer, Society of Arts, 1885. Author of *Ancient and Modern Furniture and Woodwork*; *Ancient and Modern Gold and Silversmith's Work*; *The Trajan Column*; &c. } **Fan.**
- J. Hl. R.** JOHN HOLLAND ROSE, M.A., LITT.D.
Lecturer on Modern History to the Cambridge University Local Lectures Syndicate. Author of *Life of Napoleon I.*; *Napoleonic Studies*; *The Development of the European Nations*; *The Life of Pitt*; chapters in the *Cambridge Modern History*. } **Fouché.**
- J. H. R.** JOHN HORACE ROUND, M.A., LL.D. (Edin.).
Author of *Feudal England*; *Studies in Peerage and Family History*; *Peerage and Pedigree*; &c. } **Ferrers: Family;
Fitzgerald: Family.**

- J. I.** JULES ISAAC.
Professor of History at the Lycée of Lyons. } Francis I. of France.
- J. K. L.** SIR JOHN KNOX LAUGHTON, M.A., LITT.D.
Professor of Modern History, King's College, London. Secretary of the Navy Records Society. Served in the Baltic, 1854-1855; in China, 1856-1859. Mathematical and Naval Instructor, Royal Naval College, Portsmouth, 1866-1873; Greenwich, 1873-1885. President, Royal Meteorological Society, 1882-1884. Honorary Fellow, Gonville and Caius College, Cambridge. Fellow, King's College, London. Author of *Physical Geography in its Relation to the Prevailing Winds and Currents*; *Studies in Naval History*; *Sea Fights and Adventures*; &c. } Farragut; Fitzroy.
- J. L. B.** JULIAN LEVETT BAKER, F.I.C.
Analytical and Consulting Chemist. Examiner in Brewing to the City and Guilds of London Institute, Department of Technology. Hon. Secretary of the Institute of Brewing. Author of *The Brewing Industry*; &c. } Fermentation.
- J. Ma.** JOHN MACDONALD. } Fair (in part).
- J. M. S.** JAMES MONTGOMERY STUART.
Author of *The History of Free Trade in Tuscany; Reminiscences and Essays*. } Foscolo.
- J. Pa.** JAMES PATON, F.L.S.
Superintendent of Museums and Art Galleries of Corporation of Glasgow. Assistant in Museum of Science and Art, Edinburgh, 1861-1876. President of Museums Association of United Kingdom, 1896. Editor and part-author of *Scottish National Memorials*, 1890. } Feather (in part).
- J. P. E.** JEAN PAUL HIPPOLYTE EMMANUEL ADHÉMAR ESMEIN.
Professor of Law in the University of Paris. Officer of the Legion of Honour. Member of the Institute of France. Author of *Cours élémentaire d'histoire du droit français*; &c. } France: Law and Institutions.
- J. R. C.** JOSEPH ROGERSON COTTER, M.A.
Assistant to the Professor of Natural and Experimental Philosophy, Trinity College, Dublin. Editor of 2nd edition of Preston's *Theory of Heat*. } Fluorescence.
- J. R. F.*** JOSEPH R. FISHER.
Editor of the *Northern Whig*, Belfast. Author of *Finland and the Tsars*; *Law of the Press*; &c. } Finland.
- J. R. J. J.** JULIAN ROBERT JOHN JOCELYN.
Colonel, R.A. Formerly Commandant, Ordnance College; Member of Ordnance Committee; Commandant, Schools of Gunnery. } Fireworks: History.
- J. S. Bl.** REV. JOHN SUTHERLAND BLACK, M.A., LL.D.
Assistant Editor, 9th edition, *Encyclopaedia Britannica*. Joint Editor of the *Encyclopaedia Biblica*. Translated Ritschl's *Critical History of the Christian Doctrine of Justification and Reconciliation*. } Fasting; Feasts and Festivals.
- J. S. F.** JOHN SMITH FLETT, D.Sc., F.G.S.
Petrographer to the Geological Survey. Formerly Lecturer on Petrology in Edinburgh University. Neill Medallist of the Royal Society of Edinburgh. Bigsby Medallist of the Geological Society of London. } Felsite; Flint.
- J. S. K.** JOHN SCOTT KELTIE, LL.D., F.S.S., F.S.A. (Scot.).
Secretary, Royal Geographical Society. Knight of Swedish Order of North Star. Commander of the Norwegian Order of St Olaf. Hon. Member, Geographical Societies of Paris, Berlin, Rome, &c. Editor of *Statesman's Year Book*. Editor of the *Geographical Journal*. } Finland (in part); Flinders.
- J. T. Be.** JOHN T. BEALBY.
Joint Author of Stanford's *Europe*. Formerly Editor of the *Scottish Geographical Magazine*. Translator of Sven Hedin's *Through Asia, Central Asia and Tibet*; &c. } Fens; Ferghana (in part).
- K. S.** KATHLEEN SCHLESINGER.
Author of *The Instruments of the Orchestra*. } Fiddle; Fife; Flageolet; Flute (in part).
- L. D.*** LOUIS DUCHESNE.
See the biographical article: DUCHESNE, L. M. O. } Formosus.
- L. F. S.** LESLIE FREDERIC SCOTT, M.A., K.C.
Barrister-at-Law, Inner Temple. } Factor.
- L. J.** LIEUT.-COLONEL LOUIS CHARLES JACKSON, R.E., C.M.G.
Assistant Director of Fortifications and Works, War Office. Formerly Instructor in Fortification, R.M.A., Woolwich. Instructor in Fortification and Military Engineering, School of Military Engineering, Chatham. } Fortification and Siegecraft.
- L. V.*** LUIGI VILLARI.
Italian Foreign Office (Emigration Dept.). Formerly Newspaper Correspondent in east of Europe. Italian Vice-Consul in New Orleans, 1906; Philadelphia, 1907; Boston, U.S.A., 1907-1910. Author of *Italian Life in Town and Country*; *Fire and Sword in the Caucasus*; &c. } Faliero; Fantl, Manfredo; Farini, Luigi Carlo; Farnese: Family; Ferdinand I. and IV. of Naples; Ferdinand II. of the Two Sicilies; Fiesco; Filangieri, G.; Florence; Foscari; Fossombroni; Francis II. of the Two Sicilies; Francis IV. and V. of Modena.

INITIALS AND HEADINGS OF ARTICLES

- M. Ha.** MARCUS HARTOG, M.A., D.Sc., F.L.S.
Professor of Zoology, University College, Cork. Author of "Protozoa," in *Cambridge Natural History*; and papers for various scientific journals. { **Flagellata;**
Foraminifera.
- N. W. T.** NORTHCOTE WHITBRIDGE THOMAS, M.A.
Government Anthropologist to Southern Nigeria. Corresponding Member of the Société d'Anthropologie de Paris. Author of *Thought Transference*; *Kinship and Marriage in Australia*; &c. { **Faith Healing;**
Fetichism;
Folklore.
- O. H.*** OTTO HEHNER, F.I.C., F.C.S.
Public Analyst. Formerly President of Society of Public Analysts. Vice-President of Institute of Chemistry of Great Britain and Ireland. Author of works on Butter Analysis; Alcohol Tables; &c. { **Food Preservation.**
- O. M.** DAVID ORME MASSON, M.A., D.Sc., F.R.S.
Professor of Chemistry, Melbourne University. Author of papers on chemistry in the transactions of various learned societies. { **Fireworks: Modern.**
- P. A.** PAUL DANIEL ALPHANDÉRY.
Professor of the History of Dogma, École Pratique des Hautes Études, Sorbonne, Paris. Author of *Les Idées morales chez les hétérodoxes latines au début du XIII^e siècle.* { **Flagellants.**
- P. A. K.** PRINCE PETER ALEXEIVITCH KROPOTKIN.
See the biographical article: KROPOTKIN, P. A. { **Ferghana (in part);**
Finland (in part).
- P. C. Y.** PHILIP CHESNEY YORKE, M.A.
Magdalen College, Oxford. { **Falkland; Fanshaw;**
Fawkes, Guy; Fell, John;
Fortescue, Sir John.
- P. C. M.** PETER CHALMERS MITCHELL, F.R.S., F.Z.S., D.Sc., LL.D.
Secretary to the Zoological Society of London. University Demonstrator in Comparative Anatomy and Assistant to Linacre Professor at Oxford, 1881-1891. Examiner in Zoology to the University of London, 1903. Author of *Outlines of Biology*; &c. { **Evolution.**
- P. G. K.** PAUL GEORGE KONODY.
Art Critic of the *Observer* and the *Daily Mail*. Formerly Editor of *The Artist*. Author of *The Art of Walter Crane*; *Velasquez, Life and Work*; &c. { **Fiorenzo di Lorenzo;**
Fragonard.
- P. J. H.** PHILIP JOSEPH HARTOG, M.A., L. ès Sc. (Paris).
Academic Registrar of the University of London. Author of *The Writing of English*, and articles in the Special Reports on educational subjects of the Board of Education. { **Examinations (in part).**
- P. W.** PAUL WIRIATH.
Director of the École Supérieure Pratique de Commerce et d'Industrie, Paris. { **France: History to 1870.**
- R. Ad.** ROBERT ADAMSON, LL.D.
See the biographical article: ADAMSON, R. { **Fichte;**
Fourier, F. C. M.
- R. A. S. M.** ROBERT ALEXANDER STEWART MACALISTER, M.A., F.S.A.
St John's College, Cambridge. Director of Excavations for the Palestine Exploration Fund. { **Font.**
- R. H. C.** REV. ROBERT HENRY CHARLES, M.A., D.D., D.LITT. (Oxon.).
Grinfield Lecturer and Lecturer in Biblical Studies, Oxford. Fellow of the British Academy. Formerly Senior Moderator of Trinity College, Dublin. Author and Editor of *Book of Enoch*; *Book of Jubilees*; *Apocalypse of Baruch*; *Assumption of Moses*; *Ascension of Isaiah*; *Testaments of the XII. Patriarchs*; &c. { **Ezra: Third and Fourth Books of.**
- R. J. M.** RONALD JOHN MCNEILL, M.A.
Christ Church, Oxford. Barrister-at-Law. Formerly Editor of the *St James's Gazette*, London. { **Fenlans;**
Fitzgerald, Lord Edward;
Flood, Henry.
- R. L.*** RICHARD LYDEKKER, F.R.S., F.G.S., F.Z.S.
Member of the Staff of the Geological Survey of India, 1874-1882. Author of *Catalogue of Fossil Mammals, Reptiles and Birds in British Museum*; *The Deer of all Lands*; *The Game Animals of Africa*; &c. { **Flying-Squirrel;**
Fox.
- R. N. B.** ROBERT NISBET BAIN (d. 1909).
Assistant Librarian, British Museum, 1883-1909. Author of *Scandinavia: the Political History of Denmark, Norway and Sweden, 1513-1900*; *The First Romanovs, 1613-1725*; *Slavonic Europe: the Political History of Poland and Russia from 1469 to 1796*; &c. { **Fersen, Counts von.**
- R. Po.** RENÉ POUPARDIN, D. ès L.
Secretary of the École des Chartes. Honorary Librarian at the Bibliothèque Nationale, Paris. Author of *Le Royaume de Provence sous les Carolingiens*; *Recueil des chartes de Saint-Germain*; &c. { **Franche-Comté.**
- R. P. S.** R. PHENÉ SPIERS, F.S.A., F.R.I.B.A.
Formerly Master of the Architectural School, Royal Academy, London. Past President of Architectural Association. Associate and Fellow of King's College, London. Corresponding Member of the Institute of France. Editor of *Fergusson's History of Architecture*. Author of *Architecture: East and West*; &c. { **Flute: Architecture.**
- R. S. C.** ROBERT SEYMOUR CONWAY, M.A., D.LITT. (Cantab.).
Professor of Latin and Indo-European Philology in the University of Manchester. Formerly Professor of Latin in University College, Cardiff; and Fellow of Gonville and Caius College, Cambridge. Author of *The Italic Dialects*. { **Falisc.**
- R. Tr.** ROLAND TRUSLOVE, M.A.
Formerly Scholar of Christ Church, Oxford. Fellow, Dean and Lecturer in Classics at Worcester College, Oxford. { **France: Statistics.**

- S. A. C.** STANLEY ARTHUR COOK, M.A.
Editor for Palestine Exploration Fund. Lecturer in Hebrew and Syriac, and formerly Fellow, Gonville and Caius College, Cambridge. Examiner in Hebrew and Aramaic, London University, 1904-1908. Author of *Glossary of Aramaic Inscriptions*; *The Laws of Moses and the Code of Hammurabi*; *Critical Notes on Old Testament History*; *Religion of Ancient Palestine*; &c.
- S. C.** SIDNEY COLVIN, LL.D.
See the biographical article: COLVIN, S.
- St C.** VISCOUNT ST CYRES.
See the biographical article: IDDESLEIGH, 1ST EARL OF
- S. E. B.** HON. SIMEON EBEN BALDWIN, M.A., LL.D.
Professor of Constitutional and Private International Law in Yale University. Director of the Bureau of Comparative Law of the American Bar Association. Formerly Chief Justice of Connecticut. Author of *Modern Political Institutions*; *American Railroad Law*; &c.
- S. E. S.-R.** STEPHEN EDWARD SPRING-RICE, M.A., C.B. (1856-1902).
Formerly Principal Clerk, H.M. Treasury, and Auditor of the Civil List. Fellow of Trinity College, Cambridge.
- T. A. I.** THOMAS ALLAN INGRAM, M.A., LL.D.
Trinity College, Dublin.
- T. As.** THOMAS ASHBY, M.A., D.LITT. (Oxon.), F.S.A.
Director of British School of Archaeology at Rome. Formerly Scholar of Christ Church, Oxford. Craven Fellow, 1897. Corresponding Member of the Imperial German Archaeological Institute. Author of the *Classical Topography of the Roman Campagna*; &c.
- T. Ba.** SIR THOMAS BARCLAY, M.P.
Member of the Institute of International Law. Member of the Supreme Council of the Congo Free State. Officer of the Legion of Honour. Author of *Problems of International Practice and Diplomacy*; &c. M.P. for Blackburn, 1910.
- T. H. H.*** SIR THOMAS HUNGERFORD HOLDICH, K.C.M.G., K.C.I.E., D.Sc., F.R.G.S.
Colonel in the Royal Engineers. Superintendent, Frontier Surveys, India, 1892-1898. Gold Medallist, R.G.S., London, 1887. H.M. Commissioner for the Persia-Beluch Boundary, 1896. Author of *The Indian Borderland*; *The Gates of India*; &c.
- T. K. C.** REV. THOMAS KELLY CHEYNE, D.D.
See the biographical article: CHEYNE, T. K.
- T. Se.** THOMAS SECCOMBE, M.A.
Lecturer in History, East London and Birkbeck Colleges, University of London. Stanhope Prizeman, Oxford, 1887. Formerly Assistant Editor of *Dictionary of National Biography*, 1891-1901. Joint-author of *The Bookman History of English Literature*. Author of *The Age of Johnson*; &c.
- T. Wo.** THOMAS WOODHOUSE.
Head of Weaving and Textile Designing Department, Technical College, Dundee.
- V. M.** VICTOR CHARLES MAHILLON.
Principal of the Conservatoire Royal de Musique at Brussels. Chevalier of the Legion of Honour.
- W. A. B. C.** REV. WILLIAM AUGUSTUS BREVOORT COOLIDGE, M.A., F.R.G.S., Ph.D. (Bern).
Fellow of Magdalen College, Oxford. Professor of English History, St David's College, Lampeter, 1880-1881. Author of *Guide to Switzerland*; *The Alps in Nature and in History*; &c. Editor of the *Alpine Journal*, 1880-1889.
- W. A. P.** WALTER ALISON PHILLIPS, M.A.
Formerly Exhibitioner of Merton College and Senior Scholar of St John's College, Oxford. Author of *Modern Europe*; &c.
- W. B.*** WILLIAM BURTON, M.A., F.C.S.
Chairman, Joint Committee of Pottery Manufacturers of Great Britain. Author of *English Stoneware and Earthenware*; &c.
- W. Ca.** WALTER CAMP, A.M.
Member of Yale University Council. Author of *American Football*; *Football Facts and Figures*; &c.
- W. Ga.** WALTER GARSTANG, M.A., D.Sc.
Professor of Zoology at the University of Leeds. Scientific Adviser to H.M. Delegates on the International Council for the Exploration of the Sea, 1901-1907. Formerly Fellow of Lincoln College, Oxford. Author of *The Races and Migrations of the Mackerel*; *The Impoverishment of the Sea*; &c.
- W. He.** WALTER HEPWORTH.
Formerly Commissioner of the Council of Education, Science and Art Department, South Kensington.
- W. M. R.** WILLIAM MICHAEL ROSSETTI.
See the biographical article: ROSSETTI, DANTE G.
- Exodus, The; Ezra and Nehemiah, Books of**
- Fine Arts; Finiguerra; Flaxman.**
- Fénelon.**
- Extradition: U.S.A.**
- Exchequer (in part).**
- Explosives: Law.**
- Faesulae; Falerii; Falerio; Fanum Fortunae; Ferentino; Fermo; Flaminia Via; Florence: Early History; Fondi; Fonnli; Forum Appii.**
- Exterritoriality.**
- Everest, Mount.**
- Eve (in part).**
- Fawcett, Henry.**
- Flax.**
- Flute (in part).**
- Feldkirch.**
- Excellency; Faust; Febronianism.**
- Firebrick (in part).**
- Football: American (in part).**
- Fishes.**
- Fool.**
- Ferrari, Gaudenzio; Fielding, Copley; Franceschi, Plero; Francela.**

W. P. P.	WILLIAM PLANE PYCRAFT, F.Z.S. Assistant in the Zoological Department, British Museum. Formerly Assistant Linacre Professor of Comparative Anatomy, Oxford. Vice-President of the Selborne Society. Author of <i>A History of Birds</i> ; &c.	Feather (in part).
W. N. S.	WILLIAM NAPIER SHAW, M.A., LL.D., D.Sc., F.R.S. Director of the Meteorological Office. Reader in Meteorology in the University of London. President of Permanent International Meteorological Committee. Member of Meteorological Council, 1897-1905. Hon. Fellow of Emmanuel College, Cambridge. Fellow of Emmanuel College, 1877-1899; Senior Tutor, 1890-1899. Joint Author of <i>Text Book of Practical Physics</i> ; &c.	Fog.
W. P. R.	HON. WILLIAM PEMBER REEVES. Director of London School of Economics. Agent-General and High Commissioner for New Zealand, 1896-1909. Minister of Education, Labour and Justice, New Zealand, 1891-1896. Author of <i>The Long White Cloud, a History of New Zealand</i> ; &c.	Fox, Sir William.
W. R. S.	WILLIAM ROBERTSON SMITH, LL.D. See the biographical article: SMITH, W. R.	Eve (in part).
W. R. E. H.	WILLIAM RICHARD EATON HODGKINSON, Ph.D., F.R.S. Professor of Chemistry and Physics, Ordnance College, Woolwich. Formerly Professor of Chemistry and Physics, R.M.A., Woolwich. Part Author of Valentin-Hodgkinson's <i>Practical Chemistry</i> ; &c.	Explosives.
W. Sch.	SIR WILHELM SCHLICH, K.C.I.E., M.A., Ph.D., F.R.S., F.L.S. Professor of Forestry at the University of Oxford. Hon. Fellow of St John's College. Author of <i>A Manual of Forestry</i> ; <i>Forestry in the United Kingdom</i> ; <i>The Outlook of the World's Timber Supply</i> ; &c.	Forests and Forestry.
W. W. F.*	WILLIAM WARDE FOWLER, M.A. Fellow of Lincoln College, Oxford. Sub-rector, 1881-1904. Gifford Lecturer, Edinburgh University, 1908. Author of <i>The City-State of the Greeks and Romans</i> ; <i>The Roman Festivals of the Republican Period</i> ; &c.	Fortuna.
W. W. R.*	WILLIAM WALKER ROCKWELL, LIC.THEOL. Assistant Professor of Church History, Union Theological Seminary, New York. Author of <i>Die Doppelhe des Landgrafen Philipp von Hessen</i> .	Ferrara-Florence, Council of.

 PRINCIPAL UNSIGNED ARTICLES

Evil Eye.
Excise.
Execution.
Executors and Adminis-
trators.
Exeter.
Exile.
Eylau.
Famine.

Fault.
Federal Government.
Federalist Party.
Fehmle Courts.
Felony.
Fez.
Fezzan.
Fictions.
Fife.

Flg.
Filigree
Fir.
Flves.
Fleurus.
Florida.
Foix.
Fold.
Fontenelle.

Fontenoy.
Foot and Mouth Disease.
Forest Laws.
Fortarshire.
Forgery.
Formosa.
Foundling Hospitals.
Fountain.

ENCYCLOPÆDIA BRITANNICA

ELEVENTH EDITION

VOLUME X

EVANGELICAL CHURCH CONFERENCE, a convention of delegates from the different Protestant churches of Germany. The conference originated in 1848, when the general desire for political unity made itself felt in the ecclesiastical sphere as well. A preliminary meeting was held at Sandhof near Frankfort in June of that year, and on the 21st of September some five hundred delegates representing the Lutheran, the Reformed, the United and the Moravian churches assembled at Wittenberg. The gathering was known as *Kirchentag* (church diet), and, while leaving each denomination free in respect of constitution, ritual, doctrine and attitude towards the state, agreed to act unitedly in bearing witness against the non-evangelical churches and in defending the rights and liberties of the churches in the federation. The organization thus closely resembles that of the Free Church Federation in England. The movement exercised considerable influence during the middle of the 19th century. Though no *Kirchentag*, as such, has been convened since 1871, its place has been taken by the *Kongress für innere Mission*, which holds annual meetings in different towns. There is also a biennial conference of the evangelical churches held at Eisenach to discuss matters of general interest. Its decisions have no legislative force.

EVANGELICAL UNION, a religious denomination which originated in the suspension of the Rev. James Morison (1816–1893), minister of a United Secession congregation in Kilmarnock, Scotland, for certain views regarding faith, the work of the Holy Spirit in salvation, and the extent of the atonement, which were regarded by the supreme court of his church as anti-Calvinistic and heretical. Morison was suspended by the presbytery in 1841 and thereupon definitely withdrew from the Secession Church. His father, who was minister at Bathgate, and two other ministers, being deposed not long afterwards for similar opinions, the four met at Kilmarnock on the 16th of May 1843 (two days before the "Disruption" of the Free Church), and, on the basis of certain doctrinal principles, formed themselves into an association under the name of the Evangelical Union, "for the purpose of countenancing, counselling and otherwise aiding one another, and also for the purpose of training up spiritual and devoted young men to carry forward the work and 'pleasure of the Lord.'" The doctrinal views of the new denomination gradually assumed a more decidedly anti-Calvinistic

form, and they began also to find many sympathizers among the Congregationalists of Scotland. Nine students were expelled from the Congregational Academy for holding "Morisonian" doctrines, and in 1845 eight churches were disjoined from the Congregational Union of Scotland and formed a connexion with the Evangelical Union. The Union exercised no jurisdiction over the individual churches connected with it, and in this respect adhered to the Independent or Congregational form of church government; but those congregations which originally were Presbyterian vested their government in a body of elders. In 1889 the denomination numbered 93 churches; and in 1896, after prolonged negotiation, the Evangelical Union was incorporated with the Congregational Union of Scotland.

See *The Evangelical Union Annual; History of the Evangelical Union*, by F. Ferguson (Glasgow, 1876); *The Worthies of the E.U.* (1883); W. Adamson, *Life of Dr James Morison* (1898).

EVANS, CHRISTMAS (1766–1838), Welsh Nonconformist divine, was born near the village of Llandyssul, Cardiganshire, on the 25th of December 1766. His father, a shoemaker, died early, and the boy grew up as an illiterate farm labourer. At the age of seventeen, becoming servant to a Presbyterian minister, David Davies, he was affected by a religious revival and learned to read and write in English and Welsh. The itinerant Calvinistic Methodist preachers and the members of the Baptist church at Llandyssul further influenced him, and he soon joined the latter denomination. In 1789 he went into North Wales as a preacher and settled for two years in the desolate peninsula of Lley, Carnarvonshire, whence he removed to Llangefni in Anglesey. Here, on a stipend of £17 a year, supplemented by a little tract-selling, he built up a strong Baptist community, modelling his organization to some extent on that of the Calvinistic Methodists. Many new chapels were built, the money being collected on preaching tours which Evans undertook in South Wales.

In 1826 Evans accepted an invitation to Caerphilly, where he remained for two years, removing in 1828 to Cardiff. In 1832, in response to urgent calls from the north, he settled in Carnarvon and again undertook the old work of building and collecting. He was taken ill on a tour in South Wales, and died at Swansea on the 19th of July 1838. In spite of his early disadvantages and personal disfigurement (he had lost an eye in a

youthful brawl), Christmas Evans was a remarkably powerful preacher. To a natural aptitude for this calling, he united a nimble mind and an inquiring spirit; his character was simple, his piety humble and his faith fervently evangelical. For a time he came under Sandemanian influence, and when the Wesleyans entered Wales he took the Calvinist side in the bitter controversies that were frequent from 1800 to 1810. His chief characteristic was a vivid and affluent imagination, which absorbed and controlled all his other powers, and earned for him the name of "the Bunyan of Wales."

His works were edited by Owen Davies in 3 vols. (Carnarvon, 1895-1897). See the *Lives* by D. R. Stephens (1847) and Paxton Hood (1883).

EVANS, EVAN HERBER (1836-1896), Welsh Nonconformist divine, was born on the 5th of July 1836, at Pant yr Onen near Newcastle Emlyn, Cardiganshire. As a boy he saw something of the "Rebecca Riots," and went to school at the neighbouring village of Llechryd. In 1853 he went into business, first at Pontypridd and then at Merthyr, but next year made his way to Liverpool. He decided to enter the ministry, and studied arts and theology respectively at the Normal College, Swansea, and the Memorial College, Brecon, his convictions being deepened by the religious revival of 1858-1859. In 1862 he succeeded Thomas Jones as minister of the Congregational church at Morryston near Swansea. In 1865 he became pastor of Salem church, Carnarvon, a charge which he occupied for nearly thirty years despite many invitations to English pastorates. In 1894 he became principal of the Congregational college at Bangor. He died on the 30th of December 1896. He was chairman of the Welsh Congregational Union in 1886 and of the Congregational Union of England and Wales in 1892; and by his earnest ministry, his eloquence and his literary work, especially in the denominational paper *Y Dysgedydd*, he achieved a position of great influence in his country.

See *Life* by H. Elvet Lewis.

EVANS, SIR GEORGE DE LACY (1787-1870), British soldier, was born at Moig, Limerick, in 1787. He was educated at Woolwich Academy, and entered the army in 1806 as a volunteer, obtaining an ensigncy in the 22nd regiment in 1807. His early service was spent in India, but he exchanged into the 3rd Light Dragoons in order to take part in the Peninsular War, and was present in the retreat from Burgos in 1812. In 1813 he was at Vittoria, and was afterwards employed in making a military survey of the passes of the Pyrenees. He took part in the campaign of 1814, and was present at Pampeluna, the Nive and Toulouse; and later in the year he served with great distinction on the staff in General Ross's Bladensburg campaign, and took part in the capture of Washington and of Baltimore and the operations before New Orleans. He returned to England in the spring of 1815, in time to take part in the Waterloo campaign as assistant quartermaster-general on Sir T. Picton's staff. As a member of the staff of the duke of Wellington he accompanied the English army to Paris, and remained there during the occupation of the city by the allies. He was still a substantive captain in the 5th West India regiment, though a lieutenant-colonel by brevet, when he went on half-pay in 1818. In 1830 he was elected M.P. for Rye in the Liberal interest; but in the election of 1832 he was an unsuccessful candidate both for that borough and for Westminster. For the latter constituency he was, however, returned in 1833, and, except in the parliament of 1841-1846, he continued to represent it till 1865, when he retired from political life. His parliamentary duties did not, however, interfere with his career as a soldier. In 1835 he went out to Spain in command of the Spanish Legion, recruited in England, and 9600 strong, which served for two years in the Carlist War on the side of the queen of Spain. In spite of great difficulties the legion won great distinction on the battlefields of northern Spain, and Evans was able to say that no prisoners had been taken from it in action, that it had never lost a gun or an equipage, and that it had taken 27 guns and 1100 prisoners from the enemy. He received several Spanish orders, and on his return in 1839 was made a colonel and K.C.B. In 1846 he became

major-general; and in 1854, on the breaking-out of the Crimean War, he was made lieutenant-general and appointed to command the 2nd division of the Army of the East. At the battle of the Alma, where he received a severe wound, his quick comprehension of the features of the combat largely contributed to the victory. On the 26th of October he defeated a large Russian force which attacked his position on Mount Inkerman. Illness and fatigue compelled him a few days after this to leave the command of his division in the hands of General Pennefather; but he rose from his sick-bed on the day of the battle of Inkerman, the 5th of November, and, declining to take the command of his division from Pennefather, aided him in the long-protracted struggle by his advice. On his return invalided to England in the following February, Evans received the thanks of the House of Commons. He was made a G.C.B., and the university of Oxford conferred on him the degree of D.C.L. In 1861 he was promoted to the full rank of general. He died in London on the 9th of January 1870.

EVANS, SIR JOHN (1823-1908), English archaeologist and geologist, son of the Rev. Dr A. B. Evans, head master of Market Bosworth grammar school, was born at Britwell Court, Bucks, on the 17th of November 1823. He was for many years head of the extensive paper manufactory of Messrs John Dickinson at Nash Mills, Hemel Hempstead, but was especially distinguished as an antiquary and numismatist. He was the author of three books, standard in their respective departments: *The Coins of the Ancient Britons* (1864); *The Ancient Stone Implements, Weapons and Ornaments of Great Britain* (1872, 2nd ed. 1897); and *The Ancient Bronze Implements, Weapons and Ornaments of Great Britain and Ireland* (1881). He also wrote a number of separate papers on archaeological and geological subjects—notably the papers on "Flint Implements in the Drift" communicated in 1860 and 1862 to *Archæologia*, the organ of the Society of Antiquaries. Of that society he was president from 1885 to 1892, and he was president of the Numismatic Society from 1874 to the time of his death. He also presided over the Geological Society, 1874-1876; the Anthropological Institute, 1877-1879; the Society of Chemical Industry, 1892-1893; the British Association, 1897-1898; and for twenty years (1878-1898) he was treasurer of the Royal Society. As president of the Society of Antiquaries he was an *ex officio* trustee of the British Museum, and subsequently he became a permanent trustee. His academic honours included honorary degrees from several universities, and he was a corresponding member of the Institut de France. He was created a K.C.B. in 1892. He died at Berkhamsted on the 31st of May 1908.

His eldest son, ARTHUR JOHN EVANS, born in 1851, was educated at Brasenose College, Oxford, and Göttingen. He became fellow of Brasenose and in 1884 keeper of the Ashmolean Museum at Oxford. He travelled in Finland and Lapland in 1873-1874, and in 1875 made a special study of archaeology and ethnology in the Balkan States. In 1893 he began his investigations in Crete, which have resulted in discoveries of the utmost importance concerning the early history of Greece and the eastern Mediterranean (see *ÆGEAN CIVILIZATION* and *CRETE*). He is a member of all the chief archaeological societies in Europe, holds honorary degrees at Oxford, Edinburgh and Dublin, and is a fellow of the Royal Society. His chief publications are: *Cretan Pictographs and Præ-Phœnician Script* (1896); *Further Discoveries of Cretan and Aegean Script* (1898); *The Mycenaean Tree and Pillar Cult* (1901); *Scripta Minoa* (1909 foll.); and reports on the excavations. He also edited with additions Freeman's *History of Sicily*, vol. iv.

EVANS, OLIVER (1755-1819), American mechanic, was born at Newport, Delaware, in 1755. He was apprenticed to a wheelwright, and at the age of twenty-two he invented a machine for making the card-teeth used in carding wool and cotton. In 1780 he became partner with his brothers, who were practical millers, and soon introduced various labour-saving appliances which both cheapened and improved the processes of flour-milling. Turning his attention to the steam engine, he employed steam at a relatively high pressure, and the plans of his invention which he sent over to England in 1787 and in 1794-1795 are said

to have been seen by R. Trevithick, whom in that case he anticipated in the adoption of the high-pressure principle. He made use of his engine for driving mill machinery; and in 1803 he constructed a steam dredging machine, which also propelled itself on land. In 1819 a disastrous fire broke out in his factory at Pittsburg, and he did not long survive it, dying at New York on the 21st of April 1819.

EVANSON, EDWARD (1731-1805), English divine, was born on the 21st of April 1731 at Warrington, Lancashire. After graduating at Cambridge (Emmanuel College) and taking holy orders, he officiated for several years as curate at Mitcham. In 1768 he became vicar of South Mimms near Barnet; and in November 1769 he was presented to the rectory of Tewkesbury, with which he held also the vicarage of Longdon in Worcestershire. In the course of his studies he discovered what he thought important variance between the teaching of the Church of England and that of the Bible, and he did not conceal his convictions. In reading the service he altered or omitted phrases which seemed to him untrue, and in reading the Scriptures pointed out errors in the translation. A crisis was brought on by his sermon on the resurrection, preached at Easter 1771; and in November 1773 a prosecution was instituted against him in the consistory court of Gloucester. He was charged with "depraving the public worship of God contained in the liturgy of the Church of England, asserting the same to be superstitious and unchristian, preaching, writing and conversing against the creeds and the divinity of our Saviour, and assuming to himself the power of making arbitrary alterations in his performance of the public worship." A protest was at once signed and published by a large number of his parishioners against the prosecution. The case was dismissed on technical grounds, but appeals were made to the court of arches and the court of delegates. Meanwhile Evanson had made his views generally known by several publications. In 1772 appeared anonymously his *Doctrines of a Trinity and the Incarnation of God, examined upon the Principles of Reason and Common Sense*. This was followed in 1777 by *A Letter to Dr Hurd, Bishop of Worcester, wherein the Importance of the Prophecies of the New Testament and the Nature of the Grand Apostasy predicted in them are particularly and impartially considered*. He also wrote some papers on the Sabbath, which brought him into controversy with Joseph Priestley, who published the whole discussion (1792). In the same year appeared Evanson's work entitled *The Dissonance of the four generally received Evangelists*, to which replies were published by Priestley and David Simpson (1793). Evanson rejected most of the books of the New Testament as forgeries, and of the four gospels he accepted only that of St Luke. In his later years he ministered to a Unitarian congregation at Lympton, Devonshire. In 1802 he published *Reflections upon the State of Religion in Christendom*, in which he attempted to explain and illustrate the mysterious foreshadowings of the Apocalypse. This he considered the most important of his writings. Shortly before his death at Colford, near Crediton, Devonshire, on the 25th of September 1805, he completed his *Second Thoughts on the Trinity*, in reply to a work of the bishop of Gloucester.

His sermons (prefaced by a Life by G. Rogers) were published in two volumes in 1807, and were the occasion of T. Falconer's *Bampton Lectures* in 1811. A narrative of the circumstances which led to the prosecution of Evanson was published by N. Havard, the town-clerk of Tewkesbury, in 1778.

EVANSTON, a city of Cook county, Illinois, U.S.A., on the shore of Lake Michigan, 12 m. N. of Chicago. Pop. (1900) 19,259, of whom 4441 were foreign-born; (1910 U. S. census) 24,978. It is served by the Chicago & North-Western, and the Chicago, Milwaukee & St Paul railways, and by two electric lines. The city is an important residential suburb of Chicago. In 1908 the Evanston public library had 41,430 volumes. In the city are the College of Liberal Arts (1855), the Academy (1860), and the schools of music (1895) and engineering (1908) of Northwestern University, co-educational, chartered in 1851, opened in 1855, the largest school of the Methodist Episcopal Church in America. In 1909-1910 it had productive funds amounting to about \$7,500,000, and, including all the allied schools, a faculty of

418 instructors and 4487 students; its schools of medicine (1869), law (1859), pharmacy (1886), commerce (1908) and dentistry (1887) are in Chicago. In 1909 its library had 114,869 volumes and 79,000 pamphlets (exclusive of the libraries of the professional schools in Chicago); and the Garrett Biblical Institute had a library of 25,671 volumes and 4500 pamphlets. The university maintains the Grand Prairie Seminary at Onarga, Iroquois county, and the Elgin Academy at Elgin, Kane county. Enjoying the privileges of the university, though actually independent of it, are the Garrett Biblical Institute (Evanston Theological Seminary), founded in 1855, situated on the university campus, and probably the best-endowed Methodist Episcopal theological seminary in the United States, and affiliated with the Institute, the Norwegian Danish Theological school; and the Swedish Theological Seminary, founded at Galesburg in 1870, removed to Evanston in 1882, and occupying buildings on the university campus until 1907, when it removed to Orrington Avenue and Noyes Street. The Cumnock School of Oratory, at Evanston, also co-operates with the university. By the charter of the university the sale of intoxicating liquors is forbidden within 4 m. of the university campus. The manufacturing importance of the city is slight, but is rapidly increasing. The principal manufactures are wrought iron and steel pipe, bakers' machinery and bricks. In 1905 the value of the factory products was \$2,550,529, being an increase of 207.3% since 1900. In Evanston are the publishing offices of the National Woman's Christian Temperance Union. Evanston was incorporated as a town in 1863 and as a village in 1872, and was chartered as a city in 1892. The villages of North Evanston and South Evanston were annexed to Evanston in 1874 and 1892 respectively.

EVANSVILLE, a city and the county-seat of Vanderburg county, Indiana, U.S.A., and a port of entry, on the N. bank of the Ohio river, 200 m. below Louisville, Kentucky—measuring by the windings of the river, which double the direct distance. Pop. (1890) 50,756; (1900) 59,007; (1910 census) 69,647. Of the total population in 1900, 5518 were negroes, 5626 were foreign-born (including 4380 from Germany and 384 from England), and 17,419 were of foreign parentage (both parents foreign-born), and of these 13,910 were of German parentage. Evansville is served by the Evansville & Terre Haute, the Evansville & Indianapolis, the Illinois Central, the Louisville & Nashville, the Louisville, Henderson & St Louis, and the Southern railways, by several interurban electric lines, and by river steamboats. The city is situated on a plateau above the river, and has a number of fine business and public buildings, including the court house and city hall, the Southern Indiana hospital for the insane, the United States marine hospital, and the Willard library and art gallery, containing in 1908 about 30,000 volumes. The city's numerous railway connexions and its situation in a coal-producing region (there are five mines within the city limits) and on the Ohio river, which is navigable nearly all the year, combine to make it the principal commercial and manufacturing centre of Southern Indiana. It is in a tobacco-growing region, is one of the largest hardwood lumber markets in the country, and has an important shipping trade in pork, agricultural products, dried fruits, lime and limestone, flour and tobacco. Among its manufactures in 1905 were flour and grist mill products (value, \$2,638,914), furniture (\$1,655,246), lumber and timber products (\$1,229,533), railway cars (\$1,118,376), packed meats (\$998,428), woollen and cotton goods, cigars and cigarettes, malt liquors, carriages and wagons, leather and canned goods. The value of the factory products increased from \$12,167,524 in 1900 to \$19,201,716 in 1905, or 57.8%, and in the latter year Evansville ranked third among the manufacturing cities in the state. The waterworks are owned and operated by the city. First settled about 1812, Evansville was laid out in 1817, and was named in honour of Robert Morgan Evans (1783-1844), one of its founders, who was an officer under General W. H. Harrison in the war of 1812. It soon became a thriving commercial town with an extensive river trade, was incorporated in 1819, and received a city charter in 1847. The completion of the Wabash

& Erie Canal, in 1853, from Evansville to Toledo, Ohio, a distance of 400 m., greatly accelerated the city's growth.

EVARISTUS, fourth pope (c. 98-105), was the immediate successor of Clement.

EVARTS, WILLIAM MAXWELL (1818-1901), American lawyer, was born in Boston on the 6th of February 1818. He graduated at Yale in 1837, was admitted to the bar in New York in 1841, and soon took high rank in his profession. In 1860 he was chairman of the New York delegation to the Republican national convention. In 1861 he was an unsuccessful candidate for the United States senatorship from New York. He was chief counsel for President Johnson during the impeachment trial, and from July 1868 until March 1869 he was attorney-general of the United States. In 1872 he was counsel for the United States in the "Alabama" arbitration. During President Hayes's administration (1877-1881) he was secretary of state; and from 1885 to 1891 he was one of the senators from New York. As an orator Senator Evarts stood in the foremost rank, and some of his best speeches were published. He died in New York on the 28th of February 1901.

EVE, the English transcription, through Lat. *Eva* and Gr. *Ἔβα*, of the Hebrew name חַוָּה Ḥavvah, given by Adam to his wife because she was "mother of all living," or perhaps more strictly, "of every group of those connected by female kinship" (see W. R. Smith, *Kinship*, 2nd ed., p. 208), as if Eve were the personification of mother-kinship, just as Adam ("man") is the personification of mankind.

[The abstract meaning "life" (LXX. *Ζωή*), once favoured by Robertson Smith, is at any rate unsuitable in a popular story. Wellhausen and Nöldeke would compare the Ar. *ḥayyatun*, "serpent," and the former remarks that, if this is right, the Israelites received their first ancestress from the Ḥivvites (Hivites), who were originally the serpent-tribe (*Composition des Hexateuchs*, p. 343; cf. *Reste arabischen Heidentums*, 2nd ed., p. 154). Cheyne, too, assumes a common origin for Ḥavvah and the Ḥivvites.]

[The account of the origin of Eve (Gen. iii. 21-23) runs thus: "And Yahweh-Elohim caused a deep sleep to fall upon the man, and he slept. And he took one of his ribs, and closed up the flesh in its stead, and the rib which Yahweh-Elohim had taken from the man he built up into a woman, and he brought her to the man." Enchanted at the sight, the man now burst out into elevated, rhythmic speech: "This one," he said, "at length is bone of my bone and flesh of my flesh," &c.; to which the narrator adds the comment, "Therefore doth a man forsake his father and his mother, and cleave to his wife, and they become one flesh (body)." Whether this comment implies the existence of the custom of *beena*, marriage (W. R. Smith, *Kinship*, 2nd ed., p. 208), seems doubtful. It is at least equally possible that the expression "his wife" simply reflects the fact that among ordinary Israelites circumstances had quite naturally brought about the prevalence of monogamy.¹ What the narrator gives is not a doctrine of marriage, much less a precept, but an explanation of a simple and natural phenomenon. How is it, he asks, that a man is so irresistibly drawn towards a woman? And he answers: Because the first woman was built up out of a rib of the first man. At the same time it is plain that the already existing tendency towards monogamy must have been powerfully assisted by this presentation of Eve's story as well as by the prophetic descriptions of Yahweh's relation to Israel under the figure of a monogamous union.]

[The narrator is no rhetorician, and spares us a description of the ideal woman. But we know that, for Adam, his strangely produced wife was a "help (or helper) matching or corresponding to him"; or, as the Authorized Version puts it, "a help meet for him" (ii. 18b). This does not, of course, exclude subordination on the part of the woman; what is excluded is that exaggeration of natural subordination which the narrator may have found both in his

¹ That polygamy had not become morally objectionable is shown by the stories of Lamech, Abraham and Jacob.

own and in the neighbouring countries, and which he may have regarded as (together with the pains of parturition) the punishment of the woman's transgression (Gen. iii. 16). His own ideal of woman seems to have made its way in Palestine by slow degrees. An apocryphal book (Tobit viii. 6, 7) seems to contain the only reference to the section till we come to the time of Christ, to whom the comment in Gen. ii. 24 supplies the text for an authoritative prohibition of divorce, which presupposes and sanctifies monogamy (Matt. x. 7, 8; Matt. xix. 5). For other New Testament applications of the story of Eve see 1 Cor. xi. 8, 9 (especially); 2 Cor. xi. 3; 1 Tim. ii. 13, 14; and in general cf. ADAM, and *Ency. Biblica*, "Adam and Eve."]

[The seeming omissions in the Biblical narrative have been filled up by imaginative Jewish writers.] The earliest source which remains to us is the Book of Jubilees, or Leptogenesis, a Palestinian work (referred by R. H. Charles to the century immediately preceding the Christian era; see APOCALYPTIC LITERATURE). In this book, which was largely used by Christian writers, we find a chronology of the lives of Adam and Eve and the names of their daughters—Avan and Azura.² The Targum of Jonathan informs us that Eve was created from the thirteenth rib of Adam's right side, thus taking the view that Adam had a rib more than his descendants. Some of the Jewish legends show clear marks of foreign influence. Thus the notion that the first man was a double being, afterwards separated into the two persons of Adam and Eve (*Berachot*, 61; *Erubin*, 18), may be traced back to Philo (*De mundi opif.* §53; cf. *Quaest. in Gen.* lib. i. §25), who borrows the idea, and almost the words, of the myth related by Aristophanes in the *Platonic Symposium* (189 D, 190 A), which, in extravagant form, explains the passion of love by the legend that male and female originally formed one body.

[A recent critic³ (F. Schwally) even holds that this notion was originally expressed in the account of the creation of man in Gen. i. 27. This involves a textual emendation, and one must at least admit that the present text is not without difficulty, and that Berossus refers to the existence of primeval monstrous androgynous beings according to Babylonian mythology.] There is an analogous Iranian legend of the true man, which parted into man and woman in the Bundahish⁴ (the Parsi Genesis), and an Indian legend, which, according to Spiegel, has presumably an Iranian source.⁵

[It has been remarked elsewhere (ADAM, §16) that though the later Jews gathered material for thought very widely, such guidance as they required in theological reflection was mainly derived from Greek culture. What, for instance, was to be made of such a story as that in Gen. ii.-iv.? To "minds trained under the influence of the Jewish Haggada, in which the whole Biblical history is freely intermixed with legendary and parabolic matter," the question as to the literal truth of that story could hardly be formulated. It is otherwise when the Greek leaven begins to work.]

Josephus, in the prologue to his *Archaeology*, reserves the problem of the true meaning of the Mosaic narrative, but does not regard everything as strictly literal. Philo, the great representative of Alexandrian allegory, expressly argues that in the nature of things the trees of life and knowledge cannot be taken otherwise than symbolically. His interpretation of the creation of Eve is, as has been already observed, plainly suggested by a Platonic myth. The longing for reunion which love implants in the divided halves of the original dual man is the source of sensual pleasure (symbolized by the serpent), which in turn is the beginning of all transgression. Eve represents the sensuous or perceptive part of man's nature, Adam the reason. The serpent, therefore, does not venture to attack Adam directly.

² See West's authoritative translation in *Paltaivi Texts* (Sacred Books of the East).

³ "Die bibl. Schöpfungsberrichte" (*Archiv für Religionswissenschaft*, ix. 171 ff.).

⁴ Spiegel, *Eränische Alterthumskunde*, i. 511.

⁵ Muir, *Sanscrit Texts*, vol. i. p. 25; cf. Spiegel, vol. i. p. 458.

Imaginative or legendary developments.

Course of Jewish and Christian interpretation.

It is sense which yields to pleasure, and in turn enslaves the reason and destroys its immortal virtue. This exposition, in which the elements of the Bible narrative become mere symbols of the abstract notions of Greek philosophy, and are adapted to Greek conceptions of the origin of evil in the material and sensuous part of man, was adopted into Christian theology by Clement and Origen, notwithstanding its obvious inconsistency with the Pauline anthropology, and the difficulty which its supporters felt in reconciling it with the Christian doctrine of the excellence of the married state (Clemens Alex. *Stromata*, p. 174). These difficulties had more weight with the Western church, which, less devoted to speculative abstractions and more deeply influenced by the Pauline anthropology, refused, especially since Augustine, to reduce Paradise and the fall to the region of pure *intelligibilia*; though a spiritual sense was admitted along with the literal (Aug. *Civ. Dei*, xiii. 21).¹

The history of Adam and Eve became the basis of anthropological discussions which acquired more than speculative importance from their connexion with the doctrine of original sin and the meaning of the sacrament of baptism. One or two points in Augustinian teaching may be here mentioned as having to do particularly with Eve. The question whether the soul of Eve was derived from Adam or directly infused by the Creator is raised as an element in the great problem of traducianism and creationism (*De Gen. ad lit.* lib. x.). And it is from Augustine that Milton derives the idea that Adam sinned, not from desire for the forbidden fruit, but because love forbade him to dissociate his fate from Eve's (*ibid.* lib. xi. *sub fin.*). Medieval discussion moved mainly in the lines laid down by Augustine. A sufficient sample of the way in which the subject was treated by the schoolmen may be found in the *Summa* of Thomas, pars i. qu. xcii. *De productione mulieris*.

The Reformers, always hostile to allegory, and in this matter especially influenced by the Augustinian anthropology, adhered strictly to the literal interpretation of the history of the Protoplasts, which has continued to be generally identified with Protestant orthodoxy. The disintegration of the confessional doctrine of sin in last century was naturally associated with new theories of the meaning of the biblical narrative; but neither renewed forms of the allegorical interpretation, in which everything is reduced to abstract ideas about reason and sensuality, nor the attempts of Eichhorn and others to extract a kernel of simple history by allowing largely for the influence of poetical form in so early a narrative, have found lasting acceptance. On the other hand, the strict historical interpretation is beset with difficulties which modern interpreters have felt with increasing force, and which there is a growing disposition to solve by adopting in one or other form what is called the *mythical* theory of the narrative. But interpretations pass under this now popular title which have no real claim to be so designated. What is common to the "mythical" interpretations is to find the real value of the narrative, not in the form of the story, but in the thoughts which it embodies. But the story cannot be called a myth in the strict sense of the word, unless we are prepared to place it on one line with the myths of heathenism, produced by the unconscious play of plastic fancy, giving shape to the impressions of natural phenomena on primitive observers. Such a theory does no justice to a narrative which embodies profound truths peculiar to the religion of revelation. Other forms of the so-called mythical interpretation are little more than abstract allegory in a new guise, ignoring the fact that the biblical story does not teach general truths which repeat themselves in every individual, but gives a view of the purpose of man's creation, and of the origin of sin, in connexion with the divine plan of redemption. Among his other services in refutation of the unhistorical rationalism of last century, Kant has the merit of having forcibly recalled attention to the fact that the narrative of Genesis, even if we do not take it literally, must be regarded as

¹ Thus in medieval theology Eve is a type of the church, and her formation from the rib has a mystic reason, inasmuch as blood and water (the sacraments of the church) flowed from the side of Christ on the cross (Thomas, *Summa*, par. i. qu. xcii.).

presenting a view of the beginnings of the history of the human race (*Muthmasslicher Anfang der Menschengeschichte*, 1786). Those who recognize this fact ought not to call themselves or be called by others adherents of the mythical theory, although they also recognize that in the nature of things the divine truths brought out in the history of the creation and fall could not have been expressed either in the form of literal history or in the shape of abstract metaphysical doctrine; or even although they may hold—as is done by many who accept the narrative as a part of supernatural revelation—that the specific biblical truths which the narrative conveys are presented through the vehicle of a story which, at least in some of its parts, may possibly be shaped by the influence of legends common to the Hebrews with their heathen neighbours. (W. R. S.; [T. K. C.])

EVECTION (Latin for "carrying away"), in astronomy, the largest inequality produced by the action of the sun in the monthly revolution of the moon around the earth. The deviation expressed by it has a maximum amount of about 1° 15' in either direction. It may be considered as arising from a semi-annual variation in the eccentricity of the moon's orbit and the position of its perigee. It was discovered by Ptolemy.

EVELETH, a city of St Louis county, Minnesota, U.S.A., about 71 m. N.N.W. of Duluth. Pop. (1900) 2752; (1905, state census) 5332, of whom 2975 were foreign-born (1145 Finns, 676 Austrians and 325 Swedes); (1910) 7036. Eveleth is served by the Duluth, Missabe & Northern and the Duluth & Iron Range railways. It lies in the midst of the great red and brown hematite iron-ore deposits of the Mesabi Range—the richest in the Lake Superior district—and the mining and shipping of this ore are its principal industries. The municipality owns and operates the water-works, the water being obtained from Lake Saint Mary, one of a chain of small lakes lying S. of the city. Eveleth was first chartered as a city in 1902.

EVELYN, JOHN (1620–1706), English diarist, was born at Wotton House, near Dorking, Surrey, on the 31st of October 1620. He was the younger son of Richard Evelyn, who owned large estates in the county, and was in 1633 high sheriff of Surrey and Sussex. When John Evelyn was five years old he went to live with his mother's parents at Cliffe, near Lewes. He refused to leave his "too indulgent" grandmother for Eton, and when on her husband's death she married again, the boy went with her to Southover, where he attended the free school of the place. He was admitted to the Middle Temple in February 1637, and in May he became a fellow commoner of Balliol College, Oxford. He left the university without taking a degree, and in 1640 was residing in the Middle Temple. In that year his father died, and in July 1641 he crossed to Holland. He was enrolled as a volunteer in Apsley's company, then encamped before Genep on the Waal, but his commission was apparently complimentary, his military experience being limited to six days of camp life, during which, however, he took his turn at "trailing a pike." He returned in the autumn to find England on the verge of civil war. Evelyn's part in the conflict is best told in his own words:—

"12th November was the battle of Brentford, surprisingly fought. . . . I came in with my horse and arms just at the retreat; but was not permitted to stay longer than the 15th by reason of the army marching to Gloucester; which would have left both me and my brothers exposed to ruin, without any advantage to his Majesty . . . and on the 10th [December] returned to Wotton, nobody knowing of my having been in his Majesty's army."

At Wotton he employed himself in improving his brother's property, making a fishpond, an island and other alterations in the gardens. But he found it difficult to avoid taking a side; he was importuned to sign the Covenant, and "finding it impossible to evade doing very unhandsome things," he obtained leave in October 1643 from the king to travel abroad. From this date his *Diary* becomes full and interesting. He travelled in France and visited the cities of Italy, returning in the autumn of 1646 to Paris, where he became intimate with Sir Richard Browne, the English resident at the court of France. In June of the following year he married Browne's daughter and heiress, Mary, then a child of not more than twelve years of age. Leaving

his wife in the care of her parents, he returned to England to settle his affairs. He visited Charles I. at Hampton Court in 1647, and during the next two years maintained a cipher correspondence with his father-in-law in the royal interest. In 1649 he obtained a pass to return to Paris, but in 1650 paid a short visit to England. The defeat of Charles II. at Worcester in 1651 convinced him that the royalist cause was hopeless, and he decided to return to England. He went in 1652 to Sayes Court at Deptford, a house which Sir Richard Browne had held on a lease from the crown. This had been seized by the parliament, but Evelyn was able to compound with the occupiers for £3500, and after the Restoration his possession was secured. Here his wife joined him, their eldest son, Richard, being born in August 1652. Under the Commonwealth Evelyn amused himself with his favourite occupation of gardening, and made many friends among the scientific inquirers of the time. He was one of the promoters of the scheme for the Royal Society, and in the king's charter in 1662 was nominated a member of its directing council. Meanwhile he had refused employment from the government of the Commonwealth, and had maintained a cipher correspondence with Charles. In 1659 he published an *Apology for the Royal Party*, and in December of that year he vainly tried to persuade Colonel Herbert Morley, then lieutenant of the Tower, to forestall General Monk by declaring for the king. From the Restoration onwards Evelyn enjoyed unbroken court favour till his death in 1706; but he never held any important political office, although he filled many useful and often laborious minor posts. He was commissioner for improving the streets and buildings of London, for examining into the affairs of charitable foundations, commissioner of the Mint, and of foreign plantations. In 1664 he accepted the responsibility for the care of the sick and wounded and the prisoners in the Dutch war. He stuck to his post throughout the plague year, contenting himself with sending his family away to Wotton. He found it impossible to secure sufficient money for the proper discharge of his functions, and in 1688 he was still petitioning for payment of his accounts in this business. Evelyn was secretary of the Royal Society in 1672, and as an enthusiastic promoter of its interests was twice (in 1682 and 1691) offered the presidency. Through his influence Henry Howard, duke of Norfolk, was induced to present the Arundel marbles to the university of Oxford (1667) and the valuable Arundel library to Gresham College (1678). In the reign of James II., during the earl of Clarendon's absence in Ireland, he acted as one of the commissioners of the privy seal. He was seriously alarmed by the king's attacks on the English Church, and refused on two occasions to license the illegal sale of Roman Catholic literature. He concurred in the revolution of 1688, in 1695 was entrusted with the office of treasurer of Greenwich hospital for old sailors, and laid the first stone of the new building on the 30th of June 1696. In 1694 he left Sayes Court to live at Wotton with his brother, whose heir he had become, and whom he actually succeeded in 1699. He spent the rest of his life there, dying on the 27th of February 1706. Evelyn's house at Sayes Court had been let to Captain, afterwards Admiral John Benbow, who was not a "polite" tenant. He sublet it to Peter the Great, who was then visiting the dockyard at Deptford. The tsar did great damage to Evelyn's beautiful gardens, and, it is said, made it one of his amusements to ride in a wheelbarrow along a thick holly hedge planted especially by the owner. The house was subsequently used as a workhouse, and is now almshouses, the grounds having been converted into public gardens by Mr Evelyn in 1886.

It will be seen that Evelyn's politics were not of the heroic order. But he was honourable and consistent in his adherence to the monarchical principle throughout his life. With the court of Charles II. he could have had no sympathy, his dignified domestic life and his serious attention to religion standing in the strongest contrast with the profligacy of the royal surroundings. His *Diary* is therefore a valuable chronicle of contemporary events from the standpoint of a moderate politician and a devout adherent of the Church of England. He had none of Pepys's love of gossip, and was devoid of his all-embracing curiosity,

as of his diverting frankness of self-revelation. Both were admirable civil servants, and they had a mutual admiration for each other's sterling qualities. Evelyn's *Diary* covers more than half a century (1640-1706) crowded with remarkable events, while Pepys only deals with a few years of Charles II.'s reign.

Evelyn was a generous art patron, and Grinling Gibbons was introduced by him to the notice of Charles II. His domestic affections were very strong. He had six sons, of whom John (1655-1699), the author of some translations, alone reached manhood. He has left a pathetic account of the extraordinary accomplishments of his son Richard, who died before he was six years old, and of a daughter Mary, who lived to be twenty, and probably wrote most of her father's *Mundus muliebris* (1690). Of his two other daughters, Susannah, who married William Draper of Addiscombe, Surrey, survived him.

Evelyn's *Diary* remained in MS. until 1818. It is in a quarto volume containing 700 pages, covering the years between 1641 and 1697, and is continued in a smaller book which brings the narrative down to within three weeks of its author's death. A selection from this was edited by William Bray, with the permission of the Evelyn family, in 1818, under the title of *Memoirs illustrative of the Life and Writings of John Evelyn, comprising his Diary from 1641 to 1705/6, and a Selection of his Familiar Letters*. Other editions followed, the most notable being those of Mr H. B. Wheatley (1879) and Mr Austin Dobson (3 vols., 1906). Evelyn's active mind produced many other works, and although these have been overshadowed by the famous *Diary* they are of considerable interest. They include: *Of Liberty and Servitude* . . . (1649), a translation from the French of Francois de la Mothe le Vayer, Evelyn's own copy of which contains a note that he was "like to be call'd in question by the Rebels for this booke"; *The State of France, as it stood in the IXth year of . . . Louis XIII.* (1652); *An Essay on the First Book of T. Lucretius Carus de Rerum Natura. Interpreted and made English verse by J. Evelyn* (1656); *The Golden Book of St John Chrysostom, concerning the Education of Children. Translated out of the Greek by J. E.* (printed 1658, dated 1659); *The French Gardener: instructing how to cultivate all sorts of Fruit-trees* . . . (1658), translated from the French of N. de Bonnefons; *A Character of England* . . . (1659), describing the customs of the country as they would appear to a foreign observer, reprinted in *Somers' Tracts* (ed. Scott, 1812), and in the *Harleian Miscellany* (ed. Park, 1813); *The Late News from Brussels unmasked* . . . (1660), in answer to a libellous pamphlet on Charles I. by Marchmont Needham; *Fumifugium, or the inconvenience of the Aer and Smoak of London dissipated* (1661), in which he suggested that sweet-smelling trees should be planted in London to purify the air; *Instructions concerning erecting of a Library* . . . (1661), from the French of Gabriel Naudé; *Tyrannus or the Mode, in a Discourse of Sumptuary Laws* (1661); *Sculptura: or the History and Art of Chalcography and Engraving in Copper* . . . (1662); *Sylva, or a Discourse of Forest Trees* . . . to which is annexed *Pomona* . . . Also *Kalendarium Hortense* . . . (1664); *A Parallel of the Ancient Architecture with the Modern* . . . (1664), from the French of Roland Fréart; *The History of the three late famous Imposters, viz. Padre Ottomano, Mahomed Bei, and Sabatei Sevi* . . . (1669); *Navigation and Commerce* . . . in which his *Majesties title to the Dominion of the Sea is asserted against the Novel and later Pretenders* (1674), which is a preface to a projected history of the Dutch wars undertaken at the request of Charles II., but countermanded on the conclusion of peace; *A Philosophical Discourse of Earth* . . . (1676), a treatise on horticulture, better known by its later title of *Terra; The Compleat Gardener* . . . (1693), from the French of J. de la Quintinie; *Numismata* . . . (1697). Some of these were reprinted in *The Miscellaneous Writings of John Evelyn*, edited (1825) by William Upcott. Evelyn's friendship with Mary Blagge, afterwards Mrs Godolphin, is recorded in the diary, when he says he designed "to consecrate her worthy life to posterity." This he effectually did in a little masterpiece of religious biography which remained in MS. in the possession of the Harcourt family until it was edited by Samuel Wilberforce, bishop of Oxford, as the *Life of Mrs Godolphin* (1847), reprinted in the "King's Classics" (1904). The picture of Mistress Blagge's saintly life at court is heightened in interest when read in connexion with the scandalous memoirs of the comte de Gramont, or contemporary political satires on the court. Numerous other papers and letters of Evelyn on scientific subjects and matters of public interest are preserved, a collection of private and official letters and papers (1642-1712) by, or addressed to, Sir Richard Browne and his son-in-law being in the British Museum (Add. MSS. 15857 and 15858).

Next to the *Diary* Evelyn's most valuable work is *Sylva*. By the glass factories and iron furnaces the country was being rapidly depleted of wood, while no attempt was being made to replace the damage by planting. Evelyn put in a plea for afforestation, and besides producing a valuable work on arboriculture, he was able to assert in his preface to the king that he had really induced landowners to plant many millions of trees.

EVERDINGEN, ALLART VAN (1621-?1675), Dutch painter and engraver, the son of a government clerk at Alkmaar, was born, it is said, in 1621, and educated, if we believe an old tradition, under Roeland Savery at Utrecht. He wandered in 1645 to Haarlem, where he studied under Peter de Molyn, and finally settled about 1657 at Amsterdam, where he remained till his death. It would be difficult to find a greater contrast than that which is presented by the works of Savery and Everdingen. Savery inherited the gaudy style of the Breughels, which he carried into the 17th century; whilst Everdingen realized the large and effective system of coloured and powerfully shaded landscape which marks the precursors of Rembrandt. It is not easy on this account to believe that Savery was Everdingen's master, while it is quite within the range of probability that he acquired the elements of landscape painting from de Molyn. Pieter de Molyn, by birth a Londoner, lived from 1624 till 1661 in Haarlem. He went periodically on visits to Norway, and his works, though scarce, exhibit a broad and sweeping mode of execution, differing but slightly from that transferred at the opening of the 17th century from Jan van Goyen to Solomon Ruysdael. His etchings have nearly the breadth and effect of those of Everdingen. It is still an open question when de Molyn wielded influence on his clever disciple. Alkmaar, a busy trading place near the Texel, had little of the picturesque for an artist except polders and downs or waves and sky. Accordingly we find Allart at first a painter of coast scenery. But on one of his expeditions he is said to have been cast ashore in Norway, and during the repairs of his ship he visited the inland valleys, and thus gave a new course to his art. In early pieces he cleverly represents the sea in motion under varied, but mostly clouded, aspects of sky. Their general intonation is strong and brown, and effects are rendered in a powerful key, but the execution is much more uniform than that of Jacob Ruysdael. A dark scud lowering on a rolling sea near the walls of Flushing characterizes Everdingen's "Mouth of the Schelde" in the Hermitage at St Petersburg. Storm is the marked feature of sea-pieces in the Staedel or Robartes collections; and a strand with wreckers at the foot of a cliff in the Munich Pinakothek may be a reminiscence of personal adventure in Norway. But the Norwegian coast was studied in calms as well as in gales; and a fine canvas at Munich shows fishermen on a still and sunny day taking herrings to a smoking hut at the foot of a Norwegian crag. The earliest of Everdingen's sea-pieces bears the date of 1640. After 1645 we meet with nothing but representations of inland scenery, and particularly of Norwegian valleys, remarkable alike for wildness and a decisive depth of tone. The master's favourite theme is a fall in a glen, with mournful fringes of pines interspersed with birch, and log-huts at the base of rocks and craggy slopes. The water tumbles over the foreground, so as to entitle the painter to the name of "inventor of cascades." It gives Everdingen his character as a precursor of Jacob Ruysdael in a certain form of landscape composition; but though very skilful in arrangement and clever in effects, Everdingen remains much more simple in execution; he is much less subtle in feeling or varied in touch than his great and incomparable countryman. Five of Everdingen's cascades are in the museum of Copenhagen alone: of these, one is dated 1647, another 1649. In the Hermitage at St Petersburg is a fine example of 1647; another in the Pinakothek at Munich was finished in 1656. English public galleries ignore Everdingen; but one of his best-known master-pieces is the Norwegian glen belonging to Lord Listowel. Of his etchings and drawings there are much larger and more numerous specimens in England than elsewhere. Being a collector as well as an engraver and painter, he brought together a large number of works of all kinds and masters; and the sale of these by his heirs at Amsterdam on the 11th of March 1676 gives an approximate clue to the date of the painter's death.

His two brothers, Jan and Caesar, were both painters. **CAESAR VAN EVERDINGEN** (1606-1679), mainly known as a portrait painter, enjoyed some vogue during his life, and many of his pictures are to be seen in the museums and private houses of

Holland. They show a certain cleverness, but are far from entitling him to rank as a master.

EVEREST, SIR GEORGE (1790-1866), British surveyor and geographer, was the son of Tristram Everest of Gwerndale, Brecknockshire, and was born there on the 4th of July 1790. From school at Marlow he proceeded to the military academy at Woolwich, where he attracted the special notice of the mathematical master, and passed so well in his examinations that he was declared fit for a commission before attaining the necessary age. Having gone to India in 1806 as a cadet in the Bengal Artillery, he was selected by Sir Stamford Raffles to take part in the reconnaissance of Java (1814-1816); and after being employed in various engineering works throughout India, he was appointed in 1818 assistant to Colonel Lambton, the founder of the great trigonometrical survey of that country. In 1823, on Colonel Lambton's death, he succeeded to the post of superintendent of the survey; in 1830 he was appointed by the court of directors of the East India Company surveyor-general of India; and from that date till his retirement from the service in 1843 he continued to discharge the laborious duties of both offices. During the rest of his life he resided in England, where he became fellow of the Royal Society and an active member of several other scientific associations. In 1861 he was made a C.B. and received the honour of knighthood, and in 1862 he was chosen vice-president of the Royal Geographical Society. He died at Greenwich on the 1st of December 1866. The geodetical labours of Sir George Everest rank among the finest achievements of their kind; and more especially his measurement of the meridional arc of India, $11\frac{1}{2}^{\circ}$ in length, is accounted as unrivalled in the annals of the science. In great part the Indian survey is what he made it.

His works are purely professional.—A paper in vol. i. of the *Memoirs of the Royal Astronomical Society*, pointing out a mistake in La Caille's measurement of an arc of the meridian which he had discovered during sick-leave at the Cape of Good Hope; *An account of the measurement of the arc of the meridian between the parallels of $18^{\circ} 3'$ and $24^{\circ} 7'$, being a continuation of the Grand Meridional Arc of India, as detailed by Lieut.-Col. Lambton in the volumes of the Asiatic Society of Calcutta* (London, 1830); *An account of the measurement of two sections of the Meridional Arc of India, bounded by the parallels of $18^{\circ} 3' 15''$, $24^{\circ} 7' 11''$, and $20^{\circ} 30' 48''$* (London, 1847).

EVEREST, MOUNT, the highest mountain in the world. It is a peak of the Himalayas situated in Nepal almost precisely on the intersection of the meridian 87° E. long. with the parallel 28° N. lat. Its elevation as at present determined by trigonometrical observation is 29,002 ft., but it is possible that further investigation into the value of refraction at such altitudes will result in placing the summit even higher. It has been confused with a peak to the west of it called Gaurisankar (by Schlagintweit), which is more than 5000 ft. lower; but the observations of Captain Wood from peaks near Khatmandu, in Nepal, and those of the same officer, and of Major Ryder, from the route between Lhasa and the sources of the Brahmaputra in 1904, have definitely fixed the relative position of the two mountain masses, and conclusively proved that there is no higher peak than Everest in the Himalayan system. The peak possesses no distinctive native name and has been called Everest after Sir George Everest (*q.v.*), who completed the trigonometrical survey of the Himalayas in 1841 and first fixed its position and altitude. (T. H. H.*)

EVERETT, ALEXANDER HILL (1790-1847), American author and diplomatist, was born in Boston, Massachusetts, on the 19th of March 1790. He was the son of Rev. Oliver Everett (1753-1802), a Congregational minister in Boston, and the brother of Edward Everett. He graduated at Harvard in 1806, taking the highest honours of his year, though the youngest member of his class. He spent one year as a teacher in Phillips Academy, Exeter, New Hampshire, and then began the study of law in the office of John Quincy Adams. In 1809 Adams was appointed minister to Russia, and Everett accompanied him as his private secretary, remaining attached to the American legation in Russia until 1811. He was secretary of the American legation at The Hague in 1815-1816, and *chargé d'affaires* there

from 1818 to 1824. From 1825 to 1829, during the presidency of John Quincy Adams, he was the United States minister to Spain. At that time Spain recognized none of the governments established by her revolted colonies, and Everett became the medium of all communications between the Spanish government and the several nations of Spanish origin which had been established, by successful revolutions, on the other side of the ocean. Everett was a member of the Massachusetts legislature in 1830–1835, was president of Jefferson College in Louisiana in 1842–1844, and was appointed commissioner of the United States to China in 1845, but did not go to that country until the following year, and died on the 29th of May 1847 at Canton, China. Everett, however, is known rather as a man of letters than as a diplomat. In addition to numerous articles, published chiefly in the *North American Review*, of which he was the editor from 1829 to 1835, he wrote: *Europe, or a General Survey of the Political Situation of the Principal Powers, with Conjectures on their Future Prospects* (1822), which attracted considerable attention in Europe and was translated into German, French and Spanish; *New Ideas on Population* (1822); *America, or a General Survey of the Political Situation of the Several Powers of the Western Continent, with Conjectures on their Future Prospects* (1827), which was translated into several European languages; a volume of *Poems* (1845); and *Critical and Miscellaneous Essays* (first series, 1845; second series, 1847).

EVERETT, CHARLES CARROLL (1829–1900), American divine and philosopher, was born on the 19th of June 1829, at Brunswick, Maine. He studied at Bowdoin College, where he graduated in 1850, after which he proceeded to Berlin. Subsequently he took a degree in divinity at the Harvard Divinity School. From 1859 to 1869 he was pastor of the Independent Congregational (Unitarian) church at Bangor, Maine. This charge he resigned to take the Bussey professorship of theology at Harvard University, and, in 1878, became dean of the faculty of theology. Interested in a variety of subjects, he devoted himself chiefly to the philosophy of religion, and published *The Science of Thought* (Boston, 1869; revised 1891). He also wrote *Fichte's Science of Knowledge* (1884); *Poetry, Comedy and Duty* (1888); *Religions before Christianity* (1883); *Ethics for Young People* (1891); *The Gospel of Paul* (1892). He died at Cambridge on the 16th of October 1900.

EVERETT, EDWARD (1794–1865), American statesman and orator, was born in Dorchester, Massachusetts, on the 11th of April 1794. He was the son of Rev. Oliver Everett and the brother of Alexander Hill Everett (*q.v.*). His father died in 1802, and his mother removed to Boston with her family after her husband's death. At seventeen Edward Everett graduated from Harvard College, taking first honours in his class. While at college he was the chief editor of *The Lyceum*, the earliest in the series of college journals published at the American Cambridge. His earlier predilections were for the study of law, but the advice of Joseph Stevens Buckminster, a distinguished preacher in Boston, led him to prepare for the pulpit, and as a preacher he at once distinguished himself. He was called to the ministry of the Brattle Street church (Unitarian) in Boston before he was twenty years old. His sermons attracted wide attention in that community, and he gained a considerable reputation as a theologian and a controversialist by his publication in 1814 of a volume entitled *Defence of Christianity*, written in answer to a work, *The Grounds of Christianity Examined* (1813), by George Bethune English (1787–1828), an adventurer, who, born in Cambridge, Massachusetts, was in turn a student of law and of theology, an editor of a newspaper, and a soldier of fortune in Egypt. Everett's tastes, however, were then, as always, those of a scholar; and in 1815, after a service of little more than a year in the pulpit, he resigned his charge to accept a professorship of Greek literature in Harvard College.

After nearly five years spent in Europe in preparation, he entered with enthusiasm on his duties, and, for five years more, gave a vigorous impulse, not only to the study of Greek, but to all the work of the college. In January 1820 he assumed the charge of the *North American Review*, which now became a

quarterly; and he was indefatigable during the four years of his editorship in contributing on a great variety of subjects. From 1825 to 1835 he was a member of the National House of Representatives, supporting generally the administration of President J. Q. Adams and opposing that of Jackson, which succeeded it. He bore a part in almost every important debate, and was a member of the committee of foreign affairs during the whole time of his service in Congress. Everett was a member of nearly all the most important select committees, such as those on the Indian relations of the state of Georgia, the Apportionment Bill, and the Bank of the United States, and drew the report either of the majority or the minority. The report on the congress of Panama, the leading measure of the first session of the Nineteenth Congress, was drawn up by Everett, although he was the youngest member of the committee and had just entered Congress. He led the unsuccessful opposition to the Indian policy of General Jackson (the removal of the Cherokee and other Indians, without their consent, from lands guaranteed to them by treaty).

In 1835 he was elected governor of Massachusetts. He brought to the duties of the office the untiring diligence which was the characteristic of his public life. We can only allude to a few of the measures which received his efficient support, *e.g.* the establishment of the board of education (the first of such boards in the United States), the scientific surveys of the state (the first of such public surveys), the criminal law commission, and the preservation of a sound currency during the panic of 1837.

Everett filled the office of governor for four years, and was then defeated by a single vote, out of more than one hundred thousand. The election is of interest historically as being the first important American election where the issue turned on the question of the prohibition of the retail sale of intoxicating liquors. In the following spring he made a visit with his family to Europe. In 1841, while residing in Florence, he was named United States minister to Great Britain, and arrived in London to enter upon the duties of his mission at the close of that year. Great questions were at that time open between the two countries—the north-eastern boundary, the affair of M'Leod, the seizure of American vessels on the coast of Africa, in the course of a few months the affair of the "Creole," to which was soon added the Oregon question. His position was more difficult by reason of the frequent changes that took place in the department at home, which, in the course of four years, was occupied successively by Messrs Webster, Legaré, Upshur, Calhoun and Buchanan. From all these gentlemen Everett received marks of approbation and confidence.

By the institution of the special mission of Lord Ashburton, however, the direct negotiations between the two governments were, about the time of Everett's arrival in London, transferred to Washington, though much business was transacted at the American legation in London.

Immediately after the accession of Polk to the presidency Everett was recalled. From January 1846 to 1849, as the successor of Josiah Quincy, he was president of Harvard College. On the death, in October 1852, of his friend Daniel Webster, to whom he had always been closely attached, and of whom he was always a confidential adviser, he succeeded him as secretary of state, which post he held for the remaining months of Fillmore's administration, leaving it to go into the Senate in 1853, as one of the representatives of Massachusetts. Under the work of the long session of 1853–1854 his health gave way. In May 1854 he resigned his seat, on the orders of his physician, and retired to what was called private life.

But, as it proved, the remaining ten years of his life most widely established his reputation and influence throughout America. As early as 1820 he had established a reputation as an orator, such as few men in later days have enjoyed. He was frequently invited to deliver an "oration" on some topic of historical or other interest. With him these "orations," instead of being the ephemeral entertainments of an hour, became careful studies of some important theme. Eager to avert, if possible, the impending conflict of arms between the North and South, Everett

prepared an "oration" on George Washington, which he delivered in every part of America. In this way, too, he raised more than one hundred thousand dollars, for the purchase of the old home of Washington at Mount Vernon. Everett also prepared for the *Encyclopaedia Britannica* a biographical sketch of Washington, which was published separately in 1860. In 1860 Everett was the candidate of the short-lived Constitutional-Union party for the vice-presidency, on the ticket with John Bell (*q.v.*), but received only 39 electoral votes. During the Civil War he zealously supported the national government and was called upon in every quarter to speak at public meetings. He delivered the last of his great orations at Gettysburg, after the battle, on the consecration of the national cemetery there. On the 9th of January 1865 he spoke at a public meeting in Boston to raise funds for the southern poor in Savannah. At that meeting he caught cold, and the immediate result was his death on the 15th of January 1865.

In Everett's life and career was a combination of the results of diligent training, unflinching industry, delicate literary tastes and unequalled acquaintance with modern international politics. This combination made him in America an entirely exceptional person. He was never loved by the political managers; he was always enthusiastically received by assemblies of the people. He would have said himself that the most eager wish of his life had been for the higher education of his countrymen. His orations have been collected in four volumes (1850-1859). A work on international law, on which he was engaged at his death, was never finished. Allibone records 84 titles of his books and published addresses. (E. E. H.)

EVERETT, a city of Middlesex county, Massachusetts, U.S.A., adjoining Chelsea and 3 m. N. of Boston, of which it is a residential suburb. Pop. (1880) 4159; (1890) 11,068; (1900) 24,336, of whom 6882 were foreign-born; (1910 census) 33,484. It covers an area of about 3 sq. m. and is served by the Boston & Maine railway and by interurban electric lines. Everett has the Frederick E. Parlin memorial library (1878), the Shute memorial library (1898), the Whidden memorial hospital and Woodlawn cemetery (176 acres). The principal manufactures are coke, chemicals and boots and shoes; among others are iron and structural steel. According to the U.S. Census of Manufactures (1905), "the coke industry in Everett is unique, inasmuch as illuminating gas is the primary product and coke really a by-product, while the coal used is brought from mines located in Nova Scotia." The value of the city's total factory product increased from \$4,437,180 in 1900 to \$6,135,650 in 1905 or 38.3%. Everett was first settled about 1630, remaining a part of Malden (and being known as South Malden) until 1870, when it was incorporated as a township. It was chartered as a city in 1892.

EVERETT, a city, a sub-port of entry, and the county-seat of Snohomish county, Washington, U.S.A., on Puget Sound, at the mouth of the Snohomish river, about 35 m. N. of Seattle. Pop. (1900) 7838; (1910 U. S. census) 24,814. The city is served by the Northern Pacific and the Great Northern railways, being the western terminus of the latter's main transcontinental line, by interurban electric railway, and by several lines of Sound and coasting freight and passenger steamboats. Everett has a fine harbour with several large iron piers. Among its principal buildings are a Carnegie library, a Y.M.C.A. building and two hospitals. The buildings of the Pacific College were erected here by the United Norwegian Lutheran Church in 1908. The city is in a rich lumbering, gardening, farming, and copper-, gold- and silver-mining district. There is a U.S. assayer's office here, and there are extensive shipyards, a large paper mill, iron works, and, just outside the city limits, the smelters of the American Smelters Securities Company, in connexion with which is one of the two plants in the United States for saving arsenic from smelter fumes. Lumber interests, however, are of most importance, and here are some of the largest lumber plants in the Pacific Northwest. Red-cedar shingles are an important product. Everett was settled in 1891 and was incorporated in 1893. Its rapid growth is due to its favourable situation as a

commercial port, its transportation facilities, and its nearness to extensive forests whence the material for its chief industries is obtained.

EVERGLADES, an American lake, about 8000 sq. m. in area, in which are numerous half-submerged islands; situated in the southern part of Florida, U.S.A., in Lee, De Soto, Dade and St Lucie counties. West of it is the Big Cypress Swamp. The floor of the lake is a limestone basin, extending from Lake Okechobee in the N. to the extreme S. part of the state, and the lake varies in depth from 1 to 12 ft., its water being pure and clear. The surface is above tide level, and the lake is enclosed, probably on all sides, within an outcropping limestone rim, averaging about 10 ft. above mean low tide, and approaching much nearer to the Atlantic on the E. than to the gulf on the W. There are several small outlets, such as the Miami river and the New river on the E. and the Shark river on the S.W., but no streams empty into the Everglades, and the water-supply is furnished by springs and precipitation. There is a general south-easterly movement of the water. The soil of the islands is very fertile and is subject to frequent inundations, but gradually the water area is being replaced by land. The vegetation is luxuriant, the live oak, wild lemon, wild orange, cucumber, papaw, custard apple and wild rubber trees being among the indigenous species; there are, besides, many varieties of wild flowers, the orchids being especially noteworthy. The fauna is also varied; the otter, alligator and crocodile are found, also the deer and panther, and among the native birds are the ibis, egret, heron and limpkin. There are two seasons, wet and dry, but the climate is equable.

Systematic exploration has been prevented by the dense growth of saw grass (*Cladium effusum*), a kind of sedge, with sharp, saw-toothed leaves, which grows everywhere on the muck-covered rock basin and extends several feet above the shallow water. The first white man to enter the region was Escalante de Fontenada, a Spanish captive of an Indian chief, who named the lake Laguno del Espiritu Santo and the islands Cayos del Espiritu Santo. Between 1841 and 1856 various United States military forces penetrated the Everglades for the purpose of attacking and driving out the Seminoles, who took refuge here. The most important explorations during the later years of the 19th century were those of Major Archie P. Williams in 1883, James E. Ingraham in 1892 and Hugh L. Willoughby in 1897. The Seminole Indians were in 1909 practically the only inhabitants. In 1850 under the "Arkansas Bill," or Swamp and Overflow Act, practically all of the Everglades, which the state had been urging the federal government to drain and reclaim, were turned over to the state for that purpose, with the provision that all proceeds from such lands be applied to their reclamation. A board of trustees for the Internal Improvement Fund, created in 1855 and having as members *ex officio* the governor, comptroller, treasurer, attorney-general and commissioner-general, sold and allowed to railway companies much of the grant. Between 1881 and 1896 a private company owning 4,000,000 acres of the Everglades attempted to dig a canal from Lake Okechobee through Lake Hicpochee and along the Caloosahatchee river to the Gulf of Mexico; the canal was closed in 1902 by overflows. Six canals were begun under state control in 1905 from the lake to the Atlantic, the northernmost at Jensen, the southernmost at Ft. Lauderdale; the total cost, estimated at \$1,035,000 for the reclamation of 12,500 sq. m., is raised by a drainage tax (not to exceed 10 cents per acre) levied by the trustees of the Internal Improvement Fund and Board of Drainage commissioners. The small area reclaimed prior to that year (1905) was found very fertile and particularly adapted to raising sugar-cane, oranges and garden truck.

See Hugh L. Willoughby's *Across the Everglades* (Philadelphia, 1898), and especially an article "The Everglades of Florida" by Edwin A. Dix and John M. MacGonigle, in the *Century Magazine* for February 1905.

EVERGREEN, a general term applied to plants which are always in leaf, as contrasted with deciduous trees which are bare for some part of the year (see HORTICULTURE). In

temperate or colder zones where a season favourable to vegetation is succeeded by an unfavourable or winter season, leaves of evergreens must be protected from the frost and cold drying winds, and are therefore tougher or more leathery in texture than those of deciduous trees, and frequently, as in pines, firs and other conifers, are needle-like, thus exposing a much smaller surface to the drying action of cold winds. The number of seasons for which the leaves last varies in different plants; every season some of the older leaves fall, while new ones are regularly produced. The common English bramble is practically evergreen, the leaves lasting through winter and until the new leaves are developed next spring. In privet also the leaves fall after the production of new ones in the next year. In other cases the leaves last several years, as in conifers, and may sometimes be found on eleven-year-old shoots.

EVERLASTING, or **IMMORTELLE**, a plant belonging to the division *Tubuliflorae* of the natural order Compositae, known botanically as *Helichrysum orientale*. It is a native of North Africa, Crete, and the parts of Asia bordering on the Mediterranean; and it is cultivated in many parts of Europe. It first became known in Europe about the year 1629, and has been cultivated since 1815. In common with several other plants of the same group, known as "everlastings," the immortelle plant possesses a large involucre of dry scale-like or scarios bracts, which preserve their appearance when dried, provided the plant be gathered in proper condition. The chief supplies of *Helichrysum orientale* come from lower Provence, where it is cultivated in large quantities on the ground sloping to the Mediterranean, in positions well exposed to the sun, and usually in plots surrounded by dry stone walls. The finest flowers are grown on the slopes of Bandols and Ciotat, where the plant begins to flower in June. It requires a light sandy or stony soil, and is very readily injured by rain or heavy dews. It can be propagated in quantity by means of offsets from the older stems. The flowering stems are gathered in June, when the bracts are fully developed, all the fully-expanded and immature flowers being pulled off and rejected. A well-managed plantation is productive for eight or ten years. The plant is tufted in its growth, each plant producing 60 or 70 stems, while each stem produces an average of 20 flowers. About 400 such stems weigh a kilogramme. A hectare of ground will produce 40,000 plants, bearing from 2,400,000 to 2,800,000 stems, and weighing from 5½ to 6½ tons, or from 2 to 3 tons per acre. The colour of the bracts is a deep yellow. The natural flowers are commonly used for garlands for the dead, or plants dyed black are mixed with the yellow ones. The plant is also dyed green or orange-red, and thus employed for bouquets or other ornamental purposes.

Other species of *Helichrysum* and species of allied genera with scarios heads of flowers are also known as "everlastings." One of the best known is the Australian species *H. bracteatum*, with several varieties, including double forms, of different colours; *H. vestitum* (Cape of Good Hope) has white satiny heads. Others are species of *Helipteryx* (West Australia and South Africa), *Ammobium* and *Waitzia* (Australia) and *Xeranthemum* (south Europe). Several members of the natural order Amarantaceae have also "everlasting" flowers; such are *Gomphrena globosa*, with rounded or oval heads of white, orange, rose or violet, scarios bracts, and *Celosia pyramidalis*, with its elegant, loose, pyramidal inflorescences. Frequently these everlastings are mixed with bleached grasses, as *Lagurus ovatus*, *Briza maxima*, *Bromus brizaeformis*, or with the leaves of the Cape silver tree (*Leucadendron argenteum*), to form bouquets or ornamental groups.

EVERSLEY, CHARLES SHAW LEFEVRE, VISCOUNT (1794–1888), speaker of the British House of Commons, eldest son of Mr Charles Shaw (who assumed his wife's name of Lefevre in addition to his own on his marriage), was born in London on the 22nd of February 1794, and educated at Winchester and at Trinity College, Cambridge. He was called to the bar in 1819, and though a diligent student was also a keen sportsman. Marrying a daughter of Mr Samuel Whitbread, whose wife was the sister of Earl Grey, afterwards premier, he thus became

connected with two influential political families, and in 1830 he entered the House of Commons as member for Downton, in the Liberal interest. In 1831 he was returned, after a severe contest, as one of the county members for Hampshire, in which he resided; and after the passing of the Reform Act of 1832 he was elected for the Northern Division of the county. For some years Mr Shaw Lefevre was chairman of a committee on petitions for private bills. In 1835 he was chairman of a committee on agricultural distress, but as his report was not accepted by the House, he published it as a pamphlet addressed to his constituents. He acquired a high reputation in the House of Commons for his judicial fairness, combined with singular tact and courtesy, and when Mr James Abercromby retired in 1839, he was nominated as the Liberal candidate for the chair. The Conservatives put forward Henry Goulburn, but Mr Shaw Lefevre was elected by 317 votes to 299. The period was one of fierce party conflict, and the debates were frequently very acrimonious; but the dignity, temper and firmness of the new speaker were never at fault. In 1857 he had served longer than any of his predecessors, except the celebrated Arthur Onslow (1691–1768), who was speaker for more than 33 years in five successive parliaments. Retiring on a pension, he was raised to the peerage as Viscount Eversley of Heckfield, in the county of Southampton. His appearances in the House of Lords were very infrequent, but in his own county he was active in the public service. From 1859 he was an ecclesiastical commissioner, and he was also appointed a trustee of the British Museum. He died on the 28th of December 1888, the viscounty becoming extinct.

His younger brother, Sir JOHN GEORGE SHAW LEFEVRE (1797–1879), who was senior wrangler at Cambridge in 1818, had a long and distinguished career as a public official. He was under-secretary for the colonies, and had much to do with the introduction of the new poor law in 1834, and with the foundation of the colony of South Australia; then having served on several important commissions he was made clerk of the parliaments in 1855, and in the same year became one of the first civil service commissioners. He helped to found the university of London, of which he was vice-chancellor for twenty years, and also the Athenaeum Club. He died on the 20th of August 1879.

The latter's son, GEORGE JOHN SHAW LEFEVRE (b. 1832), was created Baron Eversley in 1906, in recognition of long and prominent services to the Liberal party. He had filled the following offices:—civil lord of the admiralty, 1856; secretary to the board of trade, 1869–1871; under-secretary, home office, 1871; secretary to the admiralty, 1871–1874; first commissioner of works, 1881–1883; postmaster-general, 1883–1884; first commissioner of works, 1892–1893; president of local government board, 1894–1895; chairman of royal commission on agriculture, 1893–1896.

EVESHAM, a market-town and municipal borough in the Evesham parliamentary division of Worcestershire, England, 107 m. W.N.W. of London by the Great Western railway, and 15 m. S.E. by E. of Worcester, with a station on the Redditch-Ashchurch branch of the Midland railway. Pop. (1901) 7101. It lies on the right (north) bank of the Avon, in the rich and beautiful Vale of Evesham. The district is devoted to market-gardening and orchards, and the trade of the town is mainly agricultural. Evesham is a place of considerable antiquity, a Benedictine house having been founded here by St Egwin in the 8th century. It became a wealthy abbey, but was almost wholly destroyed at the Dissolution. The churchyard, however, is entered by a Norman gateway, and there survives also a magnificent isolated bell-tower dating from 1533, of the best ornate Perpendicular workmanship. The abbey walls surround the churchyard, but almost the only other remnant is a single Decorated arch. Close to the bell-tower, however, are the two parish churches of St Lawrence and of All Saints, the former of the 16th century, the latter containing Early English work, and the ornate chapel of Abbot Lichfield, who erected the bell-tower. Other buildings include an Elizabethan town hall, the grammar school, founded by Abbot Lichfield, and the picturesque

almonry. The borough includes the parish of Bengeworth St Peter, on the left bank of the river. Evesham is governed by a mayor, 4 aldermen and 12 councillors. Area, 2265 acres.

Evesham (*Homme, Ethomme*) grew up around the Benedictine abbey, and had evidently become of some importance as a trading centre in 1055, when Edward the Confessor gave it a market and the privileges of a commercial town. It is uncertain when the town first became a borough, but the Domesday statement that the men paid 20s. may indicate the existence of a more or less organized body of tradesmen. Before 1482 the burgesses were holding the town at a fee farm rent of twenty marks, but the abbot still had practical control of the town, and his steward presided over the court at which the bailiffs were chosen. After the Dissolution the manor with the markets and fairs and other privileges was granted to Sir Philip Hoby, who increased his power over the town by persuading the burgesses to agree that, after they had nominated six candidates for the office of bailiff, the steward of the court instructed by him should indicate the two to be chosen. This privilege was contested by Queen Elizabeth, but when the case was taken before the court of the exchequer it was decided in favour of Sir Philip's heir, Sir Edward Hoby. In 1604 James I. granted the burgesses their first charter, but in the following year, by a second charter, he incorporated Evesham with the village of Bengeworth, and granted that the borough should be governed by a mayor and seven aldermen, to whom he gave the power of holding markets and fairs and several other privileges which had formerly belonged to the lord of the manor. Evesham received two later charters, but in 1688 that of 1605 was restored and still remains the governing charter of the borough. Evesham returned two members to parliament in 1295 and again in 1337, after which date the privilege lapsed until 1604. Its two members were reduced to one by the act of 1867, and the borough was disfranchised in 1885.

Evesham gave its name to the famous battle, fought on the 4th of August 1265, between the forces of Simon de Montfort, earl of Leicester, and the royalist army under Prince Edward. After a masterly campaign, in which the prince had succeeded in defeating Leicester in the valleys of the Severn and Usk, and had destroyed the forces of the younger Montfort at Kenilworth before he could effect a junction with the main body, the royalist forces approached Evesham in the morning of the 4th of August in time to intercept Leicester's march towards Kenilworth. Caught in the bend of the river Avon by the converging columns, and surrounded on all sides, the old earl attempted to cut his way out of the town to the northward. At first the fury of his assault forced back the superior numbers of the prince; but Simon's Welsh levies melted away and his enemies closed the last avenue of escape. The final struggle took place on Green Hill, a little to the north-west of the town, where the devoted friends of de Montfort formed a ring round their leader, and died with him. The spot is marked with an obelisk.

EVIDENCE (Lat. *evidentia, evideri*, to appear clearly), a term which may be defined briefly as denoting the facts presented to the mind of a person for the purpose of enabling him to decide a disputed question. Evidence in the widest sense includes all such facts, and reference may be made to the article LOGIC for the science or art of dealing with the proper way of drawing correct conclusions and the nature of proof. In a narrower sense, however, evidence includes in English law only such facts as are allowed to be so presented in the course of judicial proceedings. Thus we say that a fact is not evidence, meaning thereby that it is not admissible as evidence in accordance with the rules of English law. The law of legal evidence is part of the law of procedure. It determines the kinds of evidence which may be produced in judicial proceedings, and regulates the mode in which, and the conditions under which, evidence may be produced and tested.

The English law of evidence is of comparatively modern growth. It enshrines certain maxims, some derived from Roman law, some invented by Coke, who, as J. B. Thayer says, "spawned Latin maxims freely." But for the most part it was built up by English judges in the course of the

18th century, and consists of this judge-made law, as modified by statutory enactments of the 19th century. Early Teutonic procedure knew nothing of evidence in the modern sense, just as it knew nothing of trials in the modern sense. What it knew was "proofs." There were two modes of proof, ordeals and oaths. Both were appeals to the supernatural. The judicial combat was a bilateral ordeal. Proof followed, instead of preceding, judgment. A judgment of the court, called by German writers the *Beweisurteil*, and by M. M. Bigelow the "medial judgment," awarded that one of the two litigants must prove his case, by his body in battle, or by a one-sided ordeal, or by an oath with oath-helpers, or by the oaths of witnesses. The court had no desire to hear or weigh conflicting testimony. To do so would have been to exercise critical faculties, which the court did not possess, and the exercise of which would have been foreign to the whole spirit of the age. The litigant upon whom the burden of furnishing proof was imposed had a certain task to perform. If he performed it, he won; if he failed, he lost. The number of oath-helpers varied in different cases, and was determined by the law or by the court. They were probably, at the outset, kinsmen, who would have had to take up the blood-feud. At a later stage they became witnesses to character. In the cases, comparatively rare, where the oaths of witnesses were admitted as proof, their oaths differed materially from the sworn testimony of modern courts. As a rule no one could testify to a fact unless, when the fact happened, he was solemnly "taken to witness." Then, when the witness was adduced, he came merely to swear to a set formula. He did not make a promissory oath to answer questions truly. He merely made an assertory oath in a prescribed form.

In the course of the 12th and 13th centuries the old formal accusatory procedure began to break down, and to be superseded by another form of procedure known as *inquisitio*, inquest, or *enquête*. Its decay was hastened by the decree of the fourth Lateran Council in 1215, which forbade ecclesiastics to take part in ordeals. The Norman administrative system introduced into England by the Conquest was familiar with a method of ascertaining and determining facts by means of a verdict, return or finding made on oath by a body of men drawn from the locality. The system may be traced to Carolingian, and even earlier, sources. Henry II., by instituting the grand assize and the four petty assizes, placed at the disposal of litigants in certain actions the opportunity of giving proof by the verdict of a sworn inquest of neighbours, proof "by the country." The system was gradually extended to other cases, criminal as well as civil. The verdict given was that of persons having a general, but not necessarily a particular, acquaintance with the persons, places and facts to which the inquiry related. It was, in fact, a finding by local popular opinion. Had the finding of such an inquest been treated as final and conclusive in criminal cases, English criminal procedure might, like the continental inquisition, the French *enquête*, have taken the path which, in the forcible language of Fortescue (*De laudibus*, &c.) "leads to hell" (*semita ipsa est ad gehennam*). Fortunately English criminal procedure took a different course. The spirit of the old accusatory procedure was applied to the new procedure by inquest. In serious cases the words of the jurors, the accusing jurors, were treated not as testimony, but as accusation, the new indictment was treated as corresponding to the old appeal, and the preliminary finding by the accusing jury had to be supplemented by the verdict of another jury. In course of time the second jury were required to base their findings not on their own knowledge, but on evidence submitted to them. Thus the modern system of inquiry by grand jury and trial by petty jury was gradually developed.

A few words may here be said about the parallel development of criminal procedure on the continent of Europe. The tendency in the 12th and 13th centuries to abolish the old formal methods of procedure, and to give the new procedure the name of inquisition or inquest, was not peculiar to England. Elsewhere the old procedure was breaking down at the same time, and for similar reasons. It was the great pope Innocent III., the pope

of the fourth Lateran Council, who introduced the new inquisitorial procedure into the canon law. The procedure was applied to cases of heresy, and, as so applied, especially by the Dominicans, speedily assumed the features which made it infamous. "Every safeguard of innocence was abolished or disregarded; torture was freely used. Everything seems to have been done to secure a conviction." Yet, in spite of its monstrous defects, the inquisitorial procedure of the ecclesiastical courts, secret in its methods, unfair to the accused, having torture as an integral element, gradually forced its way into the temporal courts, and may almost be said to have been adopted by the common law of western Europe. In connexion with this inquisitorial procedure continental jurists elaborated a theory of evidence, or judicial proofs, which formed the subject of an extensive literature. Under the rules thus evolved full proof (*plena probatio*) was essential for conviction, in the absence of confession, and the standard of full proof was fixed so high that it was in most cases unattainable. It therefore became material to obtain confession by some means or other. The most effective means was torture, and thus torture became an essential feature in criminal procedure. The rules of evidence attempted to graduate the weight to be attached to different kinds of testimony and almost to estimate that weight in numerical terms. "Le parlement de Toulouse," said Voltaire, "a un usage très singulier dans les preuves par témoins. On admet ailleurs des demi-preuves, . . . mais à Toulouse on admet des quarts et des huitièmes de preuves." Modern continental procedure, as embodied in the most recent codes, has removed the worst features of inquisitorial procedure, and has shaken itself free from the trammels imposed by the old theory and technical rules of proof. But in this, as in other branches of law, France seems to have put the penalty for having been first in the field with codification by lagging behind in material reforms. The French Code of Criminal Procedure was largely based on Colbert's Ordonnance of 1670, and though embodying some reforms, and since amended on certain points, still retains some of the features of the unreformed procedure which was condemned in the 18th century by Voltaire and the *philosophes*. Military procedure is in the rear of civil procedure, and the trial of Captain Dreyfus at Rennes in 1899 presented some interesting archaisms. Among these were the weight attached to the rank and position of witnesses as compared with the intrinsic character of their evidence, and the extraordinary importance attributed to confession even when made under suspicious circumstances and supported by flimsy evidence.

The history of criminal procedure in England has been traced by Sir James Stephen. The modern rules and practice as to evidence and witnesses in the common law courts, both in civil and in criminal cases, appear to have taken shape in the course of the 18th century. The first systematic treatise on the English law of evidence appears to have been written by Chief Baron Gilbert, who died in 1726, but whose *Law of Evidence* was not published until 1761. In writing it he is said to have been much influenced by Locke.¹ It is highly praised by Blackstone as "a work which it is impossible to abstract or abridge without losing some beauty and destroying the charm of the whole"; but Bentham, who rarely agrees with Blackstone, speaks of it as running throughout "in the same strain of anility, garrulity, narrow-mindedness, absurdity, perpetual misrepresentation and indefatigable self-contradiction." In any case it remained the standard authority on the law of evidence throughout the remainder of the 18th century. Bentham wrote his *Rationale of Judicial Evidence, specially applied to English Practice*, at various times between the years 1802 and 1812.

¹ Reference may be made to a well-known passage in the *Essay concerning Human Understanding* (Book iv. ch. xv.): "The grounds of probability are—First, the conformity of anything with our own knowledge, observation and experience. Second, the testimony of others touching their observation and experience. In the testimony of others is to be considered (1) the number, (2) the integrity, (3) the skill of the witnesses. (4) The design of the author, where it is a testimony out of a book cited. (5) The consistency of the parts and circumstances of the relation. (6) Contrary testimonies."

By this time he had lost the nervous and simple style of his youth, and required an editor to make him readable. His great interpreter, Dumont, condensed his views on evidence into the *Traité des preuves judiciaires*, which was published in 1823. The manuscript of the *Rationale* was edited for English reading, and to a great extent rewritten, by J. S. Mill, and was published in five volumes in 1827. The book had a great effect both in England and on the continent. The English version, though crabbed and artificial in style, and unmeasured in its invective, is a storehouse of comments and criticisms on the principles of evidence and the practice of the courts, which are always shrewd and often profound. Bentham examined the practice of the courts by the light of practical utility. Starting from the principle that the object of judicial evidence is the discovery of truth, he condemned the rules which excluded some of the best sources of evidence. The most characteristic feature of the common-law rules of evidence was, as Bentham pointed out, and, indeed, still is, their exclusionary character. They excluded and prohibited the use of certain kinds of evidence which would be used in ordinary inquiries. In particular, they disqualified certain classes of witnesses on the ground of interest in the subject-matter of the inquiry, instead of treating the interest of the witness as a matter affecting his credibility. It was against this confusion between competency and credibility that Bentham directed his principal attack. He also attacked the system of paper evidence, evidence by means of affidavits instead of by oral testimony in court, which prevailed in the court of chancery, and in ecclesiastical courts. Subsequent legislation has endorsed his criticisms. The Judicature Acts have reduced the use of affidavits in chancery proceedings within reasonable limits. A series of acts of parliament have removed, step by step, almost all the disqualifications which formerly made certain witnesses incompetent to testify.

Before Bentham's work appeared, an act of 1814 had removed the incompetency of ratepayers as witnesses in certain cases relating to parishes. The Civil Procedure Act 1833 enacted that a witness should not be objected to as incompetent, solely on the ground that the verdict or judgment would be admissible in evidence for or against him. An act of 1840 removed some doubts as to the competency of ratepayers to give evidence in matters relating to their parish. The Evidence Act 1843 enacted broadly that witnesses should not be excluded from giving evidence by reason of incapacity from crime or interest. The Evidence Act 1851 made parties to legal proceedings admissible witnesses subject to a proviso that "nothing herein contained shall render any person who in any criminal proceeding is charged with the commission of any indictable offence, or any offence punishable on summary conviction, competent or compellable to give evidence for or against himself or herself, or shall render any person compellable to answer any question tending to criminate himself or herself, or shall in any criminal proceeding render any husband competent or compellable to give evidence for or against his wife, or any wife competent or compellable to give evidence for or against her husband." The Evidence (Scotland) Act 1853 made a similar provision for Scotland. The Evidence Amendment Act 1853 made the husbands and wives of parties admissible witnesses, except that husbands and wives could not give evidence for or against each other in criminal proceedings or in proceedings for adultery, and could not be compelled to disclose communications made to each other during marriage. Under the Matrimonial Causes Act 1857 the petitioner can be examined and cross-examined on oath at the hearing, but is not bound to answer any question tending to show that he or she has been guilty of adultery. Under the Matrimonial Causes Act 1859, on a wife's petition for dissolution of marriage on the ground of adultery coupled with cruelty or desertion, husband and wife are competent and compellable to give evidence as to the cruelty or desertion. The Crown Suits &c. Act 1865 declared that revenue proceedings were not to be treated as criminal proceedings for the purposes of the acts of 1851 and 1853. The Evidence Further Amendment Act 1869 declared that parties to actions for breach of promise of marriage

were competent to give evidence in the action, subject to a proviso that the plaintiff should not recover unless his or her testimony was corroborated by some other material evidence. It also made the parties to proceedings instituted in consequence of adultery, and their husbands and wives, competent to give evidence, but a witness in any such proceeding, whether a party or not, is not to be liable to be asked or bound to answer any question tending to show that he or she has been guilty of adultery, unless the witness has already given evidence in the same proceeding in disproof of the alleged adultery. There are similar provisions applying to Scotland in the Conjugal Rights (Scotland) Amendment Act 1861, and the Evidence Further Amendment (Scotland) Act 1874. The Evidence Act 1877 enacts that "on the trial of any indictment or other proceeding for the non-repair of any public highway or bridge, or for a nuisance to any public highway, river, or bridge, and of any other indictment or proceeding instituted for the purpose of trying or enforcing a civil right only, every defendant to such indictment or proceeding, and the wife or husband of any such defendant shall be admissible witnesses and compellable to give evidence." From 1872 onwards numerous enactments were passed making persons charged with particular offences, and their husbands and wives, competent witnesses. The language and effect of these enactments were not always the same, but the insertion of some provision to this effect in an act creating a new offence, especially if it was punishable by summary proceedings, gradually became almost a common form in legislation. In the year 1874 a bill to generalize these particular provisions, and to make the evidence of persons charged with criminal offences admissible in all cases was introduced by Mr Gladstone's government, and was passed by the standing committee of the House of Commons. During the next fourteen years bills for the same purpose were repeatedly introduced, either by the government of the day, or by Lord Bramwell as an independent member of the House of Lords. Finally the Criminal Evidence Act 1898, introduced by Lord Halsbury, has enacted in general terms that "every person charged with an offence, and the wife or husband, as the case may be, of the person so charged, shall be a competent witness for the defence at every stage of the proceedings, whether the person so charged is charged solely or jointly with any other person." But this general enactment is qualified by some special restrictions, the nature of which will be noticed below. The act applies to Scotland but not to Ireland. It was not to apply to proceedings in courts-martial unless so applied by general orders or rules made under statutory authority. The provisions of the act have been applied by rules to military courts-martial, but have not yet been applied to naval courts-martial. The removal of disqualifications for want of religious belief is referred to below under the head of "Witnesses."

The act of 1898 finishes for the present the history of English legislation on evidence. For a view of the legal literature on the subject it is necessary to take a step backwards. Early in the 19th century Chief Baron Gilbert was superseded as an authority on the English law of evidence by the books of Phillips (1814) and Starkie (1824), who were followed by Roscoe (*Nisi Prius*, 1827; *Criminal Cases*, 1835), Greenleaf (*American*, 1842), Taylor (based on Greenleaf, 1848), and Best (1849). In 1876 Sir James FitzJames Stephen brought out his *Digest of the Law of Evidence*, based upon the Indian Evidence Act 1872, which he had prepared and passed as law member of the council of the governor-general of India. This Digest obtained a rapid and well-deserved success, and has materially influenced the form of subsequent writings on the English law of evidence. It sifted out what Stephen conceived to be the main rules of evidence from the mass of extraneous matter in which they had been embedded. Roscoe's Digests told the lawyer what things must be proved in order to sustain particular actions or criminal charges, and related as much to pleadings and to substantive law as to evidence proper. Taylor's two large volumes were a vast storehouse of useful information, but his book was one to consult, not to master. Stephen eliminated much of this extraneous matter, and summed up his rules in a series of succinct propositions, supplemented by apt illustrations, and couched in such a form that they could be easily read and remembered. Hence the English Digest, like the Indian Act, has been of much educational value. Its most original feature, but unfortunately also its weakest point, is its theory of relevancy.

Pondering the multitude of "exclusionary" rules which had been laid down by the English courts, Stephen thought that he had discovered the general principle on which those rules rested, and could devise a formula by which the principle could be expressed. "My study of the subject," he says, "both practically and in books has convinced me that the doctrine that all facts in issue and relevant to the issue, and no others, may be proved, is the unexpressed principle which forms the centre of and gives unity to all the express negative rules which form the great mass of the law." The result was the chapter on the relevancy of facts in the Indian Evidence Act, and the definition of relevancy in s. 7 of that act. This definition was based on the view that a distinction could be drawn between things which were and things which were not causally connected with each other, and that relevancy depended on causal connexion. Subsequent criticism convinced Stephen that his definition was in some respects too narrow and in others too wide, and eventually he adopted a definition out of which all reference to causality was dropped. But even in their amended form the provisions about relevancy are open to serious criticism. The doctrine of relevancy, *i.e.* of the probative effect of facts, is a branch of logic, not of law, and is out of place both in an enactment of the legislature and in a compendium of legal rules. The necessity under which Stephen found himself of extending the range of relevant facts by making it include facts "deemed to be relevant," and then narrowing it by enabling the judge to exclude evidence of facts which are relevant, illustrates the difference between the rules of logic and the rules of law. Relevancy is one thing; admissibility is another; and the confusion between them, which is much older than Stephen, is to be regretted. Rightly or wrongly English judges have, on practical grounds, declared inadmissible evidence of facts, which are relevant in the ordinary sense of the term, and which are so treated in non-judicial inquiries. Under these circumstances the attempt so to define relevancy as to make it coterminous with admissibility is misleading, and most readers of Stephen's Act and Digest would find them more intelligible and more useful if "admissible" were substituted for "relevant" throughout. Indeed it is hardly too much to say that Stephen's doctrine of relevancy is theoretically unsound and practically useless. The other parts of the work contain terse and vigorous statements of the law, but a Procrustean attempt to make legal rules square with a preconceived theory has often made the language and arrangement artificial, and the work, in spite of its compression, still contains rules which, under a more scientific treatment, would find their appropriate place in other branches of the law. These defects are characteristic of a strong and able man, who saw clearly, and expressed forcibly what he did see, but was apt to ignore or to deny the existence of what he did not see, whose mind was vigorous rather than subtle or accurate, and who, in spite of his learning, was somewhat deficient in the historical sense. But notwithstanding these defects, the conspicuous ability of the author, his learning, and his practical experience, especially in criminal cases, attach greater weight to FitzJames Stephen's statements than to those of any other English writer on the law of evidence.

The object of every trial is, or may be, to determine two classes of questions or issues, which are usually distinguished as questions of law, and questions of fact, although the distinction between them is not so clear as might appear on a superficial view. In a trial by jury these two classes of questions are answered by different persons. The judge lays down the law. The jury, under the guidance of the judge, find the facts. It was with reference to trial by jury that the English rules of evidence were originally framed; it is by the peculiarities of this form of trial that many of them are to be explained; it is to this form of trial alone that some of the most important of them are exclusively applicable. The negative, exclusive, or exclusionary rules which form the characteristic features of the English law of evidence, are the rules in accordance with which the judge guides the jury. There is no difference of principle between the method of inquiry in judicial and in non-judicial proceedings. In either case a person who wishes to find out whether a particular event did or did not happen, tries, in the first place, to obtain information from persons who were present and saw what happened (direct evidence), and, failing this, to obtain information from persons who can tell him about facts from which he can draw an inference as to whether the event did or did not happen (indirect evidence). But in judicial inquiries the information given must be given on oath, and be liable to be tested by cross-examination. And there are rules of law which exclude from the consideration of the jury certain classes of facts which, in an ordinary inquiry, would, or might, be taken into consideration. Facts so excluded are said to be "not admissible as evidence," or "not evidence," according

as the word is used in the wider or in the narrower sense. And the easiest way of determining whether a fact is or is not evidence in the narrower sense, is first to consider whether it has any bearing on the question to be tried, and, if it has, to consider whether it falls within any one or more of the rules of exclusion laid down by English law. These rules of exclusion are peculiar to English law and to systems derived from English law. They have been much criticized, and some of them have been repealed or materially modified by legislation. Most of them may be traced to directions given by a judge in the course of trying a particular case, given with special reference to the circumstances of that case, but expressed in general language, and, partly through the influence of text-writers, eventually hardened into general rules. In some cases their origin is only intelligible by reference to obsolete forms of pleading or practice. But in most cases they were originally rules of convenience laid down by the judge for the assistance of the jury. The judge is a man of trained experience, who has to arrive at a conclusion with the help of twelve untrained men, and who is naturally anxious to keep them straight, and give them every assistance in his power. The exclusion of certain forms of evidence assists the jury by concentrating their attention on the questions immediately before them, and by preventing them from being distracted or bewildered by facts which either have no bearing on the question before them, or have so remote a bearing on those questions as to be practically useless as guides to the truth. It also prevents a jury from being misled by statements the effect of which, through the prejudice they excite, is out of all proportion to their true weight. In this respect the rules of exclusion may be compared to blinkers, which keep a horse's eyes on the road before him. In criminal cases the rules of exclusion secure fair play to the accused, because he comes to the trial prepared to meet a specific charge, and ought not to be suddenly confronted by statements which he had no reason to expect would be made against him. They protect absent persons against statements affecting their character. And lastly they prevent the infinite waste of time which would ensue in the discussion of a question of fact if an inquiry were allowed to branch out into all the subjects with which that fact is more or less connected. The purely practical grounds on which the rules are based, according to the view of a great judge, may be illustrated by some remarks of Mr Justice Willes (1814-1872). In discussing the question whether evidence of the plaintiff's conduct on other occasions ought to be admitted, he said:—

"It is not easy in all cases to draw the line and to define with accuracy where probability ceases and speculation begins; but we are bound to lay down the rule to the best of our ability. No doubt the rule as to confining the evidence to that which is relevant and pertinent to the issue is one of great importance, not only as regards the particular case, but also with reference to saving the time of the court, and preventing the minds of the jury from being drawn away from the real point they have to decide. . . . Now it appears to me that the evidence proposed to be given in this case, if admitted, would not have shown that it was more probable that the contract was subject to the condition insisted upon by the defendant. The question may be put thus, Does the fact of a person having once or many times in his life done a particular act in a particular way make it more probable that he has done the same thing in the same way upon another and different occasion? To admit such speculative evidence would, I think, be fraught with great danger. . . . If such evidence were held admissible it would be difficult to say that the defendant might not in any case, where the question was whether or not there had been a sale of goods on credit, call witnesses to prove that the plaintiff had dealt with other persons upon a certain credit; or, in an action for an assault, that the plaintiff might not give evidence of former assaults committed by the defendant upon other persons, or upon other persons of a particular class, for the purpose of showing that he was a quarrelsome individual, and therefore that it was highly probable that the particular charge of assault was well founded. The extent to which this sort of thing might be carried is inconceivable. . . . To obviate the prejudices, the injustice, and the waste of time to which the admission of such evidence would lead, and bearing in mind the extent to which it might be carried, and that litigants are mortal, it is necessary not only to adhere to the rule, but to lay it down strictly. I think, therefore, the fact that the plaintiff had entered into contracts of a particular kind with other persons on other occasions could not be properly admitted in evidence where no

custom of trade to make such contracts, and no connexion between such and the one in question, was shown to exist" (*Hollingham v. Head*, 1858, 4 C.B. N.S. 388).

There is no difference between the principles of evidence in civil and in criminal cases, although there are a few special rules, such as those relating to confessions and to dying declarations, which are only applicable to criminal proceedings. But in civil proceedings the issues are narrowed by mutual admissions of the parties, more use is made of evidence taken out of court, such as affidavits, and, generally, the rules of evidence are less strictly applied. It is often impolitic to object to the admission of evidence, even when the objection may be sustained by previous rulings. The general tendency of modern procedure is to place a more liberal and less technical construction on rules of evidence, especially in civil cases. In recent volumes of law reports cases turning on the admissibility of evidence are conspicuous by their rarity. Various causes have operated in this direction. One of them has been the change in the system of pleading, under which each party now knows before the actual trial the main facts on which his opponent relies. Another is the interaction of chancery and common-law practice and traditions since the Judicature Acts. In the chancery courts the rules of evidence were always less carefully observed, or, as Westminster would have said, less understood, than in the courts of common law. A judge trying questions of fact alone might naturally think that blinkers, though useful for a jury, are unnecessary for a judge. And the chancery judge was apt to read his affidavits first, and to determine their admissibility afterwards. In the meantime they had affected his mind.

The tendency of modern text-writers, among whom Professor J. B. Thayer (1831-1902), of Harvard, was perhaps the most independent, instructive and suggestive, is to restrict materially the field occupied by the law of evidence, and to relegate to other branches of the law topics traditionally treated under the head of evidence. Thus in every way the law of evidence, though still embodying some principles of great importance, is of less comparative importance as a branch of English law than it was half a century ago. Legal rules, like dogmas, have their growth and decay. First comes the judge who gives a ruling in a particular case. Then comes the text-writer who collects the scattered rulings, throws them into the form of general propositions, connects them together by some theory, sound or unsound, and often ignores or obscures their historical origin. After him comes the legislator who crystallizes the propositions into enactments, not always to the advantage of mankind. So also with decay. Legal rules fall into the background, are explained away, are ignored, are denied, are overruled. Much of the English law of evidence is in a stage of decay.

The subject-matter of the law of evidence may be arranged differently according to the taste or point of view of the writer. It will be arranged here under the following heads:—I. Preliminary Matter; II. Classes of Evidence; III. Rules of Exclusion; IV. Documentary Evidence; V. Witnesses.

I. PRELIMINARY MATTER

Under this head may be grouped certain principles and considerations which limit the range of matters to which evidence relates.

1. *Law and Fact*.—Evidence relates only to facts. It is therefore necessary to touch on the distinction between law and facts. *Ad questionem facti non respondent iudices; ad questionem juris non respondent juratores*. Thus Coke, attributing, after his wont, to Bracton a maxim which may have been invented by himself. The maxim became the subject of political controversy, and the two rival views are represented by Pulteney's lines—

"For twelve honest men have decided the cause
Who are judges alike of the facts and the laws,"

and by Lord Mansfield's variant—

"Who are judges of facts, but not judges of laws."

The particular question raised with respect to the law of libel

was settled by Fox's Libel Act 1792. Coke's maxim describes in a broad general way the distinction between the functions of the judge and of the jury, but is only true subject to important qualifications. Judges in jury cases constantly decide what may be properly called questions of fact, though their action is often disguised by the language applied or the procedure employed. Juries, in giving a general verdict, often practically take the law into their own hands. The border-line between the two classes of questions is indicated by the "mixed questions of law and fact," to use a common phrase, which arise in such cases as those relating to "necessaries," "due diligence," "negligence," "reasonableness," "reasonable and probable cause." In the treatment of these cases the line has been drawn differently at different times, and two conflicting tendencies are discernible. On the one hand, there is the natural tendency to generalize common inferences into legal rules, and to fix legal standards of duty. On the other hand, there is the sound instinct that it is a mistake to define and refine too much in these cases, and that the better course is to leave broadly to the jury, under the general guidance of the judge, the question what would be done by the "reasonable" or "prudent" man in particular cases. The latter tendency predominates in modern English law, and is reflected by the enactments in the recent acts codifying the law on bills of exchange and sale of goods, that certain questions of reasonableness are to be treated as questions of fact. On the same ground rests the dislike to limit the right of a jury to give a general verdict in criminal cases. Questions of custom begin by being questions of fact, but as the custom obtains general recognition it becomes law. Many of the rules of the English mercantile law were "found" as customs by Lord Mansfield's special juries. Generally, it must be remembered that the jury act in subordinate co-operation with the judge, and that the extent to which the judge limits or encroaches on the province of the jury is apt to depend on the personal idiosyncrasy of the judge.

2. *Judicial Notice.*—It may be doubted whether the subject of judicial notice belongs properly to the law of evidence, and whether it does not belong rather to the general topic of legal or judicial reasoning. Matters which are the subject of judicial notice are part of the equipment of the judicial mind. It would be absurd to require evidence of every fact; many facts must be assumed to be known. The judge, like the jurymen, is supposed to bring with him to the consideration of the question which he has to try common sense, a general knowledge of human nature and the ways of the world, and also knowledge of things that "everybody is supposed to know." Of such matters judicial notice is said to be taken. But the range of general knowledge is indefinite, and the range of judicial notice has, for reasons of convenience, been fixed or extended, both by rulings of the judges and by numerous enactments of the legislature. It would be impossible to enumerate here the matters of which judicial notice must or may be taken. These are to be found in the text-books. For present purposes it must suffice to say that they include not only matters of fact of common and certain knowledge, but the law and practice of the courts, and many matters connected with the government of the country.

3. *Presumptions.*—A presumption in the ordinary sense is an inference. It is an argument, based on observation, that what has happened in some cases will probably happen in others of the like nature. The subject of presumptions, so far as they are mere inferences or arguments, belongs, not to the law of evidence, or to law at all, but to rules of reasoning. But a legal presumption, or, as it is sometimes called, a presumption of law, as distinguished from a presumption of fact, is something more. It may be described, in Stephen's language, as "a rule of law that courts and judges shall draw a particular inference from a particular fact, or from particular evidence, unless and until the truth" (perhaps it would be better to say 'soundness') "of the inference is disproved." Courts and legislatures have laid down such rules on grounds of public policy or general convenience, and the rules have then to be observed as rules of positive law, not merely used as part of the ordinary process of

reasoning or argument. Some so-called presumptions are rules of substantive law under a disguise. To this class appear to belong "conclusive presumptions of law," such as the common-law presumption that a child under seven years of age cannot commit a felony. So again the presumption that every one knows the law is merely an awkward way of saying that ignorance of the law is not a legal excuse for breaking it. Of true legal presumptions, the majority may be dealt with most appropriately under different branches of the substantive law, such as the law of crime, of property, or of contract, and accordingly Stephen has included in his *Digest of the Law of Evidence* only some which are common to more than one branch of the law. The effect of a presumption is to impute to certain facts or groups of facts a prima facie significance or operation, and thus, in legal proceedings, to throw upon the party against whom it works the duty of bringing forward evidence to meet it. Accordingly the subject of presumptions is intimately connected with the subject of the burden of proof, and the same legal rule may be expressed in different forms, either as throwing the advantage of a presumption on one side, or as throwing the burden of proof on the other. Thus the rule in Stephen's Digest, which says that the burden of proving that any person has been guilty of a crime or wrongful act is on the person who asserts it, appears in the article entitled "Presumption of Innocence." Among the more ordinary and more important legal presumptions are the presumption of regularity in proceedings, described generally as a presumption *omnia esse rite acta*, and including the presumption that the holder of a public office has been duly appointed, and has duly performed his official duties, the presumption of the legitimacy of a child born during the mother's marriage, or within the period of gestation after her husband's death, and the presumptions as to life and death. "A person shown not to have been heard of for seven years by those (if any) who, if he had been alive, would naturally have heard of him, is presumed to be dead unless the circumstances of the case are such as to account for his not being heard of without assuming his death; but there is no presumption as to the time when he died, and the burden of proving his death at any particular time is upon the person who asserts it. There is no presumption" (*i.e.* legal presumption) "as to the age at which a person died who is shown to have been alive at a given time, or as to the order in which two or more persons died who are shown to have died in the same accident, shipwreck or battle" (Stephen, *Dig.*, art. 99). A document proved or purporting to be thirty years old is presumed to be genuine, and to have been properly executed and (if necessary) attested if produced from the proper custody. And the legal presumption of a "lost grant," *i.e.* the presumption that a right or alleged right which has been long enjoyed without interruption had a legal origin, still survives in addition to the common law and statutory rules of prescription.

4. *Burden of Proof.*—The expression *onus probandi* has come down from the classical Roman law, and both it and the Roman maxims, *Agenti incumbit probatio*, *Necessitas probandi incumbit ei qui dicit non ei qui negat*, and *Reus excipiendo fit actor*, must be read with reference to the Roman system of actions, under which nothing was admitted, but the plaintiff's case was tried first; then, unless that failed, the defendant's on his *exceptio*; then, unless that failed, the plaintiff's on his *replicatio*, and so on. Under such a system the burden was always on the "actor." In modern law the phrase "burden of proof" may mean one of two things, which are often confused—the burden of establishing the proposition or issue on which the case depends, and the burden of producing evidence on any particular point either at the beginning or at a later stage of the case. The burden in the former sense ordinarily rests on the plaintiff or prosecutor. The burden in the latter sense, that of going forward with evidence on a particular point, may shift from side to side as the case proceeds. The general rule is that he who alleges a fact must prove it, whether the allegation is couched in affirmative or negative terms. But this rule is subject to the effect of presumptions in particular cases, to the principle that in considering the amount of evidence necessary to shift the burden of proof regard

must be had to the opportunities of knowledge possessed by the parties respectively, and to the express provisions of statutes directing where the burden of proof is to lie in particular cases. Thus many statutes expressly direct that the proof of lawful excuse or authority, or the absence of fraudulent intent, is to lie on the person charged with an offence. And the Summary Jurisdiction Act 1848 provides that if the information or complaint in summary proceedings negatives any exemption, exception, proviso, or condition in the statute on which it is founded, the prosecutor or complainant need not prove the negative, but the defendant may prove the affirmative in his defence.

II. CLASSES OF EVIDENCE

Evidence is often described as being either oral or documentary. To these two classes should be added a third, called by Bentham real evidence, and consisting of things presented immediately to the senses of the judge or the jury. Thus the judge or jury may go to view any place the sight of which may help to an understanding of the evidence, and may inspect anything sufficiently identified and produced in court as material to the decision. Weapons, clothes and things alleged to have been stolen or damaged are often brought into court for this purpose. Oral evidence consists of the statements of witnesses. Documentary evidence consists of documents submitted to the judge or jury by way of proof. The distinction between primary and secondary evidence relates only to documentary evidence, and will be noticed in the section under that head. A division of evidence from another point of view is that into direct and indirect, or, as it is sometimes called, circumstantial evidence. By direct evidence is meant the statement of a person who saw, or otherwise observed with his senses, the fact in question. By indirect or circumstantial evidence is meant evidence of facts from which the fact in question may be inferred. The difference between direct and indirect evidence is a difference of kind, not of degree, and therefore the rule or maxim as to "best evidence" has no application to it. Juries naturally attach more weight to direct evidence, and in some legal systems it is only this class of evidence which is allowed to have full probative force. In some respects indirect evidence is superior to direct evidence, because, as Paley puts it, "facts cannot lie," whilst witnesses can and do. On the other hand facts often deceive; that is to say, the inferences drawn from them are often erroneous. The circumstances in which crimes are ordinarily committed are such that direct evidence of their commission is usually not obtainable, and when criminality depends on a state of mind, such as intention, that state must necessarily be inferred by means of indirect evidence.

III. RULES OF EXCLUSION

It seems desirable to state the leading rules of exclusion in their crude form instead of obscuring their historical origin by attempting to force them into the shape of precise technical propositions forming parts of a logically connected system. The judges who laid the foundations of our modern law of evidence, like those who first discoursed on the duties of trustees, little dreamt of the elaborate and artificial system which was to be based upon their remarks. The rules will be found, as might be expected, to be vague, to overlap each other, to require much explanation, and to be subject to many exceptions. They may be stated as follows:—(1) Facts not relevant to the issue cannot be admitted as evidence. (2) The evidence produced must be the best obtainable under the circumstances. (3) Hearsay is not evidence. (4) Opinion is not evidence.

1. *Rule of Relevancy.*—The so-called rule of relevancy is sometimes stated by text-writers in the form in which it was laid down by Baron Parke in 1837 (*Wright v. Doe and Tatham*, 7 A. and E. 384), when he described "one great principle" in the law of evidence as being that "all facts which are relevant to the issue may be proved." Stated in different forms, the rule has been made by FitzJames Stephen the central point of his theory of evidence. But relevancy, in the proper and natural sense, as we have said, is a matter not of law, but of logic. If Baron

Parke's dictum relates to relevancy in its natural sense it is not true; if it relates to relevancy in a narrow and artificial sense, as equivalent to admissible, it is tautological. Such practical importance as the rule of relevancy possesses consists, not in what it includes, but in what it excludes, and for that reason it seems better to state the rule in a negative or exclusive form. But whether the rule is stated in a positive or in a negative form its vagueness is apparent. No precise line can be drawn between "relevant" and "irrelevant" facts. The two classes shade into each other by imperceptible degrees. The broad truth is that the courts have excluded from consideration certain matters which have some bearing on the question to be decided, and which, in that sense, are relevant, and that they have done so on grounds of policy and convenience. Among the matters so excluded are matters which are likely to mislead the jury, or to complicate the case unnecessarily, or which are of slight, remote, or merely conjectural importance. Instances of the classes of matters so excluded can be given, but it seems difficult to refer their exclusion to any more general principle than this. Rules as to evidence of character and conduct appear to fall under this principle. Evidence is not admissible to show that the person who is alleged to have done a thing was of a disposition or character which makes it probable that he would or would not have done it. This rule excludes the biographical accounts of the prisoner which are so familiar in French trials, and is an important principle in English trials. It is subject to three exceptions: first, that evidence of good character is admissible in favour of the prisoner in all criminal cases; secondly, that a prisoner indicted for rape is entitled to call evidence as to the immoral character of the prosecutrix; and thirdly, that a witness may be called to say that he would not believe a previous witness on his oath. The exception allowing the good character of a prisoner to influence the verdict, as distinguished from the sentence, is more humane than logical, and seems to have been at first admitted in capital cases only. The exception in rape cases does not allow evidence to be given of specific acts of immorality with persons other than the prisoner, doubtless on the ground that such evidence would affect the reputations of third parties. Where the character of a person is expressly in issue, as in actions of libel and slander, the rule of exclusion, as stated above, does not apply. Nor does it prevent evidence of bad character from being given in mitigation of damages, where the amount of damages virtually depends on character, as in cases of defamation and seduction. As to conduct there is a similar general rule, that evidence of the conduct of a person on other occasions is not to be used merely for the purpose of showing the likelihood of his having acted in a similar way on a particular occasion. Thus, on a charge of murder, the prosecutor cannot give evidence of the prisoner's conduct to other persons for the purpose of proving a bloodthirsty and murderous disposition. And in a civil case a defendant was not allowed to show that the plaintiff had sold goods on particular terms to other persons for the purpose of proving that he had sold similar goods on the same terms to the defendant. But this general rule must be carefully construed. Where several offences are so connected with each other as to form parts of an entire transaction, evidence of one is admissible as proof of another. Thus, where a prisoner is charged with stealing particular goods from a particular place, evidence may be given that other goods, taken from the same place at the same time, were found in his possession. And where it is proved or admitted that a person did a particular act, and the question is as to his state of mind, that is to say, whether he did the act knowingly, intentionally, fraudulently, or the like, evidence may be given of the commission by him of similar acts on other occasions for the purpose of proving his state of mind on the occasion. This principle is most commonly applied in charges for uttering false documents or base coin, and not uncommonly in charges for false pretences, embezzlement or murder. In proceedings for the receipt or possession of stolen property, the legislature has expressly authorized evidence to be given of the possession by the prisoner of other stolen property, or of his previous conviction of an offence involving fraud or dishonesty

(Prevention of Crimes Act 1871). Again, where there is a question whether a person committed an offence, evidence may be given of any fact supplying a motive or constituting preparation for the offence, of any subsequent conduct of the person accused, which is apparently influenced by the commission of the offence, and of any act done by him, or by his authority, in consequence of the offence. Thus, evidence may be given that, after the commission of the alleged offence, the prisoner absconded, or was in possession of the property, or the proceeds of the property, acquired by the offence, or that he attempted to conceal things which were or might have been used in committing the offence, or as to the manner in which he conducted himself when statements were made in his presence and hearing. Statements made to or in the presence of a person charged with an offence are admitted as evidence, not of the facts stated, but of the conduct or demeanour of the person to whom or in whose presence they are made, or of the general character of the transaction of which they form part (under the *res gestae* rule mentioned below).

2. *Best Evidence Rule*.—Statements to the effect of the best evidence rule were often made by Chief Justice Holt about the beginning of the 18th century, and became familiar in the courts. Chief Baron Gilbert, in his book on evidence, which must have been written before 1726, says that "the first and most signal rule in relation to evidence is this, that a man must have the utmost evidence the nature of the fact is capable of." And in the great case of *Omichund v. Barker* (1744), Lord Hardwicke went so far as to say, "The judges and sages of the law have laid down that there is but one general rule of evidence, the best that the nature of the case will admit" (1 Atkyns 49). It is no wonder that a rule thus solemnly stated should have found a prominent place in text-books on the law of evidence. But, apart from its application to documentary evidence, it does not seem to be more than a useful guiding principle which underlies, or may be used in support of, several rules.

It is to documentary evidence that the principle is usually applied, in the form of the narrower rule excluding, subject to exceptions, secondary evidence of the contents of a document where primary evidence is obtainable. In this form the rule is a rule of exclusion, but may be most conveniently dealt with in connexion with the special subject of documentary evidence. As noticed above, the general rule does not apply to the difference between direct and indirect evidence. And, doubtless on account of its vague character, it finds no place in Stephen's Digest.

3. *Hearsay*.—The term "hearsay" primarily applies to what a witness has heard another person say in respect to a fact in dispute. But it is extended to any statement, whether reduced to writing or not, which is brought before the court, not by the author of the statement, but by a person to whose knowledge the statement has been brought. Thus the hearsay rule excludes statements, oral or written, made in the first instance by a person who is not called as a witness in the case. Historically this rule may be traced to the time when the functions of the witnesses were first distinguished from the functions of the jury, and when the witnesses were required by their formula to testify *de visu suo et auditu*, to state what they knew about facts from the direct evidence of their senses, not from the information of others. The rule excludes statements the effect of which is liable to be altered by the narrator, and which purport to have been made by persons who did not necessarily speak under the sanction of an oath, and whose accuracy or veracity is not tested by cross-examination. It is therefore of practical utility in shutting out many loose statements and much irresponsible gossip. On the other hand, it excludes statements which are of some value as evidence, and may indeed be the only available evidence. Thus, a statement has been excluded as hearsay, even though it can be proved that the author of the statement made it on oath, or that it was against his interest when he made it, or that he is prevented by insanity or other illness from giving evidence himself, or that he has left the country and disappeared, or that he is dead.

Owing to the inconveniences which would be caused by a strict application of the rule, it has been so much eaten into by exceptions that some persons doubt whether the rule and the exceptions ought not to change places. Among the exceptions the following may be noticed: (a) *Certain sworn statements*.—In many cases statements made by a person whose evidence is material, but who cannot come before the court, or could not come before it without serious difficulty, delay or expense, may be admitted as evidence under proper safeguards. Under the Indictable Offences Act 1848, where a person has made a deposition before a justice at a preliminary inquiry into an offence, his deposition may be read in evidence on proof that the deponent is dead, or too ill to travel, that the deposition was taken in the presence of the accused person, and that the accused then had a full opportunity of cross-examining the deponent. The deposition must appear to be signed by the justice before whom it purports to have been taken. Depositions taken before a coroner are admissible under the same principle. And the principle probably extends to cases where the deponent is insane, or kept away by the person accused. There are other statutory provisions for the admission of depositions, as in the Criminal Law Amendment Act 1867; the Foreign Jurisdiction Act 1890; and the Children Act 1908, incorporating an act of 1894. In civil cases the rule excluding statements not made in court at the trial is much less strictly applied. Frequent use is made of evidence taken before an examiner, or under a commission. Affidavits are freely used for subordinate issues or under an arrangement between the parties, and leave may be given to use evidence taken in other proceedings. The old chancery practice, under which evidence, both at the trial and at other stages of a proceeding, was normally taken by affidavit, irrespectively of consent, was altered by the Judicature Acts. Under the existing rules of the supreme court evidence may be given by affidavit upon any motion, petition or summons, but the court or a judge may, on the application of either party, order the attendance for cross-examination of the person making the affidavit. (b) *Dying declarations*.—In a trial for murder or manslaughter a declaration by the person killed as to the cause of his death, or as to any of the circumstances of the transaction which resulted in his death, is admissible as evidence. But this exception is very strictly construed. It must be proved that the declarant, at the time of making the declaration, was in actual danger of death, and had given up all hope of recovery. (c) *Statements in pedigree cases*.—On a question of pedigree the statement of a deceased person, whether based on his own personal knowledge or on family tradition, is admissible as evidence, if it is proved that the person who made the statement was related to the person about whose family relations the statement was made, and that the statement was made before the question with respect to which the evidence is required had arisen. (d) *Statements as to matters of public or general interest*.—Statements by deceased persons are admissible as evidence of reputation or general belief in questions relating to the existence of any public or general right or custom, or matter of public and general interest. Statements of this kind are constantly admitted in questions relating to right of way, or rights of common, or manorial or other local customs. Maps, copies of court rolls, leases and other deeds, and verdicts, judgments, and orders of court fall within the exception in cases of this kind. (e) *Statements in course of duty or business*.—A statement with respect to a particular fact made by a deceased person in pursuance of his duty in connexion with any office, employment or business, whether public or private, is admissible as evidence of that fact, if the statement appears to have been made from personal knowledge, and at or about the time when the fact occurred. This exception covers entries by clerks and other employees. (f) *Statements against interest*.—A statement made by a deceased person against his pecuniary or proprietary interest is admissible as evidence, without reference to the time at which it was made. Where such a statement is admissible the whole of it becomes admissible, though it may contain matters not against the interest of the person who made it, and though the total effect may be in his favour. Thus, where there was a question whether a particular sum was a gift or a loan, entries in an account book of receipt of interest on the sum were admitted, and a statement in the book that the alleged debtor had on a particular date acknowledged the loan was also admitted. (g) *Public documents*.—Under this head may be placed recitals in public acts of parliament, notices in the *London, Edinburgh, or Dublin Gazette* (which are made evidence by statute in a large number of cases), and entries made in the performance of duty in official registers or records, such as registers of births, deaths or marriages, registers of companies, records in judicial proceedings, and the like. An entry in a public document may be treated as a statement made in the course of duty, but it is admissible whether the person who made the statement is alive or dead, and without any evidence as to personal knowledge, or the time at which the statement is made. (h) *Admissions*.—By the term "admission," as here used, is meant a statement made out of the witness-box by a party to the proceedings, whether civil or criminal, or by some person whose statements are binding on that party, against the interest of that party. The term includes admissions made in answer to interrogatories, or to a notice to admit facts, but not admissions made on the pleadings. Admissions, in this sense of the term, are admissible as evidence against the person by whom they are made, or on whom they are binding,

without reference to the life or death of the person who made them. A person is bound by the statements of his agent, acting within the scope of his authority, and barristers and solicitors are agents for their clients in the conduct of legal proceedings. Conversely, a person suing or defending on behalf of another, e.g. as agent or trustee, is bound by the statements of the person whom he represents. Statements respecting property made by a predecessor in title bind the successor. Where a statement is put in evidence as an admission by, or binding on, any person, that person is entitled to have the whole statement given in evidence. The principle of this rule is obviously sound, because it would be unfair to pick out from a man's statement what tells against him, and to suppress what is in his favour. But the application of the rule is sometimes attended with difficulty. An admission will not be allowed to be used as evidence if it was made under a stipulation, express or implied, that it should not be so used. Such admissions are said to be made "without prejudice." (i) *Confessions*.—A confession is an admission by a person accused of an offence that he has committed the offence of which he is accused. But the rules about admitting as evidence confessions in criminal proceedings are much more strict than the rules about admissions in civil proceedings. The general rule is, that a confession is not admissible as evidence against any person except the person who makes it. But a confession made by one accomplice in the presence of another is admissible against the latter to this extent, that, if it implicates him, his silence under the charge may be used against him, whilst on the other hand his prompt repudiation of the charge might tell in his favour. In other words, the confession may be used as evidence of the conduct of the person in whose presence it was made. A confession cannot be admitted as evidence unless proved to be voluntary. A confession is not treated as being voluntary if it appears to the court to have been caused by any inducement, threat or promise which proceeded from a magistrate or other person in authority concerned in the charge, and which, in the opinion of the court, gave the accused person reasonable ground for supposing that by making a confession he would gain some advantage or avoid some evil in reference to the proceedings against him. This applies to any inducement, threat or promise having reference to the charge, whether it is addressed directly to the accused person or is brought to his knowledge indirectly. But a confession is not involuntary merely because it appears to have been caused by the exhortations of a person in authority to make it as a matter of religious duty, or by an inducement collateral to the proceedings, or by an inducement held out by a person having nothing to do with the apprehension, prosecution or examination of the prisoner. Thus, a confession made to a gaol chaplain in consequence of religious exhortation has been admitted as evidence. So also has a confession made by a prisoner to a gaoler in consequence of a promise by the gaoler, that if the prisoner confessed he should be allowed to see his wife. To make a confession involuntary, the inducement must have reference to the prisoner's escape from the charge against him, and must be made by some person having power to relieve him, wholly or partially, from the consequences of the charge. A confession is treated as voluntary if, in the opinion of the court, it was made after the complete removal of the impression produced by any inducement, threat or promise which would have made it involuntary. Where a confession was made under an inducement which makes the confession involuntary, evidence may be given of facts discovered in consequence of the confession, and of so much of the confession as distinctly relates to those facts. Thus, A. under circumstances which make the confession involuntary, tells a policeman that he, A., had thrown a lantern into the pond. Evidence may be given that the lantern was found in the pond, and that A. said he had thrown it there. It is of course improper to try to extort a confession by fraud or under the promise of secrecy. But if a confession is otherwise admissible as evidence, it does not become inadmissible merely because it was made under a promise of secrecy, or in consequence of a deception practised on the accused person for the purpose of obtaining it, or when he was drunk, or because it was made in answer to questions, whether put by a magistrate or by a private person, or because he was not warned that he was not bound to make the confession, and that it might be used against him. If a confession is given in evidence, the whole of it must be given, and not merely the parts disadvantageous to the accused person. Evidence amounting to a confession may be used as such against the person who gave it, though it was given on oath, and though the proceeding in which it was given had reference to the same subject-matter as the proceeding in which it is to be used, and though the witness might have refused to answer the questions put to him. But if, after refusing to answer such questions, the witness is improperly compelled to answer, his answers are not a voluntary confession. The grave jealousy and suspicion with which the English law regards confessions offer a marked contrast to the importance attached to this form of evidence in other systems of procedure, such as the inquisitorial system which long prevailed, and still to some extent prevails, on the continent. (j) *Res gestae*.—Statements are often admitted as evidence on the ground that they form part of what is called the "transaction," or *res gestae*, the occurrence or nature of which is in question. For instance, where an act may be proved, statements accompanying and explaining the act made by or to the person doing it, may be given in evidence.

There is no difficulty in understanding the principle on which this exception from the hearsay rule rests, but there is often practical difficulty in applying it, and the practice has varied. How long is the "transaction" to be treated as lasting? What ought to be treated as "the immediate and natural effect of continuing action," and, for that reason, as part of the *res gestae*? When an act of violence is committed, to what extent are the terms of the complaint made by the sufferer, as distinguished from the fact of a complaint having been made, admissible as evidence? These are some of the questions raised. The cases in which statements by a person as to his bodily or mental condition may be put in evidence may perhaps be treated as falling under the same principle. In the Rugeley poisoning case, statements by the deceased person before his illness as to his state of health, and as to his symptoms during illness, were admitted as evidence for the prosecution. Under the same principle may also be brought the rule as to statements in conspiracy cases. In charges of conspiracy, after evidence has been given of the existence of the plot, and of the connexion of the accused with it, the charge against one conspirator may be supported by evidence of anything done, written, or said, not only by him, but by any other of the conspirators, in furtherance of the common purpose. On the other hand, a statement made by one conspirator, not in execution of the common purpose, but in narration of some event forming part of the conspiracy, would be treated, not as part of the "transaction," but as a statement excluded by the hearsay rule. Thus the admissibility of writings in conspiracy cases may depend on the time when they can be shown to have been in the possession of a fellow-conspirator, whether before or after the prisoner's apprehension. (k) *Complaints in rape cases, &c.*—In trials for rape and similar offences, the fact that shortly after the commission of the alleged offence a complaint was made by the person against whom the offence was committed, and also the terms of the complaint, have been admitted as evidence, not of the facts complained of, but of the consistency of the complainant's conduct with the story told by her in the witness-box, and as negating consent on her part.

4. *Opinion*.—The rule excluding expressions of opinion also dates from the first distinction between the functions of witnesses and jury. It was for the witnesses to state facts, for the jury to form conclusions. Of course every statement of fact involves inference, and implies a judgment on phenomena observed by the senses. And the inference is often erroneous, as in the answer to the question, "Was he drunk?" A prudent witness will often guard himself, and is allowed to guard himself, by answering to the best of his belief. But, for practical purposes, it is possible to draw a distinction between a statement of facts observed and an expression of opinion as to the inference to be drawn from these facts, and the rule telling witnesses to state facts and not express opinions is of great value in keeping their statements out of the region of argument and conjecture. The evidence of "experts," that is to say, of persons having a special knowledge of some particular subject, is generally described as constituting the chief exception to the rule. But perhaps it would be more accurate to say that experts are allowed a much wider range than ordinary witnesses in the expression of their opinions, and in the statement of facts on which their opinions are based. Thus, in a poisoning case, a doctor may be asked as an expert whether, in his opinion, a particular poison produces particular symptoms. And, where lunacy is set up as a defence, an expert may be asked whether, in his opinion, the symptoms exhibited by the alleged lunatic commonly show unsoundness of mind, and whether such unsoundness of mind usually renders persons incapable of knowing the nature of their acts, or of knowing that what they do is either wrong or contrary to the law. Similar principles are applied to the evidence of engineers, and in numerous other cases. In cases of disputed handwriting the evidence of experts in handwriting is expressly recognized by statute (*Evidence and Practice on Criminal Trials* 1865).

IV. DOCUMENTARY EVIDENCE

Charters and other writings were exhibited to the jury at a very early date, and it is to writings so exhibited that the term "evidence" or "evidences" seems to have been originally applied *par excellence*. The oral evidence of witnesses came later. Where a document is to be used as evidence the first question is how its contents are to be proved. To this question the principle of "best evidence" applies, in the form of the rule that primary evidence must be given except in the cases where secondary evidence is allowed. By primary evidence is meant the document itself produced for inspection. By secondary

evidence is meant a copy of the document, or verbal accounts of its contents.

The rule as to the inadmissibility of a copy of a document is applied much more strictly to private than to public or official documents. Secondary evidence may be given of the contents of a private document in the following cases:

- (a) Where the original is shown or appears to be in the possession of the adverse party, and he, after having been served with reasonable notice to produce it, does not do so.
- (b) Where the original is shown or appears to be in the possession or power of a stranger not legally bound to produce it, and he, after having been served with a writ of *subpoena duces tecum*, or after having been sworn as a witness and asked for the document, and having admitted that it is in court, refuses to produce it.
- (c) Where it is shown that proper search has been made for the original, and there is reason for believing that it is destroyed or lost.
- (d) Where the original is of such a nature as not to be easily movable, as in the case of a placard posted on a wall, or of a tombstone, or is in a country from which it is not permitted to be removed.
- (e) Where the original is a document for the proof of which special provision is made by any act of parliament, or any law in force for the time being. Documents of that kind are practically treated on the same footing as private documents.
- (f) Where the document is an entry in a banker's book, provable according to the special provisions of the Bankers' Books Evidence Act 1879.

Secondary evidence of a private document is usually given either by producing a copy and calling a witness who can prove the copy to be correct, or, when there is no copy obtainable, by calling a witness who has seen the document, and can give an account of its contents. No general definition of public document is possible, but the rules of evidence applicable to public documents are expressly applied by statute to many classes of documents. Primary evidence of any public document may be given by producing the document from proper custody, and by a witness identifying it as being what it professes to be. Public documents may always be proved by secondary evidence, but the particular kind of secondary evidence required is in many cases defined by statute. Where a document is of such a public nature as to be admissible in evidence on its mere production from the proper custody, and no statute exists which renders its contents provable by means of a copy, any copy thereof or extract therefrom is admissible as proof of its contents, if it is proved to be an examined copy or extract, or purports to be signed or certified as a true copy or extract by the officer to whose custody the original is entrusted. Many statutes provide that various certificates, official and public documents, documents and proceedings of corporations and of joint stock and other companies, and certified copies of documents, by-laws, entries in registers and other books, shall be receivable as evidence of certain particulars in courts of justice, if they are authenticated in the manner prescribed by the statutes. Whenever, by virtue of any such provision, any such certificate or certified copy is receivable as proof of any particular in any court of justice, it is admissible as evidence, if it purports to be authenticated in the manner prescribed by law, without calling any witness to prove any stamp, seal, or signature required for its authentication, or the official character of the person who appears to have signed it. The Documentary Evidence Acts 1868, 1882 and 1895, provide modes of proving the contents of several classes of proclamations, orders and regulations.

If a document is of a kind which is required by law to be attested, but not otherwise, an attesting witness must be called to prove its due execution. But this rule is subject to the following exceptions:

- (a) If it is proved that there is no attesting witness alive, and capable of giving evidence, then it is sufficient to prove that the attestation of at least one attesting witness is in his handwriting, and that the signature of the person executing the document is in the handwriting of that person.
- (b) If the document is proved, or purports to be, more than thirty years old, and is produced from what the court considers to be its proper custody, an attesting witness need not be called, and it will be presumed without evidence that the instrument was duly executed and attested.

Where a document embodies a judgment, a contract, a grant, or disposition of property, or any other legal transaction or "act in the law," on which rights depend, the validity of the transaction may be impugned on the ground of fraud, incapacity, want of consideration, or other legal ground. But this seems outside the law of evidence. In this class of cases a question often arises whether extrinsic evidence can be produced to vary the nature of the transaction embodied in the document. The answer to this question seems to depend on whether the docu-

ment was or was not intended to be a complete and final statement of the transaction which it embodies. If it was, you cannot go outside the document for the purpose of ascertaining the nature of the transaction. If it was not, you may. But the mere statement of this test shows the difficulty of formulating precise rules, and of applying them when formulated. Fitz-James Stephen mentions, among the facts which may be proved in these cases, the existence of separate and consistent oral agreements as to matters on which the document is silent, if there is reason to believe that the document is not a complete and final statement of the transaction, and the existence of any usage or custom with reference to which a contract may be presumed to have been made. But he admits that the rules on the subject are "by no means easy to apply, inasmuch as from the nature of the case an enormous number of transactions fall close on one side or the other of most of them." The underlying principle appears to be a rule of substantive law rather than of evidence. When parties to an arrangement have reduced the terms of the arrangement to a definite, complete, and final written form, they should be bound exclusively by the terms embodied in that form. The question in each case is under what circumstances they ought to be treated as having done so.

The expression "parol evidence," which includes written as well as verbal evidence, has often been applied to the extrinsic evidence produced for the purpose of varying the nature of the transaction embodied in a document. It is also applied to extrinsic evidence used for another purpose, namely, that of explaining the meaning of the terms used in a document. The two questions, What is the real nature of the transaction referred to in a document? and, What is the meaning of a document? are often confused, but are really distinct from each other. The rules bearing on the latter question are rules of construction or interpretation rather than of evidence, but are ordinarily treated as part of the law of evidence, and are for that reason included by Fitz-James Stephen in his Digest. In stating these rules he adopts, with verbal modifications, the six propositions laid down by Vice-Chancellor Wigram in his *Examinations of the Rules of Law respecting the admission of Extrinsic Evidence in Aid of the Interpretation of Wills*. The substance of these propositions appears to be this, that wherever the meaning of a document cannot be satisfactorily ascertained from the document itself, use may be made of any other evidence for the purpose of elucidating the meaning, subject to one restriction, that, except in cases of equivocation, *i.e.* where a person or thing is described in terms applicable equally to more than one, resort cannot be had to extrinsic expressions of the author's intention.

V. WITNESSES

1. *Attendance*.—If a witness does not attend voluntarily he can be required to attend by a writ of *subpoena*.

2. *Competency*.—As a general rule every person is a competent witness. Formerly persons were disqualified by crime or interest, or by being parties to the proceedings, but these disqualifications have now been removed by statute, and the circumstances which formerly created them do not affect the competency, though they may often affect the credibility, of a witness.

Under the general law as it stood before the Criminal Evidence Act 1898 came into force, a person charged with an offence was not competent to give evidence on his own behalf. But many exceptions had been made to this rule by legislation, and the rule itself was finally abolished by the act of 1898. Under that law a person charged is a competent witness, but he can only give evidence for the defence, and can only give evidence if he himself applies to do so. Under the law as it stood before 1898, persons jointly charged and being tried together were not competent to give evidence either for or against each other. Under the act of 1898 a person charged jointly with another is a competent witness, but only for the defence, and not for the prosecution. If, therefore, one of the persons charged applies to give evidence his cross-examination must not be conducted with a view to establish the guilt of the other. Consequently, if it is thought

desirable to use against one prisoner the evidence of another who is being tried with him, the latter should be released, or a separate verdict of not guilty taken against him. A prisoner so giving evidence is popularly said to turn king's evidence. It follows that, subject to what has been said above as to persons tried together, the evidence of an accomplice is admissible against his principal, and *vice versa*. The evidence of an accomplice is, however, always received with great jealousy and caution. A conviction on the unsupported testimony of an accomplice may, in some cases, be strictly legal, but the practice is to require it to be confirmed by unimpeachable testimony in some material part, and more especially as to his identification of the person or persons against whom his evidence may be received. The wife of a person charged is now a competent witness, but, except in certain special cases, she can only give evidence for the defence, and can only give evidence if her husband applies that she should do so. The special cases in which a wife can be called as a witness either for the prosecution or for the defence, and without the consent of the person charged, are cases arising under particular enactments scheduled to the act of 1898, and relating mainly to offences against wives and children, and cases in which the wife is by common law a competent witness against her husband, *i.e.* where the proceeding is against the husband for bodily injury or violence inflicted on his wife. The rule of exclusion extends only to a lawful wife. There is no ground for supposing that the wife of a prosecutor is an incompetent witness. A witness is incompetent if, in the opinion of the court, he is prevented by extreme youth, disease affecting his mind, or any other cause of the same kind, from recollecting the matter on which he is to testify, from understanding the questions put to him, from giving rational answers to those questions, or from knowing that he ought to speak the truth. A witness unable to speak or hear is not incompetent, but may give his evidence by writing or by signs, or in any other manner in which he can make it intelligible. The particular form of the religious belief of a witness, or his want of religious belief, does not affect his competency. This ground of incompetency has now been finally removed by the Oaths Act 1888. It will be seen that the effect of the successive enactments which have gradually removed the disqualifications attaching to various classes of witnesses has been to draw a distinction between the *competency* of a witness and his *credibility*. No person is disqualified on moral or religious grounds, but his character may be such as to throw grave doubts on the value of his evidence. No relationship, except to a limited extent that of husband and wife, excludes from giving evidence. The parent may be examined on the trial of the child, the child on that of the parent, master for or against servant, and servant for or against master. The relationship of the witness to the prosecutor or the prisoner in such cases may affect the credibility of the witness, but does not exclude his evidence.

3. *Privilege*.—It does not follow that, because a person is *competent* to give evidence, he can therefore be compelled to do so.

No one, except a person charged with an offence when giving evidence on his own application, and as to the offence where-with he is charged, is bound to answer a question if the answer would, in the opinion of the court, have a tendency to expose the witness, or the wife or husband of the witness, to any criminal charge, penalty, or forfeiture, which the court regards as reasonably likely to be preferred or sued for. Accordingly, an accomplice cannot be examined without his consent, but if an accomplice who has come forward to give evidence on a promise of pardon, or favourable consideration, refuses to give full and fair information, he renders himself liable to be convicted on his own confession. However, even accomplices in such circumstances are not required to answer on their cross-examination as to other offences. Where, under the new law, a person charged with an offence offers himself as a witness, he may be asked any question in cross-examination, notwithstanding that it would tend to criminate him as to the offence charged. But he may not be asked, and if he is asked must not be required to answer, any question tending to show that he has committed, or been

convicted of, or been charged with, any other offence, or is of bad character, unless:—

- (i.) The proof that he has committed, or been convicted of, the other offence is admissible evidence to show that he is guilty of the offence with which he is then charged; or,
- (ii.) He has personally, or by his advocate, asked questions of the witnesses for the prosecution, with a view to establish his own good character, or has given evidence of his good character, or the nature or conduct of the defence is such as to involve imputations on the character of the prosecutor or the witnesses for the prosecution; or,
- (iii.) He has given evidence against any other person charged with the same offence.

He may not be asked questions tending to criminate his wife.

The privilege as to criminating answers does not cover answers merely tending to establish a civil liability. No one is excused from answering a question or producing a document only because the answer or document may establish or tend to establish that he owes a debt, or is otherwise liable to any civil proceeding. It is a privilege for the protection of the witness, and therefore may be waived by him. But there are other privileges which cannot be so waived. Thus, on grounds of public policy, no one can be compelled, or is allowed, to give evidence relating to any affairs of state, or as to official communications between public officers upon public affairs, except with the consent of the head of the department concerned, and this consent is refused if the production of the information asked for is considered detrimental to the public service.

Again, in cases in which the government is immediately concerned, no witness can be compelled to answer any question the answer to which would tend to discover the names of persons by or to whom information was given as to the commission of offences. It is, as a rule, for the court to decide whether the permission of any such question would or would not, under the circumstances of the particular case, be injurious to the administration of justice.

A husband is not compellable to disclose any communication made to him by his wife during the marriage; and a wife is not compellable to disclose any communication made to her by her husband during the marriage.

A legal adviser is not permitted, whether during or after the termination of his employment as such, unless with his client's express consent, to disclose any communication, oral or documentary, made to him *as such legal adviser*, by or on behalf of his client, during, in the course of, and for the purpose of his employment, or to disclose any advice given by him to his client during, in the course of, and for the purpose of such employment. But this protection does not extend to—

(a) Any such communication if made in furtherance of any criminal purpose; nor

(b) Any fact observed by a legal adviser in the course of his employment as such, showing that any crime or fraud has been committed since the commencement of his employment, whether his attention was directed to such fact by or on behalf of his client or not; nor

(c) Any fact with which the legal adviser became acquainted otherwise than in his character as such.

Medical men and clergymen are not privileged from the disclosure of communications made to them in professional confidence, but it is not usual to press for the disclosures of communications made to clergymen.

4. *Oaths*.—A witness must give his evidence under the sanction of an oath, or of what is equivalent to an oath, that is to say, of a solemn promise to speak the truth. The ordinary form of oath is adapted to Christians, but a person belonging to a non-Christian religion may be sworn in any form prescribed or recognized by the custom of his religion. (See the article OATH.)

5. *Publicity*.—The evidence of a witness at a trial must, as a general rule, be given in open court in the course of the trial. The secrecy which was such a characteristic feature of the "inquisition" procedure is abhorrent to English law, and, even where publicity conflicts with decency, English courts are very reluctant to dispense with or relax the safeguards for justice which publicity involves.

6. *Examination.*—The normal course of procedure is this. The party who begins, *i.e.* ordinarily the plaintiff or prosecutor, calls his witnesses in order. Each witness is first examined on behalf of the party for whom he is called. This is called the examination in chief. Then he is liable to be cross-examined on behalf of the other side. And, finally, he may be re-examined on behalf of his own side. After the case for the other side has been opened, the same procedure is adopted with the witnesses for that side. In some cases the party who began is allowed to adduce further evidence in reply to his opponent's evidence. The examination is conducted, not by the court, but by or on behalf of the contending parties. It will be seen that the principle underlying this procedure is that of the duel, or conflict between two contending parties, each relying on and using his own evidence, and trying to break down the evidence of his opponent. It differs from the principle of the "inquisition" procedure, in which the court takes a more active part, and in which the cases for the two sides are not so sharply distinguished. In a continental trial it is often difficult to determine whether the case for the prosecution or the case for the defence is proceeding. Conflicting witnesses stand up together and are "confronted" with each other. In the examination in chief questions must be confined to matters bearing on the main question at issue, and a witness must not be asked leading questions, *i.e.* questions suggesting the answer which the person putting the question wishes or expects to receive, or suggesting disputed facts about which the witness is to testify. But the rule about leading questions is not applied where the questions asked are simply introductory, and form no part of the real substance of the inquiry, or where they relate to matters which, though material, are not disputed. And if the witness called by a person appears to be directly hostile to him, or interested on the other side, or unwilling to reply, the reason for the rules applying to examination in chief breaks down, and the witness may be asked leading questions and cross-examined, and treated in every respect as though he was a witness called on the other side, except that a party producing a witness must not impeach his credit by general evidence of bad character (Evidence and Practice on Criminal Trials Act 1865). In cross-examination questions not bearing on the main issue and leading questions may be put and (subject to the rules as to privilege) must be answered, as the cross-examiner is entitled to test the examination in chief by every means in his power. Questions not bearing on the main issue are often asked in cross-examination merely for the purpose of putting off his guard a witness who is supposed to have learnt up his story. In cross-examination questions may also be asked which tend either to test the accuracy or credibility of the witness, or to shake his credit by impeaching his motives or injuring his character. The licence allowed in cross-examination has often been seriously abused, and the power of the court to check it is recognized by one of the rules of the supreme court (R.S.C. xxxvi. 39, added in 1883). It is considered wrong to put questions which assume that facts have been proved which have not been proved, or that answers have been given contrary to the fact. A witness ought not to be pressed in cross-examination as to any facts which, if admitted, would not affect the question at issue or the credibility of the witness. If the cross-examiner intends to adduce evidence contrary to the evidence given by the witness, he ought to put to the witness in cross-examination the substance of the evidence which he proposes to adduce, in order to give the witness an opportunity of retracting or explaining. Where a witness has answered a question which only tends to affect his credibility by injuring his character, it is only in a limited number of cases that evidence can be given to contradict his answer. Where he is asked whether he has ever been convicted of any felony or misdemeanour, and denies or refuses to answer, proof may be given of the truth of the facts suggested (28 & 29 Vict. c. 15, s. 6). The same rule is observed where he is asked a question tending to show that he is not impartial. Where a witness has previously made a statement inconsistent with his evidence, proof may be given that he did in fact make it. But before such proof is given the circumstances of the alleged

statement, sufficient to designate the particular occasion, must be mentioned to the witness, and he must be asked whether he did or did not make the statement. And if the statement was made in, or has been reduced to, writing, the attention of the witness must, before the writing is used against him, be called to those parts of the writing which are to be used for the purpose of contradicting him (Evidence and Practice on Criminal Trials Act 1865, ss. 4, 5). The credibility of a witness may be impeached by the evidence of persons who swear that they, from their knowledge of the witness, believe him to be unworthy of credit on his oath. These persons may not on their examination in chief give reasons for their belief, but they may be asked their reasons in cross-examination, and their answers cannot be contradicted. When the credit of a witness is so impeached, the party who called the witness may give evidence in reply to show that the witness is worthy of credit. Re-examination must be directed exclusively to the explanation of matters referred to in cross-examination, and if new matter is, by the permission of the court, introduced in re-examination, the other side may further cross-examine upon it. A witness under examination may refresh his memory by referring to any writing made by himself at or about the time of the occurrence to which the writing relates, or made by any other person, and read and found accurate by the witness at or about the time. An expert may refresh his memory by reference to professional treatises.

For the history of the English law of evidence, see Brunner, *Entstehung der Schwurgerichte*; Bigelow, *History of Procedure in England*; Stephen (Sir J. F.), *History of the Criminal Law of England*; Pollock and Maitland, *History of English Law*, bk. ii. ch. ix.; Thayer, *Preliminary Treatise on Evidence at the Common Law*. The principal text-books now in use are—Roscoe, *Digest of the Law of Evidence on the Trial of Actions at Nisi Prius* (18th ed., 1907); Roscoe, *Digest of the Law of Evidence in Criminal Cases* (13th ed., 1908); Taylor, *Treatise on the Law of Evidence* (10th ed., 1906); Best, *Principles of the Law of Evidence* (10th ed., 1906); Powell, *Principles and Practice of the Law of Evidence* (8th ed., 1904); Stephen, *Digest of the Law of Evidence* (8th ed., 1907); Wills, *Theory and Practice of the Law of Evidence* (1907). For the history of the law of criminal evidence in France, see Esmein, *Hist. de la procédure criminelle en France*. For Germany, see Holtzendorff, *Encyclopädie der Rechtswissenschaft* (passages indexed under head "Beweis"); Holtzendorff, *Rechtswörterbuch* ("Beweis"). (C. P. I.)

EVIL EYE. The terror of the arts of "fascination," *i.e.* that certain persons can bewitch, injure and even kill with a glance, has been and is still very widely spread. The power was not thought to be always maliciously cultivated. It was as often supposed to be involuntary (cf. Deuteronomy xxviii. 54); and a story is told of a Slav who, afflicted with the evil eye, at last blinded himself in order that he might not be the means of injuring his children (Woyciki, *Polish Folklore*, trans. by Lewenstein, p. 25). Few of the old classic writers fail to refer to the dread power. In Rome the "evil eye" was so well recognized that Pliny states that special laws were enacted against injury to crops by incantation, excantation or fascination. The power was styled *βασκανία* by the Greeks and *fascinatio* by the Latins. Children and young animals of all kinds were thought to be specially susceptible. Charms were worn against the evil eye both by man and beast, and in Judges viii. 21 it is thought there is a reference to this custom in the allusion to the "ornaments" on the necks of camels. In classic times the wearing of amulets was universal. They were of three classes: (1) those the intention of which was to attract on to themselves, as the lightning-rod the lightning, the malignant glance; (2) charms hidden in the bosom of the dress; (3) written words from sacred writings. Of these three types the first was most numerous. They were oftenest of a grotesque and generally grossly obscene nature. They were also made in the form of frogs, beetles and so on. But the ancients did not wholly rely on amulets. Spitting was among the Greeks and Romans a most common antidote to the poison of the evil eye. According to Theocritus it is necessary to spit three times into the breast of the person who fears fascination. Gestures, too, often intentionally obscene, were regarded as prophylactics on meeting the dreaded individual. The evil eye was believed to have its impulse in envy, and thus it came

to be regarded as unlucky to have any of your possessions praised. Among the Romans, therefore, it was customary when praising anything to add *Præfiscini dixerim* (Fain Evil! I should say). This custom survives in modern Italy, where in like circumstances is said *Si mal occhio non ci fosse* (May the evil eye not strike it). The object of these conventional phrases was to prove that the speaker was sincere and had no evil designs in his praise. Though there is no set formula, traces of the custom are found in English rural sayings, e.g. the Somersetshire "I don't wish ee no harm, so I on't zay no more." This is what the Scots call "fore-speaking," when praise beyond measure is likely to be followed by disease or accident. A Manxman will never say he is very well: he usually admits that he is "middling," or qualifies his admission of good health by adding "now" or "just now." The belief led in many countries to the saying, when one heard anybody or anything praised superabundantly, "God preserve him or it." So in Ireland, to avoid being suspected of having the evil eye, it is advisable when looking at a child to say "God bless it"; and when passing a farm-yard where cows are collected at milking time it is usual for the peasant to say, "The blessing of God be on you and all your labour." Bacon writes: "It seems some have been so curious as to note that the times when the stroke . . . of an envious eye does most hurt are particularly when the party envied is beheld in glory and triumph."

The powers of the evil eye seem indeed to have been most feared by the prosperous. Its powers are often quoted as almost limitless. Thus one record solemnly declares that in a town of Africa a fascinator called Elzanar killed by his evil art no less than 80 people in two years (W. W. Story, *Castle St Angelo*, 1877, p. 149). The belief as affecting cattle was universal in the Scottish Highlands as late as the 18th century and still lingers. Thus if a stranger looks admiringly on a cow the peasants still think she will waste away, and they offer the visitor some of her milk to drink in the belief that in this manner the spell is broken. The modern Turks and Arabs also think that their horses and camels are subject to the evil eye. But the people of Italy, especially the Neapolitans, are the best modern instances of implicit believers. The *jettatore*, as the owner of the evil eye is called, is so feared that at his approach it is scarcely an exaggeration to say that a street will clear: everybody will rush into doorways or up alleys to avoid the dreaded glance. The *jettatore di bambini* (fascinator of children) is the most dreaded of all. The evil eye is still much feared for horses in India, China, Turkey, Greece and almost everywhere where horses are found. In rural England the pig is of all animals oftenest "overlooked." While the Italians are perhaps the greatest believers in the evil eye as affecting persons, the superstition is rife in the East. In India the belief is universal. In Bombay the blast of the evil eye is supposed to be a form of spirit-possession. In western India all witches and wizards are said to be evil-eyed. Modern Egyptian mothers thus account for the sickly appearance of their babies. In Turkey passages from the Koran are painted on the outside of houses to save the inmates, and texts as amulets are worn upon the person, or hung upon camels and horses by Arabs, Abyssinians and other peoples. The superstition is universal among savage races.

For a full discussion see *Evil Eye* by F. T. Elworthy (London, 1895); also W. W. Story, *Castle St Angelo and the Evil Eye* (1877); E. N. Rolfe and H. Ingleby, *Naples in 1888* (1888); Johannes Christian Frommann, *Tractatus de fascinatione novus et singularis*, &c., &c. (Nuremberg, 1675); R. C. Maclagan, *Evil Eye in the Western Highlands* (1902).

EVOLUTION. The modern doctrine of evolution or "evolving," as opposed to that of simple creation, has been defined by Prof. James Sully in the 9th edition of this encyclopaedia as a "natural history of the cosmos including organic beings, expressed in physical terms as a mechanical process." The following exposition of the historical development of the doctrine is taken from Sully's article, and for the most part is in his own words.

In the modern doctrine of evolution the cosmic system appears as a natural product of elementary matter and its laws. The various grades of life on our planet are the natural consequences

of certain physical processes involved in the gradual transformations of the earth. Conscious life is viewed as conditioned by physical (organic and more especially nervous) processes, and as evolving itself in close correlation with organic evolution. Finally, human development, as exhibited in historical and pre-historical records, is regarded as the highest and most complex result of organic and physical evolution. This modern doctrine of evolution is but an expansion and completion of those physical theories (see below) which opened the history of speculation. It differs from them in being grounded on exact and verified research. As such, moreover, it is a much more limited theory of evolution than the ancient. It does not necessarily concern itself about the question of the infinitude of worlds in space and in time. It is content to explain the origin and course of development of the world, the solar or, at most, the sidereal system which falls under our own observation. It would be difficult to say what branches of science had done most towards the establishment of this doctrine. We must content ourselves by referring to the progress of physical (including chemical) theory, which has led to the great generalization of the conservation of energy; to the discovery of the fundamental chemical identity of the matter of our planet and of other celestial bodies, and of the chemical relations of organic and inorganic bodies; to the advance of astronomical speculation respecting the origin of the solar system, &c.; to the growth of the science of geology which has necessitated the conception of vast and unimaginable periods of time in the past history of our globe, and to the rapid march of the biological sciences which has made us familiar with the simplest types and elements of organism; finally, to the development of the science of anthropology (including comparative psychology, philology, &c.), and to the vast extension and improvement of all branches of historical study.

History of the Idea of Evolution.—The doctrine of evolution in its finished and definite form is a modern product. It required for its formation an amount of scientific knowledge which could only be very gradually acquired. It is vain, therefore, to look for clearly defined and systematic presentations of the idea among ancient writers. On the other hand, nearly all systems of philosophy have discussed the underlying problems. Such questions as the origin of the cosmos as a whole, the production of organic beings and of conscious minds, and the meaning of the observable grades of creation, have from the dawn of speculation occupied men's minds; and the answers to these questions often imply a vague recognition of the idea of a gradual evolution of things. Accordingly, in tracing the antecedents of the modern philosophic doctrine we shall have to glance at most of the principal systems of cosmology, ancient and modern. Yet since in these systems inquiries into the *esse* and *fieri* of the world are rarely distinguished with any precision, it will be necessary to indicate very briefly the general outlines of the system so far as they are necessary for understanding their bearing on the problems of evolution.

Mythological Interpretation.—The problem of the origin of the world was the first to engage man's speculative activity. Nor was this line of inquiry pursued simply as a step in the more practical problem of man's final destiny. The order of ideas observable in children suggests the reflection that man began to discuss the "whence" of existence before the "whither." At first, as in the case of the child, the problem of the genesis of things was conceived anthropomorphically: the question "How did the world arise?" first shaped itself to the human mind under the form "Who made the world?" As long as the problem was conceived in this simple manner there was, of course, no room for the idea of a necessary self-conditioned evolution. Yet the first indistinct germ of such an idea appears to emerge in combination with that of creation in some of the ancient systems of theogony. Thus, for example, in the myth of the ancient Parsees, the gods Ormuzd and Ahriman are said to evolve themselves out of a primordial matter. It may be supposed that these crude fancies embody a dim recognition of the physical forces and objects personified under the forms of deities, and a rude attempt to account for their genesis as a natural

process. These first unscientific ideas of a genesis of the permanent objects of nature took as their pattern the process of organic reproduction and development, and this, not only because these objects were regarded as personalities, but also because this particular mode of becoming would most impress these early observers. This same way of looking at the origin of the material world is illustrated in the Egyptian notion of a cosmic egg out of which issues the god (Phtha) who creates the world.

Indian Philosophy.—Passing from mythology to speculation properly so called, we find in the early systems of philosophy of India theories of emanation which approach in some respects the idea of evolution. Brahma is conceived as the eternal self-existent being, which on its material side unfolds itself to the world by gradually condensing itself to material objects through the gradations of ether, fire, water, earth and the elements. At the same time this eternal being is conceived as the all-embracing world-soul from which emanates the hierarchy of individual souls. In the later system of emanation of Sankhya there is a more marked approach to a materialistic doctrine of evolution. If, we are told, we follow the chain of causes far enough back we reach unlimited eternal creative nature or matter. Out of this "principal thing" or "original nature" all material and spiritual existence issues, and into it will return. Yet this primordial creative nature is endowed with volition with regard to its own development. Its first emanation as plastic nature contains the original soul or deity out of which all individual souls issue.

Early Greek Physicists.—Passing by Buddhism, which, though teaching the periodic destruction of our world by fire, &c., does not seek to determine the ultimate origin of the cosmos, we come to those early Greek physical philosophers who distinctly set themselves to eliminate the idea of divine interference with the world by representing its origin and changes as a natural process. The early Ionian physicists, including Thales, Anaximander and Anaximenes, seek to explain the world as generated out of a primordial matter (Gr. ὕλη; hence the name "Hylozoists"), which is at the same time the universal support of things. This substance is endowed with a generative or transmutative force by virtue of which it passes into a succession of forms. They thus resemble modern evolutionists, since they regard the world with its infinite variety of forms as issuing from a simple mode of matter. More especially the cosmology of Anaximander resembles the modern doctrine of evolution in its conception of the indeterminate (τὸ ἀπειρον) out of which the particular forms of the cosmos are differentiated. Again, Anaximander may be said to prepare the way for more modern conceptions of material evolution by regarding his primordial substance as eternal, and by looking on all generation as alternating with destruction, each step of the process being of course simply a transformation of the indestructible substance. Once more, the notion that this indeterminate body contains potentially in itself the fundamental contraries—hot, cold, &c.—by the excretion or evolution of which definite substances were generated, is clearly a forecasting of that antithesis of potentiality and actuality which from Aristotle downwards has been made the basis of so many theories of development. In conclusion, it is noteworthy that though resorting to utterly fanciful hypotheses respecting the order of the development of the world, Anaximander agrees with modern evolutionists in conceiving the heavenly bodies as arising out of an aggregation of diffused matter, and in assigning to organic life an origin in the inorganic materials of the primitive earth (pristine mud). The doctrine of Anaximenes, who unites the conceptions of a determinate and indeterminate original substance adopted by Thales and Anaximander in the hypothesis of a primordial and all-generating air, is a clear advance on these theories, inasmuch as it introduces the scientific idea of condensation and rarefaction as the great generating or transforming agencies. For the rest, his theory is chiefly important as emphasizing the vital character of the original substance. The primordial air is conceived as animated. Anaximenes seems to have inclined to a view of cosmic evolution as throughout

involving a quasi-spiritual factor. This idea of the air as the original principle and source of life and intelligence is much more clearly expressed by a later writer, Diogenes of Apollonia. Diogenes made this conception of a vital and intelligent air the ground of a teleological view of climatic and atmospheric phenomena. It is noteworthy that he sought to establish the identity of organic and inorganic matter by help of the facts of vegetal and animal nutrition. Diogenes distinctly taught that the world is of finite duration, and will be renewed out of the primitive substance.

Heraclitus again deserves a prominent place in a history of the idea of evolution. Heraclitus conceives of the incessant process of flux in which all things are involved as consisting of two sides or moments—generation and decay—which are regarded as a confluence of opposite streams. In thus making transition or change, viewed as the identity of existence and non-existence, the leading idea of his system, Heraclitus anticipated in some measure Hegel's peculiar doctrine of evolution as a dialectic process.¹ At the same time we may find expressed in figurative language the germs of thoughts which enter into still newer doctrines of evolution. For example, the notion of conflict (πόλεμος) as the father of all things and of harmony as arising out of a union of discords, and again of an endeavour by individual things to maintain themselves in permanence against the universal process of destruction and renovation, cannot but remind one of certain fundamental ideas in Darwin's theory of evolution.

Empedocles.—Empedocles took an important step in the direction of modern conceptions of physical evolution by teaching that all things arise, not by transformations of some primitive form of matter, but by various combinations of a number of permanent elements. Further, by maintaining that the elements are continually being combined and separated by the two forces love and hatred, which appear to represent in a figurative way the physical forces of attraction and repulsion, Empedocles may be said to have made a considerable advance in the construction of the idea of evolution as a strictly mechanical process. It may be observed, too, that the hypothesis of a primitive compact mass (*sphaerus*), in which love (attraction) is supreme, has some curious points of similarity to, and contrast with, that notion of a primitive nebulous matter with which the modern doctrine of cosmic evolution usually sets out. Empedocles tries to explain the genesis of organic beings, and, according to Lange, anticipates the idea of Darwin that adaptations abound, because it is their nature to perpetuate themselves. He further recognizes a progress in the production of vegetable and animal forms, though this part of his theory is essentially crude and unscientific. More important in relation to the modern problems of evolution is his thoroughly materialistic way of explaining the origin of sensation and knowledge by help of his peculiar hypothesis of effluvia and pores. The supposition that sensation thus rests on a material process of absorption from external bodies naturally led up to the idea that plants and even inorganic substances are precipient, and so to an indistinct recognition of organic life as a scale of intelligence.

Atomists.—In the theory of Atomism taught by Leucippus and Democritus we have the basis of the modern mechanical conceptions of cosmic evolution. Here the endless harmonious diversity of our cosmos, as well as of other worlds supposed to coexist with our own, is said to arise through the various combination of indivisible material elements differing in figure and magnitude only. The force which brings the atoms together in the forms of objects is inherent in the elements, and all their motions are necessary. The origin of things, which is also their substance, is thus laid in the simplest and most homogeneous elements or principles. The real world thus arising consists only of diverse combinations of atoms, having the properties of magnitude, figure, weight and hardness, all other qualities being relative only to the sentient organism. The problem of the genesis of mind is practically solved by identifying the soul,

¹ This is brought out by F. Lassalle, *Die Philosophie Herakleitos*, p. 126.

or vital principle, with heat or fire which pervades in unequal proportions, not only man and animals, but plants and nature as a whole, and through the agitation of which by incoming effluvia all sensation arises.

Aristotle.—Aristotle is much nearer a conception of evolution than his master Plato. It is true he sets out with a transcendent Deity, and follows Plato in viewing the creation of the cosmos as a process of descent from the more to the less perfect according to the distance from the original self-moving agency. Yet on the whole Aristotle leans to a teleological theory of evolution, which he interprets dualistically by means of certain metaphysical distinctions. Thus even his idea of the relation of the divine activity to the world shows a tendency to a pantheistic notion of a divine thought which gradually realizes itself in the process of becoming. Aristotle's distinction of form and matter, and his conception of becoming as a transition from actuality to potentiality, provides a new ontological way of conceiving the process of material and organic evolution.¹ To Aristotle the whole of nature is instinct with a vital impulse towards some higher manifestation. Organic life presents itself to him as a progressive scale of complexity determined by its final end, namely, man.² In some respects Aristotle approaches the modern view of evolution. Thus, though he looked on species as fixed, being the realization of an unchanging formative principle (*φύσις*), he seems, as Ueberweg observes, to have inclined to entertain the possibility of a spontaneous generation in the case of the lowest organisms. Aristotle's teleological conception of organic evolution often approaches modern mechanical conceptions. Thus he says that nature fashions organs in the order of their necessity, the first being those essential to life. So, too, in his psychology he speaks of the several degrees of mind as arising according to a progressive necessity.³ In his view of touch and taste, as the two fundamental and essential senses, he may remind one of Herbert Spencer's doctrine. At the same time Aristotle precludes the idea of a natural development of the mental series by the supposition that man contains, over and above a natural finite soul inseparable from the body, a substantial and eternal principle (*νοῦς*) which enters into the individual from without. Aristotle's brief suggestions respecting the origin of society and governments in the *Politics* show a leaning to a naturalistic interpretation of human history as a development conditioned by growing necessities.

Strato.—Of Aristotle's immediate successors one deserves to be noticed here, namely, Strato of Lampsacus, who developed his master's cosmology into a system of naturalism. Strato appears to reject Aristotle's idea of an original source of movement and life extraneous to the world in favour of an immanent principle. All parts of matter have an inward plastic life whereby they can fashion themselves to the best advantage, according to their capability, though not with consciousness.

The Stoics.—In the cosmology of the Stoics we have the germ of a monistic and pantheistic conception of evolution. All things are said to be developed out of an original being, which is at once material (fire) and spiritual (the Deity), and in turn they will dissolve back into this primordial source. At the same time the world as a developed whole is regarded as an organism which is permeated with the divine Spirit, and so we may say that the world-process is a self-realization of the divine Being. The formative principle or force of the world is said to contain the several rational germinal forms of things. Individual things are supposed to arise out of the original being, as animals and plants out of seeds. Individual souls are an efflux from the all-compassing world-soul. The necessity in the world's order is regarded by the Stoics as identical with the divine reason, and this idea is used as the basis of a teleological and optimistic view of nature. Very curious, in relation to modern evolutionary ideas, is the Stoical doctrine that our world is but one of a series of exactly

identical ones, all of which are destined to be burnt up and destroyed.

The Epicureans—Lucretius.—The Epicureans differed from the Stoics by adopting a purely mechanical view of the world-process. Their fundamental conception is that of Democritus; they seek to account for the formation of the cosmos, with its order and regularity, by setting out with the idea of an original (vertical) motion of the atoms, which somehow or other results in movements towards and from one another. Our world is but one of an infinite number of others, and all the harmonies and adaptations of the universe are regarded as a special case of the infinite possibilities of mechanical events. Lucretius regards the primitive atoms (first beginnings or first bodies) as seeds out of which individual things are developed. All living and sentient things are formed out of insentient atoms (*e.g.* worms spring out of dung). The peculiarity of organic and sentient bodies is due to the minuteness and shape of their particles, and to their special motions and combinations. So, too, mind consists but of extremely fine particles of matter, and dissolves into air when the body dies. Lucretius traces, in the fifth book of his poem, the progressive genesis of vegetal and animal forms out of the mother-earth. He vaguely anticipates the modern idea of the world as a survival of the fittest when he says that many races may have lived and died out, and that those which still exist have been protected either by craft, courage or speed. Lucretius touches on the development of man out of a primitive, hardy, beast-like condition. Pregnant hints are given respecting a natural development of language which has its germs in sounds of quadrupeds and birds, of religious ideas out of dreams and waking hallucinations, and of the art of music by help of the suggestion of natural sounds. Lucretius thus recognizes the whole range of existence to which the doctrine of evolution may be applied.

Neoplatonists.—In the doctrines of the Neoplatonists, of whom Plotinus is the most important, we have the world-process represented after the example of Plato as a series of descending steps, each being less perfect than its predecessors, since it is further removed from the first cause.⁴ The system of Plotinus, Zeller remarks, is not strictly speaking one of emanation, since there is no communication of the divine essence to the created world; yet it resembles emanation inasmuch as the genesis of the world is conceived as a necessary physical effect, and not as the result of volition. In Proclus we find this conception of an emanation of the world out of the Deity, or the absolute, made more exact, the process being regarded as threefold—(1) persistence of cause in effect, (2) the departure of effect from cause, and (3) the tendency of effect to revert to its cause.

The Fathers.—The speculations of the fathers respecting the origin and course of the world seek to combine Christian ideas of the Deity with doctrines of Greek philosophy. The common idea of the origin of things is that of an absolute creation of matter and mind alike. The course of human history is regarded by those writers who are most concerned to refute Judaism as a progressive divine education. Among the Gnostics we meet with the hypothesis of emanation, as, for example, in the curious cosmic theory of Valentinus.

Middle Ages—Early Schoolmen.—In the speculative writings of the middle ages, including those of the schoolmen, we find no progress towards a more accurate and scientific view of nature. The cosmology of this period consists for the most part of the Aristotelian teleological view of nature combined with the Christian idea of the Deity and His relation to the world. In certain writers, however, there appears a more elaborate transformation of the doctrine of creation into a system of emanation. According to John Scotus Erigena, the nothing out of which the world is created is the divine essence. Creation is the act by which God passes through the primordial causes, or universal ideas, into the region of particular things (*processio*), in order finally to return to himself (*reversio*). The transition from the

⁴ Zeller observes that this scale of decreasing perfection is a necessary consequence of the idea of a transcendent deity.

¹ Zeller says that through this distinction Aristotle first made possible the idea of development.

² See this well brought out in G. H. Lewes's *Aristotle*, p. 187.

³ Grote calls attention to the contrast between Plato's and Aristotle's way of conceiving the gradations of mind (*Aristotle*, ii. 171).

universal to the particular is of course conceived as a descent or degradation. A similar doctrine of emanation is to be found in the writings of Bernhard of Chartres, who conceives the process of the unfolding of the world as a movement in a circle from the most general to the individual, and from this back to the most general. This movement is said to go forth from God to the animated heaven, stars, visible world and man, which represent decreasing degrees of cognition.

Arab Philosophers.—Elaborate doctrines of emanation, largely based on Neoplatonic ideas, are also propounded by some of the Arabic philosophers, as by Fārābī and Avicenna. The leading thought is that of a descending series of intelligences, each emanating from its predecessor, and having its appropriate region in the universe.

Jewish Philosophy.—In the Jewish speculations of the middle ages may be found curious forms of the doctrine of emanations uniting the Biblical idea of creation with elements drawn from the Persians and the Greeks. In the later and developed form of the Kabbala, the origin of the world is represented as a gradually descending emanation of the lower out of the higher. Among the philosophic Jews, the Spanish Avicbron, in his *Fons Vitae*, expounds a curious doctrine of emanation. Here the divine will is viewed as an efflux from the divine wisdom, as the intermediate link between God, the first substance, and all things, and as the fountain out of which all forms emanate. At the same time all forms, including the higher intelligible ones, are said to have their existence only in matter. Matter is the one universal substance, body and mind being merely specifications of this. Thus Avicbron approaches, as Salomon Munk observes,¹ a pantheistic conception of the world, though he distinctly denies both matter and form to God.

Later Scholastics.—Passing now to the later schoolmen, a bare mention must be made of Thomas Aquinas, who elaborately argues for the absolute creation of the world out of nothing, and of Albertus Magnus, who reasons against the Aristotelian idea of the past eternity of the world. More importance attaches to Duns Scotus, who brings prominently forward the idea of a progressive development in nature by means of a process of determination. The original substance of the world is the *materia primo-prima*, which is the immediate creation of the Deity. This serves Duns Scotus as the most universal basis of existence, all angels having material bodies. This matter is differentiated into particular things (which are not privations but perfections) through the addition of an individualizing principle (*haecceitas*) to the universal (*quidditas*). The whole world is represented by the figure of a tree, of which the seeds and roots are the first indeterminate matter, the leaves the accidents, the twigs and branches corruptible creatures, the blossoms the rational soul, and the fruit pure spirits or angels. It is also described as a bifurcation of two twigs, mental and bodily creation out of a common root. One might almost say that Duns Scotus recognizes the principle of a gradual physical evolution, only that he chooses to represent the mechanism by which the process is brought about by means of quaint scholastic fictions.

Revival of Learning.—The period of the revival of learning, which was also that of a renewed study of nature, is marked by a considerable amount of speculation respecting the origin of the universe. In some of these we see a return to Greek theories, though the influence of physical discoveries, more especially those of Copernicus, Kepler and Galileo, is distinctly traceable.

Telesio.—An example of a return to early Greek speculation is to be met with in Bernardino Telesio. By this writer the world is explained as a product of three principles—dead matter, and two active forces, heat and cold. Terrestrial things arise through a confluence of heat, which issues from the heavens, and cold, which comes from the earth. Both principles have sensibility, and thus all products of their collision are sentient, that is, feel pleasure and pain. The superiority of animals to plants and metals in the possession of special organs of sense is connected with the greater complexity and heterogeneity of their structure.

¹ *Mélanges de philosophie juive et arabe*, p. 225.

Giordano Bruno.—In the system of Giordano Bruno, who sought to construct a philosophy of nature on the basis of new scientific ideas, more particularly the doctrine of Copernicus, we find the outlines of a theory of cosmic evolution conceived as an essentially vital process. Matter and form are here identified, and the evolution of the world is presented as the unfolding of the world-spirit to its perfect forms according to the plastic substratum (matter) which is but one of its sides. This process of change is conceived as a transformation, in appearance only, of the real unchanging substance (matter and form). All parts of matter are capable of developing into all forms; thus the materials of the table and chair may under proper circumstances be developed to the life of the plant or of the animal. The elementary parts of existence are the *minima*, or monads, which are at once material and mental. On their material side they are not absolutely unextended, but spherical. Bruno looked on our solar system as but one out of an infinite number of worlds. His theory of evolution is essentially pantheistic, and he does not employ his hypothesis of monads in order to work out a more mechanical conception.

Campanella.—A word must be given to one of Bruno's contemporary compatriots, namely Campanella, who gave poetic expression to that system of universal vitalism which Bruno developed. He argues, from the principle *quicquid est in effectibus esse et in causis*, that the elements and the whole world have sensation, and thus he appears to derive the organic part of nature out of the so-called "inorganic."

Boehme.—Another writer of this transition period deserves a passing reference here, namely, Jacob Boehme the mystic, who by his conception of a process of inner diremption as the essential character of all mind, and so of God, prepared the way for later German theories of the origin of the world as the self-differentiation and self-externalization of the absolute spirit.

Hobbes and Gassendi.—The influence of an advancing study of nature, which was stimulated if not guided by Bacon's writings, is seen in the more careful doctrines of materialism worked out almost simultaneously by Hobbes and Gassendi. These theories, however, contain little that bears directly on the hypothesis of a natural evolution of things. In the view of Hobbes, the difficulty of the genesis of conscious minds is solved by saying that sensation and thought are part of the reaction of the organism on external movement. Yet Hobbes appears (as Clarke points out) to have vaguely felt the difficulty; and in a passage of his *Physics* (chap. 25, sect. 5) he says that the universal existence of sensation in matter cannot be disproved, though he shows that when there are no organic arrangements the mental side of the movement (*phantasma*) is evanescent. The theory of the origin of society put forth by Hobbes, though directly opposed in most respects to modern ideas of social evolution, deserves mention here by reason of its enforcing that principle of struggle (*bellum omnium contra omnes*) which has played so conspicuous a part in the modern doctrine of evolution. Gassendi, with some deviations, follows Epicurus in his theory of the formation of the world. The world consists of a finite number of atoms, which have in their own nature a self-moving force or principle. These atoms, which are the seeds of all things, are, however, not eternal but created by God. Gassendi distinctly argues against the existence of a world-soul or a principle of life in nature.

Descartes.—In the philosophy of Descartes we meet with a dualism of mind and matter which does not easily lend itself to the conception of evolution. His doctrine that consciousness is confined to man, the lower animals being unconscious machines (*automata*), excludes all idea of a progressive development of mind. Yet Descartes, in his *Principia Philosophiae*, laid the foundation of the modern mechanical conception of nature and of physical evolution. In the third part of this work he inclines to a thoroughly natural hypothesis respecting the genesis of the physical world, and adds in the fourth part that the same kind of explanation might be applied to the nature and formation of plants and animals. He is indeed careful to keep right with

the orthodox doctrine of creation by saying that he does not believe the world actually arose in this mechanical way out of the three kinds of elements which he here supposes, but that he simply puts out his hypothesis as a mode of conceiving how it might have arisen. Descartes's account of the mind and its passions is thoroughly materialistic, and to this extent he works in the direction of a materialistic explanation of the origin of mental life.

Spinoza.—In Spinoza's pantheistic theory of the world, which regards thought and extension as but two sides of one substance, the problem of becoming is submerged in that of being. Although Spinoza's theory attributes a mental side to all physical events, he rejects all teleological conceptions and explains the order of things as the result of an inherent necessity. He recognizes gradations of things according to the degree of complexity of their movements and that of their conceptions. To Spinoza (as Kuno Fischer observes) man differs from the rest of nature in the degree only and not in the kind of his powers. So far Spinoza approaches the conception of evolution. He may be said to furnish a further contribution to a metaphysical conception of evolution in his view of all finite individual things as the infinite variety to which the unlimited productive power of the universal substance gives birth. Sir F. Pollock has taken pains to show how nearly Spinoza approaches certain ideas contained in the modern doctrine of evolution, as for example that of self-preservation as the determining force in things.

Locke.—In Locke we find, with a retention of certain anti-evolutionist ideas, a marked tendency to this mode of viewing the world. To Locke the universe is the result of a direct act of creation, even matter being limited in duration and created. Even if matter were eternal it would, he thinks, be incapable of producing motion; and if motion is itself conceived as eternal, thought can never begin to be. The first eternal being is thus spiritual or "cogitative," and contains in itself all the perfections that can ever after exist. He repeatedly insists on the impossibility of senseless matter putting on sense.¹ Yet while thus placing himself at a point of view opposed to that of a gradual evolution of the organic world, Locke prepared the way for this doctrine in more ways than one. First of all, his genetic method as applied to the mind's ideas—which laid the foundations of English analytical psychology—was a step in the direction of a conception of mental life as a gradual evolution. Again he works towards the same end in his celebrated refutation of the scholastic theory of real specific essences. In this argument he emphasizes the vagueness of the boundaries which mark off organic species with a view to show that these do not correspond to absolutely fixed divisions in the objective world, that they are made by the mind, not by nature.² This idea of the continuity of species is developed more fully in a remarkable passage (*Essay*, bk. iii. ch. vi. § 12), where he is arguing in favour of the hypothesis, afterwards elaborated by Leibnitz, of a graduated series of minds (species of spirits) from the Deity down to the lowest animal intelligence. He here observes that "all quite down from us the descent is by easy steps, and a continued series of things, that in each remove differ very little from one another." Thus man approaches the beasts, and the animal kingdom is nearly joined with the vegetable, and so on down to the lowest and "most inorganic parts of matter." Finally, it is to be observed that Locke had a singularly clear view of organic arrangements (which of course he explained according to a theistic teleology) as an adaptation to the circumstances of the environment or to "the neighbourhood of the bodies that surround us." Thus he suggests that man has not eyes of a microscopic delicacy, because he would receive no great advantage from such acute organs, since though adding indefinitely to his speculative knowledge of the physical world they would

¹ Yet he leaves open the question whether the Deity has annexed thought to matter as a faculty, or whether it rests on a distinct spiritual principle.

² Locke half playfully touches on certain monsters, with respect to which it is difficult to determine whether they ought to be called men. (*Essay*, book iii. ch. vi. sect. 26, 27.)

not practically benefit their possessor (e.g. by enabling him to avoid things at a convenient distance).³

Idea of Progress in History.—Before leaving the 17th century we must just refer to the writers who laid the foundations of the essentially modern conception of human history as a gradual upward progress. According to Flint,⁴ there were four men who in this and the preceding century seized and made prominent this idea, namely, Bodin, Bacon, Descartes and Pascal. The former distinctly argues against the idea of a deterioration of man in the past. In this way we see that just as advancing natural science was preparing the way for a doctrine of physical evolution, so advancing historical research was leading to the application of a similar idea to the collective human life.

English Writers of the 18th Century—Hume.—The theological discussions which make up so large a part of the English speculation of the 18th century cannot detain us here. There is, however, one writer who sets forth so clearly the alternative suppositions respecting the origin of the world that he claims a brief notice. We refer to David Hume. In his *Dialogues concerning Natural Religion* he puts forward tentatively, in the person of one of his interlocutors, the ancient hypothesis that since the world resembles an animal or vegetal organism rather than a machine, it might more easily be accounted for by a process of generation than by an act of creation. Later on he develops the materialistic view of Epicurus, only modifying it so far as to conceive of matter as finite. Since a finite number of particles is only susceptible of finite transpositions, it must happen (he says), in an eternal duration that every possible order or position will be tried an infinite number of times, and hence this world is to be regarded (as the Stoics maintained) as an exact reproduction of previous worlds. The speaker seeks to make intelligible the appearance of art and contrivance in the world as a result of a natural settlement of the universe (which passes through a succession of chaotic conditions) into a stable condition, having a constancy in its forms, yet without its several parts losing their motion and fluctuation.

French Writers of the 18th Century.—Let us now pass to the French writers of the 18th century. Here we are first struck by the results of advancing physical speculation in their bearing on the conception of the world. Careful attempts, based on new scientific truths, are made to explain the genesis of the world as a natural process. Maupertuis, who, together with Voltaire, introduced the new idea of the universe as based on Newton's discoveries, sought to account for the origin of organic things by the hypothesis of sentient atoms. Buffon the naturalist speculated, not only on the structure and genesis of organic beings, but also on the course of formation of the earth and solar system, which he conceived after the analogy of the development of organic beings out of seed. Diderot, too, in his varied intellectual activity, found time to speculate on the genesis of sensation and thought out of a combination of matter endowed with an elementary kind of sentience. De la Mettrie worked out a materialistic doctrine of the origin of things, according to which sensation and consciousness are nothing but a development out of matter. He sought (*L'Homme-machine*) to connect man in his original condition with the lower animals, and emphasized (*L'Homme-plante*) the essential unity of plan of all living things. Helvétius, in his work on man, referred all differences between our species and the lower animals to certain peculiarities of organization, and so prepared the way for a conception of human development out of lower forms as a process of physical evolution. Charles Bonnet met the difficulty of the origin of conscious beings much in the same way as Leibnitz, by the supposition of eternal minute organic bodies to which are attached immortal souls. Yet though in this way opposing himself to the method of the modern doctrine of evolution, he aided the development of this doctrine by his view of the organic world as an ascending

³ A similar coincidence between the teleological and the modern evolutionary way of viewing things is to be met with in Locke's account of the use of pain in relation to the preservation of our being (bk. ii. ch. vii. sect. 4).

⁴ *Philosophy of History* (1893), p. 103, where an interesting sketch of the growth of the idea of progress is to be found.

scale from the simple to the complex. Robinet, in his treatise *De la nature*, worked out the same conception of a gradation in organic existence, connecting this with a general view of nature as a progress from the lowest inorganic forms of matter up to man. The process is conceived as an infinite series of variations or specifications of one primitive and common type. Man is the *chef-d'œuvre* of nature, which the gradual progression of beings was to have as its last term, and all lower creations are regarded as pre-conditions of man's existence, since nature "could only realize the human form by combining in all imaginable ways each of the traits which was to enter into it." The formative force in this process of evolution (or "metamorphosis") is conceived as an intellectual principle (*idée génératrice*). Robinet thus laid the foundation of that view of the world as wholly vital, and as a progressive unfolding of a spiritual formative principle, which was afterwards worked out by Schelling. It is to be added that Robinet adopted a thorough-going materialistic view of the dependence of mind on body, going even to the length of assigning special nerve-fibres to the moral sense. The system of Holbach seeks to provide a consistent materialistic view of the world and its processes. Mental operations are identified with physical movements, the three conditions of physical movement, inertia, attraction and repulsion, being in the moral world self-love, love and hate. He left open the question whether the capability of sensation belongs to all matter, or is confined to the combinations of certain materials. He looked on the actions of the individual organism and of society as determined by the needs of self-preservation. He conceived of man as a product of nature that had gradually developed itself from a low condition, though he relinquished the problem of the exact mode of his first genesis and advance as not soluble by data of experience. Holbach thus worked out the basis of a rigorously materialistic conception of evolution.

The question of human development which Holbach touched on was one which occupied many minds both in and out of France during the 18th century, and more especially towards its close. The foundations of this theory of history as an upward progress of man out of a barbaric and animal condition were laid by Vico in his celebrated work *Principii di scienza nuova*. In France the doctrine was represented by Turgot and Condorcet.

German Writers of the 18th Century—Leibnitz.—In Leibnitz we find, if not a doctrine of evolution in the strict sense, a theory of the world which is curiously related to the modern doctrine. The chief aim of Leibnitz is no doubt to account for the world in its static aspect as a co-existent whole, to conceive the ultimate reality of things in such a way as to solve the mystery of mind and matter. Yet by his very mode of solving the problem he is led on to consider the nature of the world-process. By placing substantial reality in an infinite number of monads whose essential nature is force or activity, which is conceived as mental (representation), Leibnitz was carried on to the explanation of the successive order of the world. He prepares the way, too, for a doctrine of evolution by his monistic idea of the substantial similarity of all things, inorganic and organic, bodily and spiritual, and still more by his conception of a perfect gradation of existence from the lowest "inanimate" objects, whose essential activity is confused representation, up to the highest organized being—man—with his clear intelligence.¹ Turning now to Leibnitz's conception of the world as a process, we see first that he supplies, in his notion of the underlying reality as force which is represented as spiritual (*quelque chose d'analogique au sentiment et à l'appétit*), both a mechanical and a teleological explanation of its order. More than this, Leibnitz supposes that the activity of the monads takes the form of a self-evolution. It is the following out of an inherent tendency or impulse to a series of changes, all of which were virtually pre-existent, and this process cannot be interfered with from without. As the individual monad, so the whole system which makes up the world is a gradual

development. In this case, however, we cannot say that each step goes out of the other as in that of individual development. Each monad is an original independent being, and is determined to take this particular point in the universe, this place in the scale of beings. We see how different this metaphysical conception is from that scientific notion of cosmic evolution in which the lower stages are the antecedents and conditions of the higher. It is probable that Leibnitz's notion of time and space, which approaches Kant's theory, led him to attach but little importance to the successive order of the world. Leibnitz, in fact, presents to us an infinite system of perfectly distinct though parallel developments, which on their mental side assume the aspect of a scale, not through any mutual action, but solely through the determination of the Deity. Even this idea, however, is incomplete, for Leibnitz fails to explain the physical aspect of development. Thus he does not account for the fact that organic beings—which have always existed as preformations (in the case of animals as *animaux spermatisques*)—come to be developed under given conditions. Yet Leibnitz prepared the way for a new conception of organic evolution. The modern monistic doctrine, that all material things consist of sentient elements, and that consciousness arises through a combination of these, was a natural transformation of Leibnitz's theory.²

Lessing.—Of Leibnitz's immediate followers we may mention Lessing, who in his *Education of the Human Race* brought out the truth of the process of gradual development underlying human history, even though he expressed this in a form inconsistent with the idea of a spontaneous evolution.

Herder.—Herder, on the other hand, Lessing's contemporary, treated the subject of man's development in a thoroughly naturalistic spirit. In his *Ideen zur Philosophie der Geschichte*, Herder adopts Leibnitz's idea of a graduated scale of beings, at the same time conceiving of the lower stages as the conditions of the higher. Thus man is said to be the highest product of nature, and as such to be dependent on all lower products. All material things are assimilated to one another as organic, the vitalizing principle being inherent in all matter. The development of man is explained in connexion with that of the earth, and in relation to climatic variations, &c. Man's mental faculties are viewed as related to his organization, and as developed under the pressure of the necessities of life.³

Kant.—Kant's relation to the doctrine of evolution is a many-sided one. In the first place, his peculiar system of subjective idealism, involving the idea that time is but a mental form to which there corresponds nothing in the sphere of noumenal reality, serves to give a peculiar philosophical interpretation to every doctrine of cosmic evolution. Kant, like Leibnitz, seeks to reconcile the mechanical and teleological views of nature, only he assigns to these different spheres. The order of the inorganic world is explained by properly physical causes. In his *Naturgeschichte des Himmels*, in which he anticipated the nebular theory afterwards more fully developed by Laplace, Kant sought to explain the genesis of the cosmos as a product of physical forces and laws. The worlds, or systems of worlds, which fill infinite space are continually being formed and destroyed. Chaos passes by a process of evolution into a cosmos, and this again into chaos. So far as the evolution of the solar system is concerned, Kant held these mechanical causes as adequate. For the world as a whole, however, he postulated a beginning in time (whence his use of the word creation), and further supposed that the impulse of organization which was conveyed to chaotic matter by the Creator issued from a central point in the infinite space spreading gradually outwards.⁴ While

¹ Both Lewes and du Bois Reymond have brought out the points of contact between Leibnitz's theory of monads and modern biological speculations (*Hist. of Phil.* ii. 287, and *Leibnizsche Gedanken in der modernen Naturwissenschaft*, p. 23 seq.).

² For Herder's position in relation to the modern doctrine of evolution see F. von Bärenbach's *Herder als Vorgänger Darwins*, a work which tends to exaggerate the proximity of the two writers.

³ Kant held it probable that other planets besides our earth are inhabited, and that their inhabitants form a scale of beings, their perfection increasing with the distance of the planet which they inhabit from the sun.

¹ G. H. Lewes points out that Leibnitz is inconsistent in his account of the intelligence of man in relation to that of lower animals, since when answering Locke he no longer regards these as differing in degree only.

in his cosmology Kant thus relies on mechanical conceptions, in his treatment of organic life his mind is, on the contrary, dominated by teleological ideas. An organism was to him something controlled by a formative organizing principle. It was natural, therefore, that he rejected the idea of a spontaneous generation of organisms (which was just then being advocated by his friend Forster), not only as unsupported by experience but as an inadequate hypothesis. Experience forbids our excluding organic activity from natural causes, also our excluding intelligence from purposeful (*zweckmäßigen*) causes; hence experience forbids our defining the fundamental force or first cause out of which living creatures arose.¹ Just as Kant thus sharply marks off the regions of the inorganic and the organic, so he sets man in strong opposition to the lower animals. His ascription to man of a unique faculty, free-will, forbade his conceiving our species as a link in a graduated series of organic developments. In his doctrine of human development he does indeed recognize an early stage of existence in which our species was dominated by sensuous enjoyment and instinct. He further conceives of this stage as itself a process of (natural) development, namely, of the natural disposition of the species to vary in the greatest possible manner so as to preserve its unity through a process of self-adaptation (*Anarten*) to climate. This, he says, must not be conceived as resulting from the action of external causes, but is due to a natural disposition (*Anlage*). From this capability of natural development (which already involves a teleological idea) Kant distinguishes the power of moral self-development or self-liberation from the dominion of nature, the gradual realization of which constitutes human history or progress. This moral development is regarded as a gradual approach to that rational, social and political state in which will be realized the greatest possible quantity of liberty. Thus Kant, though he appropriated and gave new form to the idea of human progress, conceived of this as wholly distinct from a natural (mechanical) process. In this particular, as in his view of organic actions, Kant distinctly opposed the idea of evolution as one universal process swaying alike the physical and the moral world.

Schelling.—In the earlier writings of Schelling, containing the philosophy of identity, existence is represented as a becoming, or process of evolution. Nature and mind (which are the two sides, or polar directions, of the one absolute) are each viewed as an activity advancing by an uninterrupted succession of stages. The side of this process which Schelling worked out most completely is the negative side, that is, nature. Nature is essentially a process of organic self-evolution. It can only be understood by subordinating the mechanical conception to the vital, by conceiving the world as one organism animated by a spiritual principle or intelligence (*Weltseele*). From this point of view the processes of nature from the inorganic up to the most complex of the organic become stages in the self-realization of nature. All organic forms are at bottom but one organization, and the inorganic world shows the same formative activity in various degrees or potences. Schelling conceives of the gradual self-evolution of nature in a succession of higher and higher forms as brought about by a limitation of her infinite productivity, showing itself in a series of points of arrest. The detailed exhibition of the organizing activity of nature in the several processes of the organic and inorganic world rests on a number of fanciful and unscientific ideas. Schelling's theory is a bold attempt to revitalize nature in the light of growing physical and physiological science, and by so doing to comprehend the unity of the world under the idea of one principle of organic development. His highly figurative language might leave us in doubt how far he conceived the higher stages of this evolution of nature as following the lower in time. In the introduction to his work *Von der Weltseele*, however, he argues in favour of the possibility of a transmutation of species in periods incommensurable with ours. The evolution of mind (the positive pole) proceeds by

¹ Kant calls the doctrine of the transmutation of species "a hazardous fancy of the reason." Yet, as Strauss and others have shown, Kant's mind betrayed a decided leaning at times to a more mechanical conception of organic forms as related by descent.

way of three stages—theoretic, practical and aesthetical activity. Schelling's later theosophic speculations do not specially concern us here.

Followers of Schelling.—Of the followers of Schelling a word or two must be said. Heinrich Steffens, in his *Anthropologie*, seeks to trace out the origin and history of man in connexion with a general theory of the development of the earth, and this again as related to the formation of the solar system. All these processes are regarded as a series of manifestations of a vital principle in higher and higher forms. Oken, again, who carries Schelling's ideas into the region of biological science, seeks to reconstruct the gradual evolution of the material world out of original matter, which is the first immediate appearance of God, or the absolute. This process is an upward one, through the formation of the solar system and of our earth with its inorganic bodies, up to the production of man. The process is essentially a polar linear action, or differentiation from a common centre. By means of this process the bodies of the solar system separate themselves, and the order of cosmic evolution is repeated in that of terrestrial evolution. The organic world (like the world as a whole) arises out of a primitive chaos, namely, the infusorial slime. A somewhat similar working out of Schelling's idea is to be found in H. C. Oersted's work entitled *The Soul in Nature* (Eng. trans.). Of later works based on Schelling's doctrine of evolution mention may be made of the volume entitled *Natur und Idee*, by G. F. Carus. According to this writer, existence is nothing but a becoming, and matter is simply the momentary product of the process of becoming, while force is this process constantly revealing itself in these products.

Hegel.—Like Schelling, Hegel conceives the problem of existence as one of becoming. He differs from him with respect to the ultimate motive of that process of gradual evolution which reveals itself alike in nature and in mind. With Hegel the absolute is itself a dialectic process which contains within itself a principle of progress from difference to difference and from unity to unity. "This process (W. Wallace remarks) knows nothing of the distinctions between past and future, because it implies an eternal present." This conception of an immanent spontaneous evolution is applied alike both to nature and to mind and history. Nature to Hegel is the idea in the form of heterogeneity; and finding itself here it has to remove this exteriority in a progressive evolution towards an existence for itself in life and mind. Nature (says Zeller) is to Hegel a system of gradations, of which one arises necessarily out of the other, and is the proximate truth of that out of which it results. There are three stadia, or moments, in this process of nature—(1) the mechanical moment, or matter devoid of individuality; (2) the physical moment, or matter which has particularized itself in bodies—the solar system; and (3) the organic moment, or organic beings, beginning with the geological organism—or the mineral kingdom, plants and animals. Yet this process of development is not to be conceived as if one stage is naturally produced out of the other, and not even as if the one followed the other in time. Only spirit has a history; in nature all forms are contemporaneous.² Hegel's interpretation of mind and history as a process of evolution has more scientific interest than his conception of nature. His theory of the development of free-will (the objective spirit), which takes its start from Kant's conception of history, with its three stages of legal right, morality as determined by motive and instinctive goodness (*Sittlichkeit*), might almost as well be expressed in terms of a thoroughly naturalistic doctrine of human development. So, too, some of his conceptions respecting the development of art and religion (the absolute spirit) lend themselves to a similar interpretation. Yet while, in its application to history, Hegel's theory of evolution has points of resemblance with those doctrines which seek to explain the world-process as one unbroken progress occurring in time, it constitutes on the whole a theory apart and *sui generis*. It does not conceive of the organic as succeeding on the inorganic, or of conscious life

² Hegel somewhere says that the question of the eternal duration of the world is unanswerable: time as well as space can be predicated of finitudes only.

as conditioned in time by lower forms. In this respect it resembles Leibnitz's idea of the world as a development; the idea of evolution is in each case a metaphysical as distinguished from a scientific one. Hegel gives a place in his metaphysical system to the mechanical and the teleological views; yet in his treatment of the world as an evolution the idea of end or purpose is the predominant one.

Of the followers of Hegel who have worked out his peculiar idea of evolution it is hardly necessary to speak. A bare reference may be made to J. K. F. Rosenkranz, who in his work *Hegel's Naturphilosophie* seeks to develop Hegel's idea of an earth-organism in the light of modern science, recognizing in crystallization the morphological element.

Schopenhauer.—Of the other German philosophers immediately following Kant, there is only one who calls for notice here, namely, Arthur Schopenhauer. This writer, by his conception of the world as will which objectifies itself in a series of gradations from the lowest manifestations of matter up to conscious man, gives a slightly new shape to the evolutionary view of Schelling, though he deprives this view of its optimistic character by denying any co-operation of intelligence in the world-process. In truth, Schopenhauer's conception of the world as the activity of a blind force is at bottom a materialistic and mechanical rather than a spiritualistic and teleological theory. Moreover, Schopenhauer's subjective idealism, and his view of time as something illusory, hindered him from viewing this process as a sequence of events in time. Thus he ascribes eternity of existence to species under the form of the "Platonic ideas." As Ludwig Noiré observes, Schopenhauer has no feeling for the problem of the origin of organic beings. He says Lamarck's original animal is something metaphysical, not physical, namely, the will to live. "Every species (according to Schopenhauer) has of its own will, and according to the circumstances under which it would live, determined its form and organization,—yet not as something physical in time, but as something metaphysical out of time."

Von Baer.—Before leaving the German speculation of the first half of the century, a word must be said of von Baer, to whose biological contributions we shall refer later in this article, who recognized in the law of development the law of the universe as a whole. In his *Entwicklungsgeschichte der Thiere* (p. 264) he distinctly tells us that the law of growing individuality is "the fundamental thought which goes through all forms and degrees of animal development and all single relations. It is the same thought which collected in the cosmic space the divided masses into spheres, and combined these to solar systems; the same which caused the weather-beaten dust on the surface of our metallic planet to spring forth into living forms." Von Baer thus prepared the way for Herbert Spencer's generalization of the law of organic evolution as the law of all evolution.

Comte.—As we arrive at the 19th century, though yet before the days of Darwin, biology is already beginning to affect the general aspect of thought. It might suffice to single out the influence of Auguste Comte, as the last great thinker who wrote before Darwinism began to permeate philosophic speculation. Though Comte did not actually contribute to a theory of cosmic organic evolution, he helped to lay the foundations of a scientific conception of human history as a natural process of development determined by general laws of human nature together with the accumulating influences of the past. Comte does not recognize that this process is aided by any increase of innate capacity; on the contrary, progress is to him the unfolding of fundamental faculties of human nature which always pre-existed in a latent condition; yet he may perhaps be said to have prepared the way for the new conception of human progress by his inclusion of mental laws under biology.

Development of the Biological Doctrine.—In the 19th century the doctrine of evolution received new biological contents and became transformed from a vague, partly metaphysical theory to the dominant modern conception. At this point it is convenient to leave the guidance of Professor J. Sully and to follow closely T. H. Huxley, who in the 9th edition of this encyclopaedia

traced the history of the growth of the biological idea of evolution from its philosophical beginnings to its efflorescence in Charles Darwin.

In the earlier half of the 18th century the term "evolution" was introduced into biological writings in order to denote the mode in which some of the most eminent physiologists of that time conceived that the generation of living things took place; in opposition to the hypothesis advocated, in the preceding century, by W. Harvey in that remarkable work¹ which would give him a claim to rank among the founders of biological science, even had he not been the discoverer of the circulation of the blood.

One of Harvey's prime objects is to defend and establish, on the basis of direct observation, the opinion already held by Aristotle, that, in the higher animals at any rate, the formation of the new organism by the process of generation takes place, not suddenly, by simultaneous accretion of rudiments of all or the most important of the organs of the adult, nor by sudden metamorphosis of a formative substance into a miniature of the whole, which subsequently grows, but by *epigenesis*, or successive differentiation of a relatively homogeneous rudiment into the parts and structures which are characteristic of the adult.

"Et primo, quidem, quoniam per *epigenesin* sive partium superexorientium additamentum pullum fabricari certum est: quoniam pars ante alias omnes extruatur, et quid de illa ejusque generandi modo observandum veniat, dispiciemus. Ratum sane est et in ovo manifeste apparet quod *Aristoteles* de perfectorum animalium generatione enuntiat: nimirum, non omnes partes simul fieri, sed ordine aliam post aliam; primumque existere particulam genitalem, cujus virtute postea (tanquam ex principio quodam) reliquae omnes partes prosiliant. Qualem in plantarum seminibus (fabis, puta, aut glandibus) gemmam sive apicem protuberantem cernimus, totius futurae arboris principium. *Estque haec particula velut filius emancipatae seorsumque collocatus, et principium per se vivens; unde postea membrorum ordo describitur; et quaecumque ad absolvendum animal pertinent, disponuntur.*² Quoniam enim nulla pars se ipsam generat; sed postquam generata est, se ipsam jam auget; ideo eam primum oriri necesse est, quae principium augendi contineat (sive enim planta, sive animal est, aequae omnibus inest quod vim habeat vegetandi, sive nutriendi),³ simulque reliquas omnes partes suo quamque ordine distinguat et formet; proindeque in eadem primogenita particula anima primario inest, sensus, motusque, et totius vitae auctor et principium." (*Exercitatio 51.*)

Harvey proceeds to contrast this view with that of the "Medici," or followers of Hippocrates and Galen, who, "badly philosophizing," imagined that the brain, the heart, and the liver were simultaneously first generated in the form of vesicles; and, at the same time, while expressing his agreement with Aristotle in the principle of epigenesis, he maintains that it is the blood which is the primal generative part, and not, as Aristotle thought, the heart.

In the latter part of the 17th century the doctrine of epigenesis thus advocated by Harvey was controverted on the ground of direct observation by M. Malpighi, who affirmed that the body of the chick is to be seen in the egg before the *punctum sanguineum* makes its appearance. But from this perfectly correct observation a conclusion which is by no means warranted was drawn, namely, that the chick as a whole really exists in the egg antecedently to incubation; and that what happens in the course of the latter process is no addition of new parts, "alias post alias natas," as Harvey puts it, but a simple expansion or unfolding of the organs which already exist, though they are too small and inconspicuous to be discovered. The weight of Malpighi's observations therefore fell into the scale of that doctrine which Harvey terms metamorphosis, in contradistinction to epigenesis.

The views of Malpighi were warmly welcomed on philosophical grounds by Leibnitz,⁴ who found in them a support to his

¹ The *Exercitationes de generatione animalium*, which Dr George Ent extracted from him and published in 1651.

² *De generatione animalium*, lib. ii. cap. x.

³ *De generatione animalium*, lib. ii. cap. iv.

⁴ "Cependant, pour revenir aux formes ordinaires ou aux âmes matérielles, cette durée qu'il leur faut attribuer, à la place de celle qu'on avoit attribuée aux atomes pourroit faire douter si elles ne vont pas de corps en corps; ce qui seroit la mététempychose, à peu près comme quelques philosophes ont cru la transmission du mouvement

hypothesis of monads, and by Nicholas Malebranche;¹ while, in the middle of the 18th century, not only speculative considerations, but a great number of new and interesting observations on the phenomena of generation, led the ingenious Charles Bonnet and A. von Haller, the first physiologist of the age, to adopt, advocate and extend them.

Bonnet affirms that, before fecundation, the hen's egg contains an excessively minute but complete chick; and that fecundation and incubation simply cause this germ to absorb nutritious matters, which are deposited in the interstices of the elementary structures of which the miniature chick, or germ, is made up. The consequence of this intussusceptive growth is the "development" or "evolution" of the germ into the visible bird. Thus an organized individual (*tout organisé*) "is a composite body consisting of the original, or elementary, parts and of the matters which have been associated with them by the aid of nutrition"; so that, if these matters could be extracted from the individual (*tout*), it would, so to speak, become concentrated in a point, and would thus be restored to its primitive condition of a germ; "just as, by extracting from a bone the calcareous substance which is the source of its hardness, it is reduced to its primitive state of gristle or membrane."²

"Evolution" and "development" are, for Bonnet, synonymous terms; and since by "evolution" he means simply the expansion of that which was invisible into visibility, he was naturally led to the conclusion, at which Leibnitz had arrived by a different line of reasoning, that no such thing as generation, in the proper sense of the word exists in nature. The growth of an organic being is simply a process of enlargement, as a particle of dry gelatine may be swelled up by the intussusception of water; its death is a shrinkage, such as the swelled jelly might undergo on desiccation. Nothing really new is produced in the living world, but the germs which develop have existed since the beginning of things; and nothing really dies, but, when what we call death takes place, the living thing shrinks back into its germ state.³

et celle des espèces. Mais cette imagination est bien éloignée de la nature des choses. Il n'y a point de tel passage; et c'est ici où les transformations de Messieurs Swammerdam, Malpighi, et Leewenhoek, qui sont des plus excellents observateurs de notre tems, sont venues à mon secours et m'ont fait admettre plus aisément, que l'animal, et toute autre substance organisée ne commence point lorsque nous le croyons, et que sa génération apparente n'est qu'un développement et une espèce d'augmentation. Aussi ai-je remarqué que l'auteur de la *Recherche de la vérité*, M. Regis, M. Hartsoeker, et d'autres habiles hommes n'ont pas été fort éloignés de ce sentiment." Leibnitz, *Système nouveau de la nature* (1695). The doctrine of "Emboîtement" is contained in the *Considérations sur le principe de vie* (1705); the preface to the *Théodicée* (1710); and the *Principes de la nature et de la grâce* (§ 6) (1718).

¹ "Il est vrai que la pensée la plus raisonnable et la plus conforme à l'expérience sur cette question très difficile de la formation du fœtus; c'est que les enfans sont déjà presque tout formés avant même l'action par laquelle ils sont conçus; et que leurs mères ne font que leur donner l'accroissement ordinaire dans le temps de la grossesse." *De la recherche de la vérité*, livre ii. chap. vii. p. 334 (7th ed., 1721).

² *Considérations sur les corps organisés*, chap. x.

³ Bonnet had the courage of his opinions, and in the *Palingénésie philosophique*, part vi. chap. iv., he develops a hypothesis which he terms "évolution naturelle"; and which, making allowance for his peculiar views of the nature of generation, bears no small resemblance to what is understood by "evolution" at the present day:—

"Si la volonté divine a créé par un seul Acte l'Universalité des êtres, d'où venoient ces plantes et ces animaux dont Moïse nous décrit la Production au troisième et au cinquième jour du renouvellement de notre monde?"

"Abuserois-je de la liberté de conjectures si je disois, que les Plantes et les Animaux qui existent aujourd'hui sont parvenus par une sorte d'évolution naturelle des Êtres organisés qui peuplaient ce premier Monde, sorti immédiatement des MAINS du CRÉATEUR? . . .

"Ne supposons que trois révolutions. La Terre vient de sortir des MAINS du CRÉATEUR. Des causes préparées par sa SAGESSE font développer de toutes parts les Germes. Les Êtres organisés commencent à jouir de l'existence. Ils étoient probablement alors bien différens de ce qu'ils sont aujourd'hui. Ils étoient autant que ce premier Monde différoit de celui que nous habitons. Nous manquons de moyens pour juger de ces dissemblances, et peut-être que le plus habile Naturaliste qui auroit été placé dans ce premier Monde y auroit entièrement méconnu nos Plantes et nos Animaux."

The two parts of Bonnet's hypothesis, namely, the doctrine that all living things proceed from pre-existing germs, and that these contain, one enclosed within the other, the germs of all future living things, which is the hypothesis of "emboîtement," and the doctrine that every germ contains in miniature all the organs of the adult, which is the hypothesis of evolution or development, in the primary senses of these words, must be carefully distinguished. In fact, while holding firmly by the former, Bonnet more or less modified the latter in his later writings, and, at length, he admits that a "germ" need not be an actual miniature of the organism, but that it may be merely an "original preformation" capable of producing the latter.⁴

But, thus defined, the germ is neither more nor less than the "particula genitalis" of Aristotle, or the "primordium vegetale" or "ovum" of Harvey; and the "evolution" of such a germ would not be distinguishable from "epigenesis."

Supported by the great authority of Haller, the doctrine of evolution, or development, prevailed throughout the whole of the 18th century, and Cuvier appears to have substantially adopted Bonnet's later views, though probably he would not have gone all lengths in the direction of "emboîtement." In a well-known note to Charles Léopold Laurillard's *Éloge*, prefixed to the last edition of the *Ossemens fossiles*, the "radical de l'être" is much the same thing as Aristotle's "particula genitalis" and Harvey's "ovum."⁵

Bonnet's eminent contemporary, Buffon, held nearly the same views with respect to the nature of the germ, and expresses them even more confidently.

"Ceux qui ont cru que le cœur étoit le premier formé, se sont trompés; ceux qui disent que c'est le sang se trompent aussi; tout est formé en même temps. Si l'on ne consulte que l'observation, le poulet se voit dans l'œuf avant qu'il ait été couvé."⁶

"J'ai ouvert une grande quantité d'œufs à différens temps avant et après l'incubation, et je me suis convaincu par mes yeux que le poulet existe en entier dans le milieu de la cicatrice au moment qu'il sort du corps de la poule."⁷

The "moule intérieur" of Buffon is the aggregate of elementary parts which constitute the individual, and is thus the equivalent of Bonnet's germ,⁸ as defined in the passage cited above. But Buffon further imagined that innumerable "molécules organiques" are dispersed throughout the world, and that alimentation consists in the appropriation by the parts of an organism of those molecules which are analogous to them. Growth, therefore, was, on this hypothesis, partly a process of simple evolution, and partly of what has been termed syngensis. Buffon's opinion is, in fact, a sort of combination of views, essentially similar to those of Bonnet, with others, somewhat similar to those of the "Medici" whom Harvey condemns. The "molécules organiques" are physical equivalents of Leibnitz's "monads."

It is a striking example of the difficulty of getting people to use their own powers of investigation accurately, that this form of the doctrine of evolution should have held its ground so long; for it was thoroughly and completely exploded, not long after its enunciation, by Caspar Frederick Wolff, who in his *Theoria generationis*, published in 1759, placed the opposite theory of epigenesis upon the secure foundation of fact, from which it has never been displaced. But Wolff had no immediate

⁴ "Ce mot (germe) ne désignera pas seulement un corps organisé réduit en petit; il désignera encore toute espèce de préformation originelle dont un Tout organique peut résulter comme de son principe immédiat."—*Palingénésie philosophique*, part. x. chap. ii.

⁵ "M. Cuvier considérant que tous les êtres organisés sont dérivés de parens, et ne voyant dans la nature aucune force capable de produire l'organisation, croyait à la pré-existence des germes; non pas à la pré-existence d'un être tout formé, puisqu'il est bien évident que ce n'est que par des développemens successifs que l'être acquiert sa forme; mais, si l'on peut s'exprimer ainsi, à la pré-existence du radical de l'être, radical qui existe avant que la série des évolutions ne commence, et qui remonte certainement, suivant la belle observation de Bonnet, à plusieurs générations."—Laurillard, *Éloge de Cuvier*, note 12.

⁶ *Histoire naturelle*, tom. ii. ed. ii. (1750), p. 350.

⁷ *Ibid.* p. 351.

⁸ See particularly Buffon, *l.c.* p. 41.

successors. The school of Cuvier was lamentably deficient in embryologists; and it was only in the course of the first thirty years of the 19th century that Prévost and Dumas in France, and, later on, Döllinger, Pander, von Bär, Rathke, and Remak in Germany, founded modern embryology; and, at the same time, proved the utter incompatibility of the hypothesis of evolution as formulated by Bonnet and Haller with easily demonstrable facts.

Nevertheless, though the conceptions originally denoted by "evolution" and "development" were shown to be untenable, the words retained their application to the process by which the embryos of living beings gradually make their appearance; and the terms "development," "Entwicklung," and "evolutio" are now indiscriminately used for the series of genetic changes exhibited by living beings, by writers who would emphatically deny that "development" or "Entwicklung" or "evolutio," in the sense in which these words were usually employed by Bonnet or Haller, ever occurs.

Evolution, or development, is, in fact, at present employed in biology as a general name for the history of the steps by which any living being has acquired the morphological and the physiological characters which distinguish it. As civil history may be divided into biography, which is the history of individuals, and universal history, which is the history of the human race, so evolution falls naturally into two categories—the evolution of the individual (see EMBRYOLOGY) and the evolution of the sum of living beings.

The Evolution of the Sum of Living Beings.—The notion that all the kinds of animals and plants may have come into existence by the growth and modification of primordial germs is as old as speculative thought; but the modern scientific form of the doctrine can be traced historically to the influence of several converging lines of philosophical speculation and of physical observation, none of which go further back than the 17th century. These are:—

1. The enunciation by Descartes of the conception that the physical universe, whether living or not living, is a mechanism, and that, as such, it is explicable on physical principles.

2. The observation of the gradations of structure, from extreme simplicity to very great complexity, presented by living things, and of the relation of these graduated forms to one another.

3. The observation of the existence of an analogy between the series of gradations presented by the species which compose any great group of animals or plants, and the series of embryonic conditions of the highest members of that group.

4. The observation that large groups of species of widely different habits present the same fundamental plan of structure; and that parts of the same animal or plant, the functions of which are very different, likewise exhibit modifications of a common plan.

5. The observation of the existence of structures, in a rudimentary and apparently useless condition, in one species of a group, which are fully developed and have definite functions in other species of the same group.

6. The observation of the effects of varying conditions in modifying living organisms.

7. The observation of the facts of geographical distribution.

8. The observation of the facts of the geological succession of the forms of life.

1. Notwithstanding the elaborate disguise which fear of the powers that were led Descartes to throw over his real opinions, it is impossible to read the *Principes de la philosophie* without acquiring the conviction that this great philosopher held that the physical world and all things in it, whether living or not living, have originated by a process of evolution, due to the continuous operation of purely physical causes, out of a primitive relatively formless matter.¹

¹ As Buffon has well said:—"L'idée de ramener l'explication de tous les phénomènes à des principes mécaniques est assurément grande et belle, ce pas est le plus hardi qu'on peut faire en philosophie, et c'est Descartes qui l'a fait."—*l.c.* p. 50.

The following passage is especially instructive:—

"Et tant s'en faut que je veuille que l'on croie toutes les choses que j'écrirai, que même je prétends en proposer ici quelques-unes que je crois absolument être fausses; à savoir, je ne doute point que le monde n'ait été créé au commencement avec autant de perfection qu'il en a; en sorte que le soleil, la terre, la lune, et les étoiles ont été dès lors; et que la terre n'a pas eu seulement en soi les semences des plantes, mais que les plantes même en ont couvert une partie; et qu'Adam et Ève n'ont pas été créés enfans mais en âge d'hommes parfaits. La religion chrétienne veut que nous le croyons ainsi, et la raison naturelle nous persuade entièrement cette vérité; car si nous considérons la toute puissance de Dieu, nous devons juger que tout ce qu'il a fait a eu dès le commencement toute la perfection qu'il devoit avoir. Mais néanmoins, comme on connoitroit beaucoup mieux quelle a été la nature d'Adam et celle des arbres de Paradis si on avoit examiné comment les enfans se forment peu à peu dans le ventre de leurs mères et comment les plantes sortent de leurs semences, que si on avoit seulement considéré quels ils ont été quand Dieu les a créés: tout de même, nous ferons mieux entendre quelle est généralement la nature de toutes les choses qui sont au monde si nous pouvons imaginer quelques principes qui soient fort intelligibles et fort simples, desquels nous puissions voir clairement que les astres et la terre et enfin tout ce monde visible auroit pu être produit ainsi que de quelques semences (bien que nous sachions qu'il n'a pas été produit en cette façon) que si nous la décrivions seulement comme il est, ou bien comme nous croyons qu'il a été créé. Et parceque je pense avoir trouvé des principes qui sont tels, je tâcherai ici de les expliquer."²

If we read between the lines of this singular exhibition of force of one kind and weakness of another, it is clear that Descartes believed that he had divined the mode in which the physical universe had been evolved; and the *Traité de l'homme* and the essay *Sur les passions* afford abundant additional evidence that he sought for, and thought he had found, an explanation of the phenomena of physical life by deduction from purely physical laws.

Spinoza abounds in the same sense, and is as usual perfectly candid—

"Naturae leges et regulae, secundum quas omnia fiunt et ex unis formis in alias mutantur, sunt ubique et semper eadem."³

Leibnitz's doctrine of continuity necessarily led him in the same direction; and, of the infinite multitude of monads with which he peopled the world, each is supposed to be the focus of an endless process of evolution and involution. In the *Protogaea*, xxvi., Leibnitz distinctly suggests the mutability of species—

"Alii mirantur in saxis passim species videri quas vel in orbe cognito, vel saltem in vicinis locis frustra quaeras. Ita *Cornua Ammonis*, quae ex nautilorum numero habeantur, passim et forma et magnitudine (nam et pedali diametro aliquando reperiuntur) ab omnibus illis naturis discrepare dicunt, quas praebet mare. Sed quis absconditos ejus recessus aut subterraneas abyssos pervestigavit? quam multa nobis animalia antea ignota offert novus orbis? Et credibile est per magnas illas conversiones etiam animalium species plurimum immutatas."

Thus in the end of the 17th century the seed was sown which has at intervals brought forth recurrent crops of evolutionary hypotheses, based, more or less completely, on general reasonings.

Among the earliest of these speculations is that put forward by Benoit de Maillet in his *Telliamed*, which, though printed in 1735, was not published until twenty-three years later. Considering that this book was written before the time of Haller, or Bonnet, or Linnaeus, or Hutton, it surely deserves more respectful consideration than it usually receives. For De Maillet not only has a definite conception of the plasticity of living things, and of the production of existing species by the modification of their predecessors, but he clearly apprehends the cardinal maxim of modern geological science, that the explanation of the structure of the globe is to be sought in the deductive application to geological phenomena of the principles established inductively by the study of the present course of nature. Somewhat later, P. L. M. de Maupertuis⁴ suggested a curious hypothesis as to the causes of variation, which he thinks may be sufficient to account for the origin of all animals

² *Principes de la philosophie*, Troisième partie, § 45.

³ *Ethices*, Pars tertia, Praefatio.

⁴ *Système de la Nature. Essai sur la formation des corps organisés*, 1751, xiv.

from a single pair. Jean Baptiste René Robinet¹ followed out much the same line of thought as De Maillet, but less soberly; and Bonnet's speculations in the *Palingénésie*, which appeared in 1769, have already been mentioned. Buffon (1753-1778), at first a partisan of the absolute immutability of species, subsequently appears to have believed that larger or smaller groups of species have been produced by the modification of a primitive stock; but he contributed nothing to the general doctrine of evolution.

Erasmus Darwin (*Zoonomia*, 1794), though a zealous evolutionist, can hardly be said to have made any real advance on his predecessors; and, notwithstanding the fact that Goethe had the advantage of a wide knowledge of morphological facts, and a true insight into their signification, while he threw all the power of a great poet into the expression of his conceptions, it may be questioned whether he supplied the doctrine of evolution with a firmer scientific basis than it already possessed. Moreover, whatever the value of Goethe's labours in that field, they were not published before 1820, long after evolutionism had taken a new departure from the works of Treviranus and Lamarck—the first of its advocates who were equipped for their task with the needful large and accurate knowledge of the phenomena of life as a whole. It is remarkable that each of these writers seems to have been led, independently and contemporaneously, to invent the same name of "biology" for the science of the phenomena of life; and thus, following Buffon, to have recognized the essential unity of these phenomena, and their contradistinction from those of inanimate nature. And it is hard to say whether Lamarck or Treviranus has the priority in propounding the main thesis of the doctrine of evolution; for though the first volume of Treviranus's *Biologie* appeared only in 1802, he says, in the preface to his later work, the *Erscheinungen und Gesetze des organischen Lebens*, dated 1831, that he wrote the first volume of the *Biologie* "nearly five-and-thirty years ago," or about 1796.

Now, in 1794, there is evidence that Lamarck held doctrines which present a striking contrast to those which are to be found in the *Philosophie zoologique*, as the following passages show:—

"685. Quoique mon unique objet dans cet article n'ait été que de traiter de la cause physique de l'entretien de la vie des êtres organiques, malgré cela j'ai osé avancer en débutant, que l'existence de ces êtres étonnants n'appartiennent nullement à la nature; que tout ce qu'on peut entendre par le mot *nature*, ne pouvoit donner la vie, c'est-à-dire, que toutes les qualités de la matière, jointes à toutes les circonstances possibles, et même à l'activité répandue dans l'univers, ne pouvaient point produire un être muni du mouvement organique, capable de reproduire son semblable, et sujet à la mort.

"686. Tous les individus de cette nature, qui existent, proviennent d'individus semblables qui tous ensemble constituent l'espèce entière. Or, je crois qu'il est aussi impossible à l'homme de connaître la cause physique du premier individu de chaque espèce, que d'assigner aussi physiquement la cause de l'existence de la matière ou de l'univers entier. C'est au moins ce que le résultat de mes connaissances et de mes réflexions me portent à penser. S'il existe beaucoup de variétés produites par l'effet des circonstances, ces variétés ne dénaturant point les espèces; mais on se trompe, sans doute souvent, en indiquant comme espèce, ce qui n'est que variété; et alors je sens que cette erreur peut tirer à conséquence dans les raisonnements que l'on fait sur cette matière."²

The first three volumes of Treviranus's *Biologie*, which contains his general views of evolution, appeared between 1802 and 1805. The *Recherches sur l'organisation des corps vivants*, which sketches out Lamarck's doctrines, was published in 1802; but the full development of his views in the *Philosophie zoologique* did not take place until 1809.

¹ *Considérations philosophiques sur la gradation naturelle des formes de l'être; ou les essais de la nature qui apprend à faire l'homme* (1768).

² *Recherches sur les causes des principaux faits physiques*, par J. B. Lamarck. Paris. Seconde année de la République. In the preface, Lamarck says that the work was written in 1776, and presented to the Academy in 1780; but it was not published before 1794, and at that time it presumably expressed Lamarck's mature views. It would be interesting to know what brought about the change of opinion manifested in the *Recherches sur l'organisation des corps vivants*, published only seven years later.

The *Biologie* and the *Philosophie zoologique* are both very remarkable productions, and are still worthy of attentive study, but they fell upon evil times. The vast authority of Cuvier was employed in support of the traditionally respectable hypotheses of special creation and of catastrophism; and the wild speculations of the *Discours sur les révolutions de la surface du globe* were held to be models of sound scientific thinking, while the really much more sober and philosophical hypotheses of the *Hydrogéologie* were scouted. For many years it was the fashion to speak of Lamarck with ridicule, while Treviranus was altogether ignored.

Nevertheless, the work had been done. The conception of evolution was henceforward irrepensible, and it incessantly reappears, in one shape or another,³ up to the year 1858, when Charles Darwin and A. R. Wallace published their *Theory of Natural Selection*. The *Origin of Species* appeared in 1859; and thenceforward the doctrine of evolution assumed a position and acquired an importance which it never before possessed. In the *Origin of Species*, and in his other numerous and important contributions to the solution of the problem of biological evolution, Darwin confined himself to the discussion of the causes which have brought about the present condition of living matter, assuming such matter to have once come into existence. On the other hand, Spencer⁴ and E. Haeckel⁵ dealt with the whole problem of evolution. The profound and vigorous writings of Spencer embody the spirit of Descartes in the knowledge of our own day, and may be regarded as the *Principes de la philosophie* of the 19th century; while, whatever hesitation may not unfrequently be felt by less daring minds in following Haeckel in many of his speculations, his attempt to systematize the doctrine of evolution and to exhibit its influence as the central thought of modern biology, cannot fail to have a far-reaching influence on the progress of science.

If we seek for the reason of the difference between the scientific position of the doctrine of evolution in the days of Lamarck and that which it occupies now, we shall find it in the great accumulation of facts, the several classes of which have been enumerated above, under the second to the eighth heads. For those which are grouped under the second to the seventh of these classes, respectively, have a clear significance on the hypothesis of evolution, while they are unintelligible if that hypothesis be denied. And those of the eighth group are not only unintelligible without the assumption of evolution, but can be proved never to be discordant with that hypothesis, while, in some cases, they are exactly such as the hypothesis requires. The demonstration of these assertions would require a volume, but the general nature of the evidence on which they rest may be briefly indicated.

2. The accurate investigation of the lowest forms of animal life, commenced by Leeuwenhoek and Swammerdam, and continued by the remarkable labours of Réaumur, Abraham Trembley, Bonnet, and a host of other observers in the latter part of the 17th and the first half of the 18th centuries, drew the attention of biologists to the gradation in the complexity of organization which is presented by living beings, and culminated in the doctrine of the *échelle des êtres*, so powerfully and clearly stated by Bonnet, and, before him, adumbrated by Locke and by Leibnitz. In the then state of knowledge, it appeared that all the species of animals and plants could be arranged in one series, in such a manner that, by insensible gradations, the mineral passed into the plant, the plant into the polype, the polype into the worm, and so, through gradually higher forms of life, to man, at the summit of the animated world.

But, as knowledge advanced, this conception ceased to be tenable in the crude form in which it was first put forward. Taking into account existing animals and plants alone, it became obvious that they fell into groups which were more or less sharply separated from one another; and, moreover, that even

³ See the "Historical Sketch" prefixed to the last edition of the *Origin of Species*.

⁴ *First Principles and Principles of Biology* (1860-1864).

⁵ *Générale Morphologie* (1866).

the species of a genus can hardly ever be arranged in linear series. Their natural resemblances and differences are only to be expressed by disposing them as if they were branches springing from a common hypothetical centre.

Lamarck, while affirming the verbal proposition that animals form a single series, was forced by his vast acquaintance with the details of zoology to limit the assertion to such a series as may be formed out of the abstractions constituted by the common characters of each group.¹

Cuvier on anatomical, and Von Baer on embryological grounds, made the further step of proving that, even in this limited sense, animals cannot be arranged in a single series, but that there are several distinct plans of organization to be observed among them, no one of which, in its highest and most complicated modification, leads to any of the others.

The conclusions enunciated by Cuvier and Von Baer have been confirmed in principle by all subsequent research into the structure of animals and plants. But the effect of the adoption of these conclusions has been rather to substitute a new metaphor for that of Bonnet than to abolish the conception expressed by it. Instead of regarding living things as capable of arrangement in one series like the steps of a ladder, the results of modern investigation compel us to dispose them as if they were the twigs and branches of a tree. The ends of the twigs represent individuals, the smallest groups of twigs species, larger groups genera, and so on, until we arrive at the source of all these ramifications of the main branch, which is represented by a common plan of structure. At the present moment it is impossible to draw up any definition, based on broad anatomical or developmental characters, by which any one of Cuvier's great groups shall be separated from all the rest. On the contrary, the lower members of each tend to converge towards the lower members of all the others. The same may be said of the vegetable world. The apparently clear distinction between flowering and flowerless plants has been broken down by the series of gradations between the two exhibited by the *Lycopodiaceae*, *Rhizocarpeae*, and *Gymnospermeae*. The groups of *Fungi*, *Licheneae* and *Algae* have completely run into one another, and, when the lowest forms of each are alone considered, even the animal and vegetable kingdoms cease to have a definite frontier.

If it is permissible to speak of the relations of living forms to one another metaphorically, the similitude chosen must undoubtedly be that of a common root, whence two main trunks, one representing the vegetable and one the animal world, spring; and, each dividing into a few main branches, these subdivide into multitudes of branchlets and these into smaller groups of twigs.

As Lamarck has well said:²

"Il n'y a que ceux qui se sont longtemps et fortement occupés de la détermination des espèces, et qui ont consulté de riches collections, qui peuvent savoir jusqu'à quel point les espèces, parmi les corps vivants, se fondent les unes dans les autres, et qui ont pu se convaincre que, dans les parties où nous voyons des espèces isolées, cela n'est ainsi que parcequ'il nous en manque d'autres qui en sont plus voisines et que nous n'avons pas encore recueillies.

"Je ne veux pas dire pour cela que les animaux qui existent forment une série très-simple et partout également nuancée; mais je dis qu'ils forment une série rameuse, irrégulièrement graduée et qui n'a point de discontinuité dans ses parties, ou qui, du moins, n'en a toujours pas eu, s'il est vrai que, par suite de quelques espèces perdues, il s'en trouve quelque part. Il en résulte que les espèces qui terminent chaque rameau de la série générale tiennent, au moins d'un côté, à d'autres espèces voisines qui se nuancent avec elles. Voilà ce que l'état bien connu des choses me met maintenant à portée de démontrer. Je n'ai besoin d'aucune hypothèse ni d'aucune supposition pour cela: j'en atteste tous les naturalistes observateurs."

3. In a remarkable essay³ Meckel remarks:—

"There is no good physiologist who has not been struck by the observation that the original form of all organisms is one and the

¹ "Il s'agit donc de prouver que la série qui constitue l'échelle animale réside essentiellement dans la distribution des masses principales qui la composent et non dans celle des espèces ni même toujours dans celle des genres."—*Phil. zoologique*, chap. v.

² *Philosophie zoologique*, première partie, chap. iii.

³ "Entwurf einer Darstellung der zwischen dem Embryozustände der höheren Thiere und dem permanenten der niederen stattfindenden Parallelen," *Beyträge zur vergleichenden Anatomie*, Bd. ii. 1811.

same, and that out of this one form, all, the lowest as well as the highest, are developed in such a manner that the latter pass through the permanent forms of the former as transitory stages. Aristotle, Haller, Harvey, Kiemeyer, Autenrieth, and many others have either made this observation incidentally, or, especially the latter, have drawn particular attention to it, and drawn therefrom results of permanent importance for physiology."

Meckel proceeds to exemplify the thesis, that the lower forms of animals represent stages in the course of the development of the higher, with a large series of illustrations.

After comparing the salamanders and the perenni-branchiate *Urodela* with the tadpoles and the frogs, and enunciating the law that the more highly any animal is organized the more quickly does it pass through the lower stages, Meckel goes on to say:—

"From these lowest Vertebrata to the highest, and to the highest forms among these, the comparison between the embryonic conditions of the higher animals and the adult states of the lower can be more completely and thoroughly instituted than if the survey is extended to the Invertebrata, inasmuch as the latter are in many respects constructed upon an altogether too dissimilar type; indeed they often differ from one another far more than the lowest vertebrate does from the highest mammal; yet the following pages will show that the comparison may be also extended to them with interest. In fact, there is a period when, as Aristotle long ago said, the embryo of the highest animal has the form of a mere worm, and, devoid of internal and external organization, is merely an almost structureless lump of polype-substance. Notwithstanding the origin of organs, it still for a certain time, by reason of its want of an internal bony skeleton, remains worm and mollusk, and only later enters into the series of the Vertebrata, although traces of the vertebral column even in the earliest periods testify its claim to a place in that series."—*Op. cit.* pp. 4, 5.

If Meckel's proposition is so far qualified, that the comparison of adult with embryonic forms is restricted within the limits of one type of organization; and if it is further recollected, that the resemblance between the permanent lower form and the embryonic stage of a higher form is not special but general, it is in entire accordance with modern embryology; although there is no branch of biology which has grown so largely, and improved its methods so much since Meckel's time, as this. In its original form, the doctrine of "arrest of development," as advocated by Geoffroy Saint-Hilaire and Serres, was no doubt an over-statement of the case. It is not true, for example, that a fish is a reptile arrested in its development, or that a reptile was ever a fish; but it is true that the reptile embryo, at one stage of its development, is an organism which, if it had an independent existence, must be classified among fishes; and all the organs of the reptile pass, in the course of their development, through conditions which are closely analogous to those which are permanent in some fishes.

4. That branch of biology which is termed morphology is a commentary upon, and expansion of, the proposition that widely different animals or plants, and widely different parts of animals or plants, are constructed upon the same plan. From the rough comparison of the skeleton of a bird with that of a man by Pierre Delon, in the 16th century (to go no further back), down to the theory of the limbs and the theory of the skull at the present day; or, from the first demonstration of the homologies of the parts of a flower by C. F. Wolff, to the present elaborate analysis of the floral organs, morphology exhibits a continual advance towards the demonstration of a fundamental unity among the seeming diversities of living structures. And this demonstration has been completed by the final establishment of the cell theory (see CYTOLOGY), which involves the admission of a primitive conformity, not only of all the elementary structures in animals and plants respectively, but of those in the one of these great divisions of living things with those in the other. No *a priori* difficulty can be said to stand in the way of evolution, when it can be shown that all animals and all plants proceed by modes of development, which are similar in principle, from a fundamental protoplasmic material.

5. The innumerable cases of structures, which are rudimentary and apparently useless, in species, the close allies of which possess well-developed and functionally important homologous

structures, are readily intelligible on the theory of evolution, while it is hard to conceive their *raison d'être* on any other hypothesis. However, a cautious reasoner will probably rather explain such cases deductively from the doctrine of evolution than endeavour to support the doctrine of evolution by them. For it is almost impossible to prove that any structure, however rudimentary, is useless—that is to say, that it plays no part whatever in the economy; and, if it is in the slightest degree useful, there is no reason why, on the hypothesis of direct creation, it should not have been created. Nevertheless, double-edged as is the argument from rudimentary organs, there is probably none which has produced a greater effect in promoting the general acceptance of the theory of evolution.

6. The older advocates of evolution sought for the causes of the process exclusively in the influence of varying conditions, such as climate and station, or hybridization, upon living forms. Even Treviranus has got no further than this point. Lamarck introduced the conception of the action of an animal on itself as a factor in producing modification. Starting from the well-known fact that the habitual use of a limb tends to develop the muscles of the limb, and to produce a greater and greater facility in using it, he made the general assumption that the effort of an animal to exert an organ in a given direction tends to develop the organ in that direction. But a little consideration showed that, though Lamarck had seized what, as far as it goes, is a true cause of modification, it is a cause the actual effects of which are wholly inadequate to account for any considerable modification in animals, and which can have no influence at all in the vegetable world; and probably nothing contributed so much to discredit evolution, in the early part of the 19th century, as the floods of easy ridicule which were poured upon this part of Lamarck's speculation. The theory of natural selection, or survival of the fittest, was suggested by William Charles Wells in 1813, and further elaborated by Patrick Matthew in 1831. But the pregnant suggestions of these writers remained practically unnoticed and forgotten, until the theory was independently devised and promulgated by Charles Robert Darwin and Alfred Russell Wallace in 1858, and the effect of its publication was immediate and profound.

Those who were unwilling to accept evolution, without better grounds than such as are offered by Lamarck, and who therefore preferred to suspend their judgment on the question, found in the principle of selective breeding, pursued in all its applications with marvellous knowledge and skill by Darwin, a valid explanation of the occurrence of varieties and races; and they saw clearly that, if the explanation would apply to species, it would not only solve the problem of their evolution, but that it would account for the facts of teleology, as well as for those of morphology; and for the persistence of some forms of life unchanged through long epochs of time, while others undergo comparatively rapid metamorphosis.

How far "natural selection" suffices for the production of species remains to be seen. Few can doubt that, if not the whole cause, it is a very important factor in that operation; and that it must play a great part in the sorting out of varieties into those which are transitory and those which are permanent.

But the causes and conditions of variation have yet to be thoroughly explored; and the importance of natural selection will not be impaired, even if further inquiries should prove that variability is definite, and is determined in certain directions rather than in others, by conditions inherent in that which varies. It is quite conceivable that every species tends to produce varieties of a limited number and kind, and that the effect of natural selection is to favour the development of some of these, while it opposes the development of others along their pre-determined lines of modification.

7. No truths brought to light by biological investigation were better calculated to inspire distrust of the dogmas intruded upon science in the name of theology than those which relate to the distribution of animals and plants on the surface of the earth. Very skilful accommodation was needful, if the limitation of sloths to South America, and of the *Ornithorhynchus* to

Australia, was to be reconciled with the literal interpretation of the history of the Deluge; and, with the establishment of the existence of distinct provinces of distribution, any serious belief in the peopling of the world by migration from Mount Ararat came to an end.

Under these circumstances, only one alternative was left for those who denied the occurrence of evolution; namely, the supposition that the characteristic animals and plants of each great province were created, as such, within the limits in which we find them. And as the hypothesis of "specific centres," thus formulated, was heterodox from the theological point of view, and unintelligible under its scientific aspect, it may be passed over without further notice, as a phase of transition from the creational to the evolutionary hypothesis.

8. In fact, the strongest and most conclusive arguments in favour of evolution are those which are based upon the facts of geographical, taken in conjunction with those of geological, distribution.

Both Darwin and Wallace lay great stress on the close relation which obtains between the existing fauna of any region and that of the immediately antecedent geological epoch in the same region; and rightly, for it is in truth inconceivable that there should be no genetic connexion between the two. It is possible to put into words the proposition, that all the animals and plants of each geological epoch were annihilated, and that a new set of very similar forms was created for the next epoch, but it may be doubted if any one who ever tried to form a distinct mental image of this process of spontaneous generation on the grandest scale ever really succeeded in realizing it.

In later years the attention of the best palaeontologists has been withdrawn from the hodman's work of making "new species" of fossils, to the scientific task of completing our knowledge of individual species, and tracing out the succession of the forms presented by any given type in time.

Evolution at the Beginning of the 20th century.—Since Huxley and Sully wrote their masterly essays in the 9th edition of this encyclopaedia, the doctrine of evolution has outgrown the trammels of controversy and has been accepted as a fundamental principle. Writers on biological subjects no longer have to waste space in weighing evolution against this or that philosophical theory or religious tradition; philosophical writers have frankly accepted it, and the supporters of religious tradition have made broad their phylacteries to write on them the new words. A closer scrutiny of the writers of all ages who preceded Charles Darwin, and, in particular, the light thrown back from Darwin on the earlier writings of Herbert Spencer, have made plain that without Darwin the world by this time might have come to a general acceptance of evolution; but it seems established as a historical fact that the world has come to accept evolution, first, because of Darwin's theory of natural selection, and second, because of Darwin's exposition of the evidence for the actual occurrence of organic evolution. The evidence as set out by Darwin has been added to enormously; new knowledge has in many cases altered our conceptions of the mode of the actual process of evolution, and from time to time a varying stress has been laid on what are known as the purely Darwinian factors in the theory. The balance of these tendencies has been against the attachment of great importance to sexual selection, and in favour of attaching a great importance to natural selection; but the dominant feature in the recent history of the theory has been its universal acceptance and the recognition that this general acceptance has come from the stimulus given by Darwin.

A change has taken place in the use of the word evolution. Huxley, following historical custom, devoted one section of his article to the "Evolution of the Individual." The *Ontogeny*. facts and theories respecting this are now discussed under such headings as EMBRYOLOGY; HEREDITY; VARIATION AND SELECTION; under these headings must be sought information on the important recent modifications with regard to the theory of the relation between the development of the individual and the development of the race, the part played by the environment on the individual, and the modern developments of the

old quarrel between evolution and epigenesis. The most striking general change has been against seeing in the facts of ontogeny any direct evidence as to phylogeny. The general proposition as to a parallelism between individual and ancestral development is no doubt indisputable, but extended knowledge of the very different ontogenetic histories of closely allied forms has led us to a much fuller conception of the mode in which stages in embryonic and larval history have been modified in relation to their surroundings, and to a consequent reluctance to attach detailed importance to the embryological argument for evolution.

The vast bulk of botanical and zoological work on living and extinct forms published during the last quarter of the 19th century increased almost beyond all expectation the evidence for the fact of evolution. The discovery of a single fossil creature in a geological stratum of a wrong period, the detection of a single anatomical or physiological fact irreconcilable with origin by descent with modification, would have been destructive of the theory and would have made the reputation of the observer. But in the prodigious number of supporting discoveries that have been made no single negative factor has appeared, and the evolution from their predecessors of the forms of life existing now or at any other period must be taken as proved. It is necessary to notice, however, that although the general course of the stream of life is certain, there is not the same certainty as to the actual individual pedigrees of the existing forms. In the attempts to place existing creatures in approximately phylogenetic order, a striking change, due to a more logical consideration of the process of evolution, has become established and is already resolving many of the earlier difficulties and banishing from the more recent tables the numerous hypothetical intermediate forms so familiar in the older phylogenetic trees. The older method was to attempt the comparison between the highest member of a lower group and the lowest member of a higher group—to suppose, for example, that the gorilla and the chimpanzee, the highest members of the apes, were the existing representatives of the ancestors of man and to compare these forms with the lowest members of the human race. Such a comparison is necessarily illogical, as the existing apes are separated from the common ancestor by at least as large a number of generations as separate it from any of the forms of existing man. In the natural process of growth, the gap must necessarily be wider between the summits of the twigs than lower down, and, instead of imagining "missing links," it is necessary to trace each separate branch as low down as possible, and to institute the comparisons between the lowest points that can be reached. The method is simply the logical result of the fact that every existing form of life stands at the summit of a long branch of the whole tree of life. A due consideration of it leads to the curious paradox that if any two animals be compared, the zoologically lower will be separated from the common ancestor by a larger number of generations, since, on the average, sexual maturity is reached more quickly by the lower form. Naturally very many other factors have to be considered, but this alone is a sufficient reason to restrain attempts to place existing forms in linear phylogenetic series. In embryology the method finds its expression in the limitation of comparisons to the corresponding stages of low and high forms and the exclusion of the comparisons between the adult stages of low forms and the embryonic stages of higher forms. Another expression of the same method, due to Cope, and specially valuable to the taxonomist, is that when the relationship between orders is being considered, characters of subordinal rank must be neglected. It must not be supposed that earlier writers all neglected this method, or still less that all writers now employ it, but merely that formerly it was frequently overlooked by the best writers, and now is neglected only by the worst. The result is, on the one hand, a clearing away of much fantastic phylogeny, on the other, an enormous reduction of the supposed gaps between groups.

There has been a renewed activity in the study of existing forms from the point of view of obtaining evidence as to the nature and origin of species. Comparative anatomists have been learning to refrain from basing the diagnosis of a species, or the

description of the condition of an organ, on the evidence of a single specimen. Naturalists who deal specially with museum collections have been compelled, it is true, for other reasons to attach an increasing importance to what is called the type specimen, but they find that this insistence on the individual, although invaluable from the point of view of recording species, is unsatisfactory from the point of view of scientific zoology; and propositions for the amelioration of this condition of affairs range from a refusal of Linnaean nomenclature in such cases, to the institution of a division between *master species* for such species as have been properly revised by the comparative morphologist, and *provisional species* for such species as have been provisionally registered by those working at collections. Those who work with living forms of which it is possible to obtain a large number of specimens, and those who make revisions of the provisional species of palaeontologists, are slowly coming to some such conception as that a species is the abstract central point around which a group of variations oscillate, and that the peripheral oscillations of one species may even overlap those of an allied species. It is plain that we have moved far from the connotation and denotation of the word *species* at the time when Darwin began to discuss the origin of species, and that the movement, on the one hand, tends to simplify the problem philosophically, and, on the other, to make it difficult for the amateur theorist.

The conception of evolution is being applied more rigidly to the comparative anatomy of organs and systems of organs. When a series of the modifications of an anatomical structure has been sufficiently examined, it is frequently possible to decide that one particular condition is primitive, ancestral or central, and that the other conditions have been derived from it. Such a condition has been termed, with regard to the group of animals or plants the organs of which are being studied, *archecentric*. The possession of the character in the archecentric condition in (say) two of the members of the group does not indicate that these two members are more nearly related to one another than they are to other members of the group; the archecentric condition is part of the common heritage of all the members of the group, and may be retained by any. On the other hand, when the ancestral condition is modified, it may be regarded as having moved outwards along some radius from the archecentric condition. Such modified conditions have been termed *apocentric*. It is obvious that the mere apocentricity of a character can be no guide to the affinities of its possessor. It is necessary to determine if the modification be a simple change that might have occurred in independent cases, in fact if it be a multiradial apocentricity, or if it involved intricate and precisely combined anatomical changes that we could not expect to occur twice independently; that is to say, if it be a uniradial apocentricity. Multiradial apocentricities lie at the root of many of the phenomena that have been grouped under the designation *convergence*. Especially in the case of manifest adaptations, organs possessed by creatures far apart genealogically may be moulded into conditions that are extremely alike. Sir E. Ray Lankester's term, *homoplasy*, has passed into currency as designating such cases where different genetic material has been pressed by similar conditions into similar moulds. These may be called heterogeneous homoplasies, but it is necessary to recognize the existence of homogeneous homoplasies, here called multiradial apocentricities. A complex apocentric modification of a kind which we cannot imagine to have been repeated independently, and which is to be designated as uniradial, frequently forms a new centre around which new diverging modifications are produced. With reference to any particular group of forms such a new centre of modification may be termed a *metacentre*, and it is plain that the archecentre of the whole group is a metacentre of the larger group of which the group under consideration is a branch. Thus, for instance, the archecentric condition of any Avian structure is a metacentre of the Sauropsidan stem. A form of apocentricity extremely common and often perplexing may be termed *pseudocentric*; in such a condition there is an apparent simplicity that

Comparative anatomy.

reveals its secondary nature by some small and apparently meaningless complexity.

Another group of investigations that seems to play an important part in the future development of the theory of evolution relates to the study of what is known as organic symmetry. The differentiations of structure that characterize animals and plants are being shown to be orderly and definite in many respects; the relations of the various parts to one another and to the whole, the modes of repetition of parts, and the series of changes that occur in groups of repeated parts appear to be to a certain extent inevitable, to depend on the nature of the living material itself and on the necessary conditions of its growth. Closely allied to the study of symmetry is the study of the direct effect of the circumambient media on embryonic young and adult stages of living beings (see EMBRYOLOGY: *Physiology*; HEREDITY; and VARIATION AND SELECTION), and a still larger number of observers have added to our knowledge of these. It is impossible here to give even a list of the names of the many observers who in recent times have made empirical study of the effects of growth-forces and of the symmetrical limitations and definitions of growth. It is to be noticed, however, that, even after such phenomena have been properly grouped and designated under Greek names as laws of organic growth, they have not become explanations of the series of facts they correlate. Their importance in the theory of evolution is none the less very great. In the first place, they lessen the number of separate facts to be explained; in the second, they limit the field within which explanation must be sought, since, for instance, if a particular mode of repetition of parts occur in mosses, in flowering-plants, in beetles and in elephants, the seeker of ultimate explanations may exclude from the field of his inquiry all the conditions individual to these different organic forms, and confine himself only to what is common to all of them; that is to say, practically only the living material and its environment. The prosecution of such inquiries is beginning to make unnecessary much ingenious speculation of a kind that was prominent from 1880 to 1900; much futile effort has been wasted in the endeavour to find on Darwinian principles special "selection-values" for phenomena the universality of which places them outside the possibility of having relations with the particular conditions of particular organisms. On the other hand, many of those who have been specially successful in grouping diverse phenomena under empirical generalizations have erred logically in posing their generalizations against such a *vera causa* as the preservation of favoured individuals and races. The thirty years which followed the publication of the *Origin of Species* were characterized chiefly by anatomical and embryological work; since then there has been no diminution in anatomical and embryological enthusiasm, but many of the continually increasing body of investigators have turned again to bionomical work. Inasmuch as Lamarck attempted to frame a theory of evolution in which the principle of natural selection had no part, the interpretation placed on their work by many bionomical investigators recalls the theories of Lamarck, and the name *Neo-Lamarckism* has been used of such a school of biologists, particularly active in America. The weakness of the Neo-Lamarckian view lies in its interpretation of heredity; its strength lies in its zealous study of the living world and the detection therein of proximate empirical laws, a strength shared by very many bionomical investigations, the authors of which would prefer to call themselves Darwinians, or to leave themselves without sectarian designation.

Statistical inquiry into the facts of life has long been employed, and in particular Francis Galton, within the Darwinian period, has advocated its employment and developed its methods.

Bio-metrics. Within quite recent years, however, a special school has arisen with the main object of treating the processes of evolution quantitatively. Here it is right to speak of Karl Pearson as a pioneer of notable importance. It has been the habit of biologists to use the terms variation, selection, elimination, correlation and so forth, vaguely; the new school,

which has been strongly reinforced from the side of physical science, insists on quantitative measurements of the terms. When the anatomist says that one race is characterized by long heads, another by round heads, the biometricist demands numbers and percentages. When an organ is stated to be variable, the biometricist demands statistics to show the range of the variations and the mode of their distribution. When a character is said to be favoured by natural selection, the biometricist demands investigation of the death-rate of individuals with or without the character. When a character is said to be transmitted, or to be correlated with another character, the biometricist declares the statement valueless without numerical estimations of the inheritance or correlation. The subject is still so new, and its technical methods (see VARIATION AND SELECTION) have as yet spread so little beyond the group which is formulating and defining them, that it is difficult to do more than guess at the importance of the results likely to be gained. Enough, however, has already been done to show the vast importance of the method in grouping and codifying the empirical facts of life, and in so preparing the way for the investigation of ultimate "causes." The chief pitfall appears to be the tendency to attach more meaning to the results than from their nature they can bear. The ultimate value of numerical inquiries must depend on the equivalence of the units on which they are based. Many of the characters that up to the present have been dealt with by biometrical inquiry are obviously composite. The height or length of the arm of a human being, for instance, is the result of many factors, some inherent, some due to environment, and until these have been sifted out, numerical laws of inheritance or of correlation can have no more than an empirical value. The analysis of composite characters into their indivisible units and statistical inquiry into the behaviour of the units would seem to be a necessary part of biometric investigation, and one to which much further attention will have to be paid.

It is well known that Darwin was deeply impressed by differences in flora and fauna, which seemed to be functions of locality, and not the result of obvious dissimilarities of environment. A. R. Wallace's studies of island life, and the work of many different observers on local races of animals and plants, marine, fluvial and terrestrial, have brought about a conception of segregation as apart from differences of environment as being one of the factors in the differentiation of living forms. The segregation may be geographical, or may be the result of preferential mating, or of seasonal mating, and its effects plainly can be made no more of than proximate or empirical laws of differentiation, of great importance in codifying and simplifying the facts to be explained. The minute attention paid by modern systematists to the exact localities of subspecies and races is bringing together a vast store of facts which will throw further light on the problem of segregation, but the difficulty of utilizing these facts is increased by an unfortunate tendency to make locality itself one of the diagnostic characters.

Consideration of phylogenetic series, especially from the palaeontological side, has led many writers to the conception that there is something of the nature of a growth-force inherent in organisms and tending inevitably towards divergent evolution. It is suggested that even in the absence of modification produced by any possible Darwinian or Lamarckian factors, that even in a neutral environment, divergent evolution of some kind would have occurred. The conception is necessarily somewhat hazy, but the words *bathmism* and *bathmic Evolution* have been employed by a number of writers for some such conception. Closely connected with it, and probably underlying many of the facts which have led to it, is a more definite group of ideas that may be brought together under the phrase "phylogenetic limitation of variation." In its simplest form, this phrase implies such an obvious fact as that whatever be the future development of, say, existing cockroaches, it will be on lines determined by the present structure of these creatures. In a more general way, the phrase implies that at each successive branching of the tree of life, the branches become more specialized,

more defined, and, in a sense, more limited. The full implications of the group of ideas require, and are likely to receive, much attention in the immediate future of biological investigation, but it is enough at present to point out that until the more obvious lines of inquiry have been opened out much more fully, we cannot be in a position to guess at the existence of a residuum, for which such a metaphysical conception as bathmism would serve even as a convenient disguise for ignorance.

Almost every side of zoology has contributed to the theory of evolution, but of special importance are the facts and theories associated with the names of Gregor Mendel, A. Weismann and Hugo de Vries. These are discussed under the headings HEREDITY; MENDELISM; and VARIATION AND SELECTION. It has been a feature of great promise in recent contributions to the theory of evolution, that such contributions have received attention almost directly in proportion to the new methods of observation and the new series of facts with which they have come. Those have found little favour who brought to the debate only formal criticisms or amplifications of the Darwinian arguments, or re-marshallings of the Darwinian facts, however ably conducted. The time has not yet come for the attempt to synthesize the results of the many different and often apparently antagonistic groups of workers. The great work that is going on is the simplification of the facts to be explained by grouping them under empirical laws; and the most general statement relating to these that can yet be made is that no single one of these laws has as yet shown signs of taking rank as a *vera causa* comparable with the Darwinian principle of natural selection.

For evolution in relation to society see SOCIOLOGY.

REFERENCES.—Practically, every botanical and zoological publication of recent date has its bearing on evolution. The following are a few of the more general works: Bateson, *Materials for the Study of Variation*; Bunge, *Vitalismus und Mechanismus*; Cope, *Origin of the Fittest, Primary Factors of Organic Evolution, Darwin's Life and Letters*; H. de Vries, *Species and Varieties and their Origin by Mutation*; Eimer, *Organic Evolution*; Gulick, "Divergent Evolution through Cumulative Segregation," *Jour. Linn. Soc.* xx.; Haacke, *Schöpfung des Menschen*; Mitchell, "Valuation of Zoological Characters," *Trans. Linn. Soc.* viii. pt. 7; Pearson, *Grammar of Science*; Romanes, *Darwin and after Darwin*; Sedgwick, Presidential Address to Section Zoology, *Brit. Ass. Rep.* 1899; Wallace, *Darwinism*; Weismann, *The Germ-Plasm*. Further references of great value will be found in the works of Bateson and Pearson referred to above, and in the annual volumes of the *Zoological Record*, particularly under the head "General Subject." (P. C. M.)

EVORA, the capital of an administrative district in the province of Alemtejo, Portugal; 72 m. E. by S. of Lisbon, on the Casa Branca-Evora-Elvas railway. Pop. (1900) 16,020. Evora occupies a fertile valley enclosed by low hills. It is surrounded by ramparts flanked with towers, and is further defended by two forts; but the neglected condition of these, combined with the narrow arcaded streets and crumbling walls of Roman or Moorish masonry, gives the city an appearance corresponding with its real antiquity. Evora is the see of an archbishop, and has several churches, convents and hospitals, barracks, a diocesan school and a museum. A university, founded in 1550, was abolished on the expulsion of the Jesuits in the 18th century. The cathedral, originally a Romanesque building erected 1186-1204, was restored in Gothic style about 1400; its richly decorated chancel was added in 1761. The church of São Francisco (1507-1525) is a good example of the blended Moorish and Gothic architecture known as Manoellian. The art gallery, formerly the archbishop's palace, contains a collection of Portuguese and early Flemish paintings. An ancient tower, and the so-called aqueduct of Sertorius, 9 m. long, have been partly demolished to make room for the market-square, in which one of the largest fairs in Portugal is held at midsummer. Both tower and aqueduct were long believed to have been of Roman origin, but are now known to have been constructed about 1540-1555 in the reign of John III., at the instance of an antiquary named Resende. The aqueduct was probably constructed on the site of the old Roman one. A small Roman temple is used as a public library; it is usually known as the temple of Diana, a name for which no valid authority

exists. Evora is of little commercial importance, except as an agricultural centre, but its neighbourhood is famous for its mules and abounds in cork-woods; there are also mines of iron, copper, and asbestos and marble quarries.

Under its original name of *Ebora*, the city was from 80 to 72 B.C. the headquarters of Sertorius, and it long remained an important Roman military station. It was called *Liberalitas Juliae* on account of certain municipal privileges bestowed on it by Julius Caesar (c. 100-44 B.C.). Its bishopric, founded in the 5th century, was raised to an archbishopric in the 16th. In 712 Evora was conquered by the Moors, who named it *Jabura*; and it was only retaken in 1166. From 1663 to 1665 it was held by the Spaniards. In 1832 Dom Miguel, retreating before Dom Pedro, took refuge in Evora; and here was signed the convention of Evora, by which he was banished. (See PORTUGAL.)

The administrative district of Evora coincides with the central part of Alemtejo (*q.v.*); pop. (1900) 128,062; area, 2856 sq. m. **ÉVREUX**, a town of north-western France, capital of the department of Eure, 67 m. W.N.W. of Paris on the Western railway to Cherbourg. Pop. (1906) town, 13,773; commune, 18,971. Situated in the pleasant valley of the Iton, arms of which traverse it, the town, on the south, slopes up toward the public gardens and the railway station. It is the seat of a bishop, and its cathedral is one of the largest and finest in France. Part of the lower portion of the nave dates from the 11th century; the west façade with its two ungainly towers is, for the most part, the work of the late Renaissance, and various styles of the intervening period are represented in the rest of the church. A thorough restoration was completed in 1896. The elaborate north transept and portal are in the flamboyant Gothic; the choir, the finest part of the interior, is in an earlier Gothic style. Cardinal de la Balue, bishop of Évreux in the latter half of the 15th century, constructed the octagonal central tower, with its elegant spire; to him is also due the Lady chapel, which is remarkable for some finely preserved stained glass. Two rose windows in the transepts and the carved wooden screens of the side chapels are masterpieces of 16th-century workmanship. The episcopal palace, a building of the 15th century, adjoins the south side of the cathedral. An interesting belfry, facing the handsome modern town hall, dates from the 15th century. The church of St Taurin, in part Romanesque, has a choir of the 14th century and other portions of later date; it contains the shrine of St Taurin, a work of the 13th century. At Vieil Évreux, 3½ m. south-east of the town, the remains of a Roman theatre, a palace, baths and an aqueduct have been discovered, as well as various relics which are now deposited in the museum of Évreux. Évreux is the seat of a prefect, a court of assizes, of tribunals of first instance and commerce, a chamber of commerce and a board of trade arbitrators, and has a branch of the Bank of France, a lycée and training colleges for teachers. The making of ticking, boots and shoes, agricultural implements and gas motors, and metal-founding and bleaching are carried on.

Vieil-Évreux (*Mediolanum Aulerorum*) was the capital of the Gallic tribe of the *Auleri Eburovices* and a flourishing city during the Gallo-Roman period. Its bishopric dates from the 4th century.

The first family of the counts of Évreux which is known was descended from an illegitimate son of Richard I., duke of Normandy, and became extinct in the male line with the death of Count William in 1118. The countship passed in right of Agnes, William's sister, wife of Simon de Montfort-l'Amaury (d. 1087) to the house of the lords of Montfort-l'Amaury. Amaury III. of Montfort ceded it in 1200 to King Philip Augustus. Philip the Fair presented it (1307) to his brother Louis, for whose benefit Philip the Long raised the countship of Évreux into a peerage of France (1317). Philip of Évreux, son of Louis, became king of Navarre by his marriage with Jeanne, daughter of Louis the Headstrong (Hutin), and their son Charles the Bad and their grandson Charles the Noble were also kings of Navarre. The latter ceded his countships of Évreux, Champagne and Brie to King Charles VI. (1404). In 1427 the countship of Évreux was bestowed by King Charles VII. on Sir John Stuart of

Darnley (c. 1365-1420), the commander of his Scottish body-guard, who in 1423 had received the seigniorship of Aubigny and in February 1427/8 was granted the right to quarter the royal arms of France for his victories over the English (see Lady Elizabeth Cust, *Account of the Stuarts of Aubigny in France, 1422-1672*, 1891). On Stuart's death (before Orleans during an attack on an English convoy) the countship reverted to the crown. It was again temporarily alienated (1569-1584) as an appanage for Francis, duke of Anjou, and in 1651 was finally made over to Frédéric Maurice de la Tour d'Auvergne, duke of Bouillon, in exchange for the principality of Sedan.

EWALD, GEORG HEINRICH AUGUST VON (1803-1875), German Orientalist and theologian, was born on the 16th of November 1803 at Göttingen, where his father was a linen-weaver. In 1815 he was sent to the gymnasium, and in 1820 he entered the university of his native town, where under J. G. Eichhorn and T. C. Tychsen he devoted himself specially to the study of Oriental languages. At the close of his academical career in 1823 he was appointed to a mastership in the gymnasium at Wolfenbüttel, and made a study of the Oriental manuscripts in the Wolfenbüttel library. But in the spring of 1824 he was recalled to Göttingen as *repentent*, or theological tutor, and in 1827 (the year of Eichhorn's death) he became professor *extraordinarius* in philosophy and lecturer in Old Testament exegesis. In 1831 he was promoted to the position of professor *ordinarius* in philosophy; in 1833 he became a member of the Royal Scientific Society, and in 1835, after Tychsen's death, he entered the faculty of theology, taking the chair of Oriental languages.

Two years later occurred the first important episode in his studious life. In 1837, on the 18th of November, along with six of his colleagues he signed a formal protest against the action of King Ernst August (duke of Cumberland) in abolishing the liberal constitution of 1833, which had been granted to the Hanoverians by his predecessor William IV. This bold procedure of the seven professors led to their speedy expulsion from the university (14th December). Early in 1838 Ewald received a call to Tübingen, and there for upwards of ten years he held a chair as professor *ordinarius*, first in philosophy and afterwards, from 1841, in theology. To this period belong some of his most important works, and also the commencement of his bitter feud with F. C. Baur and the Tübingen school. In 1847, "the great shipwreck-year in Germany," as he has called it, he was invited back to Göttingen on honourable terms—the liberal constitution having been restored. He gladly accepted the invitation. In 1862-1863 he took an active part in a movement for reform within the Hanoverian Church, and he was a member of the synod which passed the new constitution. He had an important share also in the formation of the Protestantverein, or Protestant association, in September 1863. But the chief crisis in his life arose out of the political events of 1866. His loyalty to King George (son of Ernst August) would not permit him to take the oath of allegiance to the victorious king of Prussia, and he was therefore placed on the retired list, though with the full amount of his salary as pension. Perhaps even this degree of severity might have been held by the Prussian authorities to be unnecessary, had Ewald been less exasperating in his language. The violent tone of some of his printed manifestoes about this time, especially of his *Lob des Königs u. des Volkes*, led to his being deprived of the *venia legendi* (1868) and also to a criminal process, which, however, resulted in his acquittal (May 1869). Then, and on two subsequent occasions, he was returned by the city of Hanover as a member of the North German and German parliaments. In June 1874 he was found guilty of a libel on Prince Bismarck, whom he had compared to Frederick II. in "his unrighteous war with Austria and his ruination of religion and morality," to Napoleon III. in his way of "picking out the best time possible for robbery and plunder." For this offence he was sentenced to undergo three weeks' imprisonment. He died in his 72nd year of heart disease on the 4th of May 1875.

Ewald was no common man. In his public life he displayed many noble characteristics,—perfect simplicity and sincerity, intense moral earnestness, sturdy independence, absolute

fearlessness. As a teacher he had a remarkable power of kindling enthusiasm; and he sent out many distinguished pupils, among whom may be mentioned Hitzig, Schrader, Nöldeke, Diestel and Dillmann. His disciples were not all of one school, but many eminent scholars who apparently have been untouched by his influence have in fact developed some of the many ideas which he suggested. His numerous writings, from 1823 onwards, were the reservoirs in which the entire energy of a life was stored. His *Hebrew Grammar* inaugurated a new era in biblical philology. All subsequent works in that department have been avowedly based on his, and to him will always belong the honour of having been, as Hitzig has called him, "the second founder of the science of the Hebrew language." As an exegete and biblical critic no less than as a grammarian he has left his abiding mark. His *Geschichte des Volkes Israel*, the result of thirty years' labour, was epoch-making in that branch of research. While in every line it bears the marks of intense individuality, it is at the same time a product highly characteristic of the age, and even of the decade, in which it appeared. If it is obviously the outcome of immense learning on the part of its author, it is no less manifestly the result of the speculations and researches of many laborious predecessors in all departments of history, theology and philosophy. Taking up the idea of a divine education of the human race, which Lessing and Herder had made so familiar to the modern mind, and firmly believing that to each of the leading nations of antiquity a special task had been providentially assigned, Ewald felt no difficulty about Israel's place in universal history, or about the problem which that race had been called upon to solve. The history of Israel, according to him, is simply the history of the manner in which the one true religion really and truly came into the possession of mankind. Other nations, indeed, had attempted the highest problems in religion; but Israel alone, in the providence of God, had succeeded, for Israel alone had been inspired. Such is the supreme meaning of that national history which began with the exodus and culminated (at the same time virtually terminating) in the appearing of Christ. The historical interval that separated these two events is treated as naturally dividing itself into three great periods,—those of Moses, David and Ezra. The periods are externally indicated by the successive names by which the chosen people were called—Hebrews, Israelites, Jews. The events prior to the exodus are relegated by Ewald to a preliminary chapter of primitive history; and the events of the apostolic and post-apostolic age are treated as a kind of appendix. The entire construction of the history is based, as has already been said, on a critical examination and chronological arrangement of the available documents. So far as the results of criticism are still uncertain with regard to the age and authorship of any of these, Ewald's conclusions must of course be regarded as unsatisfactory. But his work remains a storehouse of learning and is increasingly recognized as a work of rare genius.

Of his works the more important are:—*Die Composition der Genesis kritisch untersucht* (1823), an acute and able attempt to account for the use of the two names of God without recourse to the document-hypothesis; he was not himself, however, permanently convinced by it; *De metris carminum Arabicorum* (1825); *Das Hohelied Salomo's übersetzt u. erklärt* (1826; 3rd ed., 1866); *Kritische Grammatik der hebr. Sprache* (1827)—this afterwards became the *Ausführliches Lehrbuch der hebr. Sprache* (8th ed., 1870); and it was followed by the *Hebr. Sprachlehre für Anfänger* (4th ed., 1874); *Über einige ältere Sanskritmetra* (1827); *Liber Vakedii de Mesopotamia expugnatae historia* (1827); *Commentarius in Apocalypsin Johannis* (1828); *Abhandlungen zur biblischen u. orientalischen Literatur* (1832); *Grammatica critica linguae Arabicae* (1831-1833); *Die poetischen Bücher des alten Bundes* (1835-1837, 3rd ed., 1866-1867); *Die Propheten des alten Bundes* (1840-1841, 2nd ed., 1867-1868); *Geschichte des Volkes Israel* (1843-1859, 3rd ed., 1864-1868); *Allenhümer Israels* (1848); *Die drei ersten Evangelien übersetzt u. erklärt* (1850); *Über das äthiopische Buch Henoch* (1854); *Die Sendschreiben des Apostels Paulus übersetzt u. erklärt* (1857); *Die Johanneischen Schriften übersetzt u. erklärt* (1861-1862); *Über das vierte Esrabuch* (1863); *Sieben Sendschreiben des neuen Bundes* (1870); *Das Sendschreiben an die Hebräer u. Jakobos' Rundschreiben* (1870); *Die Lehre der Bibel von Gott, oder Theologie des alten u. neuen Bundes* (1871-1875). The *Jahrbücher der biblischen Wissenschaft* (1849-1865) were edited, and for the most part written, by him. He was the chief promoter of the *Zeitschrift für die Kunde des*

Morgenlandes, begun in 1837; and he frequently contributed on various subjects to the *Götting. gelehrte Anzeigen*. He was also the author of many pamphlets of an occasional character.

The following have been translated into English:—*Hebrew Grammar*, by John Nicholson (from 2nd German edition) (London 1836); *Introductory Hebrew Grammar* (from 3rd German edition) (London, 1870); *History of Israel*, 5 vols. (corresponding to vols. i-iv. of the German), by Russell Martineau and J. Estlin Carpenter (London, 1867-1874); *Antiquities of Israel*, by H. S. Solly (London, 1876); *Commentary on the Prophets of the Old Testament*, by J. Frederick Smith (2 vols., London, 1876-1877); *Isaiah the Prophet*, chaps. i.-xxxiii., by O. Glover (London, 1869); *Life of Jesus Christ*, also by O. Glover (London, 1865).

See the article in Herzog-Hauck; T. Witton Davies, *Heinrich Ewald* (1903); and cf. T. K. Cheyne, *Founders of Old Testament Criticism* (1893); F. Lichtenberger, *History of German Theology in the Nineteenth Century* (1889).

EWALD, JOHANNES (1743-1781), the greatest lyrical poet of Denmark, was the son of a melancholy and sickly chaplain at Copenhagen, where he was born on the 18th of November 1743. At the age of eleven he was sent to school at Schleswig, his father's birthplace, and returned to the capital only to enter the university in 1758. His father was by that time dead, and in his mother, a frivolous and foolish woman, he found neither sympathy nor moral support. At fifteen he fell passionately in love with Arene Hulegaard, a girl whose father afterwards married the poet's mother; and the romantic boy resolved on various modes of making himself admired by the young lady. He began to learn Abyssinian, for the purpose of going out as a missionary to Africa, but this scheme was soon given up, and he persuaded a brother, four years older than himself, to run away that they might enlist as hussars in the Prussian army. They managed to reach Hamburg just when the Seven Years' War was commencing and were allowed to enter a regiment. But the elder brother soon got tired and ran away, while the poet, after a series of extraordinary adventures, deserted to the Austrian army, where from being drummer he rose to being sergeant, and was only not made an officer because he was a Protestant. In 1760 he was weary of a soldier's life and deserted again, getting safe back to Denmark. For the next two years he worked with great diligence at the university, but the Arene for whom he had gone through so much hardship and taken so much pains married another man almost immediately after Ewald's final and very successful examination. The disappointment was one from which he never recovered, but his own weakness of will was largely to blame for it. He plunged into dissipation of every kind, and gave his serious thoughts only to poetry.

In 1763 his first work, a perfunctory dissertation, *De pyrologia sacra*, first saw the light. In 1764 he made a considerable success with a short prose story in the popular manner of Sneedorf, *Lykkens Tempel* (The Temple of Fortune), which was translated into German and Icelandic. On the death of Frederick V., however, Ewald first appeared prominently as a poet; he published in 1766 three *Elegies* over the dead king, which were received with universal acclamation, and of which one, at least, is a veritable masterpiece. But his dramatic poem *Adam og Eva* (Adam and Eve), by far the finest imaginative work produced in Denmark up to that time, was rejected by the Society of Arts in 1767 and was not published until 1769. At the latter date, however, its merits were perceived. In 1770 Ewald attained success with *Philet*, a narrative and lyrical poem, and still more with his splendid *Rolf Krage*, the first original Danish tragedy. For the next ten years Ewald was occupied in producing one brilliant poetical work after another, in rapid succession. In 1771 he published *De brutale Klappers* (The Brutal Clappers), a tragic-comedy or parody satirizing the dispute then raging between the critics and the manager of the Royal Theatre; in 1772 he translated from the German the lyrical drama of *Philemon and Baucis*, and brought out his versified comedy of *Harlequin Patriot*, a satire on the passion for political scribbling created by Struensee's introduction of the liberty of the press. In 1773 he published *Pebersvendene* (Old Bachelors), a prose comedy. In 1771 he had already collected some of his lyrical poems under the title of *Adskilligt af Johannes Ewald* (Miscellanies). In 1774

appeared the heroic opera of *Balder's Død* (Balder's Death), and in 1779 the finest of his works, the lyrical drama *Fiskerne* (The Fishers), which contains the Danish National Song, "King Christian stood by the high Mast," his most famous lyric. In the two poems last mentioned, however, Ewald passed beyond contemporary taste, and these great works, the pride of Danish literature, were coldly received. But while the new poetry was slowly winning its way into popular esteem, the poet did not lack admirers, and at the head of these he founded in 1775 the Danish Literary Society, a body which became influential, and which made the study of Ewald a cultus. But the poet's health had broken; when he was writing *Rolf Krage* he was already an inmate of the consumptive hospital, and when he seemed to be recovering, his health was shattered again by a night spent in the frosty streets. He embittered his existence by the recklessness of his private life, and finally, through a fall from a horse, he ended by becoming a complete invalid. His last ten years were full of acute suffering; his mother treated him with cruelty, his family with neglect, and but few even of his friends showed any manliness or generosity towards him. In 1774 he was placed in the house of an inspector of fisheries at Rungsted, where Anna Hedevig Jacobsen, the daughter of the house, tended the wasted poet with infinite tenderness and skill. He stayed in this house for three years, and wrote there some of his finest later lyrics. Meanwhile he had fallen deeply in love with the charming solace of his sufferings and won her consent to a marriage. This step, however, was prevented by his family, who roughly removed him to their own keeping near Kronborg. Here he was treated so infamously that he insisted on being taken back to Copenhagen in 1777, where he found an older, but no less tender nurse, in Ane Kirstine Skou. Here he wrote *Fiskerne* with his imagination full of the familiar shore at Hornbaek, near Rungsted. In 1780 he was a little better, and managed to be present at the theatre at the first performance of his poem. But this excitement hastened his end, and after months of extreme agony he died on the 17th of March 1781, and was carried to the grave by a large assembly of his admirers, since he was now just recognized by the public for the first time as the greatest national poet. Among his papers were found fragments of three dramas, two on old Scandinavian subjects, entitled *Frode* and *Helgo*, and the third a tragedy on the story of *Hamlet*, which he meant to treat in a way wholly distinct from Shakespeare's.

Ewald belongs to the race of poetical reformers who appeared in all countries of Europe at the end of the 18th century; but it is interesting to observe that in point of time he preceded all of them. He was born six years earlier than Goethe and Alfieri, sixteen years before Schiller, nine years before André Chénier, and twenty-seven years earlier than Wordsworth, but he did for Denmark what each of these poets did for his own country. Ewald found Danish literature given over to tasteless rhetoric, and without art or vigour. He introduced vivacity of style, freshness and brevity of form, and an imaginative study of nature which was then unprecedented. But perhaps his greatest claim to notice is the fact that he was the first person to call the attention of the Scandinavian peoples to the treasures of their ancient history and mythology, and to suggest the use of these in imaginative writing. With a colouring more distinctly modern than that of Collins and Gray, his lyrics yet resemble the odes of these his English contemporaries more closely than those of any continental poet; from another point of view his ballads remind us of those of Schiller, which they preceded. His dramas, which had an immense influence on the Danish stage, are now chiefly of antiquarian interest, with the exception of "The Fishers," a work that must always live as a great national poem. In personal character and in fate Ewald seems to have been not unlike Heinrich Heine.

The first collected edition of Ewald's works began to appear in his lifetime. It is in four volumes, 1780-1784. His works have constantly been reprinted, but the standard edition is that by Liebenberg, in 8 vols., 1850-1855. The best biographies of him are those by C. Molbech (1831), Hammerich (1860) and Andreas Dølleris (1900). (E. G.)

EWART, WILLIAM (1798-1869), English politician, was born in Liverpool on the 1st of May 1798. He was educated at Eton and Christ Church, Oxford, gaining the Newdigate prize for English verse. He was called to the bar at the Middle Temple in 1827, and the next year entered parliament for the borough of Bletchingley in Surrey. He subsequently sat for Liverpool from 1830 to 1837, for Wigan in 1839, and for Dumfries Burghs from 1841 until his retirement from public life in 1868. He died at Broadleas, near Devizes, on the 23rd of January 1869. Ewart, who was an advanced liberal in politics, was responsible during his long political career for many useful measures. In 1834 he carried a bill for the abolition of hanging in chains, and in 1837 he was successful in getting an act passed for abolishing capital punishment for cattle-stealing and other offences. In 1850 he carried a bill for establishing free libraries supported out of the rates, and in 1864 he was instrumental in getting an act passed for legalizing the use of the metric system of weights and measures. He was always a strong advocate for the abolition of capital punishment, and on his motion in 1864 a select committee was appointed to consider the subject. Other reforms which he advocated and which have since been carried out were an annual statement on education, and the examination of candidates for the civil service and army.

EWÉ, a group of Negro peoples of the Slave Coast, West Africa. By the natives their country is called *Ewé-me*, "Land of the Ewé." The Ewé family forms five linguistic groups: the Anlo or Anglawa on the Gold Coast frontier, the Krepi of Anfueh speech, the Jeji, the Dahomeyans and the Mahi.

See further DAHOMEY, and A. B. Ellis, *The Ewé-Speaking Peoples of the Slave Coast* . . . (London, 1890).

EWELL, RICHARD STODDERT (1817-1872), American soldier, lieutenant-general in the Confederate army, was born in Georgetown, now a part of Washington, D.C., on the 2nd of February 1817, and graduated at West Point in 1840. As a cavalry officer he saw much active service in the Mexican War and later in Indian warfare in New Mexico. He resigned his commission at the outbreak of the Civil War, and entered the Confederate service. He commanded a brigade in the first Bull Run campaign, and a division in the famous Valley Campaign of "Stonewall" Jackson, to whom he was next in rank. At Cross Keys he was in command of the forces which defeated General Frémont. Ewell's division served with Jackson in the Seven Days and in the campaign of Second Bull Run. At the action of Groveton Ewell lost a leg, but did not on that account retire from active service, though other generals led his men in the sanguinary battles of Antietam (where they lost 47% of their numbers) and Fredericksburg. After the death of "Stonewall" Jackson, Ewell was promoted lieutenant-general and appointed to command the 2nd Corps, with which he had served from the beginning of the Valley Campaign. His promotion set aside General J. E. B. Stuart, the temporary commander of Jackson's corps; that Ewell, crippled as he was, was preferred to the brilliant cavalry leader was a marked testimony to his sterling qualities as a soldier. The invasion of Pennsylvania soon followed, Ewell's corps leading the advance of Lee's army. A federal force was skillfully cut off and destroyed near Winchester, Va., and Ewell's corps then raided Maryland and southern Pennsylvania unchecked. At the battle of Gettysburg, the 2nd Corps decided the fighting of the first day in favour of the Confederates, driving the enemy before them; on the second day it fought a desperate action on Lee's left wing. Ewell took part in the closing operations of 1863 and in all the battles of the Wilderness and Petersburg campaigns. In the final campaign of 1865 he and the remnant of his corps were cut off and forced to surrender at Sailor's Creek, a few days before his chief capitulated to Grant at Appomattox. After the war General Ewell lived in retirement. He died near Spring Hill, Maury County, Tennessee, on the 25th of January 1872.

EWING, ALEXANDER (1814-1873), Scottish divine, was born of an old Highland family in Aberdeen on the 25th of March 1814. In October 1838 he was admitted to deacon's orders, and after his return from Italy he took charge of the

episcopal congregation at Forres, and was ordained a presbyter in the autumn of 1841. In 1846 he was elected first bishop of the newly restored diocese of Argyll and the Isles, the duties of which position he discharged till his death on the 22nd of May 1873. In 1851 he received the degree of D.C.L. from the university of Oxford. Though hampered by a delicate bodily constitution, he worked in a spirit of buoyant cheerfulness. By the charm of his personal manner and his catholic sympathies he gradually attained a prominent position. In theological discussion he contended for the exercise of a wide tolerance, and attached little importance to ecclesiastical authority and organization. His own theological position had close affinity with that of Thomas Erskine of Linlathen and Frederick Denison Maurice; but his opinions were the fruit of his own meditation, and were coloured by his own individuality. The trend of his teaching is only to be gathered from fragmentary publications—letters to the newspapers, pamphlets, special sermons, essays contributed to the series of *Present Day Papers*, of which he was the editor, and a volume of sermons entitled *Revelation considered as Light*.

Besides his strictly theological writings, Ewing was the author of the *Cathedral or Abbey Church of Iona* (1865), the first part of which contains drawings and descriptive letterpress of the ruins, and the second a history of the early Celtic church and the mission of St Columba. See *Memoir of Alexander Ewing, D.C.L.*, by A. J. Ross (1877).

EWING, JULIANA HORATIA ORR (1841-1885), English writer of books for children, daughter of the Rev. Alfred Gatty and of Margaret Gatty (*q.v.*), was born at Ecclesfield, Yorkshire, in 1841. One of a large family, she was accustomed to act as nursery story-teller to her brothers and sisters, and her brother Alfred Scott Gatty provided music to accompany her plays. She was well educated in classics and modern languages, and at an early age began to publish verses, being a contributor to *Aunt Judy's Magazine*, which her mother started in 1866. *The Land of Lost Toys* and many other of Juliana's stories appeared in this magazine. In 1867 she married Major Alexander Ewing, himself an author, and the composer of the well-known hymn "Jerusalem the Golden." From this time until her death (13th May 1885), previously to which she had been a constant invalid, Mrs Ewing produced a number of charming children's stories. The best of these are: *The Brownies* (1870), *A Flat-Iron for a Farthing* (1873), *Lob-lie-by the Fire* (1874), *The Story of a Short Life* (1885) and *Jackanapes* (1884), the two last-named, in particular, obtaining great success; among others may be mentioned *Mrs Over-the-Way's Remembrances* (1869), *Six to Sixteen, Jan of the Windmill* (1876), *A Great Emergency* (1877), *We and the World* (1881), *Old-Fashioned Fairy Tales, Brothers of Pity* (1882), *The Doll's Wash, Master Fritz, Our Garden, A Soldier's Children, Three Little Nest-Birds, A Week Spent in a Glass-House, A Sweet Little Dear, and Blue-Red* (1883). Many of these were published by the S.P.C.K. Simple and unaffected in style, and sound and wholesome in matter, with quiet touches of humour and bright sketches of scenery and character, Mrs Ewing's best stories have never been surpassed in the style of literature to which they belong.

EWING, THOMAS (1789-1871), American lawyer and statesman, was born near the present West Liberty, West Virginia, on the 28th of December 1789. His father, George Ewing, settled at Lancaster, Fairfield county, Ohio, in 1792. Thomas graduated at Ohio University, Athens, Ohio, in 1815, and in August 1816 was admitted to the bar at Lancaster, where he won high rank as an advocate. He was a Whig member of the United States senate in 1831-1837, and as such took a prominent part in the legislative struggle over the United States Bank, whose re-chartering he favoured and which he resolutely defended against President Jackson's attack, opposing in able speeches the withdrawal of deposits and Secretary Woodbury's "Specie Circular" of 1836. In March 1841 he became secretary of the treasury in President W. H. Harrison's cabinet. When, however, after President Tyler's accession, the relations between the President and the Whig Party became strained, he retired (September 1841) and was succeeded by Walter Forward (1786-1852).

Subsequently from March 1849 to July 1850 he was a member of President Taylor's cabinet as the first secretary of the newly established department of the interior. He thoroughly organized the department, and in his able annual report advocated the construction by government aid of a railroad to the Pacific Coast. In 1850-1851 he filled the unexpired term of Thomas Corwin in the U.S. Senate, strenuously opposing Clay's compromise measures and advocating the abolition of slavery in the District of Columbia. He was subsequently a delegate to the Peace Congress in 1861, and was a loyal supporter of President Lincoln's war policy. He died at Lancaster, Ohio, on the 26th of October 1871.

His daughter was the wife of General William T. Sherman. His son, Hugh Boyle Ewing (1826-1905), served throughout the Civil War in the Federal armies, rising from the rank of colonel (1861) to that of brigadier-general (1862) and brevet major-general (1865), and commanding brigades at Antietam and Vicksburg and a division at Chickamauga; and was minister of the United States to the Netherlands in 1866-1870. Another son, Thomas Ewing (1829-1896), studied at Brown University in 1852-1854 (in 1894, by a special vote, he was placed on the list of graduates in the class of 1856); he was a lawyer and a free-state politician in Kansas in 1857-1861, and was the first chief-justice of the Kansas supreme court (1861-1862). In the Civil War he attained the rank of brigadier-general (March 1863) and received the brevet of major-general (1865). He was subsequently a representative in Congress from Ohio in 1877-1881; and from 1882 to 1896 practised law in New York City, where he was long one of the recognized leaders of the bar.

EXAMINATIONS. The term "examination" (*i.e.* inspecting, weighing and testing; from Lat. *examen*, the tongue of a balance) is used in the following article to denote a systematic test of knowledge, and of either special or general capacity or fitness, carried out under the authority of some public body.

1. *History.*—The oldest known system of examinations in history is that used in China for the selection of officers for the public service (*c.* 1115 B.C.), and the periodic tests which they undergo after entry (*c.* 2200 B.C.). See CHINA; also W. A. P. Martin, *The Lore of Cathay* (1901), p. 311 et seq.; T. L. Bullock, "Competitive Examinations in China" (*Nineteenth Century*, July 1894); and Étienne Zi, *Pratique des examens littéraires en Chine* (Shanghai, 1894). The abolition of this system was announced in 1906, and, as a partial substitute, it was decided to hold an annual examination in Peking of Chinese graduates educated abroad (*Times*, 22nd of October 1906).

The majority of examinations in western countries are derived from the university examinations of the middle ages. The first universities of Europe consisted of corporations of teachers and of students analogous to the trade guilds and merchant guilds of the time. In the trade guilds there were apprentices, companions, and masters. No one was admitted to mastership until he had served his apprenticeship (*q.v.*), nor, as a rule, until he had shown that he could accomplish a piece of work to the satisfaction of the gild.

The object of the universities was to teach; and to the three classes established by the gild correspond roughly the *scholar*, the *bachelor* or pupil-teacher (see Rashdall i. 209, note 2, and 221, note 5), and the *master* or *doctor* (two terms at first equivalent) who, having served his apprenticeship and passed a definite technical test, had received permission to teach. The early universities of Europe, being under the same religious authority and animated by the same philosophy, resembled each other very closely in curriculum and general organization and examinations, and by the authority of the emperor, or of the pope in most cases, the permission to teach granted by one university was valid in all (*ius ubicunque docendi*).

The earliest university examinations of which a description is available are those in civil and in canon law held at Bologna at a period subsequent to 1219. The student was admitted without examination as bachelor after from four to six years' study, and after from six to eight years' study became qualified as a candidate for the doctorate. He might obtain

the doctorate in both branches of law in ten years (Rashdall i. 221-222).

The doctoral examination at Bologna in the 13th-14th centuries consisted of two parts—a private examination which was the real test, and a public one of a ceremonial character (*conventus*). The candidate first took an "oath that he had complied with all the statutable conditions, that he would give no more than the statutable fees or entertainments to the rector himself, the doctor or his fellow-students, and that he would obey the rector." He was then presented to the archdeacon of Bologna by one or more doctors, who were required to have satisfied themselves of his fitness by private examination. On the morning of the examination, after attending mass, he was assigned by one of the doctors of the assembled college two passages (*puncta*) in the civil or canon law, which he retired to his house to study, possibly with the assistance of the presenting doctor. Later in the day he gave a lecture on, or exposition of, the prepared passages, and was examined on them by two of the doctors appointed by the college. Other doctors might then put supplementary questions on law arising out of the passages, or might suggest objections to his answers. The vote of the doctors present was taken by ballot, and the fate of the candidate was determined by the majority. The successful candidate, who received the title of licentiate, was, on payment of a heavy fee and other expenses, permitted to proceed to the *conventus* or final public examination. This consisted in the delivery of a speech and the defence of a thesis on some point of law, selected by the candidate, against opponents selected from among the students. The successful candidate received from the archdeacon the formal "licence to teach" by the authority of the pope in the name of the Trinity, and was invested with the insignia of office. At Bologna, though not at Paris, the "permission to teach" soon became fictitious, only a small number of doctors being allowed to exercise the right of teaching in that university (Rashdall).

In the faculty of arts of Paris, towards the end of the 13th century, the system was already more complicated than at Bologna. The baccalaureate, licentiate, and mastership formed three distinct degrees. For admission to the baccalaureate a preliminary test or "Responsions" was first required, at which the candidate had to dispute in grammar or logic with a master. The examiners then inspected the certificates (*schedulae*) of residence and of having attended lectures in the prescribed subjects, and examined him in the contents of his books. The successful candidate was admitted to maintain a thesis against an opponent, a process called "determination" (see Rashdall i. 443 et seq.), and as bachelor was then permitted to give "cursory" lectures. After five or six years from the date of beginning his studies (matriculation) and being twenty years of age (these conditions varied at different periods), a bachelor was permitted to present himself for the examination for the licentiate-ship, which was divided into two parts. The first part was conducted in private by the chancellor and four examiners (*templatores in cameris*), and included an inquiry into the candidate's residence, attendance at lectures, and performance of exercises, as well as examination in prescribed books; those candidates adjudged worthy were admitted to the more important examination before the faculty, and the names of successful candidates were sent to the chancellor in batches of eight or more at a time, arranged in order of merit. (The order of merit at the examination for the licentiate-ship existed in Paris till quite recently.) Each successful candidate was then required to maintain a thesis chosen by himself (*quodlibetica*) in St Julian's church, and was finally submitted to a purely formal public examination (*collatio*) at either the episcopal palace or the abbey of Ste Geneviève, before receiving from the chancellor, in the name of the Trinity, the licence to incept or begin to teach in the faculty of arts. After some six months more the licentiate took part "in a peculiarly solemn disputation known as his 'Vespers,'" then gave his formal inaugural lecture or disputation before the faculty, and was received into the faculty as master. This last process was called "inception."

In discussing the value of medieval examinations of the kind described, Paulsen (*The German Universities* (1906), p. 25) asserts that they were well adapted to increase a student's alertness, his power of comprehending new ideas, and his ability quickly and surely to assimilate them to his own, and that "they did more to enable [students] to grasp a subject than the mute and solitary reviewing and cramming of our modern examinations can possibly do." At their best they fulfilled precisely the technical purpose for which they were intended; they fully tested the capacity of the candidate to teach the subjects which he was required to teach in accordance with the methods which he was required to use. The limitations of the test were the limitations of the educational and philosophic ideals of the time, in which a dogmatic basis was presupposed to all knowledge and criticism was limited to the superstructure. At their worst, even with venal examiners (and additional fees were often offered as a bribe), Rashdall regards these examinations (at the end of the 13th century) as probably "less of a farce than the pass examinations of Oxford and Cambridge almost within the memory of persons now living." It is, however, to be pointed out that the standard in Paris and elsewhere at a later date became scandalously low in some cases. In some universities the sons of nobles were regularly excused certain examinations. At Cambridge in 1774 Fellow Commoners were examined with such precipitation to fulfil the formal requirements of the statutes that the ceremony was termed "huddling for a degree" (Jebb, *Remarks upon the Present Mode of Education in the University of Cambridge*, 4th ed., 1774, p. 32). The last privileges of this kind were abolished at Cambridge by a grace passed on the 20th of March 1884.

In the medieval examinations described above we find most of the elements of our present examinations: certificates of previous study and good conduct, preparation of set-books, questioning on subjects not specially prepared, division of examinations into various parts, classification in order of merit, payment of fees, the presentation of a dissertation, and the defence and publication of a thesis (a term of which the meaning has now become extended).

The requirement to write answers to questions written or dictated, to satisfy a practical test (other than in teaching), and a clinical test in medicine, appear to be of later date.¹ The medieval candidate for the doctorate in medicine, although required to have attended practice before presenting himself, discussed as his thesis a purely theoretical question, often semi-theological in character, of which as an extreme example may be quoted "whether Adam had a navel."

The competitive system was developed considerably at Louvain, and in the 15th century the candidates for the master-ship of arts were divided into three classes (*rigorosi*, honour-men; *transibiles*, pass-men; *gratiosi*, charity-passes), while a fourth, which was not published, contained the names of those who failed. In the 17th century the first class comprised the names of twelve, and the second, of twenty-four, candidates, who were divided on the report of their teachers into classes before the examination, and finally arranged in order of merit by the examiners (Vernulaeus, quoted by Sir W. Hamilton, *Discussions*, 1852; p. 647; Rashdall, *loc. cit.* ii. 262). At the Cambridge tripos (as described by Jebb in 1774, *Remarks*, &c., pp. 20-31) the first twenty-four candidates were also selected by a preliminary test; they were then divided further into "wranglers" (the disputants, *par excellence*) and *Senior Optimes*, the next twelve on the list being called the *Junior Optimes*. These names have in the mathematics tripos survived the procedure. (The name *Tripos* is derived from the three-legged stool on which "an old bachelour," selected for the purpose, sat during his disputation with the senior bachelor of the year, who was required to propound two questions to him.)

¹ W. W. Rouse Ball in his *History of the Study of Mathematics at Cambridge* (1889), p. 193, states that he can find no record of any European examinations by means of written papers earlier than those introduced by R. Bentley at Trinity College, Cambridge, in 1702.

The subjects in which the medieval universities examined were (i.) those of the trivium and quadrivium in the faculty of arts; (ii.) theology; (iii.) medicine; and (iv.) civil and canon law. The number of subjects in which examinations are held has since grown immensely. We can only sketch in outline the transformations of certain typical university systems of examinations.

At Oxford there is no record of a process of formal examination on books similar to that of Paris (Rashdall, ii. 442 et seq.), disputations being apparently the only test applied in its early history. Examinations were definitely introduced for the B.A. and M.A. degrees by Laud in 1636-1638 (Brodrick, *History of Oxford*, p. 114), but the standard prescribed was so much beyond the actual requirements of later times that it may be doubted if it was enforced. The studies fell in the 18th century into an "abject state," from which they were first raised by a statute passed in 1800 (*Report of Oxford University Commission of 1850-1852*, p. 60 et seq.), under which distinctions were first allotted to the ablest candidates for the bachelor's degree. Further changes were made in 1807 and 1825; and in 1830 a distinction was made between honours examinations of a more difficult character, at which successful candidates were divided into four classes, and pass examinations of an easier character. By the statutes of 1849 and 1858 an intermediate "Moderations" examination was instituted between the preliminary examination called "Responsions" and the final examination. Since 1850, although fresh subjects of examination have been introduced, no considerable change of system has been made.

The bachelor's degree at Oxford tended from an early period to be postponed to an advanced stage of studies, while the requirements for the master's degree diminished until, in 1807, the examination for the M.A. was abolished. It is now awarded to bachelors of three years' standing on payment of a fee.

Cambridge in early times followed the example of Oxford, and here also the bachelor's degree became more and more important (Bass Mullinger, *History of the University of Cambridge from 1535*. . . , p. 414), and the M.A. has been finally reduced to a mere formality, awarded on terms similar to those of the sister university. The standard of examinations was raised in Cambridge at an earlier date than at Oxford, and in the 18th century the tripos "established the reputation of Cambridge as a School of Mathematical Science." The school, however, produced few, if any, great mathematicians between Newton and George Green. It was only between 1830 and 1840 that the standard of the tripos became a high one. At Cambridge there is no intermediate examination between the "Previous Examination" (commonly called "Little-go"), which corresponds to Oxford "Responsions" or "Smalls" and the triposes and examinations for the "Poll" degree, which correspond to the Oxford final honours and pass examinations respectively. But most of the triposes have been divided into two parts, of which the second is not obligatory in order to obtain a degree. The "senior wrangler" was the first candidate in order of merit in the first part of the mathematical tripos. The abolition of order of merit at this examination was decided on in 1906, and names of candidates appeared in this order for the last time in 1909.

At the Scottish universities the B.A. degree has become extinct, and the M.A., awarded on the results of examination, is the first degree in the faculty of arts.

The incorporation of the university of London in 1836 marks an era in the history of examinations; the teaching and examining functions of a university were dissociated for the first time. Until 1858 the London examinations were open only to students in affiliated colleges, and the teachers had no share in the appointment of the examiners or in determining the curricula for examinations; in 1858 the examinations were thrown open to all comers, and no requirements were insisted on with regard to courses of study except for degrees in the faculty of medicine. The sole function of the university was to examine, and its examinations for matriculation and for degrees in arts and science were carried on by means of written papers not only in London but in many centres in the United Kingdom and the colonies. From the

first the degrees were (unlike those of Oxford and Cambridge until 1871) open to all male persons without religious distinctions; and in 1878 they were opened to women. (Tripos examinations were thrown open to women at Cambridge by the grace of 24th Feb. 1881, and at Oxford women were admitted to examinations for honours by statute of 29th April 1884. Proposals to admit women to university degrees were rejected by Oxford and Cambridge in 1896 and 1897 respectively.)

The standard of difficulty set by the university of London was a high one, very much higher for its pass degrees than the corresponding standards at Oxford and Cambridge, while the standard for honours was equally high. In medicine the examinations were made both wider in range and more searching than those of any other examining body. But, for reasons dealt with below, great discontent was roused by the new system. In 1880 the Victoria University, Manchester, was established, in which teaching and examining were again united; and in the universities since established, with the exception of the Royal University of Ireland (which was created in 1880 as an examining body on the model of London, but which was dissolved under the Irish Universities Act 1908, and replaced by the National University of Ireland and the Queen's University of Belfast), the precedent of Victoria has been followed. By an act passed in 1898, of which the provisions came into force in 1900, the university of London was reconstituted as a teaching university, although provision was made for the continuance of the system of examinations by "external examiners" for "external students," together with "internal examinations" for "internal students," in which the teachers and the external examiners of the university are associated. The examinations in music and the final examinations in law and medicine are carried on [1910] both for "internal" and "external" students by "external" examiners only, who are, however, appointed on the recommendation of boards of studies consisting mainly of London teachers.

At the university of Dublin, examinations have been maintained both for the B.A. and M.A. degrees, and students may be admitted to the examinations in subjects other than divinity, law, medicine, and engineering without attendance at university courses.

The examinations of the newer universities, the Victoria University of Manchester, Birmingham, Liverpool, Leeds, Sheffield and Wales, are open only to students at these universities, and are conducted by the teachers in association with one or more external examiners for each subject. In some universities, e.g. Manchester, the M.A. degree is given after examination to students who have taken a pass, and without examination to those who have taken an honours degree.

The universities which have departed furthest from the medieval system of examinations, at any rate in appearance, are those of Germany. The baccalaureate has disappeared, but students cannot be matriculated without having passed the *Abiturienten-examen* (see below), probably the most severe of all entrance examinations (foreign students may be exempted under certain conditions). The student desiring to proceed to the doctorate is free from examinations thereafter until he presents his thesis for the doctor's degree,¹ when, if it is accepted, he is submitted to a public oral examination not only in his principal subject (*Hauptfach*), but also as a rule in two or more collateral subjects (*Nebenfächer*). The doctor's degree does not give the right to teach in a faculty (*venia legendi*). To acquire this a doctor must present a further thesis (*Habilitationschrift*), and must deliver two lectures, one before the faculty, followed by a discussion (*colloquium*), the other in public; but these lectures "seem to be merely secondary and are tending to become so more and more"; "scientific productiveness is so sharply emphasized among the conditions for admission that it overshadows all the rest" (Paulsen, *loc. cit.* p. 165).

¹ It should be mentioned that the professors of chemistry of a number of German, Austrian and Swiss universities, have, by agreement, instituted an intermediate examination in that subject which students are required to pass before beginning work on the doctoral thesis. The examination of the students is conducted by the teachers concerned.

In France the examination for the baccalaureate, though conducted in part by university examiners, has become a school-leaving examination (see below). The licentiate-ship has been preserved in the faculties of arts, science and laws, and is in point of difficulty about equal to the pass degree examinations of the university of London, though differing in the nature of the tests. In the faculty of sciences, the three subjects of examination selected may, under a recent regulation, be taken separately. Until a few years ago the successful candidates at the licentiate-ship were arranged in order of merit. For the doctorate in the faculty of letters two theses must be submitted, of which the subject and plan must be approved by the faculty (until recently one of them was required to be written in Latin). Permission to print the theses is given by the rector or vice-rector after report from one or more professors, and they are then discussed publicly by the faculty and the candidate (*soutenance de thèse*). In this public discussion the "disputation" of the middle ages survives in its least changed form. The literary theses required by French universities are, as a rule, volumes of several hundred pages, and more important in character even than the German *Habilitationschrift*. The possession of the doctorate is a *sine qua non* for eligibility to a university chair, and to a lectureship in the university of Paris.

In the faculty of sciences a candidate for the doctorate may submit two theses, or else submit one thesis and undergo an oral examination.

For the doctorate in law, a thesis and two oral examinations are required.

In the faculty of medicine there is no licentiate-ship, but for the doctorate six examinations must be passed and a thesis submitted.

There is also a special doctorate, the "*doctorat d'Université*," awarded on a thesis and an oral examination; and there are diplomas (*Diplômes d'Études supérieures*) awarded on dissertations and examinations on subjects in philosophy, history and geography, classics or modern languages, selected mainly by the candidate and approved by the faculty.

2. *Professional Examinations.* (a) *Teaching.*—University examinations for degrees having ceased to be used as technical tests of teaching capacity, new examinations have been devised for this purpose. The test for German university teachers has been described above. For secondary teachers, W. von Humboldt instituted a special examination in 1810 (Paulsen, *Gesch. des gelehrten Unterrichts*, ii. pp. 283 and 393), and an examination for primary teachers was instituted in Prussia in 1794.

In France there is a competitive examination for secondary teachers, the *agrégation*, originally established in 1766. *Agrégés* have a right to state employment and they alone can occupy the highest teaching post (*chaire de professeur*) in a state secondary school, other posts being open to licentiates. There are also examinations for primary teachers. The tests for teachers are different for the two sexes.

In England there is no obligatory test for secondary teachers. The universities and the College of Preceptors conduct examinations for teaching diplomas. The Board of Education holds special examinations (Preliminary Certificate examination and Certificate examination, &c.) for primary teachers.

(b) *Medicine.*—See MEDICAL EDUCATION.

(c) *Other Professions.*—A system of professional examinations carried on by professional bodies, in some cases with legal sanction, was developed in England during the 19th century. Those in the following subjects are the most important: Accountancy (Institute of Chartered Accountants and Society of Accountants and Auditors), actuarial work (Institute of Actuaries), music (Royal Academy of Music, Royal College of Music, Trinity College of Music, Royal College of Organists, and the Incorporated Society of Musicians), pharmacy (Pharmaceutical Society), plumbing (the Plumbers' Company), surveying (Surveyors' Institution), veterinary medicine (Royal College of Veterinary Surgeons), technical subjects, e.g. cotton-spinning, dyeing, motor-manufacture (City & Guilds of London Institute), architecture (Royal Institute of British Architects), commercial

subjects, shorthand (the Society of Arts and London Chamber of Commerce), engineering (Institutions of Civil Engineers, of Mechanical Engineers, and of Electrical Engineers).

3. *School-leaving Examinations.*—The faculty of arts in medieval universities covered secondary as well as higher education in the subjects concerned. The division in arts subjects between secondary and university education has been drawn at different levels in different countries. Thus the first two years of the arts curriculum in English and American universities correspond, roughly speaking, to the last two years spent in a secondary school of Germany or France, and the continental "school-leaving examinations" correspond to the intermediate examinations of the newer English universities and to the pass examinations for the degree at Oxford and Cambridge (Mark Pattison, *Suggestions on Academical Organization*, 1868, p. 238, and Matthew Arnold, *Higher Schools and Universities in Germany*, 1892, p. 209).

A tabular summary is given (see Tables I., II., III., IV.) of the requirements of the secondary school-leaving examinations of France, Prussia (for the nine-year secondary schools) and Scotland, and of the university of London.

There are in England a number of school examinations which, under prescribed conditions, also serve as school-leaving examinations, and give entrance to certain universities, especially the Oxford and Cambridge local examinations (both established in 1858), and the examinations of the Oxford and Cambridge "Joint Board." A movement to reduce the number of entrance examinations and to secure uniformity in their standard was set on foot in 1901. In that year the General Medical Council communicated to the Board of Education a memorial on the subject from the Headmasters' Conference. The memorial was further communicated to various professional bodies concerned. Conferences were held by the consultative committee of the Board of Education in 1903, with representatives of the universities, the Headmasters' Conference, the Association of Head-Masters, the Association of Head-Mistresses, the College of Preceptors, the Private Schools' Association, and with representatives of professional bodies. The committee were of opinion that a central board, consisting of representatives of the Board of Education and the different examining bodies, should be established, to co-ordinate and control the standards of [the examinations, and to secure interchangeability of certificates, &c., as soon as a sufficient number of such bodies signified their willingness to be represented on the board. They recommended that the examination should be conducted by external and internal examiners, representing in each case the examining body and the school staff respectively, and that reports on the school work of candidates should be available for reference by the examiners (circular of the Board of Education of 12th of July 1904).

The "accrediting" system in the United States was started by the university of Michigan in 1871. A school desiring to be accredited is submitted to inspection without previous notice. If the inspection is satisfactory, the school is accredited by a university for from one to three years, and upon the favourable report of its principal any of its students are admitted to the university by which it has been accredited without any entrance examination. In practice it is found that many students whom their teachers refuse to certify are able to pass the university entrance examination. The statistics of nine years show that the standard of the certified students is higher than that of non-certified students. Two hundred and fifty schools are accredited by the university of Michigan. In 1904 it was stated that the system was gaining favour in the east,¹ and that it had been adopted more or less by all the eastern colleges and universities with the exception of Harvard, Yale, Princeton and Columbia.

4. *Methods of Examination.*—Examinations may test (i.) knowledge, or, more exactly, the power of restating facts and arguments of a kind that may be learnt by rote; (ii.) the power

of doing something, e.g. of making a *précis* of a written document, of writing a letter or a report on a particular subject with a particular object in view, of translating from or into a foreign language, of solving a mathematical problem, of criticizing a passage from a literary work, of writing an essay on an historical or literary subject with the aid of books in a library, of diagnosing the malady of a patient, of analysing a chemical mixture or compound; and (the highest form under the rubric) of making an original contribution to learning or science as the result of personal investigation or experiment. Examinations are carried out at present by means of (1) written papers; (2) oral examinations; (3) practical, including in medicine clinical, tests; (4) theses; or a combination of these.

In written examinations the candidates are, as a rule, supplied with a number of printed questions, of which they must answer all, or a certain proportion, within a given time, varying, as a rule, from 1½ to 3 hours, the latter being the duration most generally adopted for higher examinations in England. Whereas in France and Germany the questions are generally few in number and require long answers, showing constructive skill and mastery of the mother-tongue on the part of the candidates, such "essay-papers" are comparatively rare in England. In many subjects, the written examinations test memory rather than capacity. It has been suggested that sets of questions to be answered in writing should as a rule be divided into two parts: (i.) a number of questions requiring short answers and intended to test the range of the candidate's knowledge; (ii.) questions requiring long answers, intended to test its depth, and the candidate's powers of co-ordination and reflection. A necessary condition for the application of the second kind of test is that time should be given for reflection and for rewriting, say one-third or one-quarter of the whole time allowed. A further distinction is important, especially in such subjects as mathematics or foreign languages, in which it is legitimate to ask what precise power on the part of a candidate the passing of an examination shall signify. Owing to a prevailing confusion between tests of memory and tests of capacity, the allowance for chance fairly applied to the former is apt to be unduly extended to the latter. In applying tests of memory, it may be legitimate to allow a candidate to pass who answers correctly from 30 to 50% of the questions; such an allowance if applied to a test of capacity, such as the performance of a sum in addition, the solution of triangles by means of trigonometrical tables, or the translation of an easy passage from a foreign language, appears to be irrational. A candidate who obtains only 50% of the marks in performing such operations cannot be regarded as being able to perform them; and, if the examination is to be treated as a test of his capacity to perform them, he should be rejected unless he obtains full marks, less a certain allowance (say 10, or at most 20%) in view of the more or less artificial conditions inherent in all examinations.

The oral examination is better suited than the written to discover the range of a candidate's knowledge; it also serves as a test of his powers of expression in his mother-tongue, or in a foreign language, and may be used (as in the examination for entrance to the Osborne Naval College) to test the important qualities (hardly tested in any other examinations at present), readiness of wit, common-sense and nerve. It may be objected that candidates are heavily handicapped by nervousness in oral examinations, but this objection does not afford sufficient ground for rejecting the test, provided that it is supplemented by others. Oral tests are used almost invariably in medical examinations; and there is a growing tendency to make them compulsory in dealing with modern languages. Oral examinations are much more used abroad than in England, where the pupils during their school years receive but little exercise in the art of consecutive speaking.

The laboratory examination may be used in subjects like physics, chemistry, geology, zoology, botany, anatomy, physiology, to test powers of manipulation and knowledge of experimental methods. In some cases (e.g. in certain honours

¹ See E. E. Brown in *Monographs on Education in the United States* (ed. by N. M. Butler, 1900, i. 164), and T. Gregory Foster and H. R. Reichel, *Report of Mosely Educational Commission* (1904), pp. 117-119 and 288-289.

EXAMINATIONS

TABLE I.—PRUSSIA: ABITURIENTEN EXAMEN

I. Name of Examination.	II. Minimum Age for Entry.	III. Length of Course of Study.	IV. Subjects.	V. Co-ordination with Teaching.	VI. Examiners.	VII. Nature of Examination and General Remarks.
<p><i>Abiturienten Examen</i> (established in 1788).</p>	<p>Age only limited by condition of length of school course. The usual age is 17-18.</p>	<p>9 years. Candidates who have not attended the 9 years' school course may be admitted to the examination on special application.</p>	<p style="text-align: center;">In <i>Gymnasium</i>.</p> <p>Written. { German essay. Mathematics. Translation into Latin. Translation from Greek into German.</p> <p>Oral. { Latin. Greek. English or French. Religion. History. Mathematics.</p> <p style="text-align: center;">In <i>Real-Gymnasium</i>.</p> <p>Written. { German essay. Mathematics. Translation from Latin. Translation from German into, or essay in, English or French. Physics.</p> <p>Oral. { Latin. English. French. Physics or Chemistry. Religion. History. Mathematics.</p> <p style="text-align: center;">In <i>Ober-Realschule</i>.</p> <p>Written. { German essay. Mathematics. An exercise in French and in English (an essay in one language and a translation from the other into German). Physics or Chemistry.</p> <p>Oral. { English. French. Physics. Chemistry. Religion. History. Mathematics.</p>	<p>The object of the examination is defined as being a test of whether the candidate has fulfilled the aims laid down in the curricula, &c., prescribed for a <i>Gymnasium</i>, <i>Real-gymnasium</i> or <i>Ober-realschule</i>, as the case may be, and the subjects of examination are those prescribed in the curricula for the kind of school concerned.</p> <p>The report on the school work of each candidate in his various subjects is laid before the Examining Board before the beginning of the examination.</p>	<p>The Examining Board consists of a government inspector (<i>der Königliche Kommissar</i>) acting as chairman, the headmaster of the school, and the teachers of the highest classes in the school. The inspector may nominate a deputy, who is, as a rule, the headmaster of the school.</p> <p>Each teacher concerned selects for the written examination three alternative subjects in his branch, from which, after receiving a report thereon from the headmaster, the inspector makes a final choice.</p> <p>The papers are marked by the teachers concerned, and circulated to the whole Board of Examiners, who then decide whether individual candidates shall be (i.) rejected, (ii.) admitted with exemption from the oral examination, or (iii.) submitted to the oral examination.</p>	<p>The written examination extends over four or five days. Only one paper is given each day, for which 3 to 5½ hours are allowed (5½ hours for the German essay). For essays in foreign languages dictionaries may be used.</p>

TABLE II.—FRANCE: BACCALAURÉAT

I. Name of Examination.	II. Minimum Age for Entry.	III. Length of Course of Study.	IV. Subjects.	V. Co-ordination with Teaching.	VI. Examiners.	VII. Nature of Examination and General Remarks.
<p><i>Baccalauréat de l'enseignement secondaire</i>.</p> <p>This examination has been carried on under different forms since 1808. The regulations summarized here date from 1902, when the <i>baccalauréat</i> described replaced the <i>baccalauréat-ès-lettres</i>, <i>baccalauréat-ès-sciences</i>, and <i>baccalauréat de l'enseignement moderne</i>.</p>	<p>Part I., 16, or with special permission, 15. Part II. may not be taken within an academic year after passing Part I.</p>	<p>There is no requirement of attendance. Part I. of the examination corresponds exactly to the subjects taken in the "second cycle" of secondary education, and Part II. to the <i>classe de philosophie</i> and <i>classe de mathématiques</i>.</p> <p>See also under V.</p>	<p>Part I. is divided into four Branches, viz.:- (1) Latin-Greek. (2) Latin-modern languages. (3) Latin-science. (4) Science-modern languages.</p> <p>In each Branch the examination is divided into two parts, viz. written and oral. The nature of the examination may be indicated by the following requirements in Branch (1):-</p> <p>Written. { (i.) French composition. (ii.) Translation from Latin. (iii.) Translation from Greek.</p> <p>Oral. { (i.) Explanation of a Greek text. (ii.) Explanation of a Latin text. (iii.) Explanation of a French text. (iv.) Test in a modern foreign language. (v.) Interrogation on ancient history. (vi.) Interrogation on modern history. (vii.) Interrogation on geography. (viii.) Interrogation on mathematics. (ix.) Interrogation on physics.</p> <p>Part II. is divided into two Branches, viz.:- (1) Philosophy. (2) Mathematics.</p> <p>The nature of the examination may be indicated by the following requirements in Branch (1):-</p> <p>Written. { (i.) An essay in French on a philosophical subject. (ii.) An examination in physical and natural science.</p> <p>Oral. { (i.) Interrogation on philosophy and philosophical writers. (ii.) Interrogation on contemporary history. (iii.) Interrogation on physical science. (iv.) Interrogation on natural science.</p>	<p>The syllabus of the examination is that prescribed for the higher classes in the Government secondary schools.</p> <p>The candidate may submit his <i>livret scolaire</i>, or school record, which will be taken into account.</p>	<p>The Board of Examiners (or "jury") consists of (i.) University examiners being members of a faculty of letters or faculty of sciences; (ii.) secondary teachers, active or retired, selected by the minister of public instruction. The Board consists of from four to six examiners, of whom, when the number is even, half are chosen from either category.</p>	<p>The written portion of Part I. extends over from 9 to 10 hours in all (not on a single day), in periods of 3 or 4 hours each; the written portion of Part II. extends over from 6 to 9 hours. The oral examination for each part lasts ¼ hour on the average, and is public.</p>

EXAMINATIONS

TABLE III.—SCOTLAND: SCHOOL-LEAVING EXAMINATION

I. Name of Examination.	II. Minimum Age for Entry.	III. Length of Course of Study.	IV. Subjects.	V. Co-ordination with Teaching.	VI. Examiners.	VII. Nature of Examination and General Remarks.
Scottish school-leaving examination (established 1888). (See pamphlet on the "Leaving Certificate Examination" issued by the Scottish Education Department, 1908.)	17 on 1st of January following the year in which the candidate passes the last of the written examinations.	4 years.	Candidates must pass in four subjects on the higher grade standard, or in three subjects on the higher grade standard and two on the lower. A pass in drawing is accepted in lieu of one of the two lower grade passes. A pass in Gaelic is reckoned as a pass on the lower grade. All candidates must have passed in higher English and in either higher or lower grade mathematics. The remaining subjects may be either science with one or more languages (Latin, Greek, French, German, Spanish, or Italian), or languages only. But where two or more languages other than English are taken, the candidate's group must include either higher or lower grade Latin. A pass in Spanish, Italian, or science (in which subjects there is only one examination) is reckoned as a pass on the higher grade standard.	Schools are inspected, and the course of instruction must be approved by the Scottish Education Department, but the examinations are conducted by external examiners with whom teachers are not associated.	The examiners are appointed by the Scottish Education Department.	The examination consists of a written examination and an oral examination, on which stress is laid. The length of the examination varies with the subjects selected. The periods of examination vary from 1 to 2½ hours. If the candidate selects on the higher grade, English, Latin, mathematics, and French, the examination extends over 19½ hours.

TABLE IV.—UNIVERSITY OF LONDON SCHOOL EXAMINATION, MATRICULATION STANDARD

I. Name of Examination.	II. Minimum Age For Entry.	III. Length of Course of Study.	IV. Subjects.	V. Co-ordination with Teaching.	VI. Examiners.	VII. Nature of Examination and General Remarks.
School examination, matriculation standard (established in 1902). <i>Note</i> —A higher school-leaving certificate is awarded to pupils who (i.) have pursued an approved course of study for a period of years at a school or schools under inspection approved by the University; and (ii.) being matriculated students, have passed the "higher school examination" in at least three subjects at one and the same examination.	The minimum age of entry is 15, but if the candidate is under 16 he must remain at school until he is 16 years of age in order to be qualified for the school-leaving certificate, and cannot be registered as a student of the University until he has reached that age.	The curriculum of each school is considered on its own merits.	Pupils must satisfy the examiners in not less than five subjects, as follows:— (1) English. (2) Elementary mathematics. (3) Latin, or elementary mechanics, or elementary physics—heat, light and sound, or elementary chemistry, or elementary botany, or general elementary science. (4) and (5) Two of the following subjects, neither of which has already been taken under section (3). If Latin be not taken, one of the other subjects selected must be another language, either ancient or modern, from the list, and languages other than those included in the list may be taken if approved by the University, provided that the language is included in the regular curriculum:— Latin, Greek, French, German, ancient history, modern history, history and geography, physical and general geography, logic, geometrical and mechanical drawing, mathematics (more advanced), elementary mechanics, elementary chemistry, elementary physics—heat, light and sound, elementary physics—electricity and magnetism, elementary biology—botany, elementary biology—zoology, general elementary science (chemistry and physics).	Schools under a approved inspection, and course of instruction approved by the University. The papers are ordinarily set on the matriculation syllabus, but papers may be specially set more closely in accordance with the school curriculum provided that the syllabus proposed is approved by the University as at least equivalent to that for which it is substituted.	The examiners are ordinarily those appointed by the University for the ordinary matriculation examination.	The examination extends over at least 18 hours, and includes an oral examination in modern languages.

examinations) the examination may be prolonged over one or more days, and may test higher powers of investigation. But

Practical. such powers can only be fully tested by the performance of original work, under conditions difficult to fulfil in the examination room or laboratory. At the French examinations for the *prix de Rome* the candidates are required to execute a painting in a given number of days, under strict supervision (*en loge*).

In medicine the clinical examination of a patient is a test carried out under conditions more nearly approaching those of actual work than any other; and distinction in medical examinations is probably more often followed by distinction in after life than is the case in other examinations.

For the doctor's degree (where this is not an honorary distinction) a thesis or dissertation is generally, though not invariably, required in England. Of recent years the thesis has been introduced into lower examinations; it is required for the master's degree at London in the case of internal students, in subjects other than mathematics (1910);

both at Oxford and London, the B.Sc. degree, and at Cambridge the B.A. degree, may be given for research, although the number of students proceeding to a degree in this way is at present relatively small. In certain of the honours B.A. and B.Sc. examinations at Manchester and Liverpool, candidates may take the written portion of the examination at the end of the second year's course of study and submit a dissertation at the end of the third year. These are generally examined by two or more specialists.

5. *Competitive Examinations.*—The arrangement of students in order of merit led naturally to the use of examinations not only as a qualifying but also as a selective test, and to the offering of money prizes (including exhibitions, scholarships and fellowships) on the results. In 1854 selection by examination as a method of appointment to posts in the English public service was first substituted for the patronage system, which had caused grave dissatisfaction (see Macaulay's speech on the subject, *The Times* of the 25th of June 1853). The first public competitive examination for the Royal Military Academy, Woolwich, took place in

1855, and in 1870 the principle of open competition for the civil service was adopted as a general rule. (For further details see CIVIL SERVICE.)

In the Württemberg civil service candidates are admitted to a year's probation after passing a theoretical examination, at the conclusion of which they must pass an examination of a more practical character (A. Herbert, *Sacrifice of Education* . . ., 1889, p. 111).

In the award of scholarships, &c., it should be definitely decided whether the scholarship is to be awarded (1) for attainment, in which case the examination-test pure and simple may suffice, or (2) for promise, in which case personal information and a *curriculum vitae* are necessary. To take a simple instance: a candidate partly educated in Germany may obtain more marks in German at a scholarship examination than another who is more gifted, but whose opportunities have been less; the question at once arises, are the examiners to take the circumstances of the candidate into account or not? It is understood that at the colleges of the older universities such circumstances are considered. It must again be decided whether the financial circumstances of candidates are to be taken into account; are scholarships intended as prizes, or as a means of enabling poor students to obtain a university education? In some cases wealthy students have been known to return the emoluments of scholarships. It many universities of the United States there is a definite understanding that emoluments shall only be accepted by those needing them. It would not be difficult to ask candidates to make a confidential declaration on this subject on entrance and to establish in Great Britain a tradition similar to that of the United States, and steps in this direction have been taken both at Oxford and Cambridge (Lord Curzon of Kedleston, *University Reform*, p. 86).

A special allowance may be made for age. In certain scholarship examinations held formerly by the London County Council a percentage was added to the marks of each candidate proportionate to the number of months by which his age fell short of the maximum age for entry. The whole subject of entrance scholarships at English schools and universities, and especially their tendency to produce premature specialization, has recently been much discussed.

6. *The Organization and Conduct of Examinations.*—The organization and conduct of examinations, in such a way that each candidate shall be treated in precisely the same way as every other candidate, is a complex matter, especially where several thousand candidates are concerned. The greatest precautions must be taken to ensure the secrecy of the examination papers before the examination, and the effective isolation of individual candidates during the examination. The supervision should be adequate to remove all temptation to copying. The hygienic conditions should be such as to reduce the strain to a minimum. The question of the mental fatigue produced by examinations has been studied by certain German observers, but has not yet been fully investigated.

7. *Marking, Classification and Errors of Detail.*—In applying a single test in a qualifying examination it would be sufficient to mark candidates as passing or failing. But examinations consist as a rule of a number of tests, each one of which is complex; and a mark is recorded in respect of each test or portion of a test in order to enable the examining body to estimate the performance, considered as a whole, of the candidate. At Oxford the marks are not numerical, but the papers are judged as of this or that supposed "class," and various degrees of merit are indicated by the symbols α , β , γ , δ , to which the signs + or - may be prefixed, according as they are above or below a certain standard within each class. At Cambridge, numerical marks are used. The advantage of numerical marks is that they are more easily manipulated than symbols; the disadvantage, that they produce the false impression that merit can be estimated with mathematical accuracy. Professor F. Y. Edgeworth, in two papers on "The Statistics of Examinations" and the "Element of Chance in Competitive Examinations" (*Journal of the Royal Statistical Society*, 1888 and 1890), has dealt with

the subject, although on somewhat limited lines. His investigations show clearly that with candidates near the border-line of failure, which must necessarily be fixed at a given point (subject to certain allowances, where more than one subject is considered), the element of chance necessarily enters largely into the question of pass and failure. The fact may be stated in this way:—the general efficiency of the test being granted, it is true to say that the large majority of those who pass an examination will be superior in efficiency to those who fail; but a few of those who fail may be superior to a few of those who pass. These errors are not peculiar to the examination system, they are inherent in all human judgments. It is necessary to allow for them in considering the failure of an individual candidate as an index of inefficiency.

The element of chance, which prevails in the region on either side of the border between pass and failure, obviously prevails equally on either side of the border between "classes," where candidates are classified; it has been suggested by Dr Schuster that numerical order should accompany classification so as to avoid the creation of an artificial gap between the last candidate in one class and the highest in the next. Edgeworth's objection to such an argument is that the number of uncertainties is far less when candidates are classed than when they are placed in ostensible order of merit.

The difficulties of comparison of marks are further complicated when students take different subjects and it is necessary to compare their merit by means of marks allotted by different examiners and added together. In a pass examination the question has to be considered how far, if at all, excellence in one subject shall compensate for deficiency in another, a question which is indeterminate until the precise object of the whole examination is formulated. In the competitive examination for the Indian civil service, places are allotted on the aggregate of marks obtained in a number of subjects selected by the candidate from a list of thirty-two. The successful candidates are compared a year later on the results of another examination in which there is again a choice, though a much more limited one. The order of merit in the two examinations is, as a rule, very different.

Two further points may be noted. An examiner may have underestimated the time required to answer the questions which he has set; this will be obvious if with a large number of candidates (say 300 or 400) none approaches the maximum mark. In this case the maximum should be reduced. Again, it is generally recognized to be undesirable to give marks for a smattering. In order to avoid this various devices are adopted. The simplest is to award a proportion of marks (say 10 to 15, or even 20%) for "general impression." In some examinations, unless say 20% or more marks are obtained for a particular subject, no credit is given for the paper in that subject. Latham (*The Action of Examinations*, 1877, p. 490) describes other numerical adjustments used to meet this difficulty, especially that used in English civil service examinations. The numerical results of the civil service examinations are reduced so as to conform to a certain symmetrical "frequency-curve," of which the abscissae represent percentages of marks between definite limits and the ordinates the number of candidates obtaining marks between those limits. C. E. Fawsitt (*The Education of the Examiner*, Royal Philosophical Society of Glasgow, 1905) shows that frequency-curves deduced from actual investigation of class-marks are not symmetrical, but have two maxima corresponding to the performance of "non-workers" and of "workers." In pass examinations of a well-known character there is a maximum just beyond the pass mark, this being the point of efficiency at which many students aim.

8. *The Object and Efficiency of Examinations, and their Indirect Effects.*—In order to estimate the efficiency of an examination as a test, the precise question should be asked in each case—what is it intended to test? Much of the evil attributed to, and resulting from, examinations is due to the fact that this question has not been definitely put, and that a test legitimate for certain purposes has been used for others to which it is unsuited. Examinations are suited in the first instance for the

purpose for which they were originally designed in medieval universities—the test of technical and professional capacity; it has never been proposed to abolish qualifying examinations for doctors, pharmaceutical chemists, &c.; the tests applied are (or should be) direct tests of capacity carried out under conditions as nearly as possible like those of actual practice. If a student can auscultate correctly, or make up a prescription, at an examination, he will in all probability be able to do so in other circumstances.

Examinations as tests of the knowledge of isolated facts are necessarily of relatively small value, because the memory of such facts is transient; and memorization of a large number of facts for examination purposes is generally admitted to be specially transient; the “knowledge-test,” considered apart from a test of capacity, is in fact not a test of permanent knowledge, but of the power of retaining facts for a length of time which it is impossible to estimate and which with some candidates extends over a few weeks only. When used as tests of “general culture,” examinations, in the view of Paulsen, based on a study of German education, not only fail in their purpose, but tend to destroy the faculties which it is desired to develop (*Geschichte des gelehrten Unterrichts*, ii. 684 et seq.); to prepare ready answers to the numberless questions which an examiner may ask on a large variety of subjects is to paralyse the natural and free activity of the mind (cf. A. C. Benson on the results of English secondary classical education, *From a College Window*, 3rd ed., 1906, pp. 154-177). If pushed to its logical conclusion the view of Paulsen must, it is submitted, lead to the complete abandonment at examinations of tests of “knowledge” as distinguished from direct tests of capacity. Thus isolated questions on details of grammar would disappear from papers on the mother-tongue and on foreign languages, in which the test would consist mainly or entirely of composition and translation. Erudition would be tested by the power of writing, at leisure, a dissertation on some subject selected by the examiners or the candidate or, in the case of a teacher, by the delivery of a lecture on the subject. At the French *agrégation* candidates are given twenty-four hours for the preparation of a lecture of this kind. Such examinations would test the “skill in the manipulation of facts which is the true sign of a trained intelligence” (cf. K. Pearson, “The Function of Science in the Modern State,” *Ency. Brit.* 10th ed. xxxii. Prefatory essay). They might possibly be supplemented by easy oral examinations to test both range of knowledge and readiness of mind. But in the case of a pupil who had passed through a good secondary school it would be as safe to rely for supplementary information under this head on the testimony of his teachers, as it is to rely on their evidence with regard to the fundamental and all-important element on which no examination supplies direct information—personal character.

The main arguments of those opposed to the examination system may be summarized as follows: (i.) Examinations tend to destroy natural interests and exclude from the attention of the pupil all matters outside the purview of the examination (they would not do so if examinations were so limited in character that preparation therefor could absorb only a fraction of the pupil's time); (ii.) they tend to cultivate a personal judgment where no personal basis of judgment is possible, (this argument, directed mainly against the Oxford essay system, applies not to examinations in general, but to the character of the subjects set for essays); (iii.) competitive examinations on the home and Indian civil services scheme tend to diffuse mental energy over too many subjects (but see (xviii.) below); (iv.) examinations, especially competitive examinations, tend to become more and more difficult, difficulty being confused with efficiency—this has shown itself with the Cambridge mathematical tripos, in which for years questions of increasing difficulty were set on relatively unimportant subjects, until the examination was reformed (reply: all examinations should be overhauled periodically); (v.) they tend to paralyse the powers of exposition, all statements of knowledge being thrown into a form suitable, not for an uninstructed person, but for one who already possesses it, the examiner (this tendency should be counteracted by definite

training in composition); (vi.) the sample of knowledge and capacity yielded at an examination is frequently not a fair sample; it is liable to extreme variations in a favourable sense, if the candidate happens to have prepared the precise questions asked; in an unfavourable sense, if the candidate is suffering from misfortune or from accidental ill-health, the latter, owing to the periodic function, occurring much more frequently in the case of women than of men—the reform of examination methods may remove to a great extent the element of chance in questions set; in a competitive examination it is impossible to allow for ill-health; in a qualifying examination it is difficult to make any allowance unless the examination is definitely conducted in whole or in part by the teachers, and the past record of the candidate is taken into account (cf. Paulsen, *The German Universities*, pp. 344-345); (vii.) examinations of several hundred candidates at a time cannot be rationally conducted so as to be equally fair to the individuality of all candidates; the individual test is the only complete one (it is admitted that examinations on a large scale necessarily involve a margin of error; but this error may be reduced to a minimum, especially by a combination of oral and practical with written work); (viii.) the multiplicity of school examinations required for different reasons produces confusion in our secondary education (there is a growing tendency to admit equivalence of “school-leaving” and entrance examinations; thus entrance examinations of Oxford, Cambridge and London, and the Northern Universities Joint Board are interchangeable under certain conditions); (ix.) the multiplicity of examinations tends to “underselling” (the success of the London examinations in medicine proves that a high standard attracts candidates as well as a low one; possibly intermediate standards may be killed in the competition; it is by no means obvious that a uniform system of examinations would conduce to efficiency); (x.) examinations produce physical damage to health, especially in the case of women-students (on this point more statistical evidence is needed; see, however, Engelmann quoted by G. Stanley Hall, *Adolescence*, 1905, ii. 588 et seq.); (xi.) examinations have in England mechanically cast the education of women into the same mould as that of men, without reference to the different social functions of the two sexes (the remedy is obvious); (xii.) it is unjustifiable to give a man a university position on the results of his performance in the examination room, a practice common in England though almost unknown on the continent; a just estimate of a man's powers in research or for teaching can only be properly based on his performance. The present system merely leads to the transmission of the sterile art of passing examinations. (At Oxford and Cambridge many fellowships are now awarded on the results of examination; it is sometimes stated, in defence of this system, that young men cannot be expected to carry out research in classics or philosophy.)

On the other hand, the defenders of examinations reply that (xiii.) examinations are necessary in order to test the efficiency of schools to which grants of public money are given (this argument has become somewhat out of date owing to the recent substitution of “inspection” for examination as a test of the efficiency of schools; a combination of inspection and examination is also sometimes used); (xiv.) they serve as a necessary incentive to steady and concentrated work¹ (the reply made to this is that the incentive is a bad one, and that with efficient teachers it is unnecessary); (xv.) they show both student and teacher where they have failed (unnecessary for efficient teachers); (xvi.) though possibly harmful to the highest class of men, they are good for the mass (reply: no system which damages the highest class of men is tolerable); (xvii.) they are indispensable as an impartial means of selecting men for the civil service; (xviii.) in a difficult examination like the first class civil service examination the qualities of quickness of comprehension, industry, concentration, power of rapidly passing

¹ The Oxford commissioners of 1852 reported that “the examinations have become the chief instruments not only for testing the proficiency of the students but also for stimulating and directing the studies of the place” (*Report*, p. 61).

from one subject to another, good health, are necessary for success, though not tested directly, and these qualities are valuable in any kind of work (this appears to be incontrovertible); (xix.) examination records show that success in examinations is generally followed by success in after-life, and the test is therefore efficient (it does not follow that certain rejected candidates may not be extremely efficient); (xx.) as a plea for purely "external examinations," teachers cannot be trusted to be impartial and it is better for a boy to "cram" than to curry favour with his teacher (Latham).

The brief comments in brackets, appended above to the arguments, merely indicate what has been said or can be said on the other side. It can scarcely be doubted that in spite of the powerful objections that have been advanced against examinations, they are, in the view of the majority of English people, an indispensable element in the social organization of a highly specialized democratic state, which prefers to trust nearly all decisions to committees rather than to individuals. But in view of the extreme importance of the matter, and especially of the evidence that, for some cause or other (which may or may not be the examination system), intellectual interest and initiative seem to diminish in many cases very markedly during school and college life in England, the whole subject seems to call for a searching and impartial inquiry.

SOURCES OF INFORMATION.—The works mentioned above, and T. D. Acland, *Some Account of the Origin and Objects of the New Oxford Examinations for the Title of Associate in Arts* (London, 1858); Matthew Arnold, *Higher Schools and Universities in Germany* (1874); Graham Balfour, *The Educational Systems of Great Britain and Ireland* (2nd ed., Oxford, 1903); W. W. Rouse Ball, *Origin and History of the Mathematical Tripos* (Cambridge, 1880); Adolf Beier, *Die höheren Schulen in Preussen und ihre Lehrer* (1902–1906) (in progress); Cloudesley Breerton, "A New Method of awarding Scholarships," *School World*, 1907, p. 409; G. C. Brodrick, *A History of the University of Oxford* (London, 1886); F. Buisson, *Dictionnaire de pédagogie* (1880–1887); Lord Curzon of Kedleston, *Principles and Methods of University Reform* (1909); J. Demogeot and H. Montucci, *De l'enseignement supérieur en Angleterre et en Écosse* (1870); H. Denifle, *Die Universitäten des Mittelalters bis 1400* (Berlin, 1885); F. Y. Edgeworth, "The Statistics of Examinations," and "The Element of Chance in Competitive Examinations," *Journal of the Statistical Society*, 1888 and 1890 respectively; H. W. Eve, Lecture "On Marking," in *The Practice of Education* (Cambridge, 1883); Charles E. Fawsitt, *The Education of the Examiner* (Royal Philosophical Society of Glasgow) (Glasgow, 1905); J. G. Fitch, "The Proposed Admission of Girls to the University Local Examination," *Education Miscellanies* (1865), vol. x.; W. Garnett, "The Representation of certain Examination Results," *Journ. Statist. Soc.* (Jan. 1910); G. Stanley Hall, *Adolescence* (London, 1905); Sir W. Hamilton, *Discussions on Philosophy* (London, 1853); P. J. Hartog, "Universities, Schools and Examinations" in the *University Review* (July 1905); P. J. Hartog and Mrs A. H. Langdon, *The Writing of English* (1907); Auberger Herbert (edited by), *The Sacrifice of Education to Examination*, Letters from "All Sorts and Conditions of Men" (1889); *Influence of Examinations*, Report by a Committee, British Association Reports for 1903, p. 434, and for 1904, p. 360; John Jebb, *Remarks upon the Present Mode of Education in the University of Cambridge* (4th ed., 1774); Henry Latham, *On the Action of Examinations* (Cambridge, 1877); H. C. Maxwell Lyte, *A History of the University of Oxford to the Year 1530* (London, 1886); W. A. P. Martin, *The Lore of Cathay* (Edinburgh and London, 1901); J. B. Mullinger, *The University of Cambridge* (Cambridge, 1873); *How to pass Examinations successfully*, by an Oxford Coach; Mark Pattison, *Suggestions on Academical Organization* (Edinburgh, 1868); Friedrich Paulsen, *The German Universities and University Study* (London, 1906) and *Geschichte des gelehrten Unterrichts* (Leipzig, 1896); George Peacock, *Observations on the Statutes of the University of Cambridge* (1841); *Programme des examens du nouveau baccalauréat de l'enseignement secondaire*, Delalain frères, Paris; Hastings Rashdall, *The Universities of Europe in the Middle Ages* (Oxford, 1895); Rein's *Encyklopädisches Handbuch der Pädagogik* (2nd ed., 1902, &c.), articles "Prüfungen" (by F. Paulsen), &c.; Third Report of the Royal Commissioners on Scientific Instructions, 1873; J. E. Thorold Rogers, *Education in Oxford* (1861); M. E. Sadler, "Memorandum on the Leaving Examinations . . . in the Secondary Schools of Prussia," in Report of Royal Commission on Secondary Education, vol. v. p. 27 (1895); C. A. Schmid, *Geschichte der Erziehung* (Stuttgart, 1884, &c.), and *Encyklopädie des gesammten Erziehungs- und Unterrichtswesens* (2nd ed., 1876–87), articles "Prüfung," "Schulprüfungen," "Versetzungsprüfungen," &c.; Scholarships, various papers on, by H. B. Baker, A. A. David, H. A. Miers, M. E. Sadler and H. Bompas Smith, and others, British Association Report, 1907,

pp. 707–718; Arthur Schuster, article on "Universities and Examinations" in the *University Review* (May 1905); W. H. Sharp, *The Educational System of Japan* (Office of the Director-General of Education in India) (Bombay, 1906); Special Educational Reports, issued by the Board of Education, *passim*; A. M. M. Stedman, *Oxford: its Life and Schools* (London, 1887); I. Todhunter, *Conflict of Studies* (1873); William Whewell, *Of a Liberal Education* (London, 1845); Christopher Wordsworth, *Scholae academicae* (Cambridge, 1877); Étienne Zi (or Siu or Seu), *Pratique des examens littéraires en Chine* (Shanghai, 1894). Private information from Professor M. E. Sadler and Mr A. E. Twentyman. (P. J. H.; A. Wn.)

EXARCH (ἔξαρχος, a chief person or leader), a title that has been conferred at different periods on certain chief officers or governors, both in secular and ecclesiastical matters. Of these, the most important were the exarchs of Ravenna (*q.v.*). In the ecclesiastical organization the exarch of a *diocese* (the word being here used of the political division) was in the 4th and 5th centuries the same as primate. This dignity was intermediate between the patriarchal and the metropolitan, the name patriarch being restricted after A.D. 451 to the chief bishops of the most important cities (see PATRIARCH). The title of Exarch was also formerly given in the Eastern Church to a general or superior over several monasteries, and to certain ecclesiastics deputed by the patriarch of Constantinople to collect the tribute payable by the Church to the Turkish government. In the modern Greek Church an exarch is a deputy, or legate *a latere*, of the patriarch, whose office it is to visit the clergy and churches in the provinces allotted to him. The title of exarch has been borne by the head of the Bulgarian Church (see BULGARIA), since in 1872 it repudiated the jurisdiction of the Greek patriarch of Constantinople. Hence the names of the politico-religious parties in the recent history of the Near East: "Exarchists" and "Patriarchists."

EXCAMBION (a word connected with a large class of Low Latin and Romance forms, such as *cambium*, *concambium*, *scambium*, from Lat. *cambire*, Gr. *κάμβειν* or *κάμπτειν*, to bend, turn or fold), in Scots law, the exchange (*q.v.*) of one heritable subject for another. The modern Scottish excambion may consist in the exchange of any heritable subjects whatever, e.g. a patronage or, what often occurs, a portion of a glebe for servitude. Writing is not, by the law of Scotland, essential to an excambion. Chiefly in favour of the class of cottars and small feuars, and for convenience in straightening marches, the law will consider the most informal memoranda, and even a verbal agreement, if supported by the subsequent possession. The power to excamb was gradually conferred on entailed proprietors. The Montgomery Act, which was passed in 1770, to facilitate agricultural improvements, permitted 50 acres arable and 100 acres not fit for the plough to be excambed. This was enlarged by the Rosebery Act in 1836, under which one-fourth of an entailed estate, not including the mansion-house, home farm and policies, might be excambed, provided the heirs took no higher grassum (O.E. *gersum*, fine) than £200. The power was applied to the whole estate by the Rutherford Act of 1848, and the necessary consents of substitute heirs are now regulated by the Entail (Scotland) Act 1882.

EXCELLENCY (Lat. *excellētia*, excellence), a title or predicate of honour. The earliest records of its use are associated with the Frank and Lombard kings; e.g. Anastasius Bibliothecarius (d. c. 886) in his life of Pope Honorius refers to Charlemagne as "his excellency" (*ejus excellētia*); and during the middle ages it was freely applied to or assumed by emperors, kings and sovereign princes generally, though rather as a rhetorical flourish than as a part of their formal style. Its use is well illustrated in the various charters in the Red Book of the exchequer, where the addresses to the king vary between "your excellency," "your dignity" (*vestra dignitas*), "your sublimity" (*vestra sublimitas*) and the like, according to the taste and inventiveness of the writers. Du Cange also gives examples of the style *excellētia* being applied to the pope and even to a bishop (in a charter of 1182). With the gradual stereotyping of titles of honour that of "excellency" was definitively superseded in the case of sovereigns of the highest rank, about the beginning of the 15th century, by those of "highness" and "grace," and later by "majesty," first assumed in England by King Henry VIII.

Dukes and counts of the Empire and the Italian reigning princes continued, however, to be "excellencies" for a while longer. In 1593 the bestowal of the title of *excellence* by Henry IV. of France on the duc de Nevers, his ambassador at Rome, set a precedent that was universally followed from the time of the treaty of Westphalia (1648). This, together with the reservation in 1640 of the title "eminence" (*q.v.*) to the cardinals, led the Italian princes to adopt the style of "highness" (*altezza*) instead of "excellency." In France, from 1654 onwards, the title of *excellence* was given to all high civil and military officials, and this example was followed in Germany in the 18th century.

The subsequent fate of the title varies very greatly in different countries. In Great Britain it is borne by the viceroy of India, the lord-lieutenant of Ireland, all governors of colonies and ambassadors. In the United States it is part of the official style of the governors of states, but not of that of the president; though diplomatic usage varies in this respect, some states (*e.g.* France) conceding to him the style of "excellency," others (*e.g.* Belgium) refusing it. The custom of other republics differs: in France the president is addressed as *excellence* by courtesy; in Switzerland the title is omitted; in the South American republics it is part of the official style (Pradier-Fodéré, *Cours de droit diplom.* i. 80). In Spain the title of *excelencia* properly belonged to the grandees and to those who had the right to be covered in the royal presence, but it was extended also to high officials, viceroys, ministers, captains-general, lieutenants-general, ambassadors and knights of the Golden Fleece. In Austria the title *Exzellenz* belongs properly to privy councillors. It has, however, gradually been extended by custom to all the higher military commands from lieutenant-field-marshal upwards. Ministers, even when not privy councillors, are styled *Exzellenz*. In Germany the title is borne by the imperial chancellor, the principal secretaries of state, ministers and *Oberpräsidenten* in Prussia, by generals from the rank of lieutenant-general upwards, by the chief court officials, and it is also sometimes bestowed as a title of honour in cases where it is not attached to the office held by its recipient. In Russia the title is very common, being borne by all officers from major-general upwards and by all officials above the rank of acting privy councillor. Officers and officials of the highest rank have the title of "high excellency." Finally, in Italy, the title *eccellenza*, which had come to be used in the republics of Venice and Genoa as the usual form of address to nobles, has become as meaningless as the English title of "esquire" or the address of "sir," being, especially in the south, the usual form of address to any stranger.

In the diplomatic service the title of excellency is technically reserved to ambassadors, but in addressing envoys also this form is commonly used by courtesy. (W. A. P.)

EXCHANGE, in general, the action of mutual giving and receiving objects, interests, benefits, rights, &c. The word comes through the French from the Late Lat. *excambium* (see **EX-CAMBION**). The present article deals with the theory and practice of exchange in monetary transactions, but this may conveniently be prefaced by a brief statement as to the law relating to the exchange of property and other matters. In English law exchange is defined as the mutual grant of equal interests, the one in consideration of the other. The ancient common law conveyance had certain restrictions, *e.g.* identity in quantity of interest, fee-simple for fee-simple, &c., entry to perfect the conveyance, and an implied warranty of title and right of entry by either party in case of eviction. Such exchanges are now effected by mutual conveyances with the usual covenants for title. Exchanges are also frequently made by order of the Board of Agriculture under the Inclosure Acts, and there are also statutes enabling ecclesiastical corporations to exchange benefices with the approval of the ecclesiastical commissioners. The international exchange of territories is effected by treaties. The exchange of prisoners of war is regulated by documents called "cartels" (Med. Lat. *cartellus*, diminutive of *carta*, paper, bill), which specify a certain agreed-on value for each rank of prisoners. The practice superseded the older one of ransom at the end of a war. By the Regimental Exchanges Act

1875 the sovereign may by regulation authorize exchanges by officers from one regiment to another. (For "labour exchanges" see **UNEMPLOYMENT**.)

Exchange in relation to money affairs denotes a species of barter not of goods but of the value of goods, a payment in one place being exchanged for a payment in another place. The popular statement of the theory of exchange represents four principals involved in two transactions. A and B are two persons residing in one place different from the domicile of C and D; A sells goods to C; B buys goods from D; A sells his claim on C to B, who remits it to D in satisfaction of his debt, and D receives the cash from C, so that, assuming the two transactions to be of equal value, one piece of paper satisfies the four parties to these two transactions, and the trouble, expense and risk of sending money from both places are avoided. The piece of paper which performs the service may be a telegraphic order, cheque or bill of exchange. In this elementary proposition there would be no difficulty of exchange, as the full value of A's claim on C would be paid for by B, who is under the necessity of sending in exactly similar amount of money to D; but it can be seen that in actual practice the claims of one place on another place would not be exactly balanced by the necessities of the one place to meet obligations in the other place; thus arises the complication of exchange, which may best be described as the price of monetary claims on distant debtors.

Supposing, for example, that A in London had a claim on C in Edinburgh amounting to £100, and that B in London did not require to remit more than £90 to D in Edinburgh, it is evident that B in London must be offered some inducement to take over the whole of A's claim. B might give A £99:19:0, and could then, after satisfying his debt to D, have £10 to his credit in Edinburgh, which he could retain there at interest until he had incurred further liability to D, or he could have the balance of £10 returned him in coin at an expense, say, of sixpence; this would leave B with a profit of sixpence on the transaction, and, assuming that these figures are reasonable, exchange on Edinburgh in London would be one shilling discount per £100. Supposing the necessities of B induced him to offer A only £99:14:0 for his £100 claim, A would then prefer that C remitted him £100 in coin, which, on the above scale of expenses would cost 5s. and A would receive £99:15:0 net. On these premises, exchange on Edinburgh in London cannot fall below $\frac{1}{4}\%$ discount, and the same circumstances prevent it from rising above $\frac{1}{4}\%$ premium, for B, in no case, would pay more for A's claim than £100 plus the cost of sending coin to Scotland. If this basis is appreciated, all exchange problems between different countries can be mastered, and the quotations in the daily papers of cable payments, sight drafts (cheques) and long bills are then understood and supply an interesting indication of the state of international financial relations. As shown above, the balance of indebtedness must eventually be remitted by coin, and consequently when exchange in any city is quoted at one or other of the limit points given in our example as $\frac{1}{4}\%$ discount or $\frac{1}{4}\%$ premium, this exchange immediately acquires a very serious importance, because with the development of modern monetary systems under which enormous trade is carried on with a most moderate foundation of actual coin the weakening or strengthening of that foundation is a very vital matter.

While the understanding of the theory is essential for any facile interpretation of an exchange, there are of course innumerable details of practice which require to be known to identify the limit points of exchange in any particular city. The limit points can only be taken advantage of by banking experts, and, although we assume a trader remitting his indebtedness in coin when he is asked to pay too high a price for his bill of exchange, in actual affairs the banker will supply the cheque or bill and himself will do the professional business of sending away bullion. Similarly, we have represented one trader drawing on another trader and selling his draft to a third trader who remits the draft to a fourth. In actual practice, however, No. 1 draws on No. 2 and disposes of his draft to a banker; No. 4 draws on No. 3 and sells his draft to a banker; because, speaking generally, whenever

goods are shipped, the shipper immediately requires his money; he draws a bill against the goods, and it is the function of a banker to help, as a sort of debt-collecting agency, by buying these drafts; and the bank, being a mart for all forms of remittance, gets an immense variety of demand for cable payments, cheques and bills on all centres. This does not affect the theory, for it must be remembered that the banker is a necessary link between the buyer and seller of exchange, because the seller can only sell what he has and the buyer must have exactly what he wants.

To return to the question of limit points: if a universal currency system existed, with the same monetary standard that is used in England, and the coinage kept in a proper condition of weight and fineness, and the coin readily supplied to meet every reasonable claim—if, in fact, the pound sterling were the prevalent coin and the English banking system obtained everywhere, then we should find all exchange quotations as simple as our case of London and Edinburgh, that is to say, all exchanges would be quoted at par or a premium or a discount. The limit points in any place of the exchange on London would represent simply and obviously the cost of the transmission of the coin. These limit points would vary at each place according to the distance from London, the cost of freight, the risk involved in the transmission and the local rate of interest. On the continent of Europe some advance has been made in the direction of a universal coinage. Countries subscribing to the Latin Union have agreed on the franc as a common unit, and Belgium, Switzerland, France and Italy quote exchange between themselves at a premium or discount. Greece, Spain and other countries are also parties to the arrangement, but their currencies are in a bad state, and the exchange quotations involve a considerable element of speculation. We have, however, to deal with another factor in international finance, namely, the enormous variety of currency systems; and we have then to discover, in each case, the exchange which represents par and corresponds to our £100 for £100 in the London-Edinburgh example. The United States furnishes perhaps the easiest problem, and we must find out how many dollars in gold contain exactly the same amount of the precious metal as is contained in one hundred sovereigns. The answer is 486 $\frac{5}{8}$, and the arithmetic is a question of the mint laws of the two countries. Gold coin in the United States contains one-tenth alloy and in England one-twelfth alloy. Ten dollars contain 258 grains of gold, nine-tenths fine. One pound contains 123.274 grains of gold, eleven-twelfths fine, consequently £100 is worth \$486 $\frac{5}{8}$, or, to be exact, \$486 $\frac{3}{4}$, and when cable payments between London and New York are quoted at 4.86 $\frac{5}{8}$ for the £1 sterling, exchange is about par. As a cable payment is an immediate transfer from one city to another, no question of interest or other charge is involved. Owing to the cost of sending gold as detailed above, the New York cable exchange varies from about 4.84 to 4.89 $\frac{1}{2}$; at the former point gold leaves London for New York, and at the latter point gold comes to England. Besides insurance, freight, packing, commission and interest, there must also be considered the circumstance that coin taken in bulk is always a little worn and under full weight, and in the process of turning sovereigns into dollars, the result would not bear out the calculation based on the mint regulations: consequently, when taking gold from London, the demand would first fall on the raw metal as received from South Africa or Australia to be minted in the United States, then on any stock of American coin the Bank of England might have and be willing to sell by weight (which would be accounted for tale in New York), and lastly the demand would be satisfied by sovereigns taken by tale from the Bank of England and converted by weight in America.

The instance of the American quotation may be further taken to explain some of the numerous points which the study of the exchange involves. In the first place, it will be noted that we have quoted the price in dollars. In London, business in bills, &c., on New York is quoted either in pence or in dollars, that is to say, payments are negotiated for so many dollars either at 49 $\frac{1}{8}$ pence per dollar, or at the equivalent rate \$4.88 for the pound. In practice it is much more convenient to quote in

London in the money of the foreign country, as it makes comparison with the foreign rate on London very simple. Some foreign countries quote exchange on London in pence, and then, of course, in relation to those countries the same practice will obtain in England, but the majority of the exchange quotations on London are in francs, marks, gulden, lire, kronen or other foreign money. Another point which must be explained is the reason why exchange varies between what we have called the limit points; why there is sometimes so much demand for bills on London and why at other times so many bills are being offered. Similar causes operate on other exchanges, and if we develop the New York case we shall provide explanations for exchange movements in other countries.

At one time the financial relations between England and America were as follows. England was the principal creditor of the United States, and the latter country had to remit continually very large amounts in payment of interest on English money and profits on English investments, in payment for shipping freights, for banking commissions, insurance premiums and an immense variety of services, besides paying for the large imports which crossed the Atlantic from English ports. In the fall of the year these payments would be more than offset by the enormous exports of food-stuffs, cotton, tobacco, &c., so that during the first half of the year exchange would be at or about the limit of 4.89 $\frac{1}{2}$ and gold would have to be sent from New York to supplement the deficient quantity of bills. In the autumn the produce bills would flood the exchange market and gold would be sent from London as exchange got to the other limit point of 4.84. These conditions are still very potent, but latterly another element has entered into the position, and the new development is so powerful as to reverse sometimes what we may call the natural and legitimate movement in the exchange. This new element is the more intimate banking and financial relationship which has been established between the two countries. As American conditions have become more stable, with better security for capital and an assured feeling about the currency of the United States, bankers in London have gladly allowed their banking friends in New York and other large cities to draw bills on London whenever there was a good demand for sterling remittances. We have, therefore, to consider a fresh type of bill of which the drawer has no claim on the drawee, but, on the other hand, incurs a debt to the drawee. To take a very usual method, a banker in Wall Street, New York, will advance money to stockbrokers, investors and speculators against bonds and shares with a 20% margin. He deposits this security with a trust company in New York which acts both for the American and English banker. The Wall Street banker then draws a bill at 60 days' sight or 90 days' sight on the banker in Lombard Street and sells this draft to supply the money he lends the stockbroker. Two or three months hence the New York banker must send money to London with which to meet the bill, so that, whereas, in the case of a commercial bill, the produce is despatched and in due course the consignee must find the money for the bill, in the case of a finance bill, as it is called, the bill is drawn and in due course the drawer must send the value with which it is to be honoured. In any event the acceptor, the London banker, has to pay the bill, so that it will be easily understood that relations of the greatest confidence are necessary between the drawer and drawee before finance bills of this class can be created.

The profit arising from the transaction we have sketched is realized by the separate parties in this way. The New York banker lends money for three months, say, at 5% per annum, he pays a commission of $\frac{1}{2}$ % to the trust company which has custody of the security, a charge equivalent to $\frac{1}{8}$ % interest per annum. He draws on London at 90 days' sight and sells the bill at 4.83 $\frac{5}{8}$, the cable rate being 4.87 $\frac{3}{4}$, the buyer of a three months' bill making the allowance for the English bill stamp of $\frac{1}{2}$ per mille and the London discount rate of 3%. The drawer of the bill must also pay a commission of $\frac{1}{8}$ % to the London banker who accepts the draft; this is equivalent to another $\frac{1}{4}$ % per annum in the rate of discount, so that money raised in this way costs $\frac{1}{8}$ % for the trust company, 3% the London discount rate,

about $\frac{1}{4}\%$ for bill stamps, and $\frac{3}{4}\%$ for London commission—altogether, $4\frac{1}{4}\%$; and, as the money is loaned at 5%, there appears to be $\frac{1}{8}\%$ profit to the drawer of the bill. This, however, is on the assumption that the cable rate is still $4.87\frac{3}{4}$ when the bill falls due for payment and that the drawer would have to pay that price to telegraph the money to meet the draft. But exchange on London can go up or down between 4.84 and $4.89\frac{1}{2}$, and if at the end of the three months the cable rate is 4.84 the New York banker will be able to cover his bill at almost the same rate at which he sold it and will only be out of pocket to the extent of the commissions and stamps, so that the accommodation will only cost him $1\frac{1}{2}\%$ and his profit will be $3\frac{1}{2}\%$. If he has to pay more than $4.87\frac{3}{4}$ for his cable at the maturity of the bill his profit will be less than $\frac{1}{8}\%$, and he may even be a loser on the transaction.

It is obvious, then, that a high rate of interest in New York, with a high rate of exchange on London and a low rate of discount in England, would induce the creation of these finance bills. The supply of these bills would prevent New York exchange reaching the limit point at which gold leaves the United States, and the maturity of these bills in the autumn would ensure a demand for the produce bills and possibly prevent exchange from falling to the other limit point at which London has to send gold to New York.

We have pointed out the essential difference between these finance bills and what we have called produce bills, but there is another very striking difference, that of the question of supply. These finance bills are obviously very difficult to limit in their amounts; produce bills are, of course, limited by the extent of the surplus crops of the United States and by the demand for the produce in Europe, but so long as it is mutually satisfactory to the big finance houses in both countries to draw on credit granted in London, so long may these accommodation bills be created, and the pressure of the bills in New York may depress exchange so much that gold leaves London at a time when it is required in other directions. In such a case the embarrassment caused by this artificial drain of the gold reserve would much more than offset the amount of the commission earned by the accepting houses. The Bank of England may have to raise its rate of discount at the expense of the entire home trade; probably, also, with the rise in the value of money, consequent on the diminished resources, all investment securities fall in value and more onerous terms must be submitted to by the government, corporations and colonies, in the issue of any loans they may require. It will, therefore, be appreciated that, although these finance bills may be perfectly safe, their excessive creation is viewed with great disfavour, and considerable apprehension is felt when the adventures of speculators in New York make great demands for loans against stocks and shares, and, through the instrumentality of these finance bills, shift the burden on to the shoulders of the London discount market. The effect of this is to level money rates as between New York and London, and in the process the pressure falls on London and the relief goes to America. Eventually, of course, the bills must be met and funds sent for that purpose from across the Atlantic, but in the meanwhile the disturbance of the gold supply is an inconvenience.

We have explained the process of employing credits granted in London to finance Wall Street; there are, also, many other types of bill to which the acceptor lends his name on the assurance that he will in due course be supplied with the funds required to meet the acceptance. In the case of the produce bills, a London banker will accept the bills in order that they may be more easily marketable than if they were drawn direct on the actual consignee of the cotton, tobacco or wheat. The consignees in Liverpool, &c., pay a commission for this assistance and reimburse the London bank as the produce is gradually disposed of. The transaction appears slightly more complicated when English bankers accept bills for produce shipped from the United States to merchants living in Hamburg, Genoa, Singapore and all other great ports, but the principle is the same, and the influence of such business on the exchange affects, in the first

instance, the quotation between America and London, but afterwards, when money must be sent to London with which to honour the bills, the exchanges with Germany, Italy or the Straits Settlements bear their share in the eventual adjustment, the spinners, tobacco manufacturers and corn factors requiring drafts on London where so much of the trade of the world is financed.

We shall have to consider later the reasons which ensure to London this peculiar and predominant position. We have so far used the American exchange as an example to explain causes which produce fluctuations in all the principal exchanges on London and to show the points between which fluctuations are limited. The fact that America is still developing at a much greater rate than the Old World makes an important distinction between the financial position in New York and the financial position of the big capitals in Europe. There is not in America the huge accumulation of savings and investment money which the Old World has collected, so that whereas Europe helps to finance the United States, the latter country has so many home enterprises that she can spare none of her funds to assist Europe. It would not be possible for London to draw on New York such bills as we have described as finance bills, for they could never be discounted there except on the most onerous terms, and there is nothing in America which corresponds to the London money market.

We have to deal with dollars and cents in America, with francs in France, with marks in Germany, and different money units in nearly every country; but, given the mint regulations, the theoretical par of exchange and the theoretical limit points are arrived at by simple arithmetic. An exhaustive statement with reference to every country would involve an amount of tedious repetition, so that for the purposes of this article it is more instructive to consider the essential differences between the important exchanges than to go into the details of coinage, which would appeal rather to the numismatist than to the exchange expert.

The United States, offering as it does a vast field for profitable investment, must annually remit huge amounts for interest on bonds and shares held by Europeans; coupons and dividend warrants payable in America are offered for sale daily in London, and at the end of the quarters the amount of these claims, coupons and drawn bonds is very large, and a considerable set off to the indebtedness of Europe for American produce. It is often asserted that the United States is rapidly getting sufficiently wealthy to repurchase all these bonds and shares; but whenever trade conditions are exceptionally good in the States, fresh evidence is forthcoming that assistance from London and Europe is essential to finance the commercial development of the United States. This illustrates a feature common to all new countries, and the effect is that they make annual payments to the older countries and especially to England.

A government loan or other large borrowing arranged abroad will immediately move the exchange in favour of the borrowing country. A tendency adverse to the United States results from the drafts and letters of credit of the large number of holiday makers who cross the Atlantic and spend so much money in Europe. When remittance is made of the incomes of Americans who have taken up their residence in the Old World the exchange is affected in a similar manner.

In one respect the United States stands far superior to most of the older countries. There are no restrictions on the free export of gold when exchange reaches the limit point showing that the demand for bills on London exceeds the supply. New York (with London and India) is a free gold market, and this is undoubtedly one of the reasons why money is so readily advanced to the United States, and the finance bills, to which we referred above, would not be allowed to the same extent were it not for the fact that New York will remit gold when other forms of remittance are insufficient to satisfy foreign creditors. When exchange between Paris and London reaches the theoretical limit point of 25.32 (25 francs 32 centimes for the £1 sterling), gold does not leave Paris for London unless the Bank of France is

willing to allow it. By law, silver is also legal tender in France, and if the State Bank is pressed for gold a premium will be charged for it if it is supplied. Gold may be collected on cheaper terms in small amounts from the great trading corporations or from the offices of the railways, but a large shipment can only be made by special arrangement with the Bank of France. Similarly, in Germany, where a gold standard is supposed to obtain, if a banker requires a large amount of gold from the Reichsbank he is warned that he had better not take it, and if he persists he incurs the displeasure of the government institution to the prejudice of his business, so that the theoretical limit point of 20 marks 52 pf. to the pound sterling has no practical significance, and gold cannot be secured from Berlin when exchange is against that city, and Germany has, when put to the test, an inconvertible and sometimes a debased currency. There is no state bank in the United States, and no government interference with the natural course of paying debts. On the other hand, when monetary conditions in New York indicate a great shortage of funds, and rates of interest are uncomfortably high, the United States treasury has sometimes parted with some of its revenue accumulations to the principal New York bankers on condition that they at once engage a similar amount of gold for import from abroad, which shall be turned over to the treasury on arrival. As these advances are made free of interest the effect is to adjust the limit point of 484 to about 485, and the United States treasury seems to have taken a leaf out of the book of the German Reichsbank, which frequently offers similar facilities to gold importers and creates an artificial limit point in the Berlin Exchange. The Reichsbank gives credit in Berlin for gold that has only got as far as Hamburg, and sometimes gives so many days' credit that the agent in London of German banking houses can afford an extravagant price for bar gold and even risk the loss in weight on a withdrawal of sovereigns, although the exchange may not have fallen to the other limit point of 20.32. In England the only effort that is made to attract gold is some action by the Bank of England in the direction of raising discount rates; occasionally, also, the bank outbids other purchasers for the arrivals of raw gold from South Africa, Australia and other mining countries. Quite exceptionally, for instance during the Boer War, the Bank of England allowed advances free of interest against gold shipped to London.

Many of the principal banking houses in all the important capitals receive continually throughout the day telegraphic information of the tendency and movement of all the exchanges, and on the smallest margin of profit a large business is done in what is called arbitrage (*q.v.*). For instance, cheques or bills on London will be bought by X in Paris and remitted to Y in London. X will recoup himself by selling a cable payment on Z in New York. Z will put himself in funds to meet the cable payment by selling 60 days' sight drafts on Y, who pays the 60 days' drafts at maturity out of the proceeds of the cheques or bills received from Paris, and this complicated transaction, involving no outlay of capital, must show some minute profit after all expense of bill stamps, discount, cables and commissions has been allowed for. Such business is very difficult and very technical. The arbitrageur must be in first-class credit, must make the most exact calculation, and be prompt to take advantage of the small differences in exchange, differences which can be only temporary, as these operations soon bring about an adjustment.

The European exchanges with which London is chiefly concerned are Paris and Berlin, through which centres most of the financial business of the rest of Europe is conducted; for example, Scandinavia, Russia and Austria bank more largely with Berlin than elsewhere. Italy, Switzerland, Belgium and Spain bank chiefly in Paris. European claims on London or debts to London are settled mostly through Germany or France, and consequently the German and French rates of exchange are affected by the relation of England with the rest of the Continent. The exchanges on Paris and Berlin are therefore most carefully watched by all those big interests which are concerned with the rate of discount and the value of money in London.

If the Paris cheque falls to 25.12, gold arrivals in the London bullion market will be taken by French bankers unless the profit shown by the exchange on some other country enables other buyers to pay more for the gold than Paris can afford. If the Paris cheque falls still further, it would pay to take sovereigns from the Bank of England for export, and so much would be taken as would satisfy the demand to send money to France, or until the consequent scarcity of money in London made rates of interest so high in England that French bankers would prefer to leave money and perhaps increase their balances. As between London and Paris and Berlin the greatest factor operating the exchanges is the relative value of money in the three centres. There is no great excess of trade balance at any season in favour of Germany or France and against England. On the other hand the banking relations between those countries are very intimate, and if funds can be very profitably employed in one of these places, there will be a good demand for remittance, and exchange will move in favour of that place, that is to say, exchange will go towards that limit point at which gold will be sent. The great pastoral and agricultural countries like South America, Egypt and India are in a position to draw very largely on London when their crops or other products are ready for shipment. In the early months of the year gold goes freely to South America to pay for the cereals, hides and meat, and in the autumn Egypt and India send such quantities of cotton and wheat that exchange moves heavily in favour of those countries, and gold must go to adjust the trade balance. During the rest of the year the gold tends to return as these countries always require bills on London or some form of payment to meet interest and dividends on European money invested in their government debts, railways and trading enterprises, and to pay for the European manufactures which they import. Exchange then moves in favour of England, and the Bank of England can replenish its reserve. Over the greater part of the world the rate of exchange on London is an indication simply of the trade balance. The greater part of the world receives payment for food stuffs, and has to pay for European manufactures, shipping freights, banking services and professional commissions.

The greatest complication in exchange questions arises when we have to deal with a country employing a silver standard, and, fortunately for the development of trade, this problem has disappeared of late years in the case of India, Ceylon, Japan, Mexico and the Straits Settlements, and now the only important country using silver as a standard is China. When the monetary standard in one country is only a commodity in another country we are as far removed from the ideal of an international currency as can be imagined. We can fix no limit points to the exchange and we cannot settle any theoretical par of exchange. The price of silver in the gold-using country may vary as much as the price of copper or tin, and in the silver-using country gold is dealt in just as any other metal. In both cases the only metal of constant price is the metal which is used as the money standard. The easiest method of explaining the position is to consider that any one in a gold-using country having a claim in currency on a silver-using country has to offer for sale so many ounces of silver, and vice versa the exporter in a silver-using country sending produce to London has to offer a draft representing so many ounces of gold. This introduces a very unsatisfactory element. To take a practical example:—a tea-grower in China has raised his crop in spite of the usual experience of weather and labour difficulties and the endless risks that a planter must face; the tea is then sent to London to take its chance of good or bad prices, and at the same time the planter has a draft to sell representing locally a certain weight of gold; now, in addition to all the risks of weather and trading conditions, and the chances of the fluctuations in the tea market, he is compelled to gamble in the metal market on the price of gold. Some years ago when a large number of important countries employed a silver standard it was seriously suggested that a fixed ratio should be agreed internationally at which gold and silver should be exchanged. This advocacy of bimetalism (*q.v.*) was especially persistent at a time when silver had suffered a very great fall in price and the

prominent exponents could generally be identified either as extremely practical men who were interested in the price of silver, or as very inexperienced theorists. The difficulty of the two standards was successfully solved by discarding the use of silver, and the chief silver-using countries adopted a gold standard which has given greater security for the investment of foreign capital, has simplified business and brought about a large increase of trade.

In the case of a country of which the government has been subject to great financial difficulties, gold has been shipped to satisfy foreign creditors so long as the supply held out, and the exchange with such a country will continue to move adversely with every fresh political embarrassment and any other economic cause reflecting on the national credit. With the collapse of the monarchy in Brazil the value of the milreis fell from 27d. to 5d., and all the Spanish-American countries have from time to time afforded most distressing examples of the demoralizing effects on the currency of unstable and reckless administration. In Europe similar results have been shown by the mistrust inspired by the governments of Spain, Greece, Italy and some other states. The raising of revenue by the use of the printing press creates an inconvertible and depreciating paper currency which frightens foreign capital and severely taxes the unfortunate country which must make payment abroad for the service of debt and other obligations. With the tardy appreciation of the old proverb that "honesty is the best policy" nearly every country of importance has made strenuous efforts to improve the integrity of its money.

Exchange quotations are not published from many of the British colonies, as their financial business is in the hands of a comparatively few excellently managed banks, which establish, by agreement, conventional exchanges fixed for a considerable period, notably in the case of Australia, New Zealand and South Africa. The Scottish and Irish banks supply similar examples of a monopoly in exchange.

The following table taken from the money article of a London daily paper indicates the exchanges which are of most interest to England:—

Foreign Exchanges.

	June 14.	June 15.	June 16.
Paris, cheques . . .	25 f. 18 c.	25 f. 18 c.	25 f. 18 c.
" Mkt. discount . .	2½-⅝ p.c.	2½-⅝ p.c.	2½-⅝ p.c.
Brussels, cheques . .	25 f. 23 c.	25 f. 23½ c.	..
Berlin, sight . . .	20 m. 48½ pf.	20 m. 48½ pf.	20 m. 48 pf.
" 8 days . . .	20 m. 46½ pf.	20 m. 46½ pf.	20 m. 45½ pf.
" Mkt. discount . .	3½ p.c.	3½ p.c.	3½ p.c.
Vienna, sight . . .	Holiday	24 kr. 02½ h.	24 kr. 02½ h.
Amsterdam, sight . .	12 fl. 13½ c.	12 fl. 13½ c.	..
Italy, sight . . .	Holiday	25 lire 15 c.	..
Madrid, sight . . .	"	27 ps. 68	..
Lisbon, sight . . .	"
St Petersburg, 3ms. .	94 r. 10	94 r. 10	..
Bombay, T.T. . . .	1s. 4d.	1s. 4d.	1s. 4d.
Calcutta, T.T. . . .	1s. 4d.	1s. 4d.	1s. 4d.
Hong-Kong, T.T. . .	2s. 1½d.	2s. 1½d.	2s. 1½d.
Shanghai, T.T. . .	2s. 10½d.	2s. 10½d.	2s. 10½d.
Singapore, T.T. . .	2s. 4½d.	2s. 4½d.	2s. 4½d.
Yokohama, T.T. . .	2s. 0½d.	2s. 0½d.	2s. 0½d.
*Rio de Jan'ro, 90 days	16½d.	16½d.	16½d.
*Valparaiso, 90 days
Coml.	14½d.	14½d.	14½d.
*B. Ayres, 90 days . .	48½d.	48d.	48d.

* These rates are telegraphed on the day preceding their receipt.

In the case of Paris and Berlin it will be noticed that the local rate of discount is also given, as the value of money in these centres, in relation to the value of money in London, is the most important factor in a movement of the exchange. Vienna has become important owing to the improvement in the financial position of Austria, and still greater improvement is shown in the case of Italy, whose currency stands in the above list better even than that of France. Spain, which should stand at about the same rate, still has a depreciated paper currency. Lisbon stands also at a discount, as the milreis should be worth 53½ pence.

In Russia the exchange showing 94.10 roubles to £10 is care-

fully and cleverly controlled in spite of the bad internal position. The India exchanges move slightly, as the currency is firmly established at the rate of 15 rupees to the £1. Hong-Kong quotes for the old Mexican dollar and a British trade dollar; Shanghai for the tael containing on an average 517½ grains of fine silver. The Straits Settlements have fixed their money on a gold basis at 2s. 4d. per dollar, on the lines of the arrangement made in India. In Japan there is a gold standard, and par of exchange is 2s. 0½d. for the yen. Brazil, Chile and Argentina have a depreciated paper currency, and the last quotation of 48d. is for the gold dollar equal to five francs, but there is a premium on gold in the River Plate of 127.27½% and for the present a gold standard is re-established on this basis. The letters T.T. with the eastern exchanges signify telegraphic transfer or the rate for payments made by cable. The very important New York rates are always given in another part of the daily paper with other details of American commercial interest.

These rates are all quotations for payments in England, and all over the world the exchange on London is the exchange of the greatest importance. This unique position was gained originally, probably, through the geographical position of the United Kingdom, and has been maintained owing to several reasons which secure to London a peculiar position by comparison with any other capital. Britain's colossal trade ensures a supply of and a demand for English remittances. Even when goods or produce are dealt in between foreign countries a credit is opened in London, so that the shipper of the produce can offer in the local market a bill of exchange which is readily saleable. With the highly developed banking system a large amount of deposits is collected in London, and the result is that bills of any usance up to six months can be immediately discounted, and the proceeds, if required, can be handed over in gold. There are in London a great number of wealthy banks and banking houses whose reputation and solidity allow any one of them to accept bills for amounts varying from one to ten millions sterling, whereby large commissions are earned.

These four advantages, namely, a free gold market, a huge trade, an enormous accumulation of wealth, and a discount market such as exists nowhere else, have made London an unrivalled financial centre, and consequently bills on London are an international money and the best medium of exchange.

AUTHORITIES.—*A B C of the Foreign Exchanges*, by George Clare; *Foreign Exchanges*, by Goschen; *Arbitrage*, by Deutsch; *Arbitrages et Parités*, by Ottomar Haupt; *Swoboda, Arbitrage* (12th edition), by Max Fuerst. (E. M. HA.)

EXCHEQUER. The word "exchequer" is the English form of the Fr. *échiquier*, low Lat. *scaccarium*, and its primary meaning is a chess-board (see Chess). As the name of a government department dealing with accounts it is derived from the exchequer or the "abacus" by means of which such accounts were kept, such a contrivance being almost universally in use before the introduction of the Arabic notation. In England the department or court of accounts was named originally "the tallies" from the notched sticks or tallies which constituted the primitive means of account-keeping (which were only abolished in 1826), and was only subsequently, probably in the reign of Henry I., named the exchequer from the use of the abacus. Both the name and the general features of the institution may reasonably be attributed to Norman influence, since we find both in Normandy and in the Norman kingdom of Sicily, as well as in Scotland and Ireland; the two latter cases being directly due to English example. As a court of law the exchequer owed its existence in England, as elsewhere, to the necessity of deciding legal questions arising from matters of account, and its secondary activities soon overshadowed its original functions.

We cannot say whether the exchequer, as known in England, is older than the beginning of the 12th century. The treasury, which may be regarded as one of its constituents, dates from before the conquest, and the officers of the exchequer who were drawn from the treasury staff can be traced back to Domesday. But our earliest information about the exchequer itself, apart from that afforded by the pipe rolls (see RECORD), rests on a

treatise (*Dialogus de Scaccario*) written about A.D. 1179 by Richard, bishop of London and treasurer of England. His father, Nigel, bishop of Ely, had been treasurer of Henry I., and nephew to that king's great financial minister Roger, bishop of Salisbury. Nigel is said to have reconstituted the exchequer after the troubles of Stephen's reign upon the model which he inherited from his uncle. The Angevin, or rather the Norman, exchequer cannot be regarded in strictness as a permanent department. It consisted of two parts: the lower exchequer, which was closely connected with the permanent treasury and was an office for the receipt and payment of money; and the upper exchequer, which was a court sitting twice a year to settle accounts and thus nearly related to the Curia Regis (*q.v.*). We dare hardly say that either exchequer existed in vacation; indeed the word (like the word "diet") seems to have been limited at first to the actual sitting of the king's court for financial purposes. The Michaelmas and Easter exchequers were the sessions of this court "at the exchequer" or chess-board as it had previously sat "at the tallies." The constitution of the court was that of the normal Frankish curia. The king was the nominal president, and the court consisted of his great officers of state and his barons, or tenants-in-chief, and it is doubtless due to the fact that the exchequer was originally the curia itself sitting for a special purpose that its unofficial judges retained the name of "barons" until recent times. Of the great officers we may probably find the steward in the person of the justiciar, the normal president of the court. He sat at the head of the exchequer table. The butler was not represented. The chancellor sat on the justiciar's left; he was custodian *ex officio* of the seal of the court, and thus responsible for the issue of all writs and summonses, and moreover for the keeping of a duplicate roll of accounts embodying the judgments of the court. On the left of the chancellor, and thus clear of the table, since their services might be required elsewhere at any moment, sat the constable, the two chamberlains and the marshal. The constable was the chief of the outdoor service of the court, and was responsible for everything connected with the army, or with hunting and hawking. The two chamberlains were the lay colleagues of the treasurer, and shared with him the duty of receiving and paying money, and keeping safe the seal of the court, and all the records and other contents of the treasury. The marshal, who was subordinate to the constable, shared his duties, and was specially responsible for the custody of prisoners and of the vouchers produced by accountants. At the head of the table on the justiciar's right sat, in Henry II.'s time, an extraordinary member of the court, the bishop of Winchester. The treasurer, like the chancellor a clerk, sat at the head of the right-hand side of the table. He charged the accountants with their fixed debts, and dictated the contents of the great roll of accounts (or pipe roll) which embodied the decisions of the court as to the indebtedness of the sheriffs and other accountants. These persons with certain subordinates constituted the court of accounts, or upper exchequer, whereas the lower exchequer, or exchequer of receipt, consisted almost exclusively of the subordinates of the treasurer and chamberlains. In the upper exchequer the justiciar appointed the calculator, who exhibited the state of each account by means of counters on the exchequer table, so that the proceedings of the court might be clear to the presumably illiterate sheriff. The calculator sat in the centre of the side of the table on the president's left. The chancellor's staff consisted of the *Magister Scriptorii* (probably the ancestor of the modern master of the rolls), whose duties are not stated; a clerk (the modern chancellor of the exchequer) who settled the form of all writs and summonses, charged the sheriff with all fines and amercements, and acted as a check on the treasurer in the composition of the great roll; and a scribe (afterwards the comptroller of the pipe), who wrote out the writs and summonses and kept a duplicate of the great roll, known as the chancellor's roll. The constable's subordinates were the marshal and a clerk, who, besides the duty of paying outdoor servants of the crown, had the special task of producing duplicates of all writs issued by the Curia Regis. The treasurer and chamberlains, being colleagues,

had a joint staff, the clerical or literate members of which were servants of the treasurer, while the lay or illiterate members depended on the chamberlains. Hence while the treasurer and his clerks kept their accounts by means of rolls, the chamberlains and their serjeants duplicated them so far as possible by means of tallies. Thus the great roll was written by the treasurer's scribe (the engrosser, afterwards the clerk of the pipe), while the payments on account and other allowances to be credited to the sheriff were registered by the tally cutter of the chamberlains.

In the exchequer of receipt the staff was similarly divided between the treasurer and chamberlains; the treasurer having a clerk who kept the issue and receipt rolls (the later clerk of the pells) and four tellers, while each of the chamberlains was represented by a knight (afterwards the deputy chamberlains), who controlled the clerk's account by means of tallies, and held their lands by this serjeanty; these three had joint control of the treasury, and could not act independently. The other serjeants were the knight or "pesour" who weighed the money, the melter who assayed it, and the ushers of the two exchequers. It should be noted that all the lay offices of the treasury in both exchequers were hereditary. Henry II. had also a personal clerk who supervised the proceedings personally in the upper, and by deputy in the lower, exchequer.

The business of the ancient exchequer was primarily financial, although we know that some judicial business was done there and that the court of common pleas was derived from it rather than from the curia proper. The principal accountants were the sheriffs, who were bound, as the king's principal financial agents in each county, to give an account of their stewardship twice a year, at the exchequers of Easter and Michaelmas. Half the annual revenue was payable at Easter, and at Michaelmas the balance was exacted, and the accounts made up for the year, and formally enrolled on the pipe roll. The fixed revenue consisted of the farms of the king's demesne lands within the counties, of the county mints, and of certain boroughs (see *BOROUGH*) which paid annual sums as the price of their liberties. Danegeld was also regarded as fixed revenue, though after the accession of Henry II. it was not frequently levied. There were also rents of assarts and purprestures and mining and other royalties. The casual revenue consisted of the profits of the feudal incidents (escheat, wardship and marriage), of the profits of justice (amerements, and goods of felons and outlaws), and of fines, or payments made by the king's subjects to secure grants of land, wardships or marriages, and of immunities, as well as for the hastening and sometimes the delaying of justice. Besides this, there were the revenues arising from aids and scutages of the king's military tenants, tallages of the crown lands, customs of ports, and special "gifts," or general assessments made on particular occasions. For the collection of all these the sheriff was primarily responsible, though in some cases the accountants dealt directly with the exchequer, and were bound to make their appearance in person on the day when the sheriff accounted.

We gather both from tradition and from the example of the Scottish exchequer that the farms of demesne lands were originally paid in kind, by way of purveyance for the royal household, and although such farms are expressed even in Domesday Book in terms of money, the tradition that there was a system of customary valuation is a sufficient explanation, and not of itself incredible. At some date, possibly under the administration of Roger of Salisbury, the inconvenience of this arrangement led to the substitution of money payments at the exchequer. The rapid deterioration of a small silver coinage led to successive efforts to maintain the value of these payments, first by a "scale" deduction of 6d. in the £ for wear, then by the substitution of payment by weight for payment by tale, and finally by the reduction of most of such payments to their pure silver value by means of an assay, a process originally confined to payments from particular manors. Only the farms of counties, however, were so treated, and not all of those. The amount to be deducted in these cases was settled by the weighing and assaying of a specimen pound of silver in the presence of the sheriff by the pesour and the melter in the lower exchequer. The casual

revenue was paid by tale, and for the determination of its amount it was necessary to have copies of all grants made in the chancery on which rents were reserved, or fines payable. These were known first as *contrabrevia* and later as *originalia*; the profits of justice were settled by the delivery of "estreats" from the justices, while for certain minor casualties the oath of the sheriff was at first the only security. At a later date many of them were determined by copies of inquisitions sent in from the chancery. All this business might be transacted anywhere in England, and though convenience placed the exchequer first at Winchester (where the treasury was), and afterwards usually at Westminster, it held occasional sessions at other towns even in the 14th century.

The Angevin exchequer, described by Richard the Treasurer, remained the ideal of the institution throughout its history, and the lineaments of the original exemplar were never completely effaced; but the rapid increase both of financial and judicial business led to a multiplication of machinery and a growing complexity of constitution. Even in the time of Henry II. we gather that the great officers of state, except the treasurer and chancellor, commonly attended by deputy. In the reign of Henry III. the chancellor had also ceased to attend, and his clerk acquired the title of chancellor of the exchequer. To the same period belongs the institution of the king's and lord treasurer's remembrancers. These at first had common duties and kept duplicate rolls, but by the ordinance of 1323 their functions were differentiated. Henceforward the king's remembrancer was more particularly concerned with the casual, and the lord treasurer's remembrancer with the fixed revenue. The former put all debts in charge, while the latter saw to their recovery when they had found their way on to the great roll. Hence the preliminary stages of each account, the receiving and registering of the king's writs to the treasurer and barons, and the drawing up of all particulars of account, lay with the king's remembrancer, and he retained the corresponding vouchers. The lord treasurer's remembrancer exacted the "remanets" of such accounts as had been enrolled, as well as reserved rents and fixed revenue, and so became closely connected with the clerk of the pipe. Before the end of the 14th century these three offices had already crystallized into separate departments.

In the meantime the increasing length and variety of accounts, as well as the growth of judicial business, had led to various efforts at reform. As early as 22 Henry II. it became necessary to remove from the great roll the debts which it seemed hopeless to levy, and further ordinances to the same end were made by statute in 54 Henry III. and in 12 Edward I. By this last a special "exannual roll" was established in which the "desperate debts" were recorded, in order that the sheriff might be reminded of them yearly without their overloading the great roll. But the largest accession of financial business arose from the "foreign accounts," that is to say, the accounts of national services, which did not naturally form part of the account of any county. These did not in the reign of Henry II. form a part of the exchequer business. Such expenses as appear on the pipe roll were paid by the sheriffs, or by the bailiffs of "honours"; payments out of the treasury itself would only appear on the receipt and issue rolls, and the "spending departments" probably drew their supplies from the camera curie, and not directly from the exchequer. In the course of the 13th century the exchequer gradually acquired partial control of these national accounts. Even in 18 Henry II. there is an account for the forests of England, and soon the mint, the wardrobe and the escheators followed. The undated statute of the exchequer (probably about 1276) provides for escheators, the earldom of Chester, the Channel Islands, the customs and the wardrobe. During the reign of Edward I., the wardrobe account became unmanageable, since it not only financed the household, army, navy and diplomatic service, but raised money on the customs independently of the exchequer. The reform of 1323-1326, due to Walter de Stapledon, in remedying this state of things, greatly increased the number of "foreign accounts" by making the great wardrobe (the storekeeping department), the butler,

purveyors, keepers of horses or of the stud, the clerk of the "hamper" of the chancery (who took the fees for the great seal), and the various ambassadors, directly accountable to the exchequer. At the same time the sheriffs' accounts were expedited by the further simplification of the great roll, and by appointing a special officer, the "foreign apposer," to take the account of the "green wax," or estreats, so that two accounts could go on at once. Another baron (the 5th or cursitor baron) was appointed, and the whole business of foreign accounts was transferred to a separate building where one baron and certain auditors spent their whole time in settling the balances due on the accounts already mentioned, as well as those of castles, &c., not let to farm, Wales, Gascony, Ireland, aids (clerical and lay), temporalities of vacant bishoprics, abbeys, priories and dignities, mines of silver and tin, ulnage and so forth. These balances were accounted for in the exchequer itself, and entered on the pipe roll, but the preliminary accounts were filed by the king's remembrancer, and enrolled separately by the treasurer's remembrancer as a supplement to the pipe roll.

The next important change, about the end of the 15th century, was the gradual substitution of special auditors appointed by the crown, known as the auditors of the prests (the predecessors of the commissioners for auditing public accounts), for the auditors of the exchequer. Accounts when passed by them were presented in duplicate and "declared" before the treasurer, under-treasurer and chancellor. Of the two copies, one, on paper, was retained by the auditors, the other, on parchment, was successively enrolled by the king's and lord treasurer's remembrancers, and finally by the clerk of the pipe, to secure the levying of any "remanets" or "supers" by process of the exchequer.

Besides the two great difficulties of the postponement of financial to legal business, and of preventing the sheriffs from exacting the same debt twice, the exchequer was, as has been seen, hampered in its functions by the interference of other departments in financial matters. Its own branches even acquired a certain independence. The exchequer of the Jews, which came to an end in 18 Edward I., was such a branch. In 27 Henry VIII. the court of augmentations was established to deal with forfeited lands of monasteries. This was followed in 32 & 33 Henry VIII. by the courts of first-fruits and tenths and of general surveyors. These were reabsorbed by the exchequer in 1 Mary, but remained as separate departments within it. But the development of the treasury, which succeeded to the functions of the camera curie or the king's chamber, ultimately reduced the administrative functions of the exchequer to unimportance, and the audit office took over its duties with regard to public accounts. So that when the statute of 3 & 4 William IV. cap. 99, removed the sheriff's accounts also from its competence, and brought to an end the series of pipe rolls which begins in 1130, the ancient exchequer may be said to have come to an end.

(C. J.)

In 1834 an act was passed abolishing the old offices of the exchequer, and creating a new exchequer under a comptroller-general, the detailed business of payments formerly made at the exchequer being transferred to the paymaster-general, whose office was further enlarged in 1836 and 1848. And in 1866, as the result of a select committee reporting unfavourably on the system of exchequer control as established in 1834, the exchequer was abolished altogether as a distinct department of state, and a new exchequer and audit department established.

The ancient term exchequer now survives mainly as the official title of the national banking account of the United Kingdom. This central account is commonly called the exchequer, and its statutory title is "His Majesty's Exchequer." It may also be described with statutory authority as "The Account of the Consolidated Fund of Great Britain and Ireland." This account is, in fact, divided between the Banks of England and Ireland. At the head office of each of these institutions receipts are accepted and payments made on account of the exchequer; but in published documents the two accounts are

consolidated into one, the balances only at the two banks being shown separately.

Operations affecting the exchequer are regulated by the Exchequer and Audit Departments Act 1866. Section 10 prescribes that the gross revenue of the United Kingdom (less drawbacks and repayments, which are not really revenue) is payable, and must sooner or later be paid into the exchequer. Section 11 directs that payments should be made from the fund so formed to meet the current requirements of spending departments. Sections 13, 14, 15 lay down the conditions under which money can be drawn from the exchequer. Drafts on the exchequer require the approval of an officer independent of the executive government, the comptroller and auditor-general. But the description of the formal procedure required by statute cannot adequately express the actual working of the system, or the part it plays in the national finance. The simplicity of the system laid down by the act of 1866 has been disturbed by the diversion of certain branches or portions of revenue from the exchequer to "Local Taxation Accounts," under a system initiated by the Local Government Act 1888, and much extended since.

While the exchequer is, as already stated, the central account, it is not directly in contact with the details of either revenue or expenditure. As regards revenue, the produce of taxes and other sources of income passes, in the first instance, into the separate accounts of the respective receiving departments—mainly, of course, those of the customs, inland revenue and post office. A not inconsiderable portion is received in the provinces, and remitted to London or Dublin by bills or otherwise, and the ultimate transfers to the exchequer are made (in round sums) from the accounts of the receiving departments in London or in Dublin. Thus, there are always considerable sums due to the exchequer by the revenue departments; on the other hand, as floating balances are (for the sake of economy) used temporarily for current expenses, there are generally amounts due by the exchequer to the receiving departments; such cross claims are adjusted periodically, generally once a month. The finance accounts of the United Kingdom show the gross amounts due to the exchequer from the departments, and likewise the amounts payable out of the gross revenue in priority to the claim of the exchequer. On the expenditure side a similar system prevails. No detailed payments are made direct from the exchequer, but round sums are issued from it to subsidiary accounts, from which the actual drafts for the public services are met. For instance, the interest on the national debt is paid by the Bank of England from a separate account fed by transfers of round sums from the exchequer as required. Similarly, payments for army, navy and most civil services are met by the paymaster-general out of an account of his own, fed by daily transfers from the exchequer.

This system has two noticeable effects. Firstly, it secures the simplicity and finality of the exchequer accounts, and therefore of all ordinary statements of national finance. Every evening the chancellor of the exchequer can tell his position so far as the exchequer is concerned; on the first day of every quarter the press is able to comment on the national income and expenditure up to the evening before. The annual account is closed on the evening of the 31st of March, and there can be no reopening of the budget of a past year such as may occur under other financial systems. The second effect of the system is to introduce a certain artificiality into the financial statements. Actual facts cannot be reduced to the simplicity of exchequer figures; there is always (as already explained) revenue received by government which has not yet reached the exchequer; and there must always be a considerable outstanding liability in the form of cheques issued but not yet cashed. The suggested criticism is, however, met if it can be shown that, on the whole, the differences between the true revenue and the exchequer receipts, or between the true (or audited) expenditure and the exchequer issues, are not, taking one year with another, relatively considerable. The following figures (ooo's omitted) illustrate this point:—

Expenditure.

Year.	Exchequer Issues.	Audited Expenditure.	Difference.
1888-1889	£85,674	£86,070	£+396
1889-1890	86,083	86,033	- 50
1890-1891	87,732	87,638	- 94
1891-1892	89,928	90,125	+197
1892-1893	90,375	90,164	-211
1893-1894	91,303	91,530	+227
1894-1895	93,919	93,818	-101
1895-1896	97,764	97,667	- 97
1896-1897	101,477	101,543	+ 66
1897-1898	102,936	103,010	+ 74
Total for } 10 years	£927,191	£927,598	£+407

Revenue.

Year.	Exchequer Receipts.	Actual Revenue.	Difference.
1888-1889	£88,473	£88,038	£-435
1889-1890	89,304	89,416	+112
1890-1891	89,489	89,282	-207
1891-1892	90,995	91,428	+433
1892-1893	90,395	90,181	-214
1893-1894	91,133	91,265	+132
1894-1895	94,684	94,873	+189
1895-1896	101,974	102,031	+ 57
1896-1897	103,960	104,089	+129
1897-1898	106,614	106,691	+ 77
Total for } 10 years	£947,011	£947,294	£+273

Surplus.

Year.	Exchequer Accounts.	Diff. between Actual Rev. and Aud. Exp.	Difference.
1888-1889	£2,799	£1,968	£-831
1889-1890	3,221	3,383	+162
1890-1891	1,757	1,644	-113
1891-1892	1,067	1,303	+236
1892-1893	20	17	- 3
1893-1894	-170	-205	- 95
1894-1895	765	1,055	+290
1895-1896	4,210	4,364	+154
1896-1897	2,473	2,546	+ 73
1897-1898	3,678	3,681	+ 3
Total for } 10 years	£19,820	£19,696	£-124

The third column in the above shows the price which has to be paid (in the form of discrepancies between facts and figures) for the simplicity secured to statements and records of the national finance by the present system embodied in the term exchequer. Probably few will think the price too high in consideration of the advantages secured.

The principal official who derives a title from the exchequer in its living sense is, of course, the chancellor of the exchequer. He is the person named second in the patent appointing commissions for executing the office of lord high treasurer of Great Britain and Ireland; but he is appointed chancellor of the exchequer for Great Britain and chancellor of the exchequer for Ireland by two additional patents. Although, in fact, the finance minister of the United Kingdom, he has no *statutory* power over the exchequer apart from his position as second commissioner of the treasury; but in virtue of his office he is by statute master of the mint, senior commissioner for the reduction of the national debt, a trustee of the British Museum, an ecclesiastical commissioner, a member of the board of agriculture, a commissioner of public works and buildings, local government, and education, a commissioner for regulating the offices of the House of Commons, and has certain functions connected with the office of the secretary of state for India. The only other exchequer officer requiring mention is the

comptroller and auditor-general, whose functions as comptroller-general of the exchequer have been already described.

The ancient name of the national banking account has been attached to two of the forms of unfunded national debt. Exchequer bills, which date from the reign of William and Mary (they took the place of the tallies, previously used for the same purpose), became extinct in 1897, but exchequer bonds (first issued by Mr Gladstone in 1853) still possess a practical importance. An exchequer bond is a promise by government to pay a specified sum after a specified period, generally three or five years, and meanwhile to pay interest half-yearly at a specified rate on that sum. Government possesses no general power to issue exchequer bonds; such power is only conferred by a special act, and for specified purposes; but when the power has been created, exchequer bonds issued in pursuance of it are governed by general statutory provisions contained in the Exchequer Bills and Bonds Act 1866, and amending acts. These acts create machinery for the issue of exchequer bonds and for the payment of interest thereon, and protect them against forgery.

Some traces may be mentioned of the ancient uses of the name exchequer which still remain. The chancellor of the exchequer still presides at the ceremony of "pricking the list of sheriffs," which is a quasi-judicial function; and on that occasion he wears a robe of black silk with gold embroidery, which suggests a judicial costume. In England the last judge who was styled baron of the exchequer (Baron Pollock) died in 1897. In Scotland the jurisdiction of the barons of the exchequer was transferred to the court of session in 1856, but the same act requires the appointment of one of the judges as "lord ordinary in exchequer causes," which office still exists. In Ireland Lord Chief Baron Palles was the last to retain the old title. A street near Dublin Castle is called Exchequer Street, recalling the separate Irish exchequer, which ceased in 1817. The old term also survives in the full title of the treasury representative in Scotland, which is "The King's and the Lord Treasurer's Remembrancer in Exchequer," while his office in the historic Parliament Square is styled "Exchequer Chambers." (S. E. S.-R.)

BIBLIOGRAPHY.—For the early exchequer Thomas Madox's *History and Antiquities of the Exchequer* (London, 1711) remains the standard authority, and in it the *Dialogus de Scaccario* of Richard the Treasurer (1179) was first printed (edited since by A. Hughes, C. G. Crump and C. Johnson, Oxford, 1902). The publications of the Pipe Roll Society (London, 1884 et seq.), the Pipe Rolls and Chancellor's Roll, printed by the Record Commission (London, 1833 and 1844), and H. Hall's edition of the *Receipt Roll of the Exchequer 31 Henry II.* (London, 1899) should also be consulted. A popular account is in H. Hall's *Court Life under the Plantagenets* (London, 1901), and a careful study in Dr Parow's thesis, *Comptus Vicecomitis* (Berlin, 1906). For the 13th and 14th centuries H. Hall's edition of the *Red Book of the Exchequer* (London, Rolls Series, 1896) is essential, as also the Public Record Office *List of Foreign Accounts* (London, 1900). Later practice may be gathered from the similar *List and Index of Declared Accounts* (London, 1893), and from such books as Sir T. Fanshawe's *Practice of the Exchequer Court*, written about A.D. 1600 (London, 1658); Christopher Vernon's *The Exchequer Opened* (London, 1661), or Sir Geoffrey Gilbert's *Treatise on the Court of Exchequer* (London, 1758), as well as from the statutes abolishing various offices in the exchequer. H. Hall's *Antiquities of the Exchequer* (London, 1891) gives many interesting details of various dates. For the Scottish exchequer *The Exchequer Rolls of Scotland* (Edinburgh, 1878 et seq.) should be consulted, while Gilbert's book noted above gives some details on that of Ireland. See also Appendix 13 to the great account of *Public Income and Expenditure from 1688 to 1869*, in three volumes, prepared for parliament by H. W. Chisholm (1869); and for sidelights on the working of the office from 1825 to 1866 the reminiscences of the same author (the last chief clerk of the exchequer) in *Temple Bar* (January to April 1891).

EXCISE (derived through the Dutch, *excijns* or *accijns*, possibly from Late Lat. *accensare*,—*ad*, to, and *census*, tax; the word owes something to a confusion with *excisum*, cut out), a term now well known in public finance, signifying a duty charged on home goods, either in the process of their manufacture, or before their sale to the home consumers. This form of taxation implies a commonwealth somewhat advanced in manufactures, markets and general riches; and it interferes so directly with the industry and liberty of the subject that it has seldom been

introduced save in some supreme financial exigency, and has as seldom been borne, even after long usage, with less than the ordinary impatience of taxation. Yet excise duties can boast a respectable antiquity, having a distinct parallel in the *vectigal rerum venalium* (or toll levied on all commodities sold by auction, or in public market) of the Romans. But the Roman excise was mild compared with that of modern nations, having never been more than *centesima*, or 1%, of the value; and it was much shorter lived than the modern examples, having been first imposed by Augustus, reduced for a time one-half by Tiberius, and finally abolished by Caligula, A.D. 38, so that the Roman excise cannot have had a duration of much more than half a century. Its remission must have been deemed a great boon in the marts of Rome, since it was commemorated by the issue of small brass coins with the legend *Remissis Centesimis*, specimens of which are still to be found in collections.

The history of this branch of revenue in the United Kingdom dates from the period of the civil wars, when the republican government, following the example of Holland, established, as a means of defraying the heavy expenditure of the time, various duties of excise, which the royalists when restored to power found too convenient or too necessary to be abandoned, notwithstanding their origin and their general unpopularity. On the contrary, they were destined to be steadily increased both in number and in amount. It is curious that the first commodities selected for excise were those on which this branch of taxation, after great extension, had again in the period of reform and free trade been in a manner permanently reduced, viz. malt liquors, and such kindred beverages as cider perry and spruce beer. The other excise duties remaining are chiefly in the form of licences, such as to kill game and to use and carry guns, to sell gold and silver plate, to pursue the business of appraisers or auctioneers, hawkers or pedlars, pawnbrokers or patent-medicine vendors, to manufacture tobacco or snuff, to deal in sweets or in foreign wines, to make vinegar, to roast malt, or to use a still in chemistry or otherwise. It may be presumed that the policy of the licence duties was at first not so much to collect revenue, though in the aggregate they yielded a large sum, as to guard the main sources of excise, and to place certain classes of dealers, by registration and an annual payment to the exchequer, under a direct legal responsibility. The excise system of the United Kingdom as now pruned and reformed, however, while still the most prolific of all the sources of revenue, is simple in process, and is contentedly borne as compared with what was the case in the 18th, and the beginning of the 19th century. The wars with Bonaparte strained the government resources to the uttermost, and excise duties were multiplied and increased in every practicable form. Bricks, candles, calico prints, glass, hides and skins, leather, paper, salt, soap, and other commodities of home manufacture and consumption were placed, with their respective industries, under excise surveillance and fine. When the duties could no longer be increased in number, they were raised in rate. The duty on British spirits, which had begun at a few pence per gallon in 1660, rose step by step to 11s. 8½d. per gallon in 1820; and the duty on salt was augmented to three or fourfold its value.

The old unpopularity of excise, though now somewhat out of date, must have had real enough grounds. It breaks out in English literature, from songs and pasquinades to grave political essays and legal commentaries. Blackstone, in quoting the declaration of parliament in 1649 that "excise is the most easy and indifferent levy that can be laid upon the people," adds on his own authority that "from its first original to the present time its very name has been odious to the people of England" (book i. cap. 8, tenth edition, 1786); while the definition of "excise" gravely inserted by Dr Johnson in the *Dictionary*, at the imminent risk of subjecting the eminent author to a prosecution for libel—viz. "a hateful tax levied upon commodities, and adjudged not by the common judges of property, but wretches hired by those to whom excise is paid"—can hardly be ever forgotten.

The duties of excise in the United Kingdom were, until the passing of the Finance Act 1908, under the control of the

commissioners of inland revenue; they are now under the control of the commissioners of customs; the amount raised, apart from changes in the rate, shows a fairly constant tendency to increase, and is usually regarded as one of the best tests of the prosperity of the working classes.

The *spirit duty* is levied according to the quantity of "proof spirit" contained in the product of distillation, and the charge is taken at three different points in the process of manufacture, the trader being liable for the result of the highest of the three calculations. What is known as "proof spirit" is obtained by mixing nearly equal weights of pure alcohol and water, the quantity of pure alcohol being in bulk about 57% of the whole. Owing to the high rate of duty as compared with the volume and intrinsic value of the spirits, the whole process of manufacture is carried on under the close supervision of revenue officials. All the vessels used are measured by them and are secured with revenue locks; the premises are under constant survey; and notice has to be given by the distiller of the materials used and of the several stages of his operations. Though the charge for duty is raised at the time when the process of distillation is completed, the duty is not actually paid until the spirits are required for consumption. In the meanwhile they may be retained in an approved "warehouse," which is also subject to close supervision.

The *beer duty* dates from 1880, in which year it was substituted for the duty on malt. The specific gravity of the worts depends chiefly on the amount of sugar which they contain, and is ascertained by the saccharometer.

Excise licences may be divided into—(a) licences for the sale or manufacture of excisable liquors, (b) licences for other trades, such as tobacco dealers or manufacturers, auctioneers, pawnbrokers, &c., (c) licences for male servants, carriages, motors and armorial bearings, and (d) gun, game and dog licences. Nearly the whole of the licence duties is paid over to the local taxation account.

The *railway passenger duty*, which was made an excise duty by the Railway Passenger Duty Act 1847, applies only to Great Britain. It is levied on all passenger fares exceeding 1d. per mile, the rate being 2% on urban and 5% on other traffic.

The other items which go to make up the excise revenue are the charges on deliveries from bonded warehouses, and the duties on coffee mixture labels and on chicory.

For more detailed information reference should be made to Highmore's *Excise Laws*, and the annual reports of the commissioners of inland revenue, especially those issued in 1870 and 1885. See also TAXATION; ENGLISH FINANCE.

EXCOMMUNICATION (Lat. *ex*, out of; away from; *communis*, common), the judicial exclusion of offenders from the rights and privileges of the religious community to which they belong. The history of the practice of excommunication may be traced through (1) pagan analogues, (2) Hebrew custom, (3) primitive Christian practice, (4) medieval and monastic usage, (5) modern survivals in existing Christian churches.

1. Among pagan analogues are the Gr. *χερλιβων εἰργασθαι* (Demosth. 505, 14), the exclusion of an offender from purification with holy water. This exclusion was enforced in the case of persons whose hands were defiled with bloodshed. Its consequences are described Aesch. *Choëph.* 283, *Eum.* 625 f., Soph. *Oed. Tyr.* 236 ff. The Roman *exsecratio* and *diris devotio* was a solemn pronouncement of a religious curse by priests, intended to call down the divine wrath upon enemies, and to devote them to destruction by powers human and divine. The Druids claimed the dread power of excluding offenders from sacrifice (Caes. *B.G.* vi. 13). Primitive Semitic customs recognize that when persons are laid under a ban or taboo (*herem*) restrictions are imposed on contact with them, and that the breach of these involves supernatural dangers. Impious sinners, or enemies of the community and its god, might be devoted to utter destruction.

2. *Hebrew Custom.*—In a theocracy excommunication is necessarily both a civil and a religious penalty. The word used in the New Testament to describe an excommunicated person,

ἀνάθεμα (1 Cor. xvi. 22, Gal. i. 8-9, Rom. ix. 3), is the Septuagint rendering of the Hebrew *herem*. The word means "set apart" (cf. harem), and does not distinguish originally between things set apart because devoted to God and things devoted to destruction. Lev. xxvii. 16-34 defines the law for dealing with "devoted" things; according to v. 28 "No devoted thing that a man shall devote unto the Lord, of all that he hath, whether of man or beast, or of the field of his possession, shall be sold or redeemed. None devoted shall be ransomed, he shall surely be put to death." As in Greece and Rome whole cities or nations might be devoted to destruction by pronouncement of a ban (Numbers xxi. 2, 3, Deut. ii. 34, iii. 6, vii. 2). Occasionally Israelites as well as aliens fall under the curse (Judg. xxi. 5, 11). A milder form of penalty was the temporary separation or seclusion (*niddah*) prescribed for ceremonial uncleanness. This was the ordinary form of religious discipline. In the time of Ezra the Jewish "magistrates and judges" among their ecclesiastico-civil functions have the right of pronouncing sentence whether it be unto death, or to "rooting out," or to confiscation of goods, or to imprisonment (Ezra vii. 26). There is also a lighter form of excommunication which "devotes" the goods of an offender, but only separates him from the congregation. Both major and minor kinds of excommunication are recognized by the Talmud. The lesser (*niddah*) involved exclusion from the synagogue for thirty days, and other penalties, and might be renewed if the offender remained impenitent. The major excommunication (*herem*) excluded from the Temple as well as the synagogue and from all association with the faithful. Spinoza was excommunicated (July 16, 1656) for contempt of the law. Seldon (*De jure nat. et gen.*, iv. 7) gives the text of the curse pronounced on the culprit. The *Exemplar Humanae Vitae* of Uriel d'Acosta also deserves reference. The practice of the Jewish courts in New Testament times may be inferred from certain passages in the Gospels. Luke vi. 22, John ix. 22, xii. 42 indicate that exclusion from the synagogue was a recognized penalty, and that it was probably inflicted on those who confessed Jesus as the Christ. John xvi. 2 ("Whosoever killeth you," &c.) may point to the power of inflicting the major penalty. The Talmud itself says that the judgment of capital cases was taken away from Israel forty years before the destruction of the Temple. "Forty" is probably a round number without historical value, but the circumstance recorded by this tradition and confirmed by the evangelist's account of the trial of Jesus is historical, and is to be regarded as one of several restrictions imposed on the Jewish courts in the time of the Roman procurators.

3. *Primitive Christian Practice.*—The use of excommunication as a form of Christian discipline is based on the precept of Christ and on apostolic practice. The general principles which govern the exclusion of members from a religious community may be gathered from the New Testament writings. Matt. xviii. 15-17 prescribes a threefold admonition, first privately, then in the presence of witnesses (cf. Titus iii. 10), then before the church. This is a graded procedure as in the Jewish synagogue and makes exclusion a last resort. Nothing is said as to the nature and effects of excommunication. The tone of the passage when compared with the disciplinary methods of the synagogue indicates that its purpose was to introduce elements of reason and moral suasion in place of sterner methods. Its object is rather the protection of the church than the punishment of the sinner. The offender is only treated as a heathen and publican when the purity and safety of the church demand it. In the *locus classicus* on this subject (1 Cor. v. 5) Paul refers to a formal meeting of the Corinthian church at which the incestuous person is "delivered unto Satan for the destruction of the flesh that the spirit may be saved in the day of the Lord Jesus." These are mysterious words implying (1) a formal ecclesiastical censure, (2) a physical penalty, (3) the hope of a spiritual result. The form of penalty which would meet these conditions is not explained. There is a reference in 2 Cor. ii. 6-11 to a case of discipline which may or may not be the same. If it be the same it indicates that the excommunication had not been final; the offender had been received back. If it be not the same it shows the Corinthian

church exercising discipline independently of apostolic advice. Up to this point there is no established formal practice. 1 Tim. i. 20 ("Hymenaeus and Alexander whom I delivered unto Satan that they might be taught not to blaspheme") seems to refer to an excommunication, but it does not appear whether the apostle had acted as representing a church, nor is there anything to explain the exact consequences or limits of the deliverance to Satan. 1 Cor. xvi. 22, Gal. i. 8, 9, Rom. ix. 3 refer to the practice of regarding a person as anathema. Taking these passages as a whole they seem to point to an exclusion from church fellowship rather than to a final cutting off from the hope of salvation. In the pastoral letters there is already a formal and recognized method of procedure in cases of church discipline. 1 Tim. v. 19, 20 requires two or three witnesses in the case of an accusation against an elder, and a public reproof. Tit. iii. 20 recognizes a factious spirit as a reason for excommunication after two admonitions (cf. Tim. vi. and 2 John v. 10). In 3 John v. 9-10 Diotrephes appears to have secured an excommunication by the action of a party in the church. It is clear from these illustrations that within the New Testament there is development from spontaneous towards strictly regulated methods; also that the use of excommunication is chiefly for disciplinary and protective rather than punitive purposes. A process which is intended to produce penitence and ultimate restoration cannot at the same time contemplate handing the offender over to eternal punishment.

4. *Medieval and Monastic Usage.*—The writings of the church Fathers give sufficient evidence that two degrees of excommunication, the *ἀφορισμός* and the *ἀφορισμός πανρέλης*, as they were generally called, were in use during, or at least soon after, the apostolic age. The former, which involved exclusion from participation in the eucharistic service and from the eucharist itself, though not from the so-called "service of the catechumens," was the usual punishment of comparatively light offences; the latter, which was the penalty for graver scandals, involved "exclusion from all church privileges,"—a vague expression which has sometimes been interpreted as meaning total exclusion from the very precincts of the church building (*inter hiemantes orare*) and from the favour of God (Bingham, *Antiquities of Christian Church*, xvi. 2. 16). For some sins, such as adultery, the sentence of excommunication was in the 2nd century regarded as *πανρέλης* in the sense of being irrevocable. Difference of opinion as to the absolutely "irremissible" character of mortal sins led to the important controversy associated with the names of Zephyrinus, Tertullian, Calistus, Hippolytus, Cyprian and Novatian, in which the stricter and more montanistic party held that for those who had been guilty of such sins as theft, fraud, denial of the faith, there should be no restoration to church fellowship even in the hour of death. On this point the provincial synods of Illiberis (Elvira) in 305 and of Ancyra in 315 subsequently came to conflicting decisions, the council of Elvira forbidding the reception of offenders into communion during life, and the council of Ancyra fixing a limit to the penalty in the same cases. But the excommunication was on all hands regarded as being "medicinal" in its character. It is noteworthy that the word *ἀνάθεμα* had fallen into disuse about the beginning of the 4th century, and that, throughout the same period, no instance of the judicial use of the phrase *παράδοῦναι τῷ Σατανᾷ* can be found.

A new chapter in the history of the church censure may be said to have begun with the publication of those imperial edicts against heresy, the first of which, *De summa trinitate et fide catholica*, dates from 380. Till then exclusion from church privileges had been a spiritual discipline merely; thenceforward it was to expose a man to serious temporal risks. Excommunication still continued to be occasionally used in the spirit of genuine Christian fidelity, as by Ambrose in the case of Theodosius himself (390); but the temptation to wield it as an instrument of secular tyranny too often proved to be irresistible. The church fell back on carnal weapons in her warfare and invoked the secular powers to uphold the ecclesiastical. In the formula used by Synesius (410) which is to be found in Bingham's *Antiquities*,

we already find the attention of magistrates specially called to the censured person. The history of the next thousand years shows that the magistrates were seldom slow to respond to the appeal. Even the hastiest survey of that long and interesting period enables the student to notice a marked development in the theory and practice of excommunication. One or two points may be specially noted. (1) When the Empire became nominally Christian and the quality of the church life was sacrificed to the quantity of its adherents, the original character of excommunication was lost. The power of excommunication was transferred from the community to the bishop, and was liable to abuse for personal motives: Gregory the Great rebukes a bishop for using for private ends power conferred for the public good (*Epist.* ii. 34). Excommunication became a common penalty applied in numberless cases (see the *Penitential* of Archbishop Theodosius: Haddan and Stubbs, *Councils and Documents*, iii. 1737), and was invested with superstitious terrors. (2) While it had been held as an undoubted principle by the ancient church that this sentence could only be passed on living individuals whose fault had been distinctly stated and fully proved, we find the medieval church on the one hand sanctioning the practice of excommunication of the dead (Morinus, *De poenit.* x. c. 9), and, on the other hand, by means of the papal interdict, excluding whole countries and kingdoms at once from the means of grace. The earliest well-authenticated instance of such an interdict is that which was passed (998) by Pope Gregory V. on France, in consequence of the contumacy of King Robert the Wise. Other instances are those laid respectively on Germany in 1102 by Gregory VII. (Hildebrand), on England in 1208 by Innocent III., on Rome itself in 1155 by Adrian IV. (3) While in the ancient church the language used in excommunicating had been carefully measured, we find an amazing recklessness in the phraseology employed by the medieval clergy. The curse of Ernulfus or Arnulphus of Rochester (c. 1100), often quoted by students of English literature, is a very fair specimen of that class of composition. With it may be compared the formula transcribed by Dr Burton in his *History of Scotland* (iii. 317 ff.). To the spoken word was added the language of symbol. By means of lighted candles violently dashed to the ground and extinguished the faithful were graphically taught the meaning of the greater excommunication—though in a somewhat misleading way, for it is a fundamental principle of the canon law that *disciplina est. excommunicatio, non eradicatio*. The first instance, however, of excommunication by "bell, book and candle" is comparatively late (c. 1190).

5. *Modern Survivals in Existing Christian Churches.*—At the Reformation the necessity for church discipline did not cease to be recognized; but the administration of it in many Reformed churches has passed through a period of some confusion. In some instances the old episcopal power passed more or less into the hands of the civil magistrate (a state of matters which was highly approved by Erastus and his followers), in other cases it was conceded to the presbyterial courts. In the Anglican Church the bishops (subject to appeal to the sovereign) have the right of excommunicating, and their sentence, if sustained, may in certain cases carry with it civil consequences. But this right is in practice never exercised. In the law of England sentence of excommunication, upon being properly certified by the bishop, was followed by the writ *de excommunicato capiendo* for the arrest of the offender. The statute 5 Eliz. c. 23 provided for the better execution of this writ. By the 53 Geo. III. c. 127 (which does not, however, extend to Ireland) it was enacted that "excommunication, together with all proceedings following thereupon, shall in all cases, save those hereafter to be specified, be discontinued." Disobedience to or contempt of the ecclesiastical courts is to be punished by a new writ, *de contumace capiendo*, to follow on the certificate of the judge that the defender is contumacious and in contempt. Sect. 2 provides that nothing shall prevent "any ecclesiastical court from pronouncing or declaring persons to be excommunicate on definite sentences pronounced as spiritual censures for offences of ecclesiastical cognizance." No persons so excommunicated

shall incur any civil penalty or incapacity whatever, save such sentence of imprisonment, not exceeding six months, as the court shall direct and certify to the king in chancery.

In the churches which consciously shaped their polity at or after the Reformation the principle of excommunication is preserved in the practice of church discipline. Calvin devotes a chapter in the *Institutes* (bk. iv. chap. xii.) to the "Discipline of the Church; its Principal Use in Censure and Excommunication." The three ends proposed by the church in such discipline are there stated to be, (1) that those who lead scandalous lives may not to the dishonour of God be numbered among Christians, seeing that the church is the body of Christ; (2) that the good may not be corrupted by constant association with the wicked; (3) that those who are censured or excommunicated, confounded with shame, may be led to repentance. He differentiates decisively between excommunication and anathema. "When Christ promises that what his ministers bind on earth shall be bound in heaven, he limits the power of binding to the censure of the church; by which those who are excommunicated are not cast into eternal ruin and condemnation, but by having their life and conduct condemned are also certified of their final condemnation unless they repent. For excommunication differs from anathema: anathema which ought to be very rarely, or never, resorted to, in precluding all pardon, execrates a person, and devotes him to eternal perdition: whereas excommunication rather censures and punishes his conduct. Yet in such a manner by warning him of his future condemnation it recalls him to salvation" (*Inst.* bk. iv. chap. xii. 10). The Reformed churches in England and America accepted the distinction between public and private offences. The usual provision is that private offences are to be dealt with according to the rule in Matt. v. 23-24, xviii. 15-17; public offences are to be dealt with according to the rule in 1 Cor. v. 3-5, 13. The public expulsion or suspension of the offender is necessary for the good repute of the church, and its influence over the faithful members. The expelled member may be readmitted on showing the fruits of repentance.

In Scotland three degrees of church censure are recognized—admonition, suspension from sealing ordinances (which may be called temporary excommunication), and excommunication properly so-called. Intimation of the last-named censure may occasionally (but very rarely) be given by authority of a presbytery in a public and solemn manner, according to the following formula:—"Whereas thou N. hast been by sufficient proof convicted (here mention the sin) and after due admonition and prayer remainest obstinate without any evidence or sign of true repentance: Therefore in the name of the Lord Jesus Christ, and before this congregation, I pronounce and declare thee N. excommunicated, shut out from the communion of the faithful, debar thee from privileges, and deliver thee unto Satan for the destruction of thy flesh, that thy spirit may be saved in the day of the Lord Jesus." This is called the greater excommunication. The congregation are thereafter warned to shun all unnecessary converse with the excommunicate (see *Form of Process*, c. 8). Formerly excommunicated persons were deprived of feudal rights in Scotland; but in 1690 all acts enjoining civil pains upon sentences of excommunication were finally repealed (*Burton's History*, vii. 435).

The question whether the power of excommunication rests in the church or in the clergy has been an important one in the history of English and American churches. Hooker lays down (*Survey*, pt. 3, pp. 33-46) four necessary conditions for the execution of a sentence involving church discipline. "(1) The cause exactly recorded is fully and nakedly to be presented to the consideration of the congregation. (2) The elders are to go before the congregation in laying open the rule so far as reacheth any particular now to be considered, and to express their judgment and determination thereof, so far as appertains to themselves. (3) Unless the people be able to convince them of errors and mistakes in their sentence, they are bound to join their judgment with theirs to the completing of the sentence. (4) The sentence thus completely issued is to be solemnly passed and pronounced upon the delinquent by the ruling Elder whether

it be of censure or excommunication." In this passage it is clear that the effective power of discipline is regarded as being wholly in the power of the individual church or congregation. Hooker expressly denies the power of synods to excommunicate: "that there should be Synods, which have *potestatem juridicam* is nowhere proved in Scripture because it is not a truth" (*Survey*, pt. 4, pp. 48, 49).

The confession of faith issued by the London-Amsterdam church (the original of the Pilgrim Fathers' churches) in 1596 declares that the Christian congregation having power to elect its minister has also power to excommunicate him if the case so require (Walker, *Creeds and Platforms of Congregationalism*, p. 66). In 1603 the document known as "Points of Difference" (*i.e.* from the established Anglicanism) submitted to James I. sets forth: "That all particular Churches ought to be so constituted as, having their owne peculiar Officers, the whole body of every Church may meet together in one place, and jointly performe their duties to God and one towards another. And that the censures of admonition and excommunication be in due manner executed, for sinne, convicted, and obstinately stood in. This power also to be in the body of the Church whereof the parties so offending and persisting are members." The *Cambridge Platform* of 1648 by which the New England churches defined their practice, devotes ch. xiv. to "excommunication and other censures." It follows in the main the line of Hooker and Calvin, but adds (§6) an important definition: "Excommunication being a spirituall punishment it doth not prejudice the excommunicate in, nor deprive him of his *civil* rights, therefore toucheth not princes, or other magistrates, in point of their civil dignity or authority. And, the excommunicate being but as a publican and a heathen, heathen being lawfully permitted to come to hear the word in church assemblies; wee acknowledge therefore the like liberty of hearing the word, may be permitted to persons excommunicate, that is permitted unto heathen. And because wee are not without hope of his recovery, wee are not to account him as an enemy but to admonish him as a brother." The Savoy Declaration of 1658 defines the theory and practice of the older English Nonconformist churches in the section on the "Institution of Churches and the Order appointed in them by Jesus Christ" (xix.). The important article is as follows:—"The Censures so appointed by Christ, are Admonition and Excommunication; and whereas some offences are or may be known onely to some, it is appointed by Christ, that those to whom they are so known, do first admonish the offender in private: in publique offences where any sin, before all; or in case of non-amendment upon private admonition, the offence being related to the Church, and the offender not manifesting his repentance, he is to be duely admonished in the Name of Christ by the whole Church, by the Ministry of the Elders of the Church, and if this Censure prevail not for his repentance, then he is to be cast out by Excommunication with the consent of the Church."

In contemporary English Free Churches the purity of the church is commonly secured by the removal of persons unsuitable for membership from the church books by a vote of the responsible authority. (D. Mn.)

EXCRETION (Lat. *ex*, out of, *cernere*, *cretum*, to separate), in plant and animal physiology, the separation from an organ of some substance, also the substance separated. The term usually refers to the separation of waste or harmful products, as distinguished from "secretion," which refers to products that play a useful or necessary part in the functions of the organism.

EXECUTION (from Lat. *ex-sequor*, *exsecutus*, follow or carry out), the carrying into effect of anything, whether a rite, a piece of music, an office, &c.; and so sometimes involving a notion of skill in the performance. Technically, the word is used in law in the *execution* of a deed (its formal signing and sealing), an *execution* (see below) by the sheriff's officers under a "writ of execution" (the enforcement of a judgment on a debtor's goods); and *execution of death* has been shortened to the one word to denote CAPITAL PUNISHMENT (*q.v.*).

Civil Execution may be defined as the process by which the

judgments or orders of courts of law are made effectual. In Roman law the earliest mode of execution was the seizure, legalized by the *actio per manus injectionem*, of the debtor as a slave of the creditor. During the later Republic, imprisonment took the place of slavery. Under the régime of the *actio per manus injectionem*, the debtor might dispute the debt—the issue being raised by his finding a substitute (*vindex*) to conduct the case for him. By the time of Gaius (iv. 25) the *actio per manus injectionem* had been superseded by the *actio iudicati*, the object of which was to enable the creditor to take payment of the debt or compel the debtor to find security (*pignus in causa iudicati captum*: *Cautio iudicatum solvi*), and in A.D. 320 Constantine abolished imprisonment for debt, unless the debtor were contumacious. The time allowed for payment of a judgment debt was by the XII. Tables 30 days; it was afterwards extended to two months, and ultimately, by Justinian, to four months. The next stage in the Roman law of execution was the recognition of bankruptcy either against the will of the bankrupt (*missio in bona*) or on the application of the bankrupt (*cessio bonorum*; and see BANKRUPTCY). Lastly, in the time of Antoninus Pius, judgment debts were directly enforced by the seizure and sale of the debtor's property. Slaves, oxen and implements of husbandry were privileged; and movable property was to be exhausted before recourse was had to land (see Hunter, *Roman Law*, 4th ed. pp. 1029 et seq., Sohm, *Inst. Rom. Law*, 2nd ed. pp. 302-305).

GREAT BRITAIN.—The English law of execution is very complicated, and only a statement of the principal processes can here be attempted.

High Court.—*Fieri Facias.* A judgment for the recovery of money or costs is enforced, as a rule, by writ of *feri facias* addressed to the sheriff, and directing him to cause to be made (*feri facias*) of the goods and chattels of the debtor a levy of a sum sufficient to satisfy the judgment and costs, which carry interest at 4% per annum. The seizure effected by the sheriff or his officer, under this writ, of the property of the debtor, is what is popularly known as "the putting-in" of an execution. The seizure should be carried out with all possible despatch. The sheriff or his officer must not break open the debtor's house in effecting a seizure, for "a man's house is his castle" (*Semayne's Case* [1604], 5 Coke Rep. 91); but this principle applies only to a dwelling-house, and a barn or outhouse unconnected with the dwelling-house may be broken into. The sheriff on receipt of the writ endorses on it the day, hour, month and year when he received it; and the writ binds the debtor's goods as at the date of its delivery, except as regards goods sold before seizure in market overt, or purchased for value, without notice before actual seizure (Sale of Goods Act 1893, s. 26, which supersedes s. 16 of the Statute of Frauds and s. 1 of the Mercantile Law Amendment Act 1856). This rule is limited to goods, and does not apply to the money or bank notes of the debtor which are not bound by the writ till seized under it (*Johnson v. Pickering*, Oct. 14, 1907, C.A.). The mere seizure of the goods, however, although, subject to such exceptions as those just stated, it binds the interest of the debtor, and gives the sheriff such an interest in the goods as will enable him to sue for the recovery of their possession, does not pass the property in the goods to the sheriff. The goods are in the custody of the law. But the property remains in the debtor who may get rid of the execution on payment of the claim and fees of the sheriff [as to which see Sheriffs Act 1887, s. 20, and order of 21st of August 1888, *Annual Practice* (1908), vol. ii. p. 278]. The wearing apparel, bedding, tools, &c., of the debtor to the value of £5 are protected. Competing claims as to the ownership of the goods seized are brought before the courts by the procedure of "interpleader." After seizure, the sheriff must retain possession, and, in default of payment by the execution debtor, proceed to sell. Where the judgment debt, including legal expenses, exceeds £20, the sale must be by public auction, unless the Court otherwise orders, and must be publicly advertised. The proceeds of sale, after deduction of the sheriff's fees and expenses, become the property of the execution creditor to the extent of his claim. The Bankruptcy Act 1890 (53 & 54 Vict. c. 71, s. 11 [2]) requires the sheriff in case of sale under a judgment for a sum exceeding £20 to hold the proceeds for 14 days in case notice of bankruptcy proceedings should be served upon him (see BANKRUPTCY). The form of the writ of *feri facias* requires the sheriff to make a return to the writ. In practice this is seldom done unless the execution has been ineffective or there has been delay in the execution of the writ; but the judgment creditor may obtain an order calling on the sheriff to make a return. A sheriff or his officer, who is guilty of extortion in the execution of the writ, is liable to committal for contempt, and to forfeit £200 and pay all damages suffered by the person aggrieved (Sheriffs Act 1887 [50 & 51 Vict. c. 55], s. 29 [2]), besides being civilly liable to such person. Imprisonment for debt in execution of civil judgments is

now abolished except in cases of default in the nature of contempt, unsatisfied judgments for penalties, defaults by persons in a fiduciary character, and defaults by judgment debtors (Debtors Act 1869 [32 & 33 Vict. c. 62]; Bankruptcy Act 1883 [46 & 47 Vict. c. 52], ss. 53, 103). Imprisonment for debt has been abolished within similar limits in Scotland (Debtors [Scotland] Act 1880 [43 & 44 Vict. c. 34] and Ireland, Debtors [Ireland] Act 1872, 35 & 36 Vict. c. 57). There may still be imprisonment in England, under the writ—rarely used in practice—*ne exeat regno*, which issues to prevent a debtor from leaving the kingdom.

Writ of Elegit.—The writ of *elegit* is a process enabling the creditor to satisfy his judgment debt out of the lands of the debtor. It derives its name from the election of the creditor in favour of this mode of recovery. It is founded on the Statute of Westminster (1285, 13 Ed. 1. c. 18), under which the sheriff was required to deliver to the creditor all the chattels (except oxen and beasts of the plough) and half the lands of the debtor until the debt was satisfied. By the Judgments Act 1838 the remedy was extended to all the debtor's lands, and by the Bankruptcy Act 1883 the writ no longer extends to the debtor's goods. The writ is enforceable against legal interests whether in possession or remainder (*Hood-Barrs v. Cathcart*, 1895, 2 Ch. 411), but not against equitable interests in land (*Earl of Jersey v. Uxbridge Rural Sanitary Authority*, 1891, 3 Ch. 183). When the debtor's interest is equitable, recourse is had to equitable execution by the appointment of a receiver or to bankruptcy proceedings.

The writ is directed to the sheriff, who, after marking on it the date of its receipt, at once in pursuance of its directions holds an inquiry with a jury as to the nature and value of the interest of the debtor in the lands extended under the writ, and delivers to the creditor at a reasonable price and extent in accordance with the writ, the lands of which the debtor was possessed in the bailiwick. When the sheriff has returned and filed a record (in the central office of the High Court) of the writ and the execution thereof, the execution creditor becomes "tenant to the elegit." Where the land is freehold the creditor acquires only a chattel interest in it; where the land is leasehold he acquires the whole of the debtor's interest (*Johns v. Pink*, 1900, 1 Ch. 296). The creditor is entitled to hold the land till his debt is satisfied, or enough to satisfy it is tendered to him, and under the Judgments Act 1864 the creditor may obtain an order for sale. Until the land is delivered on execution and the writs which have effected the delivery are registered in the Land Registry, the judgment does not create any charge on the land so as to fetter the debtor's power of dealing with it. Land Charges Registration Acts 1888 and 1900. (See R.S.C., O. xliii.)

Writs of Possession and Delivery.—Judgments for the recovery or for the delivery of the possession of land are enforceable by writ of possession. The recovery of specific chattels is obtained by writ of delivery (R.S.C., O. xlvii., xlviii.).

Writ of Sequestration.—Where a judgment directing the payment of money into court, or the performance by the defendant of any act within a limited time, has not been complied with, or where a corporation has wilfully disobeyed a judgment, a writ of sequestration is issued, to not less than four sequestrators, ordering them to enter upon the real estate of the party in default, and "sequester" the rents and profits until the judgment has been obeyed (R.S.C., O. xliii. r. 6).

Equitable Execution.—Where a judgment creditor is otherwise unable to reach the property of his debtor he may obtain equitable execution, usually by the appointment of a receiver, who collects the rents and profits of the debtor's land for the benefit of the creditor (R.S.C., O. l. rr. 15A-22). But receivers may be appointed of interests in personal property belonging to the debtor by virtue of the Judicature Act 1873, s. 25 (8).

Attachment.—A judgment creditor may "attach" debts due by third parties to his debtor by what are known as garnishee proceedings. Stock and shares belonging to a judgment debtor may be charged by a charging order, so as, in the first instance, to prevent transfer of the stock or payment of the dividends, and ultimately to enable the judgment creditor to realise his charge. A writ of attachment of the person of a defaulting debtor or party may be obtained in a variety of cases akin to contempt (e.g. against a person failing to comply with an order to answer interrogatories, or against a solicitor not entering an appearance in an action, in breach of his written undertaking to do so), and in the cases where imprisonment for debt is still preserved by the Debtors Act 1869 (R.S.C., O. xlv.). CONTEMPT OF COURT (*q.v.*) in its ordinary forms is also punishable by summary committal.

County Courts.—In the county courts the chief modes of execution are "warrant of execution in the nature of a writ of *feri facias*"; garnishee proceedings; equitable execution; warrants of possession and delivery, corresponding to the writs of possession and delivery above mentioned; committal, where a judgment debtor has, or, since the date of the judgment has had, means to pay his debt; and attachment of the person for contempt of court. If the judgment debtor assaults the bailiff or his officer or rescues the goods, he is liable to a fine not exceeding £5.

SCOTLAND.—The principal modes of execution or "diligence" in Scots law are (i.) Arrestment and furthcoming, which corresponds to the English garnishee proceedings; (ii.) arrestment *jurisdictionis fundandae causa*, i.e. the seizure of movables within the jurisdiction

to found jurisdiction against their owner, being a foreigner; this procedure, which is not, however, strictly a "diligence," as it does not bind the goods, is analogous to the French *saisie-arrêt*, and to the obsolete practice in the mayor's court of London known as "foreign attachment" (see Glyn and Jackson, *Mayor's Court Practice*, 2nd ed., vii. 260); (iii.) arrestment under *mediatione fugae* warrant, corresponding to the old English writ of *ne exeat regno*, and applicable in the case of a debtor who intends to leave Scotland to evade an action; (iv.) arrestment on dependence, *i.e.* of funds in security; (v.) pouncing, *i.e.* valuation and sale of the debtor's goods; (vi.) sequestration, *e.g.* of tenant's effects under a landlord's hypothec for rent; (vii.) action of adjudication, by which a debtor's "heritable" (*i.e.* real) estate is transferred to his judgment creditor in satisfaction of his debt or security therefor. In Scots law "multiplepounding" is the equivalent of "interpleader."

IRELAND.—The law of execution in Ireland (see R.S.C., 1905, Orders xli.-xlviii.) is practically the same as in England.

BRITISH POSSESSIONS.—The Judicature Acts of most of the Colonies have also adopted English Law. Parts of the French *Code de procédure civile* are still in force in Mauritius. But its provisions have been modified by local enactment (No. 19 of 1868) as regards realty, and the rules of the Supreme Court 1903 have introduced the English forms of writs. Quebec and St Lucia, where French law formerly prevailed, have now their own codes of Civil Procedure. The law of execution under the Quebec Code resembles the French, that under the St Lucia Code the English system. In British Guiana and Ceylon, in which Roman Dutch law in one form or another prevailed, the English law of execution has now in substance been adopted (British Guiana Rules of Court, 1900, Order xxxvi.), Ceylon (Code of Civil Procedure, No. 2 of 1889); the modes of execution in the South African Colonies are also the subject of local enactment, largely influenced by English law (*cf.* the Sheriffs' Ordinance, 1902, No. 9 of 1902), (Orange River Colony) and (Proclamation 17 of 1902), Transvaal (Nathan, *Common Law of South Africa*, vol. iv. p. 2206); and generally, Van Zyl, *Judicial Practice of South Africa*, pp. 198 et seq.

UNITED STATES.—Execution in the United States is founded upon English law, which it closely resembles. Substantially the same forms of execution are in force. The provisions of the Statute of Frauds making the lien of execution attach only on delivery to the sheriff were generally adopted in America, and are still law in many of the states. The law as to the rights and duties of sheriffs is substantially the same as in England. The "homestead laws" (*q.v.*) which are in force in nearly all the American States exempt a certain amount or value of real estate occupied by a debtor as his homestead from a forced sale for the payment of his debts. This homestead legislation has been copied in some British colonies, *e.g.* Western Australia (No. 37 of 1898, Pt. viii.), Quebec (Rev. Stats., ss. 1743-1748), Manitoba (Rev. Stats., 1902, c. 58, s. 29, c. 21, s. 9), Ontario (Rev. Stats., 1897, c. 29), British Columbia (Rev. Stats., 1897, c. 93), New South Wales (Crown Lands Act 1895, Pt. iii.), New Zealand (Family Homes Protection Act 1895, No. 20 of 1895).

FRANCE.—Provisional execution (*saisie-arrêt*) with a view to obtain security has been already mentioned. Execution against personalty (*saisie-exécution*) is preceded by a *commandement* or summons, personally served upon, or left at the domicile of the debtor calling on him to pay. The necessary bedding of debtors and of their children residing with them, and the clothes worn by them, cannot be seized in execution under any circumstances. Objects declared by law to be immovable by destination (*immeubles par destination*), such as beasts of burden and agricultural implements, books relating to the debtor's profession, to the value of 300 francs, workmen's tools, military equipments, provisions and certain cattle cannot be seized, even for a debt due to Government, unless in respect of provisions furnished to the debtor, or amounts due to the manufacturers or vendors of protected articles or to parties who advanced moneys to purchase, manufacture or repair them. Growing fruits cannot be seized except during the six weeks preceding the ordinary period when they become ripe. Execution against immovable property (*la saisie immobilière*) is preceded also by a summons to pay, and execution cannot issue until the expiry of 30 days after service of such summons (see further Code Proc. Civ., Arts. 673-689). Imprisonment for debt was abolished in all civil and commercial matters by the law of 22nd of July 1867, which extends to foreigners. It still subsists in favour of the State for non-payment of fines, &c. The French system is in substance in force in Belgium (Code Civ. Proc., Arts. 51 et seq.), the Netherlands (Code Civ. Proc., Arts. 430 et seq.), Italy (Code Civ. Proc., Arts. 553 et seq., 659 et seq.), and Spain.

GERMANY.—Under the German Code of Civil Procedure (Arts. 796 et seq.), both the goods and (if the goods do not offer adequate security) the person of the debtor may be seized (the process is called *arrest*) as a guarantee of payment. The debtor's goods cannot be sold except in pursuance of a judgment notified to the debtor either before or within a prescribed period after the execution (Art. 809 [3], and law of 30th of April 1886). Imprisonment for debt in civil and commercial matters has been abolished or limited on the lines of the French law of 1867 in many countries (*e.g.* Italy, law of the 6th of December 1877; Belgium, law of the 27th of July 1871; Greece, law of the 9th of March 1900; Russia, decree of the 7th of March 1879).

AUTHORITIES.—Anderson, *Execution* (London, 1889); *Annual Practice* (London, 1908); Johnston Edwards, *Execution* (London, 1888); Mather, *Sheriff Law* (London, 1903). As to Scots law, Mackay, *Manual of Practice* (Edinburgh, 1893). As to American law, Bingham, *Judgments and Executions* (Philadelphia, 1836); A. C. Freeman, *Law of Execution, Civil Cases* (3rd ed., San Francisco, 1900); H. M. Herman, *Law of Executions* (New York, 1875); American Notes to *tit.* "Execution," in *Ruling Cases* (London and Boston, 1897); Bouvier, *Law Dict.*, ed. Rawle (1897), *s.v.* "Execution."

EXECUTORS AND ADMINISTRATORS, in English law, those persons upon whom the property of a deceased person both real and personal devolves according as he has or has not left a will. Executors differ from administrators both in the mode of their creation and in the date at which their estate vests. An executor can only be appointed by the will of his testator; such appointment may be express or implied, and in the latter case he is said to be an executor "according to the tenor." The estate of an executor vests in him from the date of the testator's death. An administrator on the other hand is appointed by the probate division of the High Court, and his estate does not vest till such appointment, the title to the property being vested till then in the judge of the probate division. As to whom the court will appoint administrators and the various kinds of administrators see under ADMINISTRATION. Apart from these two points the rights and liabilities of executors and administrators are the same, and they may be indifferently referred to as the representative of the deceased. As to their appointment before the establishment of the court of probate see articles WILL and INTESACY. Before the Land Transfer Act 1897, the real estate of the deceased did not devolve upon the representative but vested directly in the devisee or heir-at-law, but by that act it was provided that the personal representative should be also the real representative, and therefore it may now be said broadly that the representative takes the whole estate of the deceased. There are, however, a few minor exceptions to this rule, of which the most important are lands held in joint tenancy and copyhold lands. As the representative stands in the shoes of the deceased he is entitled to sue upon any contract or for any debt which the deceased might have sued in his lifetime.

The duties of a representative are as follows: 1. To bury the deceased in a manner suitable to the estate he leaves behind him; and the expenses of such funeral take precedence of any duty or debt whatever; but extravagant expenses will not be allowed. No rule can be laid down as to what is a reasonable allowance for this purpose, as it is impossible to know at the time of the funeral what the estate of the deceased may amount to. The broad rule is that the representative must allow such sum as seems reasonable, having regard to all the circumstances of the case and the conditions in life of the deceased, remembering that if he should exceed this he will be personally liable for such excess in the event of the estate proving insolvent.

2. He must obtain probate or letters of administration to the deceased within six months of the death, or, if such grant be disputed, within two months of the determination of such suit. The penalty for not doing so is fixed by the Stamp Act 1815, § 37, at £100, and an additional stamp duty at the rate of 10%. As to the formalities of PROBATE see that article.

3. Strictly speaking, he must compile an inventory of all the estate of the deceased, whether in possession or outstanding, and he is to deliver it to the court on oath. He is to collect all the goods so inventoried and to commence actions to get in all those outstanding, and he is responsible to creditors for the whole of such estate, whether in possession or in action. This duty is thrown upon the representative by an act of 1529, but it is not the modern practice to exhibit such inventory unless he be cited for it in the spiritual court at the instance of a party interested. It is, however, necessary to file an affidavit setting out the value of the estate of the deceased upon applying for a grant of probate or letters of administration.

4. The representative must pay the debts of the deceased according to their priority. Next to the legitimate funeral expenses come the costs of proving and administering the estate; in the event, however, of the funeral and testamentary expenses being charged by the will upon any particular fund, they will be primarily payable out of that fund. The representative must be careful to pay the debts according to the rules of priority, otherwise he will become personally liable to the creditors of one degree if he has exhausted the estate in paying creditors of a lesser degree. First of all, a solicitor has a lien for his costs upon any fund or duty which he has recovered for the deceased; next in order come debts due to the crown by record or speciality; then debts given a priority by statute, as, for example, by the Poor Relief Act 1743, money due by an overseer of the poor to his parish. Next, debts of record, *i.e.*

judgment recovered against the deceased in any court of record; all such debts are equal among themselves, but a judgment creditor who has sued out execution is preferred to one who has not; another class of debts of record are statutes merchant and staple, or recognizances in the nature of statute staple, *i.e.* bonds of record acknowledged before the lord mayor of London or the mayor of the staple. Last in the order of debts come specialty and simple contract debts, which by Hinde Palmer's Act (the Executors Act 1869) are of equal degree, though as between specialty debts bonds given for value rank before voluntary bonds unless assigned for value, and as between simple contract debts those due to the crown have priority. Though the creditors can if necessary take all the estate of the deceased to satisfy their claims, yet as between the various classes of assets the representative must pay the debts out of assets in the following order: (i.) General personal estate not specifically bequeathed nor exempted from payment of debts; (ii.) real estate appropriated to debts; (iii.) real estate descended; (iv.) real estate devised charged with payment of debts; (v.) general pecuniary legacies *pro rata*; (vi.) specific legacies and devises; (vii.) real estate over which a general power of appointment has been exercised by will; (viii.) the widow's paraphernalia.

5. The debts of the deceased being satisfied, the representative must next proceed to satisfy the legacies and devises left by the testator. In order to enable him to do this with safety to himself, it is provided that he cannot be compelled to divide the estate among the legatees or next of kin until twelve months from the death of the deceased (this is commonly known as "the executor's year"), though if there is no doubt as to the solvency of the estate he may do so at once. As a further protection the representative may give notice by advertisement for creditors to send in their claims against the estate, and on expiration of the notices he may proceed to divide the estate, though even then the creditor may follow the assets to the person who has received them and recover for his debt. As between legatees the following priorities must be observed: (1) Specific legatees and devisees, (2) demonstrative legatees, and (3) general legatees; and as to this last class the testator can give priority to one over another. If there are not sufficient assets to pay the general legatees they must abate rateably. Legacies were not payable out of the real estate prior to the Land Transfer Act 1897, unless the testator charged the realty with them. Even then unless the testator exonerates his personalty from payment of the legacies the personalty will be the first fund chargeable. It has been suggested that the effect of the act is to make the realty chargeable *pro rata* with the personalty, but this is doubtful.

6. The residue, after all legacies and devises are satisfied, must, if there be a will, be paid to the residuary legatee therein named, and if there be no will the real estate will go to the heir (see INHERITANCE) and the personalty to the next of kin (see TESTACY). It was held at one time that in default of a residuary legatee the residue fell to the executor himself, but now nothing less than the expressed intention of the testator can give it to him.

The liabilities of the representative may be shortly stated. He is liable in his representative capacity in all cases where the deceased would be liable were he alive. To this general rule there are some exceptions. The representative cannot be sued for breach of a contract for personal services which can be performed only in the lifetime of the person contracting, nor again can he be sued in a case where unliquidated damages only could have been recovered against the deceased. He is liable in his personal capacity in the following cases: if he contracts to pay a debt due by the deceased, or if having admitted that he had assets in his hands sufficient to pay a debt or legacy he has misapplied such assets so that he cannot satisfy them; or lastly, if by mismanaging the estate and effects of the deceased he has made himself liable for a *devastavit*. Shortly stated, a representative is bound to exercise the ordinary care of a business man in administering the estate of the deceased, and he will be liable for the loss to the estate caused by his own negligence, or by the negligence of a co-representative which his act or neglect has rendered possible. Though the general rule of *delegatus non potest delegari* holds good of a representative, yet in certain cases he may "rely upon skilled persons in matters in which he cannot be expected to be experienced," *e.g.* he must employ solicitors to conduct a lawsuit.

The privileges of the representative are these: he may prefer one creditor to another of equal degree; he may retain a debt owing to him from the deceased as against other creditors of equal degree (see RETAINER); he may reimburse himself out of the estate all expenses incurred in the execution of his trust.

An executor *de son tort* is one who, without any title to do so, wrongfully intermeddles with the assets of the deceased, dealing with them in such a way as to hold himself out as executor. In such a case he is subject to all the liabilities of an executor, and can claim none of the privileges. He may be treated by the creditor as the executor, and, if he is really assuming to act as executor, creditors and legatees will get a good title from him, but he is liable to be sued by the rightful representative for damages for interfering with the property of the deceased.

Scotland.—Executor in Scots law is a more extensive term than in English. He is either nominative or dative, the latter appointed by the court and corresponding in most respects to the English

administrator. Caution is required from the latter, not from the former. By the common law doctrine of passive representation the heir or executor was liable to be sued for implement of the deceased's obligations. The Roman principle of *beneficium inventarii* was first introduced by an act of 1695. As the law at present stands, the heir or executor is liable only to the value of the succession, except where there has been vitious intromission in movables, and in *gestio pro haerede* (behaviour as heir) and other cases in heritables. The present inventory duty on succession to movables and heritables depends on the Finance Acts 1894–1909 (see ESTATE DUTY). In England the executor is bound to pay the debts of the deceased in a certain order, but in Scotland they all rank *pari passu* except privileged debts (see PRIVILEGE).

AUTHORITIES.—R. L. Vaughan Williams, *The Law of Executors and Administrators*; W. G. Walker, *Compendium on the Law of Executors and Administrators*; James Schouler, *Law of Executors and Administrators* (3rd ed., Boston, 1901).

EXEDRA, or EXHEDRA (from Gr. ἔξ, out, and ἔδρα, a seat), an architectural term originally applied to a seat or recess out of doors, intended for conversation. Such recesses were generally semicircular, as in the important example built by Herodes Atticus at Olympia. In the great Roman thermae (baths) they were of large size, and like apses were covered with a hemispherical vault. An example of these exists at Pompeii in the Street of the Tombs. From Vitruvius we learn that they were often covered over, and they are described by him (v. 11) as places leading out of porticoes, where philosophers and rhetoricians could debate or harangue.

EXELMANS, RENÉ JOSEPH ISIDORE, COUNT (1775–1852), marshal of France, was born at Bar-le-Duc on the 13th of November 1775. He volunteered into the 3rd battalion of the Meuse in 1791, became a lieutenant in 1797, and in 1798 was aide-de-camp to General Éblé, and in the following year to General Broussier. In his first campaign in Italy he greatly distinguished himself; and in April 1799 he was rewarded for his services by the grade of captain of dragoons. In the same year he took part with honour in the conquest of Naples and was again promoted, and in 1801 he became aide-de-camp to General Murat. He accompanied Murat in the Austrian, Prussian and Polish campaigns of 1805, 1806 and 1807. At the passage of the Danube, and in the action of Wertingen, he specially distinguished himself; he was made colonel for the valour which he displayed at Austerlitz, and general of brigade for his conduct at Eylau in 1807. In 1808 he accompanied Murat to Spain, but was there made prisoner and conveyed to England. On regaining his liberty in 1811 he went to Naples, where King Joachim Murat appointed him grand-master of horse. Exelmans, however, rejoined the French army on the eve of the Russian campaign, and on the field of Borodino won the rank of general of division. In the retreat from Moscow his steadfast courage was conspicuously manifested on several occasions. In 1813 he was made, for services in the campaign of Saxony and Silesia, grand-officer of the Legion of Honour, and in 1814 he reaped additional glory by his intrepidity and skill in the campaign of France. When the Bourbons were restored, Exelmans retained his position in the army. In January 1815 he was tried on an accusation of having treasonable relations with Murat, but was acquitted. Napoleon on his return from Elba made Exelmans a peer of France and placed him in command of the II. cavalry corps, which he commanded in the Waterloo campaign, the battle of Ligny and Grouchy's march on Wavre. In the closing operations round Paris Exelmans won great distinction. After the second Restoration he denounced, in the House of Peers, the execution of Marshal Ney as an "abominable assassination"; thereafter he lived in exile in Belgium and Nassau for some years, till 1819, when he was recalled to France. In 1828 he was appointed inspector-general of cavalry; and after the July revolution of 1830 he received from Louis Philippe the grand cross of the Legion of Honour, and was reinstated as a peer of France. At the revolution of 1848 Exelmans was one of the adherents of Louis Napoleon; and in 1851 he was, in recognition of his long and brilliant military career, raised to the dignity of a marshal of France. His death, which took place on the 10th of July 1852, was the result of a fall from his horse.

EXEQUATUR, the letter patent, issued by a foreign office and signed by a sovereign, which guarantees to a foreign consul the rights and privileges of his office, and ensures his recognition in the state in which he is appointed to exercise them. If a consul is not appointed by commission he receives no exequatur; and a notice in the *Gazette* in this case has to suffice. The exequatur may be withdrawn, but in practice, where a consul is obnoxious, an opportunity is afforded to his government to recall him.

EXETER, EARL, MARQUESS AND DUKE OF. These English titles have been borne at different times by members of the families of Holand or Holland, Beaufort, Courtenay and Cecil. The earls of Devon of the family of de Redvers were sometimes called earls of Exeter; but the 1st duke of Exeter was JOHN (c. 1355–1400), a younger son of Thomas Holand, earl of Kent (d. 1360). John's mother, Joan (d. 1385), a descendant of Edward I., married for her third husband Edward the Black Prince, by whom she was the mother of Richard II., and her son John was thus the king's half-brother, a relationship to which he owed his high station at the English court. He married Elizabeth (d. 1426), a daughter of John of Gaunt, duke of Lancaster, and was constantly in Richard's train until 1385, when his murder of Ralph Stafford disturbed these friendly relations. John then went to Spain as constable of the English army under John of Gaunt; but after his return to England in 1387 he was created earl of Huntingdon, was made admiral of the fleet and chamberlain of England, and was again high in the king's favour. He was Richard's chief helper in the proceedings against the lords appellants in 1397, was created duke of Exeter in September of this year, and went with the king to Ireland in 1399. After the accession of his brother-in-law, Henry IV., Holand was tried for his share in the events of 1397, and was reduced to his earlier rank of earl of Huntingdon. He was soon plotting against Henry's life, and after the projected rising in 1400 had failed he was captured and was probably beheaded at Pleshey in Essex on the 16th of January 1400.¹ He was afterwards attainted and his titles and lands were forfeited.

In 1416 THOMAS BEAUFORT, earl of Dorset, was created duke of Exeter; but this dignity was only granted for his life, and consequently it expired on his death in 1426.

In 1416 JOHN (1395–1447), son of John Holand, the former duke of Exeter, was allowed to take his father's earldom of Huntingdon. This nobleman rendered great assistance to Henry V. in his conquest of France, fighting both on sea and on land. He was marshal of England, admiral of England and governor of Aquitaine under Henry VI.; was one of the king's representatives at the conference of Arras in 1435; and in 1443 was created duke of Exeter. When he died on the 5th of August 1447 his titles passed to his son HENRY (1430–1473), who, although married to Anne (d. 1476), daughter of Richard, duke of York, fought for Henry VI. during the Wars of the Roses. After having been imprisoned by York at Pontefract, he was present at the battle of Towton, sailed with Henry's queen, Margaret of Anjou, to Flanders in 1463, and was wounded at Barnet in 1471. In 1461 he had been attainted and his dukedom declared forfeited, and he died without sons, probably in 1473.

Coming to the family of Courtenay the title of marquess of Exeter was borne by HENRY COURTENAY (c. 1406–1538), earl of Devon, who was made a marquess in 1525. A grandson of Edward IV., Courtenay was a prominent figure at the court of Henry VIII. until Thomas Cromwell rose to power, when his high birth, his great wealth and his independent position made him an object of suspicion. Some slight discontent in the west of England gave the occasion for his arrest, and he was tried and beheaded on the 9th of December 1538. A few days later he was declared a traitor and his titles were forfeited; although his only son, EDWARD (c. 1526–1556), who was restored to the

earldom of Devon in 1553 and was a suitor for the hand of Queen Mary, is sometimes called marquess of Exeter.

The title of earl of Exeter was first bestowed upon the Cecils (see *CECIL: Family*) in 1605 when THOMAS, 2nd Lord Burghley (1542–1623), the eldest son of William Cecil, Lord Burghley, was made earl of Exeter by James I. Thomas had been a member of parliament during the reign of Queen Elizabeth, who knighted him in 1575, and had fought under the earl of Leicester in the Netherlands. After his father's death in 1598 he became president of the Council of the North and was made a knight of the Garter. He died on the 7th or 8th of February 1623. His direct descendants continued to bear the title of earl of Exeter, and in 1801 HENRY (1754–1804), the 10th earl, was advanced to the dignity of marquess of Exeter, the present marquess being his lineal descendant. It may be noted that the 1st marquess is Tennyson's "lord of Burghley."

See G. E. C(okayne), *Complete Peerage* (1887–1898).

EXETER, a city and county of a city, municipal, county and parliamentary borough, and the county town of Devonshire, England, 172 m. W.S.W. of London, on the London & South Western and the Great Western railways. Pop. (1901) 47,185. The ancient city occupies a broad ridge of land, which rises steeply from the left bank of the Exe. At the head of the ridge is the castle, on the site of a great British earthwork. The High Street and its continuation, called Fore Street, are narrow, but very picturesque, with many houses of the 16th and 17th centuries. There is a maze of lesser streets within the ancient walls, the line of which may be traced. All the gates have disappeared. The suburbs, which have greatly extended since the beginning of the 19th century, contain many good streets, terraces and detached villas. The surrounding country is rich, fertile and of great beauty. Extensive views are commanded in the direction of Haldon, a stretch of high moorland which may be regarded as an outlier of Dartmoor. The lofty mound of the castle is laid out as a promenade, with fine trees and broad walks.

The cathedral, although not one of the largest in England, is unsurpassed in the beauty of its architecture and the richness of its details. With the exception of the Norman transeptal towers, the general character is Decorated, ranging from about 1280 to 1369. Transeptal towers occur elsewhere in England only in the collegiate church of Ottery St Mary, in Devonshire, for which Exeter cathedral served as a model. The west front is of later date than the rest (probably 1369–1394), and the porch is wholly covered with statues. Within, the most noteworthy features are the long unbroken roof, extending throughout nave and choir, with no central tower or lantern; the beautiful sculpture of bosses and corbels; the minstrel's gallery, projecting from the north triforium of the nave; and the remarkable manner in which the several parts of the church are made to correspond. The window tracery is much varied; but each window answers to that on the opposite side of nave or choir; pier answers to pier, aisle to aisle, and chapel to chapel, while the transeptal towers complete the balance of parts. A complete restoration under Sir G. G. Scott was carried out between 1870 and 1877. The modern stall work, the reredos, the choir pavement of tiles, rich marbles and porphyries, the stained glass and the sculptured pulpits in choir and nave are meritorious. The episcopal throne, a sheaf of tabernacle work in wood, was erected by Bishop Stapeldon about 1320, and in the north transept is an ancient clock. The most interesting monuments are those of bishops of the 12th and 13th centuries, in the choir and lady chapel. Some important MSS., including the famous book of Saxon poetry given by Leofric to his cathedral, are preserved in the chapter-house. The united sees of Devonshire and Cornwall were fixed at Exeter from the installation there of Leofric (1050) by the Confessor, until the re-erection of the Cornish see in 1876. The bishop's palace embodies Early English portions. The diocese covers the greater part of Devonshire, with a very small part of Dorsetshire.

The guildhall in the High Street is a picturesque Elizabethan building, which contains some interesting portraits; among them being one of General Monk, who was a native of Devon,

¹ There is some difference of opinion about the place and manner of the earl's death, and this question has an important bearing upon the privilege of trial by peers of the realm. See L. W. Vernon-Harcourt, *His Grace the Steward and Trial of Peers* (1907).

and another of Henrietta, duchess of Orleans, given by her brother Charles II. Both are by Sir Peter Lely. The assize hall and sessions house dates from 1774. The Albert Memorial Museum contains a school of art, an excellent free library, a reading-room, and a museum of natural history and antiquities. There is a good collection of local birds, and some remarkable pottery and bronze relics extracted from barrows near Honiton or found in various parts of Devonshire. Of the castle, called Rougemont, the chief architectural remnant is a portion of a gateway tower which may be late Norman. Traces are also seen of the surrounding earthworks, which may have belonged to the original British stronghold. Beneath the castle wall is the pleasant promenade of Northernhay. The churches of Exeter are of little importance, being mostly small, and closely beset with buildings, but the modern church of St Michael (1860) deserves notice. The Devon and Exeter Institution, founded in 1813, contains a large and valuable library, and among educational establishments may be noticed the technical and university extension college, the diocesan training college and school; and the grammar school, which was founded under a scheme of Walter de Stapeldon, bishop of Exeter and founder of Exeter College, Oxford, in 1332, and refounded in 1629, but occupies modern buildings (1886) outside the city. It is endowed with a large number of leaving exhibitions, and about 150 boys are educated. There are two market-houses in the city, many hospitals and many charitable institutions, including the picturesque hospital or almshouse of William Wynard, recorder of Exeter (1439).

Exeter is one of the principal railway centres in the south-west, and it also has some shipping trade, communicating with the sea by way of the Exeter ship-canal, originally cut in the reign of Elizabeth (1564), and enlarged in 1675 and 1827. This canal is an interesting work, being the first canal carried out in the United Kingdom for the purpose of enabling sea-going vessels to pass to an inland port. The river Exe was very early utilized by small craft trading to Exeter, parliament having granted powers for the improvement of the navigation by the construction of a canal 3 m. long from Exeter to the river; at a later date this canal was extended lower down to the tidal estuary of the Exe. Previous to the year 1820 it was only available for vessels of a draft not exceeding 9 ft., but by deepening it, raising the banks, and constructing new locks, vessels drawing 14 ft. of water were enabled to pass up to a basin and wharves at Exeter. These works were carried out under the advice of Thomas Telford. A floating basin is accessible to vessels of 350 tons. Larger vessels lie at Topsham, at the junction of the canal with the estuary of the Exe; while at the mouth of the estuary is the port of Exmouth. Imports are miscellaneous, while paper, grain, cider and other goods are exported. Brewing, paper-making and iron-founding are carried on, and the city is an important centre of agricultural trade. The parliamentary borough returns one member. The city is governed by a mayor, 14 aldermen and 42 councillors. Area, 3158 acres. The eastern suburb of Heavitree, where is the Exeter city asylum, is an urban district with a population (1901) of 7529.

Exeter was the Romano-British country town of *Isca Damnoniorum*—the most westerly town in the south-west of Roman Britain. Mosaic pavements, potsherds, coins and other relics have been found, and probably traces of the Roman walls survive here and there in the medieval walls. It is said to be the *Cæsar* *Isce* of the Britons, and its importance as a British stronghold is shown by the great earthwork which the Britons threw up to defend it, on the site of which the castle was afterwards built, and by the number of roads which branch from it. Exeter is famous for the number of sieges which it sustained as the chief town in the south-west of England. In 1001 it was unsuccessfully besieged by the Danes, but in the following year was given by King Æthelred to Queen Emma, who appointed as reeve, Hugh, a Frenchman, owing to whose treachery it was taken and destroyed by Sweyn in 1003. By 1050, however, it had recovered, and was chosen by Leofric as the new seat of the bishops of Devon. In 1068, after a siege of eighteen days, Exeter surrendered to

the Conqueror, who threw up a castle which was called Rouge-mont, from the colour of the rock on which it stood. Again in 1137 the town was held for Matilda by Baldwin de Redvers for three months and surrendered, at last, owing to lack of water. Three times subsequently Exeter held out successfully for the king—in 1467 against the Yorkists, in 1497 against Perkin Warbeck, and in 1549 against the men of Cornwall and Devon, who rose in defence of the old religion. During the civil wars the city declared for parliament, but was in 1643 taken by the royalists, who held it until 1646. The only other historical event of importance is the entry of William, prince of Orange, in 1688, shortly after his arrival in England. Exeter was evidently a borough by prescription some time before the Conquest, since the burgesses are mentioned in the Domesday Survey. Its first charter granted by Henry I. gave the burgesses all the free customs which the citizens of London enjoyed, and was confirmed and enlarged by most of the succeeding kings. By 1227 government by a reeve had given place to that by a mayor and four bailiffs, which continued until the Municipal Reform Act of 1835. Numerous trade guilds were incorporated in Exeter, one of the first being the tailors' gild, incorporated in 1466. This by 1482 had become so powerful that it interfered with the government of the town, and was dissolved on the petition of the burgesses. Another powerful gild was that of the merchant adventurers, incorporated in 1559, which is said to have dictated laws to which the mayor and bailiffs submitted. From 1295 to 1885 Exeter was represented in parliament by two members, but in the latter year the number of representatives was reduced to one. Exeter was formerly noted for the manufacture of woollen goods, introduced in Elizabeth's reign, and the value of its exports at one time exceeded half a million sterling yearly. The trade declined partly owing to the stringent laws of the trade guilds, and by the beginning of the 19th century had entirely disappeared, although at the time of its greatest prosperity it had been surpassed in value and importance only by that of Leeds.

See *Victoria County History, Devon*; Richard Izacke, *Antiquities of the City of Exeter* (1677); George Oliver, *The History of the City of Exeter* (1861); and E. A. Freeman, *Exeter* ("Historic Towns" series) (London, 1887), in the preface to which the names of earlier historians of the city are given.

EXETER, a town and one of the county-seats of Rockingham county, New Hampshire, U.S.A., on the Squamscott river, about 12 m. S.W. of Portsmouth and about 51 m. N. by E. of Boston, Mass. Pop. (1890) 4284; (1900) 4922 (1066 foreign-born); (1910) 4897; area, about 17 sq. m. It is served by the Western Division of the Boston & Maine railway. The town has a public library and some old houses built in the colonial period, and is the seat of Phillips Exeter Academy (incorporated in 1781 and opened in 1783). In its charter this institution is described as "an academy for the purpose of promoting piety and virtue, and for the education of youth in the English, Latin and Greek languages, in writing, arithmetic, music and the art of speaking, practical geometry, logic and geography, and such other of the liberal arts and sciences or languages, as opportunity may hereafter permit." It was founded by Dr John Phillips (1719-1795), a graduate of Harvard College, who acquired considerable wealth as a merchant at Exeter and gave nearly all of it to the cause of education. The academy is one of the foremost secondary schools in the country, and among its *alumni* have been Daniel Webster, Edward Everett, Lewis Cass (born in Exeter in a house still standing), John Parker Hale, George Bancroft, Jared Sparks, John Gorham Palfrey, Richard Hildreth and Francis Bowen. The government of the academy is vested in a board of six trustees, regarding whom the founder provided that a majority should be laymen and not inhabitants of Exeter. In 1900-1910 the institution had 20 buildings, 32 acres of recreation grounds, 16 instructors and 488 students, representing 38 states and territories of the United States and 4 foreign countries. At Exeter also is the Robinson female seminary (1867), with 14 instructors and 272 students in 1906-1907. The river furnishes water-power, and among the manufactures of the town are shoes, machinery, cottons, brass, &c.

The town is one of the oldest in the state; it was founded in 1638 by Rev. John Wheelwright, an Antinomian leader who with a number of followers settled here after his banishment from Massachusetts. For their government the settlers adopted (1639) a plantation covenant. There was disagreement from the first, however, with regard to the measure of loyalty to the king, and in 1643, when Massachusetts had asserted her claim to this region and the other three New Hampshire towns had submitted to her jurisdiction, the majority of the inhabitants of Exeter also yielded, while the minority, including the founder, removed from the town. In 1680 the town became a part of the newly created province of New Hampshire. During the French and Indian wars it was usually protected by a garrison, and some of the garrison houses are still standing. From 1776 to 1784 the state legislature usually met at Exeter.

See C. H. Bell, *History of the Town of Exeter* (Exeter, 1888).

EXETER BOOK [*Codex Exoniensis*], an anthology of Anglo-Saxon poetry presented to Exeter cathedral by Leofric,¹ bishop of Exeter, England, from 1050 to 1071, and still in the possession of the dean and chapter. It contains some legal documents, the poems entitled *Crist*, *Guthlac*, *Phoenix*, *Juliana*, *The Wanderer* and others, and concludes with between eighty and ninety riddles. It was first described in Humphrey Wanley's *Catalogus* . . . (1705) in detail but with many inaccuracies; subsequently by J. J. Conybeare, *Account of a Saxon Manuscript* (a paper read in 1812; printed with some extracts from the MS. in *Archaeologia*, vol. xvii. pp. 180-197, 1814). A complete transcript made (1831) by Robert Chambers is in the British Museum (Addit. MS. 9067). It was first printed in 1842 by Benjamin Thorpe for the Soc. of Antiq., London, as *Codex Exoniensis . . . with an English Translation, Notes and Indexes*. More recent editions, chiefly based on Thorpe's text, are:—in Chr. Grein's *Bibliothek der A.S. Poesie* (vol. iii. part 1, ed. R. Wülker, Leipzig, 1897, with a bibliography), J. Schipper in Pfeiffer's *Germania*, vol. xix. pp. 327-339, and Israel Gollancz, *The Exeter Book*, pt. i. (1895), with English translation, for the Early English Text Society.

A detailed account, with bibliographies of the separate poems, is given by R. Wülker, in *Grundriss . . . der A.S. Literatur*, pp. 218-236 (Leipzig, 1885); see also the introduction to *The Crist of Cynewulf* . . ., edited by Prof. A. S. Cook, with introduction, notes and a glossary (Boston, U.S.A., 1900). For the poems contained in the MS. see also *CYNEWULF AND RIDDLES*.

EXHIBITION, a term, meaning in general a public display,² which has a special modern sense as applied to public shows of goods for the promotion of trade (Fr. *exposition*). The first exhibition in this sense of which there is any account, in either sacred or profane history, was that held by King Ahasuerus, who, according to the Book of Esther, showed in the third year of his reign "the riches of his glorious kingdom, and the honour of his excellent majesty, many days, even a hundred and four-score days." The locale of this function was Shushan, the palace and the exhibits consisted of "white, green and blue hangings, fastened with cords of fine linen and purple to silver rings and pillars of marble: the beds were of gold and silver, upon a pavement of red, and blue, and white and black marble. And they gave them drink in vessels of gold, the vessels being diverse one from another." The first exhibition since the Christian era was at Venice during the dogeship of Lorenzo Tiepolo, in 1268. On that occasion there was a grand display, consisting of a water fête, a procession of the trades and an industrial exhibition. The various guilds of the Queen City of the Seas marched through the narrow streets to the great square of St Mark, and their leaders asked the dogressa to inspect the products of their industry. Other medieval exhibitions were the fairs held at Leipzig and Nizhni Novgorod in Europe, at Tanta in Egypt, and in 1689 that by the Dutch at Leiden.

¹ For Leofric, see F. E. Warren, *The Leofric Missal* (1883).

² An "exhibition," in the sense of a minor scholarship, or annual payment to a student from the funds of a school or college, is a modern survival from the obsolete meaning of "maintenance" or "endowment" (cf. Late Lat. *exhibitio et tegumentum*, i.e. food and raiment).

The first modern exhibition was held at London in 1756 by the Society of Arts, which offered prizes for improvements in the manufacture of tapestry, carpets and porcelain, the exhibits being placed side by side. Five years afterwards, in 1761, the same society gave an exhibition of agricultural machinery. In 1797 a collective display of the art factories of France, including those of Sèvres, the Gobelins and the Savonnerie, was made in the palace of St Cloud, and the exhibition was repeated during the following year in the rue de Varennes, Paris. This experiment was so successful that in the last three days of the same year an exhibition under official auspices, at which private exhibitors were allowed to compete, was held in the Champ de Mars. Four years later, in 1801, there was a second official exhibition in the grand court of the Louvre. Upon that occasion juries of practical men examined the objects shown, and the winners of a gold medal were invited to dine with Napoleon, who was at that time First Consul. In the report of the jury the following remarkable sentence appeared:—"There is not an artist or inventor who, once obtaining thus a public recognition of his ability, has not found his reputation and his business largely increased." The third Paris Exhibition, held in 1802, was the first to publish an official catalogue. There were 540 exhibitors, including J. E. Montgolfier, the first aeronaut, and J. M. Jacquard, the inventor of the loom which bears his name. The fourth exhibition was held in 1806 in the esplanade in front of the Hôtel des Invalides, and attracted 1422 exhibitors. There were no more exhibitions till after the fall of the empire, but in 1819 the fifth was held during the reign of Louis XVIII., with 1622 exhibitors. Others were held at Paris at various intervals, that in 1849 having 4500 exhibitors.

Other exhibitions, though on a smaller scale, were held in Dublin, London, and in various parts of Germany and Austria during the first half of the 19th century—that in 1844, held at Berlin, having 3040 exhibitors. Switzerland, Holland, Belgium, Sweden, Russia, Poland, Italy, Spain and Portugal all held exhibitions, and there was a Free Trade Bazaar of British Manufactures at Covent Garden theatre in 1845, which at the time created a great deal of interest. But all these exhibitions were confined to the products of the country in which they took place, and the first great International Exhibition was held in London in 1851 by the Society of Arts, under the presidency of the prince consort. All nations were invited to compete; a site was obtained in Hyde Park, and a building 20 acres in extent was erected, after the design of Sir Joseph Paxton, at a cost of £193,168. The exhibition was open for five months and fifteen days. The receipts amounted to £506,100, and the surplus was £186,000. The number of visitors was 6,039,195, and the money taken at the doors was £423,792. The total number of exhibitors was 13,937, of which Great Britain contributed 6861, the British colonies 520 and foreign countries 6556. The International Exhibition of 1851 was followed by those of New York and Dublin in 1853, Melbourne and Munich in 1854, and Paris in 1855—this latter was held in the Palais d'Industrie, which remained in existence until pulled down to make room for the two Palais des Beaux Arts, which formed one of the attractions of the 1900 exhibition. The exhibitors numbered 20,839 and the visitors 5,162,330. There were national exhibitions during the following years in several European countries, but the next great world's fair was held at London in 1862. The total space roofed in amounted to 988,000 sq. ft., 22.65 acres, the number of visitors was 6,211,103, and the amount received at the doors £408,530. The death of the prince consort had a depressing effect upon the enterprise. In 1865 an exhibition was held at Dublin, the greater proportion of the funds being supplied by Sir Benjamin Lee Guinness. The number of attendances during six months was 900,000, and the exhibition was opened at night. An Italian exhibition was held at Rome in 1862.

The Paris Exhibition of 1867 was upon a far larger scale than that of 1855. It was held, like those that preceded and succeeded it, at the Champ de Mars, and covered 41 acres. The building resembled an exaggerated gasometer. The external ring was

devoted to machinery, the internal to the gradual development of civilization, commencing with the stone age and continuing to the present era. A great feature of the exhibition was the park, which was studded with specimens of every style of modern architecture—Turkish mosques, Swedish cottages, English lighthouses, Egyptian palaces and Swiss chalets. The number of attendances was 6,805,969. The exhibitors numbered 43,217, and the total amount received for entrances, concessions, &c., was £420,735. This was the first exhibition at which there were international restaurants. The cost of the exhibition was defrayed partly by the state and partly by private subscriptions.

Small exhibitions were held in various parts of Europe between 1867 and 1870, and in the latter year a series of international exhibitions, confined to one or two special descriptions of produce or manufactures, was inaugurated in London at South Kensington. These continued till 1874, but they failed to attract any very large attendance of the public and were abandoned. A medal was given to each exhibitor, and reports on the various exhibits were published, but there was no examination of the exhibits by jurors. In 1873 there was an International Exhibition at Vienna. The main building, a rotunda, was erected in the beautiful park of the Austrian capital. There were halls for machinery and agricultural products, and hundreds of buildings, erected by different nations, were scattered amongst the woodlands of the Prater. Unfortunately, an outbreak of cholera diminished the attendance of visitors, and the receipts were only £206,477, although the visitors were said to have reached 6,740,500, and the number of exhibitors was 25,760.

None of the International Exhibitions held between 1857 and 1873 had attracted as many as 7,000,000 visitors, but the gradual extension of education amongst the masses, and the greater facilities for locomotion, brought about by the growth of the railway system in all portions of the civilized world, largely increased the attendances at subsequent World's Fairs. The Centennial Exhibition of 1876, to celebrate the one-hundredth anniversary of American Independence, was held at Fairmount Park, Philadelphia. The funds were raised partly by private subscriptions, and partly by donations from the city of Philadelphia, from Pennsylvania and some of the neighbouring states. The central government at Washington made a large loan, which was subsequently repaid. The principal buildings, five in number, occupied an area of 48½ acres, and there were several smaller structures, which in the aggregate must have filled half as much space more, the largest being that devoted to the exhibits of the various departments of the United States government, which covered 7 acres. Several novelties in exhibition management were introduced at Philadelphia. Instead of gold, silver and bronze medals, only one description, bronze, was issued, the difference between the merits of the different exhibits being shown by the reports. Season tickets were not issued, and the price of admission, the same on all occasions, was half a dollar, or about 2s. 1d. The exhibition was not open at night or on Sundays, thus following the British, and not the continental, precedent. The number of visitors was 9,892,625, of whom 8,004,214 paid for admission, the balance being exhibitors, officials and attendants. The total receipts amounted to £763,899. Upon one occasion, the Pennsylvania day, 274,919 persons—the largest number that had visited any exhibition up to that date—passed through the turnstiles. The display of machinery was the finest ever made, that of the United States occupying 480,000 sq. ft. The motive-power was obtained from a Corliss engine of 1600 horse-power. At this exhibition the United Kingdom and the British Colonies of Canada, Victoria, New South Wales, New Zealand, Cape Colony and Tasmania made a very fine display, which was only excelled by that of the United States,

The Paris Exhibition of 1878 was upon a far larger scale in every respect than any which had been previously held in any part of the world. The total area covered not less than 66 acres, the main building in the Champ de Mars occupying 54 acres. The French exhibits filled one-half the entire space, the remaining moiety being occupied by the other nations of the world. The

United Kingdom, British India, Canada, Victoria, New South Wales, Queensland, South Australia, Cape Colony and some of the British crown colonies occupied nearly one-third of the space set aside for nations outside France. Germany was the only great country which was not represented, but there were a few German paintings. The display of fine arts and machinery was upon a very large and comprehensive scale, and the Avenue des Nations, a street 2400 ft. in length, was devoted to specimens of the domestic architecture of nearly every country in Europe, and of several in Asia, Africa and America. The palace of the Trocadero, on the northern bank of the Seine, was erected for the exhibition. It was a handsome structure, with towers 250 ft. in height and flanked by two galleries. The rules for admission were the same as those at Philadelphia, and every person—exhibitor, journalist or official—who had the right of entrance was compelled to forward two copies of his or her photograph, one of which was attached to the card of entry. The ordinary tickets were not sold at the doors, but were obtainable at various government offices and shops, and from numerous pedlars in all parts of the city and suburbs. The buildings were somewhat unfinished upon the opening day, political complications having prevented the French government and the French people from paying much attention to the exhibition till about six months before it was opened; but the efforts made in April were prodigious, and by June 1st, a month after the opening, the exhibition was complete, and afforded an object-lesson of the recovery of France from the calamities of 1870–1871. The decisions arrived at by the international juries were accompanied by medals of gold, silver and bronze. The expenditure by the United Kingdom was defrayed out of the consolidated revenue, each British colony defraying its own expenses. The display of the United Kingdom was under the control of a royal commission, of which the prince of Wales was president. The number of paying visitors to the exhibition was 13,000,000, and the cost of the enterprise to the French government, which supplied all the funds, was a little less than a million sterling, after allowing for the value of the permanent buildings and the Trocadero Palace, which were sold to the city of Paris. The total number of persons who visited Paris during the time the exhibition was open was 571,792, or 308,974 more than came to the French metropolis during the year 1877, and 46,021 in excess of the visitors during the previous exhibition of 1867. It was stated at the time that, in addition to the impetus given to the trade of France, the revenue of the Republic and of the city of Paris from customs and octroi duties was increased by nearly three millions sterling as compared with the previous year.

Exhibitions on a scale of considerable magnitude were held at Sydney and Melbourne in 1879 and 1880, and many continental and American manufacturers took advantage of them in order to bring the products of their industry directly under the notice of Australian consumers, who had previously purchased their supplies through the instrumentality of British merchants. The United Kingdom and India made an excellent display at both cities, but the effect of the two great Australian exhibitions was to give a decided impetus to German, American, French and Belgian trade. One of the immediate results was that lines of steamers to Melbourne and Sydney commenced to run from Marseilles and Bremen; another, that for the first time in the history of the Australian colonies, branches of French banks were opened in the two principal cities. The whole cost of these exhibitions was defrayed by the local governments.

Exhibitions were held at Turin and Brussels during 1880, and smaller ones at Newcastle, Milan, Lahore, Adelaide, Perth, Moscow, Ghent and Lille during 1881 and 1882, and at Zurich, Bordeaux and Caraccas in Venezuela during 1883. The next of any importance was held at Amsterdam in the latter year. On that occasion a new departure in exhibition management was made. The government of the Netherlands was to a certain extent responsible for the administration of the exhibition, but the funds were obtained from private sources, and a charge was made to each nation represented for the space it occupied. The United Kingdom, India, Victoria and New South Wales

took part in the exhibition, but there was no official representation of the mother country. Exhibitions on somewhat similar lines were held at Nice and Calcutta in the winter of 1883 and 1884, and at Antwerp in 1895.

A series of exhibitions, under the presidency of the then prince of Wales, and managed by Sir Cunliffe Owen, was commenced at South Kensington in 1883. The first was devoted to a display of the various industries connected with fishing; the second, in 1884, to objects connected with hygiene; the third, in 1885, to inventions; and the fourth, in 1886, to the British colonies and India. These exhibitions attracted a large number of visitors and realized a substantial profit. They might have been continued indefinitely if it had not been that the buildings in which they were held had become very dilapidated, and that the ground covered by them was required for other purposes. There was no examination of the exhibits by juries, but a tolerably liberal supply of instrumental music was supplied by military and civil bands. The Crystal Palace held a successful International Exhibition in 1884, and there was an Italian Exhibition at Turin, and a Forestry Exhibition at Edinburgh, during the same year. A World's Industrial Fair was held at New Orleans in 1884-1885, and there were universal Exhibitions at Montenegro and Antwerp in 1885, at Edinburgh in 1886, Liverpool, Adelaide, Newcastle and Manchester in 1887, and at Glasgow, Barcelona and Brussels in 1888. Melbourne held an International Exhibition in 1888-1889 to celebrate the Centenary of Australia. Great Britain, Germany, France, Austria and the United States were officially represented, and an expenditure of £237,784 was incurred by the local government.

The Paris Exhibition of 1889 marked an important change in the policy which had previously characterized the management of these gatherings. The funds were contributed partly by the state, which voted 17,000,000 francs, and by the municipality of Paris, which gave 8,000,000. A guarantee fund amounting to 23,124,000 francs was raised, and on this security a sum of 18,000,000 francs was obtained and paid into the coffers of the administration. The bankers who advanced this sum recouped themselves by the issue of 1,200,000 "bons," each of 25 francs. Every bon contained 25 admissions, valued at 1 franc, and certain privileges in the shape of participation in a lottery, the grand prix being £20,000. The calculations of the promoters were tolerably accurate. The attendances reached the then unprecedented number of 32,350,297, of whom 25,398,609 paid in entrance tickets and 2,723,366 entered by season tickets. A sum of 2,307,999 francs was obtained by concessions for restaurants and "side-shows," upon which the administration relied for much of the attractiveness of the exhibition. The total expenditure was 44,000,000 francs, and there was a small surplus. The space covered in the Champ de Mars, the Trocadero, the Palais d'Industrie, the Invalides and the Quai d'Orsay was 72 acres, as compared with 66 acres in 1878 and 41 acres in 1867. Amongst the novelties was the Eiffel Tower, 1000 ft. in height, and a faithful reproduction of a street in Cairo. The system of international juries was continued, but instead of gold, silver and copper medals, diplomas of various merits were granted, each entitling the holder to a uniform medal of bronze. Some of the "side-shows," although perhaps pecuniary successes, did not add to the dignity of the exhibition. The date at which it was held, the Centenary of the French Revolution, did not commend it to several European governments. Austria, Hungary, Belgium, China, Egypt, Spain, Great Britain, Italy, Luxemburg, Holland, Peru, Portugal, Rumania and Russia took part, but not officially, while Germany, Sweden, Turkey and Montenegro were conspicuous by their absence. On the other hand, Argentina, Bolivia, Chile, the United States, Greece, Guatemala, Morocco, Mexico, Nicaragua, Norway, Paraguay, Salvador, the South African Republic, Switzerland, Uruguay and Venezuela sent commissioners, who were accredited to the government of the French Republic. The total number of exhibitors was 61,722, of which France contributed 33,937, and the rest of the world 27,785. The British and colonial section was under the management of the Society of Arts, which obtained

a guarantee fund of £16,800, and, in order to recoup itself for its expenditure, made a charge to exhibitors of 5s. per sq. ft. for the space occupied. There were altogether 1149 British exhibitors, of whom 429 were in the Fine Arts section. One of the features of the exhibition was the number of congresses and conferences held in connexion with it.

During the year 1890 there was a Mining Exhibition at the Crystal Palace, and a Military Exhibition in the grounds of Chelsea Hospital; in 1891 a Naval Exhibition at Chelsea and an International at Jamaica. In 1891-1892 there were exhibitions at Palermo and at Launceston in Tasmania; in 1892, a Naval Exhibition at Liverpool, and one of Electrical Appliances at the Crystal Palace. A series of small national exhibitions under private management was held at Earl's Court between 1887 and 1891. The first of the series was that of the United States-Italy followed in 1888, Spain in 1889, France in 1890 and Germany in 1891.

The next exhibition of the first order of magnitude was at Chicago in 1893, and was held in celebration of the 400th anniversary of the discovery of America by Columbus. The financial arrangements were undertaken by a company, with a capital of £2,000,000. The central government at Washington allotted £20,000 for the purposes of foreign exhibits, and £300,000 for the erection and administration of a building for exhibits from the various government departments. The exhibition was held at Jackson Park, a place for public recreation, 580 acres in extent, situated on the shore of Lake Michigan, on the southern side of the city, with which it was connected by railways and tramways. Special provision was made for locomotion in the grounds themselves by a continuous travelling platform and an elevated electric railway. The proximity of the lake, and of some artificial canals which had been constructed, rendered possible the service of electric and steam launches. The exhibition remained open from the 1st of May to the 30th of October, and was visited by 21,477,212 persons, each of whom paid half a dollar (about 2s. 1d.) for admission. The largest number of visitors on any one day was 716,881. In addition to its direct vote of £320,000, Congress granted £500,000 to the exhibition in a special coinage, which sold at an enhanced price. The receipts from admissions were £2,120,000; from concessions, £750,000; and the miscellaneous receipts, £159,000: total, £3,029,000. The total expenses were £5,222,000. Of the sums raised by the Company, £400,000 was returned to the subscribers. Speaking roughly, it may be said that the total outlay on the Chicago Exhibition was six millions sterling, of which three millions were earned by the Fair, two millions subscribed by Chicago and a million provided by the United States government. The sums expended by the participating foreign governments were estimated at £1,440,000. The total area occupied by buildings at Chicago was as nearly as possible 200 acres, the largest building, that devoted to manufactures, being 1687 ft. by 787, and 30.5 acres. The funds for the British commission, which was under the control of the Society of Arts, were provided by the imperial government, which granted £60,000. The number of British exhibitors was 2236, of whom 597 were Industrial, 501 Fine Arts and 1138 Women's work. In this total were included 18 Indian exhibitors. The space occupied by Great Britain was 306,285 sq. ft.; and, in addition, separate buildings were erected in the grounds. These were Victoria House, the headquarters of the British commission; the Indian Pavilion, erected by the Indian Tea Association; the Kiosk of the White Star Steamship Company; and the structure set up by the Maxim-Nordenfelt Company. Canada and New South Wales had separate buildings, which covered 100,140 and 50,951 sq. ft. respectively; and Cape Colony occupied 5250, Ceylon 27,574, British Guiana 3367, Jamaica 4250, Trinidad 3400 and India 3584 sq. ft. in the several buildings. The total space occupied by the British Colonies was therefore 193,660 sq. ft. The system of awards was considered extremely unsatisfactory. Instead of international juries, a single judge was appointed for each class, and the recompenses were all of one grade, a bronze medal and a diploma, on which was stated the reasons which induced the

judge to make his decision. Some judges took a high standard, and refused to make awards except to a small proportion of selected exhibits; others took a low one, and gave awards indiscriminately. About 1183 awards were made to British exhibitors. The French refused to accept any awards. The value of the British goods exhibited was estimated, exclusive of Fine Arts, at £430,000, and the expenses of showing them at £200,000. A large expenditure was incurred in the erection of buildings, which were more remarkable for their beauty and grandeur than for their suitableness to the purposes for which they were intended. Considerable areas were devoted to "side-shows," and the Midway Plaisance, as it was termed, resembled a gigantic fair. Every country in the world contributed something. There were sights and shows of every sort from everywhere. The foreign countries represented were Argentina, Austria, Belgium, Bolivia, Brazil, Bulgaria, Chile, Colombia, Costa Rica, Cuba, Curaçoa, Denmark, Danish West Indies, Ecuador, France, Germany, Greece, Guatemala, Honduras, Hayti, Japan, Johore, Korea, Liberia, Mexico, Monaco, Netherlands, Norway, Orange Free State, Paraguay, Persia, Portugal, Russia, Siam, Spain, Sweden, Turkey, United Kingdom and Colonies, Uruguay and Venezuela.

Exhibitions were held at Antwerp, Madrid and Bucharest in 1894; Hobart in 1894-1895; Bordeaux, 1895; Nizhni Novgorod, Berlin and Buda-Pest in 1896; Brussels and Brisbane in 1897. A series of exhibitions, under the management of the London Exhibitions Company, commenced at Earl's Court in 1895 and continued in successive years.

The Paris Exhibition of 1900 was larger than any which had been previously held in Europe. The buildings did not cover so much ground as those at Chicago, but many of those at Paris had two or more floors. In addition to the localities occupied in 1889, additional space was obtained at the Champs Elysées, the park of Vincennes, on the north bank of the Seine between the Place de la Concorde, and at the Trocadero. The total superficial area occupied was as follows: Champ de Mars, 124 acres; Esplanade des Invalides, 30 acres; Trocadero Gardens, 40 acres; Champs Elysées, 37 acres; quays on left bank of Seine, 23 acres; quays on right bank of Seine, 23 acres; park at Vincennes, 270 acres: total, 549 acres. The space occupied by buildings and covered in amounted to 4,865,328 sq. ft., 111½ acres. The French section covered 2,691,000 sq. ft., the foreign 1,829,880, and those at the park of Vincennes 344,448 sq. ft. About one hundred French and seventy-five foreign pavilions and detached buildings were erected in the grounds in addition to the thirty-six official pavilions, which were for the most part along the Quai d'Orsay. Funds were raised upon the same system as that adopted in 1889. The French government granted £800,000, and a similar sum was contributed by the municipality of Paris. £2,400,000 was raised by the issue of 3,250,000 "bons," each of the value of 20 francs, and containing 20 tickets of admission to the exhibition of the face value of one franc each, and a document which gave its holder a right either to a reduced rate for admission to the different "side-shows" or else to a diminution in the railway fare to and from Paris, together with a participation in the prizes, amounting to six million francs, drawn at a series of lotteries. Permission to erect restaurants, and to open places of amusement in buildings erected for that purpose, were sold at high prices, and for these privileges, which only realised 2,307,999 francs in 1889, the concessionaires agreed to pay 8,864,442 francs in 1900. The results did not justify the expectations which had been formed, and the administration finally consented to receive a much smaller sum. The administration calculated that they would have 65,000,000 paying visitors, though there were only 13,000,000 in 1878 and 25,398,609 in 1889. A very few weeks after the opening day, April 15th, it became evident that the estimated figures would not be reached, since a large number of holders of "bons" threw them on the market, and the selling price of an admission ticket declined from the par value of one franc to less than half that amount, or from 30 to 50 centimes. The proprietors of the restaurants and "side-shows" discovered

that they had paid too much for their concessions, that the buildings they had erected were far too handsome and costly to be profitable, and that the public preferred the exhibition itself to the so-called attractions. The exhibition was largely visited by foreigners, but various causes kept away many persons of wealth and position. Although many speculators were ruined, the exhibition itself was successful. The attendance was unprecedentedly large, and during the seven months the exhibition was open, 39,000,000 persons paid for admission with 47,000,000 tickets, since from two to five tickets were demanded at certain times of the day and on certain occasions. The entries of exhibitors, attendants and officials totalled 9,000,000. The receipts were 114,456,213 francs (£4,578,249), and the expenditure 116,500,000 (£4,660,000), leaving a deficiency of rather more than two millions of francs (£80,000). It was calculated that the expenditure of the foreign nations which took part in the exhibition was six millions sterling, and of the French exhibitors and concessionaires three millions sterling.

A new plan of classifying exhibits was adopted at Paris, all being displayed according to their nature, and not according to their country of origin, as had been the system at previous exhibitions. One-half the space in each group was allotted to France, so that the exhibitors of that nation were enabled to overwhelm their rivals by the number and magnitude of the objects displayed by them. All the agricultural implements, whatever their nationality, were in one place, all the ceramics in another, so that there was no exclusively British and no exclusively German court. The only exception to this rule was in the Trocadero, where the French, British, Dutch, and Portuguese Colonies, Algeria, Tunis, Siberia, the South African Republic, China and Japan were allowed to erect at their own cost separate pavilions. The greater number of the nationalities represented had palaces of their own in the rue des Nations along the Quai d'Orsay, in which thoroughfare were to be seen the buildings erected by Italy, Turkey, the United States, Denmark, Portugal, Austria, Bosnia, Herzegovina, Peru, Hungary, the United Kingdom, Persia, Belgium, Norway, Luxemburg, Finland, Germany, Spain, Bulgaria, Monaco, Sweden, Rumania, Greece, Servia and Mexico. Scattered about the grounds, in addition to those in the Trocadero, were the buildings of San Marino, Morocco, Ecuador and Korea. Nearly every civilized country in the world was represented at the exhibition, the most conspicuous absentees being Argentina, Brazil, Chile, and some other South and Central American Republics, and a number of the British colonies. The most noteworthy attractions of the exhibition were the magnificent effects produced by electricity in the palace devoted to it in the Château d'Eau and in the Hall of Illusions, the two palaces of the Fine Arts in the Champs Elysées, and the Bridge over the Seine dedicated to the memory of Alexander II. These permanent Fine Art palaces were devoted, the one to modern painting and sculpture, the other to the works of French artists and art workmen who flourished from the dawn of French art up to the end of the 18th century.

The United Kingdom was well but not largely represented both in Fine Arts and Manufactures, the administration of the section being in the hands of a royal commission, presided over by the prince of Wales. The British pavilion contained an important collection of paintings of the British school, chiefly by Reynolds, Gainsborough and their contemporaries, and by Turner and Burne-Jones. Special buildings had been erected by the British colonies and by British India. Canada, West Australia and Mauritius occupied the former, India and Ceylon the latter. For the first time since the war of 1870 Germany took part in a French International Exhibition, and the exhibits showed the great industrial progress which had been made since the foundation of the empire in 1870. The United States made a fine display, and fairly divided the honours with Germany. Remarkable progress was manifested in the exhibits of Canada and Hungary. France maintained her superiority in all the objects in which good taste was the first consideration, but the more utilitarian exhibits were more remarkable for their number than

their quality, except those connected with electrical work and display, automobiles and iron-work. The number of exhibitors in the industrial section from the British empire, including India and the colonies, was 1250, who obtained 1647 awards, as many persons exhibited in several classes. There were, in addition, 465 awards for "collaborateurs," that is, assistants, engineers, foremen, craftsmen and workmen who had co-operated in the production of the exhibits. In the British Fine Arts section there were 429 exhibits by 282 exhibitors and 175 awards.

In later years, important international exhibitions have been held at Glasgow, and at Buffalo, New York, in 1901, at St Louis (commemorating the Louisiana purchase) in 1904, at Liège in 1905, at Milan in 1906, at Dublin in 1907, and in London (Franco-British), 1908. In the artistic taste and magnificence of their buildings and the interest of their exhibits these took their cue from the great Paris Exhibition, and even in some cases went beyond it, notably at Buffalo (*q.v.*), St Louis (*q.v.*) and London. And it might well be thought that the evolution of this type of public show had reached its limits. (G. C. L.)

EXHUMATION (from Med. Lat. *exhumare*; *ex*, out of, and *humus*, ground), the act of digging up and removing an object from the ground. The word is particularly applied to the removal of a dead body from its place of burial. For the offence of exhuming a body without legal authority, and the process of obtaining such authority, see BURIAL AND BURIAL ACTS.

EXILARCH, in Jewish history, "Chief or Prince of the Captivity." The Jews of Babylonia, after the fall of the first temple, were termed by Jeremiah and Ezekiel the people of the "Exile." Hence the head of the Babylonian Jews was the exilarch (in Aramaic *Resh Galutha*). The office was hereditary and carried with it considerable power. Some traditions regarded the last king of Davidic descent (Jehoiachin) as the first exilarch, and all the later holders of the dignity claimed to be scions of the royal house of Judah. Under the Arsacids and Sassanids the office continued. In the 6th century an attempt was made to secure by force political autonomy for the Jews, but the exilarch who led the movement (Mar Zutra) was executed. For some time thereafter the office was in abeyance, but under Arabic rule there was a considerable revival of its dignity. From the middle of the 7th till the 11th centuries the exilarchs were all descendants of Bostanai, through whom "the splendour of the office was renewed and its political position made secure" (Bacher). The last exilarch of importance was David, son of Zakkai, whose contest with Scadiah (*q.v.*) had momentous consequences. Hezekiah (c. 1040) was the last Babylonian exilarch, though the title left its traces in later ages. Benjamin of Tudela (*Itinerary*, p. 61) names an exilarch Daniel b. Hisdai in the 12th century. Petahiah (*Travels*, p. 17) records that this Daniel's nephew succeeded to the office jointly with a R. Samuel. The latter, according to Petahiah, had a learned daughter who "gave instruction, through a window, remaining in the house while the disciples were below, unable to see her."

Our chief knowledge of the position and function of the exilarch concerns the period beginning with the Arabic rule in Persia. In the age succeeding the Mahommedan conquest the exilarch was noted for the stately retinue that accompanied him, the luxurious banquets given at his abode, and the courtly etiquette that prevailed there. A brilliant account has come down of the ceremonies at the installation of a new exilarch. Homage was paid to him by the rabbinical heads of the colleges (each of whom was called Gaon, *q.v.*); rich gifts were presented; he visited the synagogue in state, where a costly canopy had been erected over his seat. The exilarch then delivered a discourse, and in the benediction or doxology (*Qaddish*) his name was inserted. Thereafter he never left his house except in a carriage of state and in the company of a large retinue. He would frequently have audiences of the king, by whom he was graciously received. He derived a revenue from taxes which he was empowered to exact. The exilarch could excommunicate, and no doubt had considerable jurisdiction over the Jews. A spirited description of the glories of the exilarch is given in D'Israeli's novel *Alroy*.

See Neubauer, *Mediaeval Jewish Chronicles*, ii. 68 seq.; Zacuto, *Yuhasin*; Graetz, *Geschichte*, vols. iv.-vi.; Benjamin of Tudela, *Itinerary*, ed. Adler, pp. 39 seq.; Bacher, *Jewish Encyclopaedia*, vol. v. 288. (I. A.)

EXILE (Lat. *exsilium* or *exilium*, from *exsul* or *exul*, which is derived from *ex*, out of, and the root *sal*, to go, seen in *salire*, to leap, *consul*, &c.; the connexion with *solum*, soil, country is now generally considered wrong), banishment from one's native country by the compulsion of authority. In a general sense exile is applied to prolonged absence from one's country either through force of circumstances or when undergone voluntarily. Among the Greeks, in the Homeric age, banishment (*φυγή*) was sometimes inflicted as a punishment by the authorities for crimes affecting the general interests, but is chiefly known in connexion with cases of homicide. With these the state had nothing to do; the punishment of the murderer was the duty and privilege of the relatives of the murdered man. Unless the relatives could be induced to accept a money payment by way of compensation (*ποινή*, weregeld; see especially Homer, *Iliad*, xviii. 497), in which case the murderer was allowed to remain in the country, his only means of escaping punishment was flight to a foreign land. If, during his self-imposed exile, the relatives expressed their willingness to accept the indemnity, he was at liberty to return and resume his position in society.

In later times banishment is (1) a legal punishment for particular offences; (2) voluntary.

1. Banishment for life with confiscation of property was inflicted upon those who destroyed or uprooted the sacred olives at Athens; upon those who remained neutral during a sedition (by a law of Solon, which subsequently fell into abeyance); upon those who gave refuge to or received on board ship a man who had fled to avoid punishment; upon those who wounded with intent to kill and those who prompted them to such an act (it is uncertain whether in this case exile was for life or temporary); upon any one who wilfully murdered an alien; for impiety. Certain political crimes were also similarly punished—treason, laconism, sycophancy (see SYCOPHANT), attempts to subvert existing decrees. For the peculiar form of banishment called OSTRACISM, see separate article.

In cases of voluntary homicide the punishment was death; but (except in cases of parricide) the murderer could leave the country unmolested after the first day of the trial. He was bound to remain outside Attica, and when on foreign soil was not allowed to appear at the public games, to enter the temples or take part in sacrifices; but provided that he adhered to the prescribed regulations, he was accorded a certain amount of protection. Even when a general amnesty was proclaimed, he was not allowed to return; if he did so, he might at once be put to death.

Temporary exile (the period of which is uncertain) without confiscation, was the punishment for involuntary homicide. As soon as the relatives of the deceased became reconciled to the man who had slain him, the latter was permitted to return; further, since banishment was only temporary, it is reasonable to suppose that the law insisted upon such reconciliation.

2. Citizens sometimes voluntarily left the country for other reasons (debt, inability to pay a fine). Since extradition was only demanded in cases of high treason or other serious offences against the state, the fugitive was not interfered with. He was at liberty to return after a certain time had elapsed.

Little is known about exile as it affected Sparta and other Greek towns, but it is probable that the same conditions prevailed as at Athens.

At Rome, in early times, exile was not a punishment, but rather a means of escaping punishment. Before judgment had been finally pronounced it was open to any Roman citizen condemned to death to escape the penalty by voluntary exile (*solum vertere exsilii causa*). To prevent his return, he was interdicted from the use of fire and water; if he broke the interdict and returned, any one had the right to put him to death. The *aquae et ignis* (to which *et tecti* "shelter" is sometimes added) *interdictio* is variously explained as exclusion from the necessaries of life,

from the symbols of civic communion, or from "the marks of a pure society, which the criminal would defile by his further use of them." Subsequently (probably at the time of the Gracchi) it became a recognized legal penalty, practically equivalent to "exile," taking the place of capital punishment. The criminal was permitted to withdraw from the city *after* sentence was pronounced; but in order that this withdrawal might as far as possible bear the character of a punishment, his departure was sanctioned by a decree of the people which declared his exile permanent. Authorities are not agreed whether this exile by interdiction entailed loss of *civitas*; according to some this did not ensue until (as in earlier times) the criminal had assumed the citizenship of the state in which he had taken refuge and thereby lost his rights as a citizen of Rome, while others hold that it was not until the time of Tiberius (A.D. 23) that *capitis deminutio media* became the direct consequence of trial and conviction. *Interdictio* was the punishment for treason, murder, arson and other serious offences which came under the cognizance of the *quaestiones perpetuae* (permanent judicial commissions for certain offences); confiscation of property was only inflicted in extreme cases.

Under the Empire *interdictio* gradually fell into disuse and a new form of banishment, introduced by Augustus, called *deportatio*, generally *in insulam*, took its place. For some time the two probably existed side by side. *Deportatio* consisted in transportation for life to an island (or some place prescribed on the mainland, not of Italy), accompanied by loss of *civitas* and all civil rights, and confiscation of property. The most dreaded places of exile were the islands of Gyarus, Sardinia, an oasis in the desert (*quasi in insulam*) of Libya; Crete, Cyprus and Rhodes were considered more tolerable. Large bodies of persons were also transported in this manner; thus Tiberius sent 4000 freedmen to Sardinia for Jewish or Egyptian superstitious practices. *Deportatio* was originally inflicted upon political criminals, but in course of time became more particularly a means of removing those whose wealth and popularity rendered them objects of suspicion. It was also a punishment for the following offences: adultery, murder, poisoning, forgery, embezzlement, sacrilege and certain cases of immorality.

Relegatio was a milder form of *deportatio*. It either excluded the person banished from one specified district only, with permission to choose a residence elsewhere, or the place of exile was fixed. *Relegatio* could be either temporary or for life, but it did not in either case carry with it loss of *civitas* or property, nor was the exile under military surveillance, as in the case of *deportatio*. Thus, Ovid, when in exile at Tomi, says (*Tristia*, v. 11): "he (*i.e.* the emperor) has not deprived me of life, nor of wealth, nor of the rights of a citizen . . . he has simply ordered me to leave my home." He calls himself *relegatus*, not *exsul*.

In later writers the word *exsilium* is used in the sense of all its three forms—*aquae et ignis interdictio*, *deportatio* and *relegatio*.

In England the first enactment legalizing banishment dates from the reign of Elizabeth (39 Eliz. c. 4), which gave power to banish from the realm "such rogues as are dangerous to the inferior people." A statute of Charles II. (18 Car. II. c. 3) gave power to execute or to transport to America for life the moss-troopers of Cumberland and Northumberland. Banishment or transportation for criminal offences was regulated by an act of 1824 (5 Geo. IV. s. 84) and finally abolished by the Penal Servitude Acts 1853 and 1857 (see further DEPORTATION). The word exile has sometimes, though wrongly, been applied to the sending away from a country of those who are not natives of it, but who may be temporary or even permanent residents in it (see ALIEN; EXPATRIATION; EXPULSION).

BIBLIOGRAPHY.—J. J. Thonissen, *Le Droit pénal de la république athénienne* (Brussels, 1875); G. F. Schömann, *Griechische Aeltertümer* (4th ed., 1897), p. 46; T. Mommsen, *Römisches Strafrecht* (1899), pp. 68, 964, and *Römisches Staatsrecht* (1887), iii. p. 48; L. M. Hartmann, *De exilio apud Romanos* (Berlin, 1887); F. von Holtzendorff-Vietmanskorf, *Die Deportationsstrafe im römischen Alterthum* (Leipzig, 1859); articles in Smith's *Dict. of Greek and Roman Antiquities* (3rd ed., 1890) and Daremberg and Saglio's *Dict. des antiquités* (C. Lécivain and G. Humbert).

EXILI, an Italian chemist and poisoner in the 17th century. His real name was probably Nicolo Egidi or Eggidio. Few authentic details of his life exist. Tradition, however, credits him with having been originally the salaried poisoner at Rome of Olympia Maidalchina, the mistress of Pope Innocent X. Subsequently he became a gentleman in waiting to Queen Christina of Sweden, whose taste for chemistry may have influenced this appointment. In 1663 his presence in France aroused the suspicions of the French government, and he was imprisoned in the Bastille. Here he is said to have made the acquaintance of Godin de Sainte-Croix, the lover of the marquise de Brinvilliers (*q.v.*). After three months' imprisonment, powerful influences secured Exili's release, and he left France for England. In 1681 he was again in Italy, where he married the countess Fantaguzzi, second cousin of Duke Francis of Modena.

EXMOOR FOREST, a high moorland in Somersetshire and Devonshire, England. The uplands of this district are bounded by the low alluvial plain of Sedgemoor on the east, by the lower basin of the Exe on the south, by the basin of the Taw (in part) on the west, and by the Bristol Channel on the north. The area thus defined, however, includes not only Exmoor but the Brendon and Quantock Hills east of it. Excluding these, the total area in the district lying at an elevation exceeding 1000 ft. is about 120 sq. m. The geological formation is Devonian. The ancient forest had an area of about 20,000 acres, and was enclosed in 1815. Large tracts are still uncultivated; and the wild red deer and native Exmoor pony are characteristic of the district. The highest point is Dunkery Beacon in the east (1707 ft.), but Span Head in the south-west is 1618 ft., and a height of 1500 ft. is exceeded at several points. The Exe, Barle, Lyn and other streams, traversing deep picturesque valleys except in their uppermost courses, are in favour with trout fishermen. The few villages, such as Exford, Withypool and Simonsbath, with Lynton and Lynmouth on the coast, afford centres for tourists and sportsmen. Exmoor is noted for its stag hunting. The district has a further fame through Richard Blackmore's novel, *Lorna Doone*.

EXMOUTH, EDWARD PELLEW, 1ST VISCOUNT (1757-1833), English admiral, was descended from a family which came originally from Normandy, but had for many centuries been settled in the west of Cornwall. He was born at Dover, on the 19th of April 1757. At the age of thirteen he entered the navy, and even then his smartness and activity, his feats of daring, and his spirit of resolute independence awakened remark, and pointed him out as one specially fitted to distinguish himself in his profession. He had, however, no opportunity of active service till 1776, when, at the battle of Lake Champlain, his gallantry, promptitude and skill, not only saved the "Carleton"—whose command had devolved upon him during the progress of the battle—from imminent danger, but enabled her to take a prominent part in sinking two of the enemy's ships. For his services on this occasion he obtained a lieutenant's commission, and the command of the schooner in which he had so bravely done his duty. The following year, in command of a brigade of seamen, he shared in the hardships and perils of the American campaign of General Burgoyne. In 1782, in command of the "Pelican," he attacked three French privateers inside the Île de Batz, and compelled them to run themselves on shore—a feat for which he was rewarded by the rank of post-captain. On the outbreak of the French War in 1793, he was appointed to the "Nymphé," a frigate of 36 guns; and, notwithstanding that for the sake of expedition she was manned chiefly by Cornish miners, he captured, after a desperate conflict, the French frigate "La Cléopâtre," a vessel of equal strength. For this act he obtained the honour of knighthood. In 1794 he received the command of the "Arethusa" (38), and in a fight with the French frigate squadron off the Île de Batz he compelled the "Pomona" (44) to surrender. The same year the western squadron was increased and its command divided, the second squadron being given to Sir Edward Pellew in the "Indefatigable" (44). While in command of this squadron he, on several occasions, performed acts of great personal daring;

and for his bravery in boarding the wrecked transport "Dutton," and his promptitude and resolution in adopting measures so as to save the lives of all on board, he was in 1796 created a baronet. In 1798 he joined the channel fleet, and in command of the "Impétueux" (74) took part in several actions with great distinction. In 1802 Sir Edward Pellew was elected member of parliament for Dunstable, and during the time that he sat in the Commons he was a strenuous supporter of Pitt. In 1804 he was made rear-admiral of the blue, and appointed commander-in-chief in India, where, by his vigilance and rapidity of movement, he entirely cleared the seas of French cruisers, and secured complete protection to English commerce. He returned to England in 1809, and in 1810 was appointed commander-in-chief in the North Sea, and in 1811 commander-in-chief in the Mediterranean. In 1814 he was created Baron Exmouth of Canonteign, and in the following year was made K.C.B., and a little later G.C.B. When the dey of Algiers, in 1816, violated the treaty for the abolition of slavery, Exmouth was directed to attack the town. Accordingly, on the 26th of August, he engaged the Algerine battery and fleet, and after a severe action of nine hours' duration, he set on fire the arsenal and every vessel of the enemy's fleet, and shattered the sea defences into ruins. At the close of the action the dey apologized for his conduct, and agreed to a renewal of the treaty, at the same time delivering up over three thousand persons of various nationalities who had been Algerine slaves. For this splendid victory Exmouth was advanced to the dignity of viscount. Shortly before his death, which took place on the 23rd of January 1833, he was made vice-admiral.

He had married Susan (d. 1837), daughter of James Frowde of Knoyle, Wiltshire, who bore him four sons and two daughters. His eldest son, Pownoll Bastard Pellew (1786-1833), became 2nd Viscount Exmouth, and his descendant, Edward Addington Hargreaves Pellew (b. 1890), became the 5th viscount in 1899.

Exmouth's second son, Sir Fleetwood Broughton Reynolds Pellew (1789-1861), was like his father an admiral. The third son was George Pellew (1793-1866), author and divine, who married Frances (d. 1870), daughter of the prime minister, Lord Sidmouth, and wrote his father-in-law's life (*The Life and Correspondence of Henry Addington, 1st Viscount Sidmouth*, 1847).

Exmouth had a brother, Sir Israel Pellew (1758-1832), also an admiral, who was present at the battle of Trafalgar.

A *Life* of the 1st viscount, by Edward Osler, was published in 1835.

EXMOUTH, a market-town, seaport and watering-place in the Honiton parliamentary division of Devonshire, England, at the mouth of the river Exe, 10½ m. S.E. by S. of Exeter by the London & South-Western railway. Pop. of urban district (1901) 10,485. In the 18th century it consisted of a primitive fishing village at the base of Beacon Hill, a height commanding fine views over the estuary and the English Channel. After its more modern terraces were built up the hillside, Exmouth became the first seaside resort in Devon. Its excellent bathing and the beauty of its coast and moorland scenery attract many visitors in summer, while it is frequented in winter by sufferers from pulmonary disease. The climate is unusually mild, as a range of hills shelters the town on the east. A promenade runs along the sea wall; there are golf links and public gardens, and the port is a favourite yachting centre, a regatta being held annually. Near the town is a natural harbour called the Bight. The local industries include fishing, brick-making and the manufacture of Honiton lace. Exmouth was early a place of importance, and in 1347 contributed 10 vessels to the fleet sent to attack Calais. It once possessed a fort or "castelet," designed to command the estuary of the Exe. This fort, which was garrisoned for the king during the Civil War, was blockaded and captured by Colonel Shapcoate in 1646.

EXODUS, BOOK OF, in the Bible, a book of the Old Testament which derives its name, through the Greek, from the event which forms the most prominent feature of the history it narrates, viz. the deliverance of Israel from Egypt. Strictly speaking, however, this title is applicable to the first half only, the historical portion of the book, and takes no account of those

chapters which describe the giving of the Law on Mt. Sinai, nor of those which deal with the Tabernacle and its furniture. By the Jews it is usually styled after its opening words *וַיִּצְרַח יִשְׂרָאֵל* (*We'eleh Shēmōlh*) or, more briefly, *שְׁמֹלֵחַ* (*Shēmōlh*).

In its present form the book sets forth (a) the oppression of the Israelites in Egypt (ch. i.), (b) the birth and education of Moses, and his flight to the land of Midian (ch. ii.), (c) the theophany at Mt. Horeb (the Burning Bush), and the subsequent commission of Moses and Aaron (iii. 1-iv. 17), (d) the return of Moses to Egypt, and his appeal to Pharaoh which results in the further oppression of Israel (iv. 18-vii. 7), (e) the plagues of Egypt (vii. 8-xi. 10), (f) the institution of the Passover and of the Feast of Unleavened Cakes, the last plague, and Israel's departure from Egypt (xii. 1-xiii. 16), (g) the crossing of the Red Sea and the discomfiture of the Egyptians, the Song of Triumph, the sending of the manna and other incidents of the journeying through the wilderness (xiii. 17-xviii. 27), (h) the giving of the Law, including the Decalogue and the so-called Book of the Covenant, on Sinai-Horeb (xix.-xxiv.), (i) directions for the building of the Tabernacle and for the consecration of the priests (xxv.-xxxi.), (j) the sin of the Golden Calf, and another earlier version of the first legislation (xxxii.-xxxiv.), (k) the construction of the Tabernacle and its erection (xxxv.-xl.). The book of Exodus, however, like the other books of the Hexateuch, is a composite work which has passed, so to speak, through many editions; hence the order of events given above cannot lay claim to any higher authority than that of the latest editor. Moreover, the documents from which the book has been compiled belong to different periods in the history of Israel, and each of them, admittedly, reflects the standpoint of the age in which it was written. Hence it follows that the contents of the book are not of equal historical value; and though the claim of a passage to be considered historical is not necessarily determined by the age of the source from which it is derived, yet, in view of the known practice of Hebrew writers, greater weight naturally attaches to the earlier documents in those cases in which the sources are at variance with one another. Any attempt, therefore, at restoring the actual course of history must be preceded by an inquiry into the source of the various contents of the book.

The sources from which the book of Exodus has been compiled are the same as those which form the basis of the book of Genesis, while the method of composition is very similar. Here, too, the strongly marked characteristics of P, or the Priestly Document, as opposed to JE, enable us to determine the extent of that document with comparative ease; but the absence, in some cases, of conclusive criteria prevents any final judgment as to the exact limits of the two strands which have been united in the composite JE. The latter statement applies especially to the legislative portions of the book: in the historical sections the separation of the two sources gives rise to fewer difficulties. It does not, however, lie within the scope of the present article to examine the various sources underlying the narrative with any minuteness, but rather to sum up those results of modern criticism which have been generally accepted by Old Testament scholars. To this end it will be convenient to treat the subject-matter of the book under three main heads: (a) the historical portion (ch. i.-xviii.), (b) the sections dealing with the giving of the Law (xix.-xxiv., xxxii.-xxxiv.), and (c) the construction of the Tabernacle and its furniture (xxv.-xxxi., xxxv.-xl.).

(a) *Israel in Egypt and the Exodus* (ch. i.-xviii.). (1) i. 1-vii. 13.—The analysis of these chapters shows that the history, in the main, has been derived from the two sources J and E, chiefly the former, and that a later editor has included certain passages from P, besides introducing a slight alteration of the original order and other redactional changes. The combined narrative of JE sets forth the rise of a new king in Egypt, who endeavoured to check the growing strength of the children of Israel; it thus prepares the way for the birth of Moses, his early life in Egypt, his flight to Midian and marriage with Zipporah, the theophany at Mt. Horeb, and his divine commission to deliver Israel from Egypt.

At the very outset the two sources betray their divergent origin and point of view. According to J (i. 6, 8-12, 20b) the Israelites dwell apart in the province of Goshen, and their numbers become so great as to call for severe measures of repression, the method employed being that of forced labour. E, on the other hand (i. 15-20a,

21, 22), represents them as living among the Egyptians, and so few in number that two midwives satisfy their requirements. It is to this latter source that we owe the account of the birth of Moses and of his education at the court of Pharaoh (ii. 1-10). On reaching manhood Moses openly displays his sympathy with his brethren by slaying an Egyptian, and has, in consequence, to flee to Midian, where he marries Zipporah, the daughter of the priest of Midian (ii. 11-22). In this section the editor has undoubtedly made use of the parallel narrative of J, though it is impossible to determine the exact point at which J's account is introduced: certainly ii. 15b-22 belong to that source.¹ The narrative of the call of Moses is by no means uniform, and shows obvious traces of twofold origin (J iii. 2-4a, 5, 7, 8, 16-18; iv. 1-12 (13-16), 29-31; E iii. 1, 4b, 6, 9-14, 21, 22; iv. 17, 18, 20b, 27, 28). These two sources present striking points of difference, which reappear in the subsequent narrative. According to E, Moses with Aaron is to demand from Pharaoh the release of Israel, which will be effected in spite of his opposition; in assurance thereof the promise is given that they shall serve God upon this mountain; moreover, the people on their departure are to borrow raiment and jewels from their Egyptian neighbours. According to J, on the other hand, the spokesmen are to be Moses and the elders; and their request is for a temporary departure only, viz. "three days' journey into the wilderness"; their departure from Egypt is a hurried one. Yet another difficulty, which disappears as soon as the composite character of the narrative is recognized, is that of the signs. In J three signs are given for the purpose of reassuring Moses, only one of which is wrought with the rod (iv. 1-9), but in iv. 17 (E) the reference is clearly to entirely different signs, probably the plagues of Egypt, which according to E were invariably wrought by "the rod of God." Further, it is questionable if the passage iv. 13-16 really forms part of the original narrative of J, and is not rather to be ascribed to the redactor of JE. The name of Aaron has certainly been introduced by a later hand in J's account of the plague of frogs (viii. 12), and the only passage in J in which Aaron is represented as taking an active part is iv. 29-31, where the mention of his name causes no little difficulty.² In E, on the other hand, Aaron is sent by God to meet Moses at Mt. Horeb, after the latter had taken leave of Jethro, and, later on, accompanies him into the presence of Pharaoh. The succeeding narrative (v. 1-vi. 1) is mainly taken from J, though E's account of the first interview with Pharaoh has been partially retained in v. 1, 2, 4. Moses and the elders ask leave to go three days' journey into the wilderness to sacrifice to Yahweh, a request which is met by an increase of the burdensome work of brick-making: henceforward the Israelites have to provide their own straw. The people complain bitterly to Moses, who appeals to Yahweh and is assured by him of the future deliverance of Israel "by a strong hand."

With the exception of the genealogical list (i. 1-5) and the brief notices of the increase of Israel (i. 7) and of its oppression at the hands of the Egyptians (i. 13, 14; ii. 23b-25), the narrative so far exhibits no traces of P.³ But in vi. 2-vii. 13 we are confronted with a narrative which carries us back to ii. 23b-25 and gives practically a parallel account to that of JE in ch. iii.-v. Thus the revelation of the divine name, vi. 2f., finds its counterpart in iii. 10f., the message to be delivered to Israel (vi. 6f.) is very similar to that of ch. iii. 16f., while the demand which is to be addressed to Pharaoh is identical

with that which had been already refused in ch. v. No allusion, however, is made by Moses to this previous demand; he merely urges the same objection as that put forward in iv. 10f. With the resumption of the story in vi. 28 f. Moses reiterates his objection, and is told that Aaron shall be his "prophet" and speak for him, and shall also perform the sign of the rod (cf. iv. 2-4). The sign, however, has no effect on Pharaoh (vii. 13), and we thus reach the same point in the narrative as at vi. 1. Apart from the literary characteristics which clearly differentiate this narrative from the preceding accounts of J and E, the following points of variation are worthy of consideration: (1) The people refuse to listen to Moses; (2) Aaron is appointed to be Moses' spokesman, not with the people, but with Pharaoh; (3) one sign is given (not three) and performed before Pharaoh; (4) the rod is turned into a reptile (*tannin*), not a serpent (*nāhāsh*).

(2) vii. 14-xi. 10. *The First Plagues of Egypt.*—In this section the analysis again reveals three main sources, which are clearly marked off from one another both by their linguistic features and by their difference of representation. The principal source is J, from which are derived six plagues, viz. killing of the fish in the river (vii. 14, 16, 17a, 18, 21a, 24, 25), frogs (viii. 1-4, 8-15a), insects (viii. 20-32), murrain (ix. 1-7), hail (ix. 13-18, 23b, 24b, 25b-34), locusts (x. 1a, 3-11, 13b, 14b, 15a, c-19, 24-26, 28, 29), the threat to slay all the first-born (xi. 4-8). The most striking characteristic of this narrative is that the plagues are represented as mainly due to natural causes and follow a natural sequence. Thus Yahweh smites the river so that the fish die and render the water undrinkable. This is succeeded by a plague of frogs. The swarms of flies and insects, which next appear, are the natural outcome of the decaying masses of frogs, and these, in turn, would form a natural medium for the spread of cattle disease. Destructive hailstorms, again, though rare, are not unknown in Egypt, while the locusts are definitely stated to have been brought by a strong east wind. Other distinctive features of J's narrative are: (1) Moses alone is bidden to interview Pharaoh (vii. 14 f.; viii. 1 f., 20 f.; ix. 1 f., 13 f.; x. 1 f.); (2) on each occasion he makes a formal demand; (3) on Pharaoh's refusal the plague is announced, and takes place at a fixed time without any human intervention; (4) when the plague is sent, Pharaoh sends for Moses and entreats his intercession, promising in most cases to accede in part to his request; when the plague is removed, however, the promise is left unfulfilled, the standing phrase being "and Pharaoh's heart was heavy (כבד), " or "and Pharaoh made heavy (כביר) his heart"; (5) the plagues do not affect the children of Israel in Goshen. E's account (water turned into blood, vii. 15, 17b, 20b, 23; hail, ix. 22, 23a, 24a, 25a, 35; locusts, x. 12, 13a, 14a, 15b) is more fragmentary, having been doubtless superseded in most cases by the fuller and more graphic narrative of J, but the plague of darkness (x. 20-23, 27) is found only in this source. As contrasted with J the narrative emphasizes the miraculous character of the plagues. They are brought about by "the rod of God," which Moses wields, the effect being instantaneous and all-embracing. The Israelites are represented as living among the Egyptians, and enjoy no immunity from the plagues, except that of darkness. Their departure from Egypt is deliberate; the people have time to borrow raiment and jewels from their neighbours. E regularly uses the phrase "and Pharaoh's heart was strong (קח), " or "and Yahweh made strong (חייק) Pharaoh's heart" and "he would not let the children of Israel (or, them) go." In the priestly narrative (P) the plagues assume the form of a trial of skill between Aaron, who acts at Moses' command, and the Egyptian magicians, and thus connect with vii. 8-13. The magicians succeed in turning the Nile water into blood (vii. 19, 20a, 21b, 22), and in bringing up frogs (viii. 5-7), but they fail to bring forth lice (viii. 15b-19), and are themselves smitten with boils (ix. 8-12): the two last-named plagues have no parallel either in J or E. Throughout the P sections Aaron is associated with Moses, and the regular command given to the latter is "Say unto Aaron": no demand is ever made to Pharaoh, and the description of the plague is quite short. The formula employed by P is "and Pharaoh's heart was strong (קח)," or "and Pharaoh made strong (חייק) his heart," as in E, but it is distinguished from E's phrase by the addition of "and he hearkened not unto them as Yahweh had spoken."

(3) xii. 1-xiii. 16. *The Last Plague, the Deliverance from Egypt, the Institution of the Passover and of the Feast of Unleavened Cakes, the Consecration of the First-born.*—This section presents the usual phenomena of a composite narrative, viz. repetitions and inconsistencies. Thus J's regulations for the Passover (xii. 21-23, 27b) seem at first sight simply to repeat the commands given to Moses and Aaron in xii. 1-13 (P), but in reality they are a parallel and divergent account. In v. 1-13 the choice of the lamb and the manner in which it is to be eaten constitute the essential feature, the smearing with the blood being quite secondary; in v. 21 f. the latter point is all-important, and no regulations are given for the paschal meal (which, possibly, formed no part of J's original account). Similarly the institution of the Feast of Mazzoth, or Unleavened Cakes (xiii. 3-10J), does not form the sequel to the regulations laid down in xii.

¹ The genealogy of Moses and Aaron (v. 14-27) appears to be a later addition.

¹ The fact that the father-in-law of Moses is called Reuel in v. 18, as contrasted with the name Jethro, which occurs in iii. 1 f. and in all subsequent passages from E, cannot be taken as conclusive on this point, since critics are agreed that "Reuel" in this verse is a later addition: had it been original we should have expected the name to be given at v. 16 rather than at v. 18. But, if no argument can be based on the discrepancy between the two names, we may at least assume that the namelessness of the priest in v. 16 f. points to a different source for those verses from that of iii. 1 f. Elsewhere J speaks of "Hobab, the son of Reuel the Midianite, Moses' father-in-law" (Num. x. 29); the addition, "the priest of Midian," only occurs in the (secondary) passages iii. 1, xviii. 1 (E). Probably RJE omitted the name in ii. 16 and added "the priest of Midian" in iii. 1, xviii. 1, from harmonizing motives. Further, v. 15b-22 speak of one son being born to Moses at this period, a statement which is borne out by iv. 20, 25 ("sons" in iv. 20 is obviously a correction), whereas ch. xviii. (E) mentions two sons.

The original order of events in J seems to have been as follows: after the death of Pharaoh (ii. 23a; the Septuagint repeats this notice before iv. 19) Moses returns to Egypt with his wife and son (iv. 19, 20) in obedience to Yahweh's command. On the way he is seized with a sudden illness, which Zipporah attributes to the fact that he has not been circumcised and seeks to avert by circumcising her son (iv. 24-26). The scene of the theophany, therefore, according to J, is to be placed on the way from Midian to Goshen. Probably the displacement of iv. 19, 20, 24-26 is due to the editor of JE, who was thus enabled to combine the two narratives of the theophany.

² Cf. iv. 30; Aaron had received no command to do the signs, and the words "and he did the signs" are most naturally referred to Moses.

³ The expansion in iii. 8c, 15, 17b; iv. 22, 23, are probably the work of a Deuteronomistic redactor.

of the mountain, but that Moses alone was permitted to approach Yahweh. Then followed the theophany, and, as the text stands, the sacrificial meal (9-11).¹ The conclusion of J's narrative is given in ch. xxxiv.,² which describes how Moses hewed two tables of stone at Yahweh's command, and went up to the top of the mountain, where he received the words of the covenant and wrote them on the tables. As it stands, however, this chapter represents the legislation which it contains as a renewal of a former covenant, also written on tables of stone, which had been broken (1b, 4a). But the document from which the chapter, as a whole, is derived, is certainly J, while the previous references to tables of stone and to Moses' breaking them belong to the parallel narrative of E. Moreover, the covenant here set forth (v. 10 f.) is clearly a new one, and contains no hint of any previous legislation, nor of any breach of it by the people. In view of these facts we are forced to conclude that 1b ("like unto the first . . . brakest"), 4a ("and he hewed . . . the first") and v. 28 ("the ten words") formed no part of the original narrative,³ but were inserted by a later Deuteronomist redactor. In the view of this editor the Decalogue alone formed the basis of the covenant at Sinai-Horeb, and in order to retain J's version, he represented it as a renewal of the tables of stone which Moses had broken.⁴

The legislation contained in xxxiv. 10-26, which may be described as the oldest legal code of the Hexateuch, is almost entirely religious. It prohibits the making of molten images (v. 17), the use of leaven in sacrifices (25a), the retention of the sacrifice until the morning (25b),⁵ and the seething of a kid in its mother's milk (26b); and enjoins the observance of the three annual feasts and the Sabbath (18a, 21-23), and the dedication of the first-born (19, 20, derived from xiii. 11-13) and of the first-fruits (26a).

The parallel collection of E is preserved in xx. 24-26, xxxiii. 10-19, to which we should probably add xxii. 29-31 (for which xxxiii. 19a was afterwards substituted). The two collections resemble one another so closely, both in form and extent, that they can only be regarded as two versions of the same code. E has, however, preserved certain additional regulations with regard to the building of altars (xx. 24-26) and the observance of the seventh year (xxxiii. 10, 11), and omits the prohibition of molten images (xx. 22, 23, appear to be the work of a redactor); xxxiii. 20-33, the promises attached to the observance of the covenant, probably formed no part of the original code, but were added by the Deuteronomist redactor; cf. especially vv. 23-25a, 27, 28, 31b-33. The narrative of E relative to the delivery of these laws has disappeared,⁶ but xxiv. 3-8 (which manifestly have no connexion with their immediate context) clearly point back to some such narrative. These verses describe how Moses wrote all the words of the Lord in a book and recited them to the people (v. 7) as the basis of a covenant, which was solemnly ratified by the sprinkling of the blood of the accompanying sacrifices.

In the existing text the covenant laws of E (xx. 24-26, xxii. 29-31, xxxiii. 10-19) are combined with a mass of civil and other legislation; hence the title "Book of the Covenant" (referred to above, xxiv. 7) has usually been applied to the whole section, xx. 22-xxxiii. 33. But this section includes three distinct elements: (a) the "words" (דברים) found in xx. 24-26, xxii. 29-31, xxxiii. 1-10; (b) the "judgments" (מִשְׁפָּטִים), xxi. 2-xxii. 17; and (c) a group of moral and ethical enactments, xxii. 18-28, xxxiii. 1-9; and an examination of their contents makes it evident that, though the last two groups are unmistakably derived from E, they cannot have formed part of the original "Book of the Covenant"; for the "judgments," which are expressed in a hypothetical form, consist of a number of legal decisions on points of civil law. The cases dealt with fall into five divisions: (1) The rights of slaves, xxi. 2-11; (2) capital offences, xxi. 12-16 (v. 17 has probably been added later); (3) injuries inflicted by man or beast, xxi. 18-32; (4) losses incurred by culpable negligence or theft, xxi. 33-xxii. 6; (5) cases arising out of deposits, loans, seduction, xxii. 7-17. It is obvious, from their very nature, that these legal precedents could not have been included in the covenant which the people (xxiv. 3) promised to observe, and it is

¹ Unless we follow Riedel and read simply "and worshipped" (יִשְׁתַּחֲוּ) instead of "and drank" (יָשָׁה), treating "and ate" (אִכְלוּ) as a later addition; cf. *HDB*, extra vol. p. 631 note.

² Vv. 6-9 are out of place here: they belong to the story of Moses' intercession in ch. xxxiii.

³ This view is confirmed by (a) a comparison of v. 1b ("and I will write") with vv. 27, 28; according to the latter, Moses wrote the words of the covenant; and (b) the tardy mention of Moses in 4b; the name would naturally be given at the beginning of the verse.

⁴ Others suppose that the present position of ch. xxxiv. is due, in the first instance, to RJE, but in view of the other Deuteronomist expansions in vv. 10b-16, 23, 24, it is more probable that J's version was discarded by RJE in favour of E's, and was afterwards restored by RD.

⁵ Reading "the sacrifice of my feasts" for "the sacrifice of the feast of the Passover."

⁶ Unless, with Bacon, we are to regard xxiv. 12-14, 18b as original. More probably a later editor has worked up old material of E (of which there are unmistakable traces) in order to include the whole of xx.-xxxiii. in the covenant: xxiv. 15-18a are an addition from P.

now generally admitted that the words "and the judgments" (which are missing in c. 1 b) have been inserted in xxiv. 3a by the redactor to whom the present position of the "judgments" is due.⁷ The majority of critics, therefore, adopt Kuenen's conjecture that the "judgments" were originally delivered by Moses on the borders of Moab, and that when D's revised version of Ex. xxi.-xxxiii. was combined with JE, the older code was placed alongside of E's other legislation at Horeb. The third group of laws (xxii. 18-28, xxxiii. 1-9) appears to have been added somewhat later than the bulk of xxi.-xxxiii. Some of the regulations are couched in hypothetical form, but their contents are of a different character to the "judgments," e.g. xxii. 25 f., xxxiii. 4 f.; others, again, are of a similar nature, but differ in form, e.g. xxii. 18 f. Lastly, xxii. 20-24, xxxiii. 1-3 set forth a number of moral injunctions affecting the individual, which cannot have found place in a civil code. At the same time, these additions must for the most part be prior to D, since many of them are included in Deut. xii.-xxvi., though there are traces of Deuteronomist revision.

Now it is obvious that the results obtained by the foregoing analysis of J and E have an important bearing on the history of the remaining section of E's legislation, viz. the Decalogue (*q.v.*), Ex. xx. 1-17 (=Deut. v. 6-21). At present the "Ten Words" stand in the forefront of E's collection of laws, and it is evident that they were already found in that position by the author of Deuteronomy, who treated them as the sole basis of the covenant at Horeb. The evidence, however, afforded (a) by the parallel version of Deuteronomy and (b) by the literary analysis of J and E not only fails to support this tradition, but excites the gravest suspicions as to the originality both of the form and of the position in which the Decalogue now appears. For when compared with Ex. xx. 1-17 the parallel version of Deut. v. 6 ff. is found to exhibit a number of variations, and, in particular, assigns an entirely different reason for the observance of the Sabbath. But these variations are practically limited to the explanatory comments attached to the 2nd, 4th, 5th and 10th commandments; and the majority of critics are now agreed that these comments were added at a later date, and that all the commandments, like the 1st and the 6th to the 9th, were originally expressed in the form of a single short sentence. This view is confirmed by the fact that the additions, or comments, bear, for the most part, a close resemblance to the style of D. They can scarcely, however, have been transferred from Deuteronomy to Exodus (or vice versa), owing to the variations between the two versions: we must rather regard them as the work of a Deuteronomist redactor. But the expansion and revision of the Decalogue were not limited to the Deuteronomist school. Literary traces of J and E in the 2nd, 3rd, 4th and 10th commandments point to earlier activity on the part of RJE, while the addition of v. 11, which bases the observance of the Sabbath on P's narrative of the Creation (Gen. ii. 1-3), can only be ascribed to a priestly writer: its absence from Deut. v. 6 ff. is otherwise inexplicable. Thus the Decalogue, as given in Exodus, would seem to have passed through at least three stages before it assumed its present form. But even in its original form it could hardly have formed part of E's Horeb legislation; for (a) both J and E have preserved a different collection of laws (or "words") inscribed by Moses, which are definitely set forth as the basis of the covenant at Sinai-Horeb (Ex. xxxiv. 10, xxiv. 3 f.), and (b) the further legislation of E in ch. xx.-xxxiii. affords close parallels to all the commandments (except the 7th and the 10th), and a comparison of the two leaves no doubt as to which is the more primitive. Hence we can only conclude that the Decalogue, in its original short form, came into existence during the period after the completion of E, but before the promulgation of Deuteronomy. Its present position is, doubtless, to be ascribed to a redactor who was influenced by the same conception as the author of Deuteronomy. This redactor, however, did not limit the Horeb covenant to the Decalogue, but retained E's legislation alongside of it. The insertion of the Decalogue, or rather the point of view which prompted its insertion, naturally involved certain consequential changes of the existing text. The most important of these, viz. the harmonistic additions to ch. xxxiv., by means of which J's version of the covenant was represented as a renewal of the Decalogue, has already been discussed; other passages which show traces of similar revision are xxiv. 12-15a, 18b, and xxxiv. 1-6.

The confusion introduced into the legislation by later additions, with the consequent displacement of earlier material, has not been without effect on the narratives belonging to the different sources. Hence the sequence of events after the completion of the covenant on Sinai-Horeb is not always easy to trace, though indications are not wanting in both J and E of the probable course of the history. The two main incidents that precede the departure of the children of Israel from the mountain (Num. x. 29 ff.) are (1) the sin of the people, and (2) the intercession of Moses, of both of which a double account has been preserved.

⁷ The present text of xxiv. 12 also has probably been transposed in accordance with the view that the "judgment" formed part of the covenant, cf. Deut. v. 31. Originally the latter part of the verse must have run, "That I may give thee the tables of stone which I have written, and may teach thee the law and the commandment." For further details see Bacon, *Triple Tradition of Exodus*, pp. 111 f., 132 f.

(1) *The Sin of the People*.—According to J (xxxii. 25-29) the people, during the absence of Moses, "break loose," *i.e.* mutiny. Their behaviour excites the anger of Moses on his return, and in response to his appeal the sons of Levi arm themselves and slay a large number of the people: as a reward for their services they are bidden to consecrate themselves to Yahweh. The fragmentary form of the narrative—we miss especially a fuller account of the "breaking loose"—is doubtless due to the latter editor, who substituted the story of the golden calf (xxxii. 1-6, 15-24, 35), according to which the sin of the people consisted in direct violation of the 2nd commandment. At the instigation of the people Aaron makes a molten calf out of the golden ornaments brought from Egypt; Moses and Joshua, on their return to the camp, find the people holding festival in honour of the occasion; Moses in his anger breaks the tables of the covenant which he is carrying: he then demolishes the golden calf, and administers a severe rebuke to Aaron. The punishment of the people is briefly recorded in v. 35. This latter narrative, which is obviously inconsistent with the story of J, shows unmistakable traces of E. In its present form, however, it can hardly be original, but must have been revised in accordance with the later Deuteronomistic conception which represented the sin committed by the people as a breach of the 2nd commandment. Possibly vv. 7-14 are also to be treated as a Deuteronomistic expansion (cf. Deut. ix. 12-14). Though they show clear traces of J, it is extremely difficult to fit them into that narrative in view of Moses' action in vv. 25-29 and of his intercession in ch. xxxiii.; in any case, vv. 8 and 13 must be regarded as redactional.

(2) *Moses' Intercession*.—The time for departure from the Sacred Mount had now arrived, and Moses is accordingly bidden to lead the people to the promised land. Yahweh himself refuses to accompany Israel owing to their disobedience, but in response to Moses' passionate appeal finally consents to let his presence go with them. The account of Moses' intercession has been preserved in J, though the narrative has undergone considerable dislocation. The true sequence of the narrative appears to be as follows: Moses is commanded to lead the people to Canaan (xxxiii. 1-3); he pleads that he is unequal to the task (Num. xi. 10c, 11, 12, 14, 15), and, presumably, asks for assistance, which is promised (omitted). Moses then asks for a fuller knowledge of Yahweh and his ways (xxxiii. 12, 13); this request also is granted (v. 17), and he is emboldened to pray that he may see the glory of Yahweh; Yahweh replies that his prayer can only be granted in part, for "man shall not see me and live"; a partial revelation is then vouchsafed to Moses (xxxiii. 18-23, xxxiv. 6-8): finally, Moses beseeches Yahweh to go in the midst of his people, and is assured that Yahweh's presence shall accompany them (xxxiv. 9, xxxiii. 14-16). The passage from Numbers xi., which is here included, is obviously out of place in its present context (the story of the quails), and supplies in part the necessary antecedent to Ex. xxxiii. 12, 13; the passage is now separated from Ex. xxxiii. by Ex. xxxiv. (J), which has been wrongly transferred to the close of the Horeb-Sinai incidents (see above), and by the priestly legislation of Ex. xxxv.-xl., Leviticus and Num. i.-x.; but originally it must have stood in close connexion with that chapter. A similar displacement has taken place with regard to Ex. xxxiv. 6-9, which clearly forms the sequel to xxxiii. 17-23. The latter passage, however, can hardly represent the conclusion of the interview, which is found more naturally in xxxiii. 14-16. E's account of Moses' intercession seems to have been retained, in part, in xxxii. 30-34, but the passage has probably been revised by a later hand; in any case its position *before* instead of *after* the dismissal would seem to be redactional.

It is a plausible conjecture that the original narratives of J and E also contained directions for the construction of an ark,¹ as a substitute for the personal presence of Yahweh, and also for the erection of a "tent of meeting" outside the camp, and that these commands were omitted by R^E in favour of the more elaborate instructions given in ch. xxv.-xxix. (P). The subsequent narrative of J (Num. x. 33-36, xiv. 44) implies an account of the making of the ark, while the remarkable description in Ex. xxxiii. 7-11 (E) of Moses' practice in regard to the "tent of meeting" points no less clearly to some earlier statement as to the making of this tent.

The history of Exodus in its original form doubtless concluded with the visit of Moses' father-in-law and the appointment of judges (ch. xviii.), the departure from the mountain and the battle with Amalek (xvii. 8-16).

(c) *The Construction of the Tabernacle and its Furniture* (ch. xxv.-xxxi., xxxv.-xl.).—It has long been recognized that the elaborate description of the Tabernacle and its furniture, and the accompanying directions for the dress and consecration of the priests, contained in ch. xxv.-xxxi., have no claim to be regarded as an historical presentment of the Mosaic Tabernacle and its service. The language, style and contents of this section point unmistakably to the hand of P; and it is now generally admitted that these chapters form part of an ideal representation of the post-exilic ritual system, which has been transferred to the Mosaic age. According to this

representation, Moses, on the seventh day after the conclusion of the covenant, was summoned to the top of the mountain, and there received instructions with regard to (a) the furniture of the sanctuary, viz. the ark, the table and the lamp-stand (ch. xxv.); (b) the Tabernacle (ch. xxvi.); (c) the court of the Tabernacle and the altar of burnt-offering (ch. xxvii.); (d) the dress of the priests (ch. xxviii.); (e) the consecration of Aaron and his sons (xxix. 1-37); and (f) the daily burnt-offering (xxix. 38-42): the section ends with a formal conclusion (xxix. 43-46). The two following chapters contain further instructions relative to the altar of incense (xxx. 1-10), the payment of the half-shekel (11-16), the brazen laver (17-21), the anointing oil (22-33), the incense (34-38), the appointment of Bezaleel and Oholiab (xxxi. 1-11) and the observance of the Sabbath (12-17). It is hardly doubtful, however, that these two chapters formed no part of P's original legislation, but were added by a later hand.² For (1) the altar of incense is here mentioned for the first time, and was apparently unknown to the author of ch. xxv.-xxix. Had he known of its existence, he could hardly have failed to include it with the rest of the Tabernacle furniture in ch. xxvi., and must have mentioned it at xxvi. 34 f., where the relative positions of the contents of the Tabernacle are defined: further, the ritual of the Day of Atonement (Lev. xvi. referred to in xxx. 10) ignores this altar, and mentions only *one* altar (cf. "the altar," xxvii. 1), viz. that of burnt-offering; (2) the command as to the half-shekel presupposes the census of Num. i., and appears to have been unknown in the time of Nehemiah (Neh. x. 32) (Heb. 33); (3) the instructions as to the brazen laver would naturally be expected alongside of those for the altar of burnt-offering in ch. xxvii.; (4) the following section relating to the anointing oil presupposes the altar of incense (v. 28), and further extends the ceremony of anointing to Aaron's sons, though, elsewhere, the ceremony is confined to Aaron (xxix. 7, Lev. viii. 12), cf. the title "anointed priest" applied to the high priest (Lev. iv. 3, &c.); (5) the directions for compounding the incense connect naturally with xxx. 1-10, while (6) the appointment of Bezaleel and Oholiab cannot be separated from the rest of ch. xxx.-xxxi. The concluding section on the Sabbath (xxxi. 12-17) shows marks of resemblance to H (Lev. xvii.-xxvi.), especially in vv. 12-14a, which appear to have been expanded, very possibly by the editor who inserted the passage. The continuation of P's narrative is given in xxxiv. 29-35, which describe Moses' return from the mount. The subsequent chapters (xxxv.-xl.), however, can hardly belong to the original stratum of P, if only because they presuppose ch. xxx., xxxi., and were probably added at a later stage than the latter chapters. They narrate how the commands of ch. xxv.-xxxi. were carried out, and practically repeat the earlier chapters *verbatim*, merely the tenses being changed, the most noticeable omissions being xvii. 20 f. (oil for the lamps), xxviii. 30 (Urim and Thummim), xxix. 1-37 (the consecration of the priests, which recurs in Lev. viii.) and xxix. 38-42 (the daily burnt-offering). Apart from the omissions the most striking difference between the two sections is the variation in order, the different sections of ch. xxv.-xxxi. being here set forth in their natural sequence. The secondary character of these concluding chapters receives considerable confirmation from a comparison of the Septuagint text. For this version exhibits numerous cases of variation, both as regards *order* and *contents*, from the Hebrew text; moreover the translation, more particularly of many technical terms, differs from that of ch. xxv.-xxxi., and seems to be the work of different translators. Hence it is by no means improbable that the final recension of these chapters had not been completed when the Alexandrine version was made.

AUTHORITIES.—In addition to the various English and German commentaries on Exodus included under the head of the Pentateuch, the following English works are especially worthy of mention: S. R. Driver, *Introd. to the Literature of the O.T.*, and "Exodus" in the *Camb. Bible*; B. W. Bacon, *The Triple Tradition of the Exodus* (Hartford, U.S.A., 1894), and A. H. McNeile, *The Book of Exodus* (Westminster Commentaries) (1908); also the articles on "Exodus" by G. Harford-Battersby (Hastings, *Dict. Bib.* vol. i.) and by G. F. Moore, *Ency. Biblica*, vol. ii. (J. F. St.)

EXODUS, THE, the name given to the journey (Gr. *ἐξόδος*) of the Israelites from Egypt into Palestine, under the leadership of Moses and Aaron, as described in the books of the Bible from Exodus to Joshua. These books contain the great national epic of Judaism relating the deliverance of the people from bondage in Egypt, the overthrow of the pursuing Pharaoh and his army, the divinely guided wanderings through the wilderness and the final entry into the promised land. Careful criticism of the narratives³ has resulted in the separation of later accretions from the earliest records, and the tracing of the elaboration of older traditions under the influence of developing religious and social institutions. In the story of the Exodus there have been incorporated codes of laws and institutions which were to be observed by the descendants of the Israelites in their future

¹ According to Deut. x. 1 f., which is in the main a *verbal* excerpt from Ex. xxxiv. 1 f., Yahweh ordered Moses to make an ark of acacia wood *before* he ascended the mountain.

² To the same hand are to be ascribed also xxvii. 6, 20, 21; xxviii. 41; xxix. 21, 38-41.

³ See the articles on the books in question.

home, and these, really of later origin, have thus been thrown back to the earlier period in order to give them the stamp of authority. So, although a certain amount of the narrative could date from the days of Moses, the Exodus story has been made the vehicle for the aims and ideals of subsequent ages, and has been adapted from time to time to the requirements of later stages of thought. The work of criticism has brought to light important examples of fluctuating tradition, singular lacunae in some places and unusual wealth of tradition in others, and has demonstrated that much of that which had long been felt to be impossible and incredible was due to writers of the post-exilic age many centuries after the presumed date of the events.

The book of Genesis closes with the migration of Jacob's family into Egypt to escape the famine in Canaan. Jacob died and was buried in Canaan by his sons, who, however, returned again to the pastures which the Egyptian king had granted them in Goshen. Their brother Joseph on his death-bed promised that God would bring them to the land promised to their forefathers and solemnly adjured them to carry up his bones (Gen. l.). In the book of Exodus the family has become a people.¹ The Pharaoh is hostile, and Yahweh, the Israelite deity, is moved to send a deliverer; on the events that followed see EXODUS, BOOK OF; MOSES. It has been thought that dynastic changes occasioned the change in Egyptian policy (e.g. the expulsion of the Hyksos), but if the Israelites built Rameses and Pithom (Ex. i. 11), cities which, as excavation has shown, belong to the time of Rameses II. (13th century B.C.), earlier dates are inadmissible. On these grounds the Exodus may have taken place under one of his successors, and since Mineptah or Merneptah (son of Rameses), in relating his successes in Palestine, boasts that *Ysiraal* is desolated, it would seem that the Israelites had already returned. On the other hand, it has been suggested that when Jacob and his family entered Egypt, some Israelite tribes had remained behind and that it is to these that Mineptah's inscription refers. The problem is complicated by the fact that, from the Egyptian evidence, not only was there at this time no remarkable emigration of oppressed Hebrews, but Bedouin tribes were then receiving permission to enter Egypt and to feed their flocks upon Egyptian soil. It might be assumed that the Israelites (or at least those who had not remained behind in Palestine) effected their departure at a somewhat later date, and in the time of Mineptah's successor, Seti II., there is an Egyptian report of the pursuit of some fugitive slaves over the eastern frontier. The value of all such evidence will naturally depend largely upon the estimate formed of the biblical narratives, but it is necessary to observe that these have not yet found Egyptian testimony to support them. Although the information which has been brought to bear upon Egyptian life and customs substantiates the general accuracy of the local colouring in some of the biblical narratives, the latter contain several inherent improbabilities, and whatever future research may yield, no definite trace of Egyptian influence has so far been found in Israelite institutions.

No allusions to Israelites in Egypt have yet been found on the monuments; against the view that the Aperiu (or Apury) of the inscriptions were Hebrews, see S. R. Driver in D. G. Hogarth, *Authority and Archaeology*, pp. 56 sqq.; H. W. Hogg, *Ency. Bib.* col. 1310. The plagues of Egypt have been shown to be those to which the land is naturally subject (R. Thomson, *Plagues of Egypt*), but the description of the relations of Moses and Aaron to the court raises many difficult questions (H. P. Smith, *O.T. Hist.* pp. 57-60). Those who reject Ex. i. 11 and hold that 480 years elapsed between the Exodus and the foundation of the temple (1 Kings vi. 1, see BIBLE: *Chronology*) place the former about the time of Tethmosis (Thothmes) III., and suppose that the hostile Habiri (Khabiri) who

troubled Palestine in the 15th century are no other than Hebrews (the equation is philologically sound), i.e. the invading Israelites.² But although the evidence of the Amarna tablets might thus support the biblical tradition in its barest outlines, the view in question, if correct, would necessitate the rejection of a great mass of the biblical narratives as a whole.

In the absence of external evidence the study of the Exodus of the Israelites must be based upon the Israelite records, and divergent or contradictory views must be carefully noticed. Regarded simply as a journey from Egypt into Palestine it is the most probable of occurrences: the difficulty arises from the actual narratives. The first stage is the escape from the land of Goshen (*q.v.*), the district allotted to the family of Jacob (Gen. xlvii. 28-34, xlviii. 1, 4, 6).³ As to the route taken across the Red Sea (*Yam Sūph*) scholars are not agreed (see W. M. Müller, *Ency. Bib.* col. 1436 sqq.); it depends upon the view held regarding the second stage of the journey, the road to the mountain of Sinai or Horeb and thence to Kadesh. The last-mentioned place is identified with Ain Kadis, about 50 m. south of Beersheba; but the identification of the mountain is uncertain, and it is possible that tradition confused two distinct places. According to one favourite view, the journey was taken across the Sinaitic peninsula to Midian, the home of Jethro. Others plead strongly for the traditional site Jebel Mūsā or Serbāl in the south of the peninsula (see J. R. Harris, *Dict. Bible*, iv. pp. 536 sqq.; H. Winckler, *Ency. Bib.* col. 4641). The latter view implies that the oppressed Israelites left Egypt for one of its dependencies, and both theories find only conjectural identifications in the various stations recorded in Num. xxxiii. But this list of forty names, corresponding to the years of wandering, is from a post-exilic source, and may be based merely upon a knowledge of caravan-routes; even if it be of older origin, it is of secondary value since it represents a tradition differing notably from that in the earlier narratives themselves, and these on inspection confirm Judg. xi. 16 seq., where the Israelites proceed immediately to Kadesh.

Ex. xvi.-xviii. presuppose a settled encampment and a law-giving, and thus belong to a stage after Sinai had been reached (Ex. xix. sqq.). They are closely related, as regards subject matter, &c., to the narratives in Num. x. 29-xi., xx. 1-13 (Sinai to Kadesh), and the initial step is the recognition that the latter is their original context (see G. F. Moore, *Ency. Bib.* col. 1443 [v.]). Further, internal peculiarities associating events now at Sinai-Horeb with those at Kadesh support the view that Kadesh was their true scene, and it is to be noticed that in Ex. xv. 22 seq. the Israelites already reach the wilderness of Shur and accomplish the three days' journey which had been their original aim (cf. Ex. iii. 18, v. 3, viii. 27). The wilderness of Shur (Gen. xvi. 7, xx. 1; 1 Sam. xv. 7, xxvii. 8) is the natural scene of conflicts with Amalekites (Ex. xvii. 8 sqq.); and its sanctuary of Kadesh or En Mishpat ("well of judgment," Gen. xiv. 7) was doubtless associated with traditions of the giving of statutes and ordinances. The détour to Sinai-Horeb appears to belong to a later stage of the tradition, and is connected with the introduction of laws and institutions of relatively later form. It is foreshadowed by the injunction to avoid the direct way into Palestine (see Ex. xiii. 17-19), since on reaching Kadesh the Israelites would be within reach of hostile tribes, and the conflicts which it was proposed to avoid actually ensued.⁴ The forty years of wandering in the wilderness is characteristic of the Deuteronomic and post-exilic narratives; in the earlier sources the fruitful oasis of Kadesh is the centre, and even after the tradition of a détour to Sinai-Horeb was developed, only a brief period is spent at the holy mountain.

From Kadesh spies were sent into Palestine, and when the people were dismayed at their tidings and incurred the wrath of Yahweh, the penalty of the forty years' delay was pronounced

² See, e.g., J. Orr, *Problem of the O.T.* pp. 422 sqq.; Ed. Meyer, *Die Israëlitern*, pp. 222 sqq. Some, too, find in the Amarna tablets the historical background for Joseph's high position at the Egyptian court (see Cheyne, *Ency. Bib.* art. "Joseph").

³ For the varying traditions regarding the number of the people and their residence (whether settled apart, cf., e.g., Gen. xlvii. 34, Ex. viii. 22, ix. 26, x. 23, or in the midst of the Egyptians) see the recent commentaries.

⁴ See further J. Wellhausen, *Prolegomena*, pp. 342 sqq.; G. F. Moore, *Ency. Bib.* col. 1443; S. A. Cook, *Jew. Quart. Rev.* (1906), pp. 741 sqq. (1907), p. 122, and art. MOSES. Ex. xiii. 17-19 forbids the compromise which would place Sinai-Horeb in the neighbourhood of Kadesh (A. E. Haynes, *Pal. Explor. Fund. Quart. Statem.* (1896), pp. 175 sqq.; C. F. Kent [see *Lit.* below], p. 381).

¹ There is a lacuna between the oldest traditions in Genesis and those in Exodus: the latter beginning simply "and there arose a new king over Egypt which knew not Joseph." The interval between Jacob's arrival in Egypt and the Exodus is given variously as 400 or 430 years (Gen. xv. 13, Ex. xii. 40 sqq., Acts vii. 6); but the Samaritan and Septuagint versions allow only 215 years (Ex. *loc. cit.*), and a period of only four generations is presupposed in Gen. xv. 16 (cf. the length of the genealogies between the contemporaries of Joseph and those of Moses in Ex. vi. 16-20).

(Num. xiii. seq.). Originally Caleb alone was exempt and for his faith received a blessing; later tradition adds Joshua and in Deut. i. 37 seq. alludes to some unknown offence of Moses. According to Num. xxi. 1-3 the Israelites (a generalizing amplification) captured Hormah, on the way to Beersheba, and subsequently the clan Caleb and the Kenites (the clan of Moses' father-in-law) are found in Judah (Judg. i. 16). Although the traditions regard their efforts as part of a common movement (from Gilgal, see below), it is more probable that these (notably Caleb) escaped the punishment which befell the rest of the Israelites, and made their way direct from Kadesh into the south of Palestine.¹ On the other hand, according to the prevailing tradition, the attempt to break northwards was frustrated by a defeat at Hormah (Num. xiv. 40-45), an endeavour to pass Edom failed, and the people turned back to the *Yam Sûph* (here at the head of the Gulf of Akabah) and proceeded up to the east of Edom and Moab. Conflicting views are represented (on which see MOAB), but at length Shittim was reached and preparations were made to cross the Jordan into the promised land. This having been effected, Gilgal became the base for a series of operations in which the united tribes took part. But again the representations disagree, and to the overwhelming campaigns depicted in the book of Joshua most critics prefer the account of the more gradual process as related in the opening chapter of the book of Judges (see *Jews: History*, § 8).

Thus, whatever evidence may be supplied by archaeological research, the problem of the Exodus must always be studied in the light of the biblical narratives. That the religious life of Israel as portrayed therein dates from this remote period cannot be maintained against the results of excavation or against the later history, nor can we picture a united people in the desert when subsequent vicissitudes represent the union as the work of many years, and show that it lasted for a short time only under David and Solomon. During the centuries in which the narratives were taking shape many profound changes occurred to affect the traditions. Developments associated with the Deuteronomic reform and the reorganization of Judaism in post-exilic days can be unmistakably recognized, and it would be unsafe to assume that other vicissitudes have not also left their mark. Allowance must be made for the shifting of boundaries or of spheres of influence (Egypt, Edom, Moab), for the incorporation of tribes and of their own tribal traditions, and in particular for other movements (e.g. from Arabia).² If certain clans moved direct from Kadesh into Judah, it is improbable that others made the lengthy détour from Kadesh by the Gulf of Akabah, but this may well be an attempt to fuse the traditions of two distinct migrations. Among the Joseph-tribes (Ephraim and Manasseh), the most important of Israelite divisions, the traditions of an ancestor who had lived and died in Egypt would be a cherished possession, but although most writers agree that not all the tribes were in Egypt, it is impossible to determine their number with any certainty. At certain periods, intercourse with Egypt was especially intimate, and there is much in favour of the view that the name Mizraim (Egypt) extended beyond the borders of Egypt proper. Reference has already been made to other cases of geographical vagueness, and one must recognize that in a body of traditions such as this there was room for the inclusion of the most diverse elements which it is almost hopeless to separate, in view of the scantiness of relevant evidence from other sources, and the literary intricacy of the extant narratives. That many different beliefs have influenced the tradition is apparent from what has been said above, and is especially noticeable from a study of the general features. Thus, although the Israelites possessed cattle (Ex. xvii. 3, xix. 13, xxiv. 5, xxxii. 6, xxxiv. 3; Num. xx. 19), allusion is made to their lack of meat in order to magnify the wonders of the journey, and among divinely sent aids to guide

¹ So B. Stade, Steuernagel, Guthe, G. F. Moore, H. P. Smith, C. F. Kent, &c. See CALEB; JERAHMEEL; JUDAH; KENITES; LEVITES; and JEWS: *History*, §§ 5, 20 (end).

² An instructive parallel to the last-mentioned is afforded by Dissard's account of the migration of Arab tribes into Palestine in the 18th century A.D. (*Revue biblique*, July 1905).

and direct the people upon the march not only does Moses require the assistance of a human helper (Jethro or Hobab), but the angel, the ark, the pillar of cloud and of fire and the mysterious hornet are also provided.

In addition to the references already given, see J. W. Colenso, *Pentateuch and Book of Joshua* (on internal difficulties); A. Jeremias, *Alle Test. im Lichte d. alt. Orient's* (pp. 402 sqq., on later references in Manetho, &c., with which cf. also R. H. Charles, *Jubilees*, p. 245 seq.); art. "Exodus" in *Ency. Bib.*; Ed. Meyer, *Israëlitien (passim)*; Böhnhoff, *Theolog. Stud. u. Krit.* (1907), pp. 159-217; the histories of Israel and commentaries on the book of Exodus. Among the numerous special works, mention may be made of G. Ebers, *Durch Gosen zum Sinai*; E. H. Palmer, *Desert of the Exodus*; O. A. Toffteen, *The Historic Exodus*; fuller information is given in L. B. Paton, *Hist. of Syria and Palestine*, p. 34 (also ch. viii.); and C. F. Kent, *Beginnings of Heb. Hist.* p. 355 seq. (S. A. C.)

EXOGAMY (Gr. ἔξω, outside; and γάμος, marriage), the term proposed by J. F. McLennan for the custom compelling marriage "out of the tribe" (or rather "out of the totem"); its converse is endogamy (*q.v.*). McLennan would find an explanation of exogamy in the prevalence of female infanticide, which, "rendering women scarce, led at once to polyandry within the tribe, and the capturing of women from without." Infanticide of girls is, and no doubt ever has been, a very common practice among savages, and for obvious reasons. Among tribes in a primitive stage of social organization girl-children must always have been a hindrance and a source of weakness. They had to be fed and yet they could not take part in the hunt for food, and they offered a temptation to neighbouring tribes. Infanticide, however, is not proved to have been so universal as McLennan suggests, and it is more probable that the reason of exogamy is really to be found in that primitive social system which made the "captured" woman the only wife in the modern sense of the term. In the beginnings of human society children were related only to their mother; and the women of a tribe were common property. Thus no man might appropriate any female or attempt to maintain proprietary rights over her. With women of other tribes it would be different, and a warrior who captured a woman would doubtless pass unchallenged in his claim to possess her absolutely. Infanticide, the evil physical effects of "in-and-in" breeding, the natural strength of the impulse to possess on the man's part, and the greater feeling of security and a tendency to family life and affections on the woman's, would combine to make exogamy increase and marriages within the tribe decrease. A natural impulse would in a few generations tend to become a law or a custom, the violation of which would be looked on with horror. Physical capture, too, as soon as increasing civilization and tribal intercommunication removed the necessity for violence, became symbolic of the more permanent and individual relations of the sexes. An additional explanation of the prevalence of exogamy may be found in the natural tendency of exogamous tribes to increase in numbers and strength at the expense of those communities which moved towards decadence by in-breeding. Thus tradition would harden into a prejudice, strong as a principle of religion, and exogamy would become the inviolable custom it is found to be among many races. In Australia, Sir G. Grey writes: "One of the most remarkable facts connected with the natives is that they are divided into certain great families, all the members of which bear the same name . . . these family names are common over a great portion of the continent and a man cannot marry a woman of his own family name." In eastern Africa, Sir R. Burton says: "The Somal will not marry one of the same, or even of a consanguineous family," and the Bakalahari have the same rule. Paul B. du Chaillu found exogamy the rule and blood marriages regarded as an abomination throughout western Equatorial Africa. In India the Khasias, Juangs, Waralis, Oraons, Hos and other tribes are strictly exogamous. The Kalmucks are divided into hordes, and no man may marry a woman of the same horde. Circassians and Samoyedes have similar rules. The Ostiaks regard endogamy (marriage within the clan) as a crime, as do the Yakuts of Siberia. Among the Indians of America severe rules prescribing exogamy prevail. The Tsimshéan Indians of British Columbia are divided into

tribes and totems, or "crests which are common to all the tribes," says one writer. "The crests are the whale, the porpoise, the eagle, the coon, the wolf and the frog. . . . The relationship existing between persons of the same crest is nearer than that between members of the same tribe. . . . Members of the same tribe may marry, but those of the same crest are not allowed to under any circumstances; that is, a whale may not marry a whale, but a whale may marry a frog, &c." The Thlinkets, the Mayas of Yucatan and the Indians of Guiana are exogamous, observing a custom which is thus seen to exist throughout Africa, in Siberia, China, India, Polynesia and the Americas.

AUTHORITIES.—J. F. McLennan, *Primitive Marriage* (1865), and *Studies in Anc. Hist.* (1896); Lord Avebury, *Origin of Civilization* (1902); Westermarck, *History of Human Marriage* (1894); A. Lang, *Social Origins* (1903); L. H. Morgan, *Ancient Society* (1877); J. G. Frazer, *Totemism and Exogamy* (1910); see also TOTEM.

EXORCISM (Gr. ἐξορκίζειν, to conjure out), the expulsion of evil spirits from persons or places by incantations, magical rites or other means. As a corollary of the animistic theory of diseases and of belief in Possession (*q.v.*), we find widely spread customs whose object is to get rid of the evil influences. These customs may take the form of a general expulsion of evils, either once a year or at irregular intervals; the evils, which are often regarded as spirits, sometimes as the souls of the dead, may be expelled, according to primitive philosophy, either immediately by spells, purifications or some form of coercion; or they may be put on the back of a scapegoat or other material vehicle. Among the means of compelling the evil spirits are assaults with warlike weapons or sticks, the noise of musical instruments or of the human voice, the use of masks, the invocation of more powerful good spirits, &c.; both fire and water are used to drive them out, and the use of iron is a common means of holding them at bay.

The term exorcism is applied more especially to the freeing of an individual from a possessing or disease-causing spirit; the means adopted are frequently the same as those mentioned above; in the East Indies the sufferer sometimes dances round a small ship, into which the spirit passes and is then set adrift. The patient may be beaten or means may be employed whose efficiency depends largely on their suggestive nature. Among the Dakota Indians the medicine-man chants *hi-le-li-lahl* at the bed of the sick man and accompanies his chant with the rattle; he then sucks at the affected part till the possessing spirit is supposed to come out and take its flight, when men fire guns at it from the door of the tent. The Zulus believe that they can get rid of the souls of the dead, which cause diseases, by sacrifices of cattle, or by expostulating with the spirits; so too the *shaman* or magician in other parts of the world offers the possessing spirit objects or animals.

The professional exorcist was known among the Jews; in Greece the art was practised by women, and it is recorded that the mothers of Epicurus and Aeschines belonged to this class; both were bitterly reproached, the one by the Stoics, the other by Demosthenes, with having taken part in the practices in question. The prominence of exorcism in the early ages of the Christian church appears from its frequent mention in the writings of the fathers, and by the 3rd century there was an order of exorcists (see EXORCIST). The ancient rite of exorcism in connexion with baptism is still retained in the Roman ritual, as is also a form of service for the exorcising of possessed persons. The exorcist signs the possessed person with the figure of the cross, desires him to kneel, and sprinkles him with holy water; after which the exorcist asks the devil his name, and abjures him by the holy mysteries of the Christian religion not to afflict the person possessed any more. Then, laying his right hand on the demoniac's head, he repeats the form of exorcism as follows: "I exorcise thee, unclean spirit, in the name of Jesus Christ; tremble, O Satan, thou enemy of the faith, thou foe of mankind, who hast brought death into the world, who hast deprived men of life, and hast rebelled against justice, thou seducer of mankind, thou root of evil, thou source of avarice, discord and envy." Houses and other places supposed to be haunted by unclean

spirits are likewise to be exorcised with similar rites, and in general exorcism has a place in all the ceremonies for consecrating and blessing persons or things (see BENEDICTION).

See Tylor, *Primitive Culture*; Skeat, *Malay Magic*, p. 427 seq.; Frazer, *Golden Bough*, vol. iii. 189; Krafft, *Ausführliche Historie von Exorcismus*; Koldeweg, *Der Exorcismus im Herzogthum Braunschweig*; Brecher, *Das Transcendentale, Magie, etc. im Talmud*, pp. 195-203; *Zeitschr. für Assyriologie* (Dec. 1893, April 1894); Herzog, *Realencykl.*, s.v. "Exorcismus"; Waldmeier, *Autobiography*, p. 64; L. W. King, *Babylonian Magic*; Maury, *La Magie*; R. C. Thompson, *Devils and Evil Spirits of Babylonia*.

EXORCIST (Lat. *exorcista*, Gr. ἐξορκιστής), in the Roman Catholic church, the third grade in the minor orders of the clergy, between those of acolyte and reader. The office, which involves the right of ceremonially exorcising devils (see EXORCISM), is actually no more than a preliminary stage of the priesthood. The earliest record of the special ordination of exorcists is the 7th canon of the council of Carthage (A.D. 256). "When they are ordained," it runs, "they receive from the hand of the bishop a little book in which the exorcisms are written, receiving power to lay hands on the *energumēni*, whether baptized or catechumens." Whatever its present position, the office of exorcist was, until comparatively recent times, by no means considered a sinecure. "The exorcist a terror to demons" (Paulinus, *Epist.* 24) survived the Reformation among Protestants, with the belief, expressed by Firmilianus in his epistle to St Cyprian, that "through the exorcists, by the voice of man and the power of God, the devil may be whipped, and burnt and tortured."

EXOTIC (Gr. ἐξωτικός, foreign, from ἔξω, outside), of foreign origin, or belonging to another country. The term is now used in the restricted sense of something not indigenous or native, and is mostly applied to plants introduced from foreign countries, which have not become acclimatized. Figuratively, "exotic" is used to convey the sense of something rare, delicate or extravagant.

EXPATRIATION (from Late Lat. *expatriare*, to exile, and *patria*, native land), a term used in a general sense for the banishment of a person from his own country. In international law expatriation is the renunciation or change of allegiance to one's native or adopted country. It may take place either by a voluntary act or by operation of law. Some countries, as France and England, disclaim their subjects if they become naturalized in another country, others, again, passively permit expatriation whether a new nationality has been acquired or not; others, as Germany, make expatriation the consequence of continued absence from their territory. (See ALIEN; ALLEGIANCE; NATURALIZATION.)

EXPERT (Lat. *expertus*, from *experiri*, to try), strictly, skilled, or one who has special knowledge; as used in law, an expert is a person, selected by a court, or adduced by a party to a cause, to give his opinion on some point in issue with which he is peculiarly conversant. In Roman law questions of disputed handwriting were referred to experts; and in France, whenever the court considers that a report by experts is necessary, it is ordered by a judgment clearly setting forth the objects of the *expertise* (Code Proc. Civ. art. 302). Three experts are then to be appointed, unless the parties agree upon one only (art. 303). The experts are required to take an oath (art. 305), but in practice this requirement is frequently dispensed with. They may be challenged on the same grounds as witnesses (art. 310). The necessary documentary and other evidence is laid before them (art. 317), and they make a single report to the court, even if they express different opinions: in that case the grounds only of the different opinions are to be stated, and not the personal opinion of each of the experts (art. 318). If the court is not satisfied with the report, new experts may be appointed (art. 322); the judges are not bound to adopt the opinion of the experts (art. 323). "This procedure in regard to experts is common to both the civil and commercial courts, but it is much more frequently resorted to in the commercial court than in the civil court, and the investigation is usually conducted by special experts officially attached to each of these courts" (Bodington, *French Law of Evidence*, London, 1904, p. 102).

A similar system is to be found in many other European countries; see e.g. Codes of Civil Procedure of Holland, arts. 222 et seq.; Belgium, arts. 302 et seq.; Italy, arts. 252 et seq.; as well as in those colonies where French law has been followed (Codes of Civil Procedure of Quebec, arts. 392 et seq.; St Lucia, arts. 286 et seq.). In Mauritius the articles of the French law, summarized above, are still nominally in force; but in practice each side calls its own expert evidence, as in England.

There is some evidence that in England the courts were in early times in the habit of summoning to their assistance, apparently as assessors, persons specially qualified to advise upon any scientific or technical question that required to be determined. Thus "in an appeal of maihem (*i.e.* wounding) . . . the court did not know how to adjudge because the wound was new, and then the defendant took issue and prayed the court that the maihem might be examined, on which a writ was sent to the sheriff to cause to come *medicos chirurgios de melioribus London, ad informandum dominum regem et curiam de his quae eis ex parte domini regis injungerentur* (Year Book, 21 Hen. VII. pl. 30, p. 33). The practice of calling in expert assistance in judicial inquiries was not confined to medico-legal cases. "If matters arise," said Justice Saunders in *Buckley v. Rice Thomas* (1554, Plowden, 124 a), "which concern other faculties, we commonly apply for the aid of that science or faculty which it concerns." English procedure, however, being *litigious*, and not, like continental European procedure, *inquisitorial*, in its character, the expert soon became, and still is, simply a witness to speak to matters of opinion.

There is a considerable body of law in England as to expert evidence. Only a few points can be touched upon here. (1) An expert is permitted to refresh his memory in regard to any fact by referring to anything written by himself or under his direction at the time when the fact occurred or at a time when it was fresh in his memory. This is also law generally in the United States (see e.g. New York Civil Code, s. 1843). In Scotland, medical and other scientific reports are lodged in process before the trial, and the witness reads them as part of his evidence and is liable to be examined or cross-examined on their contents. (2) In strictness, an expert will not be allowed, in cases of alleged insanity, to say that a litigating or incriminated party is insane or the reverse, and so to usurp the prerogative of the court or jury. But he may be asked whether certain facts or symptoms, *assuming them to be proved*, are or are not indicative of insanity. But in practice this rule is relaxed both in England and in Scotland, and (where it exists) to a still greater extent in America. (3) Foreign law can only be proved in English courts—and the same rule applies in Scotland—(a) by obtaining an opinion on the subject from a superior court of the country whose laws are in dispute under the Foreign Law Ascertainment Act 1861 or the British Law Ascertainment Act 1859, or (b) by the evidence of a lawyer of the country whose law is in question, or who has studied it *in that country*, or of an official whose position requires, and therefore presumes, a sufficient knowledge of that law. (4) The weight of authority both in England and in America supports the view that an expert is not bound to give evidence as to matters of opinion unless upon an undertaking by the party calling him to pay a reasonable remuneration for his evidence.

Statutory provision has been made in England for the summoning of expert assistance by the legal tribunals in various cases. In the county courts the judge may, if he thinks fit, on the application of either party, call in as assessor one or more persons of skill and experience as to the matters in dispute (County Courts Act 1888, s. 103), and special provision is made for calling in an assessor in employers' liability cases (act of 1880, s. 6) and admiralty matters (see County Courts Admiralty Jurisdiction Acts of 1868 and 1869). In the High Court and court of appeal one or more specially qualified assessors may be called in to assist in the hearing of any cause or matter except a criminal proceeding by the crown (Judicature Acts 1873, s. 56), and a like power is given to both these courts and the judicial committee of the privy council in patent cases (Patents, &c., Act

1883, s. 28). Maritime causes, whether original or on appeal from county courts, are usually taken in the presence of Elder Brethren of the Trinity House, who advise the judge without having any right to control or any responsibility for his decision (see the "Beryl," 1884, 9 P.D. 1), and on appeal in maritime causes nautical assessors are usually called in by the court of appeal, and may be called in by the House of Lords (Judicature Act 1891, s. 3); a like provision is made as to maritime causes in Scottish courts (Nautical Assessors [Scotland] Act 1894). The judicial committee of the privy council, besides its power to call in assessors in patent cases, is authorized to call them in in ecclesiastical causes (Appellate Jurisdiction Act 1876, s. 14).

In addition to the authorities cited in the text, see Taylor, *Law of Evidence* (9th ed., London, 1895); J. D. Lawson, *Law of Expert and Opinion Evidence* (1900).

EXPLOSIVES, a general term for substances which by certain treatment "explode," *i.e.* decompose or change in a violent manner so as to generate force. From the manner and degree of violence of the decomposition they are classified into "propellants" and "detonators," but this classification is not capable of sharp delimitation. In some cases the same substance may be employed for either purpose under altered external conditions; but there are some substances which could not possibly be employed as propellants, and others which can scarcely be induced to explode in the manner known as "detonation." A propellant may be considered as a substance that on explosion produces such a disturbance that neighbouring substances are thrown to some distance; a detonator or disruptor may produce an extremely violent disturbance within a limited area without projecting substances to any great distance. Time is an important, perhaps the most important, factor in this action. A propellant generally acts by *burning* in a more or less rapid and regular manner, producing from a comparatively small volume a large volume of gases; during this action heat is also developed, which, being expended mostly on the gaseous products, causes a further expansion. The noise accompanying an explosion is due to an air wave, and is markedly different in the case of a detonator from a real propellant. Some cases of ordinary combustion can be accelerated into explosions by increasing the area of contact between the combustible and the oxygen supplier, for instance, ordinary gas or dust explosions. Neither temperature nor quantity of heat energy necessarily gives an explosive action. Some metals, e.g. aluminium and magnesium, will, in oxidizing, produce a great thermal effect, but unless there be some gaseous products no real explosive action.

Explosives may be mechanical mixtures of substances capable of chemical interaction with the production of large volumes of gases, or definite chemical compounds of a peculiar class known as "endothermic," the decomposition of which is also attended with the evolution of gases in large quantity.

All chemical compounds are either "endothermic" or "exothermic." In endothermic compounds energy, in some form, has been taken up in the act of formation of the compound. Some of this energy has become potential, or rather the compound formed has been raised to a higher potential. This case occurs when two elements can be united only under some compulsion such as a very high temperature, by the aid of an electric current, or spark, or as a secondary product whilst some other reactions are proceeding. For example, oxygen and nitrogen combine only under the influence of an electric spark, and carbon and calcium in the electric furnace. The formation of chlorates by the action of chlorine on boiling potash is a good instance of a complex compound (potassium chlorate), being formed in small quantity as a secondary product whilst a large quantity of primary and simpler products (potassium chloride and water) is forming. In chlorate formation the greater part of the reaction represents a running down of energy and formation of exothermic compounds, with only a small yield of an endothermic substance. Another idea of the meaning of endothermic is obtained from acetylene. When 26 parts by weight of this substance are burnt, the heat produced will warm up 310,450 parts of water 1° C. Acetylene consists of 24 parts of carbon and 2 of hydrogen by weight. The 24 parts of carbon will, if in the form of pure charcoal, heat 192,000 parts of water 1°, and the 2 parts of hydrogen will heat 68,000 parts of water 1°, the total heat production being 260,000 heat units. Thus 26 grams of acetylene give an excess of 50,450 units over the amount given by the constituents. This excess of

heat energy¹ is due to some form of potential energy in the compound which becomes actual heat energy at the moment of dissolution of the chemical union. The manner in which a substance is endothermic is of importance as regards the practical employment of explosives. Some particular endothermic state or form results from the mode of formation and the consequent internal structure of the molecule. Physical structure alone can be the cause of a relative endothermic state, as in the glass bulbs known as Rupert's drops, &c., or even in chilled steel. Rupert's drops fly in pieces on being scratched or cut to a certain depth. The cause is undoubtedly to be ascribed to the molecular state of the glass brought about by chilling from the melted state. The molecules have not had time to separate or arrange themselves in easy positions. In steel when melted the carbide of iron is no doubt diffused equally throughout the liquid. When cooled slowly some carbide separates out more or less, and the steel is soft or annealed. When chilled the carbides are retained in solid solution. The volume of chilled glass or steel differs slightly from that in the annealed state.

Superfused substances are probably in a similar state of physical potential or strain. Many metallic salts, and organic compounds especially, will exhibit this state when completely melted and then allowed to cool in a clean atmosphere. On touching with a little of the same substance in a solid state the liquids will begin to crystallize, at the same time becoming heated almost up to their melting-points. The metal gallium shows this excellently well, keeping liquid for years until touched with the solid metal, when there is a considerable rise of temperature as solidification takes place.

All carbon compounds, excepting carbon dioxide, and many if not all compounds of nitrogen, are endothermic. Most of the explosives in common use contain nitrogen in some form.

Exothermic compounds are in a certain sense the reverse of endothermic; they are relatively inert and react but slowly or not at all, unless energy be expended upon them from outside. Water, carbon dioxide and most of the common minerals belong to this class.

The explosives actually employed at the present time include mixtures, such as gunpowders and some chlorate compositions, the ingredients of which separately may be non-explosive; compounds used singly, as guncotton, nitroglycerin (in the form of dynamite), picric acid (as lyddite or melinite), trinitrotoluene, nitroresols, mercury fulminate, &c.; combinations of some explosive compounds, such as cordite and the smokeless propellants in general use for military purposes; and, finally, blasting and detonating or igniting compositions, some of which contain inert diluting materials as well as one or more high explosives. Many igniting compositions are examples of the last type, consisting of a high explosive diluted with a neutral substance, and frequently containing in addition a composition which is inflamed by the explosion of the diluted high explosive, the flame in turn igniting the actual propellant.

Explosive Mixtures.—The explosive mixture longest known is undoubtedly gunpowder (*q.v.*) in some form—that is, a mixture of charcoal with sulphur and nitre, the last being the oxygen provider. Besides the nitrates of metals and ammonium nitrate, there is a limited number of other substances capable of serving in a sufficiently energetic manner as oxygen providers. A few chlorates, perchlorates, permanganates and chromates almost complete the list. Of these the sodium, potassium and barium chlorates are best known and have been actually tried, in admixture with some combustible substances, as practical explosives. Most other metallic chlorates are barred from practical employment owing to instability, deliquescence or other property.

Of the chlorates those of potassium and sodium are the most stable, and mixtures of either of these salts with sulphur or sulphides, phosphorus, charcoal, sugar, starch, finely-ground cellulose, coal or almost any kind of organic, *i.e.* carbon, compound, in certain proportions, yield an explosive mixture. In many cases these mixtures are not only fired or exploded by heating to a certain temperature, but also by quite moderate friction or percussion. Consequently there is much danger in manufacture and storage, and however these mixtures have been made up, they are quite out of the question as propellants on account of their great tendency to explode in the manner of a detonator. In addition they are not smokeless, and leave a

¹ Not necessarily heat energy entirely. A number of substances—acetylides and some nitrogen compounds, such as nitrogen chloride—decompose with extreme violence, but little heat is produced.

considerable residue which in a gun would produce serious fouling.

Mixtures of chlorates with aromatic compounds such as the nitro- or dinitro-benzenes or even naphthalene make very powerful blasting agents. The violent action of a chlorate mixture is due first to the rapid evolution of oxygen, and also to the fact that a chlorate can be detonated when alone. A drop of sulphuric acid will start the combustion of a chlorate mixture. In admixture with sulphur, sulphides and especially phosphorus, chlorates give extremely sensitive compositions, some of which form the basis of friction tube and firing mixtures.

Potassium and sodium perchlorates and permanganates make similar but slightly less sensitive explosive mixtures with the above-mentioned substances. Finely divided metals such as aluminium or magnesium give also with permanganates, chlorates or perchlorates sensitive and powerful explosives. Bichromates, although containing much available oxygen, form but feeble explosive mixtures, but some compounds of chromic acid with diazo compounds and some acetylides are extremely powerful as well as sensitive. Ammonium bichromate is a self-combustible after the type of ammonium nitrate, but scarcely an explosive.

Explosive Compounds.—Nearly all the explosive compounds in actual use either for blasting purposes or as propellants are nitrogen compounds, and are obtained more or less directly from nitric acid. Most of the propellants at present employed consist essentially of nitrates of some organic compound, and may be viewed theoretically as nitric acid, the hydrogen of which has been replaced by a carbon complex; such compounds are expressed by $M \cdot O \cdot NO_2$, which indicates that the carbon group is in some manner united by means of oxygen to the nitrogen group. Guncotton and nitroglycerin are of this class. Another large class of explosives is formed by a more direct attachment of nitrogen to the carbon complex, as represented by $M \cdot NO_2$. A number of explosives of the detonating type are of this class. They contain the same proportions of oxygen and nitrogen as nitrites, but are not nitrites. They have been termed nitro-derivatives for distinction. One of the simplest and longest-known members of this group is nitrobenzene, $C_6H_5NO_2$, which is employed to some extent as an explosive, being one ingredient in rack-a-rock and other blasting compositions. The dinitro-benzenes, $C_6H_4(NO_2)_2$, made from it are solids which are somewhat extensively employed as constituents of some sporting powders, and in admixture with ammonium nitrate form a blasting powder of a "flameless" variety which is comparatively safe in dusty or "gassy" coal seams.

Picric acid or trinitrophenol, $C_6H_2 \cdot OH \cdot (NO_2)_3$ is employed as a high explosive for shell, &c. It requires, however, either to be enclosed and heated, or to be started by a powerful detonator to develop its full effect. Its compounds with metals, such as the potassium salt, $C_6H_2 \cdot OK \cdot (NO_2)_3$, are when dry very easily detonated by friction or percussion and *always* on heating, whereas picric acid itself will burn very quietly when set fire to under ordinary conditions. Trinitrotoluene, $C_6H_2 \cdot CH_3 \cdot (NO_2)_3$, is a high explosive resembling picric acid in the manner of its explosion (to which in fact it is a rival), but differs therefrom in not forming salts with metals. The nitronaphthols, $C_{10}H_6 \cdot OH \cdot NO_2$, and higher nitration products may be counted in the list. Their salts with metals behave much like the picrates.

All these nitro compounds can be reduced by the action of nascent hydrogen to substances called amines (*q.v.*), which are not always explosive in themselves, but in some cases can form nitrates of a self-combustible nature. Aminoacetic acid, for instance, will form a nitrate which burns rapidly but quietly, and might be employed as an explosive. By the action of nitrous acid at low temperatures on aromatic amines, *e.g.* aniline, $C_6H_5NH_2$, diazo compounds are produced. These are all highly explosive, and when in a dry state are for the most part also extremely sensitive to friction, percussion or heat. As many of these diazo compounds contain no oxygen their explosive nature must be ascribed to the peculiar state of union of the nitrogen. This state is attempted to be shown by the formulae such as, for

instance, $C_6H_5 \cdot N:N \cdot X$, which may be some compound of diazobenzene. Probably the most vigorous high explosive at present known is the substance called hydrazoic acid or azoimide (*q.v.*). It forms salts with metals such as AgN_3 , which explode in a peculiar manner. The ammonium compound, NH_4N_3 , may become a practical explosive of great value.

Mercuric fulminate, $HgC_2N_2O_2$, is one of the most useful high explosives known. It is formed by the action of a solution of mercurous nitrate, containing some nitrous acid, on alcohol. It is a white crystalline substance almost insoluble in cold water and requiring 130 times its weight of boiling water for solution. It may be heated to $180^\circ C.$ before exploding, and the explosion so brought about is much milder than that produced by percussion. It forms the principal ingredient in cap compositions, in many fuses and in detonators. In many of these compositions the fulminate is diluted by mixture with certain quantities of inert powders so that its sensitiveness to friction or percussion is just so much lowered, or slowed down, that it will fire another mixture capable of burning with a hot flame. For detonating dynamite, guncotton, &c., it is generally employed without admixture of a diluent.

Smokeless Propellants.—Gunpowders and all other explosive mixtures or compounds containing metallic salts must form smoke on combustion. The solids produced by the resolution of the compounds are in an extremely finely-divided state, and on being ejected into the atmosphere become more or less attached to water vapour, which is so precipitated, and consequently adds to the smoke. The simplest examples of propellants of the smokeless class are compressed gases. Compressed air was the propellant for the Zaluski dynamite gun. Liquefied carbon dioxide has also been proposed and used to a slight extent with the same idea. It is scarcely practical, however, because when a quantity of a gas liquefied by pressure passes back again into the gaseous state, there is a great absorption of heat, and any remaining liquid, and the containing vessel, are considerably cooled. Steam guns were tried in the American Civil War in 1864; but a steam gun is not smokeless, for the steam escaping from the long tube or gun immediately condenses on expansion, forming white mist or smoke.

At the earliest stage of the development of guncotton the advantage of its smokeless combustion was fully appreciated (see GUNCOTTON). That it did not at once take its position as the smokeless propellant, was simply due to its physical state—a fibrous porous mass—which burnt too quickly or even detonated under the pressure required in fire-arms of any kind. In the early eighties of the 19th century it was found that several substances would partly dissolve or at least gelatinize guncotton, and the moment when guncotton proper was obtained as a colloid or jelly was the real start in the matter of smokeless propellants.

Guncotton is converted into a gelatinous form by several substances, such as esters, *e.g.* ethyl acetate or benzoate, acetone and other ketones, and many benzene compounds, most of which are volatile liquids. On contact with the guncotton a jelly is formed which stiffens as the evaporation of the gelatinizing agent proceeds, and finally hardens when the evaporation is complete. Whilst in a stiff pasty state it may be cut, moulded or pressed into any desired shape without any danger of ignition. In fact guncotton in the colloid state may be hammered on an anvil, and, as a rule, only the portion struck will detonate or fire. Guncotton alone makes a very hard and somewhat brittle mass after treatment with the gelatinizing agent and complete drying, and small quantities of camphor, vaseline, castor oil and other substances are incorporated with the gelatinous guncotton to moderate this hard and brittle state.

All the smokeless powders, of which gelatinized guncottons or nitrated celluloses are the base, are moulded into some conveniently shaped grain, *e.g.* tubes, cords, rods, disks or tablets, so that the rate of burning may be controlled as desired. The Vieille powder, invented in 1887 and adopted in France for a magazine rifle, consisted of gelatinized guncotton with a little picric acid. Later a mixture of two varieties of guncotton

gelatinized together was used. In addition to guncottons other explosive or non-explosive substances are contained in some of these powders. Guncotton alone in the colloid state burns very slowly if in moderate-sized pieces, and when subdivided or made into thin rods or strips it is still very mild as an explosive, partly from a chemical reason, *viz.* there is not sufficient oxygen in it to burn the carbon to dioxide. Many mixtures are consequently in use, and many more have been proposed, which contain some metallic salt capable of supplying oxygen, such as barium or ammonium nitrate, &c., the idea being to accelerate the rate of burning of the guncotton and if possible avoid the production of smoke.

The discovery by A. Nobel that nitroglycerin could be incorporated with collodion cotton to form blasting gelatin (see DYNAMITE) led more or less directly to the invention of ballistite, which differs from blasting gelatin only in the relative amounts of collodion, or soluble nitrated cotton, and nitroglycerin. Ballistite was adopted by the Italian government in 1890 as a military powder. Very many substances and mixtures have been proposed for smokeless powder, but the two substances, guncotton and nitroglycerin, have for the most part kept the field against all other combinations, and for several reasons. Nitroglycerin contains a slight excess of oxygen over that necessary to convert the whole of the carbon into carbon dioxide; it burns in a more energetic manner than guncotton; the two can be incorporated together in any proportion whilst the guncotton is in the gelatinous state; also all the liquids which gelatinize guncotton dissolve nitroglycerin, and, as these gelatinizing liquids evaporate, the nitroglycerin is left entangled in the guncotton jelly, and then shares more or less its colloidal character. In burning the nitroglycerin is protected from detonation by the gelatinous state of the guncotton, but still adds to the rate of burning and produces a higher temperature.

Desirable Qualities.—Smokelessness is one only of the desirable properties of a propellant. All the present so-called smokeless powders produce a little fume or haze, mainly due to the condensation of the steam which forms one of the combustion products. There is often also a little vapour from the substances, such as oils, mineral jelly, vaseline or other hydrocarbon added for lubrication or to render the finished material pliable, &c. The gases produced should neither be very poisonous nor exert a corrosive action on metals, &c. The powder itself should have good keeping qualities, that is, not be liable to chemical changes within ordinary ranges of temperature or in different climates when stored for a few years. In these powders slight chemical changes are generally followed by noticeable ballistic changes. All the smokeless powders of the present day produce some oxide of nitrogen, traces of which hang about the gun after firing and change rapidly into nitrous and nitric acids. Nitrous acid is particularly objectionable in connexion with metals, as it acts as a carrier of oxygen. The fouling from modern smokeless powders is a slight deposit of acid grease, and the remedy consists in washing out the bore of the piece with an alkaline liquid. The castor oil, mineral jelly or camphor, and similar substances added to smokeless powders are supposed to act as lubricants to some extent. They are not as effective in this respect as mineral salts, and the rifling of both small-arms and ordnance using smokeless powders is severely gripped by the metal of the projectile. The alkaline fouling produced by the black and brown powders acted as a preventive of rusting to some extent, as well as a lubricant in the bore.

Danger in Manufacture.—In the case of the old gunpowders, the most dangerous manufacturing operation was incorporation. With the modern colloid propellants the most dangerous operations are the chemical processes in the preparation of nitroglycerin, the drying of guncotton, &c. After once the gelatinizing solvent has been added, all the mechanical operations can be conducted, practically, with perfect safety. This statement appears to be correct for all kinds of nitrated cellulose powders, whether mixed with nitroglycerin or other substances. Should they become ignited, which is possible by a rise of temperature (to say 180°) or contact with a flame, the mixture burns quickly, but does not detonate.

As a rule naval and military smokeless powders are shaped into flakes, cubes, cords or cylinders, with or without longitudinal perforations. All the modifications in shape and size are intended to regulate the rate of burning. Sporting powders are often coloured for trade distinction. Some powders are blacklead by glazing with pure graphite, as is done with black powders. One object of this glazing is to prevent the grains or pieces becoming joined by pressure; for rods or pieces of some smokeless powders might possibly unite under considerable pressure, producing larger pieces and thus altering the rate of burning. Most smokeless powders are fairly

insensitive to shock. All these gelatinized powders are a little less easily ignited than black powders. A slightly different cap composition is required for small-arm cartridges, and cannon cartridges generally require a small primer or starter of powdered black gunpowder.

It is desired that a propellant shall produce the maximum velocity with the minimum pressure. The pressure should start gently so that the inertia of the projectile is overcome without any undue local strain on the breech near the powder chamber, and more especially that as more and more space is given to the gases by the movement of the projectile up the gun to the muzzle, gas should be produced with sufficient rapidity to keep the pressure nearly uniform or slightly increasing along the bore. The leading idea for improvements in relation to propellants is to obtain the greatest possible pressure regularly developed, and at the same time the lowest temperatures. (W. R. E. H.)

Law.—In 1860 an act was passed in England "to amend the law concerning the making, keeping and carriage of gunpowder and compositions of an explosive nature, and concerning the manufacture and use of fireworks" (23 & 24 Vict. c. 139), whereby previous acts on the same subject were repealed, and minute and stringent regulations introduced. Amending acts were passed in 1861 and 1862. In 1875 was passed the Explosives Act (38 & 39 Vict. c. 17), which repealed the former acts, and dealt with the whole subject in a more comprehensive manner. This act, containing 122 sections, and applying to Scotland and Ireland, as well as to England, constitutes, with various orders in council and home office orders, a complete code. The act of 1875 was based on the report of a committee of the House of Commons, public opinion having been greatly excited on the subject by a terrible explosion on the Regent's Canal in 1874. Explosives are thus defined: (1) Gunpowder, nitro-glycerin, dynamite, gun-cotton, blasting powders, fulminate of mercury or of other metals, coloured fires, and every other substance, whether similar to those above-mentioned or not, used or manufactured with a view to produce a practical effect by explosion or a pyrotechnic effect, and including (2) fog-signals, fireworks, fuses, rockets, percussion caps, detonators, cartridges, ammunition of all descriptions, and every adaptation or preparation of an explosive as above defined. Part i. deals with gunpowder, providing that it shall be manufactured only at factories lawfully existing or licensed under the act; that it shall be kept (except for private use) only in existing or new magazines or stores, or in registered premises, licensed under the act. Private persons may keep gunpowder for their own use to the amount of thirty pounds. The act also prescribes rules for the proper keeping of gunpowder on registered premises. Part ii. deals with nitro-glycerin and other explosives; part iii. with inspection, accidents, search, &c.; part iv. contains various supplementary provisions. By order in council the term "explosive" may be extended to any substance which appears to be specially dangerous to life or property by reason of its explosive properties, or to any process liable to explosion in the manufacture thereof, and the provisions of the act then extend to such substance just as if it were included in the term "explosive" in the act. The act lays down minute and stringent regulations for the sale of gunpowder, restricting the sale thereof in public thoroughfares or places, or to any child apparently under the age of thirteen; requiring the sale of gunpowder to be in closed packages labelled; it also lays down general rules for conveyance, &c. The act also gives power by order in council to define, from time to time, the composition, quality and character of any explosive, and to classify explosives, and such orders in council are frequently made including new substances; those in force will be found in the *Statutory Rules and Orders*, tit. "explosive substance." The Merchant Shipping Act 1804 imposes restrictions on the carriage of dangerous goods in a British or foreign vessel, "dangerous goods" meaning aquafortis, vitriol, naphtha, benzine, gunpowder, lucifer matches, nitro-glycerin, petroleum and any explosive within the meaning of the Explosives Act 1875. The act is administered by the home office, and an annual report is published containing the proceedings of the inspectors of explosives and an account of the working of the act. Each annual report gives a list of explosives at the time authorized for manufacture

or importation, and appendices containing information as to accidents, experiments, &c.

Practically every European country has legislated on the lines of the English act of 1875, Austria taking the lead, in 1877, with an explosives ordinance almost identical with the English act. The United States and the various English colonies also have explosives acts regulating the manufacture, storage and importation of explosives. (See also PETROLEUM.) (T. A. I.)

BIBLIOGRAPHY.—M. Berthelot, *Sur la force des matières explosives* (Paris, 1883); P. F. Chalon, *Les Explosifs modernes* (Paris, 1886); W. H. Wardell, *Handbook of Gunpowder and Gun-cotton* (London, 1888); J. P. Cundill, *A Dictionary of Explosives* (London, 1889 and 1897); M. Eissler, *A Handbook of Modern Explosives* (London, 1896, new ed. 1903); J. A. Longridge, *Smokeless Powder and its Influence on Gun Construction* (London, 1890); C. Napier Hake and W. Macnab, *Explosives and their Power* (London, 1892); G. Coralys, *Les Explosifs* (Paris, 1893); A. Pontaux, *La Poudre sans fumée et les poudres anciennes* (Paris, 1893); F. Salvati, *Vocabolario di polveri ed esplosivi* (Rome, 1893); C. Guttman, *The Manufacture of Explosives* (London, 1895 and later); S. J. von Romocki, *Geschichte der Sprengstoffchemie, der Sprengtechnik und des Torpedowesens bis zum Beginn der neusten Zeit* (Berlin, 1895); *Geschichte der Explosivstoffe, die rauchschwachen Pulver* (Berlin, 1896); P. G. Sanford, *Nitro-explosives* (London, 1896); L. Gody, *Traité théorique et pratique des matières explosives* (Namur, 1896); R. Wille, *Der Plastomerie* (Berlin, 1898); E. Sarrau, *Introduction à la théorie des explosifs* (1893); *Théorie des explosifs* (1896); O. Guttman, *Manufacture of Explosives* (London, 1895); E. M. Weaver, *Notes on Military Explosives* (New York, 1906); M. Eissler, *The Modern High Explosives* (New York, 1906); *Treatise on Service Explosives*, published by order of the secretary of state for war (London, 1907). Most of the literature on modern explosives, e.g. dynamite, &c., is to be found in papers contributed to scientific journals and societies. An index to those which have appeared in the *Journal of the Society of Chemical Industry* is to be found in the decennial index (1908) compiled by F. W. Renant.

EXPRESS (through the French from the past participle of the Lat. *exprimere*, to press out, by transference used of representing objects in painting or sculpture, or of thoughts, &c. in words), a word signifying that which is clearly and definitely set forth or represented, explicit, and thus used of a meaning, a law, a contract and the like, being specially contrasted with "implied." Thus in law, malice, for which there is actual evidence, as apart from that which may be inferred from the acts of the person charged, is known as "express." The word is most frequently used with the idea of something done with a definite purpose; the term "express train," now meaning one that travels at a high speed over long distances with few intermediate stoppages, was, in the early days of railways, applied to what is now usually called a "special," i.e. a train not running according to the ordinary time-tables of the railway company, but for some specific purpose, or engaged by a private person. About 1845 this term became used for a train running to a particular place without stopping. Similarly in the British postal service, express delivery is a special and immediate delivery of a letter, parcel, &c., by an express messenger at a particular increased rate. The system was adopted in 1891.

In the United States of America, express companies for the rapid transmission of parcels and luggage and light goods generally perform the function of the post office or the railways in the United Kingdom and the continent of Europe. Not only do they deliver goods, but by the cash on delivery system (see CASH) the express companies act as agents both for the purchaser and seller of goods. They also serve as a most efficient agency for the transmission of money, the express money order being much more easily convertible than the postal money orders, as the latter can only be redeemed at offices in large and important towns. The system dates back to 1839, when one William Frederick Harnden (1813-1845), a conductor on the Boston and Worcester railway, undertook on his own account the carrying of small parcels and the performance of small commissions. Obligated to leave the company's service or abandon his enterprise, he started an "express" service between Boston and New York, carrying parcels, executing commissions and collecting drafts and bills. Alvin Adams followed in 1840, also between Boston and New York. From 1840 to 1845 the system was adopted by many others between the more important towns

throughout the States. The attempt to carry letters also was stopped by the government as interfering with the post office. In 1854 began the amalgamation of many of the companies. Thus under the name of the Adams Express Company the services started by Harnden and Adams were consolidated. The lines connecting the west and east by Albany, Buffalo and the lakes were consolidated in the American Express Company, under the direction of William G. Fargo (*q.v.*), Henry Wells and Johnston Livingston, while another company, Wells, Fargo & Co., operated on the Pacific coast. The celebrated "Pony Express" was started in 1860 between San Francisco and St. Joseph, Missouri, the time scheduled being eight days. The service was carried on by relays of horses, with stations 25 m. apart. The charge made for the service was \$2.50 per $\frac{1}{2}$ oz. The completion of the Pacific Telegraph Company line in 1861 was followed by the discontinuance of the regular service.

The name "express" is applied to a rifle having high velocity, flat trajectory and long fixed-sight ranges; and an "express-bullet" is a light bullet with a heavy charge of powder used in such a rifle (see RIFLE).

EXPROPRIATION, the taking away or depriving of property (Late Lat. *expropriare*, to take away, *proprium*, *i.e.* that which is one's own). The term is particularly applied to the compulsory acquisition of private property by the state or other public authority.

EXPULSION (Lat. *expulsio*, from *expellere*), the act of driving out, or of removing a person from the membership of a body or the holding of an office, or of depriving him of the right of attending a meeting, &c. In the United Kingdom the House of Commons can by resolution expel a member. Such resolution cannot be questioned by any court of law. But expulsion is only resorted to in cases where members are guilty of offences rendering them unfit for a seat in the House, such as being in open rebellion, being guilty of forgery, perjury, fraud or breach of trust, misappropriation of public money, corruption, conduct unbecoming the character of an officer and a gentleman, &c. It is customary to order the member, if absent, to attend in his place, before an order is made for his expulsion (see May, *Parliamentary Practice*, 1906, p. 56 seq.). Municipal corporations or other local government bodies have no express power to expel a member, except in such cases where the law declares the member to have vacated his seat, or where power is given by statute to declare the member's seat vacant. In the cases of officers and servants of the crown, tenure varies with the nature of the office. Some officials hold their offices *ad vitam aut culpam* or *dum bene se gesserunt*, others can be dismissed at any time and without reason assigned and without compensation. In the case of membership of a voluntary association (club, &c.) the right of expulsion depends upon the rules, and must be exercised in good faith. Courts of justice have jurisdiction to prevent the improper expulsion of the member of a voluntary association where that member has a right of property in the association. In the case of meetings, where the meeting is one of a public body, any person not a member of the body is entitled to be present only on sufferance, and may be expelled on a resolution of the body. In the case of ordinary public meetings those who convene the meeting stand in the position of licensors to those attending and may revoke the licence and expel any person who creates disorder or makes himself otherwise objectionable.

Expulsion of Aliens.—Under the Naturalization Act of 1870, the last of the civil disqualifications affecting aliens in England was removed. The political disqualifications which remained only applied to electoral rights. In the very exceptional cases in which it was retained in the statute book, expulsion was considered to have fallen into desuetude, but it has been revived by the Aliens Act of 1905 (5 Edw. VII. c. 13). Under this act powers are given to the secretary of state to make an order requiring an alien to leave the United Kingdom within a time fixed by the order and thereafter to remain outside the United Kingdom, subject to certain conditions, provided it is certified

to him that the alien has been convicted of any felony or misdemeanour or other offence for which the court has power to impose imprisonment without the option of a fine, &c., or that he has been sentenced in a foreign country with which there is an extradition treaty, for a crime not being an offence of a political character. There are also provisions applicable within one year after the alien has entered the United Kingdom in the case of pauper aliens. Precautions are taken to prevent, as far as possible, any abuse of the power of expulsion. Under the French law of expulsion (December 3, 1849) there are no such precautions, the minister of the interior having an absolute discretion to order any foreigner as a measure of public policy to leave French territory and in fact to have him taken immediately to the frontier.

EXTENSION (Lat. *ex*, out; *tendere*, to stretch), in general, the action of straining or stretching out. It is usually employed metaphorically (cf. the phrase an "extension of time," a period allowed in excess of what has been agreed upon). It is used as a technical term in logic to describe the total number of objects to which a given term may be applied; thus the meaning of the term "King" in "extension" means the kings of England, Italy, Spain, &c. (cf. DENOTATION), while in "intension" it means the attributes which taken together make up the idea of kingship (see CONNOTATION). In psychology the literal sense of extension is retained, *i.e.* "spread-outness." The perception of space by the senses of sight and touch, as opposed to semi-spatial perceptions by smell and hearing, is that of "continuous expanse composed of positions separated and connected by distances" (Stout); to this the term "extension" is applied. The perception of separate objects involves position and distance, but these taken together are not extension, which necessarily implies continuity. To move one's finger along the keys of a piano gives both the position and the distance of the keys; to move it along the frame gives the idea of extension. By expanding this idea we obtain the conception of all space as an extended whole. To this perception are necessary both form and material. It should be observed the actual quality of a stimulus (rough, smooth, dry, &c.) has nothing to do with the spatial perception as such, which is concerned purely with what is known as "local signature." The elementary undifferentiated sensation excited by the stimuli exerted by a continuous whole is known as its "extensive quantity" or "extensity." The term has to do not with the kind of object which excites the sensation, but simply with the vague massiveness of the latter. As such it is distinguishable in thought from extension, though it is not easy to say whether and if so how far the quantitative aspect of space can exist apart from spatial order. Extensity as an element in the complex of extension must be carefully distinguished from intensity. Mere increase of pressure implies increase of intensity of sensation; to increase the extensity the *area*, so to speak, of the exciting stimulus must be increased. Thus the extensity (also called "voluminousness," or "massiveness") of the sensation produced by a roll of thunder is greater than that produced by a whistle or the bark of a dog. It should be observed that this application of the idea of extensity to sensation in general, rather than to the matter which is the exciting stimulus, is only an analogy, an attempt to explain a common psychic phenomenon by terminology which is intrinsically suitable to the physical. As a natural consequence the term represents different shades of meaning in different treatises, verging sometimes towards the physical, sometimes towards the psychic, meaning.

In connexion with extension elaborate psycho-physical experiments have been devised, *e.g.* with the object of comparing the accuracy of tactual and visual perception and discovering what are the least differences which each can observe. At a distance two lights appear as one, just as two stars distinguishable through a telescope are one to the naked eye (see VISION): again if the points of a compass are brought close together and pressed lightly on the skin the sensation, though vague and diffused, is a single one.

See PSYCHOLOGY and works there quoted; also SPACE AND TIME.

EXTENUATING CIRCUMSTANCES. This expression is used in law with reference to crimes, to describe cases in which, though an offence has been committed without legal justification or excuse, its gravity, from the point of view of punishment or moral opprobrium, is mitigated or reduced by reason of the facts leading up to or attending the commission of the offence. According to English procedure, the jury has no power to determine the punishment to be awarded for an offence. The sentence, with certain exceptions in capital cases, is within the sole discretion of the judge, subject to the statutory prescriptions as to the kind and maximum of punishment. It is common practice for juries to add to their verdict, guilty or not guilty, a rider recommending the accused to mercy on the ground of grave provocation received, or other circumstances which in their view should mitigate the penalty. This form of rider is often added on a verdict of guilty of wilful murder, a crime as to which the judge has no discretion as to punishment, but the recommendation is sent to the Home Office for consideration in advising as to exercise of the prerogative of mercy. Quite independently of any recommendation by the jury, the judge is entitled to take into account matters proved during the trial, or laid before him after verdict, as a guide to him in determining the quantum of punishment.

Under the French law (*Code d'instruction criminelle*, art. 345), it is the sole right and the duty of a jury in a criminal case to pronounce whether or not the commission of the offence was attended by extenuating circumstances (*circonstances atténuantes*). They are not bound to say anything about the matter; but the whole or the majority may qualify the verdict by finding extenuation, and if they do, the powers of the court to impose the maximum punishment are taken away and the sentence to be pronounced is reduced in accordance with the scale laid down in art. 463 of the *Code pénal*. The most important result of this rule is to enable a jury to prevent the infliction of capital punishment for murder. In cases of what is termed "crime passionnel," French juries, when they do not acquit, almost invariably find extenuation; and a like verdict has become common even in the case of cold-blooded and sordid murders, owing to objections to capital punishment.

EXTERRITORIALITY, a term of international law, used to denominate certain immunities from the application of the rule that every person is subject for all acts done within the boundaries of a state to its local laws. It is also employed to describe the quasi-extraterritorial position, to borrow the phrase of Grotius, of the dwelling-place of an accredited diplomatic agent, and of the public ships of one state while in the waters of another. Latterly its sense has been extended to all cases in which states refrain from enforcing their laws within their territorial jurisdiction. The cases recognized by the law of nations relate to: (1) the persons and belongings of foreign sovereigns, whether incognito or not; (2) the persons and belongings of ambassadors, ministers plenipotentiary, and other accredited diplomatic agents and their suites (but not consuls, except in some non-Christian countries, in which they sometimes have a diplomatic character); (3) public ships in foreign waters. Exterritoriality has also been granted by treaty to the subjects and citizens of contracting Christian states resident within the territory of certain non-Christian states. Lastly, it is held that when armies or regiments are allowed by a foreign state to cross its territory, they necessarily have extraterritorial rights. "The ground upon which the immunity of sovereign rulers from process in our courts," said Mr Justice Wills in the case of *Mighell v. Sultan of Johore*, 1894, "is recognized by our law, is that it would be absolutely inconsistent with the status of an independent sovereign that he should be subject to the process of a foreign tribunal," unless he deliberately submits to its jurisdiction. It has, however, been held where the foreign sovereign was also a British subject (*Duke of Brunswick v. King of Hanover*, 1844), that he is amenable to the jurisdiction of the English Courts in respect of transactions done by him in his capacity as a subject. A "foreign sovereign" may be taken to include the president of a republic, and even a potentate whose inde-

pendence is not complete. Thus in the case, cited above, of *Mighell v. Sultan of Johore*, the sultan was ascertained to have abandoned all right to contract with foreign states, and to have placed his territory under British protection. The court held that he was, nevertheless, a foreign sovereign in so far as immunity from British jurisdiction was concerned. The immunity of a foreign diplomatic agent, as the direct representative of a foreign sovereign (or state), is based on the same grounds as that of the sovereign authority itself. The international practice in the case of Great Britain was confirmed by an act of parliament of the reign of Queen Anne, which is still in force. The preamble to this act states that "turbulent and disorderly persons in a most outrageous manner had insulted the person of the then ambassador of his Czarish Majesty, emperor of Great Russia," by arresting and detaining him in custody for several hours, "in contempt to the protection granted by Her Majesty, contrary to the law of nations, and in prejudice of the rights and privileges which ambassadors and other public ministers, authorized and received as such, have at all times been thereby possessed of, and ought to be kept sacred and inviolable." This preamble has been repeatedly held by our courts to be declaratory of the English common law. The act provides that all suits, writs, processes, against any accredited ambassador or public minister or his domestic servant, and all proceedings and judgments had thereupon, are "utterly null and void," and that any person violating these provisions shall be punished for a breach of the public peace. Thus a foreign diplomatic agent cannot, like the sovereign he represents, waive his immunity by submitting to the British jurisdiction. The diplomatic immunity necessarily covers the residence of the diplomatic agent, which some writers describe as assimilated to territory of the state represented by the agent; but there is no consideration which can justify any extension of the immunity beyond the needs of the diplomatic mission resident within it. It is different with public ships in foreign waters. In their case the extraterritoriality attaches to the vessel. Beyond its bulwarks captain and crew are subject to the ordinary jurisdiction of the state upon whose territory they happen to be. By a foreign public ship is now understood any ship in the service of a foreign state. It was even held in the case of the "*Parlement Belge*" (1880), a packet belonging to the Belgian government, that the character of the vessel as a public ship was not affected by its carrying passengers and merchandise for hire. In a more recent case an action brought by the owners of a Greek vessel against a vessel belonging to the state of Rumania was dismissed, though the agents of the Rumanian government had entered an appearance unconditionally and had obtained the release of the vessel on bail, on the ground that the Rumanian government had not authorized acceptance of the British jurisdiction (*The "Jassy"*, 1906, 75 L.J.P. 93).

Writers frequently describe the extraterritoriality of both embassies and ships as absolute. There is, however, this difference, that the extraterritoriality of the latter not being, like that of embassies, a derived one, there seems to be no ground for limitation of it. It was, nevertheless, laid down by the arbitrators in the "*Alabama*" case (Cockburn dissenting), that the privilege of extraterritoriality accorded to vessels had not been admitted into the law of nations as an absolute right, but solely as a proceeding founded on the principle of courtesy and mutual deference between different nations, and that it could therefore "never be appealed to for the protection of acts done in violation of neutrality."

The extraterritorial settlements in the Far East, the privileges of Christians under the arrangements made with the Ottoman Porte, and other exceptions from local jurisdictions, are subject to the conditions laid down in the treaties by which they have been created. There are also cases in which British communities have grown up in barbarous countries without the consent of any local authority. All these are regulated by orders in council, issued now in virtue of the Foreign Jurisdiction Act 1890, an act enabling the crown to exercise any jurisdiction it may have "within a foreign country" in as ample a manner

as if it had been acquired "by cession or conquest of territory." A very exceptional case of extritoriality is that granted to the pope under a special Italian enactment. (T. B.A.)

EXTORTION (Lat. *extorsio*, from *extorquere*, to twist out, to take away by force), in English law the term applied to the exaction by public officers of money or money's worth not due at all, or in excess of what is due, or before it is due. Such exaction, unless made in good faith (*i.e.* in honest mistake as to the sum properly payable), is a misdemeanour by the common law and is punishable by fine and (or) imprisonment. Besides the punishment above stated, an action for twice the value of the thing extorted lies against officers of the king (1275, 3 Edw. I. c. 26). There are numerous provisions for the punishment of particular officers who make illegal exactions or take illegal fees: *e.g.* sheriffs and their officers (Sheriffs Act 1887), county court bailiffs (County Courts Act 1888), clerks of courts of justice, and gaolers who exact fees from prisoners. A gaoler is also punishable for detaining the corpse of a prisoner as security for debt. The term "public officer" is not limited to offices under the crown; and there are old precedents of criminal proceedings for extortion against churchwardens, and against millers and ferrymen who demand tolls in excess of what is customary under their franchise.

The term extortion is also applied to the exaction of money or money's worth by menaces of personal violence or by threats to accuse of crime or to publish defamatory matter about another person. These offences fall partly under the head of robbery and partly under blackmail, or what in French is termed *chantage*.

See *Russell on Crimes* (6th ed., vol. i. p. 423; vol. iii. p. 348).

EXTRACT (from Lat. *extrahere*, to draw out), in pharmacy, the name given to preparations formed by evaporating or concentrating solutions of active principles; *tinctures* are solutions which have not been subjected to any evaporation. "Liquid extracts" are those of a syrupy consistency, and are generally prepared by treating the drug with the solvent (water, alcohol, &c.) and concentrating the solution until it attains the desired consistency. "Ordinary extracts" are thick, tenacious and sometimes even dry preparations; they are obtained by evaporating solutions as obtained above, or the juices expressed from the plants.

Extraction, in chemical technology, is a process for separating one substance from another by taking advantage of the varying solubility of the components in some chosen solvent. The term "lixivation" is used when water is the solvent. In laboratory practice all the common solvents are employed. With small quantities it may suffice to shake the substance with the solvent, the mixture being heated if necessary, filter and distil or otherwise remove the solvent from the distillate. For larger quantities continuous extraction is advisable. This may be carried out in many forms of apparatus; one of the most convenient is the Soxhlet extractor, in which the extract siphons into the flask containing the solvent, and so maintains the quantity of available solvent practically constant. Continuous extraction is generally the practice in technology. One of the most important applications is in the fat and gelatine industries.

EXTRADITION (Lat. *ex*, out, and *traditio*, handing over), the surrender of an alleged criminal for trial by a foreign state where he has taken refuge, to the state against which the alleged offence has been committed. When a person who has committed an offence in one country escapes to another, what is the duty of the latter with regard to him? Should the country of refuge try him in its own courts according to its own laws, or deliver him up to the country whose laws he has broken? To the general question international law gives no certain answer. Some jurists, Grotius among them, incline to hold that a state is bound to give up fugitive criminals, but the majority appear to deny the obligation as a matter of right, and prefer to put it on the ground of comity. And the universal practice of nations is to surrender criminals only in consequence of some special treaty with the country which demands them.

There are two practical difficulties about extradition which

have probably prevented the growth of any uniform rule on the subject. One is the variation in the definitions of crime adopted by different countries. The second is the possibility of the process of extradition being employed to get hold of a person who is wanted by his country, not really for a criminal, but for a political offence. In modern states, and more particularly in England, offences of a political character have always been carefully excluded from the operation of the law of extradition.

1. UNITED KINGDOM.—The Extradition Acts 1870–1873 (33 & 34 Vict. cc. 62, and 36 & 37 Vict. c. 60) and the Fugitive Offenders Act 1881 (44 & 45 Vict. c. 69) deal with different branches of the same subject, the recovery and surrender of fugitive criminals. The Extradition Acts apply in the case of countries with which Great Britain has extradition treaties. The Fugitive Offenders Act applies—(1) as between the United Kingdom and any British possession, (2) as between any two British possessions, and (3) as between the United Kingdom or a British possession and certain foreign countries, such as Turkey and China, in which the crown exercises foreign jurisdiction.

Conditions of Surrender.—In spite of some earlier authorities it has long been settled that in English law there is no power to surrender fugitive criminals to a foreign country without express statutory authority. Such authority is now given by the Extradition Acts 1870–1873, but only in the case of the offences therein specified, and with regard to countries with which an arrangement has been entered into, and to which the acts have been applied by order in council. The acts are further to be applied, subject to such "conditions, exceptions and qualifications as may be deemed expedient" (s. 2); and these conditions, &c., are invariably to be found in the extradition treaty which is set out in the order in council applying the Extradition Acts to a particular country. To support a demand for extradition from Great Britain it is therefore necessary to show that the offence is one of those enumerated in the Extradition Acts, and also in the particular treaty, and that the acts charged amount to the offence according to the laws both of Great Britain and of the state demanding the surrender.

Surrender of Subjects.—A further question arises where a state is called on to surrender one of its own subjects. Some of the treaties, such as those with France and Germany, stipulate that neither contracting party shall surrender its own subjects, and in such cases a British subject cannot be surrendered by his own country. The treaties with Spain, Switzerland and Luxemburg provide for the surrender by Great Britain of her own subjects, but there is no reciprocity. Other treaties, such as those with Austria, Belgium, Russia and the Netherlands, give each party the option of surrendering or refusing to surrender its own subjects in each particular case. Under such treaties British subjects are surrendered unless the secretary of state intervenes to forbid it. Lastly, some treaties, such as that with the United States, contain no restriction of this kind, and the subjects of each power are freely surrendered to the other. Surrender by Great Britain is also subject to the following restrictions contained in s. 3 of the Extradition Act 1870:—(1) that the offence is not of a political character, and the requisition has not been made with a view to try and punish for an offence of a political character; (2) that the prisoner shall not be liable to be tried for any but the specified extradition offences; (3) that he shall not be surrendered until he has been tried and served his sentence for offences committed in Great Britain; and (4) that he shall not be actually given up until fifteen days after his committal for extradition, so as to allow of an application to the courts.

Political Offences.—The question as to what constitutes a political offence is one of some nicety. It was discussed in *In re Castioni* (1890, 1 Q.B. 149), where it was held, following the opinion of Mr Justice Stephen in his *History of the Criminal Law*, that to give an offence a political character it must be "incidental to and form part of political disturbances." Extradition was accordingly refused for homicide committed in the course of an armed rising against the constituted authorities. In the more

recent case of *In re Meunier* (1894, 2 Q.B. 415), an Anarchist was charged with causing two explosions in Paris—one at the Café Véry resulting in the death of two persons, and the other at certain barracks. It was not contended that the outrage at the café was a political crime, but it was argued that the explosion at the barracks came within the description. The court, however, held that to constitute a political offence there must be two or more parties in the state, each seeking to impose a government of its own choice on the other, which was not the case with regard to Anarchist crimes. The party of anarchy was the enemy of all governments, and its effects were directed primarily against the general body of citizens. The test applied in the earlier case is perhaps the more satisfactory of the two.

With regard to the provision that surrender shall not be granted if the requisition has in fact been made with a view to try and punish for an offence of a political character, it was decided in the case of *Arton* (1896, 1 Q.B. 108) that a mere suggestion, that after his surrender for a non-political crime, the prisoner would be interrogated on political matters (his alleged complicity in the Panama scandal), and punished for his refusal to answer, was not enough to bring him within the provision. The court also held that it had no jurisdiction to entertain a suggestion that the request of the French government for his extradition was not made in good faith and in the interests of justice.

Extradition Offences.—The following is a list of crimes in respect of which extradition may be provided for under the Extradition Acts 1870–1873, and the Slave Trade Act 1873. *Extradition Act 1870*:—(1) Murder; (2) Attempt to murder; (3) Conspiracy to murder; (4) Manslaughter; (5) Counterfeiting and altering money, uttering counterfeit or altered money; (6) Forgery, counterfeiting, and altering and uttering what is forged or counterfeited or altered; (7) Embezzlement and larceny; (8) Obtaining money or goods by false pretences; (9) Crimes by bankrupts against bankruptcy law; (10) Fraud by a bailee, banker, agent, factor, trustee or director, or member or public officer of any company made criminal by any law for the time being in force; (11) Rape; (12) Abduction; (13) Child-stealing; (14) Burglary and housebreaking; (15) Arson; (16) Robbery with violence; (17) Threats by letter or otherwise with intent to extort; (18) Crimes committed at sea: (a) Piracy by the law of nations; (b) Sinking or destroying a vessel at sea, or attempting or conspiring to do so; (c) Assault on a ship on the high seas, with intent to destroy life or to do grievous bodily harm; (d) Revolt, or conspiring to revolt, by two or more persons on board a ship on the high seas against the authority of the master; (19) Bribery. *Extradition Act 1873*:—(20) Kidnapping and false imprisonment; (21) Perjury and subornation of perjury. This act also extends to indictable offences under 24 & 25 Vict. cc. 96, 97, 98, 99, 100, and amending and substituted acts. Among such offences included in various extradition treaties are the following:—(22) Obtaining valuable securities by false pretences; (23) Receiving any money, valuable security or other property, knowing the same to have been stolen or unlawfully obtained; (24) Falsification of accounts (see *In re Arton*, 1896, 1 Q.B. 509); (25) Malicious injury to property, if such offence be indictable; (26) Knowingly making, without lawful authority, any instrument, tool or engine adapted and intended for the counterfeiting of coin of the realm; (27) Abandoning children; exposing or unlawfully detaining them; (28) Any malicious act done with intent to endanger the safety of any person in a railway train; (29) Wounding or inflicting grievous bodily harm; (30) Assault occasioning actual bodily harm; (31) Assaulting a magistrate or peace or public officer; (32) Indecent assault; (33) Unlawful carnal knowledge, or any attempt to have unlawful carnal knowledge, of a girl under age; (34) Bigamy; (35) Administering drugs or using instruments with intent to procure the miscarriage of women; (36) Any indictable offence under the laws for the time being in force in relation to bankruptcy. *Slave Trade Act 1873* (36 & 37 Vict. c. 88, s. 27):—(37) Dealing in slaves in such manner as to constitute a criminal offence against the laws of both states.

The United Kingdom has extradition treaties with practically all civilized foreign countries; and though it is not practicable to state which of the statutory extradition offences are included in each, it may be said generally that crimes 1 to 17 inclusive are covered in all, though Rumania has reserved the right to refuse, and Portugal does refuse, to surrender for a crime punishable with death.

The act of 1873 provides for the surrender of accessories before and after the fact to extradition crimes, and most of the treaties contain a clause by which extradition is to be granted for participation in any of the crimes specified in the treaty, provided that such participation is punishable by the laws of both countries. Several of the treaties also contain clauses providing for optional surrender in respect of any crime not expressly mentioned for which extradition can be granted by the laws of both countries.

It is further to be noted that the restrictions on surrender in the Extradition Acts apply only to surrenders by Great Britain. Foreign countries may surrender fugitives to Great Britain without any treaty, if they are willing to do so and their law allows of it, and such surrenders have not infrequently been made. But when surrendered for an extradition crime, the prisoner cannot be tried in England for any other crime committed before such surrender, until he has been restored, or has had an opportunity of returning, to the foreign state from which he was extradited.

Procedure.—To obtain from a foreign country the extradition of a fugitive from the United Kingdom, it is necessary to procure a warrant for his arrest, and to send it, or a certified copy, to the home secretary together with such further evidence as is required by the treaty with the country in question. In most cases an information or deposition containing evidence which would justify a committal for trial in Great Britain will be required. The home secretary will then communicate through the foreign secretary and the proper diplomatic channels with the foreign authorities, and in case of urgency will ask them by telegraph for a provisional arrest. For the arrest in the United Kingdom of fugitive criminals whose extradition is requested by a foreign state, two procedures are provided in ss. 7 and 8 of the act of 1870:—(1) On a diplomatic requisition supported by the warrant of arrest and documentary evidence, the home secretary, if he thinks the crime is not of a political character, will order the chief magistrate at Bow Street to proceed; and such magistrate will then issue a warrant of arrest on such evidence as would be required if the offence had been committed in the United Kingdom. (2) More summarily, any magistrate or justice of the peace may issue a provisional warrant of arrest on evidence which would support such a warrant if the crime had been committed within his jurisdiction. In practice a sworn information is required, but this may be based on a telegram from the foreign authorities. The magistrate or justice must then report the issue of the warrant to the home secretary, who may cancel it and discharge the prisoner. When arrested on the provisional warrant, the prisoner will be brought up before a magistrate and remanded to Bow Street, and will then be further remanded until the magistrate at Bow Street is notified that a formal requisition for surrender has been made; and unless such requisition is made in reasonable time the prisoner is entitled to be discharged. The examination of the prisoner prior to his committal for extradition ordinarily takes place at Bow Street. The magistrate is required to hear evidence that the alleged offence is of a political character or is not an extradition crime. If satisfied in these respects, and if the foreign warrant of arrest is duly authenticated, and evidence is given which according to English law would justify a committal for trial, if the prisoner has not yet been tried, or would prove a conviction if he has already been convicted, the magistrate will commit him for extradition. Under the Extradition Act 1895 the home secretary, if of opinion that removal to Bow Street would be dangerous to the prisoner's life, or prejudicial to his health, may order the case to be taken by a magistrate at the place where the prisoner was apprehended, or then is, and the magistrate may order the

prisoner to be detained in such place. After committal for extradition, every prisoner has fifteen days in which to apply for *habeas corpus*, and after such period, or at the close of the *habeas corpus* proceedings if they are unsuccessful, the home secretary issues his warrant for surrender, and the prisoner is handed over to the officers of the foreign government.

The Extradition Acts apply to the British colonies, the governor being substituted for the secretary of state. Their operation may, however, be suspended by order in council, as in the case of Canada, where the colony has passed an Extradition Act of its own (see Statutory Rules and Orders).

Fugitive Offenders Act.—There are no extradition treaties with certain countries in which the crown exercises foreign jurisdiction, such as Cyprus, Turkey, Egypt, China, Japan, Corea, Zanzibar, Morocco, Siam, Persia, Somali, &c. In these countries the Fugitive Offenders Act 1881 (44 & 45 Vict. c. 69) has been applied, pursuant to s. 36 of that statute, and the measures for obtaining surrender of a fugitive criminal are the same as in a British colony. The act, however, only applies to persons over whom the crown has jurisdiction in these territories, and generally is expressly restricted to British subjects.

Under this act a fugitive from one part of the king's dominions to another, or to a country where the crown exercises foreign jurisdiction, may be brought back by a procedure analogous to extradition, but applicable only to treason, piracy and offences punishable with twelve months' imprisonment with hard labour or more. The original warrant of arrest must be endorsed by one of several authorities where the offenders happen to be,—in practice by the home secretary in the United Kingdom and by the governor in a colony. Pending the arrival of the original warrant a provisional arrest may be made, as under the Extradition Acts. The fugitive must then be brought up for examination before a local magistrate, who, if the endorsed warrant is duly authenticated, and evidence is produced "which, according to the law administered by the magistrate, raises a strong or probable presumption that the offender committed the offence, and that the act applies to it," may commit him for return. An interval of fifteen days is allowed for *habeas corpus* proceedings, and (s. 10) the court has a large discretion to discharge the prisoner, or impose terms, if it thinks the case frivolous, or that the return would be unjust or oppressive, or too severe a punishment. The next step is for the home secretary in the United Kingdom, and the governor in a colony, to issue a warrant for the return of the prisoner. He must be removed within a month, in the absence of reasonable cause to the contrary. If not prosecuted within six months after arrival, or if acquitted, he is entitled to be sent back free of cost.

In the case of fugitive offenders from one part of the United Kingdom to another, it is enough to get the warrant of arrest backed by a magistrate having jurisdiction in that part of the United Kingdom where the offender happens to be. A warrant issued by a metropolitan police magistrate may be executed, without backing, by a metropolitan police officer anywhere, and there are certain other exceptions, but as a rule a warrant cannot be executed without being backed by a local magistrate. (J. E. P. W.)

2. UNITED STATES.—Foreign extradition is purely an affair of the United States, and not for the individual states themselves. Upon a demand upon the United States for extradition, there is a preliminary examination before a commissioner or judge before there can be a surrender to the foreign government (Revised Statutes, Title LXVI.; 22 Statutes at Large, 215). It is enough to show probable guilt (*Ornelas v. Ruiz*, 161 United States Reports, 502). An extradition treaty covers crimes previously committed. If a Power, with which the United States have such a treaty, surrenders a fugitive charged with a crime not included in the treaty, he may be tried in the United States for such crime. Inter-state extradition is regulated by act of Congress under the Constitution of the United States (Article IV. s. 2; United States Revised Statutes, s. 5278). A surrender may be demanded of one properly charged with an act which constitutes a crime under the laws of the demanding state, although

it be no crime in the other state. A party improperly surrendered may be released by writ of *habeas corpus*, either from a state or United States court (*Robb v. Conolly*, 111 U.S. Reports, 624). On his return to the state from which he fled, he is subject to prosecution for any crime, though on a foreign extradition the law is otherwise (*Lascelles v. Georgia*, 148 U.S. Reports, 537). (S. E. B.)

See Sir E. Clarke, *Treatise upon the Law of Extradition* (4th ed., 1904); Biron and Chalmers, *Law and Practice of Extradition* (1903).

EXTRADOS (*extra*, outside, Fr. *dos*, back), the architectural term for the outer boundary of the voussours of an arch (*q.v.*).

EXTREME UNCTION, a sacrament of the Roman Catholic Church. In James v. 14 it is ordained that, if any believer is sick, he shall call for the elders of the church; and they shall pray over him, anointing him with oil in the name of the Lord; and the prayer of faith shall save him that is sick, and the Lord shall raise him up; and if he have committed sins, it shall be forgiven him.

Origen reprobated medical art on the ground that the prescription here cited is enough; modern faith-healers and Peculiar People have followed in his wake. The Catholic Church has more wisely left physicians in possession, and elevated the anointing of the sick into a sacrament to be used only in cases of mortal sickness, and even then not to the exclusion of the healing art.

It has been general since the 9th century. The council of Florence A.D. 1439 thus defined it:—

"The fifth sacrament is extreme unction. Its matter is olive oil, blessed by a bishop. It shall not be given except to a sick person whose death is apprehended. He shall be anointed in the following places: the eyes, ears, nostrils; mouth, hands, feet, reins. The form of the sacrament is this: Through this anointing of thee and through its most pious mercy, be forgiven all thy sins of sight, &c. . . and so in respect of the other organs. A priest can administer this sacrament. But its effect is to make whole the mind, and, so far as it is expedient, the body as well."

This sacrament supplements that of penance (*viz.* remission of post-baptismal sin) in the sense that any guilt unconfessed or left over after normal penances imposed by confessors is purged thereby. It was discussed in the 12th century whether this sacrament is indelible like baptism, or whether it can be repeated; and the latter view, that of Peter Lombard, prevailed.

It was a popular opinion in the middle ages that extreme unction extinguishes all ties and links with this world, so that he who has received it must, if he recovers, renounce the eating of flesh and matrimonial relations. A few peasants of Lombardy still believe that one who has received extreme unction ought to be left to die, and that sick people may be starved to death through the withholding of food on superstitious grounds. Such opinions, combated by bishops and councils, were due to the influence of the *consolamentum* of the Cathars (*q.v.*). In both sacraments the death-bed baptism of an earlier age seems to survive, and they both fulfil a deep-seated need of the human spirit.

Some Gnostics sprinkled the heads of the dying with oil and water to render them invisible to the powers of darkness; but in the East generally, where the need to compete with the Cathar sacrament of *Consolatio* was less acutely felt, extreme unction is unknown. The Latinizing Armenians adopted it from Rome in the crusading epoch. At an earlier date, however, it was usual to anoint the dead.*

In the Roman Church the bishop blesses the oil of the sick used in extreme unctions on Holy Thursday at the Chrismal Mass,¹ using the following prayer of the sacramentaries of Gelasius and Hadrian:—

"Send forth, we pray Thee, O Lord, Thy holy spirit, the Paraclete from Heaven, into this fatness of oil, which Thou hast deigned to produce from the green wood for refreshment of mind and body; and through Thy holy benediction may it be for all that anoint, taste, touch, a protection of mind and body, of soul and spirit, unto the easing away of all pain, all weakness, all sickness of mind and body; wherefore Thou hast anointed priest, kings and prophets and martyrs with thy chrism, perfected by Thee, O Lord, blessed and abiding in our bowels in the name of our Lord Jesus Christ."

See L. Duchesne, *Origines du Culte Chrétien* (Paris, 1898).

(F. C. C.)

¹ The oil left over from the year before is burnt.

EYBESCHÜTZ, JONATHAN (1690-1764), German rabbi, was from 1750 rabbi in Altona. He was a man of erudition, but he owed his fame chiefly to his personality. Few men of the period so profoundly impressed their mark on Jewish life. He became specially notorious because of a curious controversy that arose concerning the amulets which Eybeschütz was suspected of issuing. These amulets recognized the Messianic claims of Sabbatai Sebi (*q.v.*), and a famous rabbinic contemporary of Eybeschütz, Jacob Emden, boldly accused him of heresy. The controversy was a momentous incident in the Jewish life of the period, and though there is insufficient evidence against Eybeschütz, Emden may be credited with having crushed the lingering belief in Sabbatai current even in some orthodox circles. (I. A.)

EYCK, VAN, the name of a family of Flemish painters in whose works the rise and mature development of art in western Flanders are represented. Though bred in the valley of the Meuse, they finally established their professional domicile in Ghent and in Bruges; and there, by skill and inventive genius, they changed the traditional habits of the earlier schools, remodelled the primitive forms of Flemish design, and introduced a complete revolution into the technical methods of execution familiar to their countrymen.

1. **HUBERT (Huybrecht) VAN EYCK** (? 1366-1426) was the oldest and most remarkable of this race of artists. The date of his birth and the records of his progress are lost amidst the ruins of the earlier civilization of the valley of the Meuse. He was born about 1366, at Maeseyck, under the shelter or protection of a Benedictine convent, in which art and letters had been cultivated from the beginning of the 8th century. But after a long series of wars—when the country became insecure, and the schools which had flourished in the towns decayed—he wandered to Flanders, and there for the first time gained a name. As court painter to the hereditary prince of Burgundy, and as client to one of the richest of the Ghent patricians, Hubert is celebrated. Here, in middle age, between 1410 and 1420, he signalized himself as the inventor of a new method of painting. Here he lived in the pay of Philip of Charolais till 1421. Here he painted pictures for the corporation, whose chief magistrates honoured him with a state visit in 1424. His principal masterpiece, the "Worship of the Lamb," commissioned by Jodocus Vijdts, lord of Pamele, is the noblest creation of the Flemish school, a piece of which we possess all the parts dispersed from St Bavon in Ghent to the galleries of Brussels and Berlin,—one upon which Hubert laboured till he died, leaving it to be completed by his brother. Almost unique as an illustration of contemporary feeling for Christian art, this great composition can only be matched by the "Fount of Salvation," in the museum of Madrid. It represents, on numerous panels, Christ on the judgment seat, with the Virgin and St John the Baptist at His sides, hearing the songs of the angels, and contemplated by Adam and Eve, and, beneath him, the Lamb shedding His blood in the presence of angels, apostles, prophets, martyrs, knights and hermits. On the outer sides of the panels are the Virgin and the angel annunciate, the sibyls and prophets who foretold the coming of the Lord, and the donors in prayer at the feet of the Baptist and Evangelist. After this great work was finished it was placed, in 1432, on an altar in St Bavon of Ghent, with an inscription on the framework describing Hubert as "maior quo nemo reperitus," and setting forth, in colours as imperishable as the picture itself, that Hubert began and John afterwards brought it to perfection. John van Eyck certainly wished to guard against an error which ill-informed posterity showed itself but too prone to foster, the error that he alone had composed and carried out an altarpiece executed jointly by Hubert and himself. His contemporaries may be credited with full knowledge of the truth in this respect, and the facts were equally well known to the duke of Burgundy or the chiefs of the corporation of Bruges, who visited the painter's house in state in 1432, and the members of the chamber of rhetoric at Ghent, who reproduced the Agnus Dei as a *tableau vivant* in 1456. Yet a later generation of Flemings forgot the claims of Hubert,

and gave the honours that were his due to his brother John exclusively.

The solemn grandeur of church art in the 15th century never found, out of Italy, a nobler exponent than Hubert van Eyck. His representation of Christ as the judge, between the Virgin and St John, affords a fine display of realistic truth, combined with pure drawing and gorgeous colour, and a happy union of earnestness and simplicity with the deepest religious feeling. In contrast with earlier productions of the Flemish school, it shows a singular depth of tone and great richness of detail. Finished with surprising skill, it is executed with the new oil medium, of which Hubert shared the invention with his brother, but of which no rival artists at the time possessed the secret,—a medium which consists of subtle mixtures of oil and varnish applied to the moistening of pigments after a fashion, only kept secret for a time from gildsmen of neighbouring cities, but unrevealed to the Italians till near the close of the 15th century. When Hubert died on the 18th of September 1426 he was buried in the chapel on the altar of which his masterpiece was placed. According to a tradition as old as the 16th century, his arm was preserved as a relic in a casket above the portal of St Bavon of Ghent. During a life of much apparent activity and surprising successes he taught the elements of his art to his brother John, who survived him.

2. **JOHN (Jan) VAN EYCK** (? 1385-1440). The date of his birth is not more accurately known than that of his elder brother, but he was born much later than Hubert, who took charge of him and made him his "disciple." Under this tuition John learnt to draw and paint, and mastered the properties of colours from Pliny. Later on, Hubert admitted him into partnership, and both were made court painters to Philip of Charolais. After the breaking up of the prince's household in 1421, John became his own master, left the workshop of Hubert, and took an engagement as painter to John of Bavaria, at that time resident at the Hague as count of Holland. From the Hague he returned in 1424 to take service with Philip, now duke of Burgundy, at a salary of 100 livres per annum, and from that time till his death John van Eyck remained the faithful servant of his prince, who never treated him otherwise than graciously. He was frequently employed in missions of trust; and following the fortunes of a chief who was always in the saddle, he appears for a time to have been in ceaseless motion, receiving extra pay for secret services at Leiden, drawing his salary at Bruges, yet settled in a fixed abode at Lille. In 1428 he joined the embassy sent by Philip the Good to Lisbon to beg the hand of Isabella of Portugal. His portrait of the bride fixed the duke's choice. After his return he settled finally at Bruges, where he married, and his wife bore him a daughter, known in after years as a nun in the convent of Maeseyck. At the christening of this child the duke was sponsor, and this was but one of many distinctions by which Philip the Good rewarded his painter's merits. Numerous altarpieces and portraits now give proof of van Eyck's extensive practice. As finished works of art and models of conscientious labour they are all worthy of the name they bear, though not of equal excellence, none being better than those which were completed about 1432. Of an earlier period, a "Consecration of Thomas à Becket" has been preserved, and may now be seen at Chatsworth, bearing the date of 1421; no doubt this picture would give a fair representation of van Eyck's talents at the moment when he started as an independent master, but that time and accidents of omission and commission have altered its state to such an extent that no conclusive opinion can be formed respecting it. The panels of the "Worship of the Lamb" were completed nine years later. They show that John van Eyck was quite able to work in the spirit of his brother. He had not only the lines of Hubert's compositions to guide him, he had also those parts to look at and to study which Hubert had finished. He continued the work with almost as much vigour as his master. His own experience had been increased by travel, and he had seen the finest varieties of landscape in Portugal and the Spanish provinces. This enabled him to transfer to his pictures the charming scenery of lands

more sunny than those of Flanders, and this he did with accuracy and not without poetic feeling. We may ascribe much of the success which attended his efforts to complete the altarpiece of Ghent to the cleverness with which he reproduced the varied aspect of changing scenery, reminiscient here of the orange groves of Cintra, there of the bluffs and crags of his native valley. In all these backgrounds, though we miss the scientific rules of perspective with which the van Eycks were not familiar, we find such delicate perceptions of gradations in tone, such atmosphere, yet such minuteness and perfection of finish, that our admiration never flags. Nor is the colour less brilliant or the touch less firm than in Hubert's panels. John only differs from his brother in being less masculine and less sternly religious. He excels in two splendid likenesses of Jodocus Vijdts and his wife Catherine Burluuts. The same vigorous style and coloured key of harmony characterizes the small "Virgin and Child" of 1432 at Ince, and the "Madonna," probably of the same date, at the Louvre, executed for Rollin, chancellor of Burgundy. Contemporary with these, the male portraits in the National Gallery, and the "Man with the Pinks," in the Berlin Museum (1432-1434), show no relaxation of power; but later creations display no further progress, unless we accept as progress a more searching delicacy of finish, counterbalanced by an excessive softness of rounding in flesh contours. An unflinching minuteness of hand and great tenderness of treatment may be found, combined with angularity of drapery and some awkwardness of attitude in the full length portrait couple (John Arnolfini and his wife) at the National Gallery (1434), in which a rare insight into the detail of animal nature is revealed in a study of a terrier dog. A "Madonna with Saints," at Dresden, equally soft and minute, charms us by the mastery with which an architectural background is put in. The bold and energetic striving of earlier days, the strong bright tone, are not equalled by the soft blending and tender tints of the later ones. Sometimes a crude ruddiness in flesh strikes us as a growing defect, an instance of which is the picture in the museum of Bruges, in which Canon van der Paelen is represented kneeling before the Virgin under the protection of St George (1434). From first to last van Eyck retains his ability in portraiture. Fine specimens are the two male likenesses in the gallery of Vienna (1436), and a female, the master's wife, in the gallery of Bruges (1439). His death in 1440/41 at Bruges is authentically recorded. He was buried in St Donat. Like many great artists he formed but few pupils. Hubert's disciple, Jodocus of Ghent, hardly does honour to his master's teaching, and only acquires importance after he has thrown off some of the peculiarities of Flemish teaching. Petrus Cristus, who was taught by John, remains immeasurably behind him in everything that relates to art. But if the personal influence of the van Eycks was small, that of their works was immense, and it is not too much to say that their example, taken in conjunction with that of van der Weyden, determined the current and practice of painting throughout the whole of Europe north of the Alps for nearly a century.

See also Waagen, *Hubert and Johann van Eyck* (1822); Voll, *Werke des Jan van Eyck* (1900); L. Kämmerer on the two families in Knackfuss's *Künstler-Monographien* (1898). (J. A. C.)

EYE, a market-town and municipal borough in the Eye parliamentary division of Suffolk; England; 94½ m. N.E. from London by the Great Eastern railway, the terminus of a branch from the Ipswich-Norwich line. Pop. (1901) 2004. The church of St Peter and St Paul is mainly of Perpendicular flint work, with Early English portions and a fine Perpendicular rood screen. It was formerly attached to a Benedictine priory. Slight fragments of a Norman castle crown a mound of probably earlier construction. There are a town hall, corn exchange, and grammar school founded in 1566. Brewing is the chief industry. The town is governed by a mayor, 4 aldermen and 12 councillors. Area, 4410 acres.

Eye (*Heya*, *Aye*) was once surrounded by a stream, from which it is said to have derived its name. Leland says it was situated in a marsh and had formerly been accessible by river vessels from Cromer, though the river was then only navigable

to Burston, 12 m. from Eye. From the discovery of numerous bones and Roman urns and coins it has been thought that the place was once the cemetery of a Roman camp. William I. gave the lordship of Eye to Robert Malet, a Norman, who built a castle and a Benedictine monastery which was at first subordinate to the abbey of Bernay in Normandy. Eye is a borough by prescription. In 1205 King John granted to the townsmen a charter freeing them from various tolls and customs and from the jurisdiction of the shire and hundred courts. Later charters were granted by Elizabeth in 1558 and 1574, by James I. in 1604, and by William III. in 1697. In 1574 the borough was newly incorporated under two bailiffs, ten chief and twenty-four inferior burgesses, and an annual fair on Whit-Monday and a market on Saturday were granted. Two members were returned to each parliament from 1571 till 1832, when the Reform Act reduced the membership to one. By the Redistribution Act of 1885 the representation was merged in the Eye division of the county. The making of pillow-lace was formerly carried on extensively, but practically ceased with the introduction of machinery.

EYE (O. Eng. *edge*, Ger. *Auge*; derived from an Indo-European root also seen in Lat. *oc-ulus*, the organ of vision (*q.v.*)).

ANATOMY.—The eye consists of the eyeball, which is the true organ of sight, as well as of certain muscles which move it, and of the lachrymal apparatus which keeps the front of it in a moist condition. The *eyeball* is contained in the front of the orbit and is a sphere of about an inch (24 mm.) in diameter. From the front of this a segment of a lesser sphere projects slightly and forms the *cornea* (fig. 1, *co*). There are three coats

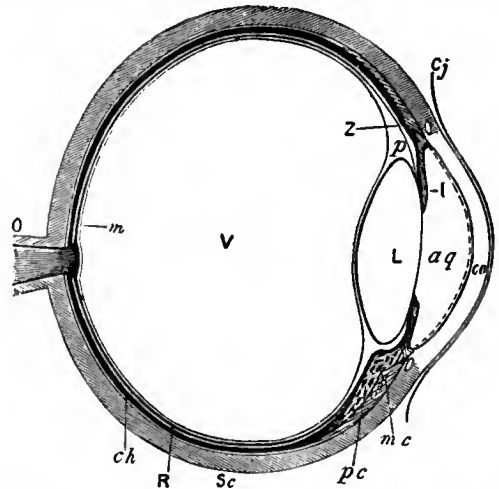

FIG. 1.—Diagrammatic Section through the Eyeball.

<i>cj</i> , Conjunctiva.	<i>L</i> , Lens.
<i>co</i> , Cornea.	<i>V</i> , Vitreous body.
<i>Sc</i> , Sclerotic.	<i>Z</i> , Zonule of Zinn, the ciliary process being removed to show it.
<i>ch</i> , Choroid.	<i>p</i> , Canal of Petit.
<i>pc</i> , Ciliary processes.	<i>m</i> , Yellow spot.
<i>mc</i> , Ciliary muscle.	The dotted line behind the cornea represents its posterior epithelium.
<i>O</i> , Optic nerve.	
<i>R</i> , Retina.	
<i>I</i> , Iris.	[humour.
<i>aq</i> , Anterior chamber of aqueous	

to the eyeball, an external (protective), a middle (vascular), and an internal (sensory). There are also three refracting media, the aqueous humour, the lens and the vitreous humour or body.

The protective coat consists of the *sclerotic* in the posterior five-sixths and the *cornea* in the anterior sixth. The sclerotic (fig. 1, *Sc*) is a firm fibrous coat, forming the "white of the eye," which posteriorly is pierced by the optic nerve and blends with the sheath of that nerve, while anteriorly it is continued into the cornea at the *corneo-scleral junction*. At this point a small canal, known as the *canal of Schlemm*, runs round the margin of the cornea in the substance of the sclerotic (see fig. 1). Between the sclerotic and the subjacent choroid coat is a lymph space traversed by some loose pigmented connective tissue,—the

lamina fusca. The cornea is quite continuous with the sclerotic but has a greater convexity. Under the microscope it is seen to consist of five layers. Most anteriorly there is a layer of stratified epithelium, then an anterior elastic layer, then the *substantia propria* of the cornea which is fibrous with spaces in which the stellate *corneal corpuscles* lie, while behind this is the posterior elastic layer and then a delicate layer of endothelium. The transparency of the cornea is due to the fact that all these structures have the same refractive index.

The middle or vascular coat of the eye consists of the *choroid*, the *ciliary processes* and the *iris*. The choroid (fig. 1, *ch*) does not come quite as far forward as the corneo-scleral junction; it is composed of numerous blood-vessels and pigment cells bound together by connective tissue and, superficially, is lined by a delicate layer of pigmented connective tissue called the *lamina suprachoroidea* in contact with the already-mentioned perichoroidal lymph space. On the deep surface of the choroid is a structureless basal lamina.

The *ciliary processes* are some seventy triangular ridges, radially arranged, with their apices pointing backward (fig. 1, *pc*), while their bases are level with the corneo-scleral junction. They are as vascular as the rest of the choroid, and contain in their interior the *ciliary muscle*, which consists of radiating and circular fibres. The radiating fibres (fig. 1, *mc*) rise, close to the canal of Schlemm, from the margin of the posterior elastic lamina of the cornea, and pass backward and outward into the ciliary processes and anterior part of the choroid, which they pull forward when they contract. The circular fibres lie just internal to these and are few or wanting in short-sighted people.

The *iris* (fig. 1, *I*) is the coloured diaphragm of the eye, the centre of which is pierced to form the pupil; it is composed of a connective tissue stroma containing blood-vessels, pigment cells and muscle fibres. In front of it is a reflection of the same layer of endothelium which lines the back of the cornea, while behind both it and the ciliary processes is a double layer of epithelium, deeply pigmented, which really belongs to the retina. The pigment in the substance of the iris is variously coloured in different individuals, and is often deposited after birth, so that, in newly-born European children, the colour of the eyes is often slate-blue owing to the black pigment at the back of the iris showing through. White, yellow or reddish-brown pigment is deposited later in the substance of the iris, causing the appearance, with the black pigment behind, of grey, hazel or brown eyes. In blue-eyed people very little interstitial pigment is formed, while in Albinos the posterior pigment is also absent and the blood-vessels give the pink coloration. The muscle fibres of the iris are described as circular and radiating, though it is still uncertain whether the latter are really muscular rather than elastic. On to the front of the iris, at its margin, the posterior layer of the posterior elastic lamina is continued as a series of ridges called the *ligamentum pectinatum iridis*, while between these ridges are depressions known as the *spaces of Fontana*.

The inner or sensory layer of the wall of the eyeball is the *retina*; it is a delicate transparent membrane which becomes thinner as the front of the eye is approached. A short distance behind the ciliary processes the nervous part of it stops and forms a scalloped border called the *ora serrata*, but the pigmented layer is continued on behind the ciliary processes and iris, as has been mentioned, and is known as the *pars ciliaris retinae* and *pars iridica retinae*. Under the microscope the posterior part of the retina is seen to consist of eight layers. In its passage from the lens and vitreous the light reaches these layers in the following order:—(1) Layer of nerve fibres; (2) Layer of ganglion cells; (3) Inner molecular layer; (4) Inner nuclear layer; (5) Outer molecular layer; (6) Outer nuclear layer; (7) Layer of rods and cones; (8) Pigmented layer.

The layer of nerve fibres (fig. 2, 2) is composed of the axis-cylinders only of the fibres of the optic nerve which pierce the sclerotic, choroid and all the succeeding layers of the retina to radiate over its surface.

The ganglionic layer (fig. 2, 3) consists of a single stratum of large ganglion cells, each of which is continuous with a fibre of the preceding layer which forms its axon. Each also gives off a number of finer processes (dendrites) which arborize in the next layer.

The inner molecular layer (fig. 2, 4) is formed by the interlacement of the dendrites of the last layer with those of the cells of the inner nuclear layer which comes next.

The inner nuclear layer (fig. 2, 5) contains three different kinds of cells, but the most important and numerous are large bipolar cells, which send one process into the inner molecular layer, as has just been mentioned, and the other into the outer molecular layer, where they arborize with the ends of the rod and cone fibres.

The outer molecular layer (fig. 2, 6) is very narrow and is formed by the arborizations just described. The outer nuclear layer (fig. 2, 7), like the inner, consists of oval cells, which are of two kinds. The rod granules are transversely striped, and are connected externally with the rods, while internally processes pass into the outer molecular layer to end in a knob around which the arborizations of the inner nuclear cells lie. The cone granules are situated more externally, and are in close contact with the cones; internally their processes form a foot-plate in the outer molecular layer from which arborizations extend.

The layer of rods and cones (fig. 2, 8) contains these structures, the rods being more numerous than the cones. The rods are spindle-shaped bodies, of which the inner segment is thicker than the outer. The cones are thicker and shorter than the rods, and resemble Indian clubs, the handles of which are directed outward and are transversely striped. In the outer part of the rods the visual purple or rhodopsin is found.

The pigmented layer consists of a single layer of hexagonal cells containing pigment, which is capable of moving towards the rods and cones when the eye is exposed to light and away from them in the dark.

Supporting the delicate nervous structures of the retina are a series of connective tissue rods known as the *fibræ of Müller* (fig. 2, *Cl*); these run through the thickness of the retina at

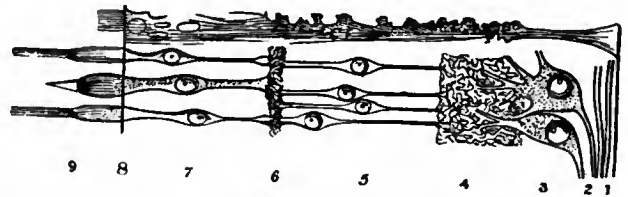

FIG. 2.—Diagrammatic section through the retina to show the several layers, which are numbered as in the text. *Cl*, The radial fibres of the supporting connective tissue.

right angles to its surface, and are joined together on the inner side of the layer of nerve fibres to form the *inner limiting membrane*. More externally, at the bases of the rods and cones, they unite again to form the outer limiting membrane.

When the retina is looked at with the naked eye from in front two small marks are seen on it. One of these is an oval depression about 3 mm. across, which, owing to the presence of pigment, is of a yellow colour and is known as the yellow spot (*macula lutea*); it is situated directly in the antero-posterior axis of the eyeball, and at its margin the nerve fibre layer is thinned and the ganglionic layer thickened. At its centre, however, both these layers are wanting, and in the layer of rods and cones only the cones are present. This central part is called the *fovea centralis* and is the point of acutest vision. The second mark is situated a little below and to the inner side of the yellow spot; it is a circular disk with raised margins and a depressed centre and is called the *optic disk*; in structure it is a complete contrast to the yellow spot, for all the layers except that of the nerve fibres are wanting, and consequently, as light cannot be appreciated here, it is known as the "blind spot." It marks the point of entry of the optic nerve, and at its centre the retinal artery appears and divides into branches. An appreciation of the condition of the optic disk is one of the chief objects of the ophthalmoscope.

The *crystalline lens* (fig. 1, *L*) with its ligament separates the aqueous from the vitreous chamber of the eye; it is a biconvex lens the posterior surface of which is more curved than the anterior. Radiating from the anterior and posterior poles are three faint lines forming a Y, the posterior Y being erect and the anterior inverted. Running from these figures are a series of lamellae, like the layers of an onion, each of which is made up of a number of fibrils called the lens fibres. On the anterior surface of the lens is a layer of epithelial cells, which, towards the margin or equator, gradually elongate into lens fibres. The whole lens is enclosed in an elastic structureless membrane, and, like the

cornea, its transparency is due to the fact that all its constituents have the same refractive index.

The ligament of the lens is the thickened anterior part of the hyaloid membrane which surrounds the vitreous body; it is closely connected to the iris at the ora serrata, and then splits into two layers, of which the anterior is the thicker and blends with the anterior part of the elastic capsule of the lens, so that, when its attachment to the ora serrata is drawn forward by the ciliary muscle, the lens, by its own elasticity, increases its convexity. Between the anterior and posterior splitting of the hyaloid membrane is a circular lymph space surrounding the margin of the lens known as the *canal of Petit* (fig. 1, p).

The *aqueous humour* (fig. 1, aq) is contained between the lens and its ligament posteriorly and the cornea anteriorly. It is practically a very weak solution of common salt (chloride of sodium 1.4%). The space containing it is imperfectly divided into a large anterior and a small posterior chamber by a perforated diaphragm—the iris.

The *vitreous body* or *humour* is a jelly which fills all the contents of the eyeball behind the lens. It is surrounded by the hyaloid membrane, already noticed, and anteriorly is concave for the reception of the lens.

From the centre of the optic disk to the posterior pole of the lens a lymph canal formed by a tube of the hyaloid membrane stretches through the centre of the vitreous body; this is the *canal of Stilling*, which in the embryo transmitted the hyaloid artery to the lens. The composition of the vitreous is practically the same as that of the aqueous humour.

The *arteries of the eyeball* are all derived from the ophthalmic branch of the internal carotid, and consist of the retinal which enters the optic nerve far back in the orbit, the two long ciliaries, which run forward in the choroid and join the anterior ciliaries, from muscular branches of the ophthalmic, in the circulus iridis major round the margin of the iris, and the six to twelve short ciliaries which pierce the sclerotic round the optic nerve and supply the choroid and ciliary processes.

The *veins of the eyeball* emerge as four or five trunks rather behind the equator; these are called from their appearance *venae vorticosae*, and open into the superior ophthalmic vein. In addition to these there is a retinal vein which accompanies its artery.

Accessory Structures of the Eye.—The *eyelids* are composed of the following structures from in front backward: (1) Skin; (2) Superficial fascia; (3) Orbicularis palpebrarum muscle; (4) *Tarsal plates* of fibrous tissue attached to the orbital margin by the superior and inferior *palpebral ligaments*, and, at the junction of the eyelids, by the external and internal *tarsal ligaments* of which the latter is also known as the *tendo oculi*; (5) *Meibomian glands*, which are large modified sebaceous glands lubricating the edges of the lids and preventing them adhering, and *Glands of Moll*, large sweat glands which, when inflamed, cause a "sty"; (6) the *conjunctiva*, a layer of mucous membrane which lines the back of the eyelids and is reflected on to the front of the globe, the reflection forming the fornix: on the front of the cornea the conjunctiva is continuous with the layer of epithelial cells already mentioned.

The *lacrimal gland* is found in the upper and outer part of the front of the orbit. It is about the size of an almond and has an upper (orbital) and a lower (palpebral) part. Its six to twelve ducts open on to the superior fornix of the conjunctiva.

The *lacrimal canals* (canaliculi) (see fig. 3, 2 and 3) are superior and inferior, and open by minute orifices (puncta) on to the free margins of the two eyelids near their inner point of junction. They collect the tears, secreted by the lacrimal gland, which thus pass right across the front of the eyeball, continually moistening the conjunctiva. The two ducts are bent round a small pink tubercle called the *caruncula lacrymalis* (fig. 3, 4) at the inner angle of the eyelids, and open into the *lacrimal sac* (fig. 3, 5), which lies in a groove in the lacrimal bone. The sac is continued down into the *nasal duct* (fig. 3, 6), which is about $\frac{3}{4}$ inch long and opens into the inferior meatus of the nose, its opening being guarded by a valve.

The orbit contains seven muscles, six of which rise close to the optic foramen. The *levator palpebrae superioris* is the highest, and passes forward to the superior tarsal plate and fornix of the conjunctiva. The *superior* and *inferior recti* are inserted into the upper and lower surfaces of the eyeball respectively; they make the eye look inward as well as up or down. The external and internal recti are inserted into the sides of the eyeball and make it look outward or inward. The superior oblique runs forward to a pulley in the inner and front part of the roof of the orbit, round which it turns to be inserted into the outer

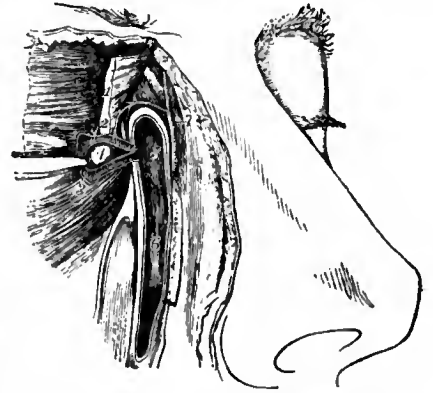

FIG. 3.—Lacrimal Canals and Duct.

and back part of the eyeball. It turns the glance downward and outward. The inferior oblique rises from the inner and front part of the floor of the orbit, and is also inserted into the outer and back part of the eyeball. It directs the glance upward and outward. Of all these muscles the superior oblique is supplied by the fourth cranial nerve, the external rectus by the sixth and the rest by the third.

The posterior part of the eyeball and the anterior parts of the muscles are enveloped in a lymph space, known as the *capsule of Tenon*, which assists their movements.

The *embryology*.—As is pointed out in the article BRAIN, the *optic vesicles* grow out from the fore-brain, and the part nearest the brain becomes constricted and elongated to form the optic stalk (see figs. 4 and 5, β). At the same time the ectoderm covering the side of the head thickens and becomes invaginated to form the lens vesicle (see figs. 4 and 5, δ), which later loses its connexion with the surface and approaches the optic vesicle, causing that structure to become cupped for its reception, so that what was the optic vesicle becomes the optic cup and consists of an external and an internal layer of cells (fig. 6 β and δ). Of these the outer cells become the retinal pigment, while the inner form the other layers of the retina. The invagination of the optic cup extends, as the *choroidal fissure* (not shown in the

diagrams), along the lower and back part of the optic stalk, and into this slit sinks some of the surrounding mesoderm to form the vitreous body and the hyaloid arteries, one of which persists.¹ When this has happened the fissure closes up. The anterior epithelium of the lens vesicle remains, but from the posterior the lens fibres are developed and these gradually fill up the cavity. The superficial layer of head ectoderm, from which the lens has been invaginated and separated, becomes the anterior



FIG. 4.
Diagram of Developing Eye (1st stage).

a, Forebrain.
 β , Optic vesicle.
 γ , Superficial ectoderm.
 δ , Thickening for lens.



FIG. 5.
Diagram of Developing Eye (2nd stage).

a, Forebrain.
 β , Optic cup.
 δ , Invagination of lens.
Other letters as in fig. 4.

¹Some embryologists regard the vitreous body as formed from the ectoderm (see Quain's *Anatomy*, vol. i., 1908).

epithelium of the cornea (fig. 6, ϵ), and between it and the lens the mesoderm sinks in to form the cornea, iris and anterior chamber of the eye, while surrounding the optic cup the mesoderm forms the sclerotic and choroid coats (fig. 7, η and ζ).

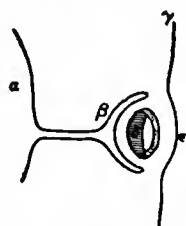

FIG. 6.

Diagram of Developing Eye (3rd stage).

- δ , Solid lens.
- ϵ , Corneal epithelium.
- Other letters as in figs. 4 and 5.

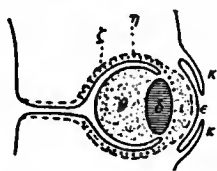

FIG. 7.

Diagram of Developing Eye (4th stage). The mesodermal tissues are dotted.

- ζ , Choroid and Iris.
- η , Sclerotic and Cornea.
- θ , Vitreous.
- ϵ , Aqueous.
- κ , Eyelids.

humours as well as the iris and cornea are derived from the mesoderm.

See *Human Embryology*, by C. S. Minot (New York); *Quain's Anatomy*, vol. i. (1908); "Entwicklung des Auges der Wirbeltiere," by A. Frosiep, in *Handbuch der vergleichenden und experimentellen Entwicklungslehre der Wirbeltiere* (O. Hertwig, Jena, 1905).

COMPARATIVE ANATOMY.—The Acrania, as represented by Amphioxus (the lancelet), have a patch of pigment in the fore part of the brain which is regarded as the remains of a degenerated eye. In the Cyclostomata the hag (*Myxine*) and larval lamprey (*Ammocoetes*) have ill-developed eyes lying beneath the skin and devoid of lens, iris, cornea and sclerotic as well as eye muscles. In the adult lamprey (*Petromyzon*) these structures are developed at the metamorphosis, and the skin becomes transparent, rendering sight possible. Ocular muscles are developed, but, unlike most vertebrates, the inferior rectus is supplied by the sixth nerve while all the others are supplied by the third. In all vertebrates the retina consists of a layer of senso-neural cells, the rods and cones, separated from the light by the other layers which together represent the optic ganglia of the invertebrates; in the latter animals, however, the senso-neural cells are nearer the light than the ganglia.

In fishes the eyeball is flattened in front, but the flat cornea is compensated by a spherical lens, which, unlike that of other vertebrates, is adapted for near vision when at rest. The iris in some bony fishes (*Teleostei*) is not contractile. In the *Teleostei*, too, there is a process of the choroid which projects into the vitreous chamber and runs forward to the lens; it is known as the *processus falciformis*, and, besides nourishing the lens, is concerned in accommodation. This specialized group of fishes is also remarkable for the possession of a so-called *choroid gland*, which is really a *rete mirabile* (see ARTERIES) between the choroid and sclerotic. The sclerotic in fishes is usually chondrified and sometimes calcified or ossified. In the retina the rods and cones are about equal in number, and the cones are very large. In the cartilaginous fishes (*Elasmobranchs*)

there is a silvery layer, called the *tapetum lucidum*, on the retinal surface of the choroid.

In the Amphibia the cornea is more convex than in the fish, but the lens is circular and the sclerotic often chondrified. There is no *processus falciformis* or *tapetum lucidum*, but the class is interesting in that it shows the first rudiments of the ciliary muscle, although accommodation is brought about by shifting the lens. In the retina the rods outnumber the cones and these latter are smaller than in any other animals. In some Amphibians coloured oil globules are found in connexion with the cones, and sometimes two cones are joined, forming double or twin cones.

In Reptilia the eye is spherical and its anterior part is often protected by bony plates in the sclerotic (*Lacertilia* and *Chelonia*). The ciliary muscle is striated, and in most reptiles accommodation is effected by relaxing the ciliary ligament as in higher vertebrates, though in the snakes (*Ophidia*) the lens is shifted as it is in the lower forms. Many lizards have a vascular projection of the choroid into the vitreous, foreshadowing the pecten of birds and homologous with the *processus falciformis* of fishes. In the retina the rods are scarce or absent.

In birds the eye is tubular, especially in nocturnal and raptorial forms: this is due to a lengthening of the ciliary region, which is always protected by bony plates in the sclerotic. The pecten, already mentioned in lizards, is a pleated vascular projection from the optic disk towards the lens which in some cases it reaches. In *Apteryx* this structure disappears. In the retina the cones outnumber the rods, but are not as numerous as in the reptiles. The ciliary muscle is of the striped variety.

In the Mammalia the eye is largely enclosed in the orbit, and bony plates in the sclerotic are only found in the monotremes. The cornea is convex except in aquatic mammals, in which it is flattened. The lens is biconvex in diurnal mammals, but in nocturnal and aquatic it is spherical. There is no pecten, but the numerous hyaloid arteries which are found in the embryo represent it. The iris usually has a circular pupil, but in some ungulates and kangaroos it is a transverse slit. In the Cetacea this transverse opening is kidney-shaped, the hilum of the kidney being above. In many carnivores, especially nocturnal ones, the slit is vertical, and this form of opening seems adapted to a feeble light, for it is found in the owl, among birds. The *tapetum lucidum* is found in Ungulata, Cetacea and Carnivora. The ciliary muscle is unstriped. In the retina the rods are more numerous than the cones, while the macula lutea only appears in the Primates in connexion with binocular vision.

Among the accessory structures of the eye the retractor bulbi muscle is found in amphibians, reptiles, birds and many mammals; its nerve supply shows that it is probably a derivative of the external or posterior rectus. The nictitating membrane or third eyelid is well-developed in amphibians, reptiles, birds and some few sharks; it is less marked in mammals, and in Man is only represented by the little *plica semilunaris*. When functional it is drawn across the eye by special muscles derived from the retractor bulbi, called the *bursalis* and *pyramidalis*. In connexion with the nictitating membrane the Harderian gland is developed, while the lachrymal gland secretes fluid for the other eyelids to spread over the conjunctiva. These two glands are specialized parts of a row of glands which in the Urodela (tailed amphibians) are situated along the lower eyelid; the outer or posterior part of this row becomes the lachrymal gland, which in higher vertebrates shifts from the lower to the upper eyelid, while the inner or anterior part becomes the Harderian gland. Below the amphibians glands are not necessary, as the water keeps the eye moist.

The lachrymal duct first appears in the tailed amphibians; in snakes and gecko lizards, however, it opens into the mouth.

For literature up to 1900 see R. Wiedersheim's *Vergleichende Anatomie der Wirbeltiere* (Jena, 1902). Later literature is noticed in the catalogue of the Physiological Series of the R. College of Surgeons of England Museum, vol. iii. (London, 1906). (F. G. P.)

EYE DISEASES.—The specially important diseases of the eye are those which temporarily or permanently interfere with

sight. In considering the pathology of the eye it may be remembered that (1) it is a double organ, while (2) either eye may have its own trouble.

1. The two eyes act together, under normal conditions, for all practical purposes exactly as if there were but one eye placed in the middle of the face. All impressions made upon either retina, to the one side of a vertical line through the centre, the *fovea centralis*, before giving rise to conscious perception cause a stimulation of the same area in the brain. Impressions formed simultaneously, for instance, on the right side of the right retina and on corresponding areas of the right side of the left retina, are conveyed to the same spots in the right occipital lobe of the brain. Pathological processes, therefore, which are localized in the right or left occipital lobes, or along any part of the course of the fibres which pass from the right or left optic tracts to these "visual centres," cause defects in function of the right or left halves of the two retinæ. *Hemianopia*, or half-blindness, arising from these pathological changes, is of very varying degrees of severity, according to the nature and extent of the particular lesion. The blind areas in the two fields of vision, corresponding to the outward projection of the paralysed retinal areas, are always symmetrical both in shape and degree. The central lesion may for instance be very small, but at the same time destructive to the nerve tissue. This will be revealed as a sector-shaped or insular symmetrical complete blindness in the fields of vision to the opposite side. Or a large central area, or an area comprising many or all of the nerve fibres which pass to the visual centre on one side, may be involved in a lesion which causes impairment of function, but no actual destruction of the nerve tissue. There is thus caused a symmetrical weakening of vision (*amblyopia*) in the opposite fields. In such cases the colour vision is so much more evidently affected than the sense of form that the condition has been called *hemiachromatopsia* or half-colour blindness. *Hemianopia* may be caused by hæmorrhage, by embolism, by tumour growth which either directly involves the visual nerve elements or affects them by compression and by inflammation. Transitory hemianopia is rare and is no doubt most frequently of toxic origin.

The two eyes also act as if they were one in accommodating. It is impossible for the two eyes to accommodate simultaneously to different extents, so that where there is, as occasionally happens, a difference in focus between them, this difference remains the same for all distances for which they are adapted. In such cases, therefore, both eyes cannot ever be accurately adapted at the same time, though either may be alone. It often happens as a consequence that the one eye is used to receive the sharpest images of distant, and the other of near objects. Any pathological change which leads to an interference in the accommodating power of one eye alone must have its origin in a lesion which lies peripherally to the nucleus of the third cranial nerve. Such a lesion is usually one of the third nerve itself. Consequently, a unilateral accommodation paresis is almost invariably associated with pareses of some of the oculo-motor muscles. A bilateral accommodation paresis is not uncommon. It is due to a nuclear or more central cerebral disturbance. Unlike a hemianopia, which is mostly permanent, a double accommodation paresis is frequently transitory. It is often a post-diphtheritic condition, appearing alone or associated with other paresis.

Both eyes are also normally intimately associated in their movements. They move in response to a stimulus or a combination of stimuli, emanating from different centres of the brain, but one which is always equally distributed to the corresponding muscles in both eyes, so that the two lines of fixation meet at the succession of points on which attention is directed. The movements are thus associated in the same direction, to the right or left, upwards or downwards, &c. In addition, owing to the space which separates the two eyes, convergent movements, caused by stimuli equally distributed between the two internal recti, are required for the fixation of nearer and nearer-lying objects. These movements would not be necessary in the case of a single eye. It would merely have to accommodate.

The converging movements of the double eye occur in association with accommodation, and thus a close connexion becomes established between the stimuli to accommodation and convergence. All combinations of convergent and associated movements are constantly taking place normally, just as if a single centrally-placed eye were moved in all directions and altered its accommodation according to the distance, in any direction, of the object which is fixed.

Associated and convergent movements may be interfered with pathologically in different ways. Cerebral lesions may lead to their impairment or complete abolition, or they may give rise to involuntary spasmodic action, as the result of paralyzing or irritating the centres from which the various co-ordinated impulses are controlled or emanate. Lesions which do not involve the centres may prevent the response to associated impulses in one eye alone by interfering with the functional activity of one or more of the nerves along which the stimuli are conveyed. Paralysis of oculo-motor nerves is thus a common cause of defects of association in the movements of the double eye. The great advantage of simultaneous binocular vision—viz. the appreciation of depth, or stereoscopic vision—is thus lost for some, or it may be all directions of fixation. Instead of seeing singly with two eyes, there is then double-vision (*diplopia*). This persists so long as the defect of association continues, or so long as the habit of mentally suppressing the image of the faultily-directed eye is not acquired.

In the absence of any nerve lesions, central or other, interfering with their associated movements, the eyes continue throughout life to respond equally to the stimuli which cause these movements, even when, owing to a visual defect of the one eye, binocular vision has become impossible. It is otherwise, however, with the proper co-ordination of convergent movements. These are primarily regulated by the unconscious desire for binocular vision, and more or less firmly associated with accommodation. When one eye becomes blind, or when binocular vision for other reasons is lost, the impulse is gradually, as it were, unlearned. This is the cause of *divergent concomitant squint*. Under somewhat similar conditions a degree of convergence, which is in excess of the requirements of fixation, may be acquired from different causes. This gives rise to *convergent concomitant squint*.

For *Astigmatism*, &c., see the article VISION.

2. Taking each eye as a single organ, we find it to be subject to many diseases. In some cases both eyes may be affected in the same way, e.g. where the local disease is a manifestation of some general disturbance. Apart from the fibrous coat of the eye, the sclera, which is little prone to disease, and the external muscles and other adnexa, the eye may be looked upon as composed of two elements, (a) the dioptric media, and (b) the parts more or less directly connected with perception. Pathological conditions affecting either of these elements may interfere with sight.

The dioptric media, or the transparent portions which are concerned in the transmission of light to, and the formation of images upon, the retina, are the following: the *cornea*, the *aqueous humour*, the *crystalline lens* and the *vitreous humour*. Loss of transparency in any of these media leads to blurring of the retinal images of external objects. In addition to loss of transparency the cornea may have its curvature altered by pathological processes. This necessarily causes imperfection of sight. The crystalline lens, on the other hand, may be dislocated, and thus cause image distortion.

The Cornea.—The transparency of the cornea is mainly lost by inflammation (*keratitis*), which causes either an infiltration of its tissues with leucocytes, or a more focal, more destructive ulcerative process.

Inflammation of the cornea may be primary or secondary, i.e. the inflammatory changes met with in the corneal tissue may be directly connected with one or more foci of inflammation in the cornea itself or the focus or foci may be in some other part of the eye. Only the very superficial forms of primary keratitis, those confined to the epithelial layer, leave no permanent change:

there is otherwise always a loss of tissue resulting from the inflammation and this loss is made up for by more or less densely intransparent connective tissue (*nebula, leucoma*). These according to their site and extent cause greater or less visual disturbance. Primary keratitis may be ulcerative or non-ulcerative, superficial or deep, diffuse or circumscribed, vascularized or non-vascularized. It may be complicated by deeper inflammations of the eye such as iritis and cyclitis. In some cases the anterior chamber is invaded by pus (*hypopyon*). The healing of a corneal ulcer is characterized by the disappearance of pain where this has been a symptom and by the rounding off of its sharp margins as epithelium spreads over them from the surrounding healthy parts. Ulcers tend to extend either in depth or superficially, rarely in both manners at the same time. A deep ulcer leads to perforation with more or less serious consequences according to the extent of the perforation. Often an eye bears permanent traces of a perforation in adhesion of the iris to the back of a corneal scar or in changes in the lens capsule (capsular cataract). In other cases the ulcerated cornea may yield to pressure from within, which causes it to bulge forwards (*staphyloma*).

The principal causes of primary keratitis are traumata and infection from the conjunctiva. Traumata are most serious when the body causing the wound is not aseptic or when micro-organisms from some other source, often the conjunctiva and tear-sac, effect a lodgment before healing of the wound has sufficiently advanced. In infected cases a complication with iritis is not uncommon owing to the penetration of toxins into the anterior chamber.

Inflammations of the cornea are the most important diseases of the eye, because they are among the most frequent, because of the value of the cornea to vision and because much good can often be done by judicious treatment and much harm result from wrong interference and neglect. The treatment of primary keratitis must vary according to the cause. Generally speaking the aim should be to render the ulcerated portions as aseptic as possible without using applications which are apt to cause a great deal of irritation and thus interfere with healing. On this account it is important to be able to recognize when healing is taking place, for as soon as this is the case, rest, along with frequent irrigation of the conjunctiva with sterilized water at the body temperature, and occasionally mild antiseptic irrigation of the nasal mucous membrane is all that is required. It is a common and dangerous mistake to over treat.

Of local antiseptics which are of use may be mentioned the actual cautery, chlorine water, freshly prepared silver nitrate or protargol, and the yellow oxide of mercury. These different agents are of course not all equally applicable in any given case; it depends upon the severity as well as upon the nature of the inflammation which is the most suitable. For instance, the actual cautery is employed only in the case of the deeper septic or malignant ulcers, in which the destruction of tissue is already considerable and tending to spread further. Again the yellow oxide of mercury should only be used in the more superficial, strumous forms of inflammation. Many other substances are also in use, but need not here be referred to.

Secondary keratitis takes the form of an interstitial deposit of leucocytes between the layers of the cornea as well as often of vascularization, sometimes intense, from the deeper network of vessels (anterior ciliary) surrounding the cornea. The duration of a secondary keratitis is usually prolonged, often lasting many months. More or less complete restoration of transparency is the rule, however, eventually.

No local treatment is called for except the shading of the eyes and in most cases the use of a mydriatic to prevent synechiae when the iris is involved. Often it is advisable to do something for the general health. In young people there is probably nothing better than cod-liver oil and syrup of the iodide of iron. Inherited syphilis, tuberculous and other inflammations are the causes of secondary keratitis.

Neuro-paralytic Keratitis.—When the fifth nerve is paralysed there is a tendency for the cornea to become inflamed. Different

forms of inflammation may then occur which all, besides anaesthesia, show a marked slowness in healing. The main cause of neuro-paralytic keratitis lies in the greater vulnerability of the cornea. The prognosis is necessarily bad. The treatment consists in as far as possible protecting the eye from external influences, by keeping it tied up, and by frequently irrigating with antiseptic lotions.

Certain non-inflammatory and degenerative changes are met with in the cornea. Of these may be mentioned *keratoconus* or conical cornea, in which, owing to some disturbance of vitality, the nature of which has not been discovered, the normal curvature of the cornea becomes altered to something more of a hyperboloid of revolution, with consequent impairment of vision: *arcus senilis*, a whitish opacity due to fatty degeneration, extending round the corneal margin, varying in thickness in different subjects and usually only met with in old people: *transverse calcareous film*, consisting of a finely punctiform opacity extending, in a tolerably uniformly wide band, occupying the zone of the cornea which is left uncovered when the lids are half closed.

Tumours of the cornea are not common. Those chiefly met with are dermoids, fibromata, sarcomata and epitheliomata.

Scleritis.—Inflammation of the sclera is confined to its anterior part which is covered by conjunctiva. Scleritis may occur in circumscribed patches or may be diffused in the shape of a belt round the cornea. The former is usually more superficial and uncomplicated, the latter deeper and complicated with corneal infiltration, irido-cyclitis and anterior choroiditis. Superficial scleritis or, as it is often called, *episcleritis*, is a long-continued disease which is associated with very varying degrees of discomfort. The chronic nature of the affection depends mainly upon the tendency that the inflammation has to recur in successive patches at different parts of the sclera. Often only one eye at a time is affected. Each patch lasts for a month or two and is succeeded by another after an interval of varying duration. Months or years may elapse between the attacks. The cicatricial site of a previous patch is rarely again attacked. The scleral infiltration causes a firm swelling, often sensitive to touch, over which the conjunctiva is freely movable. The overlying conjunctiva is always injected. The infiltration itself at the height of the process is densely vascularized. Seen through the conjunctiva its vessels have a darker, more purplish hue than the superficial ones. The swelling caused by the infiltration gradually subsides, leaving a cicatrix to which the overlying conjunctiva becomes adherent. The cicatrix has a slaty porcellanous-looking colour. Superficial scleritis occurs in both sexes with about equal frequency. No definite cause for the inflammation is known. The treatment on the whole is unsatisfactory. Burning down the nodules with the actual cautery, and subsequently a visit to such baths as Harrogate, Buxton, Homburg and Wiesbaden, may be recommended.

Deep scleritis with its attendant complications is altogether a more serious disease. Etiologically it is equally obscure. Both eyes are almost always attacked. It more generally occurs in young people, mostly in young women. Deep scleritis is more persistent and less subject to periods of intermission than episcleritis. The deeper and more wide-spread inflammatory infiltrations of the sclera lead eventually to weakening of that coat, and cause it to yield to the intra-ocular pressure. Vision suffers from extension of the infiltration to the cornea, or from iritis with its attendant synechiae, or from anterior choroiditis, and sometimes also from secondary glaucoma. The treatment is on the whole unsatisfactory. Iridectomy, especially if done early in the process, may be of use.

The Aqueous Humour.—Intransparency of the aqueous humour is always due to some exudation. This comes either from the iris or the ciliary processes, and may be blood, pus or fibrin. An exudation in this situation tends naturally to gravitate to the most dependent part, and, in the case of blood or pus, is known as *hyphaema* or *hypopyon*.

The Crystalline Lens Cataract.—Intransparency of the crystalline lens is technically known as *cataract*. Cataract may be idiopathic and uncomplicated, or traumatic, or secondary to

disease in the deeper parts of the eye. The modified epithelial structure of which the lens is composed is always being added to throughout life. The older portions of the lens are consequently the more central. They are harder and less elastic. This arrangement seems to predispose to difficulties of nutrition. In many people, in the absence altogether of general or local disease, the transparency of the lens is lost owing to degeneration of the incompletely-nourished fibres. This idiopathic cataract mostly occurs in old people; hence the term *senile cataract*. So-called *senile* cataract is not, however, necessarily associated with any general senile changes. An idiopathic uncomplicated cataract is also met with as a congenital defect due to faulty development of the crystalline lens. A particular and not uncommon form of this kind of cataract, which may also develop during infancy, is *lamellar* or *zonular cataract*. This is a partial and stationary form of cataract in which, while the greater part of the lens retains its transparency, some of the lamellae are intransparent. Traumatic cataract occurs in two ways: by laceration or rupture of the lens capsule, or by nutritional changes consequent upon injuries to the deeper structures of the eye. The transparency of the lens is dependent upon the integrity of its capsule. Penetrating wounds of the eye involving the capsule, or rupture of the capsule from severe blows on the eye without perforation of its coats, are followed by rapidly developing cataract. Severe non-penetrating injuries, which do not cause rupture of the capsule, are sometimes followed, after a time, by slowly-progressing cataract. Secondary cataract is due to abnormalities in the nutrient matter supplied to the lens owing to disease of the ciliary body, choroid or retina. In some diseases, as diabetes, the altered general nutrition tells in the same way on the crystalline lens. Cataract is then rapidly formed. All cases of cataract in diabetes are not, however, necessarily true diabetic cataracts in the above sense. *Dislocations of the lens* are traumatic or congenital. In old-standing disease of the eye the suspensory ligament may yield in part, and thus lead to lens dislocation. The lens is practically always cataractous before this takes place.

The Vitreous Humour.—The vitreous humour loses its transparency owing to exudation from the inflamed ciliary body or choroid. The exudation may be fibrinous or purulent; the latter only as a result of injuries by which foreign bodies or septic matter are introduced into the eye or in metastatic choroiditis. Blood may also be effused into the vitreous from rupture of retinal, ciliary or choroidal vessels. The pathological significance of the various effusions into the vitreous depends greatly upon the cause. In many cases effusion and absorption are constantly taking place simultaneously. The extent of possible clearing depends greatly upon the preponderance of the latter process.

Diseases of the Iris and Ciliary Body.—Inflammation of the iris, *iritis*, arises from different causes. The various idiopathic forms have relations to constitutional disturbances such as rheumatism, gout, albuminuria, tuberculosis, fevers, syphilis, gonorrhoea and others, or they may come from cold alone. Traumatic and infected cases are attributable to accidents, the presence of foreign bodies, operations, &c. In addition, iritis may be secondary to keratitis, scleritis or choroiditis. The beginning of an attack of inflammation of the iris is characterized by alterations in its colour due to hyperaemia and by circumcorneal injection. Later on, exudation takes place into the substance of the iris, causing thickening and also a loss of gloss of its surface. According to the nature and severity of the exudation there may be deposits formed on the back of the cornea, attachments between the iris and lens capsule (*synechiae*), or even gelatinous-looking coagulations or pus in the anterior chamber.

The subjective symptoms to which the inflammation may give rise are dread of light (*photophobia*), pain, generally most severe at night and often very great, also more or less impairment of sight. Along with the pain and photophobia there is lacrymation. An acute attack of iritis usually lasts about six weeks. Some cases become chronic and last much longer. Others are

chronic from the first, and in one clinical type of iritis, in which the ciliary body is also at the same time affected, viz. *iritis serosa*, there is usually comparatively little injection of the eye or pain, so that the patient's attention may only be directed to the eye owing to the gradual impairment of sight which results. In some cases, and more particularly in men, there is a tendency to the recurrence at longer or shorter intervals of attacks of iritis (*recurrent iritis*). In these cases, as well as in all cases of plastic iritis which have not been properly treated, serious consequences to sight are apt to follow from the binding down of the iris to the lens capsule and the occlusion of the pupil by exudation.

Inflammation of the ciliary body, *cyclitis*, is frequently associated with iritis. This association is probable in all cases where there are deposits on the posterior surface of the cornea. It is certain where there are changes in the intra-ocular tension. Often in cyclitis there is a very marked diminution in tension. Cyclitis is also present when the degree of visual disturbance is greater than can be accounted for by the visible changes in the pupil and anterior chamber. The exudation may, as in iritis, be serous, plastic or purulent. It passes from the two free surfaces of the ciliary body into the posterior aqueous, and into the vitreous, chambers. This produces, what is a constant sign of cyclitis, more or less intransparency of the vitreous humour. Where there has been excessive exudation into the vitreous, subsequent shrinking and liquefaction take place, leading to detachment of the retina and consequent blindness.

The treatment of iritis necessarily differs to some extent according to the cause. The general treatment applicable to all cases need only be here considered. What should be aimed at, at the time of the inflammation, is to put the eye as far as possible at rest, to prevent the formation of synechiae and alleviate the pain. An attempt should be made to get the pupil thoroughly dilated with atropine. The dilatation should be kept up as long as any circumcorneal injection lasts. If a case of iritis be left to itself or treated without the use of a mydriatic, posterior synechiae almost invariably form. Some fibrinous exudation may even organize into a membrane stretching across, and more or less completely occluding, the pupil. Synechiae, though not of themselves causing impairment of vision, increase the risk that the eye runs from subsequent attacks of iritis. It should however be remembered that as the main call for a mydriatic is to prevent synechiae, the *raison d'être* for its use no longer exists when, having been begun too late, the pupil cannot properly be dilated by it. Under these conditions it may even do harm. The eyes should also be kept shaded from the light by the use of a shade or neutral-tinted glasses. During an attack any use of the eyes for reading or sewing or work of any kind calling for accommodation must be prohibited. This applies equally to the case of inflammation in one eye alone and in both.

Pain is best relieved by hot fomentations, cocain, and in many cases the internal use of salicin or phenacetin. The treatment sometimes required for cases of old iritis is iridectomy. The operation is called for in two different classes of cases. In the first place, to improve vision where the pupil is small, and to a great extent occluded, though the condition has not so far led to serious nutritive changes; and in the second place, with the object as well of preventing the complete destruction of vision which either the existing condition or the danger of recurrence of the inflammation has threatened. Iridectomy for iritis should be performed when the inflammation has entirely subsided. The portion of iris excised should be large. The operation is urgently called for where the condition of *iris bombans* exists.

Iris tumours, either simple or malignant, are of rare occurrence.

A frequent result of a severe blow on the eye is a separation of a portion of the iris from its peripheral attachment (*iridodialysis*). Of congenital anomalies the most commonly met with are coloboma and more or less persistence of the foetal pupillary membrane. The most serious form of irido-cyclitis is that which may follow penetrating wounds of the eye. Under certain

conditions this leads to a similar inflammation in the other eye. This so-called *sympathetic ophthalmitis* is of a malignant type, causing destruction of the sympathizing eye.

The Retina.—Choroidal inflammations are generally patchy, various foci of inflammation being scattered over the choroid. These patches may in course of time become more or less confluent. The effect upon vision depends upon the extent to which the external or percipient elements of the retina become involved. It is especially serious when the more central portions of the retina are thus affected (*choroido-retinitis centralis*).

A peculiar and grave pathological condition of the eye is what is known as *glaucoma*. A characteristic of this condition is increase of the intra-ocular tension, which has a deleterious effect on the optic nerve end and its ramifications in the retina. The cause of the rise of tension is partly congestive, partly mechanical. The effect of glaucoma, when untreated, is to cause ever-increasing loss of sight, although the time occupied by the process before it leads to complete blindness varies within such extraordinary wide limits as from a few hours to many years. The uveal tract may be the site of *sarcoma*.

The retina is subject to inflammation, to detachment from the choroid, to haemorrhages from the blood-vessels and to tumour. Retinal inflammation may primarily affect either the nerve elements or the connective tissue framework. The former is usually associated with some general disease such as albuminuria or diabetes and is bilateral. The tissue changes are oedema, the formation of exudative patches, and haemorrhage. Where the connective tissue elements are primarily affected, the condition is a slow one, similar to *sclerosis* of the central nervous system. The gradual blindness which this causes is due to compression of the retinal nerve elements by the connective tissue hyperplasia, which is always associated with characteristic changes in the disposition of the retinal pigment. This retinal sclerosis is consequently generally known as *retinitis pigmentosa*, a disease to which there is a hereditary predisposition. Besides occurring during inflammation, haemorrhages into the retina are met with in phlebitis of the central retinal vein, which is almost invariably unilateral, and in certain conditions of the blood, as pernicious anaemia, when they are always bilateral.

The optic nerve is subject to inflammation (optic neuritis) and atrophy. Double optic neuritis, affecting, however, only the intra-ocular ends of the nerves, is an almost constant accompaniment of brain tumour. Unilateral neuritis has a different causation, depending upon an inflammation, mainly perineuritic, of the nerve in the orbit. It is analogous to peripheral inflammation of other nerves, such as the third, fourth, sixth and seventh cranial nerves.

Diseases of the Conjunctiva.—These are the most frequent diseases of the eye with which the surgeon has to deal. They generally lead to more or less interference with the functional activity of the eye and often indeed to great impairment of vision owing to the tendency which there is for the cornea to become implicated.

Many different micro-organisms are of pathogenetic importance in connexion with the conjunctiva. Microbes exist in the normal conjunctival sac. These are mostly harmless, though it is usual to find at any rate a small proportion of others which are known to be pyrogenetic. This fact is of great importance in connexion both with problems of etiology and the practical question of operations on the eye.

Hyperaemia.—When the conjunctiva becomes hyperaemic its colour is heightened and its transparency lessened. Sometimes too it becomes thickened and its surface altered in appearance. The often marked heightening of colour is due to the very superficial position of the dilated vessels. This is specially the case with that part of the membrane which forms the transition fold between the palpebral and the ocular conjunctiva. Consequently it is there that the redness is most marked, while it is seen to diminish towards the cornea. An important diagnostic mark is thus furnished between purely conjunctival hyperaemia and what is called circumcorneal congestion, which is always an indication of more deep-seated vascular dilatation. It also

differs materially from a scleral injection, in which there is a visible dilatation of the superficial scleral vessels.

When a conjunctival hyperaemia has existed for some time the papillae become swollen, and small blebs form on the surface of the membrane: sometimes too, lymph follicles begin to show. The enlargement and compression of adjacent papillae give rise to a velvety appearance of the surface.

Hyperaemia of the conjunctiva where not followed by inflammation causes more or less lacrymation but no alteration in the character of its secretion. The hyperaemia may be acute and transitory or chronic. Much depends upon the cause as well as upon the persistence of the irritation which sets it up.

Traumata, the presence of foreign bodies in the conjunctival sac, or the irritations of superficial chalky infarcts in the Meibomian ducts, cause more or less severe transitory congestion. Continued subjection to irritating particles such as flour, stones, dust, &c., causes a more continued hyperaemia which is often circumscribed and less pronounced. Bad air in schools, barracks, workhouses, &c., also causes a chronic hyperaemia in which it is common to find a follicular hyperplasia. Long exposure to too intense light, astigmatism and other ocular defects which cause asthenopia lead also to chronic hyperaemia. Anaemic individuals are often subject to discomfort from hyperaemia of this nature.

The treatment of conjunctival hyperaemia consists first in the removal of the cause when it can be discovered. Often this is difficult. In addition the application of hot sterilized water is useful and soothing.

Conjunctivitis.—When the conjunctiva is actually inflamed the congested membrane is brought into a condition of heightened secreting action. The secretions become more copious and more or less altered in character. A sufficiently practical though by no means sharply defined clinical division of cases of conjunctivitis is arrived at by taking into consideration the character of the secretion from the inflamed membrane and the visible tissue alterations which the membrane undergoes. The common varieties of conjunctivitis which may thus be distinguished are the following: (α) Catarrhal conjunctivitis, (β) Purulent conjunctivitis, (γ) Phlyctenular conjunctivitis, (δ) Granular conjunctivitis and (ε) Diphtheritic conjunctivitis.

However desirable a truly etiological classification might appear to be, it is doubtful whether such could satisfactorily be made. So much is certain at all events, that not only can identically the same clinical appearance result from the actions of quite different pathogenetic organisms, but that various concomitant circumstances may lead to very different clinical signs being set up by one and the same microbe. As regards *contagion* there is no doubt that the secretion in the case of a true conjunctivitis (*i.e.* not merely a hyperaemia) is always more or less contagious. The degree of virulence varies not only in different cases, but the effect of contagion from the same source may be different in different individuals. Healthy conjunctivae may thus react differently, not only as regards the degree of severity, but even according to different clinical types, when infected by secretion from the same source. There are no doubt different reasons for this, such as the stage at which the inflammation has arrived in the eye from which the secretion is derived, differences in the surroundings and in the susceptibility of the infected individuals, the presence of dormant microbes of a virulent type in the healthy conjunctiva which has been infected, &c. Many points in this connexion are very difficult to investigate and much remains to be elucidated. Contagion usually takes place directly and not through the air. Often in this way one eye is first affected and may in some cases, when sufficient care is afterwards taken, be the only one to suffer.

The treatment in all severer forms of conjunctivitis should be undertaken with the primary object in view of preventing any implication of the cornea.

Catarrhal conjunctivitis, which is characterized by an increased mucoid secretion accompanying the hyperaemia, is usually bilateral and may be either acute or chronic. Acute conjunctivitis lasts as a rule only for a week or two: the chronic type may persist, with or without occasional exacerbations, for

years. The subjective symptoms vary in intensity with the severity of the inflammation. There is always more or less troublesome "burning" in the eyes with a tired heavy feeling in the lids. This is aggravated by reading, which is most distressing in a close or smoky atmosphere and by artificial light. In acute cases, indeed, reading is altogether impossible. In all cases of catarrhal conjunctivitis the symptoms are also more marked if the eyes have been tied up, even though this may produce a temporary relief.

A curious variety of acute catarrhal conjunctivitis, in which the hyperaemia and lachrymation are the predominant features, is the so-called *hay-fever*. In this condition the mucous membrane of the nose and throat are similarly affected, and there is at the same time more or less constitutional disturbance. Hay-fever is due to irritation from the pollen of many plants, but principally from that of the different grasses. Some people are so susceptible to it that they invariably suffer every year during the early summer months. Here it is difficult to remove the cause, but many cases can be cured and almost all are alleviated by means of a special antitoxin applied locally.

Other ectogenetic causes of catarrhal conjunctivitis which have been studied are mostly microbial. Of these the most common are the *Morax-Axenfeld* and the *Koch-Weeks* conjunctivitis.

The *Morax-Axenfeld* bacillus sets up a conjunctivitis which affects individuals of all ages and conditions and which is contagious. The inflammation is usually chronic, at most subacute. It is often sufficiently characteristic to be recognized without a microscopical examination of the secretions. In typical cases the lid margin, palpebral conjunctiva, and it may be a patch of ocular conjunctiva at the outer or inner angle are alone hyperaemic: the secretion is not copious and is mostly found as a greyish coagulum lying at the inner lid-margin. The subjective symptoms are usually slight. Complications with other varieties of catarrhal conjunctivitis are not uncommon. This mild form of conjunctivitis generally lasts for many months, subject to more or less complete disappearance followed by recurrences. It can be rapidly cured by the use of an oxide of zinc ointment, which should be continued for some time after the appearances have altogether passed off.

The conjunctivitis caused by the *Koch-Weeks* microbe is still more common. It is a more acute type, affects mostly children, and is very contagious and often epidemic. Here the hyperaemia involves both the ocular and the palpebral conjunctiva, and usually there is considerable swelling of the lids and a copious secretion. Both eyes are always affected. Occasionally the engorged conjunctival vessels give way, causing numerous small extravasations (ecchymoses). Complications with phlyctenulae (*vide infra*) are common in children. The acute symptoms last for a week or ten days, after which the course is more chronic. Treatment with nitrate of silver in solution is generally satisfactory. Other less frequent microbial causes of catarrhal conjunctivitis yield to the same treatment.

A form of *epidemic muco-purulent conjunctivitis* is not uncommon, in which the swelling of the conjunctival folds and lids is much more marked and the secretions copious. It is less amenable to treatment and also apt to be complicated by corneal ulceration. The microbe which gives rise to this condition has not been definitely established. This inflammation is also known as *school ophthalmia*. This is extremely contagious, so that isolation of cases becomes necessary. The treatment with weak solutions of sub-acetate of lead during the acute stage, provided there be no corneal complication, and subsequently with a weak solution of tannic acid, may be recommended.

Purulent Conjunctivitis.—Some of the severer forms of catarrhal conjunctivitis are accompanied not only by a good deal of swelling of both conjunctiva and lids but also by a decidedly muco-purulent secretion. Nevertheless there is a sufficiently sharply-defined clinical difference between the catarrhal and purulent types of inflammation. In purulent conjunctivitis the oedema of the lids is always marked, often

excessive, the hyperaemia of the whole conjunctiva is intense: the membrane is also infiltrated and swollen (chemosis), the papillae enlarged and the secretion almost wholly purulent. Although this variety of conjunctivitis is principally due to infection by gonococci, other microbes, which more frequently set up a catarrhal type, may lead to the purulent form.

All forms are contagious, and transference of the secretion to other eyes usually sets up the same type of severe inflammation. The way in which infection mostly takes place is by direct transference by means of the hands, towels, &c., of secretions containing gonococci either from the eye or from some other mucous membrane. The poison may also sometimes be carried by flies. The dried secretion loses its virulence.

In new-born children (*ophthalmia neonatorum*) infection takes place from the maternal passages during birth. Notwithstanding the great changes which occur during the progress of a purulent conjunctivitis, there is on recovery a complete *restitutio ad integrum* so far as the conjunctiva is concerned. Owing to the tendency to severe ulceration of the cornea, more or less serious destructions of that membrane, and consequently more or less interference with sight, may result before the inflammation has passed off. This is a special danger in the case of adults. For this reason when only one eye is affected the first point to be attended to in the treatment is to secure the second eye from contagion by efficient occlusion. The appliance known as Buller's shield, a watch-glass strapped down by plaster, is the best for this purpose. It not only admits of the patient seeing with the sound eye, but allows the other to remain under direct observation. The treatment otherwise consists in frequent removal of the secretions from the affected eye, and the use of nitrate of silver solution as a bactericide applied directly to the conjunctival surface; sometimes it is necessary to cut away the chemotic conjunctiva immediately surrounding the cornea. When the cornea has become affected efforts may be made with the thermo-cautery or otherwise to limit the area of destruction and thus admit of something being done to improve the vision after all inflammation has subsided. The greatest cleanliness as well as proper antiseptic precautions should of course be observed by every one in any way connected with the treatment of such cases.

Phlyctenular conjunctivitis is an acute inflammation of the ocular conjunctiva, in which little blebs or phlyctenules form, more particularly in the vicinity of the corneal margin, as well as on the epithelial continuation of the conjunctiva which covers the cornea. The inflammation is characterized by being distributed in little circumscribed foci and not diffused as in all other forms of conjunctivitis. In it the conjunctival secretion is not altered, unless there should exist at the same time a complication with some other form of conjunctivitis. This condition is most frequent in children, particularly such as are ill-nourished or are recovering from some illness, e.g. measles. The susceptibility occurs in fact mainly where there exists what used to be called a "strumous" diathesis. In many cases, therefore, there is some kind of tubercular basis for the manifestations. This basis has to do with the susceptibility only, at all events to begin with. The local changes are not tuberculous; their exact origin has not been clearly established. They are in all probability produced by staphylococci.

Many children suffering from phlyctenular conjunctivitis get after a short time an eczematous excoriation of the skin of the nostrils. This excoriated, scabby area contains crowds of staphylococci which find a nidus here, where the copious tear-flow down the nostrils has excoriated and irritated the skin. Lachrymation is indeed a very common concomitant of phlyctenular conjunctivitis. Another frequently distressing symptom is a pronounced dread of light (*photophobia*), which often leads to convulsive and very persistent closing of the lids (*blepharospasm*). Indeed the relief of the photophobia is often the most important point to be considered in the treatment of phlyctenular conjunctivitis. The photophobia may be very severe when the local changes are slight. The eyes should be shaded but not bandaged. Cocain may be freely used. The best

local application is the yellow oxide of mercury used as an ointment.

Phlyctenular conjunctivitis, and the corneal complications with which it is so often associated, constitute a large proportion (from $\frac{1}{4}$ to $\frac{1}{3}$) of all eye affections with which the surgeon has to deal.

Granular Conjunctivitis.—This disease, which also goes by the name of *trachoma*, is characterized by an inflammatory infiltration of the adenoid tissue of the conjunctiva. The inflammation is accompanied by the formation of so-called *granules*, and at the same time by a hyperplasia of the papillae. The changes further lead in the course of time to cicatricial transformations, so that a gradual and progressive atrophy of the conjunctiva results. The disease takes its origin most frequently in the conjunctival fold of the upper lid, but eventually as a rule involves the cornea and the deeper tissues of the lid, particularly the tarsus.

The etiology of trachoma is unknown. Though a perfectly distinctive affection when fully established, the differential diagnosis from other forms of conjunctivitis, particularly those associated with much follicular enlargement or which have begun as purulent inflammation, may be difficult. Trachoma is mostly chronic. When occurring in an acute form it is more amenable to treatment and less likely to end in cicatricial changes. Fully half the cases of trachoma which occur are complicated by *pannus*, which is the name given to the affection when it has spread to the cornea. Pannus is a superficial vascularized infiltration of the cornea. The veiling which it produces causes more or less defect of sight.

Various methods of treatment are in use for trachoma. Expression by means of roller-forceps or repeated grattage are amongst the more effective means of surgical treatment, while local applications of copper sulphate or of alum are certainly useful in suitable cases.

Diphtheritic conjunctivitis is characterized by an infiltration into the conjunctival tissues which, owing to great coagulability, rapidly interferes with the nutrition of the invaded area and thus leads to necrosis of the diphtheritic membrane. Conjunctival diphtheria may or may not be associated with diphtheria of the throat. It is essentially a disease of early childhood, not more than 10% of all cases occurring after the age of four. The cornea is exposed to great risk, more particularly during the first few days, and may be lost by necrosis. Subsequent ulceration is not uncommon, but may often be arrested before complete destruction has taken place. The disease is generally confined to one eye, and complicated by swelling of the preauricular glands of that side. It may prove fatal. In true conjunctival diphtheria the exciting cause is the Klebs-Löffler bacillus. The inflammation occurs in very varying degrees of severity. The secretion is at first thin and scant, afterwards purulent and more copious. In severe cases there is great chemosis with much tense swelling of the lids, which are often of an ashy-grey colour. A streptococcus infection produces somewhat similar and often quite as disastrous results.

The treatment must be both general with antitoxin and local with antiseptics. Of rarer forms of conjunctivitis may be mentioned Parinaud's conjunctivitis and the so-called spring catarrh.

Non-inflammatory Conjunctival Affections.—These are of less importance than conjunctivitis, either on account of their comparative infrequency or because of their harmlessness. The following conditions may be shortly referred to.

Amyloid degeneration, in which waxy-looking masses grow from the palpebral conjunctiva of both lids, often attaining very considerable dimensions. The condition is not uncommon in China and elsewhere in the East.

Essential Shrinking of the Conjunctiva.—This is the result of pemphigus, in which the disease has attacked the conjunctiva and led to its atrophy.

Pterygium is a hypertrophic thickening of the conjunctiva of triangular shape firmly attached by its apex to the superficial layers of the cornea. It is a common condition in warm climates

owing to exposure to sun and dust, and often calls for operative interference.

Tumours of the Conjunctiva.—These may be malignant or benign, also syphilitic and tubercular. (G. A. BE.)

EYEMOUTH, a police burgh of Berwickshire, Scotland. Pop. (1901) 2436. It is situated at the mouth of the Eye, $7\frac{1}{2}$ m. N.N.W. of Berwick-on-Tweed by the North British railway via Burnmouth. Its public buildings are the town hall, library and masonic hall. The main industry is the fishing and allied trades. The harbour was enlarged in 1887, and the bay is easily accessible and affords good anchorage. Owing to the rugged character of the coast and its numerous ravines and caves the whole district was once infested with smugglers. The promontory of St Abb's Head is 3 m. to the N.W.

EYLAU (*Preussisch-Eylau*), a town of Germany, in east Prussia, on the Pasmur, 23 m. S. by E. of Königsberg by rail on the line Pillau-Prostken. It has an Evangelical church, a teachers' seminary, a hospital, foundries and saw mills. Pop. 3200. Eylau was founded in 1336 by Arnolf von Eilenstein, a knight of the Teutonic Order. It is famous as the scene of a battle between the army of Napoleon and the Russians and Prussians commanded by General Bennigsen, fought on the 8th of February 1807.

The battle was preceded by a severe general engagement on the 7th. The head of Napoleon's column (cavalry and infantry), advancing from the south-west, found itself opposed at the outlet of the Grünhöfchen defile by a strong Russian rearguard which held the (frozen) lakes on either side of the Eylau road, and attacked at once, dislodging the enemy after a sharp conflict. The French turned both wings of the enemy, and Bagration, who commanded the Russian rearguard, retired through Eylau to the main army, which was now arrayed for battle east of Eylau. Barclay de Tolly made a strenuous resistance in Eylau itself, and in the churchyard, and these localities changed hands several times before remaining finally in possession of the French. It is very doubtful whether Napoleon actually ordered this attack upon Eylau, and it is suggested that the French soldiers were encouraged to a premature assault by the hope of obtaining quarters in the village. There is, however, no reason to suppose that this attack was prejudicial to Napoleon's chance of success, for his own army was intended to pin the enemy in front, while the outlying "masses of manoeuvre" closed upon his flanks and rear (see NAPOLEONIC CAMPAIGNS). In this case the vigour of the "general advanced guard" was superfluous, for Bennigsen stood to fight of his own free will.

The foremost line of the French bivouacs extended from Rothenen to Freiheit, but a large proportion of the army spent the night in quarters farther back. The Russian army on the other hand spent the night bivouacked in order of battle, the right at Schloditten and the left at Serpallen. The cold was extreme, 2° F. being registered in the early morning, and food was scarce in both armies. The ground was covered at the time of battle with deep snow, and all the lakes and marshes were frozen, so that troops of all arms could pass everywhere, so far as the snow permitted. Two of Napoleon's corps (Davout and Ney) were still absent, and Ney did not receive his orders until the morning of the 8th. His task was to descend upon the Russian right, and also to prevent a Prussian corps under Lestocq from coming on to the battlefield. Davout's corps advancing from the south-east on Mollwitten was destined for the attack of Bennigsen's left wing about Serpallen and Klein Sausgarten. In the meantime Napoleon with his forces at and about Eylau made the preparations for the frontal attack. His infantry extended from the windmill, through Eylau, to Rothenen, and the artillery was deployed along the whole front; behind each infantry corps and on the wings stood the cavalry. The Guard was in second line south of Eylau, and an army reserve stood near the Waschkeiten lake. Bennigsen's army was drawn up in line from Schloditten to Klein Sausgarten, the front likewise covered by guns, in which arm he was numerically much superior. A detachment occupied Serpallen.

The battle opened in a dense snowstorm. About 8 A.M.

Bennigsen's guns opened fire on Eylau, and after a fierce but undecided artillery fight the French delivered an infantry attack from Eylau. This was repulsed with heavy losses, and the Russians advanced towards the windmill in force. Thereupon Napoleon ordered his centre, the VII. corps of Augéreau, to move forward from the church against the Russian front, the division of St Hilaire on Augéreau's right participating in the attack. If we conceive of this first stage of the battle as the action of the "general advanced guard," Augéreau must be held to have overdone his part. The VII. corps advanced in dense masses, but in the fierce snowstorm lost its direction. St Hilaire attacked directly and unsupported; Augéreau's corps was still less fortunate. Crossing obliquely the front of the Russian line, as if making for Schloditten, it came under a *feu d'enfer* and was practically annihilated. In the confusion the Russian cavalry charged with the utmost fury downhill and with the wind behind them. Three thousand men only out of about fourteen thousand appeared at the evening parade of the corps. The rest were killed, wounded, prisoners or dispersed. The marshal and every senior officer was amongst the killed and wounded, and one regiment, the 14th of the Line, cut off in the midst of the Russians and refusing to surrender, fell almost to a man. The Russian

line extended from the church to Kutschitten. The Russian army was being driven westward, when the advance of Lestocq gave them fresh steadiness. The Prussian corps had been fighting a continuous flank-guard action against Marshal Ney to the north-west of Althof, and Lestocq had finally succeeded in disengaging his main body, Ney being held up at Althof by a small rearguard, while the Prussians, gathering as they went the fugitives of the Russian army, hastened to oppose Davout. The impetus of these fresh troops led by Lestocq and his staff-officer Scharnhorst was such as to check even the famous divisions of Davout's corps which had won the battle of Auerstädt single-handed. The French were now gradually forced back until their right was again at Sausgarten and their centre on the Kreege Berg.

Both sides were now utterly exhausted, for the Prussians also had been marching and fighting all day against Ney. The battle died away at nightfall, Ney's corps being unable effectively to intervene owing to the steadiness of the Prussian detachment left to oppose him, and the extreme difficulty of the roads. A severe conflict between the Russian extreme right and Ney's corps which at last appeared on the field at Schloditten ended the battle. Bennigsen retreated during the night through Schmoditten, Lestocq through Kutschitten. The numbers engaged in the first stage of the battle may be taken as—Napoleon, 50,000, Bennigsen, 67,000, to which later were added on the one side Ney and Davout, 29,000, on the other Lestocq, 7000. The losses were roughly, 15,000 men to the French, 18,000 to the Allies, or 21 and 27% respectively of the troops actually engaged. The French lost 5 eagles and 7 other colours, the Russians 16 colours and 24 guns.

EYRA (*Felis eyra*), a South American wild cat, of weasel-like build, and uniform coloration, varying in different individuals from reddish-yellow to chestnut. It is found in Brazil, Guiana and Paraguay, and extends its range to the Rio del Norte, but is rare north of the isthmus of Panama. Little is known of its habits in a wild state, beyond the fact that it is a forest-dweller, active in movement and fierce in disposition. Several have been exhibited in the London Zoological Gardens, and some have grown gentle in captivity. Don Felix de Azara wrote of one which he kept on a chain that it was "as gentle and playful as any kitten could be." The name is sometimes applied to the jaguarondi.

EYRE, EDWARD JOHN (1815–1901), British colonial governor, the son of a Yorkshire clergyman, was born on the 5th of August 1815. He was intended for the army, but delays having arisen in producing a commission, he went out to New South Wales, where he engaged in the difficult but very necessary undertaking of transporting stock westward to the new colony of South Australia, then in great distress, and where he became magistrate and protector of the aborigines, whose interests he warmly advocated. Already experienced as an Australian traveller, he undertook the most extensive and difficult journeys in the desert country north and west of Adelaide, and after encountering the greatest hardships, proved the possibility of land communication between South and West Australia. In 1845 he returned to England and published the narrative of his travels. In 1846 he was appointed lieutenant-governor of New Zealand, where he served under Sir George Grey. After successively governing St Vincent and Antigua, he was in 1862 appointed acting-governor of Jamaica and in 1864 governor. In October 1865 a negro insurrection broke out and was repressed with laudable vigour, but the unquestionable severity and alleged illegality of Eyre's subsequent proceedings raised a storm at home which induced the government to suspend him and to despatch a special commission of investigation, the effect of whose inquiries, declared by his successor, Sir John Peter Grant, to have been "admirably conducted," was that he should not be reinstated in his office. The government, nevertheless, saw nothing in Eyre's conduct to justify legal proceedings; indictments preferred by amateur prosecutors at home against him and military officers who had acted under his direction, resulted in failure, and he retired upon the pension of a colonial governor. As an

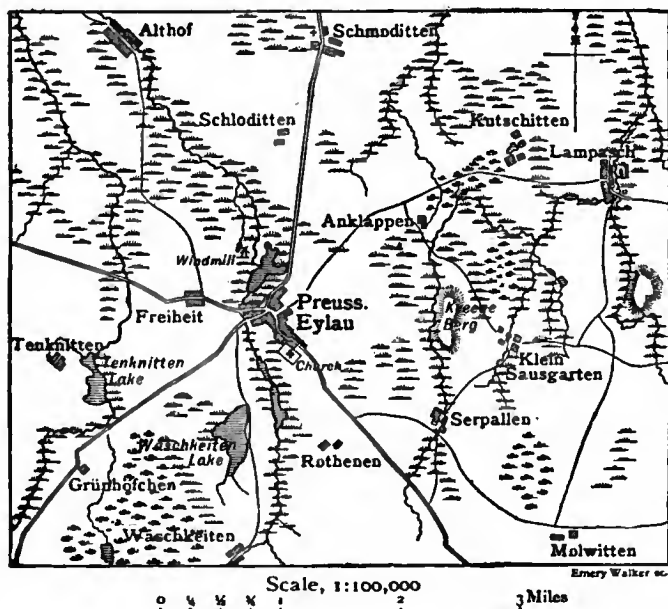

counterstroke penetrated into Eylau itself and Napoleon himself was in serious danger. With the utmost coolness, however, he judged the pace of the Russian advance and ordered up a battalion of the Guard at the exact moment required. In the streets of Eylau the Guard had the Russians at their mercy, and few escaped. Still the situation for the French was desperate and the battle had to be maintained at all costs. Napoleon now sent forward the cavalry along the whole line. In the centre the charge was led by Murat and Bessières, and the Russian horsemen were swept off the field. The Cuirassiers under D'Hautpoult charged through the Russian guns, broke through the first line of infantry and then through the second, penetrating to the woods of Anklappen.

The shock of a second wave of cavalry broke the lines again, and though in the final retirement the exhausted troopers lost terribly, they had achieved their object. The wreck of Augéreau's and other divisions had been reformed, the Guard brought up into first line, and, above all, Davout's leading troops had occupied Serpallen. Thence, with his left in touch with Napoleon's right (St Hilaire), and his right extending gradually towards Klein Sausgarten, the marshal pressed steadily upon the Russian left, rolling it up before him, until his right had reached Kutschitten and his centre Anklappen. By that time the troops under Napoleon's immediate command, pivoting their left on Eylau church, had wheeled gradually inward until the general

explorer Eyre must be classed in the highest rank, but opinions are always likely to differ as to his action in the Jamaica rebellion. He died on the 30th of November 1901.

EYRE, SIR JAMES (1734-1799), English judge, was the son of the Rev. Thomas Eyre, of Wells, Somerset. He was educated at Winchester College and at St John's College, Oxford, which, however, he left without taking a degree. He was called to the bar at Gray's Inn in 1755, and commenced practice in the lord mayor's and sheriffs' courts, having become by purchase one of the four counsel to the corporation of London. He was appointed recorder of London in 1763. He was counsel for the plaintiff in the case of *Wilkes v. Wood*, and made a brilliant speech in condemnation of the execution of general search warrants. His refusal to voice the remonstrances of the corporation against the exclusion of Wilkes from parliament earned him the recognition of the ministry, and he was appointed a judge of the exchequer in 1772. From June 1792 to January 1793 he was chief commissioner of the great seal. In 1793 he was made chief justice of the common pleas, and presided over the trials of Horne Tooke, Thomas Crosfield and others, with great ability and impartiality. He died on the 1st of July 1799 and was buried at Ruscombe, Berkshire.

See Howell, *State Trials*, xix. (1154-1155); Foss, *Lives of the Judges*.

EYRIE, the alternative English form of the words Aerie or Aery, the lofty nest of a bird of prey, especially of an eagle, hence any lofty place of abode; the term is also used of the brood of the bird. The word derives from the Fr. *aire*, of the same meaning, which comes from the Lat. *arca*, an open space, but was early connected with *aërius*, high in the air, airy, a confusion that has affected the spelling of the word. The forms "eyrie" or "eyry" date from a 17th century attempt to derive the word from the Teutonic *ey*, an egg.

EZEKIEL (זְכַרְיָהּ, "God strengthens" or "God is strong"; Sept. Ἰεζεκιήλ; Vulg. Ezechiel), son of Buzi, one of the most vigorous and impressive of the older Israelite thinkers. He was a priest of the Jerusalem temple, probably a member of the dominant house of Zadok, and doubtless had the literary training of the cultivated priesthood of the time, including acquaintance with the national historical, legal and ritual traditions and with the contemporary history and customs of neighbouring peoples. In the year 597 (being then, probably, not far from thirty years of age) he was carried off to Babylonia by Nebuchadrezzar with King Jehoiachin and a large body of nobles, military men and artisans, and there, it would seem, he spent the rest of his life. His prophecies are dated from this year ("our captivity," xl. 1), except in i. 1, where the meaning of the date "thirtieth year" is obscure; it cannot refer to his age (which would be otherwise expressed in Hebrew), or to the reform of Josiah, 621 (which is not elsewhere employed as an epoch); possibly the reference is to the era of Nabopolassar (626 according to the Canon of Ptolemy), if chronological inexactness be supposed (34 or 33 years instead of 30), a supposition not at all improbable. That the word "thirtieth" is old, appears from the fact that a scribe has added a gloss (*vv.* 2, 3) to bring this statement into accord with the usual way of reckoning in the book: the "thirtieth" year, he explains, is the fifth year of the captivity of Jehoiachin. The exiles dwelt at Tell-abib ("Hill of the flood"), one of the mounds or ruins made by the great floods that devastated the country,¹ near the "river" Chebar (Kebar), probably a large canal not far south of the city of Babylon. Here they had their own lands, and some form of local government by elders, and appear to have been prosperous and contented; probably the only demand made on them by the Babylonian government was the payment of taxes.

Ezekiel was married (xxiv. 18), had his own house, and comported himself quietly as a Babylonian subject. But he was a profoundly interested observer of affairs at home and among

¹ The Assyrian term *abubu* is used of the great primeval deluge (in the Gilgamesh epic), and also of the local floods common in the country.

the exiles: as patriot and ethical teacher he deplored alike the political blindness of the Jerusalem government (King Zedekiah revolted in 588) and the immorality and religious superficiality and apostasy of the people. He, like Jeremiah, was friendly to Nebuchadrezzar, regarding him as Yahweh's instrument for the chastisement of the nation. Convinced that opposition to Babylonian rule was suicidal, and interpreting historical events, in the manner of the times, as indications of the temper of the deity, he held that the imminent political destruction of the nation was proof of Yahweh's anger with the people on account of their moral and religious depravity; Jerusalem was hopelessly corrupt and must be destroyed (xxiv.). On the other hand, he was equally convinced that, as his predecessors had taught (Hos. xi. 8, 9; Isa. vii. 3 *al.*), Yahweh's love for his people would not suffer them to perish utterly—a remnant would be saved, and this remnant he naturally found in the exiles in Babylonia, a little band plucked from the burning and kept safe in a foreign land till the wrath should have passed (xi. 14 ff.). This conception of the exiles as the kernel of the restored nation he further set forth in the great vision of ch. i., in which Yahweh is represented as leaving Jerusalem and coming to take up his abode among them in Babylonia for a time, intending, however, to return to his own city (xliii. 7).

This, then, was Ezekiel's political creed—destruction of Jerusalem and its inhabitants, restoration of the exiles, and meantime submission to Babylon. His arraignment of the Judeans is violent, almost malignant (vi. xvi. *al.*). The well-meaning but weak king Zedekiah he denounces with bitter scorn as a perjured traitor (xvii.). He does not discuss the possibility of successful resistance to the Chaldeans; he simply assumes that the attempt is foolish and wicked, and, like other prophets, he identifies his political programme with the will of God. Probably his judgment of the situation was correct; yet, in view of Sennacherib's failure at Jerusalem in 701 and of the admitted strength of the city, the hope of the Jewish nobles could not be considered wholly unfounded, and in any case their patriotism (like that of the national party in the Roman siege) was not unworthy of admiration. The prophet's predictions of disaster continued, according to the record, up to the investment of the city by the Chaldean army in 588 (i. xxiv.); after the fall of the city (586) his tone changed to one of consolation (xxxiii.-xxxix.)—the destruction of the wicked mass accomplished, he turned to the task of reconstruction. He describes the safe and happy establishment of the people in their own land, and gives a sketch of a new constitution, of which the main point is the absolute control of public religion by the priesthood (xl.-xlviii.).

The discourses of the first period (i.-xxiv.) do not confine themselves to political affairs, but contain much interesting ethical and religious material. The picture given of Jerusalemite morals is an appalling one. Society is described as honeycombed with crimes and vices; prophets, priests, princes and the people generally are said to practise unblushingly extortion, oppression, murder, falsehood, adultery (xxii.). This description is doubtless exaggerated. It may be assumed that the social corruption in Jerusalem was such as is usually found in wealthy communities, made bolder in this case, perhaps, by the political unrest and the weakness of the royal government under Zedekiah. No such charges are brought by the prophet against the exiles, in whose simple life, indeed, there was little or no opportunity for flagrant violation of law. Ezekiel's own moral code is that of the prophets, which insists on the practice of the fundamental civic virtues. He puts ritual offences, however, in the same category with offences against the moral law, and he does not distinguish between immorality and practices that are survivals of old recognized customs: in ch. xxii. he mentions "eating with the blood"² along with murder, and failure to observe ritual regulations along with oppression of the fatherless and the widow; the old customary law permitted marriage with a half-sister (father's daughter), with a daughter-in-law, and with a father's wife (Gen. xx. 12, xxxviii. 26; 2 Sam. xvi. 21, 22), but the more refined

² So we must read (as Robertson Smith has pointed out) in xxii. 9 and xviii. 6, instead of "eating on the mountains."

feeling of the later time frowned on the custom, and Ezekiel treats it as adultery.¹ However, notwithstanding the insistence on ritual, natural in a priest, his moral standard is high; following the prescription of Ex. xxii. 21 [20] he regards oppression of resident aliens (a class that had not then received full civil rights) as a crime (xxii. 7), and in his new constitution (xlvi. 22, 23) gives them equal rights with the homeborn. His strongest denunciation is directed against the religious practices of the time in Judea—the worship of the Canaanite local deities (the Baals), the Phœnician Tammuz, and the sun and other Babylonian and Assyrian gods (vi., viii., xvi., xxiii.); he maintained vigorously the prophetic struggle for the sole worship of Yahweh. Probably he believed in the existence of other gods, though he does not express himself clearly on this point; in any case he held that the worship of other deities was destructive to Israel. His conception of Yahweh shows a mingling of the high and the low. On the one hand, he regards him as supreme in power, controlling the destinies of Babylonia and Egypt as well as those of Israel, and as inflexibly just in dealing with ordinary offences against morality. But he conceives of him, on the other hand, as limited locally and morally—as having his special abode in the Jerusalem temple, or elsewhere in the midst of the Israelite people, and as dealing with other nations solely in the interests of Israel. The bitter invectives against Ammon, Moab, Edom, Philistia, Tyre, Sidon and Egypt, put into Yahweh's mouth, are based wholly on the fact that these peoples are regarded as hostile and hurtful to Israel; Babylonia, though nowise superior to Egypt morally, is favoured and applauded because it is believed to be the instrument for securing ultimately the prosperity of Yahweh's people. The administration of the affairs of the world by the God of Israel is represented, in a word, as determined not by ethical considerations but by personal preferences. There is no hint in Ezekiel's writings of the grandiose conception of Isa. xl. 4-5, that Israel's mission is to give the knowledge of religious truth to the other nations of the world; he goes so far as to say that Yahweh's object in restoring the fortunes of Israel is to establish his reputation among the nations as a powerful deity (xxxvi. 20-23, xxxvii. 28, xxxix. 23). The prophet regards Yahweh's administrative control as immediate: he introduces no angels or other subordinate supernatural agents—the cherubs and the "men" of ix. 2 and xl. 3 are merely imaginative symbols or representations of divine activity. His high conception of God's transcendence, it may be supposed, led him to ignore intermediary agencies, which are common in the popular literature, and later, under the influence of this same conception of transcendence, are freely employed.

The relations between the writings of Ezekiel and those of Jeremiah is not clear. They have so much in common that they must have drawn from the same current bodies of thought, or there must have been borrowing in one direction or the other. In one point, however,—the attitude toward the ritual—the two men differ radically. The finer mind of the nation, represented mainly by the prophets from Amos onward, had denounced unsparingly the superficial non-moral popular cult. The struggle between ethical religion and the current worship became acute toward the end of the 7th century. There were two possible solutions of the difficulty. The ritual books of our Pentateuch were not then in existence, and the sacrificial cult might be treated with contempt as not authoritative. This is the course taken by Jeremiah, who says boldly that God requires only obedience (Jer. vii. 21 ff.). On the other hand the better party among the priests, believing the ritual to be necessary, might undertake to moralize it; of such a movement, begun by Deuteronomy, Ezekiel is the most eminent representative. Priest and prophet, he sought to unify the national religious consciousness by preserving the sacrificial cult, discarding its abuses and vitalizing it ethically. The event showed that he judged the situation rightly—the religious scheme announced by him, though not accepted in all its details, became the dominant policy of the later time, and he has been justly called

¹The stricter marriage law is formulated in Lev. xviii. 8-15, xx. 11 ff.

"the father of Judaism." He speaks as a legislator, citing no authority; but he formulates, doubtless, the ideas, and perhaps the practices of the Jerusalem priesthood. His ritual code (xliii.-xlvi.), which in elaborateness stands midway between that of Deuteronomy and that of the middle books of the Pentateuch (resembling most nearly the code of Lev. xvii.-xxvi.) shows good judgment. Its most noteworthy features are two. Certain priests of idolatrous Judean shrines (distinguished by him as "Levites") he deprives of priestly functions, degrading them to the rank of temple menials; and he takes from the civil ruler all authority over public religion, permitting him merely to furnish material for sacrifices. He is, however, much more than a ritual reformer. He is the first to express clearly the conception of a sacred nation, isolated by its religion from all others, the guardian of divine law and the abode of divine majesty. This kingdom of God he conceives of as moral: Yahweh is to put his own spirit into the people,² creating in them a disposition to obey his commandments, which are moral as well as ritual (xxxvi. 26, 27). The conception of a sacred nation controlled the whole succeeding Jewish development; if it was narrow in its exclusive regard for Israel, its intensity saved the Jewish religion to the world.

Text and Authorship.—The Hebrew text of the book of Ezekiel is not in good condition—it is full of scribal inaccuracies and additions. Many of the errors may be corrected with the aid of the Septuagint (e.g. the 430—390+40—of iv. 5, 6 is to be changed to 190), and none of them affect the general thought. The substantial genuineness of the discourses is now accepted by the great body of critics. The Talmudic tradition (*Baba Bathra* 14b) that the men of the Great Synagogue "wrote" Ezekiel, may refer to editorial work by later scholars.³ There is no validity in the objections of Zunz (*Gottesdienstl. Vortr.*) that the specific prediction concerning Zedekiah (xii. 12 f.) is non-Prophetic, and that the drawing-up of a new constitution soon after the destruction of the city and the mention of Noah, Daniel, Job and Persia are improbable. The prediction in question was doubtless added by Ezekiel after the event; the code belongs precisely in his time, and the constitution was natural for a priest; Noah, Daniel and Job are old legendary Hebrew figures; and it is not probable that the prophet's "Paras" is our "Persia." Havet's contention (in *La Modernité des prophètes*) that Gog represents the Parthians (40 B.C.) has little or nothing in its support. There are additions made *post eventum*, as in the case mentioned above and in xxix. 17-20, and the description of the commerce of Tyre (xxvii. 9b-25a), which interrupts the comparison of the city to a ship, looks like an insertion whether by the prophet or by some other; but there is no good reason to doubt that the book is substantially the work of Ezekiel. Ezekiel's style is generally impetuous and vigorous, somewhat smoother in the consolatory discourses (xxxiv., xxxvi., xxxvii.); he produces a great effect by the cumulation of details, and is a master of invective; he is fond of symbolic pictures, proverbs and allegories; his "visions" are elaborate literary productions, his prophecies show less spontaneity than those of any preceding prophet (he receives his revelations in the form of a book, ii. 9), and in their present shape were hardly pronounced in public—a fact that seems to be hinted at in the statement that he was "dumb" till the fall of Jerusalem (iii. 26, xxxiii. 22); in private interviews the people did not take him seriously (xxxiii. 30-33). His book was accepted early as part of the sacred literature: Ben-Sira (c. 180 B.C.) mentions him along with Isaiah and Jeremiah (Ecclus. xlix. 8); he is not quoted directly in the New Testament, but his imagery is employed largely in the Apocalypse and elsewhere. His divergencies from the Pentateuchal code gave rise to serious doubts, but, after prolonged study, the discrepancies were explained, and the book was finally canonized (Shab. 13b). According to

²Yahweh's spirit, thought of as Yahweh's vital principle, as man's spirit is man's vital principle, is to be breathed into them, as, in Gen. ii. 7, Yahweh breathes his own breath into the lifeless body. The spirit in the Old Testament is a refined material thing that may come or be poured out on men.

³The "Great Synagogue" is semi-mythical.

Jerome (Preface to *Comm. on Ezek.*) the Jewish youth were forbidden to read the mysterious first chapter (called the *markaba*, the "chariot") and the concluding section (xl.-xlviii.) till they reached the age of thirty years.

The book divides itself naturally into three parts: the arraignment of Jerusalem (i.-xxiv.); denunciation of foreign enemies (xxv.-xxxii.); consolatory construction of the future (xxxiii.-xlviii.). The opening "vision" (i.), an elaborate symbolic picture, is of the nature of a general preface, and was composed probably late in the prophet's life. Out of the north (the Babylonian sacred mountain) comes a bright cloud, wherein appear four Creatures (formed on the model of Babylonian composite figures), each with four faces (man, lion, bull, eagle) and attended by a wheel; the wheels are full of eyes, and move straight forward, impelled by the spirit dwelling in the Creatures (the spirit of Yahweh). Supported on their heads is something like a crystalline firmament, above which is a form like a sapphire throne (cf. Ex. xxiv. 10), and on the throne a man-like form (Yahweh) surrounded by a rainbow brightness. The wheels symbolize divine omniscience and control, and the whole vision represents the coming of Yahweh to take up his abode among the exiles. The prophet then receives his call (ii., iii.) in the shape of a roll of a book, which he is required to cat (an indication of the literary form now taken by prophecy). He is informed that the people to whom he is sent are rebellious and stiff-necked (this indicates his opinion of the people, and gives the keynote of the following discourses); he is appointed watchman to warn men when they sin, and is to be held responsible for the consequences if he fail in this duty. To this high conception of a preacher's function the prophet was faithful throughout his career. Next follow minatory discourses (iv.-vii.) predicting the siege and capture of Jerusalem—perhaps revised after the event. There are several symbolic acts descriptive of the siege. One of these (iv. 4 ff.) gives the duration of the national punishment in loose chronological reckoning: 40 years (a round number) for Judah, and 150 more (according to the corrected text) for Israel, the starting-point, probably, being the year 722, the date of the capture of Samaria; the procedure described in v. 8 is not to be understood literally. In vi. the idolatry of the nation is pictured in darkest colours. Next follows (viii.-xi.) a detailed description, in the form of a vision, of the sin of Jerusalem: within the temple-area elders and others are worshipping beast-forms, Tammuz and the sun (probably actual cults of the time);¹ men approach to defile the temple and slay the inhabitants of the city (ix.). In ch. x. the imagery of ch. i. reappears, and the Creatures are identified with the cherubs of Solomon's temple. This appears to be an independent form of the vision, which has been brought into connexion with that of i. by a harmonizing editor. There follow a symbolic prediction of the exile (xii.) and a denunciation of non-moral prophets and prophetesses (xiii.)—though Yahweh deceive a prophet, yet he and those who consult him will be punished; and so corrupt is the nation that the presence of a few eminently good men will not save it (xiv.).² After a comparison of Israel to a worthless wild vine (xv.) come two allegories, one portraying idolatrous Jerusalem as the unfaithful spouse of Yahweh (xvi.), the other describing the fate of Zedekiah (xvii.). The fine insistence on individual moral responsibility in xviii. (cf. Deut. xxiv. 16, Jer. xxxi. 29 f.), while it is a protest against a superficial current view, is not to be understood as a denial of all moral relations between successive generations. This latter question had not presented itself to the prophet's mind; his object was simply to correct the opinion of the people that their present misfortunes were due not to their own faults but to those of their predecessors. A more sympathetic attitude appears in two elegies (xix.), one on the kings Jehoahaz and Jehoiachin, the other on the nation. These are followed by a scathing sketch of Israel's religious career (xx. 1-26), in which, contrary to the view of earlier prophets, it is declared that the nation had always been disobedient. From this point to the end of xxiv. there is a mingling of threat and promise.³ The allegory of xxiii. is similar to that of xvi., except that in the latter Samaria is relatively treated with favour, while in the former it (Aholah) is involved in the same condemnation as that of Jerusalem. At this point is introduced (xxv.-xxxii.) the series of discourses directed against foreign nations. The description of the king of Tyre (xxviii. 11-19) as dwelling in Eden, the garden of God, the sacred mountain, under the protection of the cherub, bears a curious resemblance to the narrative in Gen. ii., iii., of which, however, it seems to be independent, using different Babylonian material; the text is corrupt. The section dealing with Egypt is one of remarkable imaginative power and rhetorical vigour: the king of Egypt is compared to a magnificent cedar of Lebanon (in xxxi. 3 read: "there was a cedar in Lebanon") and to the dragon of the Nile, and the picture of his

descent into Sheol is intensely tragic. Whether these discourses were all uttered between the investment of Jerusalem and its fall, or were here inserted by Ezekiel or by a scribe, it is not possible to say. In xxxiii. the function of the prophet as watchman is described at length (expansion of the description in iii.) and the news of the capture of the city is received. The following chapters (xxxiv.-xxxix.) are devoted to reconstruction: Edom, the detested enemy of Israel, is to be crushed; the nation, politically raised from the dead, with North and South united (xxxvii.), is to be established under a Davidide king; a final assault, made by Gog, is to be successfully met,⁴ and then the people are to dwell in their own land in peace for ever; this Gog section is regarded by some as the beginning of Jewish apocalyptic writing. In the last section (xl.-xlviii.), put as a vision, the temple is to be rebuilt, in dimensions and arrangements a reproduction of the temple of Solomon (cf. 1 Kings vi., vii.), the sacrifices and festivals and the functions of priests and prince are prescribed, a stream issuing from under the temple is to vivify the Dead Sea and fertilize the land (this is meant literally), the land is divided into parallel strips and assigned to the tribes. The prophet's thought is summed up in the name of the city: *Yahweh Shammah*, "Yahweh is there," God dwelling for ever in the midst of his people.

LITERATURE.—For the older works see the *Introductions* of J. G. Carpov (1757) and C. H. H. Wright (1890). For legends: Pseud-Epiphani., *De vit. prophet.*; Benjamin of Tudela, *Itin.*; Hamburger, *Realencycl.*; *Jew. Encycl.* On the Hebrew text; C. H. Cornill, *Ezechiel* (1886) (very valuable for text and ancient versions); H. Graetz, *Emendationes* (1893); C. H. Toy, "Text of Ezek." (1899) in Haupt's *Sacred Books of the Old Test.* Commentaries; F. Hitzig (1847); H. Ewald (1868); E. Reuss (French ed., 1876; Germ. ed., 1892); Currey (1876) in *Speaker's Comm.*; R. Smend (revision of Hitzig) (1880) in *Kurzgefasst. exeget. Handbuch*; A. B. Davidson (1882) in *Cambr. Bible for Schools*; J. Skinner (1895) in *Expos. Bible*; A. Bertholet (1897) in Marti's *Kurz. Hand-Comm.*; C. H. Toy (1899) in Haupt's *Sacr. Bks.* (Eng. ed.); R. Kraetzschmar (1900) in W. Nowack's *Handkommentar*. See also Duhm, *Theol. d. Propheten* (1875); A. Kuenen, *Prophets and Prophecy* (1877); Gautier, *La Mission du prophète Ézéchiël* (1891); Montefiore, *Hibbert Lectures* (1892); A. Bertholet, *Der Verfassungsentwurf des Hesekiel* (1896); articles in Herzog-Hauck, *Realencycl.*; Hastings, *Bibl. Dict.*; Cheyne, *Encycl. Bibl.*, *Jew. Encycl.*; F. Bleek, *Introd.* (Eng. tr., 1875), and Bleek-Wellhausen (Germ.) (1878); Wildeboer, *Letterkunde d. Oud. Verbonds* (1893), and Germ. transl., *Lit. d. Alt. Test.*; Perrot and Chipiez, *Hist. de l'art, &c.*, in which, however, the restoration of Ezekiel's temple (by Chipiez) is probably untrustworthy. (C. H. T.*)

EZRA (from a Hebrew word meaning "help"), in the Bible, the famous scribe and priest at the time of the return of the Jews in the reign of the Persian king Artaxerxes I. (458 B.C.). His book and that of Nehemiah form one work (see **EZRA AND NEHEMIAH, BOOKS OF**), apart from which we have little trustworthy evidence as to his life. Even in the beginning of the 2nd century B.C., when Ben Sira praises notable figures of the exilic and post-exilic age (Zerubbabel, Jeshua and Nehemiah), Ezra is passed over (Ecclesiasticus xlix. 11-13), and he is not mentioned in a still later and somewhat fanciful description of Nehemiah's work (2 Macc. i. 18-36). Already well known as a scribe, Ezra's labours were magnified by subsequent tradition. He was regarded as the father of the scribes and the founder of the Great Synagogue. According to the apocryphal fourth book of Ezra (or 2 Esdras xiv.) he restored the law which had been lost, and rewrote all the sacred records (which had been destroyed) in addition to no fewer than seventy apocryphal works. The former theory recurs elsewhere in Jewish tradition, and may be associated with the representation in Ezra-Nehemiah which connects him with the law. But the story of his many literary efforts, like the more modern conjecture that he closed the canon of the Old Testament, rests upon no ancient basis.

See **BIBLE**, sect. Old Testament (Canon and Criticism); **Jews** (history, § 21 seq.). The apocryphal books, called 1 and 2 Esdras (the Greek form of the name) in the English Bible, are dealt with below as **EZRA, THIRD BOOK OF**, and **EZRA, FOURTH BOOK OF**, while the canonical book of Ezra is dealt with under **EZRA AND NEHEMIAH**.

EZRA, THIRD BOOK OF [*1 Esdras*]. The titles of the various books of the Ezra literature are very confusing. The Greek, the Old Latin, the Syriac, and the English Bible from 1560

¹ In viii. 17 the unintelligible expression "they put the branch to their nose" is the rendering of a corrupt Hebrew text; a probable emendation is: "they are sending a stench to my nostrils."

² The legendary figure of Daniel (xiv. 14) is later taken by the author of the book of Daniel as his hero.

³ For a reconstruction of the poem in xxi. 10, 11, see the English Ezekiel in Haupt's *Sacred Books*.

⁴ Gog probably represents a Scythian horde (though such an invasion never took place)—certainly not Alexander the Great, who would have been called "king of Greece," and would have been regarded not as an enemy but as a friend.

onwards designate this book as 1 Esdras, the canonical books Ezra and Nehemiah being 2 Esdras in the Greek. In the Vulgate, however, our author was, through the action of Jerome, degraded into the third place and called 3 Esdras, whereas the canonical books *Ezra* and *Nehemiah* (see EZRA AND NEHEMIAH, BOOKS OF, below) were called 1 and 2 Esdras, and the Apocalypse of Ezra 4 Esdras. Thus the nomenclature of our book follows, and possibly wrongly, the usage of the Vulgate.¹ In the Ethiopic version a different usage prevails. The Apocalypse is called 1 Esdras, our author 2 Esdras, and Ezra and Nehemiah 3 Esdras, or 3 and 4 Esdras. Throughout this article we shall use the best attested designation of this book, *i.e.* 1 Esdras.

Contents.—With the exception of one original section, namely, that of Darius and the three young men, our author contains essentially the same materials as the canonical Ezra and some sections of 2 Chronicles and Nehemiah. To the various explanations of this phenomenon we shall recur later. The book may be divided as follows (the verse division is that of the Cambridge LXX):—

Chap. i. = 2 Chron. xxxv. 1-xxxvi. 21.—Great passover of Josiah: his death at Megiddo. His successors down to the destruction of Jerusalem and the Captivity. (Verses i. 21-22 are not found elsewhere, though the LXX of 2 Chron. xxxv. 20 exhibits a very distant parallel.)

Chap. ii. 1-14 = Ezra i.—The edict of Cyrus. Restoration of the sacred vessels through Sanabassar to Jerusalem.

Chap. ii. 15-25 = Ezra iv. 6-24.—First attempt to rebuild the Temple: opposition of the Samaritans. Decree of Artaxerxes: work abandoned till the second year of Darius.

Chap. iii. 1-v. 6.—This section is peculiar to our author. The contest between the three pages waiting at the court of Darius and the victory of the Jewish youth "Zerubbabel," to whom as a reward Darius decrees the return of the Jews and the restoration of the Temple and worship. Partial list of those who returned with "Joachim, son of Zerubbabel."

Chap. v. 7-70 = Ezra ii.-iv. 5.—List of exiles who returned with Zerubbabel. Work on the Temple begun. Offer of the Samaritans' co-operation rejected. Suspension of the work through their intervention till the reign of Darius.

Chap. vi. 1-vii. 9 = Ezra v. 1-vi. 18.—Work resumed in the second year of Darius. Correspondence between Sisinnus and Darius with reference to the building of the Temple. Darius' favourable decree. Completion of the work by Zerubbabel.

Chap. vii. 10-15 = Ezra vi. 19-22.—Celebration of the completion of the Temple.

Chap. viii. 1-ix. 36 = Ezra vii.-x.—Return of the exiles under Ezra. Mixed marriages forbidden.

Chap. ix. 37-55 = Nehemiah vii. 73-viii. 12.—The reading of the Law.

Thus, apart from iii. 1-v. 3, which gives an account of the pages' contest, the contents of the book are doublets of the canonical Ezra and portions of 2 Chronicles and Nehemiah. The beginning of the book seems imperfect, with its abrupt opening "And Josiah held the passover": its conclusion is mutilated, as it breaks off in the middle of a sentence. As Thackeray suggests, it probably continued the history of the feast of Tabernacles described in Neh. viii.—a view that is supported by Joseph. *Ant.* xi. 5. 5, "who describes that feast using an Esdras word *ἐπιανθρώσως* and . . . having hitherto followed Esdras as his authority passes on to the Book of Nehemiah."

Claims to Canonicity.—It would seem that even greater value was attached to 1 Esdras than to the Hebrew Ezra. (1) For in the best MSS. (BA) it stands before 2 Esdras—the verbal translation of the Hebrew Ezra and Nehemiah. (2) It is used by Josephus, who in fact does not seem aware of the existence of 2 Esdras. (3) 1 Esdras is frequently quoted by the Greek fathers—Clem. Alex., Origen, Eusebius, and by the Latin—Tertullian, Cyprian, Augustine. The adverse judgment of the church is due to Jerome, who, from his firm attachment to the Hebrew Old Testament, declined to translate the "dreams" of 3 and 4 Esdras. This judgment influenced alike the Council

¹ At the Council of Trent (when the Septuagint Canon was virtually accepted as authoritative), by a most curious aberration, Esdras iii. and iv. and the Epistle of Manasseh were alone excluded from the canon and remitted to our appendix.—Howorth, "Unconventional Views on the Text of the Bible," in the *P.S.B.A.*, 1901, p. 149.

of Trent and the Lutheran church in Germany; for Luther also refused to translate Esdras and the Apocalypse of Ezra.

Origin and Relation to the Canonical Ezra.—Various theories have been given as to the relation of the book and the canonical Ezra.

1. Some scholars, as Keil, Bissell and formerly Schürer, regarded 1 Esdras as a free compilation from the Greek of 2 Esdras (2 Chron. and Ezra-Nehemiah). This theory has now given place to others more accordant with the facts of the case.

2. Others, as Ewald, *Hist. of Isr.* v. 126-128, and Thackeray in *Hastings' Bible Dictionary*, assume a lost Greek version of Chronicles, Ezra and Nehemiah, from which were derived 1 Esdras—a free redaction of the former and 2 Esdras. Thackeray claims that we have "a satisfactory explanation of the coincidences in translation and deviation from the Hebrew in 1 Esdras and 2 Esdras, if we suppose both are to some extent dependent on a lost Greek original." But later in the same article Thackeray is compelled to modify this view and admit that 1 Esdras is not a mere redaction of a no longer extant version of the canonical books, but shows not only an independent knowledge of the Hebrew text but also of a Hebrew text superior in not a few passages to the Massoretic text, where 2 Esdras gives either an inaccurate version or a version reproducing the secondary Massoretic text.

3. Others like Michaelis, Trendelenburg, Pohlmann, Herzfeld, Fritzsche hold it to be a direct and independent translation of the Hebrew. There is much to be said in favour of this view. It presupposes in reality two independent recensions of the Hebrew text, such as we cannot reasonably doubt existed at one time of the Book of Daniel. Against this it has been urged that the story of the three pages was written originally in Greek (Ewald, Schürer, Thackeray). The only grounds for this theory are the easiness of the Greek style and the paronomasia in iv. 62 *ἀνεσιω και ἀφεσιω*. But the former is no real objection, and the latter may be purely accidental. On the other hand there are several undoubted Semiticisms. Thus we have two instances of the split relative οὗ . . . αὐτοῦ iii. 5; οὗ . . . ἐπ' αὐτῷ iv. 63 and the phrase pointed out by Fritzsche *τὰ δίκαια ποιῆι ἀπὸ πάντων* = *כִּן מַשְׁמַע הַשֵּׁע*. It must, however, be admitted that there are fewer Hebraisms in this section of the book than in the rest.

4. Sir H. H. Howorth in the treatises referred to at the close of this article has shown cogent grounds for regarding 1 Esdras as the original and genuine Septuagint translation, and 2 Esdras as probably that of Theodotion. For this view he adduces among others the following grounds: (i.) Its use by Josephus, who apparently was not acquainted with 2 Esdras. (ii.) Its precedence of 2 Esdras in the great uncials. (iii.) Its origin at a time when Chronicles, Ezra and Nehemiah formed a single work. (iv.) Its preservation of a better Hebrew text in many instances than 2 Esdras. (v.) The fact that 1 Esdras and the Septuagint of Daniel go back to one and the same translator, as Dr Gwynn (*Dict. Christ. Biog.* iv. 977) has pointed out (cf. 1 Esdr. vi. 31, and Dan. ii. 5).

This contention of Howorth has been accepted by Nestle, Cheyne, Bertholet, Ginsburg and other scholars, though they regard the question of an Aramaic original of chapters iii. 1-v. 6 as doubtful. Howorth's further claim that he has established the historical credibility of the book as a whole and its chronological accuracy as against the canonical Ezra has not as yet met with acceptance; but his arguments have not been fairly met and answered.

5. Volz (*Encyc. Bibl.* ii. 1490) thinks that the solution of the problem is to be found in a different direction. The text is of unequal value, and the inequalities are so great as to exclude the supposition that the Greek version was produced *aus einem Guss*. iii. 1-v. 3 is an independent narrative written originally in Greek and itself a composite production, the praise of truth being an addition. vi. 1-vii. 15, ii. 15-25a is a fragment of an Aramaic narrative. Some in Josephus (*Ant.* xi. 4. 9) an account of Samaritan intrigues is introduced immediately after 1 Esdras vii. 15, it is natural to infer that something of the same kind

has fallen out between vi. and ii. 15-25. The Aramaic text behind 1 Esdras here is better than that behind the canonical Ezra. Next, viii.-ix. is from the Ezra document (= Ezra vii.-x.; Neh. vii. 73, viii. 1 sqq.), though implying a different Hebrew text. ii. 1-15; v. 7-73; vii. 2-4, 6-15 are from the Chronicles; likewise i. is from 2 Chron. xxxv.-vi., 2 Esdras being at the same time before the translator.

Date.—The book must be placed between 300 B.C. and A.D. 100, when it was used by Josephus. It is idle to attempt any nearer limits until definite conclusions have been reached on the chief problems of the book.

MSS. and Versions.—The book is found in B and A. The latter seems to have preserved the more ancient form of the text, as it is generally that followed by Josephus. The Old Latin in two recensions is published by Sabatier, *Bibliorum sacrorum Latinae versiones antiquae*, iii. Another Latin translation is given in Lagarde (*Septuag. Studien*, ii., 1892). In Syriac the text is found only in the Syro-Hexaplar of Paul of Tella (A.D. 616). See Walton's Polyglott. There is also an Ethiopic version edited by Dillmann (*Bibl. Vel. Test. Aeth. v.*, 1894) and an Armenian.

LITERATURE.—Exegesis: Fritzsche, *Exeget. Handb. zu den Apokr.* (1851); Zöckler, *Die Apokryphen*, 155-161 (1891); Bissell in Lange-Schaff's *Comm.* (1880); Lupton in *Speaker's Comm.* (1888); Ball, notes to 1 Esdr. in the *Variorum Apocrypha*. Introduction and critical inquiries: Trendelenburg, "Apocr. Esra," in Eichhorn's *Allgem. Bibl. der bibl. Litt.* i. 178-232 (1787); Pohlmann, "Über das Ansehen des apokr. dritten Buchs Esras," in *Tübingen Theol. Quartalschrift*, 257-275 (1859); Sir H. Howorth, "Character and Importance of 1 Esdras," in the *Academy* (1893), pp. 13, 60, 106, 174, 326, 524; and further studies entitled "Some Unconventional Views on the Text of the Bible," in the *Proceedings of the Society of Biblical Archaeology*, 1901, pp. 147-159; 306-330, 1902, June and November. (R. H. C.)

EZRA, FOURTH BOOK (OR APOCALYPSE) OF. This is the most profound and touching of the Jewish Apocalypses. It stands in the relation of a sister work to the Apocalypse of Baruch, but though the relation is so close, they have many points of divergence. Thus, whereas the former represents the ordinary Judaism of the 1st century of the Christian era, the teaching of 4 Ezra on the Law, Works, Justification, Original Sin and Free Will approximates to the school of Shammai and serves to explain the Pauline doctrines on those subjects; but to this subject we shall return.

Original Language and Versions.—In the Latin version our book consists of sixteen chapters, of which, however, only iii.-xiv. are found in the other versions. To iii.-xiv., accordingly, the present notice is confined. After the example of most of the Latin MSS. we designate the book 4 Ezra (see Bensly-James, *Fourth Book of Ezra*, pp. xxiv-xxvii). In the First Arabic and Ethiopic versions it is called 1 Ezra; in some Latin MSS. and in the English Authorized Version it is 2 Ezra, and in the Armenian 3 Ezra. Chapters i.-ii. are sometimes called 3 Ezra, and xv.-xvi. 5 Ezra. All the versions go back to a Greek text. This is shown by the late Greek apocalypse of Ezra (Tischendorf, *Apocalypses Apocryphae*, 1866, pp. 24-33), the author of which was acquainted with the Greek of 4 Ezra; also by quotations from it in Barn. iv. 4; xii. 1=4 Ezra xii. 10 sqq., v. 5; Clem. Alex. *Strom.* iii. 16 (here first expressly cited)=4 Ezra v. 35, &c. (see Bensly-James, *op. cit.* pp. xxvii-xxxviii). The derivation of the Latin version from the Greek is obvious when we consider its very numerous Graecisms. Thus the genitive is found after the comparative (v. 13) *horum majora*; xi. 29 *duorum capitum majus*, even the genitive absolute as in x. 9, the double negative, *de* and *ex* with the genitive. Peculiar genders can only be accounted for by the influence of the original forms in Greek, as x. 23 *signaculum (σφραγίς)* . . . *tradita est*; xi. 4 *caput (κεφαλή)* . . . *sed et ipsa*. In vi. 25 we have the Greek attraction of the relative—*omnibus istis quibus praedixi tibi*. In his *Messias Judaeorum* (1869), pp. 36-110, Hilgenfeld has given a reconstruction of the Greek text. Till 1896 only Ewald believed that 4 Ezra was written originally in Hebrew. In that year Wellhausen (*Gött. Gel. Anz.* pp. 12-13) and Charles (*Apoc. Bar.* p. lxxii) pointed out that a Hebrew original must be assumed on various grounds; and

this view the former established in his *Skizzen u. Vorarbeiten*, vi. 234-240 (1899). Of the numerous grounds for this assumption it will be necessary only to adduce such constructions as "de quo me interrogas de co," iv. 28, and xiii. 26, "qui per semet ipsum liberabit" (= אֲשַׁרְיָוּ) = "through whom he will deliver," or to point to such a mistranslation as vii. 33, "longanimitas congregabitur," where for "congregabitur" (= אָסַף) we require "evanesceat," which is another and the actual meaning of the Hebrew verb in this passage. The same mistranslation is found in the Vulgate in Hosca iv. 3. Gunkel has adopted this view in his German translation of the book in Kautzsch's *Apok. und Pseud. des A. Testaments*, ii. 332-333, and brought forward in confirmation the following remarkable instance in viii. 23, where though the Latin, Syriac, Ethiopic, Arabic and Armenian Versions read *testificatur*, the Second Arabic version and the Apostolic Constitutions have *μέγελ ἐπὶ τὸν ἀλώνα*, which are to be explained as translations of עֲרַח לֵיזָר (לֵיזָר). Another interesting case is found in xiv. 3, where the Latin and all other versions but Arabic² read *super rubum* and the Arabic² *in monte Sinai*. Here there is a corruption of סנה "bush" into סיני "Sinai."

Latin Version.—All the older editions of this version, as those of Fabricius, Sabatier, Volkmar, Hilgenfeld, Fritzsche, as well as in the older editions of the Bible, are based ultimately on only one MS., the Codex Sangermanensis (written A.D. 822), as Gildemeister proved in 1865 from the fact that the large fragment between verses 36 and 37 in chapter vii., which is omitted in all the above editions, originated through the excision of a leaf in this MS. A splendid edition of this version based on MSS. containing the missing fragment, which have been subsequently discovered, has been published by Bensly-James, *op. cit.* This edition has taken account of all the important MSS. known, save one at Leon in Spain.

Syriac Version.—This version, found in the Ambrosian Library in Milan, was translated into Latin by Ceriani, *Monumenta sacra et profana*, II. ii. pp. 99-124 (1866). Two years later this scholar edited the Syriac text, *op. cit.* V. i. pp. 4-111, and in 1883 reproduced the MS. by photo-lithography (*Translatio Syra Peshitto V.T.* II. iv. pp. 553-572). Hilgenfeld incorporated Ceriani's Latin translation in his *Messias Judaeorum*. This translation needs revision and correction.

Ethiopic Version.—First edited and translated by Laurence, *Primi Ezrae libri versio Aethiopica* (1820). Laurence's Latin translation was corrected by Praetorius and reprinted in Hilgenfeld's *Messias Judaeorum*. In 1894 Dillmann's text based on ten MSS. was published—*V.T. Aeth. libri apocryphi*, v. 153-193.

Arabic Versions.—The First Arabic version was translated from a MS. in the Bodleian Library into English by Ockley (in Whiston's *Primitive Christianity*, vol. iv. 1711). This was done into Latin and corrected by Steiner for Hilgenfeld's *Mess. Jud.* The Second Arabic version, which is independent of the first, has been edited from a Vatican MS. and translated into Latin by Gildemeister, 1877.

Armenian Version.—First printed in the Armenian Bible (1805). Translated into Latin by Petermann for Hilgenfeld's *Mess. Jud.*; next with Armenian text and English translation by Issaverdens in the *Uncanonical Writings of the Old Testament*, pp. 488 sqq. (Venice, 1901).

Georgian Version.—According to F. C. Conybeare an accurate Georgian version made from the Greek exists in an 11th-century MS. at Jerusalem.

Relation of the above Versions.—These versions stand in the order of worth as follows: Latin, Syriac, Ethiopic. The remaining versions are paraphrastic and less accurate, and are guilty of additions and omissions. All the versions, save the Second Arabic one, go back to the same Greek version. The Second Arabic version presupposes a second Greek version.

Modern Versions.—All the English versions are now antiquated, except those in the Variorum Apocrypha and the Revised Version of the Apocrypha, and even these are far from satisfactory. Similarly, all the German versions are behindhand, except the excellent version of Gunkel in *Apok. u. Pseud.* ii. 252-401, which, however, needs occasional correction.

Contents.—The book (iii.-xiv.) consists of seven visions or parts, like the apocalypse of Baruch. They are: (1) iii. 1-v. 19; (2) v. 20-vi. 34; (3) vi. 35-ix. 25; (4) ix. 26-x. 60; (5) xi. 1-xii. 51; (6) xiii.; (7) xiv. These deal with (1) religious problems and speculations and (2) eschatological questions. The first three are devoted to the discussion of religious problems affecting in the main the individual. The presuppositions underlying these are in many cases the same as those in the Pauline Epistles. The next three visions are principally concerned with eschatological problems which relate to the nation. The seventh vision

is a fragment of the Ezra Saga recounting the rewriting of the Scriptures, which had been destroyed. This has no organic connexion with what precedes.

First Vision. iii.-v. 19.—“In the thirtieth year after the ruin of the city I Salathiel (the same is Ezra) was in Babylon and lay troubled upon my bed.” In a long prayer Ezra asks how the desolation of Zion and the prosperity of Babylon can be in keeping with the justice of God. The angel Uriel answers that God’s ways are unsearchable and past man’s understanding. When Ezra asks when the end will be and what are the signs of it, the angel answers that the end is at hand and enumerates the signs of it.

Second Vision. v. 14-vi. 34.—Phaltiel, chief of the people, reproaches Ezra for forsaking his flock. Ezra fasts, and in his prayer asks why God had given up his people into the hands of the heathen. Uriel replies: “Lovest thou that people better than He that made them?” Man cannot find out God’s judgment. The end is at hand; its signs are recounted.

Third Vision. vi. 35-ix. 25.—Ezra recounts the works of creation, and asks why Israel does not possess the world since the world was made for Israel. The answer is that the present state is a necessary stage to the coming one. Then follows an account of the Messianic age and the resurrection: the punishment of the wicked and the blessings of the righteous. There can be no intercession for the departed. Few will be saved—only as it were a grape out of a cluster or a plant out of a forest.

Fourth Vision. ix. 26-x. 60.—Ezra eats of herbs in the field of Ardat, and sees in a vision a woman mourning for her only son. Ezra reminds her of the greater desolation of Zion. Suddenly she is transfigured and vanishes, and in her place appears a city. The woman, Uriel explains, represents Zion.

Fifth Vision. xi. 1-xii. 39.—Vision of an eagle with three heads, twelve wings and eight winglets, which is rebuked by a lion and destroyed. The eagle is the fourth kingdom seen by Daniel, and the lion is the Messiah.

Sixth Vision. xiii.—Vision of a man (*i.e.* the Messiah) arising from the sea, who destroys his enemies who assemble against him, and gathers to him another multitude, *i.e.* the lost Ten Tribes.

Seventh Vision. xiv.—Ezra is told of his approaching translation. He asks for the restoration of the Law, and is enabled by God to dictate in forty days ninety-four books (the twenty-four canonical books of the Old Testament that were lost, and seventy secret books for the wise among the people).

Ezra’s translation is found in the Canon only in the Oriental Versions. In the Latin it was omitted when xv.-xvi. were added.

Integrity.—According to Gunkel (*Apok. u. Pseud.* ii. 335-352) the whole book is the work of one writer. Thus down to vii. 16 he deals with the problem of the origin of suffering in the world, and from vii. 17 to ix. 25 with the question who is worthy to share in the blessedness of the next world. As regards the first problem the writer shows, in the first vision, that suffering and death come from sin—no less truly on the part of Israel than of all men, for God created man to be immortal; that the end is nigh, when wrongs will be righted; God’s rule will then be recognized. In the second he emphasizes the consolation to be found in the coming time, and in the third he speaks solely of the next world, and then addresses himself to the second problem. The fourth, fifth and sixth visions are eschatological. In these the writer turns aside from the religious problems of the first three visions and concerns himself only with the future national supremacy of Israel. Zion’s glory will certainly be revealed (vision four), Israel will destroy Rome (five) and the hostile Gentiles (six). Then the book is brought to a close with the legend of Ezra’s restoration of the lost Old Testament Scriptures.

In the course of the above work there are many inconsistencies and contradictions. These Gunkel explains by admitting that the writer has drawn largely on tradition, both oral and written, for his materials. Thus he concedes that eschatological materials in v. 1-13, vi. 18-28, vii. 26 sqq., also ix. 1 sqq., are from this source, and apparently from an originally independent work, as Kabisch urges, but that it is no longer possible to separate the borrowed elements from the text. Again, in the four last visions he is obliged to make the same concession on a very large scale. Vision four is based on a current novel, which the author has taken up and put into an allegorical form. Visions five and six are drawn from oral or written tradition, and relate only to the political expectations of Israel, and seven is a reproduction of a legend, for the independent existence of which evidence is furnished by the quotations in Bensly-James pp. xxxvii-xxxviii.

Thus the chief champion of the unity of the book makes so many concessions as to its dependence on previously existing sources that, to the student of eschatology, there is little to choose between his view and that of Kabisch. In fact, if the true meaning of the borrowed materials is to be discovered, the sources must be disentangled. Hence the need of some such analysis as that of Kabisch (*Das vierte Buch Ezra*, 1889): S=an Apocalypse of Salathiel, *c.* A.D. 100, preserved in a fragmentary condition, iii. 1-31, iv. 1-51, v. 13b-vi. 10, 30-vii. 25, vii. 45-viii. 62, ix. 13-x. 57, xii. 40-48, xiv. 28-35. E=an Ezra Apocalypse, *c.* 31 B.C., iv. 52-v. 13a, vi. 13-28, vii. 26-44, viii. 63-ix. 12. A=an Eagle Vision, *c.* A.D. 90, x. 60-xii. 35. M=a Son-of-Man Vision, xiii. E²=an Ezra fragment, *c.* A.D. 100, xiv. 1-17a, 18-27, 36-47. All these, according to Kabisch, were edited by a Zealot, *c.* 120, who supplied the connecting links and made many small additions. In the main this analysis is excellent. If we assume that the editor was also the author of S, and that such a vigorous stylist, as he shows himself to be, recast to some extent the materials he borrowed, there remains but slight difference between the views of Kabisch and Gunkel. Neither view, however, is quite satisfactory, and the problem still awaits solution. Other attempts, such as Ewald’s (*Gesch. d. Volkes Israel*³, vii. 69-83) and De Faye’s (*Apocalypses juives*, 155-165), make no contribution.

School of the Author.—The author or final redactor of the book was a pessimist, and herein his book stands in strong contrast with the Apocalypse of Baruch. Thus to the question propounded in the New Testament—“Are there few that be saved?” he has no hesitation in answering, “There be many created, but few that be saved” (viii. 3): “An evil heart hath grown up in us which hath led us astray . . . and that not a few only but wellnigh all that have been created” (vii. 48). In the Apocalypse of Baruch on the other hand it is definitely maintained that not a few shall be saved (xxi. 11). Moreover, the sufferings of the wicked are so great in the next world it were better, according to 4 Ezra (as also to the school of Shammai), that man had not been born. “It is much better (for the beasts of the field) than for us; for they expect not a judgment and know not of torments” (vii. 66); yet “it would have been best not to have given a body to Adam, or that being done, to have restrained him from sin; for what profit is there that man should in the present life live in heaviness and after death look for punishment” (vii. 116, 117). In iv. 12 the nexus of life, sin and suffering just referred to, is put still more strongly: “It were better we had not been at all than that we should be born and sin and suffer.”¹ The different attitude of these two writers towards this question springs from their respective views on the question of free will. The author of Baruch declares (iv. 15, 19): “For though Adam sinned and brought untimely death upon all, yet of those who were born from him each one of them prepared for his own soul torment to come, and again each one of them has chosen for himself glories to come . . . each one of us has been the Adam of his own soul.” Though the writer of Ezra would admit the possibility of a few Israelites attaining to salvation through the most strenuous endeavour, yet he holds that man is all but predoomed through his original evil disposition or through the fall of Adam (vii. 118). “O Adam, what hast thou done: for though it was thou that sinned, the evil is not fallen on thee alone, but upon all of us that come of thee.”

Another contrast between the two books is that while Baruch shows some mercy to the Gentiles (lxxii. 4-6) in the Messianic period, none according to 4 Ezra and the Shammites (Toseph. *Sanh.* xiii. 2) will be extended to them, iii. 30, ix. 22 sq., xii. 34, xiii. 37 sq.).

On the above grounds it is not unreasonable to conclude that whereas the Apocalypse of Baruch owes its leading characteristics to a pupil of Hillel’s school, 4 Ezra shows just as clearly its derivation from that of Shammai. Kohler (*Jewish Encyc.*

¹ In the Apocalypse of Baruch, x. 6, we find a similar expression: “Blessed is he who was not born, or being born has died.” But here death is said to be preferable to witnessing the present woes of Jerusalem.

v. 221) points out that the view of 4 Ezra that the Ten Tribes will return was held by the Shammaites, whereas it was denied by Aqiba. The Apocalypse of Baruch is silent on this point.

Time and Place.—The work was written towards the close of the 1st century (iii. 1, 29), and somewhere in the east.

LITERATURE.—In addition to the authorities mentioned above, see Dillmann, *Herzog's Real-Encyk.* xii. 353 sqq.; Schürer, *Gesch. des jüd. Volkes*, iii. 246 sqq.; and the articles on 4 Esdras in *Hastings' Bible Dictionary* and the *Encyclopaedia Biblica* by Thackeray and James respectively. (R. H. C.)

EZRA AND NEHEMIAH, BOOKS OF, in the Old Testament. The two canonical books entitled Ezra and Nehemiah in the English Bible¹ correspond to the 1 and 2 Esdras of the Vulgate, to the 2 Esdras of the Septuagint, and to the Ezra and Nehemiah of the Massoretic (Hebrew) text. Though for many centuries they have thus been treated as separate compositions, we have abundant evidence that they were anciently regarded as forming but one book, and a careful examination proves that together with the book of Chronicles they constitute one single work. The two books may therefore be conveniently treated together.

1. *Position and Date.*—Origen (Euseb, *H.E.* vi. 25), expressly enumerating the twenty-two books of the old covenant as acknowledged by the Jews and accepted by the Christian church, names "the First and Second Ezra in one book"; Melito of Sardis (Euseb. *H.E.* iv. 26) in like manner mentions the book of Ezra only. So also the Talmud (in *Bābā bathrā*, 14. 2), nor can it be supposed that Josephus in his enumeration (*c. Ap.* i. 8) reckoned Nehemiah as apart from Ezra. That the Jews themselves recognized no real separation is shown by the fact that no Massoretic notes are found after Ezra x., but at the end of Nehemiah the contents of both are reckoned together, and it is stated that Neh. iii. 22 is the middle verse of the book. Their position in the Hebrew Bible before the book of Chronicles is, however, illogical. The introductory verses of Ezra i. are identical with the conclusion of 2 Chron. xxxvi., whilst in the version of 1 Esdras no less than two chapters (2 Chron. xxxv. sq.) overlap. The cause of the separation is probably to be found in the late reception of Chronicles into the Jewish canon. Further proof of the unity of the three is to be found in the general similarity of style and treatment. The same linguistic criteria recur, and the interest in lists and genealogies, in priests and Levites, and in the temple service point unmistakably to the presence of the same hand (the so-called "chronicler") in Chronicles-Ezra-Nehemiah. See BIBLE (sect. Canon); CHRONICLES.

The period of history covered by the books of Ezra and Nehemiah extends from the return of the exiles under Zerubbabel in 537-536 B.C. to Nehemiah's second visit to Jerusalem in 432 B.C. In their present form, however, the books are considerably later, and allusions to Nehemiah in the past (Neh. xii. 26, 47), to the days of Jaddua (the grandson of Nehemiah's contemporary Joiada; *ib.* xii. 11), to Darius (Nothus 423 B.C. or rather Codomannus 336 B.C., *ib.* v. 22), and the use of the term "king of Persia," as a distinctive title after the fall of that empire (332 B.C.), are enough to show that, as a whole, they belong to the same age as the book of Chronicles.

2. *Contents.*—Their contents may be divided into four parts:—

(a) The events preceding the mission of Ezra (i.-vi.).—In the first year of his reign Cyrus was inspired to grant a decree permitting the Jews to return to build the temple in Jerusalem (i.); a list of families is given (ii.). The altar of burnt-offering was set up, and in the second year of the return the foundations of the new temple were laid with great solemnity (iii.). The "adversaries of Judah and Benjamin" offered to assist but were repulsed, and they raised such opposition to the progress of the work that it ceased until the second year of Darius (521-520 B.C.). Aroused by the prophets Haggai and Zechariah the building was then resumed, and despite fresh attempts to hinder the work it was completed, consecrated and dedicated

in the sixth year of that king (vi.). The event was solemnized by the celebration of the Passover (cf. 2 Chron. xxx., Hezekiah; xxxv. Josiah).

(b) An interval of fifty-eight years is passed over in silence, and the rest of the book of Ezra comprises his account of his mission to Jerusalem (vii.-x.). Ezra, a scribe of repute, well versed in the laws of Moses, returns with a band of exiles in order to reorganize the religious community. A few months after his arrival (seventh year of Artaxerxes, 458 B.C.) he instituted a great religious reform, viz. the prohibition of inter-marriage with the heathen of the land (cf. already vi. 21). In spite of some opposition (x. 15 obscurely worded) the reform was accepted, and the foundations of a new community were laid.

(c) Twelve years elapse before the return of Nehemiah, whose description of his work is one of the most interesting pieces of Old Testament narrative (Neh. i.-vi.). In the twentieth year of Artaxerxes (445 B.C.), Nehemiah the royal cup-bearer at Shushan (Susa, the royal winter palace) was visited by friends from Judah and was overcome with grief at the tidings of the miserable condition of Jerusalem and the pitiful state of the Judaeans remnant which had escaped the captivity. He obtained permission to return, and on reaching the city made a secret survey of the ruins and called upon the nobles and rulers to assist in repairing them. Much opposition was caused by Sanballat the Horonite (*i.e.* of the Moabite Horonaim or Beth-horon, about 15 m. N.W. of Jerusalem), Tobiah the Ammonite, Geshem (or Gashmu) the Arabian, and the Ashdodites, whose virulence increased as the rebuilding of the walls continued. But notwithstanding attempts upon the city and upon the life of Nehemiah, and in spite of intrigues among certain members of the Judaeans section, in fifty-two days the city walls were complete (Neh. vi. 15). The hostility, however, did not cease, and measures were taken to ensure the safety of the city (vi. 16-vii. 4). A valuable account is given of Nehemiah's economical reforms, illustrating the internal social conditions of the period and the general character of the former governors who had been placed in charge (v., cf. the laws codified in Lev. xxv. 35 sqq.).

(d) The remaining chapters carry on the story of the labours of both Ezra and Nehemiah. The list of those who returned under the decree of Cyrus is repeated (Neh. vii.), and leads up to the reading of the Law by Ezra, a great national confession of guilt, and a solemn undertaking to observe the new covenant, the provisions of which are detailed (x. 28-39). After sundry lists of the families dwelling in Jerusalem and its neighbourhood (xi. 1 sqq., apparently a sequel to vii. 1-4),² and of various priests and Levites, an account is given of the dedication of the walls (xii. 27-43), the arrangements for the Levitical organization (*vv.* 44-47), and a fresh separation from the heathen (Moabites and Ammonites, xiii. 1-3; cf. Deut. xxiii. 3 seq.). The book concludes with another extract from Nehemiah's memoirs dealing with the events of a second visit, twelve years later (xiii. 4-31). On this occasion he vindicated the sanctity of the temple by expelling Tobiah, reorganized the supplies for the Levites, took measures to uphold the observance of the Sabbath, and protested energetically against the foreign marriages. In the course of his reforms he thrust out a son of Joiada (son of Eliashib, the high-priest), who had married the daughter of Sanballat, an incident which had an important result (see SAMARITANS).

That these books are the result of compilation (like the book of Chronicles itself) is evident from the many abrupt changes; the inclusion of certain documents written in an Aramaic dialect (Ezr. iv. 8-vi. 18, vii. 12-26)³; the character of the name-lists; the lengthy gaps in the history; the use made of two distinct sources, attributed to Ezra and Nehemiah respectively, and from the varying form in which the narratives are cast. The

¹ References to 1 Esdras in this article are to the book discussed above as Ezra, THIRD BOOK OF.

² With Neh. xi. 4-19 cf. 1 Chron. ix. 3-17; with the list xii. 1-7 cf. *vv.* 12-21 and x. 3-9; and with xii. 10 sq. cf. 1 Chron. vi. 3-15 (to which it forms the sequel). See further Smend, *Listen d. Esra u. Neh.* (1881).

³ Sometimes wrongly styled Chaldee (*q.v.*); see SEMITIC LANGUAGES.

chronicler's hand can usually be readily recognized. There are relatively few traces of it in Nehemiah's memoirs and in the Aramaic documents, but elsewhere the sources are largely coloured, if not written from the standpoint of his age. Examples of artificial arrangement appear notably in Ezr. ii.-iii. 1 compared with Neh. vii. 6-viii. 1 (first clause); in the present position of Ezr. iv. 6-23; and in the dislocation of certain portions of the two memoirs in Neh. viii.-xiii. (see below). It should be noticed that the present order of the narratives involves the theory that some catastrophe ensued after Ezr. x. and before Neh. i.; that the walls had been destroyed and the gates burnt down; that some external opposition (with which, however, Ezra did not have to contend) had been successful; that the main object of Ezra's mission was delayed for twelve years, and, finally, that only through Nehemiah's energy was the work of social and religious reorganization successful. These topics raise serious historical problems (see *Jews: History*, § 21).

3. *Criticism of Ezra i.-vi.*—The chronicler's account of the destruction of Jerusalem, the seventy years' interval (2 Chron. xxxvi. 20 sq.; cf. Jer. xxv. 11, xxix. 10, also Is. xxiii. 17), and the return of 42,360 of the exiles (Ezr. ii. 64 sqq.) represent a special view of the history of the period. The totals, as also the detailed figures, in Ezr., Neh. and 1 Esdr. v. vary considerably; the number is extremely large (contrast Jer. lii. 30); it includes the common people (contrast 2 Kings xxiv. 14, xxv. 12), and ignores the fact that Judah was not depopulated, that the Jews were carried off to other places besides Babylon and that many remained behind in Babylon. According to this view, Judah and Jerusalem were practically deserted until the return. The list in Ezr. ii. is that of families which returned "every man unto his city" under twelve leaders (including Nehemiah, Azariah [cf. Ezra], Zerubbabel and Jeshua); it recurs with many variations in a different and apparently more original context in Neh. vii., and in 1 Esdr. v. is ascribed to the time of Darius. The families (to judge from the northwards extension of Judæan territory) are probably those of the population in the later Persian period, hardly those who returned to the precise homes of their ancestors (see C. F. Kent, *Israel's Hist. and Biogr. Narratives*, p. 379). The offerings which are for the temple-service in Neh. vii. 70-72 (cf. 1 Chron. xxix. 6-8) are for the building of the temple in Ezr. ii. 68-70; and since the walls are not yet built, the topographical details in Neh. viii. 1 (see 1 Esdr. v. 47) are adjusted, and the event of the seventh month is not the reading of the Law amid the laments of the people (Neh. viii.; see *vv.* 9-11) but the erection of the altar by Jeshua and Zerubbabel under inauspicious circumstances (cf. Ezr. iii. 3 with 1 Esdr. v. 50).

The chronologically misplaced account of the successful opposition in the time of Ahasuerus (*i.e.* Xerxes) and Artaxerxes (the son and grandson of Darius respectively) breaks the account of the temple under Cyrus and Darius, and is concerned with the city walls (iv. 6-23)¹; there is some obscurity in *vv.* 7-9: Rehum and Shimshai evidently take the lead, Tabeel may be an Aramaized equivalent of Tobiah. A recent return is implied (iv. 12) and the record hints that a new decree may be made (*v.* 21). The account of the unsuccessful opposition to the temple in the time of Darius (*v.* sq.; for another account see Jos. *Ant.* xi. 4, 9) is independent of iv. 7-23, and throws another light upon the decree of Cyrus (*vi.* 3-5, contrast *i.* 2-4). It implies that Sheshbazzar, who had been sent with the temple vessels in the time of Cyrus, had laid the foundations and that the work had continued without cessation (*v.* 16, contrast *iv.* 5, 24). The beginning of the reply of Darius is wanting (*vi.* 6 sqq.), and the decree which had been sought in Babylon is found at Ecbatana. Chap. vi. 15

¹ Its real position in the history of this period is not certain. Against the supposition that the names refer to Cambyses and Pseudo-Smerdis who reigned after Cyrus and before Darius, see H. E. Ryle, *Camb. Bible*, "Ezra and Neh.," p. 65 sq. Against the view that Darius is D. ii. Nothus of 423-404 B.C., see G. A. Smith, *Minor Prophets*, ii. 191 sqq. The ignorance of the compiler regarding the sequence of the kings finds a parallel in that of the author of the book of Daniel (*q.v.*); see C. C. Torrey, *Amer. Journ. of Sem. Lang.* (1907), p. 178, n. 1.

sqq. follow more naturally upon *v.* 1-2, but *v.* 14 with its difficult reference to Artaxerxes now seems to presuppose the decree in *iv.* 21 and looks forward to the time of Ezra or Nehemiah. As regards this section (Ezr. i.-vi.) as a whole, there is little doubt that *i.* iii. 1-iv. 5, *vi.* 15-22 are from the chronicler, whose free treatment of his material is seen in the use he has made of *ch.* ii. Notwithstanding the unimpeachable evidence for the tolerant attitude of Persian kings and governors towards the religion of subject races, it is probable that the various decrees incorporated in the book (cf. also 1 Esdr. iv. 42 sqq.) have been reshaped from a Jewish standpoint. A noteworthy example appears in the account of the unique powers entrusted to Ezra (*vii.* 11-26), the introduction to whose memoirs, at all events, is quite in the style of the chronicler.

4. *Memoirs of Nehemiah and Ezra.*—The memoirs of Ezra and Nehemiah do not appear to have been incorporated without some adjustment. The lapse of time between Neh. i. 1 and ii. 1 is noteworthy, and with the prayer in *i.* 5-11 cf. Ezr. ix. 6-15, Dan. ix. 4 sqq. (also parallels in Deuteronomy); *chap.* i. in its present form may be a compiler's introduction. The important topographical list in *ch.* iii. is probably from another source; the style is different, Nehemiah is absent, and the high-priest is unusually prominent.² *Chap.* v., where Nehemiah reviews his *past* conduct as governor, turns aside to economic reforms and scarcely falls within the fifty-two days of the building of the walls. The chapter is closely associated with the contents of *xiii.* and breaks the account of the opposition. Anticipated already in *ii.* 10, the hostility partly arises from the repudiation of Samaritan religious claims (*ii.* 20; cf. Ezr. iv. 3) and is partly political. It is difficult to follow its progress clearly, and the account ceases abruptly in *vi.* 17-19 with the notice of the conspiracy of Tobiah and the nobles of Judah. The chronicler's style can be recognized in *vii.* 1-5 (in its present form), where steps are taken to protect and to people Jerusalem; the older sequel is now found in *ch.* xi. Whilst the account of the dedication of the walls is marked by the use of the pronoun "I" (*xii.* 31, 38, 40), it is probably now due as a whole to the chronicler, and when the more trustworthy memoirs of Nehemiah are resumed (*xiii.* 4 sqq.) the episodes, although placed twelve years later (*ver.* 6), are intimately connected with the preceding reforms (cf. *xii.* 44-xiii. 3 with *xiii.* 10 sqq., 23 sqq.).³ Nehemiah's attitude towards intermarriage is markedly moderate in contrast to the drastic measures of Ezra, whose mission and work the simpler and perhaps earlier narratives of Nehemiah originally ignored, and the relation between the two is complicated further by the literary character of the memoir of Ezra.

To the last mentioned are prefixed (*a*) the scribe's genealogy, which traces him back to Aaron and names as his immediate ancestor, Seraiah, who had been slain 130 years previously (Ezr. vii. 1-5), and (*b*) an independent account of the return (*vv.* 6-10) with a reference to Ezra's renown, obviously not from the hand of Ezra himself. Whatever the original prelude to Ezra's thanksgiving may have been (*vii.* 27 seq.), we now have the essentially Jewish account of the letter of Artaxerxes with its unusual concessions.⁴ The list of those who returned amounts to the moderate total of 1496 males (*viii.*, but 1690 in 1 Esdr. viii. 30 sqq.). Ezra's mission was obviously concerned with the Law and Temple service (*vii.* 6, 10, 14 sqq., 25; *viii.* 17, 24-30, 33 sq.), but four months elapse between his return in the fifth month (*vii.* 9) and the preparations for the marriage reforms in the ninth (*x.* 9), and there is a delay of twelve years before the Law is read (Neh. viii.). The Septuagint version (1 Esdr. ix.; cf. Josephus, *Antiq.* xi. 5, 5 and some modern scholars) would place

² See further H. G. Mitchell, *Journ. of Bibl. Lit.* (1903), pp. 88 sqq.

³ The chronological difficulties will be seen from *xiii.* 6 ("before this"), which would imply that the dedication of the walls was on the occasion of Nehemiah's later visit (see G. A. Smith, *Expositor*, July 1906, p. 12). His previous departure is perhaps foreshadowed in *vii.* 2.

⁴ See *Ency. Bib.* col. 1480. Papyri from a Jewish colony in Elephantine (407 B.C.) clearly show the form which royal permits could take, and what the Jews were prepared to give in return; the points of resemblance are extremely interesting, but compared with the biblical documents the papyri reveal some striking differences.

the latter after Ezr. x., but more probably this event (dated in the seventh month) should precede the great undertaking in Ezr. ix.¹ That the adjustment was attended with considerable revision of the passages appears from a careful comparison of Neh. viii. sq. with Ezr. ix. sq. With Ezra's confession (ix. 6 sqq.) compare the prayer in Neh. ix. 5 sqq., which the Septuagint ascribes to him. In Ezr. x. (written in the third person) the number of those that had intermarried with the heathen is relatively small considering the general trend of the preliminaries, and the list bears a marked resemblance to that in ch. ii. It ends abruptly and obscurely (x. 44; cf. 1 Esdr. ix. 35), and whilst as a whole the memoirs of Ezra point to ideas later than those of Nehemiah, the present close literary connexion between them is seen in the isolated reference to Johanan the son of Eliashib in Ezra x. 6, which seems to be connected with Neh. xiii. 7, and (after W. R. Smith) in the suitability of *ib.* xiii. 1, 2 between Ezr. x. 9 and 10. The list of signatories in Neh. x. 1-27 should be compared with the names in xii. and 1 Chron. xxiv.; the true connexion of ix. 38 is very obscure, and the relation to Ezr. ix. seq. is complicated by the reference to the separation from the heathen in Neh. ix. 2. The description of the covenant (Neh. x. 28 sqq., marked by the use of "we") is closely connected with xii. 43-xiii. 3 (from the same or an allied source), and anticipates the parallel though somewhat preliminary measures detailed in the more genuine memoirs (Neh. xiii. 4 sqq.). Finally, the specific allusion in xiii. 1-3 to Ammon and Moab is possibly intended as an introduction to the references to Tobiah and Sanballat respectively (*vv.* 4 seq., 28).

5. *Summary.*—The literary and historical criticism of Ezra-Nehemiah is closely bound up with that of Chronicles, whose characteristic features it shares. Although the three formed a unit at one stage it may seem doubtful whether two so closely related chapters as 1 Chron. ix. and Neh. xi. would have appeared in one single work, while the repetition of Neh. vii. 6-viii. 1 in Ezr. ii.-iii. 1 is less unnatural if they had originally appeared in distinct sources. Thus other hands apart from the compiler of Chronicles may have helped to shape the narratives, either before their union with that book or after their separation.² The present intricacy is also due partly to specific historical theories regarding the post-exilic period. Here the recension in 1 Esdras especially merits attention for its text, literary structure and for its variant traditions.³ Its account of a return in the time of Darius scarcely arose *after* Ezr. i.-iii. (Cyrus); the reverse seems more probable, and the possibility of some confusion or of an intentional adjustment to the earlier date is emphasized by the relation between the popular feeling in Ezr. iii. 12 (Cyrus) and Hag. ii. 3 (Darius), and between the grant by Cyrus in iii. 7 (it is not certain that he held Phoenicia) and the permit of Darius in 1 Esdr. iv. 47-57 (see *v.* 48). To the latter context belongs the list of names which reappears in Ezr. ii. (Cyrus). But from the independent testimony of Haggai and Zechariah it is doubtful whether the chronicler's account of the return under Cyrus is at all trustworthy. The list in 1 Esdr. v., Ezr. ii., as already observed, appears to be in its more original context in Neh. vii., *i.e.* in the time of Artaxerxes, and it is questionable whether the earliest of the surviving detailed traditions in Ezra-Nehemiah went back before this reign. It is precisely at this age that there is evidence for a return, apparently other than that of Ezra or Nehemiah (see Ezr. iv. 12), yet no account seems to be preserved unless the records were used for the history of earlier periods (cf. generally Ezr. iii. 12 sq. with Neh.

¹ C. C. Torrey, *Comp. and Hist. Value of Ezra-Neh.* (Beihefte of *Zeit. f. alttest. Wissens.*, 1896), pp. 30-34; C. F. Kent, *Israel's Hist. and Biog. Narratives*, pp. 32, 369. Since Neh. vii. 70-73 is closely joined to viii., the suggested transposition would place its account of the contributions to the temple in a more appropriate context (cf. Ezr. viii. 24-30, 33 sq.).

² For linguistic evidence reference should be made to J. Geissler, *Die litterarischen Beziehungen d. Esramemoiren* (Chemnitz, 1899).

³ See especially Sir Henry Howorth, *Proc. of Society of Bibl. Arch.* (1901-1904), *passim*; C. C. Torrey, *Ezra Studies* (Chicago, 1910). For the text, see A. Klostermann, *Real-Ency. f. prot. Theol.* v. 501 sqq.; H. Guthe in Haupt's *Sacred Books of Old Testament* (1899); and S. A. Cook in R. H. Charles, *Apocrypha and Pseudepigrapha*.

viii. 9-11; Ezr. iii. 7 with the special favour enlisted on behalf of the Jews in vi. 7 sq., 13, vii. 21; Neh. ii. 7 sq.). But the account of the events in the reign of Artaxerxes is extremely perplexing. Since the building of the walls of Jerusalem must have begun early in the fifth month (Neh. vi. 15), an allowance of three days (ii. 11) makes the date of Nehemiah's arrival practically the anniversary of Ezra's return (Ezr. vii. 9, viii. 32). Considering the close connexion between the work of the two men this can hardly be accidental. The compiler, however, clearly intends Neh. vi. 15 (25th of sixth month) to be the prelude to the events in Neh. vii. 73, viii. (seventh month), but the true sequence of Neh. vi. sqq. is uncertain, and the possibility of artificiality is suggested by the unembellished statement of Josephus that the building of the walls occupied, not fifty-two days, but two years four months (*Anl.* xi. 5. 8). The present chronological order of Nehemiah's work is confused (cf. § 4, n. 3), and the obscure interval of twelve years in his work corresponds very closely to that which now separates the records of Ezra's labours. However, both the recovery of the compilers' aims and attempted reconstructions are precluded from finality by the scantiness of independent historical evidence. (See further JEWS: *History*, § 21 seq.)

BIBLIOGRAPHY.—S. R. Driver, *Lit. of the O. T.* (1909), pp. 540 sqq. and the commentaries of H. E. Ryle (*Camb. Bible*, 1893), C. Siegfried (1901), A. Bertholet (1902), and T. W. Davies (*Cent. Bible*, 1909). Impetus to recent criticism of these books starts with Van Hoonacker (*Neh. et Esd.* [1890]; see also *Expos. Times* [1897], pp. 351-354, and M.-J. Lagrange, *Rev. biblique*, iii. 561-585 [1894], iv. 186-202 [1895]) and W. H. Kusters (Germ. ed., *Wiederherstellung Israels*, 1895). The latter's important conclusions (for which see his article with Cheyne's additions in *Ency. Bib.* col. 1473 sqq., 3380 sqq.) have been adversely criticized, especially by J. Wellhausen (*Nachrichten of the Univ. of Göttingen*, 1895, pp. 166-186), E. Meyer (*Entstehung d. Judentums*, 1896), J. Ninkel (*Wiederherstellung d. jüd. Gemein.*, 1900), and S. Jampel in *Monatsschrift f. Gesch. u. Wissens. d. Judentums*, vols. xlvi.-xlvii. (1902-1903). The negative criticisms of Kusters have, however, been strengthened by his replies (in the *Dutch Theolog. Tijdschrift*), and by the discussions of C. C. Torrey and C. F. Kent (*op. cit.*) and of G. Jahn (*Ezra u. Neh.* pp. i-lxxviii; 1909), and his general position appears to do more justice to the biblical evidence as a whole. (S. A. C.)

EZZO, or EHRENFRIED (c. 954-1024), count palatine in Lorraine, was the son of a certain Hermann (d. c. 1000), also a count palatine in Lorraine who had possessions in the neighbourhood of Bonn. Having married Matilda (d. 1025), a daughter of the emperor Otto II., Ezzo came to the front during the reign of his brother-in-law, the emperor Otto III. (983-1002); his power was increased owing to the liberal grant of lands in Thuringia and Franconia which he received with his wife, and some time later his position as count palatine was recognized as an hereditary dignity. Otto's successor, the emperor Henry II., was less friendly towards the powerful count palatine, though there was no serious trouble between them until 1011; but some disturbances in Lorraine quickly compelled the emperor to come to terms, and the assistance of Ezzo was purchased by a gift of lands. Henceforward the relations between Henry and his vassal appear to have been satisfactory. Very little is known about Ezzo's later life, but we are told that he died at a great age at Saalfeld on the 21st of March 1024. He left three sons, among them being Hermann, who was archbishop of Cologne from 1036 to 1056, and Otto, who was for a short time duke of Swabia; and seven daughters, six of whom became abbesses. Ezzo founded a monastery at Brauweiler near Cologne, the place where his marriage had been celebrated. This was dedicated in 1028 by Pilgrim, archbishop of Cologne, and here both Ezzo and his wife were buried.

EZZOLIED, or ANEGENGE, an old German poem, written by Ezzo, a scholar of Bamberg. It was written about 1060, but not, as one authority asserts, composed while the author was making a pilgrimage to Jerusalem. The subject of the poem is the life of Christ. Very popular during the later middle ages, the *Ezzolied* had a great influence on the poetry of south Germany, and is valuable as a monument of the poetical literature of the time.

The text is printed in the *Denkmäler deutscher Poesie und Prosa aus dem 8-12. Jahrhundert* (Berlin, 1892) of C. V. Müllenhoff and W. Scherer.

F This is the sixth letter of the English alphabet as it was of the Latin. In the ordinary Greek alphabet the symbol has disappeared, although it survived far into historical times in many Greek dialects as *F*, the digamma, the use of which in early times was inductively proved by Bentley, when comparatively little was known of the local alphabets and dialects of Greece. The so-called *stigma 5*, which serves for the numeral 6, is all that remains to represent it. This symbol derives its name from its resemblance in mediæval MSS. to the abbreviation for *σ*. The symbol occupying the same position in the Phœnician alphabet was *Vau* (𐤅 𐤆), which seems to be represented by the Greek *Υ*, the Latin *V*, at the end of the early alphabet. Many authorities therefore contend that *F* is only a modification of the preceding symbol *E* and has nothing to do with the symbol *Vau*. In some early Latin inscriptions *F* is represented by *𐌃*, as *E* is by *𐌄*. It must be admitted that the resemblance between the sixth symbol of the Phœnician alphabet and the corresponding symbol of the European alphabet is not striking. But the position of the limbs of symbols in early alphabets often varies surprisingly. In Greek, besides *F* we find for *f* in Pamphylia (the only Greek district in Asia which possesses the symbol) *𐌃*, and in Boeotia, Thessaly, Tarentum, Cumæ and on Chalcidian vases of Italy the form *𐌃*, though except at Cumæ and on the vases the form *F* exists contemporaneously with *𐌃* or even earlier. At the little town of Falerii (Civita Castellana), whose alphabet is undoubtedly of the same origin as the Latin, *F* takes the form *𐌃*. Though uncertain, therefore, it seems not impossible that the original symbol of the Phœnician alphabet, which was a consonant like the English *w*, may have been differentiated in Greek into two symbols, one indicating the consonant value *w* and retaining the position of the Phœnician consonant *Vau*, the other having the vowel value *u*, which ultimately most dialects changed to a modified sound like French *u* or German *ü*. Be this as it may, the value of the symbol *F* in Greek was *w*, a bilabial voiced sound, not the labio-dental unvoiced sound which we call *f*. When the Romans adopted the Greek alphabet they took over the symbols with their Greek values. But Greek had no sound corresponding to the Latin *f*, for *φ* was pronounced *p-h*, like the final sound of *lip* in ordinary English or the initial sound of *pig* in Irish English. Consequently in the very old inscription on a gold fibula found at Praeneste and published in 1887 (see ALPHABET) the Latin *f* is represented by *FB*. Later, as Latin did not use *F* for the consonant written as *v* in *vis*, &c., *H* was dropped and *F* received a new special value in Latin as representative of the unvoiced labio-dental spirant. In the Oscan and Umbrian dialects, whose alphabet was borrowed from Etruscan, a special form appears for *f*, viz. *𐌃*, the old form *𐌃* being kept for the other consonant *v* (i.e. English *w*). The *𐌃* has generally been asserted to be developed out of the second element in the combination *FB*, its upper and lower halves being first converted into lozenges, *𐌃*, which naturally changed to *𐌃* when inscribed without lifting the writing or incising implement. Recent discoveries, however, make this doubtful (see ALPHABET). (P. GI.)

FABBRONI, ANGELO (1732–1803), Italian biographer, was born at Marradi in Tuscany on the 25th of September 1732. After studying at Faenza he entered the Roman college founded for the education of young Tuscans. On the conclusion of his studies he continued his stay in Rome, and having been introduced to the celebrated Jansenist Bottari, received from him the canonry of Santa Teresa in Trastevere. Some time after this he was chosen to preach a discourse in the pontifical chapel before Benedict XIV. and made such a favourable impression that the pontiff settled on him an annuity, with the possession of which Fabbroni was able to devote his whole time to study. He was

intimate with Leopold I., grand-duke of Tuscany, but the Jesuits disliked him on account of his Jansenist views. Besides his other literary labours he began at Pisa in 1771 a literary journal, which he continued till 1796. About 1772 he made a journey to Paris, where he formed the acquaintance of Condorcet, Diderot, d'Alembert, Rousseau and most of the other eminent Frenchmen of the day. He also spent four months in London. He died at Pisa on the 22nd of September 1803.

The following are his principal works:—*Vitæ Itatorum doctrina excellentium qui sæculis XVII. et XVIII. floruerunt* (20 vols., Pisa, 1778–1799, 1804–1805), the last two vols., published posthumously, contain a life of the author; *Laurentii Medicei Magnifici Vita* (2 vols., Pisa, 1784), a work which served as a basis for H. Roscoe's *Life of Lorenzo dei Medici*; *Leonis X. pontificis maximi Vita* (Pisa, 1797); and *Elogi di Dante Alighieri, di Angelo Poliziano, di Lodovico Ariosto, e di Torq. Tasso* (Parma, 1800).

FABER, the name of a family of German lead-pencil manufacturers. Their business was founded in 1760 at Stein, near Nuremberg, by Kaspar Faber (d. 1784). It was then inherited by his son Anton Wilhelm (d. 1819). Georg Leonhard Faber succeeded in 1810 (d. 1839), and the business passed to Johann Lothar von Faber (1817–1896), the great-grandson of the founder. At the time of his assuming control about twenty hands were employed, under old-fashioned conditions, and owing to the invention of the French *crayons Contés* of Nicolas Jacques Conté (*q.v.*) competition had reduced the entire Nuremberg industry to a low ebb (see PENCIL). Johann introduced improvements in machinery and methods, brought his factory to the highest state of efficiency, and it became a model for all the other German and Austrian manufacturers. He established branches in New York, Paris, London and Berlin, and agencies in Vienna, St Petersburg and Hamburg, and made his greatest *coup* in 1856, when he contracted for the exclusive control of the graphite obtained from the East Siberian mines. Faber had also branched out into the manufacture of water-colour and oil paints, inks, slates and slate-pencils, and engineers' and architects' drawing instruments, and built additional factories to house his various industries at New York and at Noisy-le-Sec, near Paris, and had his own cedar mills in Florida. For his services to German industry he received a patent of nobility and an appointment as councillor of state. After the death of his widow (1903) the business was inherited by his grand-daughter Countess Otilie von Faber-Castell and her husband, Count Alexander.

FABER, BASIL (1520–c. 1576), Lutheran schoolmaster and theologian, was born at Sorau, in lower Lusatia, in 1520. In 1538 he entered the university of Wittenberg, studying as *pauper gratis* under Melancthon. Choosing the schoolmaster's profession, he became successively rector of the schools at Nordhausen, Tennstadt (1555), Magdeburg (1557) and Quedlinburg (1560). From this last post he was removed in December 1570 as a Crypto-Calvinist. In 1571 he was appointed to the Raths-gymnasium at Erfurt, not as rector, but as director (*Vorsteher*). In this situation he remained till his death in 1575 or 1576. His translation of the first twenty-five chapters of Luther's commentary on Genesis was published in 1557; in other ways he promoted the spread of Lutheran views. He was a contributor to the first four of the *Magdeburg Centuries*. He is best known by his *Thesaurus eruditionis scholasticæ* (1571; last edition, improved by J. H. Leich, 1749, folio, 2 vols.); this was followed by his *Libellus de disciplina scholastica* (1572).

See Wagenmann and G. Müller in Herzog-Hauck's *Realencyklopädie* (1898). (A. Go.)*

FABER, FREDERICK WILLIAM (1814–1863), British hymn writer and theologian, was born on the 28th of June 1814 at Calverley, Yorkshire, of which place his grandfather, Thomas Faber, was vicar. He attended the grammar school of Bishop Auckland for a short time, but a large portion of his boyhood was spent in Westmorland. He afterwards went to Harrow

and to Balliol College, Oxford. In 1835 he obtained a scholarship at University College; and in 1836 he gained the Newdigate prize for a poem on "The Knights of St John," which elicited special praise from Keble. Among his college friends were Dean Stanley and Roundell Palmer, 1st earl of Selborne. In January 1837 he was elected fellow of University College. Meanwhile he had given up the Calvinistic views of his youth, and had become an enthusiastic follower of John Henry Newman. In 1841 a travelling tutorship took him to the continent; and on his return a book appeared called *Sights and Thoughts in Foreign Churches and among Foreign Peoples* (London, 1842), with a dedication to his friend the poet Wordsworth. He accepted the rectory of Elton in Huntingdonshire, but soon after went again to the continent, in order to study the methods of the Roman Catholic Church; and after a prolonged mental struggle he joined the Roman Catholic communion in November 1845. He founded a religious community at Birmingham, called Wilfridians, which was ultimately merged in the oratory of St Philip Neri, with John Henry Newman as Superior. In 1849 a branch of the oratory—subsequently independent—was established in London, first in King William Street, and afterwards at Brompton, over which Faber presided till his death on the 26th of September 1863. In spite of his weak health, an almost incredible amount of work was crowded into those years. He published a number of theological works, and edited the *Oratorian Lives of the Saints*. He was an eloquent preacher, and a man of great charm of character. It is mainly as a hymn-writer, however, that Faber is remembered. Among his best-known hymns are:—"The Greatness of God," "The Will of God," "The Eternal Father," "The God of my Childhood," "Jesus is God," "The Pilgrims of the Night," "The Land beyond the Sea," "Sweet Saviour, bless us ere we go," "I was wandering and weary," and "The Shadow of the Rock." The hymns are largely used in Protestant collections. In addition to many pamphlets and translations, Faber published the following works: *All for Jesus; The Precious Blood; Bethlehem; The Blessed Sacrament; The Creator and the Creature; Growth of Holiness; Spiritual Conferences; The Foot of the Cross* (8 vols., London, 1853-1860).

See his *Life and Letters*, by Father J. E. Bowden (London, 1869), and *A Brief Sketch of the Early Life of the late F. W. Faber, D.D.*, by his brother the Rev. F. A. Faber (London, 1869).

FABER, FABRI or FABRY (surnamed STAPULENSIS), **JACOBUS** [Jacques Lefèvre d'Étaples] (c. 1455-c. 1536), a pioneer of the Protestant movement in France, was born of humble parents at Étaples, in Pas de Calais, Picardy, about 1455. He appears to have been possessed of considerable means. He had already been ordained priest when he entered the university of Paris for higher education. Hermonymus of Sparta was his master in Greek. He visited Italy before 1486, for he heard the lectures of Argyropulus, who died in that year; he formed a friendship with Paulus Aemilius of Verona. In 1492 he again travelled in Italy, studying in Florence, Rome and Venice, making himself familiar with the writings of Aristotle, though greatly influenced by the Platonic philosophy. Returning to Paris, he became professor in the college of Cardinal Lemoine. Among his famous pupils were F. W. Vatable and Farel; his connexion with the latter drew him to the Calvinistic side of the movement of reform. At this time he began the publication, with critical apparatus, of Boëtius (*De Arithmetica*), and Aristotle's *Physics* (1492), *Ethics* (1497), *Metaphysics* (1501) and *Politics* (1506). In 1507 he took up his residence in the Benedictine Abbey of St Germain des Prés, near Paris; this was due to his connexion with the family of Briçonnet (one of whom was the superior), especially with William Briçonnet, cardinal bishop of St Malo (Meaux). He now began to give himself to Biblical studies, the first-fruit of which was his *Quintuplex Psalterium: Gallicum, Romanum, Hebraicum, Vetus, Conciliatum* (1509); the *Conciliatum* was his own version. This was followed by *S. Pauli Epistolae xiv. ex vulgata editione, adjecta intelligentia ex Græco cum commentariis* (1512), a work of great independence and judgment. His *De Maria Magdalena et triduo Christi disceptatio* (1517) provoked violent controversy and was condemned by the Sorbonne (1521). He had left Paris

during the whole of 1520, and, removing to Meaux, was appointed (May 1, 1523) vicar-general to Bishop Briçonnet, and published his French version of the New Testament (1523). This (contemporary with Luther's German version) has been the basis of all subsequent translations into French. From this, in the same year, he extracted the versions of the Gospels and Epistles "à l'usage du diocèse de Meaux." The prefaces and notes to both these expressed the view that Holy Scripture is the only rule of doctrine, and that justification is by faith alone. He incurred much hostility, but was protected by Francis I. and the princess Margaret. Francis being in captivity after the battle of Pavia (February 25, 1525), Faber was condemned and his works suppressed by commission of the parlement; these measures were quashed on the return of Francis some months later. He issued *Le Psautier de David* (1525), and was appointed royal librarian at Blois (1526); his version of the Pentateuch appeared two years later. His complete version of the Bible (1530), on the basis of Jerome, took the same place as his version of the New Testament. Margaret (now queen of Navarre) led him to take refuge (1531) at Nérac from persecution. He is said to have been visited (1533) by Calvin on his flight from France. He died in 1536 or 1537.

See C. H. Graf, *Essai sur la vie et les écrits* (1842); G. Bonet-Maury, in A. Herzog-Hauck's *Realencyklopädie* (1898). (A. Go.)*

FABER (or LEFÈVRE), **JOHANN** (1478-1541), German theologian, styled from the title of one of his works "*Malleus Haereticorum*," son of one Heigerlin, a smith (*faber*), was born at Leutkirch, in Swabia, in 1478. His early life is obscure; the tradition that he joined the Dominicans is untenable. He studied theology and canon law at Tübingen and at Freiburg im Breisgau, where he matriculated on the 26th of July 1509, and graduated M.A. and doctor of canon law. He was soon appointed vicar of Lindau and Leutkirch, and shortly afterwards canon of Basel. In 1518 Hugo von Landenberg, bishop of Constance, made him one of his vicars-general, and Pope Leo X. appointed him papal protonotary. He was an advocate of reforms, in sympathy with Erasmus, and corresponded (1519-1520) with Zwingli. While he defended Luther against Eck, he was as little inclined to adopt the position of Luther as of Carlstadt. His journey to Rome in the autumn of 1521 had the result of estranging him from the views of the Protestant leaders. He published *Opus adversus nova quaedam dogmata Lutheri* (1522), and appeared as a disputant against Zwingli at Zürich (1523). Then followed his *Malleus in haeresin Lutheranam* (1524). Among his efforts to stem the tide of Protestant innovation was the establishment of a training-house for the maintenance and instruction of popular preachers, drawn from the lower ranks, to compete with the orators of reform. In 1526 he became court preacher to the emperor Ferdinand, and in 1527 and 1528 was sent by him as envoy to Spain and England. He approved the death by burning of Balthasar Hubmeier, the Baptist, at Vienna on the 10th of March 1528. In 1531 he was consecrated bishop of Vienna, and combined with this (till 1538) the administration of the diocese of Neustadt. He died at Vienna on the 21st of May 1541. His works were collected in three volumes, 1537, 1539 and 1541.

See C. E. Kettner, *Diss. de J. Fabri Vita Scriptisque* (1737); Wagenmann and Egli in Herzog-Hauck's *Realencyklopädie* (1898). (A. Go.)*

FABERT, ABRAHAM DE (1599-1660), marshal of France, was the son of Abraham Fabert, seigneur de Moulins (d. 1638), a famous printer who rendered great services, civil and military, to Henry IV. At the age of fourteen he entered the *Gardes françaises*, and in 1618 received a commission in the Piedmont regiment, becoming major in 1627. He distinguished himself repeatedly in the constant wars of the period, notably in La Rochelle and at the siege of Exilles in 1630. His bravery and engineering skill were again displayed in the sieges of Avesnes and Maubeuge in 1637, and in 1642 Louis XIII. made him governor of the recently-acquired fortress of Sedan. In 1651 he became lieutenant-general, and in 1654 at the siege of Stenay he introduced new methods of siegecraft which anticipated in a measure the great improvements of Vauban. In 1658 Fabert was made a marshal of France, being the first commoner to attain that rank. He died at Sedan on the 17th of May 1660.

See *Histoire du maréchal de Fabert* (Amsterdam, 1697); P. Barre, *Vie de Fabert* (Paris, 1752); A. Feillet, *Le Premier Maréchal de France plébien* (Paris, 1869); Bourelly, *Le Maréchal Fabert* (Paris, 1880).

FABIAN [FABIANUS], **SAINT** (d. 250), pope and martyr, was chosen pope, or bishop of Rome, in January 236 in succession to Anteros. Eusebius (*Hist. Eccl.* vi. 29) relates how the Christians, having assembled in Rome to elect a new bishop, saw a dove alight upon the head of Fabian, a stranger to the city, who was thus marked out for this dignity, and was at once proclaimed bishop, although there were several famous men among the candidates for the vacant position. Fabian was martyred during the persecution under the emperor Decius, his death taking place on the 20th of January 250, and was buried in the catacomb of Calixtus, where a memorial has been found. He is said to have baptized the emperor Philip and his son, to have done some building in the catacombs, to have improved the organization of the church in Rome, to have appointed officials to register the deeds of the martyrs, and to have founded several churches in France. His deeds are thus described in the *Liber Pontificalis*: "Hic regiones dividit diaconibus et fecit vii subdiacones, qui vii notariis imminerent, ut gestas martyrum integro fideliter colligerent, et multas fabricas per cymiteria fieri praecepit." Although there is very little authentic information about Fabian, there is evidence that his episcopate was one of great importance in the history of the early church. He was highly esteemed by Cyprian, bishop of Carthage; Novatian refers to his *nobilissimae memoriae*, and he corresponded with Origen. One authority refers to him as Flavian.

See the article on "Fabian" by A. Harnack in Herzog-Hauck's *Realencyklopädie*, Band v. (Leipzig, 1898).

FABIUS, the name of a number of Roman soldiers and statesmen. The Fabian gens was one of the oldest and most distinguished patrician families of Rome. Its members claimed descent from Hercules and a daughter of the Arcadian Evander. From the earliest times it played a prominent part in Roman history, and was one of the two gentes exclusively charged with the management of the most ancient festival in Rome—the Lupercalia (Ovid, *Fasti*, ii. 375). The chief family names of the Fabian gens or clan, in republican times, were Vibulanus, Ambustus, Maximus, Buteo, Pictor, Dorso, Labeo; with surnames Verrucosus, Rullianus, Gurgus, Aemilianus, Allobrogicus (all of the Maximus branch). The most important members of the family are the following:—

1. **MARCUS FABIUS AMBUSTUS**, pontifex maximus in the year of the capture of Rome by the Gauls (390). His three sons, Quintus, Numerius and Caeso, although they had been sent as ambassadors to the Gauls when they were besieging Clusium, subsequently took part in hostilities (Livy v. 35). The Gauls thereupon demanded their surrender, on the ground that they had violated the law of nations; the Romans, by way of reply, elected them consular tribunes in the following year. The result was the march of the Gauls upon Rome, the battle of the Allia, and the capture of the city (Livy vi. 1).

2. **Q. FABIUS MAXIMUS**, surnamed *Rullianus* or *Rullus*, master of the horse in the second Samnite War to L. Papirius Cursor, by whom he was degraded for having fought the Samnites contrary to orders (Livy viii. 30), in spite of the fact that he gained a victory. In 315, when dictator, he was defeated by the Samnites at Lautulae (Livy ix. 23). In 310 he defeated the Etruscans at the Vadimonian Lake. In 295, consul for the fifth time, he defeated, at the great battle of Sentinum, the combined forces of the Etrurians, Umbrians, Samnites and Gauls (see *ROME: History*, II. "The Republic"). As censor (304) he altered the arrangement of Appius Claudius Caecus, whereby the freedmen were taken into all the tribes, and limited them to the four city tribes. For this he is said to have received the title of *Maximus*, as the deliverer of the comitia from the rule of the mob (Livy ix. 46), but there is reason to think that this title was first conferred on his grandson. It is probable that his achievements are greatly exaggerated by historians favourable to the Fabian house.

3. **QUINTUS FABIUS MAXIMUS**, surnamed *Verrucosus* (from a

wart on his lip), *Ovicula* ("the lamb," from his mild disposition), and *Cunctator* ("the delayer," from his cautious tactics in the war against Hannibal), grandson of the preceding. He served his first consulship in Liguria (233 B.C.), was censor (230) and consul for the second time (228). In 218 he was sent to Carthage to demand satisfaction for the attack on Saguntum (Livy xxi. 18). According to the well-known story, he held up a fold of his toga and offered the Carthaginians the choice between peace and war. When they declared themselves indifferent, he let fall his toga with the words, "Then take war." After the disastrous campaign on the Trebia, and the defeat on the banks of the Trasimene Lake, Fabius was named dictator (Livy calls him pro-dictator, since he was nominated, not by the consul, but by the people) in 217, and began his tactics of "masterly inactivity." Manoeuvring among the hills, where Hannibal's cavalry were useless, he cut off his supplies, harassed him incessantly, and did everything except fight. His steady adherence to his plan caused dissatisfaction at Rome and in his own camp, and aroused the suspicion that he was merely endeavouring to prolong his command. Minucius Rufus, his master of the horse, seized the opportunity, during the absence of Fabius at Rome, to make an attack upon the enemy which proved successful. The people, more than ever convinced that a forward movement was necessary, divided the command between Minucius and Fabius (Livy xxii. 15. 24; Polybius iii. 88). Minucius was led into an ambushade by Hannibal, and his army was only saved by the opportune arrival of Fabius. Minucius confessed his mistake and henceforth submitted to the orders of Fabius (Livy xxiii. 32). At the end of the legal time of six months Fabius resigned the dictatorship and the war was carried on by the consuls. The result of the abandonment of Fabian tactics was the disaster of Cannae (216). In 215 and 214 (as consul for the third and fourth times) he was in charge of the operations against Hannibal together with Claudius Marcellus (Livy xxiii. 39). He laid siege to Capua, which had gone over to Hannibal after Cannae, and captured the important position of Casilinum; in his fifth consulship (209) he retook Tarentum, which had been occupied by Hannibal for three years (Livy xxvii. 15; Polybius xiii. 4; Plutarch, *Fabius*). He died in 203. Fabius was a strenuous opponent of the new aggressive policy, and did all he could to prevent the invasion of Africa by Scipio. He was distinguished for calmness and prudence, while by no means lacking in courage when it was required. In his later years, however, he became morose, and showed jealousy of rising young men, especially Scipio (*Life* by Plutarch; Livy xx.-xxx.; Polybius iii. 87-106).

4. **Q. FABIUS MAXIMUS AEMILIANUS**, eldest son of L. Aemilius Paullus, adopted by Fabius Cunctator. He served in the last Macedonian War (168), and, as consul, defeated Viriathus in Spain (Livy, *Epit.* 52). He was the pupil and patron of Polybius (Polybius xviii., xxix. 6, xxxii. 8-10; Livy xlv. 35).

5. **Q. FABIUS MAXIMUS ALLOBROGICUS**, son of the above, consul 121 in Gaul. He obtained his surname from his victory over the Allobroges and Arverni in that year (Vell. Pat. ii. 10; Eutropius iv. 22). As censor (108) he erected the first triumphal arch.

6. **Q. FABIUS VIBULANUS**, with his brothers Caeso and Marcus, filled the consulship for seven years in succession (485-479 B.C.). In the last year there was a reaction against the family, in consequence of Caeso espousing the cause of the plebeians. Thereupon the Fabii—to the number, it is said, of 306 patricians, with some 5000 dependents—emigrated from Rome under the leadership of Caeso, and settled on the banks of the Cremera, a few miles above Rome. For two years the exiles continued to be the city's chief defence against the Veientes, until at last they were surprised and cut off. The only survivor of the gens was Quintus, the son of Marcus, who apparently took no part in the battle. The story that he had been left behind at Rome on account of his youth cannot be true, as he was consul ten years afterwards. This Quintus was consul in 467, 465 and 459, and a member of the second decemvirate in 450, on the fall of which he went into voluntary exile (Livy ii. 42, 48-50, iii. 1, 0, 41, 58, vi. 1; Dion. Halic. viii. 82-86, ix. 14-22; Ovid, *Fasti*, ii. 195).

The Fabian name is met with as late as the 2nd century A.D. A complete list of the Fabii will be found in de Vit's *Onomasticon*; see also W. N. du Rieu, *Disputatio de Gente Fabia* (1856), containing an account of 57 members of the family.

FABIUS PICTOR, QUINTUS, the father of Roman history, was born about 254 B.C. He was the grandson of Gaius Fabius, who received the surname *Pictor* for his painting of the temple of Salus (302). He took an active part in the subjugation of the Gauls in the north of Italy (225), and after the battle of Cannae (216) was employed by the Romans to proceed to Delphi in order to consult the oracle of Apollo. He was the earliest prose writer of Roman history. His materials consisted of the *Annales Maximi*, *Commentarii Consulares*, and similar records; the chronicles of the great Roman families; and his own experiences in the Second Punic War. He is also said to have made much use of the Greek historian Diocles of Peparethus. His work, which was written in Greek, began with the arrival of Aeneas in Italy, and ended with the Hannibalic war. Although Polybius and Dionysius of Halicarnassus frequently find fault with him, the first uses him as his chief authority for the Second Punic War. A Latin version of the work was in existence in the time of Cicero, but it is doubtful whether it was by Fabius Pictor or by a later writer with whom he was confused—Q. Fabius Maximus Servilianus (consul 142); or there may have been two annalists of the name of Fabius Pictor.

Fragments in H. Peter, *Historicorum Romanorum Fragmenta* (1883); see also ANNALISTS and LIVY, and Teuffel-Schwabe, *History of Roman Literature*, § 116.

FABLE (Fr. *fable*, Lat. *fabula*). With certain restrictions, the necessity of which will be shown in the course of the article, we may accept the definition of "fable" which Dr Johnson proposes in his *Life of Gay*: "A fable or apologue seems to be, in its genuine state, a narrative in which beings irrational, and sometimes inanimate (*arbores loquuntur, non tantum feræ*), are, for the purpose of moral instruction, feigned to act and speak with human interests and passions." The description of La Fontaine, the greatest of fabulists, is a poetic rendering of Johnson's definition:

"Fables in sooth are not what they appear;
Our moralists are mice, and such small deer.
We yawn at sermons, but we gladly turn
To moral tales, and so amused we learn."

The fable is distinguished from the myth, which grows and is not made, the spontaneous and unconscious product of primitive fancy as it plays round some phenomenon of natural or historical fact. The literary myth, such as, for instance, the legend of Pandora in Hesiod or the tale of Er in the *Republic* of Plato, is really an allegory, and differs from the fable in so far as it is self-interpreting; the story and the moral are intermingled throughout. Between the parable and the fable there is no clear line of demarcation, and theologians like Trench have unwarrantably narrowed their definition of a parable to fit those of the New Testament. The soundest distinction is drawn by Neander. In the fable human passions and actions are attributed to beasts; in the parable the lower creation is employed only to illustrate the higher life and never transgresses the laws of its kind. But whether Jotham's apologue of the trees choosing a king, perhaps the first recorded in literature, should be classed as a fable or a parable is hardly worth disputing. Lastly, we may point out the close affinity between the fable and the proverb. A proverb is often a condensed or fossilized fable, and not a few fables are amplified or elaborated proverbs.

The history of the fable goes back to the remotest antiquity, and Aesop has even less claim to be reckoned the father of the fable than has Homer to be entitled the father of poetry. The fable has its origin in the universal impulse of men to express their thoughts in concrete images, and is strictly parallel to the use of metaphor in language. It is the most widely diffused if not the most primitive form of literature. Though it has fallen from its high place it still survives, as in J. Chandler Harris's *Uncle Remus* and Rudyard Kipling's *Jungle Book*. The Arab of to-day will invent a fable at every turn of the conversation as the readiest form of argument, and in the *Life* of Coventry Patmore it is told how an impromptu fable of his about the pious dormouse found its way into Catholic books of devotion.

With the fable, as we know it, the moral is indispensable. As La Fontaine puts it, an apologue is composed of two parts, body and soul. The body is the story, the soul the morality. But if we revert to the earliest type we shall find that this is no longer the case. In the primitive beast-fable, which is the direct progenitor of the Aesopian fable, the story is told simply for its own sake, and is as innocent of any moral as the fairy tales of Little Red Riding-Hood and Jack and the Beanstalk. Thus, in a legend of the Flathead Indians, the Little Wolf found in cloud-land his grandsires the Spiders with their grizzled hair and long crooked nails, and they spun balls of thread to let him down to earth; when he came down and found his wife the Speckled Duck, whom the Old Wolf had taken from him, she fled in confusion, and this is why she lives and dives alone to this very day. Such animal myths are as common in the New World as in the Old, and abound from Finland and Kamtchatka to the Hottentots and Australasians. From the story invented, as the one above quoted, to account for some peculiarity of the animal world, or told as a pure exercise of the imagination, just as a sailor spins a yarn about the sea-serpent, to the moral apologue the transition is easy; and that it has been effected by savages unaided by the example of higher races seems sufficiently proved by the tales quoted by E. B. Tylor (*Primitive Culture*, vol. i. p. 411). From the beast-fables of savages we come next to the Oriental apologues, which we still possess in their original form. The East, the land of myth and legend, is the natural home of the fable, and Hindustan was the birthplace, if not of the original of these tales, at least of the oldest shape in which they still exist. The *Pancha Tantra* (2nd century B.C.), or fables of the Brahma Vishnu Sarman, have been translated from Sanskrit into almost every language and adapted by most modern fabulists. The *Kalilah* and *Dimna* (names of two jackals), or fables of Bidpai (or Pilpai), passed from India to western Europe through the successive stages of Pahlavi (ancient Persian), Arabic, Greek, Latin. By the end of the 16th century there were Italian, French and English versions. There is an excellent Arabic edition (Paris, 1816) with an introduction by Sylvestre de Sacy. The *Hitopadesa*, or "friendly instruction," is a modernized form of the same work, and of it there are three translations into English by Dr Charles Wilkins, Sir William Jones and Professor F. Johnson. The *Hitopadesa* is a complete chaplet of fables loosely strung together, but connected so as to form something of a continuous story, with moral reflections freely interspersed, purporting to be written for the instruction of some dissolute young princes. Thus, in the first fable a flock of pigeons see the grains of rice which a fowler has scattered, and are about to descend on them, when the king of the pigeons warns them by telling the fable of a traveller who being greedy of a bracelet was devoured by a tiger. They neglect his warning and are caught in the net, but are afterwards delivered by the king of the mice, who tells the story of the Deer, the Jackal and the Crow, to show that no real friendship can exist between the strong and the weak, the beast of prey and his quarry, and so on to the end of the volume. Another book of Eastern fables is well worthy of notice, *Buddhaghosha's Parables*, a commentary on the *Dhammapada* or *Buddha's Paths of Virtue*. The original is in Pali, but an English translation of the Burmese version was made by Captain T. Rogers, R.E.

From Hindustan the Sanskrit fables passed to China, Tibet and Persia; and they must have reached Greece at an early age, for many of the fables which passed under the name of Aesop are identical with those of the East. Aesop to us is little more than a name, though, if we may trust a passing notice in Herodotus (ii. 134), he must have lived in the 6th century B.C. Probably his fables were never written down, though several are ascribed to him by Xenophon, Aristotle, Plutarch and other Greek writers, and Plato represents Socrates as beguiling his last days by versifying such as he remembered. Aristophanes alludes to them as merry tales, and Plato, while excluding the poets from his ideal republic, admits Aesop as a moral teacher. Of the various versions of *Aesop's Fables*, by far the most trustworthy is that of Babrius or Babrias, a Greek probably of the 3rd century A.D., who rendered them in choliambic verse. These,

which were long known in fragments only, were recovered in a MS. found by M. Minas in a monastery on Mount Athos in 1842, now in the British Museum.¹ An inferior version of the same in Latin iambs was made by Phaedrus, a slave of Thracian origin, brought to Rome in the time of Augustus and manumitted by him. Phaedrus professes to polish in senarian verse the rough-hewn blocks from Aesop's quarry; but the numerous allusions to contemporary events, as, for example, his hit at Sejanus in the Frogs and the Sun, which brought upon the author disgrace and imprisonment, show that many of them are original or free adaptations. For some time scholars doubted as to the genuineness of Phaedrus's fables, but their doubts have been lately dispelled by a closer examination of the MSS. and by the discovery of two verses of a fable on a tomb at Apulum in Dacia. Phaedrus's style is simple, clear and brief, but dry and unpoetical; and, as Lessing has pointed out, he often falls into absurdities when he deserts his original. For instance, in Aesop the dog with the meat in his mouth sees his reflection in the water as he passes over a bridge; Phaedrus makes him see it as he swims across the river.

To sum up the characteristics of the Aesopian fable, it is artless, simple and transparent. It affects no graces of style, and we hardly need the text with which each concludes, *ὁ μῦθος δηλοῖ ὅτι, κ.τ.λ.* The moral inculcated is that of *Proverbial Philosophy* and *Poor Richard's Almanacks*. Aesop is no maker of phrases, but an orator who wishes to gain some point or induce some course of action. It is the Aesopian type that Aristotle has in view when he treats of the fable as a branch of rhetoric, not of poetry.

The Latin race was given to moralizing, and the language lent itself to crisp and pointed narrative, but they lacked the free play of fancy, the childlike "make-believe," to produce a national body of fables. With the doubtful exception of Phaedrus, we possess nothing but solitary examples, such as the famous apologue of Menenius Agrippa to the Plebs and the exquisite Town Mouse and Country Mouse of Horace's *Satires*.

The fables of the rhetorician Aphthonius about A.D. 400 in Greek prose, and those in Latin elegiac verse by Avianus, used for centuries as a text-book in schools, form in the history of the apologue a link between classical and medieval times. In a Latin dress, sometimes in prose, sometimes in regular verse, and sometimes in rhymed stanzas, the fable contributed, with other kinds of narratives, to make up the huge mass of stories which has been bequeathed to us by the monastic libraries. These served more uses than one. They were at once easier and safer reading than the classics. To the lazy monk they stood in place of novels; to the more industrious and gifted they furnished an exercise on a par with Latin verse composition in our public schools; the more original transformed them into *fabliaux*, or embodied them in edifying stories, as in the *Gesta Romanorum*. It is not in the *Speculum Doctrinale* of Vincent de Beauvais, a Dominican of the 12th century, nor in the collection of his contemporary Odo de Cerinton, an English Cistercian, nor in Planudes of the 14th century, whose one distinction is to have added to the fables a life of Aesop, that the direct lineage of La Fontaine must be traced. It is the *fabliaux* that inspired some of his best fables—the Lion's Court, the Young Widow, the Coach and the Fly.

As the supremacy of Latin declined and modern languages began to be turned to literary uses, the fable took a new life. Not only were there numerous adaptations of Aesop, known as *Ysopets*, but Marie de France in the 13th century composed many original fables, some rivalling La Fontaine's in simplicity and gracefulness. Later, also, fables were not wanting, though not numerous, in the English tongue. Chaucer has given us one, in his *Nonne Preste's Tale*, which is an expansion of the fable *Don Coc et don Werpil* of Marie de France; another is Lydgate's tale of *The Churl and the Bird*.

Several of Odo's tales, like Chaucer's story, can be ultimately

¹ M. Minas professed to have discovered under the same circumstances another collection of ninety-four fables by Babrius. This second part was accepted by Sir G. C. Lewis, but J. Conington conclusively proved it spurious, and probably a forgery. See **BABRIUS**.

traced to the History of Reynard the Fox. This great beast-epic has been referred by Grimm as far back as the 10th century, and is known to us in three forms, each with independent episodes, but all woven upon a common basis. The Latin form is probably the earliest, and the poems *Reinardus* and *Ysengrinus* date from the 10th or 11th century. Next come the German versions. The most ancient, that of a minnesinger Heinrich der Glicheaere (probably a Swabian), was analysed and edited by Grimm in 1840. The French poem of more than 30,000 lines, the *Roman du Rénéard*, belongs probably to the 13th century. In 1498 appeared *Reynke de Voss*, almost a literal version in Low Saxon of the Flemish poem of the 12th century, *Reinaert de Vos*. Hence the well-known version of Goethe into modern German hexameters was taken. The poem has been well named "an unholy world Bible." In it the Aesopian fable received a development which was in several respects quite original. We have here no short and unconnected stories. Materials, partly borrowed from older apologues, but in a much greater proportion new, are worked up into one long and systematic tale. The moral, so prominent in the fable proper, shrinks so far into the background, that the epic might be considered a work of pure fiction, an animal romance. The attempts to discover in it personal satire have signally failed; some critics deny even the design to represent human conduct at all; and we can scarcely get nearer to its signification than by regarding it as being, in a general way, what Carlyle has called "a parody of human life." It represents a contest maintained successfully, by selfish craft and audacity, against enemies of all sorts, in a half-barbarous and ill-organized society. With his weakest foes, like Chaunteclere the Cock, Reynard uses brute-force; over the weak who are protected, like Kiward the Hare and Belin the Ram, he is victorious by uniting violence with cunning; Bruin, the dull, strong, formidable Bear, is humbled by having greater power than his own enlisted against him; and the most dangerous of all the fox's enemies, Isengrim, the obstinate, greedy and implacable Wolf, after being baffled by repeated strokes of malicious ingenuity, forces Reynard to a single combat, but even thus is not a match for his dexterous adversary. The knavish fox has allies worthy of him in Grimbart the watchful badger, and in his own aunt Dame Rukenawe, the learned She-ape; and he plays at his pleasure on the simple credulity of the Lion-King, the image of an impotent feudal sovereign. The characters of these and other brutes are kept up with a rude kind of consistency, which gives them great liveliness; many of the incidents are devised with much force of humour; and the sly hits at the weak points of medieval polity and manners and religion are incessant and palpable.

It is needless to trace the fable, or illustrations borrowed from fables, that so frequently occur as incidental ornaments in the older literature of England and other countries. It has appeared in every modern nation of Europe, but has nowhere become very important, and has hardly ever exhibited much originality either of spirit or of manner. In English, Prior transplanted from France some of La Fontaine's ease of narration and artful artlessness, while Gay took as his model the *Contes* rather than the *Fables*. Gay's fables are often political satires, but some, like the Fox on his Deathbed, have the true ring, and in the Hare with many Friends there is genuine pathos. To Dryden's spirited remodelings of old poems, romances and *fabliaux*, the name of fables, which he was pleased to give them, is quite inapplicable. In German, Hagedorn and Gellert, both famous in their day and the latter extolled by Goethe, are quite forgotten; and even Lessing's fables are read by few but schoolboys. In Spanish, Yriarte's fables on literary subjects are sprightly and graceful, but the critic is more than the fabulist. A spirited version of the best appeared in *Blackwood's Magazine*, 1839. Among Italians Pignotti is famous for versatility and command of rhythm, as amongst Russians is Kriloff for his keen satire on Russian society. He has been translated into English by Ralston.

France alone in modern times has attained any pre-eminence in the fable, and this distinction is almost entirely owing to one author. Marie de France in the 13th century, Gilles Corrozet, Guillaume Haudent and Guillaume Gueroult in the 16th, are now

studied mainly as the precursors of La Fontaine, from whom he may have borrowed a stray hint or the outline of a story. The unique character of his work has given a new word to the French language: other writers of fables are called *fabulistes*, La Fontaine is named *le fablier*. He is a true poet; his verse is exquisitely modulated; his love of nature often reminds us of Virgil, as do his tenderness and pathos (see, for instance, *The Two Pigeons* and *Death and the Woodcutter*). He is full of sly fun and delicate humour; like Horace he satirizes without wounding, and "plays around the heart." Lastly, he is a keen observer of men. The whole society of the 17th century, its greatness and its foibles, its luxury and its squalor, from *Le grand monarque* to the poor *manant*, from his majesty the lion to the courtier of an ape, is painted to the life. To borrow his own phrase, La Fontaine's fables are "une ample comédie à cent actes divers." Rousseau did his best to discredit the *Fables* as immoral and corruptors of youth, but in spite of *Émile* they are studied in every French school and are more familiar to most Frenchmen than their breviary. Among the successors of La Fontaine the most distinguished is Florian. He justly estimates his own merits in the pretty apologue that he prefixed to his *Fables*. He asks a sage whether a fabulist writing after La Fontaine would not be wise to consign his work to the flames. The sage replies by a question: "What would you say did some sweet, ingenuous Maid of Athens refuse to let herself be seen because there was once a Helen of Troy?"

The fables of Lessing represent the reaction against the French school of fabulists. "With La Fontaine himself," says Lessing, "I have no quarrel, but against the imitators of La Fontaine I enter my protest." His attention was first called to the fable by Gellert's popular work published in 1746. Gellert's fables were closely modelled after La Fontaine's, and were a vehicle for lively railings against the fair sex, and hits at contemporary follies. Lessing's early essays were in the same style, but his subsequent study of the history and theory of the fable led him to discard his former model as a perversion of later times, and the "Fabeln," published in 1759, are the outcome of his riper views. Lessing's fables, like all that he wrote, display his vigorous common sense. He has, it is true, little of La Fontaine's *curiosa felicitas*, his sly humour and lightness of touch; and Frenchmen would say that his criticism of La Fontaine is an illustration of the fable of the sour grapes. On the other hand, he has the rare power of looking at both sides of a moral problem; he holds a brief for the stupid and the feeble, the ass and the lamb; and in spite of his formal protest against poetical ornament, there is in not a few of his fables a vein of true poetry, as in the *Sheep* (ii. 13) and *Jupiter and the Sheep* (ii. 18). But the monograph which introduced the *Fabeln* is of more importance than the fables themselves. According to Lessing the ideal fable is that of Aesop. All the elaborations and refinements of later authors, from Phaedrus to La Fontaine, are perversions of this original. The fable is essentially a moral precept illustrated by a single example, and it is the lesson thus enforced which gives to the fable its unity and makes it a work of art. The illustration must be either an actual occurrence or represented as such, because a fictitious case invented *ad hoc* can appeal but feebly to the reader's judgment. Lastly, the fable requires a story or connected chain of events. A single fact will not make a fable, but is only an emblem. We thus arrive at the following definition:—"A fable is a relation of a series of changes which together form a whole. The unity of the fable consists herein, that all the parts lead up to an end, the end for which the fable was invented being the moral precept."

We may notice in passing a problem in connexion with the fable which had long been debated, but never satisfactorily resolved till Lessing took it in hand—Why should animals have been almost universally chosen as the chief *dramatis personae*? The reason, according to Lessing, is that animals have distinct characters which are known and recognized by all. The fabulist who writes of Britannicus and Nero appeals to the few who know Roman history. The *Wolf and the Lamb* comes home to every one whether learned or simple. But, besides this,

human sympathies obscure the moral judgment; hence it follows that the fable, unlike the drama and the epos, should abstain from all that is likely to arouse our prejudices or our passions. In this respect the *Wolf and the Lamb* of Aesop is a more perfect fable than the *Rich Man and the Poor Man's Ewe Lamb* of Nathan.

Lessing's analysis and definition of the fable, though he seems himself unconscious of the scope of his argument, is in truth its death-warrant. The beast-fable arose in a primitive age when men firmly believed that beasts could talk and reason, that any wolf they met might be a were-wolf, that a peacock might be a Pythagoras in disguise, and an ox or even a cat a being worthy of their worship. To this succeeded the second age of the fable, which belongs to the same stage of culture as the Hebrew proverbs and the gnomic poets of Greece. That honesty is the best policy, that death is common to all, seemed to the men of that day profound truths worthy to be embalmed in verse or set off by the aid of story or anecdote. Last comes an age of high literary culture which tolerates the trite morals and hackneyed tales for the sake of the exquisite setting, and is amused at the wit which introduces topics and characters of the day under the transparent veil of animal life. Such an artificial product can be nothing more than the fashion of a day, and must, like pastoral poetry, die a natural death. A serious moralist would hardly choose that form to inculcate, like Mandeville in his *Fable of the Bees*, a new doctrine in morals, for the moral of the fable must be such that he who runs may read. A true poet will not care to masquerade as a moral teacher, or show his wit by refurbishing some old-world maxim. Yet Taine in France, Lowell in America, and J. A. Froude in England have proved that the fable as one form of literature is not yet extinct, and is capable of new and unexpected developments.

BIBLIOGRAPHY.—*Pantschatantrum*, ed. Kosegarten (Bonn, 1848); *Hitopadesa*, ed. Max Müller (1864); Silvestre de Sacy, *Calilah et Dimna, ou Fables de Bidpai, en Arabe, précédées d'un mémoire sur l'origine de ce livre* (Paris, 1816), translated by the Rev. Wyndham Knatchbull (Oxford, 1819); Comparetti, *Ricerche intorno al Libro di Sindebad* (Milan, 1869); Max Müller, "Migration of Fables," *Chips from a German Workshop*, vol. iv. (1875); Keller, *Untersuchungen über die Geschichte der griechischen Fabel* (Leipzig, 1862); *Babrius*, ed. W. G. Rutherford, with excursus on Greek fables (1883); L. Hervieux, *Les Fabulistes latins* (1884); Jakob Grimm, *Reinhart Fuchs* (Berlin, 1834); A. C. M. Robert, *Fables inédites des XII^e, XIII^e et XIV^e siècles, &c.* (Paris, 1825); Taine, *Essai sur les fables de La Fontaine* (1853); Saint-Marc Girardin, *La Fontaine et les fabulistes* (Paris, 1867). (F. S.)

FABLIAU. The entertaining tales in eight-syllable rhymed verse which form a marked section of French medieval literature are called *fabliaux*, the word being derived by Littré from *fabel*, a diminutive of *fable*. It is a mistake to suppose, as is frequently done, that every legend of the middle ages is a *fabliau*. In a poem of the 12th century a clear distinction is drawn between songs of chivalry, war or love, and *fabliaux*, which are recitals of laughter. A *fabliau* always related an event; it was usually brief, containing not more than 400 lines; it was neither sentimental, religious nor supernatural, but comic and gay. M. M. de Montaignon and Raynaud, who have closely investigated this class of literature, consider that about 150 *fabliaux* have come down to us more or less intact; a vast number have doubtless disappeared. It appears from a phrase in the writings of the trouvère, Henri d'Andeli, that the *fabliau* was not thought worthy of being copied out on parchment. The wonder, then, is that so many of these ephemeral compositions have been preserved. Arguments brought forward by M. Joseph Bédier, however, tend to show that we need not regret the disappearance of the majority of the *fabliaux*, as those which were copied into MSS. were those which were felt to be of the greatest intrinsic value. As early as the 8th century *fabliaux* must have existed, since the faithful are forbidden to take pleasure in these *fabulas inanes* by the *Paenitentiale* of Egbert. But it appears that all the early examples are lost.

In the opinion of the best scholars, the earliest surviving *fabliau* is that of *Richeu*, which dates from 1159. This is a rough and powerful study of the coarse life of the day, with little plot, but engaged with a realistic picture of manners.

Such poems, but of a more strictly narrative nature, continued to be produced, mainly in the north and north-east of France, until the middle of the 14th century. Much speculation has been expended on the probable sources of the tales which the *trouvères* told. The Aryan theory, which saw in them the direct influence of India upon Europe, has now been generally abandoned. It does not seem probable that any ancient or exotic influences were brought to bear upon the French jongleurs, who simply invented or adapted stories of that universal kind which springs unshown from every untilled field of human society. More remarkable than the narratives themselves is the spirit in which they are told. This is full of the national humour and the national irony, the true *esprit gaulois*. A very large section of these popular poems deals satirically with the pretensions of the clergy. Such are the famous *Prêtre aux mûres*, the *Prêtre qui dit la Passion* and *Les Perdrix*. Some of these are innocently merry; others are singularly depraved and obscene. Another class of fabliaux is that which comprises jests against the professions; in this, the most prominent example is *Le Vilain Mire*, a satire on doctors, which curiously predicts the *Médecin malgré lui* of Molière. There are also tales whose purpose is rather voluptuous than witty, and whose aim is to excuse libertinage and render marriage ridiculous. Among these are prominent *Court Mantel* and *Le Dit de Berenger*. Yet another class repeated, with a strain of irony or oddity, such familiar classical stories as those of Narcissus, and Pyramus and Thisbe. It is rarely that any elevation of tone raises these poems above a familiar and even playful level, but there are some that are almost idealistic. Among these the story of a sort of Sisyphus errant, *Le Chevalier de Barizel*, offers an ethical interest which lifts it in certain respects above all other surviving fabliaux. An instance of the pathetic fabliau is *Housse Partie*, a kind of primitive version of the story of King Lear.

In composing these pieces, of very varied character, the jongleurs have practised an art which was in many respects rudimentary, but sincere and simple. The student of language finds the rich vocabulary of the fabliaux much more attractive to him than the conventionality of the serious religious and amatory poems of the same age. The object of the writers was the immediate amusement of their audience; by reference to familiar things, they hoped to arouse a quick and genuine merriment. Hence their incorrectness and their negligence are balanced by a delightful ease and absence of pedantry, and in the fabliaux we get closer than elsewhere to the living diction of medieval France. It is true that if we extend too severe a judgment to these pieces, we may find ourselves obliged to condemn them altogether. An instructed French critic, vexed with their faults, has gone so far as to say that "the subjects of these tales are degrading, their inspiration nothing better than flat and cruel derision, their distinguishing features rascality, vulgarity and platitude of style." From one point of view, this condemnation of the fabliau is hardly too severe. But such scholars as Gaston Paris and Paul Meyer have not failed to emphasize other sides to the question. They have praised, in the general laxity of style and garrulity of the middle ages, the terseness of the jongleurs; in the period of false ornament, their fidelity to nature; in a time of general vagueness, the sharp and picturesque outlines of their art. One feature of the fabliaux, however, cannot be praised and yet must not be overlooked. In no other section of the world's literature is the scorn and hatred of women so prominent. It is difficult to account for the anti-feminine rage which pervades the fabliaux, and takes hideous shapes in such examples as *Le Valet aux deux femmes*, *Le Pêcheur de Pont-sur-Seine* and *Chicheface et Bigorne*. Probably this was a violent reaction against the extravagant cult of woman as expressed in the contemporary *lais* as well as in the legends of saints. The exaggeration was not greater in the one case than in the other, and it is probable that the exaltation was made endurable to those who listened to the *trouvères* by the corresponding degradation. We must remember, too, that those who listened were not nobles or clerks, they were the common people. The fabliaux were *fabellae ignobilium*, little

stories told to amuse persons of low degree, who were irritated by the moral pretensions of their superiors.

The names of about twenty of the authors of fabliaux have been preserved, although in most cases nothing is known of their personal history. The most famous poet of this class of writing is the man whose name, or more probably pseudonym, was Rutebeuf. He wrote *Frère Denyse* and *Le Sacristain*, while to him is attributed the *Dit d'Aristote*, in the course of which Aristotle gives good advice to Alexander. Fabliaux, however, form but a small part of the work of Rutebeuf, who was a satirical poet of wide accomplishment and varied energy. Most of the jongleurs who wrote these merry and indecent tales in octosyllabic verse were persons of less distinction. Henri d'Andeli was an ecclesiastic, attached, it is supposed, to the cathedral of Rouen. Jean de Condé, who flourished in the court of Hainaut from 1310 to 1340, and who is the latest of the genuine writers of fabliaux, lived in comfort and security, but most of the professional jongleurs seem to have spent their years in a Bohemian existence, wandering among the clergy and the merchant class, alternately begging for money and food and reciting their mocking verses.

The principal authorities for the fabliaux are MM. Anatole de Montaiglon and Gaston Raynaud, who published the text, in 6 vols., between 1872 and 1890. This edition corrected and supplemented the very valuable labours of Méon (1808-1823) and Jubinal (1839-1842). The works of Henri d'Andeli were edited by M. A. Héron in 1880, and those of Rutebeuf were made the subject of an exhaustive monograph by M. Léon Clédât in 1891. See also the editions of separate fabliaux by Gaston Paris, Paul Meyer, Ebeling, August Schéler and other modern scholars. M. Joseph Bedier's *Les Fabliaux* (1895) is a useful summary of critical opinion on the entire subject. (E. G.)

FABRE, FERDINAND (1830-1898), French novelist, was born at Bédarieux, in Hérault, a very picturesque district of the south of France, which he made completely his own in literature. He was the son of a local architect, who failed in business, and Ferdinand was brought up by his uncle, the Abbé Fulcran Fabre, at Camplong among the mulberry woods. Of his childhood and early youth he has given a charming account in *Ma Vocation* (1889). He was destined to the priesthood, and was sent for that purpose to the seminary of St Pons de Thomières, where, in 1848, he had, as he believed, an ecstatic vision of Christ, who warned him "It is not the will of God that thou shouldst be a priest." He had now to look about for a profession, and, after attempting medicine at Montpellier, was articulated as a lawyer's clerk in Paris. In 1853 he published a volume of verses, *Feuilles de lierre*, broke down in health, and crept back, humble and apparently without ambition, to his old home at Bédarieux. After some eight or nine years of country life he reappeared in Paris, with the MS. of his earliest novel, *Les Courbezons* (1862), in which he treated the subject which was to recur in almost all his books, the daily business of country priests in the Cevennes. This story enjoyed an immediate success with the literary class of readers; George Sand praised it, Sainte-Beuve hailed in its author "the strongest of the disciples of Balzac," and it was crowned by the French Academy. From this time forth Fabre settled down to the production of novels, of which at the time of his death he had published about twenty. Among these the most important were *Le Chevrier* (1868), unique among his works as written in an experimental mixture of Cevenol *patois* and French of the 16th century; *L'Abbé Tigrane, candidat à la papauté* (1873), by common consent the best of all Fabre's novels, a very powerful picture of unscrupulous priestly ambition; *Mon Oncle Cèlesin* (1881), a study of the entirely single and tender-hearted country abbé; and *Lucifer* (1884), a marvellous gallery of serious clerical portraits. In 1883 Fabre was appointed curator of the Mazarin Library, with rooms in the Institute, where, on 11th February 1898, he died after a brief attack of pneumonia. Ferdinand Fabre occupies in French literature a position somewhat analogous to that of Mr Thomas Hardy amongst English writers of fiction. He deals almost exclusively with the population of the mountain villages of Hérault, and particularly with its priests. He loved most of all to treat of the celibate virtues, the strictly ecclesiastical passions, the enduring tension of the young soul drawn between the spiritual

vocation and the physical demands of nature. Although never a priest, he preserved a comprehension of and a sympathy with the clerical character, and he always indignantly denied that he was hostile to the Church, although he stood just outside her borders. Fabre possessed a limited and a monotonous talent, but within his own field he was as original as he was wholesome and charming.

See also J. Lemaître, *Les Contemporains*, vol. ii.; G. Pellissier, *Études de littérature contemporaine* (1898); E. W. Gosse, *French Profiles* (1905). (E. G.)

FABRE D'ÉGLANTINE, PHILIPPE FRANÇOIS NAZAIRE (1750-1794), French dramatist and revolutionist, was born at Carcassonne on the 28th of July 1750. His real name was simple Fabre, the "d'Églantine" being added in commemoration of his receiving the golden eglantine of Clémence Isaure from the academy of the floral games at Toulouse. After travelling through the provinces as an actor, he came to Paris, and produced an unsuccessful comedy entitled *Les Gens de lettres, ou le provincial à Paris* (1787). A tragedy, *Augusta*, produced at the *Théâtre Français*, was also a failure. One only of his plays, *Philinte, ou la suite du Misanthrope* (1790), still preserves its reputation. It professes to be a continuation of Molière's *Misanthrope*, but the hero of the piece is of a different character from the nominal prototype—an impersonation, indeed, of pure and simple egotism. On its publication the play was introduced by a preface, in which the author mercilessly satirizes the *Optimiste* of his rival J. F. Collin d'Harleville, whose *Châteaux en Espagne* had gained the applause which Fabre's *Présomptueux* (1789) had failed to win. The character of Philinte had much political significance. Alceste received the highest praise, and evidently represents the citizen patriot, while Philinte is a dangerous aristocrat in disguise. Fabre was president and secretary of the club of the Cordeliers, and belonged also to the Jacobin club. He was chosen by Danton as his private secretary, and sat in the National Convention. He voted for the king's death, supporting the *maximum* and the law of the suspected, and he was a bitter enemy of the Girondins. After the death of Marat he published a *Portrait de l'Ami du Peuple*. On the abolition of the Gregorian calendar he sat on the committee entrusted with the formation of the republican substitute, and to him was due a large part of the new nomenclature, with its poetic *Prairial* and *Floréal*, its prosaic *Primidi* and *Duodi*. The report which he made on the subject, on the 24th of October, has some scientific value. On the 12th of January 1794 he was arrested by order of the committee of public safety on a charge of malversation and forgery in connexion with the affairs of the *Compagnie des Indes*. Documents still existing prove that the charge was altogether groundless. During his trial Fabre showed the greatest calmness and sang his own well-known song of *Il pleut, il pleut, bergère, rentre tes blancs moutons*. He was guillotined on the 5th of April 1794. On his way to the scaffold he distributed his manuscript poems to the people.

A posthumous play, *Les Précepteurs*, steeped with the doctrines of Rousseau's *Émile*, was performed on the 17th of September 1794, and met with an enthusiastic reception. Among Fabre's other plays are the gay and successful *Convalescent de qualité* (1791), and *L'Intrigue épistolaire* (1791). In the latter play Fabre is supposed to have drawn a portrait of the painter Jean Baptiste Greuze.

The author's *Œuvres mêlées et posthumes* were published at Paris 1802, 2 vols. See Albert Maurin, *Galerie hist. de la Révolution française*, tome 11; Jules Janin, *Hist. de la litt. dram.*; Chénier, *Tableau de la litt. française*; F. A. Aulard in the *Nouvelle Revue* (July 1885).

FABRETTI, RAPHAEL (1618-1700), Italian antiquary, was born in 1618 at Urbino in Umbria. He studied law at Cagli and Urbino, where he took the degree of doctor at the age of eighteen. While in Rome he attracted the notice of Cardinal Lorenzo Imperiali, who employed him successively as treasurer and auditor of the papal legation in Spain, where he remained thirteen years. Meanwhile, his favourite classical and antiquarian studies were not neglected; and on his return journey he made important observations of the relics and monuments of

Spain, France and Italy. At Rome he was appointed judge of appellation of the Capitol, which post he left to be auditor of the legation at Urbino. After three years he returned to Rome, on the invitation of Cardinal Carpegna, vicar of Innocent XI., and devoted himself to antiquarian research, examining with minute care the monuments and inscriptions of the Campagna. He always rode a horse which his friends nicknamed "Marco Polo," after the Venetian traveller. By Innocent XII. he was made keeper of the archives of the castle St Angelo, a charge which he retained till his death. He died at Rome on the 7th of January 1700. His collection of inscriptions and monuments was purchased by Cardinal Stoppani, and placed in the ducal palace at Urbino, where they may still be seen.

His work *De Aquis et Aquae-ductibus veteris Romae* (1680), three dissertations on the topography of ancient Latium, is inserted in Graevius's *Thesaurus*, iv. (1677). His interpretation of certain passages in Livy and other classical authors involved him in a dispute with Gronovius, which bore a strong resemblance to that between Milton and Salmasius, Gronovius addressing Fabretti as *Faber Rusticus*, and the latter, in reply, speaking of *Grunnovius* and his *litiivilitia*. In this controversy Fabretti used the pseudonym Iasitheus, which he afterwards took as his pastoral name in the Academy of the Arcadians. His other works, *De Columna Trajani Syntagma* (Rome, 1683), and *Inscriptionum Antiquarum Explicatio* (Rome, 1699), throw much light on Roman antiquity. In the former is to be found his explication of a bas-relief, with inscriptions, now in the Capitol at Rome, representing the war and taking of Troy, known as the Iliac table. Letters and other shorter works of Fabretti are to be found in publications of the time, as the *Journal des Savants*.

See Crescimbeni, *Le Vite degli Arcadi illustri*; Fabroni, *Vitae Italarum*, vi. 174; Nicéron, iv. 372; J. Lamius, *Memorabilia Italarum eruditione praestantium* (Florence, 1742-1748).

FABRIANI, SEVERINO (1792-1849), Italian author and teacher, was born at Spilamberto, Italy, on the 7th of January 1792. Entering the Church, he took up educational work, but in consequence of complete loss of voice he resolved to devote himself to teaching deaf mutes, and founded a small school specially for them. This school the duke of Modena made into an institute, and by a special authority from the pope a teaching staff of nuns was appointed. Fabriani's method of instruction is summed up in his *Logical Letters on Italian Grammar* (1847). He died on the 27th of April 1849.

FABRIANO, a town of the Marches, Italy, in the province of Ancona, from which it is 44 m. S.W. by rail, 1066 ft. above sea-level. Pop. (1901) town 9586, commune 22,996. It has been noted since the 13th century for its paper mills, which still produce the best paper in Italy. A school of painting arose here, one of the early masters of which is Allegretto Nuzi (1308-1385); and several of the churches contain works by him and other local masters. His pupil, Gentile da Fabriano (1370-1428), was a painter of considerably greater skill and wider knowledge; but there are no important works of his at Fabriano. The sacristy of S. Agostino also contains some good frescoes by Ottaviano Nelli of Gubbio. The municipal picture gallery contains a collection of pictures, and among them are some primitive frescoes, attributable to the 12th century, which still retain traces of Byzantine influence. The Archivio Comunale contains documents on watermarked paper of local manufacture going back to the 13th century. The Ponte dell' Acra, a bridge of the 15th century, is noticeable for the ingenuity and strength of its construction. The hospital of S. Maria Buon Gesu is a fine work of 1456, attributed to Rossellino.

See A. Zonghi, *Antiche Carte Fabrianesi*.

(T. As.)

FABRICIUS, GAIUS LUSCINUS (i.e. "the one-eyed"), Roman general, was the first member of the Fabrician gens who settled in Rome. He migrated to Rome from Aletrium (Livy ix. 43), one of the Hernican towns which was allowed to retain its independence as a reward for not having revolted. In 285 he was one of the ambassadors sent to the Tarentines to dissuade them from making war on the Romans. In 282 (when consul) he defeated the Bruttians and Lucanians, who had besieged

Thurii (Livy, *Epil.* 12). After the defeat of the Romans by Pyrrhus at Heraclea (280), Fabricius was sent to treat for the ransom and exchange of the prisoners. All attempts to bribe him were unsuccessful, and Pyrrhus is said to have been so impressed that he released the prisoners without ransom (Plutarch, *Pyrrhus*, 18). The story that Pyrrhus attempted to frighten Fabricius by the sight of an elephant is probably a fiction. In 278 Fabricius was elected consul for the second time, and was successful in negotiating terms of peace with Pyrrhus, who sailed away to Sicily. Fabricius afterwards gained a series of victories over the Samnites, the Lucanians and the Bruttians, and on his return to Rome received the honour of a triumph. Notwithstanding the offices he had filled he died poor, and provision had to be made for his daughter out of the funds of the state (Val. Max. iv. 4, 10). Fabricius was regarded by the Romans of later times as a model of ancient simplicity and incorruptible integrity.

FABRICIUS, GEORG (1516–1571), German poet, historian and archaeologist, was born at Chemnitz in upper Saxony on the 23rd of April 1516, and educated at Leipzig. Travelling in Italy with one of his pupils, he made an exhaustive study of the antiquities of Rome. He published the results in his *Roma* (1550), in which the correspondence between every discoverable relic of the old city and the references to them in ancient literature was traced in detail. In 1546 he was appointed rector of the college of Meissen, where he died on the 17th of July 1571. In his sacred poems he affected to avoid every word with the slightest savour of paganism; and he blamed the poets for their allusions to pagan divinities.

Principal works: editions of Terence (1548) and Virgil (1551); *Poëmatum sacrorum libri xxv.* (1560); *Poëlarum veterum ecclesiasticorum opera Christiana* (1562); *De Re Poëtica libri septem* (1565); *Rerum Misnicarum libri septem* (1569); (posthumous) *Originum illustrissimæ stirpis Saxonicae libri septem* (1597); *Rerum Germaniæ magnæ et Saxoniæ universæ memorabilium mirabiliumque volumina duo* (1609). A life of Georg Fabricius was published in 1839 by D. C. W. Baumgarten-Crusius, who in 1845 also issued an edition of Fabricius's *Epistolæ ad W. Meurerum et alios aequales*, with a short sketch *De Vita Ge. Fabricii et de gente Fabriciorum*; see also F. Wachter in Ersch and Gruber's *Allgemeine Encyclopædie*.

FABRICIUS, HIERONYMUS [FABRIZIO, GERONIMO] (1537–1619), Italian anatomist and embryologist, was surnamed *Acquapendente* from the episcopal city of that name, where he was born in 1537. At Padua, after a course of philosophy, he studied medicine under G. Fallopius, whose successor as teacher of anatomy and surgery he became in 1562. From the senators of Venice he received numerous honours, and an anatomical theatre was built by them for his accommodation. He died at Venice on the 21st of May 1619. His works include *De visione, voce et auditu* (1600), *De formato foetu* (1600), *De venarum ostioliis* (1603), *De formatione ovi et pulli* (1621). His collected works were published at Leipzig in 1687 as *Opera omnia Anatomica et Physiologica*, but the Leiden edition, published by Albinus in 1738, is preferred as containing a life of the author and the prefaces of his treatises. (See ANATOMY; EMBRYOLOGY.)

FABRICIUS, JOHANN ALBERT (1668–1736), German classical scholar and bibliographer, was born at Leipzig on the 11th of November 1668. His father, Werner Fabricius, director of music in the church of St Paul at Leipzig, was the author of several works, the most important being *Deliciae Harmonicæ* (1656). The son received his early education from his father, who on his deathbed recommended him to the care of the theologian Valentin Alberti. He studied under J. G. Herrichen, and afterwards at Quedlinburg under Samuel Schmid. It was in Schmid's library, as he afterwards said, that he found the two books, F. Barth's *Adversaria* and D. G. Morhof's *Polyhistor Literarius*, which suggested to him the idea of his *Bibliothecæ*, the works on which his great reputation was founded. Having returned to Leipzig in 1686, he published anonymously (two years later) his first work, *Scriptorum recentiorum decas*, an attack on ten writers of the day. His *Decas Decadum, sive plagiariorum et pseudonymorum centuria* (1680) is the only one of his works to which he signs the name Faber. He then applied himself to the study of medicine, which, however, he relinquished for that

of theology; and having gone to Hamburg in 1693, he proposed to travel abroad, when the unexpected tidings that the expense of his education had absorbed his whole patrimony, and even left him in debt to his trustee, forced him to abandon his project. He therefore remained at Hamburg in the capacity of librarian to J. F. Mayer. In 1696 he accompanied his patron to Sweden; and on his return to Hamburg, not long afterwards, he became a candidate for the chair of logic and philosophy. The suffrages being equally divided between Fabricius and Sebastian Edzardus, one of his opponents, the appointment was decided by lot in favour of Edzardus; but in 1699 Fabricius succeeded Vincent Placcius in the chair of rhetoric and ethics, a post which he held till his death, refusing invitations to Greifswald, Kiel, Giessen and Wittenberg. He died at Hamburg on the 30th of April 1736.

Fabricius is credited with 128 books, but very many of them were only books which he had edited. One of the most famed and laborious of these is the *Bibliotheca Latina* (1697, republished in an improved and amended form by J. A. Ernesti, 1773). The divisions of the compilation are—the writers to the age of Tiberius; thence to that of the Antonines; and thirdly, to the decay of the language; a fourth gives fragments from old authors, and chapters on early Christian literature. A supplementary work was *Bibliotheca Latina mediæ et infimæ Aetatis* (1734–1736; supplementary volume by C. Schöttgen, 1746; ed. Mansi, 1754). His *chef-d'œuvre*, however, is the *Bibliotheca Graeca* (1705–1728, revised and continued by G. C. Harles, 1790–1812), a work which has justly been denominated *maximus antiquæ eruditionis thesaurus*. Its divisions are marked off by Homer, Plato, Christ, Constantine, and the capture of Constantinople in 1453, while a sixth section is devoted to canon law, jurisprudence and medicine. Of his remaining works we may mention:—*Bibliotheca Antiquaria*, an account of the writers whose works illustrated Hebrew, Greek, Roman and Christian antiquities (1713); *Centifolium Lutheranicum*, a Lutheran bibliography (1728); *Bibliotheca Ecclesiastica* (1718). His *Codex Apocryphus* (1703) is still considered indispensable as an authority on apocryphal Christian literature.

The details of the life of Fabricius are to be found in *De Vita et Scriptis J. A. Fabricii Commentarius*, by his son-in-law, H. S. Reimarus, the well-known editor of Dio Cassius, published at Hamburg, 1737; see also C. F. Bähr in Ersch and Gruber's *Allgemeine Encyclopædie*, and J. E. Sandys, *Hist. Class. Schol.* iii. (1908).

FABRICIUS, JOHANN CHRISTIAN (1745–1808), Danish entomologist and economist, was born at Tondern in Schleswig on the 7th of January 1745. After studying at Altona and Copenhagen, he was sent to Upsala, where he attended the lectures of Linnaeus. He devoted his attention professionally to political economy, and, after lecturing on that subject in 1769, was appointed in 1775 professor of natural history, economy and finance at Kiel, in which capacity he wrote various works, chiefly referring to Denmark, and of no special interest. He also published a few other works on general and natural history, botany and travel (including *Reise nach Norwegen*, 1779), and, although his professional stipend was small, he extended his personal researches into every town in northern and central Europe where a natural history museum was to be found. It is as an entomologist that his memory survives, and for many years his great scientific reputation rested upon the system of classification which he founded upon the structure of the mouth-organs instead of the wings. He had a keen eye for specific differences, and possessed the art of terse and accurate description. He died on the 3rd of March 1808.

A complete list of his entomological publications (31) will be found in Hagen's *Bibliotheca Entomologica*; the following are the chief:—*Systema Entomologiae* (1775); *Genera Insectorum* (1776); *Philosophia Entomologica* (1778); *Species Insectorum* (1781); *Mantissa Insectorum* (1787); *Entomologia Systematica* (1792–1794), with a supplement (1798); *Systema Eleutheratorum* (1801), *Rhynchotorum* (1803), *Piezatorum* (1804), and *Aniliatorum* (1805). Full particulars of his life will be found, with a portrait, in the *Transactions of the Entomological Society of London* (1845), 4, pp. i-xvi, where his autobiography is translated from the Danish.

FABRIZI, NICOLA (1804–1885), Italian patriot, was born at Modena on the 4th of April 1804. He took part in the Modena insurrection of 1831, and attempted to succour Ancona, but was arrested at sea and taken to Toulon, whence he proceeded to Marseilles. Afterwards he organized with Mazzini the ill-fated Savoy expedition. Taking refuge in Spain, he fought against the Carlists, and was decorated for valour on the battlefield (18th July 1837). At the end of the Carlist War he established a

centre of conspiracy at Malta, endeavoured to dissuade Mazzini from the Bandiera enterprise, but aided Crispi in organizing the Sicilian revolution of 1848. With a company of volunteers he distinguished himself in the defence of Venice, afterwards proceeding to Rome, where he took part in the defence of San Pancrazio. Upon the fall of Rome he returned to Malta, accumulating arms and stores, which he conveyed to Sicily, after having, in 1859, worked with Crispi to prepare the Sicilian revolution of 1860. While Garibaldi was sailing from Genoa towards Marsala Fabrizi landed at Pizzolo, and, after severe fighting, joined Garibaldi at Palermo. Under the Garibaldian Dictatorship he was appointed governor of Messina and minister of war. Returning to Malta after the Neapolitan plebiscite, which he had vainly endeavoured to postpone, he was recalled to aid Cialdini in suppressing brigandage. While on his way to Sicily in 1862, to induce Garibaldi to give up the Aspromonte enterprise, he was arrested at Naples by Lamarmora. During the war of 1866 he became Garibaldi's chief of staff, and in 1867 fought at Mentana. In parliament he endeavoured to promote agreement between the chiefs of the Left, and from 1878 onwards worked to secure the return of Crispi to power, but died on the 31st of March 1885, two years before the realization of his object. His whole life was characterized by ardent patriotism and unimpeachable integrity. (H. W. S.)

FABROT, CHARLES ANNIBAL (1580-1659), French juriconsult, was born at Aix in Provence on the 15th of September 1580. At an early age he made great progress in the ancient languages and in the civil and the canon law; and in 1602 he received the degree of doctor of law, and was made avocat to the parlement of Aix. In 1609 he obtained a professorship in the university of his native town. He is best known by his translation of the *Basilica*, which may be said to have formed the code of the Eastern empire till its destruction. This work was published at Paris in 1647 in 7 vols. fol., and obtained for its author a considerable pension from the chancellor, Pierre Seguier, to whom it was dedicated. Fabrot likewise rendered great service to the science of jurisprudence by his edition of Cujas, which comprised several treatises of that great jurist previously unpublished. He also edited the works of several Byzantine historians, and was besides the author of various antiquarian and legal treatises. He died at Paris on the 16th of January 1659.

FABYAN, ROBERT (d. 1513), English chronicler, belonged to an Essex family, members of which had been connected with trade in London. He was a member of the Drapers company, alderman of Farringdon Without, and served as sheriff in 1493-1494. In 1496 he was one of those appointed to make representations to the king on the new impositions on English cloth in Flanders. Next year he was one of the aldermen employed in keeping watch at the time of the Cornish rebellion. He resigned his aldermanry in 1502, on the pretext of poverty, apparently in order to avoid the expense of mayoralty. He had, however, acquired considerable wealth with his wife Elizabeth Pake, by whom he had a numerous family. He spent his latter years on his estate of Halstedys at Theydon Garnon in Essex. He died on the 28th of February 1513 (*Inquisitiones post mortem for London*, p. 29, edited by G. S. Fry, 1896); his will, dated the 11th of July 1511, was proved on the 12th of July 1513. Fabyan's Chronicle was first published by Richard Pynson in 1516 as *The new chronicles of England and of France*. In this edition it ends with the reign of Richard III., and this probably represents the work as Fabyan left it, though with the omission of an autobiographical note and some religious verses, which form the *Envoi* of his history. The note and verses are first found in the second edition, printed by John Rastell in 1533 with continuations down to 1509. A third edition appeared in 1542, and a fourth in 1559 with additions to that year. The only modern edition is that of Sir Henry Ellis, 1811.

In the note above mentioned Fabyan himself says: "and here I make an ende of the vii. parte and hole werke, the vii. day of November in the yere of our Lord Jesu Christes Incarnacion M.vc. and iiii." This seems conclusive that in 1504 he did not contemplate any extension of his chronicles beyond

1485. The continuations printed by Rastell are certainly not Fabyan's work. But Stow in his *Collections* (ap. *Survey of London*, ii. 305-306, ed: C. L. Kingsford) states that Fabyan wrote "a Chronicle of London, England and of France, beginning at the creation and endynge in the third year of Henry VIII., which both I have in written hand." In his *Survey of London* (i. 191, 209, ii. 55, 116) Stow several times quotes Fabyan as his authority for statements which are not to be found in the printed continuations of Rastell. Some further evidence may be found in other notes of Stow's (ap. *Survey of London*, ii. 280, 283, 365-366), and in the citation by Hakluyt of an unprinted work of Fabyan as the authority for his note of Cabot's voyages. That Fabyan had continued his Chronicle to 1511 may be accepted as certain, but no trace of the manuscript can now be found.

It is only the seventh part of Fabyan's Chronicle, from the Norman Conquest onwards, that possesses any historical value. For his French history he followed chiefly the *Compendium super Francorum gestis* of Robert Gaguin, printed at Paris in 1497. For English history his best source was the old *Chronicles of London*, from which he borrowed also the arrangement of his work in civic form. From 1440 to 1485 he follows, as a rule with great fidelity, the original of the London Chronicle in Cotton MS. Vitellius A. XVI. (printed in *Chronicles of London*, 1905, pp. 153-264).

Fabyan's own merits are little more than those of an industrious compiler, who strung together the accounts of his different authorities without any critical capacity. He says expressly that his work was "gaderyd without understandynge," and speaks of himself as "of cunnynge full destitute." Nevertheless he deserves the praise which he has received as an early worker, and for having made public information which through Hall and Holinshed has become the common property of later historians, and has only recently been otherwise accessible. Bale alleges that the first edition was burnt by order of Cardinal Wolsey because it reflected on the wealth of the clergy; this probably refers to his version of the Lollards Bill of 1410, which Fabyan extracted from one of the London Chronicles.

See further Ellis' *Introduction*; W. Busch, *England under the Tudors* (trans. A. M. Todd, 1895), i. 405-410; and C. L. Kingsford, *Chronicles of London*, pp. xxvi-xxxii (1905). (C. L. K.)

FAÇADE, a French architectural term signifying the external face of a building, but more generally applied to the principal front.

FACCIOLATI, JACOPO (1682-1769), Italian philologist, was born at Torriglia, in the province of Padua, in 1682. He owed his admission to the seminary of Padua to Cardinal Barberigo, who had formed a high opinion of the boy's talents. As professor of logic, and regent of the schools, Facciolati was the ornament of the Paduan university during a period of forty-five years. He published improved editions of several philological works, such as the *Thesaurus Ciceronianus* of Nizolius, and the polyglot vocabulary known under the name of Calepino. The latter work, in which he was assisted by his pupil Egidio Forcellini, he completed in four years—1715 to 1719. It was written in seven languages, and suggested to the editor the idea of his *opus magnum*, the *Totius Latinitatis Lexicon*, which was ultimately published at Cardinal Priole's expense, 4 vols. fol., Padua, 1771 (revised ed. by de Vit, 1858-1887). In the compilation of this work the chief burden seems to have been borne by Facciolati's pupil Forcellini, to whom, however, the lexicographer allows a very scanty measure of justice. Perhaps the best testimony to the learning and industry of the compiler is the well-known observation that the whole body of Latinity, if it were to perish, might be restored from this lexicon. Facciolati's mastery of Latin style, as displayed in his epistles, has been very much admired for its purity and grace. In or about 1739 Facciolati undertook the continuation of Papadopoli's history of the university of Padua, carrying it on to his own day. Facciolati was known over all Europe as one of the most enlightened and zealous teachers of the time; and among the many flattering invitations which he received, but always declined, was one from the king of Portugal, to accept the directorship of a college at

Lisbon for the young nobility. He died in 1769. His history of the university was published in 1757, under the name *Fasti Gymnasii Patavini*. In 1808 a volume containing nine of his *Epistles*, never before published, was issued at Padua.

See J. E. Sandys, *Hist. Class. Schol.* ii. (1908).

FACE (from Lat. *facies*, derived either from *facere*, to make, or from a root *fa-*, meaning "appear"; cf. Gr. *φαίνω*), a word whose various meanings of surface, front, expression of countenance, look or appearance, are adaptations of the application of the word to the external part of the front portion of the head, usually taken to extend from the top of the forehead to the point of the chin, and from ear to ear (see ANATOMY: *Superficial and Artistic*; and PHYSIOGNOMY).

FACTION (through the French, from Lat. *factio*, a company of persons combined for action, *facere*, to do; from the other French derivative *façon* comes "fashion"), a term, used especially with an opprobrious meaning, for a body of partisans who put their party aims and interests above those of the state or public, and employ unscrupulous or questionable means; it is thus a common term of reciprocal abuse between parties. In the history of the Roman and Later Roman empires the factions (*factiones*) of the circus and hippodrome, at Rome and Constantinople, played a prominent part in politics. The *factiones* were properly the four companies into which the charioteers were divided, and distinguished by the colours they wore. Originally at Rome there were only two, white (*albata*) and red (*russata*), when each race was open to two chariots only; on the increase to four, the green (*prasina*) and blue (*veneta*) were added. At Constantinople the last two absorbed the red and white factions.

For a brilliant description of the factions at Constantinople under Justinian, and the part they played in the celebrated Nika riot in January 532, see Gibbon's *Decline and Fall*, ch. xl.; and J. B. Bury's *Appendix* 10 in vol. iv. of his edition (1898), for a discussion of the relationship between the *factiones* and the demes of Constantinople.

FACTOR (from Lat. *facere*, to make or do), strictly "one who makes"; thus in ordinary parlance, anything which goes to the composition of anything else is termed one of its "factors," and in mathematics the term is used of those quantities which, when multiplied together, produce a given product. In a special sense, however—and that to which this article is devoted—"factor" is the name given to a mercantile agent (of the class known as "general agents") employed to buy or sell goods for a commission. When employed to sell, the possession of the goods is entrusted to him by his principal, and when employed to buy it is his duty to obtain possession of the goods and to consign them to his principal. In this he differs from a *broker* (*q.v.*), who has not such possession, and it is this distinguishing characteristic which gave rise in England to the series of statutes known as the Factors Acts. By these acts, consolidated and extended by the act of 1889, third parties buying or taking pledges from factors are protected as if the factor were in reality owner; but these enactments have in no way affected the contractual relations between the factor and his employer, and it will be convenient to define them before discussing the position of third parties as affected by the act.

I. FACTOR AND PRINCIPAL

A factor is appointed or dismissed in the same way as any other agent. He may be employed for a single transaction or to transact all his principal's business of a certain class during a limited period or till such time as his authority may be determined. A factor's duty is to sell or buy as directed; to carry out with care, skill and good faith any instructions he may receive; to receive or make payment; to keep accounts, and to hand over to his principal the balance standing to his principal's credit, without any deduction save for commission and expenses. All express instructions he must carry out to the full, provided they do not involve fraud or illegality. On any point not covered by his express instructions he must follow the usual practice of his particular business, if not inconsistent with his instructions or his position as factor. Many usages of businesses in which factors are employed have been proved in court, and may now

be regarded as legally established. For instance, he may, unless otherwise directed, sell in his own name, give warranties as to goods sold by him, sell by sample (in most businesses), give such credit as is usual in his business, receive payment in cash or as customary, and give receipts in full discharge, sell by indorsement of bills of lading, and insure the goods. It is his duty to clear the goods at the customs, take charge of them and keep them safely, give such notices to his principal and others as may be required, and if necessary take legal proceedings for the protection of the goods. On the other hand, he has not authority to delegate his employment, or to barter; and as between himself and his principal he has no right to pledge the goods, although as between the principal and the pledgee, an unauthorized pledge made by the factor may by virtue of the Factors Act 1889 be binding upon the principal. It is, moreover, inconsistent with his employment as agent that he should buy or sell on his own account from or to his principal. A factor has no right to follow any usage which is inconsistent with the ordinary duties and authority of a factor unless his principal has expressly or impliedly given his consent.

On the due performance of his duties the factor is entitled to his commission, which is usually a percentage on the value of the goods sold or bought by him on account of his principal, regulated in amount by the usages of each business. Sometimes the factor makes himself personally responsible for the solvency of the persons with whom he deals, in order that his principal may avoid the risk entailed by the usual trade credit. In such a case the factor is said to be employed on *del credere* terms, and is entitled to a higher rate of commission, usually 2½% extra. Such an arrangement is not a contract of guarantee within the Statute of Frauds, and therefore need not be in writing. Besides his remuneration, the factor is entitled to be reimbursed by his principal for any expenses, and to be indemnified against any liabilities which he may have properly incurred in the execution of his principal's instructions. For the purpose of enforcing his rights a factor has, without legal proceedings, two remedies. Firstly, by virtue of his general *lien* (*q.v.*) he may hold any of his principal's goods which come to his hands as security for the payment to him of any commission, out-of-pocket expenses, or even general balance of account in his favour. Although he cannot sell the goods, he may refuse to give them up until he is paid. Secondly, where he has consigned goods to his principal but not been paid, he may "*stop in transit*" subject to the same rules of law as an ordinary vendor; that is to say, he must exercise his right before the transit ends; and his right may be defeated by his principal transferring the document of title to the goods to some third person, who takes it in good faith and for valuable consideration (Factors Act 1889, section 10). If the factor does not carry out his principal's instructions, or carries them out so negligently or unskillfully that his principal gets no benefit thereby, the factor loses his commission and his right to reimbursement and indemnity. If by such failure or negligence the principal suffers any loss, the latter may recover it as damages. So too if the factor fails to render proper accounts his principal may by proper legal proceedings obtain an account and payment of what is found due; and threatened breaches of duty may be summarily stopped by an injunction. Criminal acts by the factor in relation to his principal's goods are dealt with by section 78 of the Larceny Act 1860.

II. PRINCIPAL AND THIRD PARTY

(a) *At Common Law*.—The actual authority of a factor is defined by the same limits as his duty, the nature of which has been just described; *i.e.* firstly, by his principal's express instructions; secondly, by the rules of law and usages of trade, in view of which those instructions were expressed. But his power to bind his principal as regards third parties is often wider than his actual authority; for it would not be reasonable that third parties should be prejudiced by secret instructions, given in derogation of the authority ordinarily conferred by the custom of trade; and, as regards them, the factor is said to have "*apparent*" or "*ostensible*" authority, or to be *held out* as having

authority to do what is customary, even though he may in fact have been expressly forbidden so to do by his principal. But this rule is subject to the proviso that if the third party have notice of the factor's actual instructions, the "apparent" authority will not be greater than the actual. "The general principle of law," said Lord Blackburn in the case of *Cole v. North-Western Bank*, 1875, L.R. 10, C.P. 363, "is that when the true owner has clothed any one with apparent authority to act as his agent, he is bound to those who deal with the agent on the assumption that he really is an agent with that authority, to the same extent as if the apparent authority were real." Under such circumstances the principal is for reasons of common fairness precluded, or, in legal phraseology, *estopped*, from denying his agent's authority. On the same principle of estoppel, but not by reason of any trade usages, a course of dealing which has been followed between a factor and a third party with the assent of the principal will give the factor apparent authority to continue dealing on the same terms even after the principal's assent has been withdrawn; provided that the third party has no notice of the withdrawal.

Such apparent authority binds the principal both as to acts done in excess of the actual authority and also when the actual authority has entirely ceased. For instance, A.B. receives goods from C. D. with instructions not to sell below 1s. per lb; A. B. sells at 10½d., the market price; the buyer is entitled to the goods at 10½d., because A. B. had apparent authority, although he exceeded his actual authority. On the same principle the buyer would get a good title by buying from A. B. goods entrusted to him by C. D., even though at the time of the sale C. D. had revoked A. B.'s authority and instructed him not to sell at all. In either case the factor is held out as having authority to sell, and the principal cannot afterwards turn round and say that his factor had no such authority. As in the course of his business the factor must necessarily make representations preliminary to the contracts into which he enters, so the principal will be bound by any such representations as may be within the factor's actual or apparent authority to the same degree as by the factor's contracts.

(b) *Under the Factors Act 1889.*—The main object of the Factors Acts, in so far as they relate to transactions carried out by factors, has been to add to the number of cases in which third parties honestly buying or lending money on the security of goods may get a good title from persons in whose possession the goods are with the consent, actual or apparent, of the real owners, thus calling in aid the principle of French law that "*possession vaut titre*" as against the doctrine of the English common law that "*nemo dat quod non habet*." The chief change in the law relating specially to factors has been to put pledges by factors on the same footing as sales, so as to bind a principal to third parties by his factor's pledge as by his factor's sale. The Factors Act 1889 in part re-enacts and in part extends the provisions of the earlier acts of 1823, 1825, 1842 and 1877; and is, so far as it relates to sales by factors, in large measure merely declaratory of the law as it previously existed. Its most important provisions concerning factors are as follows:—

Section I., s.s. 1. The expression mercantile agent shall mean a mercantile agent having in the customary course of his business as such agent authority either to sell goods, or to consign goods for the purpose of sale, or to buy goods, or to raise money on the security of goods;

2. A person shall be deemed to be in possession of goods or of the documents or title to goods when the goods or documents are in his actual custody or are held by any other person subject to his control or for him on his behalf.

4. The expression "document of title" shall include any bill of lading, dock warrant, warehouse keeper's certificate, and warrant or order for the delivery of goods, and any other document used in the ordinary course of business as proof of the possession or control of goods, or authorizing or purporting to authorize, either by indorsement or by delivery, the possessor of the document to transfer or receive goods thereby represented.

Section II., s.s. 1. Where a mercantile agent is, with the consent of the owner, in possession of goods or of the documents or title to goods, any sale, pledge or other disposition of the goods made by him when acting in the ordinary course of business of a mercantile agent shall, subject to the provisions of this act, be as valid as if

he were expressly authorized by the owner of the goods to make the same; provided that the person taking under the disposition acts in good faith, and has not at the time of the disposition notice that the person making the disposition has not authority to make the same.

2. Where a mercantile agent has, with the consent of the owner, been in possession of goods or of the documents of title to goods, any sale, pledge or other disposition which would have been valid if the consent had continued shall be valid notwithstanding the determination of the consent; provided that the person taking under the disposition has not at the time thereof notice that the consent has been determined.

3. Where a mercantile agent has obtained possession of any documents of title to goods by reason of his being or having been, with the consent of the owner, in possession of the goods represented thereby, or of any other documents of title to the goods, his possession of the first-mentioned documents shall, for the purposes of the act, be deemed to be with the consent of the owner.

III. ENFORCEMENT OF CONTRACTS

1. Where a factor makes a contract in the name of his principal and himself signs as agent only, he drops out as soon as the contract is made, and the principal and third party alone can sue or be sued upon it. As factors usually contract in their own name this is not a common case. It is characteristic of brokers rather than of factors.

2. Where a factor makes a contract for the principal without disclosing his principal's name, the third party may, on discovering the principal, elect whether he will treat the factor or his principal as the party to the contract; provided that if the factor contract expressly as factor, so as to exclude the idea that he is personally responsible, he will not be liable. The principal may sue upon the contract, so also may the factor, unless the principal first intervene.

3. Where a factor makes a contract in his own name without disclosing the existence of his principal, the third party may, on discovering the existence of the principal, elect whether he will sue the factor or the principal. Either principal or factor may sue the third party upon the contract. But if the factor has been permitted by the principal to hold himself out as the principal, and the person dealing with the factor has believed that the factor was the principal and has acted on that belief before ascertaining his mistake, then in an action by the principal the third party may set up any defences he would have had against the factor if the factor had brought the action on his own account as principal.

4. Where a factor has a lien upon the goods and their proceeds for advances made to the principal it will be no defence to an action by him for the third party to plead that he has paid the principal, unless the factor by his conduct led the third party to believe that he agreed to a settlement being made with his principal.

5. The factor who acts for a foreign principal will always be personally liable unless it is clear that the third party has agreed to look only to the principal.

6. If a factor contract by deed under seal he alone can sue or be sued upon the contract; but mercantile practice makes contracts by deed uncommon.

AUTHORITIES.—Story, *Commentaries on the Law of Agency* (Boston, 1882); Boyd and Pearson, *The Factors Acts 1823 to 1877* (London, 1884); Blackwell, *The Law relating to Factors* (London, 1897). (L. F. S.)

FACTORY ACTS, the name given generally to a long series of acts constituting one of the most important chapters in the history of English labour legislation (see **LABOUR LEGISLATION**); the term "factory" itself being short for manufactory, a building or collection of buildings in which men or women are employed in industry.

FACULA (diminutive of *fax*, Lat. for "torch"), in astronomy, a minute shining spot on the sun's disk, markedly brighter than the photosphere in general, usually appearing in groups. Faculae are most frequent in the neighbourhood of spots. (See **SUN**.)

FACULTY (through the French, from the Lat. *facultas*, ability to do anything, from *facilis*, easy, *facere*, to do; another form of the word in Lat. *facilitas*, facility, ease, keeps the original meaning), power or capacity of mind or body for particular kinds

of activity, feeling, &c. In the early history of psychology the term was applied to various mental processes considered as causes or conditions of the mind—a treatment of “class concepts of mental phenomena as if they were real forces producing these phenomena” (G. F. Stout, *Analytic Psychology*, vol. i. p. 17). In medieval Latin *facultas* was used to translate *δύναμις* in the Aristotelian application of the word to a branch of learning or knowledge, and thus it is particularly applied to the various departments of knowledge as taught in a university and to the body of teachers of the particular art or science taught. The principal “faculties” in the medieval universities were theology, canon and civil law, medicine and arts (see UNIVERSITIES). A further extension of this use is to the body of members of any particular profession.

In law, “faculty” is a dispensation or licence to do that which is not permitted by the common law. The word in this sense is used only in ecclesiastical law. A faculty may be granted to be ordained deacon under twenty-three years of age; to hold two livings at once (usually called a licence or dispensation, but granted under the seal of the office of faculties; see BENEFICE); to be married at any place or time (usually called a special licence; see MARRIAGE; LICENCE); to act as a notary public (*q.v.*). Any alteration in a church, such as an addition or diminution in the fabric or the utensils or ornaments of the church, cannot strictly be made without the legal sanction of the ordinary, which can only be expressed by the issue of a faculty. So a faculty would be required for a vault, for the removal of a body, for the purpose of erecting monuments, for alterations in a parsonage house, for brick graves, for the apportionment of a seat, &c. Cathedrals, however, are exempt from the necessity for a faculty before making alterations in the fabric, utensils or ornaments.

The court of faculties is the court of the archbishop for granting faculties. It is a court in which there is no litigation or holding of pleas. Its chief officer is called the master of faculties, and he is one and the same with the judge of the court of arches. Attached to the court of faculties are a registrar and deputy registrars, a chief clerk and record-keeper, and a seal keeper. In Scotland the society of advocates of the court of session, and local bodies of legal practitioners, are described as faculties.

FAED, THOMAS (1826–1900), British painter, born in Kirkcudbrightshire, was the brother of John Faed, R.S.A., and received his art education in the school of design, Edinburgh. He was elected an associate of the Royal Scottish Academy in 1849, came to London three years later, was elected an associate of the Royal Academy in 1861, and academician in 1864, and retired in 1893. He had much success as a painter of domestic genre, and had considerable executive capacity. Three of his pictures, “The Silken Gown,” “Faults on Both Sides,” and “The Highland Mother,” are in the National Gallery of British Art.

See William D. McKay, *The Scottish School of Painting* (1906).

FAENZA (anc. *Faventia*), a city and episcopal see of Emilia, Italy, in the province of Ravenna, from which it is 31 m. S.W. by rail, 110 ft. above sea-level. It is 31 m. S.E. of Bologna by rail, on the line from Bologna to Rimini, and it is the junction of a line to Florence through the Apennines. Pop. (1901) 21,809 (town), 39,757 (commune). The town is surrounded by walls which date from 1456. The cathedral of S. Costanzo stands in the spacious Piazza Vittorio Emanuele in the centre of the town. It was begun in 1474 by Giuliano da Maiano; the façade is, however, incomplete. In the interior is the beautiful early Renaissance tomb of S. Savinus with reliefs showing scenes from his life, of fine and fresh execution, by Benedetto da Maiano; and later tombs by P. Bariloto, a local sculptor. Opposite the cathedral is a fountain with bronze ornamentation of 1583–1621. The clock tower alongside the cathedral belongs to the 17th century. Beyond it is the Palazzo Comunale, formerly the residence of the Manfredi, but entirely reconstructed. The other churches of the town have been mostly restored, but S. Michele (and the Palazzo Manfredi opposite it) are fine early Renaissance buildings in brickwork. The municipal art gallery contains an altar-piece by Girolamo da Treviso (who

also painted a fresco in the Chiesa della Commenda), a wooden St Jerome by Donatello, and a bust of the young St John by Antonio Rossellino (?), and some fine specimens of majolica, a variety of which, faience, takes its name from the town. It was largely manufactured in the 15th and 16th centuries, and the industry has been revived in modern times with success.

The ancient Faventia, on the Via Aemilia, was obviously from its name founded by the Romans and had the citizenship before the Social War. It was the scene of the defeat of C. Papirius Carbo and C. Norbanus by Q. Caecilius Metellus Pius in 82 B.C. In the census of Vespasian a woman of Faventia is said to have given her age as 135. Pliny speaks of the whiteness of its linen, and the productiveness of its vines is mentioned. It is noticeable that some of the fields in the territory of the ancient Faventia still preserve the exact size of the ancient Roman *centuria* of 200 *iugeri* (E. Bormann in *Corp. Inscr. Lat.* xi., Berlin, 1888, p. 121). When the exarchate was established, the town became part of it, and in 748 it was taken by Liutprand. Desiderius gave it to the church with the duchy of Ferrara. In the 11th century it began to increase in importance. In the wars of the 12th and 13th centuries it at first took the imperial side, but in 1240 it stood a long siege from Frederick II. and was only taken after eight months. After further struggles between Guelphs and Ghibellines, the Manfredi made themselves masters of the place early in the 14th century, and remained in power until 1501, when the town was taken by Caesar Borgia and the last legitimate members of the house of the Manfredi were drowned in the Tiber; and, after falling for a few years into the hands of the Venetians, it became a part of the states of the church in 1509. (T. As.)

FAEROE (also written FAROE or THE FAEROES, Danish *Færøerne* or *Färøerne*, “the sheep islands”), a group of islands in the North Sea belonging to Denmark. They are situated between Iceland and the Shetland Islands, about 200 m. N.W. of the latter, about the intersection of 7° E. with 62° N. The total land area of the group is 511 sq. m., and there are twenty-one islands (excluding small rocks and reefs), of which seventeen are inhabited. The population in 1880 amounted to 11,220, and in 1900 to 15,230. The principal islands are Strömö, on which is the chief town, Thorshavn, with a population of 1656; Osterö, Süderö, Vaagö, Sandö and Bordö. They consist throughout of rocks and hills, separated from each other by narrow valleys or ravines; but, though the hills rise abruptly, there are often on their summits, or at different stages of their ascent, plains of considerable magnitude. Almost everywhere they present to the sea perpendicular cliffs, broken into fantastic forms, affording at every turn, to those who sail along the coast, the most picturesque and varied scenery. The highest hills are Slättare-tindur in Osterö, and Kopende and Skellingfjeld in Strömö, which rise respectively to 2894, 2592 and 2520 ft. The sea pierces the islands in deep fjords, or separates them by narrow inlets through which tidal currents set with great violence, at speeds up to seven or eight knots an hour; and, as communications are maintained almost wholly by boat, the natives have need of expert watermanship. There are several lakes in which trout are abundant, and char also occur; the largest is Sörvaag Lake in Vaagö, which is close to the sea, and discharges into it by a sheer fall of about 160 ft. Trees are scarce, and there is evidence that they formerly flourished where they cannot do so now.

The fundamental formation is a series of great sheets of columnar basalt, 70 to 100 ft. thick, in which are intercalated thin beds of tuff. Upon the basalt rests the so-called Coal formation, 35 to 50 ft. thick; the lower part of this is mainly fireclay and sandstone, the upper part is weathered clay with thin layers of brown coal and shale. The coal is found in Süderö and in some of the other islands in sufficient quantity to make it a matter of exploitation. Above these beds there are layers of dolerite, 15 to 20 ft. thick, with nodular segregations and abundant cavities which are often lined with zeolites. As the rocks lie in a horizontal position, on most of the islands of the group only the basalts or dolerite are visible. The crater from which the volcanic rocks were outpoured probably lies off the Faeröe Bank some distance to the south-west of Süderö. The basalts are submarine flows which formed the basis of the land

upon which grew the vegetation which gave rise to the coals; the effusion of dolerite which covered up the Coal formation was sub-aerial. The existing land features, with the fjords, are due to ice erosion in the glacial period.¹

The climate is oceanic; fogs are common, violent storms are frequent at all seasons. July and August are the only true summer months, but the winters are not very severe. It seldom freezes for more than one month, and the harbours are rarely ice-bound. The methods of agriculture are extremely primitive and less than 3% of the total area is under cultivation. As the plough is ill-suited to the rugged surface of the land, the ground is usually turned up with the spade, care being taken not to destroy the roots of the grass, as hay is the principal crop. Horses and cows are few, and the cows give little milk, in consequence of the coarse hay upon which they are fed. The number of sheep, however, justifies the name of the islands, some individuals having flocks of from three to five hundred, and the total number in the islands considerably exceeds ten thousand. The northern hare (*Lepus alpinus*) is pretty abundant in Strömö and Osterö, having been introduced into the islands about 1840-1850. The catching of the numerous sea-birds which build their nests upon the face of the cliffs forms an important source of subsistence to the inhabitants. Sometimes the fowler is let down from the top of the cliff; at other times he climbs the rocks, or, where possible, is pushed upwards by poles made for the purpose. The birds and the contents of the nests are taken in nets mounted on poles; shooting is not practised, lest it should permanently scare the birds away. Fowling has somewhat decreased in modern times, as the fisheries have risen in importance. The puffin is most commonly taken for its feathers. The cod fishery is especially important, dried fish being exported in large quantity, and the swim-bladders made into gelatine, and also used and exported for food. The whaling industry came into importance towards the close of the 19th century, and stations for the extraction of the oil and whalebone have been established at several points, under careful regulations designed to mitigate the pollution of water, the danger to live-stock from eating the blubber, &c. The finner whale is the species most commonly taken.

The trade of the Faeroe Islands was for some time a monopoly in the hands of a mercantile house at Copenhagen, and this monopoly was afterwards assumed by the Danish government, but by the law of the 21st of March 1855 all restrictions were removed. The produce of the whaling and fishing industries, woollen goods, lamb skins and feathers, are the chief exports, while in Thorshavn the preserving of fish and the manufacture of carpets are carried on to some extent. Thorshavn is situated on the S.E. side of Strömö, upon a narrow tongue of land, having creeks on each side, where ships may be safely moored. It is the seat of the chief government and ecclesiastical officials, and has a government house and a hospital. The houses are generally built of wood and roofed with birch bark covered with turf. The character of the people is marked by simplicity of manners, kindness and hospitality. They are healthy, and the population increases steadily. The Faeroes form an *amt* (county) of Denmark. They have also a local parliament (*lagthing*), consisting of the *amtman* and nineteen other members. Among other duties, this body elects a representative to the upper house of parliament (*landsting*) in Denmark; the people choose by vote a representative in the lower house (*folkething*). The islands are included in the Danish bishopric of Zealand.

History.—The early history of the Faeroes is not clear. It appears that about the beginning of the 9th century Grim Kamban, a Norwegian emigrant who had left his country to escape the tyranny of Harold Haarfager, settled in the islands. It is said that a small colony of Irish and Scottish monks were found in Süderö and dispersed by him. The Faeroes then already bore their name of Sheep Islands, as these animals had been found to flourish here exceedingly. Early in the 11th century Sigmund or Sigismund Bresterson, whose family had flourished in the southern islands but had been almost exterminated by

See Hans von Post, "Om Färöarnes uppkomst," *Geologiska Föreningens i Stockholm Förhandlingar*, vol. xxiv. (1902).

invaders from the northern, was sent from Norway, whither he had escaped, to take possession of the islands for Olaf Trygvason, king of Norway. He introduced Christianity, and, though he was subsequently murdered, Norwegian supremacy was upheld, and continued till 1386, when the islands were transferred to Denmark. English adventurers gave great trouble to the inhabitants in the 16th century, and the name of Magnus Heineson, a native of Strömö, who was sent by Frederick II. to clear the seas, is still celebrated in many songs and stories. There was formerly a bishopric at Kirkebö, S. of Thorshavn, where remains of the cathedral may be seen; but it was abolished at the introduction of Protestantism by Christian III. Denmark retained possession of the Faeroes at the peace of Kiel in 1815. The native literature of the islands consists of the *Faereyinga Saga*, dealing with the period of Sigmund Bresterson, and a number of popular songs and legends of early origin.

BIBLIOGRAPHY.—Lucas Jacobson Debes, *Feroa Reserata* (Copenhagen, 1673; Eng. transl. London, 1675); Torfaeus, *De rebus gestis Faereyensium* (Copenhagen, 1695); I. Landt, *Beskrivelse over Färöerne* (1800), and *Descriptions of the Feroe Islands* (London, 1810); A. J. Symington, *Pen and Pencil-Sketches of Faroe and Iceland* (1862); J. Russel-Jeaffreson, *The Faröe Islands* (1901); J. Falk Rönne, *Beskrivelse over Färöerne* (Copenhagen, 1902); C. H. Ostensfeld, E. Warming and others, *Botany of the Faeroes* (Copenhagen, 1901-1903); Annandale, *The Faeroes and Iceland* (Oxford, 1905). The *Faereyinga Saga* was translated by F. York Powell (London, 1896); for folk-songs and legends see S. Kraeth, *Die färöischen Lieder von Sigurd* (Paderborn, 1877); V. U. Hammershaimb, *Faeröisk Anthologi* (Copenhagen, 1886-1891).

FAESULAE (mod. *Fiesole*, *q.v.*), an ancient city of Etruria, on the height 3 m. to the N.E. of Florentia, 970 ft. above sea-level. Remains of its walls are preserved on all sides, especially on the N.E., in one place to a height of 12 to 14 courses. The blocks are often not quite rectangular, and the courses sometimes change; but the general tendency is horizontal and the walls are not of remote antiquity, the irregularities in them being rather due to the hardness of the material employed, the rock of the hill itself. The courses vary in height from 1 to 3 ft., and some blocks are as long as 12½ ft. In this portion of the wall are two drains, below one of which is a *phallus*. The site of an ancient gate, and the road below it, can be traced; a little farther E. was an archway, conjectured by Dennis to be a gate of the Roman period, destroyed in 1848. The whole circuit of the walls extended for about 1½ m. The Franciscan monastery (1130 ft.) occupies the site of the acropolis, once encircled by a triple wall, of which no traces are now visible. Here was also the *Capitolium* of Roman times, as an inscription found here in 1879 records (*Corpus Inscr. Lat.* xi., Berlin, 1888, No. 1545). The Roman theatre, below the cathedral to the N.E., has 19 tiers of stone seats and is 37 yds. in diameter. Above it is an embanking wall of irregular masonry, and below it some remains of Roman baths, including five parallel vaults of concrete. Just outside the town on the E. a reservoir, roofed by the convergence of its sides, which were of large regular blocks, was discovered in 1832, but filled in again. Over 1000 silver denarii, all coined before 63 B.C., were found at Faesulae in 1829. A small museum contains the objects found in the excavations of the theatre.

Though Faesulae was an Etruscan city, we have no record of it in history until 215 B.C., when the Gauls passed near it in their march on Rome. Twelve years later Hannibal seems to have taken this route in his march south after the victory of the Trebia. It appears to have suffered at the hands of Rome in the Social War, and Sulla expelled some of the inhabitants from their lands to make room for his veterans, but some of the latter were soon driven out in their turn by the former occupiers. Both the veterans, who soon wasted what they had acquired, and the dispossessed cultivators joined the partisans of Catiline, and Manlius, one of his supporters, made his headquarters at Faesulae. Under the empire we hear practically nothing of it; in A.D. 405 Radagaisus was crushed in the neighbouring hills, and Belisarius besieged and took it in A.D. 539.

See L. A. Milani, *Renüiconti dei Lincei*, ser. vi. vol. ix. (1900), 289 seq., on the discovery of an archaic altar of the *Locus sacer* of Florence, belonging to Ancharia (Angerona), the goddess of Fiesole. (T. As.)

FAFNIR, in Scandinavian mythology, the son of the giant Hreidmar. He was the guardian of the hoard of the Nibelungs and was killed by Sigurd.

FAGGING (from "fag," meaning "weary"; of uncertain etymology), in English public schools, a system under which, generally with the full approval of the authorities, a junior boy performs certain duties for a senior. In detail this custom varies slightly in the different schools, but its purpose—the maintenance of discipline among the boys themselves—is the same. Dr Arnold of Rugby defined fagging as "the power given by the supreme authorities of the school to the Sixth Form, to be exercised by them over the lower boys, for the sake of securing a regular government among the boys themselves, and avoiding the evils of anarchy; in other words, of the lawless tyranny of brute force." Fagging was a fully established system at Eton and Winchester in the 16th century, and is probably a good deal older. That the advantages of thus granting the boys a kind of autonomy have stood the test of time is obvious from the fact that in almost all the great public schools founded during the 19th century, fagging has been deliberately adopted by the authorities. The right to fag carries with it certain well-defined duties. The fag-master is the protector of his fags, and responsible for their happiness and good conduct. In cases of bullying or injustice their appeal is to him, not to the form or house master, and, except in the gravest cases, all such cases are dealt with by the fag-master on his own responsibility and without report to the master. Until recent years a fag's duties included such humble tasks as blacking boots, brushing clothes, and cooking breakfasts, and there was no limit as to hours; almost all the fag's spare time being so monopolized. This is now changed. Fagging is now restricted to such light tasks as running errands, bringing tea to the "master's" study, and fagging at cricket or football. At Eton there is no cricket fagging, and at most schools it is made lighter by all the fags taking their turn in regular order for one hour, so that each boy has to "fag" but once in so many weeks. At Rugby there is "study-fagging"—two fags being assigned to each Sixth Form boy and made responsible for the sweeping out and tidying up of his study alternately each week,—and "night-fagging"—running errands for the Sixth between 8.30 and 9.30 every evening,—and each boy can choose whether he will be a study-fag or night-fag. The right to fag is usually restricted to the Sixth Form, but at Eton the privilege is also granted the Fifth, and at Marlborough and elsewhere the Eleven have a right to fag at cricket, whether in the Sixth or not.

FAGGOT, a bundle of sticks used for firewood. The word is adapted from the Fr. *fagot*, and appears in Italian as *fagotto*, the name given to the bassoon (*q.v.*). "Faggot" is frequently used with reference to the burning of heretics, and recanted heretics wore an embroidered faggot on the arm as a symbol of the punishment they had escaped. In the 18th century the word is used of a "dummy" soldier, appearing on the rolls of a regiment. It is this use, coupled with the idea of a bundle of sticks as being capable of subdivision, that appears in the expression "faggot-vote," a vote artificially created by the minute splitting up of property so as to give a bare qualification for the franchise.

FAGNIEZ, GUSTAVE CHARLES (1842—), French historian and economist, was born in Paris on the 6th of October 1842. Trained at the École des Chartes and the École des Hautes Études, he made his first appearance in the world of scholarship as the author of an excellent book called *Études sur l'industrie et la classe industrielle à Paris au XIII^e et au XIV^e siècle* (1877). This work, composed almost entirely from documents, many unpublished, opened a new field for historical study. Twenty years later he supplemented this book by an interesting collection of *Documents relatifs à l'histoire de l'industrie et du commerce en France* (2 vols., 1898–1900), and in 1897 he published *L'Économie sociale de la France sous Henri IV*, a volume containing the results of very minute research. He did not, however, confine himself to economic history. His *Le Père Joseph et Richelieu* (1894), though somewhat frigid and severe, is based on a mass

of unpublished information, and shows remarkable psychologic grasp. In 1878 his *Journal parisien de Jean de Maupoint, prieur de Ste Catherine-de-la-Couture* was published in vol. iv. of the *Mémoires de la société de l'histoire de Paris et de l'Île de France*. He wrote numerous articles in the *Revue historique* (of which he was co-director with Gabriel Monod for some years) and in other learned reviews, such as the *Revue des questions historiques* and the *Journal des savants*. In 1901 he was elected member of the Académie des Sciences Morales et Politiques.

FAGUET, EMILE (1847—), French critic and man of letters, was born at La Roche sur Yon on the 17th of December 1847. He was educated at the normal school in Paris, and after teaching for some time in La Rochelle and Bordeaux he came to Paris. After acting as assistant professor of poetry in the university he became professor in 1897. He was elected to the academy in 1900, and received the ribbon of the Legion of Honour in the next year. He acted as dramatic critic to the *Soleil*; from 1892 he was literary critic to the *Revue bleue*; and in 1896 took the place of M. Jules Lemaitre on the *Journal des débats*. Among his works are monographs on *Flaubert* (1899), *André Chénier* (1902), *Zola* (1903); an admirably concise *Histoire de la littérature française depuis le XVII^e siècle jusqu'à nos jours*; series of literary studies on the 17th, 18th and 19th centuries; *Questions politiques* (1895); *Propos littéraires* (3 series, 1902–1905); *Le Libéralisme* (1902); and *L'Anticléricalisme* (1906). See A. Séché, *Emile Faguet* (1904).

FA-HIEN (fl. A.D. 399–414), Chinese Buddhist monk, pilgrim-traveller, and writer, author of one of the earliest and most valuable Chinese accounts of India. He started from Changgan or Si-gan-fu, then the capital of the Ts'in empire, and passing the Great Wall, crossed the "River of Sand" or Gobi Desert beyond, that home of "evil demons and hot winds," which he vividly describes,—where the only way-marks were the bones of the dead, where no bird appeared in the air above, no animal on the ground below. Arriving at Khotan, the traveller witnessed a great Buddhist festival; here, as in Yarkand, Afghanistan and other parts thoroughly Islamized before the close of the middle ages, Fa-Hien shows us Buddhism still prevailing. India was reached by a perilous descent of "ten thousand cubits" from the "wall-like hills" of the Hindu Kush into the Indus valley (about A.D. 402); and the pilgrim passed the next ten years in the "central" Buddhist realm,—making journeys to Peshawur and Afghanistan (especially the Kabul region) on one side, and to the Ganges valley on another. His especial concern was the exploration of the scenes of Buddha's life, the copying of Buddhist texts, and converse with the Buddhist monks and sages whom the Brahmin reaction had not yet driven out. Thus we find him at Buddha's birthplace on the Kohana, north-west of Benares; in Patna and on the Vulture Peak near Patna; at the Jetvana monastery in Oudh; as well as at Muttra on the Jumna, at Kanauj, and at Tamluk near the mouth of the Hugli. But now the narrative, which in its earlier portions was primarily historical and geographical, becomes mystical and theological; miracle-stories and meditations upon Buddhist moralities and sacred memories almost entirely replace matters of fact. From the Ganges delta Fa-Hien sailed with a merchant ship, in fourteen days, to Ceylon, where he transcribed all the sacred books, as yet unknown in China, which he could find; witnessed the festival of the exhibition of Buddha's tooth; and remarked the trade of Arab merchants to the island, two centuries before Mahomet. He returned by sea to the mouth of the Yangtse-Kiang, changing vessels at Java, and narrowly escaping shipwreck or the fate of Jonah.

Fa-Hien's work is valuable evidence to the strength, and in many places to the dominance, of Buddhism in central Asia and in India at the time of the collapse of the Roman empire in western Europe. His tone throughout is that of the devout, learned, sensible, rarely hysterical pilgrim-traveller. His record is careful and accurate, and most of his positions can be identified; his devotion is so strong that it leads him to depreciate China as a "border-land," India the home of Buddha being the true "middle kingdom" of his creed.

See James Legge, *Record of Buddhistic Kingdoms, being an account by the Chinese Monk Fâ-hien of his travels in India and Ceylon*; translated and edited, with map, &c. (Oxford, 1886); S. Beal, *Travels of Fah-Iian and Sung-Yun, Buddhist pilgrims from China to India, 400 and 518 A.D.*, translated, with map, &c. (1869); C. R. Beazley, *Dawn of Modern Geography*, vol. i. (1897), pp. 478-485.

FAHLCRANTZ, CHRISTIAN ERIK (1790-1866), Swedish author, was born at Stora Tuna in Sweden on the 30th of August 1790. His brothers, Carl Johan (1774-1861), the landscape-painter, and Axel Magnus (1780-1854), the sculptor, became hardly less distinguished than himself. In 1804 he entered the university of Upsala; in 1821 he became tutor in Arabic, and in 1825 professor of Oriental languages. In 1828 he entered the church, but earlier than this, in 1825, he published his *Noachs Ark*, a successful satire on the literary and social life of his time, followed in 1826 by a second part. In 1835 Fahlcrantz brought out the first part of his epic of *Ansgarius*, which was completed in 1846, in 14 cantos. In 1842 he was made a member of the Swedish Academy, and in 1849 he was made bishop of Vesterås, his next literary work being an archaeological study on the beautiful ancient cathedral of his diocese. In the course of the years 1858-1861 appeared the five volumes of his *Rom förr och nu* (*Rome as it was and is*), a theological polemic, mainly directed against the Jesuits. He died on the 6th of August 1866. His complete works (7 vols., Örebro, 1863-1866) were issued mainly under his own superintendence.

FAHRENHEIT, GABRIEL DANIEL (1686-1736), German physicist, was born at Danzig on the 14th of May 1686. For the most part he lived in England and Holland, devoting himself to the study of physics and making a living, apparently, by the manufacture of meteorological instruments. He was the author of important improvements in the construction of thermometers, and he introduced the thermometric scale known by his name and still extensively used in Great Britain and the United States (see THERMOMETRY). He also invented an improved form of hygrometer, a description of which, together with accounts of various observations and experiments made by him, was published in the *Phil. Trans.* for 1724. He died in Holland on the 16th of September 1736.

FAIDHERBE, LOUIS LÉON CÉSAR (1818-1889), French general and colonial administrator, was born on the 3rd of June 1818, at Lille, received his military education at the École Polytechnique and at Metz, and entered the engineers in 1840. From 1844 to 1847 he served in Algeria, then two years in the West Indies, and again in Algeria, taking part in many expeditions against the Arabs. In 1852 he was transferred to Senegal as sub-director of engineers, and in 1854 was promoted *chef de bataillon* and appointed governor of the colony. He held this post with one brief interval until July 1865. The work he accomplished in West Africa constitutes his most enduring monument. At that time France possessed in Senegal little else than the town of St Louis and a strip of coast. Explorers had, however, made known the riches and possibilities of the Niger regions, and Faidherbe formed the design of adding those countries to the French dominions. He even dreamed of creating a French African empire stretching from Senegal to the Red Sea. To accomplish even the first part of his design he had very inadequate resources, especially in view of the aggressive action of Omar Al-Hadji, the Moslem ruler of the countries of the middle Niger. By boldly advancing the French outposts on the upper Senegal Faidherbe stemmed the Moslem advance, and by an advantageous treaty with Omar in 1860 brought the French possessions into touch with the Niger. He also brought into subjection the country lying between the Senegal and Gambia. When he resigned his post French rule had been firmly established over a very considerable and fertile area and the foundation laid upon which his successors built up the predominant position occupied now by France in West Africa. In 1863 he became general of brigade. From 1867 to the early part of 1870 he commanded the subdivision of Bona in Algeria, and was commanding the Constantine division at the commencement of the Franco-German War. Promoted general of division in November 1870, he was on the 3rd of December appointed by the Govern-

ment of National Defence to be commander-in-chief of the army of the North. In this post he showed himself to be possessed of the highest military talents, and the struggle between the I. German army and that commanded by Faidherbe, in which were included the hard-fought battles of Pont Noyelles, Bapaume and St Quentin, was perhaps the most honourable to the French army in the whole of the People's War. Even with the inadequate force of which he disposed he was able to maintain a steady resistance up to the end of the war. Elected to the National Assembly for the department of the Nord, he resigned his seat in consequence of its reactionary proceedings. For his services he was decorated with the grand cross, and made chancellor of the order of the Legion of Honour. In 1872 he went on a scientific mission to Upper Egypt, where he studied the monuments and inscriptions. An enthusiastic geographer, philologist and archaeologist, he wrote numerous works, among which may be mentioned *Collection des inscriptions numidiques* (1870), *Épigraphie phénicienne* (1873), *Essai sur la langue poul* (1875), and *Le Zénaga des tribus sénégalaises* (1877), the last a study of the Berber language. He also wrote on the geography and history of Senegal and the Sahara, and *La Campagne de l'armée du Nord* (1872). He was elected a senator in 1879, and, in spite of failing health, continued to the last a close student of his favourite subjects. He died on the 29th of September 1889, and received a public funeral. Statues and monuments to his memory were erected at Lille, Bapaume, St Quentin and St Louis, Senegal.

FAIENCE, properly the French term for the *porzellana di Faenza*, a fine kind of glazed and painted earthenware made at Faenza in Italy, hence a term applied generally to all kinds of pottery other than unglazed pottery or porcelain. It is often particularly applied to the translucent earthenware made in Persia (see CERAMICS).

FAILLY, PIERRE LOUIS CHARLES DE (1810-1892), French general, was born at Rozoy-sur-Serre (Aisne) on the 21st of January 1810, and entered the army from St Cyr in 1828. In 1851 he had risen to the rank of colonel, and Napoleon III., with whom he was a favourite, made him general of brigade in 1854 and general of division in 1855, after which for a time De Faily was his aide-de-camp. In the war of 1859 De Faily commanded a division, and in 1867 he defeated Garibaldi at Mentana, this action being the first in which the chassepot was used. In 1870 De Faily commanded the V. corps. His inactivity at Bitsch on the 6th of August while the I. corps on his right and the II. corps on his left were crushed at Wörth and Spicheren respectively, gave rise to the greatest indignation in France, and his military career ended, after the V. corps had been severely handled at Beaumont on the 30th of August, with the catastrophe of Sedan. The rest of his life was spent in retirement. De Faily wrote *Campagne de 1870, Opérations et marche du 5^{me} corps jusqu'au 30 août* (Brussels, 1871).

FAIN, AGATHON JEAN FRANÇOIS (1778-1837), French historian, was born in Paris on the 11th of January 1778. Having gained admittance to the offices of the Directory, he became head of a department. Under the Consulate he entered the office of the secretary of state, in the department of the archives. In 1806 he was appointed secretary and archivist to the *cabinet particulier* of the emperor, whom he attended on his campaigns and journeys. He was created a baron of the empire in 1809, and, on the fall of Napoleon, was first secretary of the cabinet and confidential secretary. Compelled by the second Restoration to retire into private life, he devoted his leisure to writing the history of his times, an occupation for which his previous employments well fitted him. He published successively *Manuscrit de 1814, contenant l'histoire des six derniers mois du règne de Napoléon* (1823; new edition with illustrations, 1906); *Manuscrit de 1813, contenant le précis des événements de cette année pour servir à l'histoire de l'empereur Napoléon* (1824); *Manuscrit de 1812* (1827); and *Manuscrit de l'an iii. (1794-1795), contenant les premières transactions de l'Europe avec la république française et le tableau des derniers événements du régime conventionnel* (1828), all of which are remarkable for accuracy and wide range of knowledge, and are a very valuable source for the history of

Napoleon I. Of still greater importance for the history of Napoleon are Fain's *Mémoires*, which were published posthumously in 1908; they relate more particularly to the last five years of the empire, and give a detailed picture of the emperor at work on his correspondence among his confidential secretaries. Immediately after the overthrow of Charles X., King Louis Philippe appointed Fain first secretary of his cabinet (August 1830). Fain was a member of the council of state and deputy from Montargis from 1834 until his death, which occurred in Paris on the 16th of September 1837.

FAIR, a commercial institution, defined as a "greater species of market recurring at more distant intervals": both "fair" and "market" (*q.v.*) have been distinguished by Lord Coke from "mart," which he considers as a greater species of fair; and all three may be defined as periodic gatherings of buyers and sellers in an appointed place, subject to special regulation by law or custom. Thus in England from a strictly legal point of view there can be no fair or market without a franchise; and a franchise of fair or market can only be exercised by right of a grant from the crown, or by the authority of parliament or by prescription presupposing a grant. In the earliest times periodical trading in special localities was necessitated by the difficulties of communication and the dangers of travel. Public gatherings, whether religious, military or judicial, which brought together widely scattered populations, were utilized as opportunities for commerce. At the festivals of Delos and at the Olympic games trade, it is said, found important outlets, while in Etruria the annual general assembly at the temple of Voltumna served at the same time as a fair and was regularly attended by Roman traders. Instances of a similar nature might be multiplied; but it was above all with religious festivals which recurred with regularity and convoked large numbers of persons that fairs, as distinguished from markets, are most intimately associated.

The most commonly accepted derivation of the word "fair" is from the Latin *feria*, a name which the church borrowed from Roman custom and applied to her own festivals. A fair was generally held during the period of a saint's feast and in the precincts of his church or abbey, but in England this desecration of church or churchyard was first forbidden by the Statute of Winton (c. Edward I.). Most of the famous fairs of medieval England and Europe, with their tolls or other revenues, and, within certain limits of time and place, their monopoly of trade, were grants from the sovereign to abbots, bishops and other ecclesiastical dignitaries. Their "holy day" associations are preserved in the German word for fairs, *Messen*; as also in the *kirmiss*, "church mass," of the people of Brittany. So very intimate was the connexion between the fair and the feast of the saint that the former has very commonly been regarded as an off-shoot or development of the latter. But there is every reason to suppose that fairs were already existing national institutions, long before the church turned or was privileged to turn them to her own profit.

The first charter of the great fair of Stourbridge, near Cambridge, was granted by King John for the maintenance of a leper hospital; but the origin of the fair itself is ascribed to Carausius, the rebel emperor of Britain, A.D. 207. At all events, it may be seen from the *data* given in Herbert Spencer's *Descriptive Sociology* that the country had then arrived at the stage of development where fairs might have been recognized as a necessity. The Romans also appear to have elaborated a market-law similar to that in force throughout medieval Europe—though it must be observed that the Roman *nundinae*, which some have regarded as fairs, were weekly markets. It has also been supposed that the ancient fairs of Lyons were a special privilege granted by the Roman conquerors; and Sidonius Apollinaris, A.D. 427, alludes to the fairs of the district afterwards known as the county of Champagne, as if they were then familiarly known institutions. Fairs, in a word, would not only have arisen naturally, wherever the means of communication between individual centres of production and consumption were felt to be inadequate to the demand for an interchange of commodities; but, from their very nature, they might be expected to show

some essential resemblances, even in points of legislation, and where no international transmission of custom could have been possible. Thus, the fair courts of pre-Spanish Mexico corresponded very closely to those of the Beaucaire fair. They resembled the English courts of piepowder. The Spaniards, when first they saw the Mexican fairs, were reminded of the like institutions in Salamanca and Granada. The great fair or market at the city of Mexico is said to have been attended by about 40,000 or 50,000 persons, and is thus described by Prescott:—

"Officers patrolled the square, whose business it was to keep the peace, to collect the dues imposed on the various kinds of merchandise, to see that no false measures or fraud of any kind were used, and to bring offenders at once to justice. A court of twelve judges sat in one part of the *tianguex* clothed with those ample and summary powers which, in despotic countries, are often delegated even to petty tribunals. The extreme severity with which they exercised those powers, in more than one instance, proves that they were not a dead letter."

But notwithstanding the great antiquity of fairs, their charters are comparatively modern—the oldest known being that of St Denys, Paris, which Dagobert, king of the Franks, granted (A.D. 642) to the monks of the place "for the glory of God, and the honour of St Denys at his festival."

In England it was only after the Norman conquest that fairs became of capital importance. Records exist of 2800 grants of franchise markets and fairs between the years 1199 and 1483. More than half of these were made during the reigns of John and Henry III., when the power of the church was in ascendancy. The first recorded grant, however, appears to be that of William the Conqueror to the bishop of Winchester, for leave to hold an annual "free fair" at St Giles's hill. The monk who had been the king's jester received his charter of Bartholomew fair, Smithfield, in the year 1133. And in 1248 Henry III. granted a like privilege to the abbot of Westminster, in honour of the "translation" of Edward the Confessor. Sometimes fairs were granted to towns as a means for enabling them to recover from the effects of war and other disasters. Thus, Edward III. granted a "free fair" to the town of Burnley in Rutland, just as, in subsequent times, Charles VII. favoured Bordeaux after the English wars, and Louis XIV. gave fair charters to the towns of Dieppe and Toulon. The importance attached to these old fairs may be understood from the inducements which, in the 14th century, Charles IV. held out to traders visiting the great fair of Frankfort-on-Main. The charter declared that both during the continuance of the fair, and for eighteen days before and after it, merchants would be exempt from imperial taxation, from arrest for debt, or civil process of any sort, except such as might arise from the transactions of the market itself and within its precincts. Philip of Valois's regulations for the fairs of Troyes in Champagne might not only be accepted as typical of all subsequent fair-legislation of the kingdom, but even of the English and German laws on the subject. The fair had its staff of notaries for the attestation of bargains, its court of justice, its police officers, its sergeants for the execution of the market judges' decrees, and its visitors—of whom we may mention the *prud'hommes*,—whose duty it was to examine the quality of goods exposed for sale, and to confiscate those found unfit for consumption. The confiscation required the consent of five or six representatives of the merchant community at the fair. The effect of these great "free fairs" of England and the continent on the development of society was indeed great. They helped to familiarize the western and northern countries with the banking and financial systems of the Lombards and Florentines, who resorted to them under the protection of the sovereign's "firm peace," and the ghostly terrors of the pope. They usually became the seat of foreign agencies. In the names of her streets Provins preserved the memory of her 12th-century intercourse with the agents and merchants of Germany and the Low Countries, and long before that time the Syrian traders at St Denys had established their powerful association in Paris. Like the church on the religious side, the free fairs on the commercial side evoked and cherished the international spirit. And during long ages, when commercial "protection" was regarded

as indispensable to a nation's wealth, and the merchant was compelled to "fight his way through a wilderness of taxes," they were the sole and, so far as they went, the complete substitute for the free trade of later days.

Their privileges, however, were, from their very nature, destined to grow more oppressive and intolerable the more the towns were multiplied and the means of communication increased. The people of London were compelled to close their shops during the days when the abbot of Westminster's fair was open. But a more curious and complete instance of such an ecclesiastical monopoly was that of the St Giles's fair, at first granted for the customary three days, which were increased by Henry III. to sixteen. The bishop of Winchester was, as we have seen, the lord of this fair. On the eve of St Giles's feast the magistrates of Winchester surrendered the keys of the city gates to the bishop, who then appointed his own mayor, bailiff and coroner, to hold office until the close of the fair. During the same period, Winchester and Southampton also—though it was then a thriving trading town—were forbidden to transact their ordinary commercial business, except within the bishop's fair, or with his special permission. The bishop's officers were posted along the highways, with power to forfeit to his lordship all goods bought and sold within 7 m. of the fair—in whose centre stood "the pavilion," or bishop's court. It is clear, from the curious record of the *Establishment and Expenses of the Household of Percy*, 5th earl of Northumberland, that fairs were the chief centres of country traffic even as late as the 16th century. They began to decline rapidly after 1759, when good roads had been constructed and canal communication established between Liverpool and the towns of Yorkshire, Cheshire and Lancashire. In the great towns their extinction was hastened in consequence of their evil effects on public morals. All the London fairs were abolished as public nuisances before 1855—the last year of the ever famous fair of St Bartholomew; and the fairs of Paris were swept away in the storm of the Revolution.

English Fairs and Markets.—For the general reasons apparent from the preceding sketch, fairs in England, as in France and Germany, have very largely given way to markets for specialities. Even the live-stock market of the metropolis is being superseded by the dead-meat market, a change which has been encouraged by modern legislation on cattle disease, the movements of home stock and the importation of foreign animals. Agricultural markets are also disappearing before the "agencies" and the corn exchanges in the principal towns. Still there are some considerable fairs yet remaining. Of the English fairs for live stock, those of Weyhill in Hampshire (October 10), St Faith's, near Norwich (October 17), as also several held at Devizes, Wiltshire, are among the largest in the kingdom. The first named stands next to none for its display of sheep. Horncastle, Lincolnshire, is the largest horse fair in the kingdom, and is regularly visited by American and continental dealers. The other leading horse fairs in England are Howden in Yorkshire (well known for its hunters), Woodbridge (on Lady Day) for Suffolk horses, Barnet in Hertfordshire, and Lincoln. Exeter December fair has a large display of cattle, horses and most kinds of commodities. Large numbers of Scotch cattle are also brought to the fairs of Carlisle and Ormskirk. Nottingham has a fair for geese. Ipswich has a fair for lambs on the 1st of August, and for butter and cheese on the 1st of September. Gloucester fair is also famous for the last-named commodity. Falkirk fair, or tryst, for cattle and sheep, is one of the largest in Scotland; and Ballinasloe, Galway, holds a like position among Irish fairs. The Ballinasloe cattle are usually fed for a year in Leinster before they are considered fit for the Dublin or Liverpool markets.

French Fairs.—In France fairs and markets are held under the authority of the prefects, new fairs and markets being established by order of the prefects at the instance of the commune interested. Before the Revolution fairs and markets could only be established by *seigneurs justiciers*, but only two small markets have survived the law of 1790 abolishing private ownership of market rights, namely, the *Marché Ste Catherine* and the *Marché des enfants rouges*, both in Paris. Under the present system

markets and fairs are held in most of the towns and villages in France; and at all such gatherings entertainments form an important feature. The great fair of Beaucaire instituted in 1168) has steadily declined since the opening of railway communication, and now ranks with the fairs of ordinary provincial towns. Situated at the junction of the Rhône and the Canal du Midi, and less than 40 m. from the sea, it at one time attracted merchants from Spain, from Switzerland and Germany, and from the Levant and Mediterranean ports, and formed one of the greatest temporary centres of commerce on the continent. One trade firm alone, it is said, rarely did less than 1,000,000 francs worth of business during the fortnight that the fair lasted.

German Fairs.—In Germany the police authorities are considered the market authorities, and to them in most cases is assigned the duty of establishing new fairs and markets, subject to magisterial decision. The three great fairs of Germany are those of Frankfort-on-Main, Frankfort-on-Oder and Leipzig, but, like all the large fairs of Europe, they have declined rapidly in importance. Those of Frankfort-on-Main begin on Easter Tuesday and on the nearest Monday to September 8 respectively, and their legal duration is three weeks, though the limit is regularly extended. The fairs of the second-named city are *Reminiscere*, February or March; *St Margaret*, July; *St Martin*, November. Ordinarily they last fifteen days, which is double the legal term. The greatest of the German fairs are those of Leipzig, whose display of books is famous all over the world. Its three fairs are dated January 1, Easter, Michaelmas. The Easter one is the book fair, which is attended by all the principal booksellers of Germany, and by many more from the adjoining countries. Most German publishers have agents at Leipzig. As many as 5000 new publications have been entered in a single Leipzig catalogue. As in the other instances given, the Leipzig fairs last for three weeks, or nearly thrice their allotted duration. Here no days of grace are allowed, and the holder of a bill must demand payment when due, and protest, if necessary, on the same day, otherwise he cannot proceed against either drawer or endorser.

Russian Fairs.—In Russia fairs are held by local authorities. Landed proprietors may also hold fairs on their estates subject to the sanction of the local authorities; but no private tolls may be levied on commodities brought to such fairs. In Siberia and the east of Russia, where more primitive conditions foster such centres of trade, fairs are still of considerable importance. Throughout Russia generally they are very numerous. The most important, that of Nijni Novgorod, held annually in July and August at the confluence of the rivers Volga and Kama, was instituted in the 17th century by the tsar Michael Fedorovitch. In 1881 it was calculated that trade to the value of 246,000,000 roubles was carried on within the limits of the fair. It still continues to be of great commercial importance, and is usually attended by upwards of 100,000 persons from all parts of Asia and eastern Europe. Other fairs of consequence are those of Irbit in Perm, Kharkoff (January and August), Poltava (August and February), Koreunais in Koursk, Ourloupinskia in the Don Cossack country, Krolevets in Tchernigoff, and a third fair held at Poltava on the feast of the Ascension.

Indian Fairs.—The largest of these, and perhaps the largest in Asia, is that of Hurdwar, on the upper course of the Ganges. The visitors to this holy fair number from 200,000 to 300,000; but every twelfth year there occurs a special pilgrimage to the sacred river, when the numbers may amount to a million or upwards. Those who go solely for the purposes of trade are Nepalese, Mongolians, Tibetans, central Asiatics and Mahomedan pedlars from the Punjab, Sind and the border states. Persian shawls and carpets, Indian silks, Kashmir shawls, cottons (Indian and English), preserved fruits, spices, drugs, &c., together with immense numbers of cattle, horses, sheep and camels, are brought to this famous fair.

American Fairs.—The word "fair," as now used in the United States, appears to have completely lost its Old World meaning. It seems to be exclusively applied to industrial exhibitions and to what in England are called fancy bazaars. Thus, during the Civil War, large sums were collected at the "sanitary fairs,"

for the benefit of the sick and wounded. To the first-named class belong the state and county fairs, as they are called. Among the first and best-known of these was the "New York World's Fair," opened in 1853 by a company formed in 1851. (See EXHIBITION.)

Law of Fairs.—As no market or fair can be held in England without a royal charter, or right of prescription, so any person establishing a fair without such sanction is liable to be sued under a writ of *Quo warranto*, by any one to whose property the said market may be injurious. Nor can a fair or market be legally held beyond the time specified in the grant; and by 5 Edward III. c. 5 (1331) a merchant selling goods after the legal expiry of the fair forfeited double their value. To be valid, a sale must take place in "market-overt" (open market); "it will not be binding if it carries with it a presumption of fraudulence." These regulations satisfied, the sale "transfers a complete property in the thing sold to the vendee; so that however injurious or illegal the title of the vendor may be, yet the vendee's is good against all men except the king." (In Scottish law, the claims of the real owner would still remain valid.) However, by 21 Henry VIII. c. 2 (1529) it was enacted that, "if any felon rob or take away money, goods, or chattels, and be indicted and found guilty, or otherwise attainted upon evidence given by the owner or party robbed, or by any other by their procurement, the owner or party robbed shall be restored to his money, goods or chattels," but only those goods were restored which were specified in the indictment, now could the owner recover from a *bona fide* purchaser in market-overt who had sold the goods before conviction. For obvious reasons the rules of market-overt were made particularly stringent in the case of horses. Thus, by 2 Philip & Mary c. 7 (1555) and 31 Eliz. c. 12 (1589) no sale of a horse was legal which had not satisfied the following conditions:—Public exposure of the animal for at least an hour between sunrise and sunset; identification of the vendor by the market officer, or guarantee for his honesty by "one sufficient and credible person"; entry of these particulars, together with a description of the animal, and a statement of the price paid for it, in the market officer's book. Even if his rights should have been violated in spite of all these precautions, the lawful owner could recover, if he claimed within six months, produced witnesses, and tendered the price paid to the vendor. Tolls were not a "necessary incident" of a fair—i.e. they were illegal unless specially granted in the patent, or recognized by custom. As a rule, they were paid only by the vendee, and to the market clerk, whose record of the payment was an attestation to the genuineness of the purchase. By 2 & 3 Philip & Mary c. 7 every lord of a fair entitled to exact tolls was bound to appoint a clerk to collect and enter them. It was also this functionary's business to test measures and weights. Tolls, again, are sometimes held to include "stallage" and "picage," which mean respectively the price for permission to erect stalls and to dig holes for posts in the market grounds. But toll proper belongs to the lord of the market, whereas the other two are usually regarded as the property of the lord of the soil. The law also provided that stallage might be levied on any house situated in the vicinity of a market, and kept open for business during the legal term of the said market. Among modern statutes, one of the chief is the Markets and Fairs Clauses Act 1847, the chief purpose of which was to consolidate previous measures. By the act no proprietors of a new market were permitted to let stallages, take tolls, or in any way open their ground for business, until two justices of the peace certified to the completion of the fair or market. After the opening of the place for public use, no person other than a licensed hawk may sell anywhere within the borough, his own house or shop excepted, any articles in respect of which tolls are legally exigible in the market. A breach of this provision entails a penalty of forty shillings. Vendors of unwholesome meat are liable to a penalty of £5 for each offence; and the "inspectors of provisions" have full liberty to seize the goods and institute proceedings against the owners. They may also enter "at all times of the day, with or without assistance," the slaughter-house which the undertaker of the market may, by the special act, have been empowered to construct. For general sanitary reasons, persons are prohibited from killing animals anywhere except in these slaughter-houses. Again, by the Fairs Act 1873, times of holding fairs are determined by the secretary of state; while the Fairs Act 1871 empowers him to abolish any fair on the representation of the magistrate and with the consent of the owner. The preamble of the act states that many fairs held in England and Wales are both unnecessary and productive of "grievous immorality."

The Fair Courts.—The piepowder courts, the lowest but most expeditious courts of justice in the kingdom, as Chitty calls them, were very ancient. The Conqueror's law *De Emporiis* shows their pre-existence in Normandy. Their name was derived from *ped poudreux*, i. e. "dusty-foot."¹ The lord of the fair or his representative was the presiding judge, and usually he was assisted by a jury of traders chosen on the spot. Their jurisdiction was limited by the legal time and precincts of the fair, and to disputes about

contracts, "slander of wares," attestations, the preservation of order, &c.

Authorities.—See Herbert Spencer's *Descriptive Sociology* (1873), especially the columns and paragraphs on "Distribution"; Prescott's *History of Mexico*, for descriptions of fairs under the Aztecs; Giles Jacob's *Law Dictionary* (London, 1809); Joseph Chitty's *Treatise on the Law of Commerce and Manufactures*, vol. ii. chap. 9 (London, 1824); Holinshed's and Grafton's *Chronicles*, for lists, &c., of English fairs; Meyer's *Das grosse Conversations-Lexicon* (1852), under "Messen"; article "Foire" in Larousse's *Dictionnaire universelle du XIX^e siècle* (Paris, 1866–1874), and its references to past authorities; and especially, the second volume, commercial series, of the *Encyclopédie méthodique* (Paris, 1783); M'Culloch's *Dictionary of Commerce* (1869–1871); Wharton's *History of English Poetry*, pp. 185, 186 of edition of 1870 (London, Murray & Son), for a description of the Winchester Fair, &c.; a note by Professor Henry Morley in p. 498, vol. vii. *Notes and Queries*, second series; the same author's unique *History of the Fair of St Bartholomew* (London, 1859); Wharton's *Law Lexicon* (Will's edition, London, 1876); P. Huvclín's *Essai historique sur le droit des marchés et des foires* (Paris, 1897); *Report of the Royal Commission on Market Rights and Tolls*, vols. 1. (1889), xiv. (1891); *Final Report* (1891); Walford's *Fairs, Past and Present* (1883); *The Law relating to Markets and Fairs*, by Pease and Chitty (London, 1899). (J. MA.; EV. C.*)

FAIRBAIRN, ANDREW MARTIN (1838–), British Non-conformist divine, was born near Edinburgh on the 4th of November 1838. He was educated at the universities of Edinburgh and Berlin, and at the Evangelical Union Theological Academy in Glasgow. He entered the Congregational ministry and held pastorates at Bathgate, West Lothian and at Aberdeen. From 1877 to 1886 he was principal of Airedale College, Bradford, a post which he gave up to become the first principal of Mansfield College, Oxford. In the transference to Oxford under that name of Spring Hill College, Birmingham, he took a considerable part, and he has exercised influence not only over generations of his own students, but also over a large number of undergraduates in the university generally. He was granted the degree of M.A. by a decree of Convocation, and in 1903 received the honorary degree of doctor of literature. He was also given the degrees of doctor of divinity of Edinburgh and Yale, and doctor of laws of Aberdeen. His activities were not limited to his college work. He delivered the Muir lectures at Edinburgh University (1878–1882), the Gifford lectures at Aberdeen (1892–1894), the Lyman Beecher lectures at Yale (1891–1892), and the Haskell lectures in India (1898–1899). He was a member of the Royal Commission of Secondary Education in 1894–1895, and of the Royal Commission on the Endowments of the Welsh Church in 1906. In 1883 he was chairman of the Congregational Union of England and Wales. He is a prolific writer on theological subjects. He resigned his position at Mansfield College in the spring of 1909.

Among his works are:—*Studies in the Philosophy of Religion and History* (1876); *Studies in the Life of Christ* (1881); *Religion in History and in Modern Life* (1884; rev. 1893); *Christ in Modern Theology* (1893); *Christ in the Centuries* (1893); *Catholicism Roman and Anglican* (1899); *Philosophy of the Christian Religion* (1902); *Studies in Religion and Theology* (1909).

FAIRBAIRN, SIR WILLIAM, Bart. (1789–1874), Scottish engineer, was born on the 19th of February 1789 at Kelso, Roxburghshire, where his father was a farm-bailiff. In 1803 he obtained work at three shillings a week as a mason's labourer on the bridge then being built by John Rennie at Kelso; but within a few days he was incapacitated by an accident. Later in the same year, his father having been appointed steward on a farm connected with Percy Main Colliery near North Shields, he obtained employment as a carter in connexion with the colliery. In March 1804 he was bound an apprentice to a millwright at Percy Main, and then found time to supplement the deficiencies of his early education by systematic private study. It was at Percy Main that he made the acquaintance of George Stephenson, who then had charge of an engine at a neighbouring colliery. For some years subsequent to the expiry of his apprenticeship in 1811, he lived a somewhat roving life, seldom remaining long in one place and often reduced to very hard straits before he got employment. But in 1817 he entered into partnership with a shopmate, James Lillic, with whose aid he hired an old shed in High Street, Manchester, where he set up a lathe and began business. The firm quickly secured a good reputation,

¹ In Med. Lat. *pede-pulverosus* meant an itinerant merchant or pedlar. In Scots borough law "marchand travelland" and "dusty fute" are identical.

and the improvements in mill-work and water-wheels introduced by Fairbairn caused its fame to extend beyond Manchester to Scotland and even the continent of Europe. The partnership was dissolved in 1832.

In 1830 Fairbairn had been employed by the Forth and Clyde Canal Company to make experiments with the view of determining whether it were possible to construct steamers capable of traversing the canal at a speed which would compete successfully with that of the railway; and the results of his investigation were published by him in 1831, under the title *Remarks on Canal Navigation*. His plan of using iron boats proved inadequate to overcome the difficulties of this problem, but in the development of the use of this material both in the case of merchant vessels and men-of-war he took a leading part. In this way also he was led to pursue extensive experiments in regard to the strength of iron. In 1835 he established, in connexion with his Manchester business, a shipbuilding yard at Millwall, London, where he constructed several hundred vessels, including many for the royal navy; but he ultimately found that other engagements prevented him from paying adequate attention to the management, and at the end of fourteen years he disposed of the concern at a great loss. In 1837 he was consulted by the sultan of Turkey in regard to machinery for the government workshops at Constantinople. In 1845 he was employed, in conjunction with Robert Stephenson, in constructing the tubular railway bridges across the Conway and Menai Straits. The share he had in the undertaking has been the subject of some dispute; his own version is contained in a volume he published in 1849, *An Account of the Construction of the Britannia and Conway Tubular Bridges*. In 1849 he was invited by the king of Prussia to submit designs for the construction of a bridge across the Rhine, but after various negotiations, another design, by a Prussian engineer, which was a modification of Fairbairn's, was adopted. Another matter which engaged much of Fairbairn's attention was steam boilers, in the construction of which he effected many improvements. Amid all the cares of business he found time for varied scientific investigation. In 1851 his fertility and readiness of invention greatly aided an inquiry carried out at his Manchester works by Sir William Thomson (Lord Kelvin) and J. P. Joule, at the instigation of William Hopkins, to determine the melting points of substances under great pressure; and from 1861 to 1865 he was employed to guide the experiments of the government committee appointed to inquire into the "application of iron to defensive purposes." He died at Moor Park, Surrey, on the 18th of August 1874. Fairbairn was a member of many learned societies, both British and foreign, and in 1861 served as president of the British Association. He declined a knighthood in 1861, but accepted a baronetcy in 1869.

His youngest brother, Sir PETER FAIRBAIRN (1799-1861), founded a large machine manufacturing business in Leeds. Starting on a small scale with flax-spinning machinery, he subsequently extended his operations to the manufacture of textile machinery in general, and finally to that of engineering tools. He was knighted in 1858.

See *The Life of Sir William Fairbairn*, partly written by himself and edited and completed by Dr William Pole (1877).

FAIRBANKS, ERASTUS (1792-1864), American manufacturer, was born in Brimfield, Massachusetts, on the 28th of October 1792. He studied law but abandoned it for mercantile pursuits, finally settling in St Johnsbury, Vermont, where in 1824 he formed a partnership with his brother Thaddeus for the manufacture of stoves and ploughs. Subsequently the scales invented by Thaddeus were manufactured extensively. Erastus was a member of the state legislature in 1836-1838, and governor of Vermont in 1852-1853 and 1860-1861, during his second term rendering valuable aid in the equipment and despatch of troops in the early days of the Civil War. His son HORACE (1820-1888) became president of E. & T. Fairbanks & Co. in 1874, and was governor of Vermont from 1876 to 1878.

His brother, THADDEUS FAIRBANKS (1796-1886), inventor, was born at Brimfield, Massachusetts, on the 17th of January 1796. He early manifested a genius for mechanics and designed

the models from which he and his brother manufactured stoves and ploughs at St Johnsbury. In 1826 he patented a cast-iron plough which was extensively used. The growing of hemp was an important industry in the vicinity of St Johnsbury, and in 1831 Fairbanks invented a hemp-dressing machine. By the old contrivances then in use, the weighing of loads of hemp-straw was tedious and difficult, and in 1831 Fairbanks invented his famous compound-lever platform scale, which marked a great advance in the construction of machines for weighing bulky and heavy objects. He subsequently obtained more than fifty patents for improvements or innovations in scales and in machinery used in their manufacture, the last being granted on his ninetieth birthday. His firm, eventually known as E. & T. Fairbanks & Co., went into the manufacture of scales of all sizes, in which these inventions were utilized. He, with his brothers, Erastus and Joseph P., founded the St Johnsbury Academy. He died at St Johnsbury on the 12th of April 1886.

The latter's son HENRY, born in 1830 at St Johnsbury, Vermont, graduated at Dartmouth College in 1853 and at Andover Theological Seminary in 1857, and was professor of natural philosophy at Dartmouth from 1859 to 1865 and of natural history from 1865 to 1868. In the following year he patented a grain-scale and thenceforth devoted himself to the scale manufacturing business of his family. Altogether he obtained more than thirty patents for mechanical devices.

FAIRFAX, EDWARD (c. 1580-1635), English poet, translator of Tasso, was born at Leeds, the second son of Sir Thomas Fairfax of Denton (father of the 1st Baron Fairfax of Cameron). His legitimacy has been called in question, and the date of his birth has not been ascertained. He is said to have been only about twenty years of age when he published his translation of the *Gerusalemme Liberata*, which would place his birth about the year 1580. He preferred a life of study and retirement to the military service in which his brothers were distinguished. He married a sister of Walter Laycock, chief alnager of the northern counties, and lived on a small estate at Fewston, Yorkshire. There his time was spent in his literary pursuits, and in the education of his children and those of his elder brother, Sir Thomas Fairfax, afterwards baron of Cameron. His translation appeared in 1600,—*Godfrey of Bulloigne, or the Recoverie of Ierusalem, done into English heroically Verse by Edw. Fairfax, Gent.*, and was dedicated to the queen. It was enthusiastically received. In the same year in which it was published extracts from it were printed in *England's Parnassus*. Edward Phillips, the nephew of Milton, in his *Theatrum Poetarum*, warmly eulogized the translation. Edmund Waller said he was indebted to it for the harmony of his numbers. It is said that it was King James's favourite English poem, and that Charles I. entertained himself in prison with its pages. Fairfax employed the same number of lines and stanzas as his original, but within the limits of each stanza he allowed himself the greatest liberty. Other translators may give a more literal version, but Fairfax alone seizes upon the poetical and chivalrous character of the poem. He presented, says Mr Courthope, "an idea of the chivalrous past of Europe, as seen through the medium of Catholic orthodoxy and classical humanism." The sweetness and melody of many passages are scarcely excelled even by Spenser. Fairfax made no other appeal to the public. He wrote, however, a series of eclogues, twelve in number, the fourth of which was published, by permission of the family, in Mrs Cooper's *Muses' Library* (1737). Another of the eclogues and a *Discourse on Witchcraft, as it was acted in the Family of Mr Edward Fairfax of Fuystone in the county of York in 1621*, edited from the original copy by Lord Houghton, appeared in the *Miscellanies* of the Philobiblon Society (1858-1859). Fairfax was a firm believer in witchcraft. He fancied that two of his children had been bewitched, and he had the poor wretches whom he accused brought to trial, but without obtaining a conviction. Fairfax died at Fewston and was buried there on the 27th of January 1635.

FAIRFAX OF CAMERON, FERDINANDO FAIRFAX, 2ND BARON (1584-1648), English parliamentary general, was a son of Thomas Fairfax of Denton (1560-1640), who in 1627 was

created Baron Fairfax of Cameron in the peerage of Scotland. Born on the 29th of March 1584, he obtained his military education in the Netherlands, and was member of parliament for Boroughbridge during the six parliaments which met between 1614 and 1629 and also during the Short Parliament of 1640. In May 1640 he succeeded his father as Baron Fairfax, but being a Scottish peer he sat in the English House of Commons as one of the representatives of Yorkshire during the Long Parliament from 1640 until his death; he took the side of the parliament, but held moderate views and desired to maintain the peace. In the first Scottish war Fairfax had commanded a regiment in the king's army; then on the outbreak of the Civil War in 1642 he was made commander of the parliamentary forces in Yorkshire, with Newcastle as his opponent. Hostilities began after the repudiation of a treaty of neutrality entered into by Fairfax with the Royalists. At first he met with no success. He was driven from York, where he was besieging the Royalists, to Selby; then in 1643 to Leeds; and after beating off an attack at that place he was totally defeated on the 30th of June at Adwalton Moor. He escaped to Hull, which he successfully defended against Newcastle from the 2nd of September till the 11th of October, and by means of a brilliant sally caused the siege to be raised. Fairfax was victorious at Selby on the 11th of April 1644, and joining the Scots besieged York, after which he was present at Marston Moor, where he commanded the infantry and was routed. He was subsequently, in July, made governor of York and charged with the further reduction of the county. In December he took the town of Pontefract, but failed to secure the castle. He resigned his command on the passing of the Self-denying Ordinance, but remained a member of the committee for the government of Yorkshire, and was appointed, on the 24th of July 1645, steward of the manor of Pontefract. He died from an accident on the 14th of March 1648 and was buried at Bolton Percy. He was twice married, and by his first wife, Mary, daughter of Edmund Sheffield, 3rd Lord Sheffield (afterwards 1st earl of Mulgrave), he had six daughters and two sons, Thomas, who succeeded him as 3rd baron, and Charles, a colonel of horse, who was killed at Marston Moor. During his command in Yorkshire, Fairfax engaged in a paper war with Newcastle, and wrote *The Answer of Ferdinando, Lord Fairfax, to a Declaration of William, earl of Newcastle* (1642; printed in Rushworth, pt. iii. vol. ii. p. 139); he also published *A Letter from . . . Lord Fairfax to . . . Robert, Earl of Essex* (1643), describing the victorious sally at Hull.

FAIRFAX OF CAMERON, THOMAS FAIRFAX, 3RD BARON (1612-1671), parliamentary general and commander-in-chief during the English Civil War, the eldest son of the 2nd lord, was born at Denton, near Otley, Yorkshire, on the 17th of January 1612. He studied at St John's College, Cambridge (1626-1629), and then proceeded to Holland to serve as a volunteer with the English army in the Low Countries under Sir Horace (Lord) Vere. This connexion led to one still closer; in the summer of 1637 Fairfax married Anne Vere, the daughter of the general.

The Fairfaxes, father and son, though serving at first under Charles I. (Thomas commanded a troop of horse, and was knighted by the king in 1640), were opposed to the arbitrary prerogative of the crown, and Sir Thomas declared that "his judgment was for the parliament as the king and kingdom's great and safest council." When Charles endeavoured to raise a guard for his own person at York, intending it, as the event afterwards proved, to form the nucleus of an army, Fairfax was employed to present a petition to his sovereign, entreating him to hearken to the voice of his parliament, and to discontinue the raising of troops. This was at a great meeting of the freeholders and farmers of Yorkshire convened by the king on Heworth Moor near York. Charles evaded receiving the petition, pressing his horse forward, but Fairfax followed him and placed the petition on the pommel of the king's saddle. The incident is typical of the times and of the actors in the scene. War broke out, Lord Fairfax was appointed general of the Parliamentary forces in the north,

and his son, Sir Thomas, was made lieutenant-general of the horse under him. Both father and son distinguished themselves in the campaigns in Yorkshire (see GREAT REBELLION). Sometimes severely defeated, more often successful, and always energetic, prudent and resourceful, they contrived to keep up the struggle until the crisis of 1644, when York was held by the marquess of Newcastle against the combined forces of the English Parliamentarians and the Scots, and Prince Rupert hastened with all available forces to its relief. A gathering of eager national forces within a few square miles of ground naturally led to a battle, and Marston Moor (*q.v.*) was decisive of the struggle in the north. The younger Fairfax bore himself with the greatest gallantry in the battle, and though severely wounded managed to join Cromwell and the victorious cavalry on the other wing. One of his brothers, Colonel Charles Fairfax, was killed in the action. But the marquess of Newcastle fled the kingdom, and the Royalists abandoned all hope of retrieving their affairs. The city of York was taken, and nearly the whole north submitted to the parliament.

In the south and west of England, however, the Royalist cause was still active. The war had lasted two years, and the nation began to complain of the contributions that were exacted, and the excesses that were committed by the military. Dissatisfaction was expressed with the military commanders, and, as a preliminary step to reform, the Self-denying Ordinance was passed. This involved the removal of the earl of Essex from the supreme command, and the reconstruction of the armed forces of the parliament. Sir Thomas Fairfax was selected as the new lord general with Cromwell as his lieutenant-general and cavalry commander, and after a short preliminary campaign the "New Model" justified its existence, and "the rebels' new brutish general," as the king called him, his capacity as commander-in-chief in the decisive victory of Naseby (*q.v.*). The king fled to Wales. Fairfax besieged Leicester, and was successful at Taunton, Bridgwater and Bristol. The whole west was soon reduced.

Fairfax arrived in London on the 12th of November 1645. In his progress towards the capital he was accompanied by applauding crowds. Complimentary speeches and thanks were presented to him by both houses of parliament, along with a jewel of great value set with diamonds, and a sum of money. The king had returned from Wales and established himself at Oxford, where there was a strong garrison, but, ever vacillating, he withdrew secretly, and proceeded to Newark to throw himself into the arms of the Scots. Oxford capitulated; and by the end of September 1646 Charles had neither army nor garrison in England. In January 1647 he was delivered up by the Scots to the commissioners of parliament. Fairfax met the king beyond Nottingham, and accompanied him during the journey to Holmby, treating him with the utmost consideration in every way. "The general," said Charles, "is a man of honour, and keeps his word which he had pledged to me." With the collapse of the Royalist cause came a confused period of negotiations between the parliament and the king, between the king and the Scots, and between the Presbyterians and the Independents in and out of parliament. In these negotiations the New Model Army soon began to take a most active part. The lord general was placed in the unpleasant position of intermediary between his own officers and parliament. To the grievances, usual in armies of that time, concerning arrears of pay and indemnity for acts committed on duty, there was quickly added the political propaganda of the Independents, and in July the person of the king was seized by Joyce, a subaltern of cavalry—an act which sufficiently demonstrated the hopelessness of controlling the army by its articles of war. It had, in fact, become the most formidable political party in the realm, and pressed straight on to the overthrow of parliament and the punishment of Charles. Fairfax was more at home in the field than at the head of a political committee, and, finding events too strong for him, he sought to resign his commission as commander-in-chief. He was, however, persuaded to retain it. He thus remained the titular chief of the army party, and with the greater part of its objects

he was in complete, sometimes most active, sympathy. Shortly before the outbreak of the second Civil War, Fairfax succeeded his father in the barony and in the office of governor of Hull. In the field against the English Royalists in 1648 he displayed his former energy and skill, and his operations culminated in the successful siege of Colchester, after the surrender of which place he approved the execution of the Royalist leaders Sir Charles Lucas and Sir George Lisle, holding that these officers had broken their parole. At the same time Cromwell's great victory of Preston crushed the Scots, and the Independents became practically all-powerful.

Milton, in a sonnet written during the siege of Colchester, called upon the lord general to settle the kingdom, but the crisis was now at hand. Fairfax was in agreement with Cromwell and the army leaders in demanding the punishment of Charles, and he was still the effective head of the army. He approved, if he did not take an active part in, Pride's Purge (December 6th, 1648), but on the last and gravest of the questions at issue he set himself in deliberate and open opposition to the policy of the officers. He was placed at the head of the judges who were to try the king, and attended the preliminary sitting of the court. Then, convinced at last that the king's death was intended, he refused to act. In calling over the court, when the crier pronounced the name of Fairfax, a lady in the gallery called out "that the Lord Fairfax was not there in person, that he would never sit among them, and that they did him wrong to name him as a commissioner." This was Lady Fairfax, who could not forbear, as Whitelocke says, to exclaim aloud against the proceedings of the High Court of Justice. His last service as commander-in-chief was the suppression of the Leveller mutiny at Burford in May 1649. He had given his adhesion to the new order of things, and had been reappointed lord general. But he merely administered the affairs of the army, and when in 1650 the Scots had declared for Charles II., and the council of state resolved to send an army to Scotland in order to prevent an invasion of England, Fairfax resigned his commission. Cromwell was appointed his successor, "captain-general and commander-in-chief of all the forces raised or to be raised by authority of parliament within the commonwealth of England." Fairfax received a pension of £5000 a year, and lived in retirement at his Yorkshire home of Nunappleton till after the death of the Protector. The troubles of the later Commonwealth recalled Lord Fairfax to political activity, and for the last time his appearance in arms helped to shape the future of the country, when Monk invited him to assist in the operations about to be undertaken against Lambert's army. In December 1659 he appeared at the head of a body of Yorkshire gentlemen, and such was the influence of Fairfax's name and reputation that 1200 horse quitted Lambert's colours and joined him. This was speedily followed by the breaking up of all Lambert's forces, and that day secured the restoration of the monarchy. A "free" parliament was called; Fairfax was elected member for Yorkshire, and was put at the head of the commission appointed by the House of Commons to wait upon Charles II. at the Hague and urge his speedy return. Of course the "merry monarch, scandalous and poor," was glad to obey the summons, and Fairfax provided the horse on which Charles rode at his coronation. The remaining eleven years of the life of Lord Fairfax were spent in retirement at his seat in Yorkshire. He must, like Milton, have been sorely grieved and shocked by the scenes that followed—the brutal indignities offered to the remains of his companions in arms, Cromwell and Ireton, the sacrifice of Sir Harry Vane, the neglect or desecration of all that was great, noble or graceful in England, and the flood of immorality which, flowing from Whitehall, sapped the foundations of the national strength and honour. Lord Fairfax died at Nunappleton on the 12th of November 1671, and was buried at Bilborough, near York. As a soldier he was exact and methodical in planning, in the heat of battle "so highly transported that scarce any one durst speak a word to him" (Whitelocke), chivalrous and punctilious in his dealings with his own men and the enemy. Honour and conscientiousness were equally the

characteristics of his private and public character. But his modesty and distrust of his powers made him less effectual as a statesman than as a soldier, and above all he is placed at a disadvantage by being both in war and peace overshadowed by his associate Cromwell.

Lord Fairfax had a taste for literature. He translated some of the Psalms, and wrote poems on solitude, the Christian warfare, the shortness of life, &c. During the last year or two of his life he wrote two *Memorials* which have been published—one on the northern actions in which he was engaged in 1642-1644, and the other on some events in his tenure of the chief command. At York and at Oxford he endeavoured to save the libraries from pillage, and he enriched the Bodleian with some valuable MSS. His only daughter, Mary Fairfax, was married to George Villiers, the profligate duke of Buckingham of Charles II.'s court.

His correspondence, edited by G. W. Johnson, was published in 1848-1849 in four volumes (see note thereon in *Dict. Nat. Biogr.*, s.v.), and a life of him by Clements R. Markham in 1870. See also S. R. Gardiner, *History of the Great Civil War* (1893).

His descendant Thomas, 6th baron (1692-1782), inherited from his mother, the heiress of Thomas, 2nd Baron Culpepper, large estates in Virginia, U.S.A., and having sold Denton Hall and his Yorkshire estates he retired there about 1746, dying a bachelor. He was a friend of George Washington. Thomas found his cousin William Fairfax settled in Virginia, and made him his agent, and Bryan (1737-1802), the son of William Fairfax, eventually inherited the title, becoming 8th baron in 1793. His claim was admitted by the House of Lords in 1800. But it was practically dropped by the American family, until, shortly before the coronation of Edward VII., the successor in title was discovered in Albert Kirby Fairfax (b. 1870), a descendant of the 8th baron, who was an American citizen. In November 1908 Albert's claim to the title as 12th baron was allowed by the House of Lords.

FAIRFIELD, a township in Fairfield county, Connecticut, U.S.A., near Long Island Sound, adjoining Bridgeport on the E. and Westport on the W. Pop. (1890) 3868; (1900) 4489 (1041 being foreign-born); (1910) 6134. It is served by the New York, New Haven & Hartford railway. The principal villages of the township are Fairfield, Southport, Greenfield Hill and Stratfield. The beautiful scenery and fine sea air attract to the township a considerable number of summer visitors. The township has the well-equipped Pequot and Fairfield memorial libraries (the former in the village of Southport, the latter in the village of Fairfield), the Fairfield fresh air home (which cares for between one and two hundred poor children of New York during each summer season), and the Gould home for self-supporting women. The Fairfield Historical Society has a museum of antiquities and a collection of genealogical and historical works. Among Fairfield's manufactures are chemicals, wire and rubber goods. Truck-gardening is an important industry of the township. In the Pequot Swamp within the present Fairfield a force of Pequot Indians was badly defeated in 1637 by some whites, among whom was Roger Ludlow, who, attracted by the country, founded the settlement in 1639 and gave it its present name in 1645. Within its original limits were included what are now the townships of Redding (separated, 1767), Weston (1787) and Easton (formed from part of Weston in 1845), and parts of the present Westport and Bridgeport. During the colonial period Fairfield was a place of considerable importance, but subsequently it was greatly outstripped by Bridgeport, to which, in 1870, a portion of it was annexed. On the 8th of July 1779 Fairfield was burned by the British and Hessians under Governor William Tryon. Among the prominent men who have lived in Fairfield are Roger Sherman, the first President Dwight of Yale (who described Fairfield in his *Travels* and in his poem *Greenfield Hill*), Chancellor James Kent, and Joseph Earle Sheffield.

See Frank S. Child, *An Old New England Town, Sketches of Life, Scenery and Character* (New York, 1895); and Mrs E. H. Schenck, *History of Fairfield* (2 vols., New York, 1889-1905).

FAIRFIELD, a city and the county-seat of Jefferson county, Iowa, U.S.A., about 51 m. W. by N. of Burlington. Pop. (1890) 3391; (1900) 4689, of whom 206 were foreign-born and 54 were

negroes; (1905) 5009; (1910) 4970. Area, about 2.25 sq. m. Fairfield is served by the Chicago, Burlington & Quincy, and the Chicago, Rock Island & Pacific railways. The city is in a blue grass country, in which much live stock is bred; and it is an important market for draft horses. It is the seat of Parsons College (Presbyterian, co-educational, 1875), endowed by Lewis Baldwin Parsons, Sr. (1798–1855), a merchant of Buffalo, N.Y. The college offers classical, philosophical and scientific courses, and has a school of music and an academic department; in 1907–1908 it had 19 instructors and 257 students, of whom 93 were in the college and 97 were in the school of music. Fairfield has a Carnegie library (1892), and a museum with a collection of laces. Immediately E. of the city is an attractive Chautauqua Park, of 30 acres, with an auditorium capable of seating about 4000 persons; and there is an annual Chautauqua assembly. The principal manufactures of Fairfield are farm waggons, farming implements, drain-tile, malleable iron, cotton gloves and mittens and cotton garments. The municipality owns its water-works and an electric-lighting plant. Fairfield was settled in 1839; was incorporated as a town in 1847; and was first chartered as a city in the same year.

See Charles H. Fletcher, *Jefferson County, Iowa: Centennial History* (Fairfield, 1876).

FAIRHAVEN, a township in Bristol county, Massachusetts, U.S.A., on New Bedford Harbor, opposite New Bedford. Pop. (1890) 2919; (1900) 3567 (599 being foreign-born); (1905, state census) 4235; (1910) 5122. Area, about 13 sq. m. Fairhaven is served by the New York, New Haven & Hartford railway and by electric railway to Mattapoisett and Marion, and is connected with New Bedford by two bridges, by electric railway, and by the New York, New Haven & Hartford ferry line. The principal village is Fairhaven; others are Oxford, Nasketucket and Sciticut Neck. As a summer resort Fairhaven is widely known. Among the principal buildings are the following, presented to the township by Henry H. Rogers (1840–1909), a native of Fairhaven and a large stockholder and long vice-president of the Standard Oil Co.; the town hall, a memorial of Mrs Rogers, the Rogers public schools; the Millicent public library (17,500 vols. in 1908), a memorial to his daughter; and a fine granite memorial church (Unitarian) with parish house, a memorial to his mother; and there is also a public park, of 13 acres, the gift of Mr Rogers. From 1830 to 1857 the inhabitants of Fairhaven were chiefly engaged in whaling, and the fishing interests are still important. Among manufactures are tacks, nails, iron goods, loom-cranks, glass, yachts and boats, and shoes.

Fairhaven, originally a part of New Bedford, was incorporated as a separate township in 1812. On the 5th of September 1778 a fleet and armed force under Earl Grey, sent to punish New Bedford and what is now Fairhaven for their activity in privateering, burned the shipping and destroyed much of New Bedford. The troops then marched to the head of the Acushnet river, and down the east bank to Sciticut Neck, where they camped till the 7th of September, when they re-embarked, having meanwhile dismantled a small fort, built during the early days of the war, on the east side of the river at the entrance to the harbour. On the evening of the 8th of September a landing force from the fleet, which had begun to set fire to Fairhaven, was driven off by a body of about 150 minute-men commanded by Major Israel Fearing; and on the following day the fleet departed. The fort was at once rebuilt and was named Fort Fearing, but as early as 1784 it had become known as Fort Phoenix; it was one of the strongest defences on the New England coast during the war of 1812. The township of Acushnet was formed from the northern part of Fairhaven in 1860.

See James L. Gillingham and others, *A Brief History of the Town of Fairhaven, Massachusetts* (Fairhaven, 1903).

FAIRHOLT, FREDERICK WILLIAM (1814–1866), English antiquary and wood engraver, was born in London in 1814. His father, who was of a German family (the name was originally Fahrholz), was a tobacco manufacturer, and for some years Fairholt himself was employed in the business. For a time he was a drawing-master, afterwards a scene-painter, and in 1835 he became assistant to S. Sly, the wood engraver. Some pen

and ink copies made by him of figures from Hogarth's plates led to his being employed by Charles Knight on several of his illustrated publications. His first published literary work was a contribution to Hone's *Year-Book* in 1831. His life was one of almost uninterrupted quiet labour, carried on until within a few days of death. Several works on civic pageantry and some collections of ancient unpublished songs and dialogues were edited by him for the Percy Society in 1842. In 1844 he was elected fellow of the Society of Antiquaries. He published an edition of the dramatic works of Lyly in 1856. His principal independent works are *Tobacco, its History and Association* (1859); *Gog and Magog* (1860); *Up the Nile and Home Again* (1862); many articles and serials contributed to the *Art Journal*, some of which were afterwards separately published, as *Costume in England* (1846); *Dictionary of Terms in Art* (1854). These works are illustrated by numerous cuts, drawn on the wood by his own hand. His pencil was also employed in illustrating Evans's *Coins of the Ancient Britons*, Madden's *Jewish Coinage*, Halliwell's folio *Shakespeare* and his *Sir John Maundeville*, Roach Smith's *Richborough*, the *Miscellanea Graphica* of Lord Londesborough, and many other works. He died on the 3rd of April 1866. His books relating to Shakespeare were bequeathed to the library at Stratford-on-Avon; those on civic pageantry (between 200 and 300 volumes) to the Society of Antiquaries; his old prints and works on costume to the British Museum; his general library he desired to be sold and the proceeds devoted to the Literary Fund.

FAIRMONT, a city and the county-seat of Marion county, West Virginia, U.S.A., on both sides of the Monongahela river, about 75 m. S.E. of Wheeling. Pop. (1890) 1023; (1900) 5655, of whom 283 were negroes and 182 foreign-born; (1910) 9711. It is served by the Baltimore & Ohio railway. Among its manufactures are glass, machinery, flour and furniture, and it is an important shipping point for coal mined in the vicinity. The city is the seat of one of the West Virginia state normal schools. Fairmont was laid out as Middletown in 1819, became the county-seat of the newly established Marion county in 1842, received its present name about 1844, and was chartered as a city in 1899.

FAIR OAKS, a station on a branch of the Southern railway, 6 m. E. of Richmond, Virginia, U.S.A. It is noted as the site of one of the battles of the Civil War, fought on the 31st of May and the 1st of June 1862, between the Union (Army of the Potomac) under General G. B. McClellan and the Confederate forces (Army of Northern Virginia) commanded by General J. E. Johnston. The attack of the Confederates was made at a moment when the river Chickahominy divided the Federal army into two unequal parts, and was, moreover, swollen to such a degree as to endanger the bridges. General Johnston stationed part of his troops along the river to prevent the Federals sending aid to the smaller force south of it, upon which the Confederate attack, commanded by General Longstreet, was directed. Many accidents, due to the inexperience of the staff officers and to the difficulty of the ground, hindered the development of Longstreet's attack, but the Federals were gradually driven back with a loss of ten guns, though at the last moment reinforcements managed to cross the river and re-establish the line of defence. At the close of the day Johnston was severely wounded, and General G. W. Smith succeeded to the command. The battle was renewed on the 1st of June but not fought out. At the close of the action General R. E. Lee took over the command of the Confederates, which he held till the final surrender in April 1865. So far as the victory lay with either side, it was with the Union army, for the Confederates failed to achieve their purpose of destroying the almost isolated left wing of McClellan's army, and after the battle they withdrew into the lines of Richmond. The Union losses were 5031 in killed, wounded and missing; those of the Confederates were 6134. The battle is sometimes known as the battle of Seven Pines.

FAIRŪZĀBĀDĪ [Abū-ṭ-Ṭāhīr ibn Ibrāhīm Majd ud-Dīn ul-Fairūzābādī] (1329–1414), Arabian lexicographer, was born at Kārazīn near Shiraz. His student days were spent in Shiraz, Wāsiṭ, Bagdad and Damascus. He taught for ten years in

Jerusalem, and afterwards travelled in western Asia and Egypt. In 1368 he settled in Mecca, where he remained for fifteen years. Henext visited India and spent some time in Delhi, then remained in Mecca another ten years. The following three years were spent in Bagdad, in Shiraz (where he was received by Timur), and in Ta'iz. In 1395 he was appointed chief *cadi* (*qadi*) of Yemen, married a daughter of the sultan, and died at Zabīd in 1414. During this last period of his life he converted his house at Mecca into a school of Mālikite law and established three teachers in it. He wrote a huge lexicographical work of 60 or 100 volumes uniting the dictionaries of Ibn Sida, a Spanish philologist (d. 1066), and of Sajānī (d. 1252). A digest of or an extract from this last work is his famous dictionary *al-Qāmūs* ("the Ocean"), which has been published in Egypt, Constantinople and India, has been translated into Turkish and Persian, and has itself been the basis of several later dictionaries. (G. W. T.)

FAIRY (Fr. *fée*, *faerie*; Prov. *fada*; Sp. *hada*; Ital. *fata*; med. Lat. *fatare*, to enchant, from Lat. *fatum*, fate, destiny), the common term for a supposed race of supernatural beings who magically intermeddle in human affairs. Of all the minor creatures of mythology the fairies are the most beautiful, the most numerous, the most memorable in literature. Like all organic growths, whether of nature or of the fancy, they are not the immediate product of one country or of one time; they have a pedigree, and the question of their ancestry and affiliation is one of wide bearing. But mixture and connexion of races have in this as in many other cases so changed the original folk-product that it is difficult to disengage and separate the different strains that have gone to the making or moulding of the result as we have it.

It is not in literature, however ancient, that we must look for the early forms of the fairy belief. Many of Homer's heroes have fairy lemans, called nymphs, fairies taken up into a higher region of poetry and religion; and the fairy leman is notable in the story of Athamas and his cloud bride Nephelē, but this character is as familiar to the unpoetical Eskimo, and to the Red Indians, with their bird-bride and beaver-bride (see A. Lang's *Custom and Myth*, "The Story of Cupid and Psyche"). The Gandharvas of Sanskrit poetry are also fairies.

One of the most interesting facts about fairies is the wide distribution and long persistence of the belief in them. They are the chief factor in surviving Irish superstition. Here they dwell in the "raths," old earth-forts, or earthen bases of later palisaded dwellings of the Norman period, and in the subterranean houses, common also in Scotland. They are an organized people, often called "the army," and their life corresponds to human life in all particulars. They carry off children, leaving changeling substitutes, transport men and women into fairyland, and are generally the causes of all mysterious phenomena. Whirls of dust are caused by the fairy marching army, as by the being called Kutchi in the Dieri tribe of Australia. In 1907, in northern Ireland, a farmer's house was troubled with flying stones (see **POLTERGEIST**). The neighbours said that the fairies caused the phenomenon, as the man had swept his chimney with a bough of holly, and the holly is "a gentle tree," dear to the fairies. The fairy changeling belief also exists in some districts of Argyll, and a fairy boy dwelt long in a small farm-house in Glencoe, now unoccupied.

In Ireland and the west Highlands neolithic arrow-heads and flint chips are still fairy weapons. They are dipped in water, which is given to ailing cattle and human beings as a sovereign remedy for diseases. The writer knows of "a little lassie in green" who is a fairy and, according to the percipients, haunts the banks of the Mukomar pool on the Lochy. In Glencoe is a fairy hill where the fairy music, vocal and instrumental, is heard in still weather. In the Highlands, however, there is much more interest in second sight than in fairies, while in Ireland the reverse is the case. The best book on Celtic fairy lore is still that of the minister of Aberfoyle, the Rev. Mr Kirk (*ob.* 1692). His work on *The Secret Commonwealth of Elves, Fauns and Fairies*, left in MS. and incomplete (the remainder is in the Laing

MSS., Edinburgh University library), was published (a hundred copies) in 1815 by Sir Walter Scott, and in the Bibliothèque de Carabas (Lang) there is a French translation. Mr Kirk is said (though his tomb exists) to have been carried away by fairies. He appeared to a friend and said that he would come again, when the friend must throw a dirk over his shoulder and he would return to this world. The friend, however, lost his nerve and did not throw the dirk. In the same way a woman re-appeared to her husband in Glencoe in the last generation, but he was wooing another lass and did not make any effort to recover his wife. His character was therefore lost in the glen.

It is clear that in many respects fairyland corresponds to the pre-Christian abode of the dead. Like Persephone when carried to Hades, or Wainamoïnen in the Hades of the Finns (Manala), a living human being must not eat in fairyland; if he does, he dwells there for ever. Tamlane in the ballad, however, was "fat and fair of flesh," yet was rescued by Janet: probably he had not abstained from fairy food. He was to be given as the *kane* to Hell, which shows a distinction between the beliefs in hell and in the place of fairies.

It is a not uncommon theory that the fairies survive in legend from prehistoric memories of a pigmy people dwelling in the subterranean earth-houses, but the contents of these do not indicate an age prior to the close of the Roman occupation of Britain; nor are pigmy bones common in neolithic sepulchres. The "people of peace" (*Daoine Shie*) of Ireland and Scotland are usually of ordinary stature, indeed not to be recognized as varying from mankind except by their proceedings (see J. Curtin, *Irish Folk-tales*).

The belief in a species of lady fairies, deathly to their human lovers, was found by R. L. Stevenson to be as common in Samoa (see *Island Nights' Entertainments*) as in Strathfinlas or on the banks of Loch Awe. In New Caledonia a native friend of J. J. Atkinson (author of *Primal Law*) told him that he had met and caressed the girl of his heart in the forest, that she had vanished and must have been a fairy. He therefore would die in three days, which (Mr Atkinson informs the writer) he punctually did. The Greek sirens of Homer are clearly a form of these deadly fairies, as the Nereids and Oreads and Naiads are fairies of wells, mountains and the sea. The fairy women who come to the births of children and foretell their fortunes (*Fata*, *Moerae*, ancient Egyptian *Hathors*, *Fées*, *Dominae Fatales*), with their spindles, are refractions of the human "spae-women" (in the Scots term) who attend at birth and derive omens of the child's future from various signs. The custom is common among several savage races, and these women, represented in the spiritual world by *Fata*, bequeath to us the French *fée*, in the sense of fairy. Perrault also uses *fée* for anything that has magical quality; "the key was *fée*," had *mana*, or *wakan*, savage words for the supposed "power," or *ether*, which works magic or is the vehicle of magical influences.

Though the fairy belief is universally human, the nearest analogy to the shape which it takes in Scotland and Ireland—the "pixies" of south-western England—is to be found in *Jān* or *Jinnis* of the Arabs, Moors and people of Palestine. In stories which have passed through a literary medium, like *The Arabian Nights*, the *geni* or *Jān* do not so much resemble our fairies as they do in the popular superstitions of the East, orally collected. The *Jān* are now a subterranean commonwealth, now they reside in ruinous places, like the fairies in the Irish raths. Like the fairies they go about in whirls of dust, or the dust-whirls themselves are *Jān*. They carry off men and women "to their own herd," in the phrase of Mr Kirk, and are kind to mortals who are kind to them. They chiefly differ from our fairies in their greater tendency to wear animal forms; though, like the fairies, when they choose to appear in human shape they are not to be distinguished from men and women of mortal mould. Like the fairies everywhere they have amours with mortals, such as that of the Queen of Faery with Thomas of Ercildoune. The herb rue is potent against them, as in British folk-lore, and a man long captive among the *Jān* escaped from them by observing their avoidance of rue, and by plucking two handfuls

thereof. They, like the British brownies (a kind of domesticated fairy), are the causes of strange disappearances of things. To preserve houses from their influences, rue, that "herb of grace," is kept in the apartments, and the name of Allah is constantly invoked. If this is omitted, things are stolen by the *Jân*.

They often bear animal names, and it is dangerous to call a cat or dog without pointing at the animal, for a *Jinni* of the same name may be present and may take advantage of the invocation. A man, in fun, called to a goat to escort his wife on a walk: he did not point at the goat, and the wife disappeared. A *Jinni* had carried her off, and her husband had to seek her at the court of the *Jân*. Euphemistically they are addressed as *mubārakin*, "blessed ones," as we say "the good folk" or "the people of peace." As our fairies give gold which changes into withered leaves, the *Jân* give onion peels which turn into gold. Like our fairies the *Jân* can apply an ointment, kohl, to human eyes, after which the person so favoured can see *Jân*, or fairies, which are invisible to other mortals, and can see treasure wherever it may be concealed (see *Folk-lore of the Holy Land*, by J. E. Hanauer, 1907).

It is plain that fairies and *Jân* are practically identical, a curious proof of the uniformity of the working of imagination in peoples widely separated in race and religion. Fairies naturally won their way into the poetry of the middle ages. They take lovers from among men, and are often described as of delicate, unearthly, ravishing beauty. The enjoyment of their charms is, however, generally qualified by some restriction or compact, the breaking of which is the cause of calamity to the lover and all his race, as in the notable tale of Melusine. This fay by enchantment built the castle of Lusignan for her husband. It was her nature to take every week the form of a serpent from the waist below. The hebdomadal transformation being once, contrary to compact, witnessed by her husband, she left him with much wailing, and was said to return and give warning by her appearance and great shrieks whenever one of the race of Lusignan was about to die. At the birth of Ogier le Danois six fairies attend, five of whom give good gifts, which the sixth overrides with a restriction. Gervaise of Tilbury, writing early in the 13th century, has in his *Olia Imperialia* a chapter, *De lamiis et nocturnis larvis*, where he gives it out, as proved by individuals beyond all exception, that men have been lovers of beings of this kind whom they call *Fadas*, and who did in case of infidelity or infringement of secrecy inflict terrible punishment—the loss of goods and even of life. There seems little in the characteristics of these fairies of romance to distinguish them from human beings, except their supernatural knowledge and power. They are not often represented as diminutive in stature, and seem to be subject to such human passions as love, jealousy, envy and revenge. To this class belong the fairies of Boiardo, Ariosto and Spenser.

There is no good modern book on the fairy belief in general. Keightley's *Fairy Mythology* is full of interesting matter; Rhys's *Celtic Mythology* is especially copious about Welsh fairies, which are practically identical with those of Ireland and Scotland. The works of Mr Jeremiah Curtin and Dr Douglas Hyde are useful for Ireland; for Scotland, Kirk's *Secret Commonwealth* has already been quoted. Scott's dissertation on fairies in *The Border Minstrelsy* is rich in lore, though necessarily Scott had not the wide field of comparative study opened by more recent researches. There is a full description of French fairies of the 15th century in the evidence of Jeanne d'Arc at her trial (1431) in Quicherat's *Procès de Jeanne d'Arc*, vol. i. pp. 67, 68, 187, 209, 212, vol. ii. pp. 390, 404, 450. (A. L.)

FAIRY RING, the popular name for the circular patches of a dark green colour that are to be seen occasionally on permanent grass-land, either lawn or meadow, on which the fairies were supposed to hold their midnight revels. They mark the area of growth of some fungus, starting from a centre of one or more plants. The mycelium produced from the spores dropped by the fungus or from the "spawn" in the soil, radiates outwards, and each year's successive crop of fungi rises from the new growth round the circle. The rich colour of the grass is due to the fertilizing quality of the decaying fungi, which are peculiarly rich in nitrogenous substances. The most complete and symmetrical grass rings are formed by *Marasmius orcadus*,

the fairy ring champignon, but the mushroom and many other species occasionally form rings, both on grass-lands and in woods. Observations were made on a ring in a pine-wood for a period of nine years, and it was calculated that it increased from centre to circumference about 8½ in. each year. The fungus was never found growing within the circle during the time the ring was under observation, the decaying vegetation necessary for its growth having become exhausted.

FAITHFULL, EMILY (1835-1895), English philanthropist, was the youngest daughter of the Rev. Ferdinand Faithfull, and was born at Headley Rectory, Surrey, in 1835. She took a great interest in the conditions of working-women, and with the object of extending their sphere of labour, which was then painfully limited, in 1860 she set up in London a printing establishment for women. The "Victoria Press," as it was called, soon obtained quite a reputation for its excellent work, and Miss Faithfull was shortly afterwards appointed printer and publisher in ordinary to Queen Victoria. In 1863 she began the publication of a monthly organ, *The Victoria Magazine*, in which for eighteen years she continuously and earnestly advocated the claims of women to remunerative employment. In 1868 she published a novel, *Change upon Change*. She also appeared as a lecturer, and with the object of furthering the interests of her sex, lectured widely and successfully both in England and the United States, which latter she visited in 1872 and 1882. In 1888 she was awarded a civil list pension of £50. She died in Manchester on the 31st of May 1895.

FAITH HEALING, a form of "mind cure," characterized by the doctrine that while pain and disease really exist, they may be neutralized and dispelled by faith in Divine power; the doctrine known as Christian Science (*q.v.*) holds, however, that pain is only an illusion and seeks to cure the patient by instilling into him this belief. In the Christian Church the tradition of faith healing dates from the earliest days of Christianity; upon the miracles of the New Testament follow cases of healing, first by the Apostles, then by their successors; but faith healing proper is gradually, from the 3rd century onwards, transformed into trust in relics, though faith cures still occur sporadically in later times. Catherine of Siena is said to have saved Father Matthew from dying of the plague, but in this case it is rather the healer than the healed who was strong in faith. With the Reformation faith healing proper reappears among the Moravians and Waldenses, who, like the Peculiar People of our own day, put their trust in prayer and anointing with oil. In the 16th century we find faith cures recorded of Luther and other reformers, in the next century of the Baptists, Quakers and other Puritan sects, and in the 18th century the faith healing of the Methodists in this country was paralleled by Pietism in Germany, which drew into its ranks so distinguished a man of science as Stahl (1660-1734). In the 19th century Prince Hohenlohe-Waldenburg-Schillingsfürst, canon of Grosswardein, was a famous healer on the continent; the Mormons and Irvingites were prominent among English-speaking peoples; in the last quarter of the 19th century faith healing became popular in London, and Bethshan homes were opened in 1881, and since then it has found many adherents in England.

Under faith healing in a wider sense may be included (1) the cures in the temples of Aesculapius and other deities in the ancient world; (2) the practice of touching for the king's evil, in vogue from the 11th to the 18th century; (3) the cures of Valentine Greatrakes, the "Stroker" (1629-1683); and (4) the miracles of Lourdes, and other resorts of pilgrims, among which may be mentioned St Winifred's Well in Flintshire, Treves with its Holy Coat, the grave of the Jansenist F. de Paris in the 18th century, the little town of Kevelaer from 1641 onwards, the tombs of St Louis, Francis of Assisi, Catherine of Siena and others.

An animistic theory of disease was held by Pastor J. Ch. Blumhardt, Dorothea Trudel, Boltzius and other European faith healers. Used in this sense faith healing is indistinguishable from much of savage leech-craft, which seeks to cure disease by expelling the evil spirit in some portion of the body. Although

it is usually present, faith in the medicine man is not essential for the efficacy of the method. The same may be said of the lineal descendant of savage medicine—the magical leech-craft of European folk-lore; cures for toothache, warts, &c., act in spite of the disbelief of the sufferer; how far incredulity on the part of the healer would result in failure is an open question.

From the psychological point of view all these different kinds of faith healing, as indeed all kinds of mind cure, including those of Christian Science and hypnotism, depend on suggestion (*q.v.*). In faith healing proper not only are powerful direct suggestions used, but the religious atmosphere and the auto-suggestions of the patient co-operate, especially where the cures take place during a period of religious revival or at other times when large assemblies and strong emotions are found. The suggestibility of large crowds is markedly greater than that of individuals, and to this and the greater faith must be attributed the greater success of the fashionable places of pilgrimage.

See A. T. Myers and F. W. H. Myers in *Proc. Soc. Psychical Research*, ix. 160-209, on the miracles of Lourdes, with bibliography; A. Feilding, *Faith Healing and Christian Science*; O. Stoll, *Suggestion und Hypnotismus in der Völkerpsychologie*; article "Great-takes" in *Dict. Nat. Biog.* (N. W. T.)

FAITHORNE, WILLIAM (1626 or 1627-1691), English painter and engraver, was born in London and was apprenticed to Robert Peake, a painter and printseller, who received the honour of knighthood from Charles I. On the outbreak of the Civil War he accompanied his master into the king's service, and being made prisoner at Basinghouse, he was confined for some time to Aldersgate, where, however, he was permitted to follow his profession of engraver, and among other portraits did a small one of the first Villiers, duke of Buckingham. At the earnest solicitation of his friends he very soon regained his liberty, but only on condition of retiring to France. There he was so fortunate as to receive instruction from Robert Nanteuil. He was permitted to return to England about 1650, and took up a shop near Temple Bar, where, besides his work as an engraver, he carried on a large business as a printseller. In 1680 he gave up his shop and retired to a house in Blackfriars, occupying himself chiefly in painting portraits from the life in crayons, although still occasionally engaged in engraving. It is said that his life was shortened by the misfortunes, dissipation, and early death of his son William. Faithorne is especially famous as a portrait engraver, and among those on whom he exercised his art were a large number of eminent persons, including Sir Henry Spelman, Oliver Cromwell, Henry Somerset, the marquis of Worcester, John Milton, Queen Catherine, Prince Rupert, Cardinal Richelieu, Sir Thomas Fairfax, Thomas Hobbes, Richard Hooker, Robert second earl of Essex, and Charles I. All his works are remarkable for their combination of freedom and strength with softness and delicacy, and his crayon paintings unite to these the additional quality of clear and brilliant colouring. He is the author of a work on engraving (1622).

His son **WILLIAM** (1656-1686), mezzotint engraver, at an early age gave promise of attaining great excellence, but became idle and dissipated, and involved his father in money difficulties. Among persons of note whose portraits he engraved are Charles II., Mary princess of Orange, Queen Anne when princess of Denmark, and Charles XII. of Sweden.

The best account of the Faithornes is that contained in Walpole's *Anecdotes of Painting*. A life of Faithorne the elder is preserved in the British Museum among the papers of Mr Bayford, librarian to Lord Oxford, and an intimate friend of Faithorne.

FAIZABAD, a town of Afghanistan, capital of the province of Badakshan, situated on the Kokcha river. In 1821 it was destroyed by Murad Beg of Kunduz, and the inhabitants removed to Kunduz. But since Badakshan was annexed by Abdur Rahman, the town has recovered its former importance, and is now a considerable place of trade. It is the chief cantonment for eastern Afghanistan and the Pamir region, and is protected by a fort built in 1904.

FAJARDO, a district and town on the E. coast of Porto Rico, belonging to the department of Humacao. Pop. (1899) of the district, 16,782; and of the town, 3,414. The district is highly

fertile and is well watered, owing in great measure to its abundant rainfall. Sugar production is its principal industry, but some attention is also given to the growing of oranges and pineapples. The town, which was founded in 1774, is a busy commercial centre standing 1½ m. from a large and well-sheltered bay, at the entrance to which is the cape called Cabeza de San Juan. It is the market town for a number of small islands off the E. coast, some of which produce cattle for export.

FAKHR UD-DĪN RĀZĪ (1149-1209), Arabian historian and theologian, was the son of a preacher, himself a writer, and was born at Rai (Rei, Rhagae), near Tehran, where he received his earliest training. Here and at Marāgha, whither he followed his teacher Majd ud-Dīn ul-Jili, he studied philosophy and theology. He was a Shafi'ite in law and a follower of Ash'ari (*q.v.*) in theology, and became renowned as a defender of orthodoxy. During a journey in Khwarizm and Mawara'l-nahr he preached both in Persian and Arabic against the sects of Islam. After this tour he returned to his native city, but settled later in Herat, where he died. His dogmatic positions may be seen from his work *Kitāb ul-Muḥassal*, which is analysed by Schmolders in his *Essai sur les écoles philosophiques chez les Arabes* (Paris, 1842). Extracts from his *History of the Dynasties* were published by Jourdain in the *Fundgruben des Orients* (vol. v.), and by D. R. Heinzius (St Petersburg, 1828). His greatest work is the *Mafāḥiḥ ul-Ghaḥib* ("The Keys of Mystery"), an extensive commentary on the Koran published at Cairo (8 vols., 1890) and elsewhere; it is specially full in its exposition of Ash'arite theology and its use of early and late Mu'tazilite writings.

For an account of his life see F. Wüstenfeld's *Geschichte der arabischen Ärzte*, No. 200 (Göttingen, 1840); for a list of his works cf. C. Brockelmann's *Gesch. der arabischen Literatur*, vol. I (Weimar, 1898), pp. 506 ff. An account of his teaching is given by M. Schreiner in the *Zeitschrift der deutschen morgenländischen Gesellschaft* (vol. 52, pp. 505 ff.). (G. W. T.)

FAKIR (from Arabic *faqīr*, "poor"), a term equivalent to *Dervish* (*q.v.*) or Mahomedan religious mendicant, but which has come to be specially applied to the Hindu devotees and ascetics of India. There are two classes of these Indian Fakirs, (1) the religious orders, and (2) the nomad rogues who infest the country. The ascetic orders resemble the Franciscans of Christianity. The bulk lead really excellent lives in monasteries, which are centres of education and poor-relief; while others go out to visit the poor as Gurus or teachers. Strict celibacy is not enforced among them. These orders are of very ancient date, owing their establishment to the ancient Hindu rule, followed by the Buddhists, that each "twice-born" man should lead in the woods the life of an ascetic. The second class of Fakirs are simply disreputable beggars who wander round extorting, under the guise of religion, alms from the charitable and practising on the superstitions of the villagers. As a rule they make no real pretence of leading a religious life. They are said to number nearly a million. Many of them are known as "Jogi," and lay claim to miraculous powers which they declare have become theirs by the practice of abstinence and extreme austerities. The tortures which some of these wretches will inflict upon themselves are almost incredible. They will hold their arms over their heads until the muscles atrophy, will keep their fists clenched till the nails grow through the palms, will lie on beds of nails, cut and stab themselves, drag, week after week, enormous chains loaded with masses of iron, or hang themselves before a fire near enough to scorch. Most of them are inexpressibly filthy and verminous. Among the filthiest are the Aghoris, who preserve the ancient cannibal ritual of the followers of Siva, eat filth, and use a human skull as a drinking-vessel. Formerly the fakirs were always nude and smeared with ashes; but now they are compelled to wear some pretence of clothing. The natives do not really respect these wandering friars, but they dread their curses.

See John Campbell Oman, *The Mystics, Ascetics and Saints of India* (1903), and Indian Census Reports.

FALAISE, a town of north-western France, capital of an arrondissement in the department of Calvados, on the right bank of the Ante, 19 m. S. by E. of Caen by road. Pop. (1906)

6215. The principal object of interest is the castle, now partly in ruins, but formerly the seat of the dukes of Normandy and the birthplace of William the Conqueror. It is situated on a lofty crag overlooking the town, and consists of a square mass defended by towers and flanked by a small donjon and a lofty tower added by the English in the 15th century; the rest of the castle dates chiefly from the 12th century. Near the castle, in the Place de la Trinité, is an equestrian statue in bronze of William the Conqueror, to whom the town owed its prosperity. The churches of La Trinité and St Gervais combine the Gothic and Renaissance styles of architecture, and St Gervais also includes Romanesque workmanship. A street passes by way of a tunnel beneath the choir of La Trinité. Falaise has populous suburbs, one of which, Guibray, is celebrated for its annual fair for horses, cattle and wool, which has been held in August since the 11th century. The town is the seat of a subprefecture and has tribunals of first instance and commerce, a chamber of arts and manufacture, a board of trade-arbitrators and a communal college. Tanning and important manufactures of hosiery are carried on.

From 1417, when after a siege of forty-seven days it succumbed to Henry V., king of England, till 1450, when it was retaken by the French, Falaise was in the hands of the English.

FALASHAS (*i.e.* exiles; Ethiopic *falas*, a stranger), or "Jews of Abyssinia," a tribe of Hamitic stock, akin to Galla, Somali and Beja, though they profess the Jewish religion. They claim to be descended from the ten tribes banished from the Holy Land. Another tradition assigns them as ancestor Menelek, Solomon's alleged son by the queen of Sheba. There is little or no physical difference between them and the typical Abyssinians, except perhaps that their eyes are a little more oblique; and they may certainly be regarded as Hamitic. It is uncertain when they became Jews: one account suggests in Solomon's time; another, at the Babylonian captivity; a third, during the 1st century of the Christian era. That one of the earlier dates is correct seems probable from the fact that the Falashas know nothing of either the Babylonian or Jerusalem Talmud, make no use of phylacteries (*tefillin*), and observe neither the feast of Purim nor the dedication of the temple. They possess—not in Hebrew, of which they are altogether ignorant, but in Ethiopic (or Geez)—the canonical and apocryphal books of the Old Testament; a volume of extracts from the Pentateuch, with comments given to Moses by God on Mount Sinai; the *Te-e-sa-sa Sanbat*, or laws of the Sabbath; the *Ardit*, a book of secrets revealed to twelve saints, which is used as a charm against disease; lives of Abraham, Moses, &c.; and a translation of Josephus called *Sana Aihud*. A copy of the Orit or Mosaic law is kept in the holy of holies in every synagogue. Various pagan observances are mingled in their ritual: every newly-built house is considered uninhabitable till the blood of a sheep or fowl has been spilt in it; a woman guilty of a breach of chastity has to undergo purification by leaping into a flaming fire; the Sabbath has been deified, and, as the goddess *Sanbat*, receives adoration and sacrifice and is said to have ten thousand times ten thousand angels to wait on her commands. There is a monastic system, introduced it is said in the 4th century A.D. by *Aba Zebra*, a pious man who retired from the world and lived in the cave of *Hoharewa*, in the province of *Armatshoho*. The monks must prepare all their food with their own hands, and no lay person, male or female, may enter their houses. Celibacy is not practised by the priests, but they are not allowed to marry a second time, and no one is admitted into the order who has eaten bread with a Christian, or is the son or grandson of a man thus contaminated. Belief in the evil eye or shadow is universal, and spirit-raisers, soothsayers and rain-doctors are in repute. Education is in the hands of the monks and priests, and is confined to boys. Fasts, obligatory on all above seven years of age, are held on every Monday and Thursday, on every new moon, and at the passover (the 21st or 22nd of April). The annual festivals are the passover, the harvest feast, the *Baala Mazalat* or feast of tabernacles (during which, however, no booths are built), the day of covenant or assembly and Abraham's day. It is believed that after death the soul remains in a place of darkness till the third day, when the

first sacrifice for the dead is offered; prayers are read in the synagogue for the repose of the departed, and for seven days a formal lament takes place every morning in his house. No coffins are used, and a stone vault is built over the corpse so that it may not come into direct contact with the earth.

The Falashas are an industrious people, living for the most part in villages of their own, or, if they settle in a Christian or Mahomedan town, occupying a separate quarter. They had their own kings, who, they pretend, were descended from David, from the 10th century until 1800, when the royal race became extinct, and they then became subject to the Abyssinian kingdom of Tigré. They do not mix with the Abyssinians, and never marry women of alien religions. They are even forbidden to enter the houses of Christians, and from such a pollution have to be purified before entering their own houses. Polygamy is not practised; early marriages are rare, and their morals are generally better than those of their Christian masters. Unlike most Jews, they have no liking for trade, but are skilled in agriculture, in the manufacture of pottery, ironware and cloth, and are good masons. Their numbers are variously estimated at from one hundred to one hundred and fifty thousand.

BIBLIOGRAPHY.—M. Flad, *Zwölf Jahre in Abyssinien* (Basel, 1869), and his *Falashas of Abyssinia*, translated from the German by S. P. Goodhart (London, 1869); H. A. Stern, *Wanderings among the Falashas in Abyssinia* (London, 1862); Joseph Halévy, *Travels in Abyssinia* (trans. London, 1878); Morais, "The Falashas" in *Penn Monthly* (Philadelphia, 1880); Cyrus Adler, "Bibliography of the Falashas" in *American Hebrew* (16th of March 1894); Lewin, "Ein verlassener Bruderstamm," in *Bloch's Wochenschrift* (7th February 1902), p. 85; J. Faitlovitch, *Notes d'un voyage chez les Falachas* (Paris, 1905).

FALCÃO, CHRISTOVÃO DE SOUSA (? 1512–1557), Portuguese poet, came of a noble family settled at Portalegre in the Alemtejo, which had originated with John Falcon or Falconet, one of the Englishmen who went to Portugal in 1386 in the suite of Philippa of Lancaster. His father, João Vaz de Almada Falcão, was an upright public servant who had held the captaincy of Elmina on the West African coast, but died, as he had lived, a poor man. There is a tradition that in boyhood Christovão fell in love with a beautiful child and rich heiress, D. Maria Brandão, and in 1526 married her clandestinely, but parental opposition prevented the ratification of the marriage. Family pride, it is said, drove the father of Christovão to keep his son under strict surveillance in his own house for five years, while the lady's parents, objecting to the youth's small means, put her into the Cistercian convent of Lorvão, and there endeavoured to wean her heart from him by the accusation that he coveted her fortune more than her person. Their arguments and the promise of a good match ultimately prevailed, and in 1534 D. Maria left the convent to marry D. Luis de Silva, captain of Tangier, while the broken-hearted Christovão told his sad story in some beautiful lyrics and particularly in the eclogue *Chrisfal*. He had been the disciple and friend of the poets Bernardim Ribeiro and Sá de Miranda, and when his great disappointment came, Falcão laid aside poetry and entered on a diplomatic career. There is documentary evidence that he was employed at the Portuguese embassy in Rome in 1542, but he soon returned to Portugal, and we find him at court again in 1548 and 1551. The date of his death, as of his birth, is uncertain. Such is the story accepted by Dr Theophilo Braga, the historian of Portuguese literature, but Senhor Guimarães shows that the first part is doubtful, and, putting aside the testimony of a contemporary and grave writer, Diogo do Couto, he even denies the title of poet to Christovão Falcão, arguing from internal and other evidence that *Chrisfal* is the work of Bernardim Ribeiro; his destructive criticism is, however, stronger than his constructive work. The eclogue, with its 104 verses, is the very poem of *saudade*, and its simple, direct language and chaste and tender feeling, enshrined in exquisitely sounding verses, has won for its author lasting fame and a unique position in Portuguese literature. Its influence on later poets has been very considerable, and Camoens used several of the verses as proverbs.

The poetical works of Christovão Falcão were published anonymously, owing, it is supposed, to their personal nature and allusions,

and, in part or in whole, they have been often reprinted. There is a modern critical edition of *Chrisfal* and a *Carta* (letter) by A. Epiphonio da Silva Dias under the title *Obras de Christovão Falcão* (Oporto, 1893), and one of the *Cantigas* and *Esparsas* by the same scholar appeared in the *Revista Lusitana*, vol. 4, pp. 142-179 (Lisbon, 1896), under the name *Fragmento de um Cancioneiro do Seculo XVI*. See *Bernardim Ribeiro e o Bucolismo*, by Dr T. Braga (Oporto, 1897), and *Bernardim Ribeiro (O Poeta Crisfal)*, by Delfim Guimarães (Lisbon, 1908).

FALCK, ANTON REINHARD (1777-1843), Dutch statesman, was born at Utrecht on the 19th of March 1777. He studied at the university of Leiden, and entered the Dutch diplomatic service, being appointed to the legation at Madrid. Under King Louis Napoleon he was secretary-general for foreign affairs, but resigned office on the annexation of the Batavian republic to France. He took a leading part in the revolt of 1813 against French domination, and had a considerable share in the organization of the new kingdom of the Netherlands. As minister of education under William I. he reorganized the universities of Ghent, Louvain and Liège and the Royal Academy of Brussels. Side by side with his activities in education he directed the departments of trade and the colonies. Falck was called in Holland the king's good genius, but William I. presently tired of his counsels and he was superseded by Van Maanen. He was ambassador in London when the disturbances of 1830 convinced him of the necessity of the separation of Belgium from Holland. He consequently resigned his post and lived in close retirement until 1839, when he became the first Dutch minister at the Belgian court. He died at Brussels on the 16th of March 1843. Besides some historical works he left a correspondence of considerable political interest, printed in *Brieven van A. R. Falck, 1795-1843* (2nd ed. The Hague, 1861), and *Ambtsbrieven van A. R. Falck* (*ibid.* 1878).

FALCÓN, the most northern state of Venezuela, with an extensive coast line on the Caribbean Sea and Gulf of Venezuela. Pop. (1905 est.) 173,968. It lies between the Caribbean on the N. and the state of Lara on the S., with Zulia and the Gulf of Venezuela on the W. Its surface is much broken by irregular ranges of low mountains, and extensive areas on the coast are sandy plains and tropical swamps. The climate is hot, but, being tempered by the trade winds, is not considered unhealthy except in the swampy districts. The state is sparsely settled and has no large towns, its capital, Coro, being important chiefly because of its history, and as the entrepôt for an extensive inland district. The only port in the state is La Vela de Coro, on a small bay of the same name, 7 m. E. of the capital, with which it is connected by railway.

FALCON (Lat. *Falco*;¹ Fr. *Faucon*; Teutonic, *Falk* or *Valken*), a word now restricted to the high-couraged and long-winged birds of prey which take their quarry as it moves; but formerly it had a very different meaning, being by the naturalists of the 18th and even of the 19th century extended to a great number of birds comprised in the genus *Falco* of Linnaeus and writers of his day,² while, on the other hand, by falconers, it was, and still is, technically limited to the *female* of the birds employed by them in their vocation (see **FALCONRY**), whether "long-winged" and therefore "noble," or "short-winged" and "ignoble."

According to modern usage, the majority of the falcons, in the sense first given, may be separated into *five* very distinct groups: (1) the falcons pure and simple (*Falco* proper); (2) the large northern falcons (*Hierofalco*, Cuvier); (3) the "desert falcons" (*Gennaeva*, Kaup); (4) the merlins (*Aesalon*, Kaup); and (5) the hobbies (*Hypotriorchis*, Boie). A sixth group, the kestrels

¹ Unknown to classical writers, the earliest use of this word is said to be by Servius Honoratus (*circa* A. D. 390-480) in his notes on *Aen.* x. 145. It seems possibly to be the Latinized form of the Teutonic *Falk*, though *falx* is commonly accounted its root.

The nomenclature of nearly all the older writers on this point is extremely confused. What many of them, even so lately as Pennant's time, termed the "gentle falcon" is certainly the bird we now call the goshawk (*i.e.* goose-hawk), which name itself may have been transferred to the *Astur palumbarius* of modern ornithologists, from one of the long-winged birds of prey.

(*Tinnunculus*, Vieillot), is often added. This, however, appears to have been justifiably reckoned a distinct genus.

The typical falcon is by common consent allowed to be that almost cosmopolitan species to which unfortunately the English epithet "peregrine" (*i.e.* strange or wandering) has been attached. It is the *Falco peregrinus* of Tunstall (1771) and of most recent ornithologists, though some prefer the specific name *communis* applied by J. F. Gmelin a few years later (1788) to a bird which, if his diagnosis be correct, could not have been a true falcon at all, since it had yellow irides—a colour never met with in the eyes of any bird now called by naturalists a "falcon." This species inhabits suitable localities throughout the greater part of the globe, though examples from North America have by some received specific recognition as *F. anatum* (the "duck-hawk"), and those from Australia have been described as distinct under the name of *F. melanogenys*. Here, as in so many other cases, it is almost impossible to decide as to which forms should, and which should not, be accounted merely local races. In size not surpassing a raven, this falcon (fig. 1) is perhaps the most powerful bird of prey for its bulk that flies, and its courage is not less than its power. It is the species, in Europe, most commonly



FIG. 1.—Peregrine Falcon.

trained for the sport of hawking (see **FALCONRY**). Volumes have been written upon it, and to attempt a complete account of it is, within the limits now available, impossible. The plumage of the adult is generally blackish-blue above, and white, with a more or less deep cream-coloured tinge, beneath—the lower parts, except the chin and throat, being barred transversely with black, while a black patch extends from the bill to the ear-coverts, and descends on either side beneath the mandible. The young have the upper parts deep blackish-brown, and the lower white, more or less strongly tinged with ochraceous-brown, and striped longitudinally with blackish-brown. From Port Kennedy, the most northern part of the American continent, to Tasmania, and from the shores of the Sea of Okhotsk to Mendoza in the Argentine territory, there is scarcely a country in which this falcon has not been found. Specimens have been received from the Cape of Good Hope, and it is only a question of the technical differentiation of species whether it does not extend to Cape Horn. Fearless as it is, and adapting itself to almost every circumstance, it will form its eyry equally on the sea-washed cliffs, the craggy mountains, or (though more rarely) the drier spots of a marsh in the northern hemisphere, as on trees (says H. Schlegel) in the forests of Java or the waterless ravines of Australia. In the United Kingdom it was formerly very common, and hardly a high rock from the Shetlands to the Isle of Wight

but had a pair as its tenants. But the British gamekeeper has long held the mistaken faith that it is his worst foe, and the number of pairs now allowed to rear their brood unmolested in the British Islands is very small. Yet its utility to the gamepreserver, by destroying every one of his most precious wards that shows any sign of infirmity, can hardly be questioned by reason, and G. E. Freeman (*Falconry*) has earnestly urged its claims to protection.¹ Nearly allied to this falcon are several species, such as *F. barbarus* of Mauretania, *F. minor* of South Africa, the Asiatic *F. babylonicus*, *F. peregrinator* of India (the shaheen), and perhaps *F. cassini* of South America, with some others.

Next to the typical falcons comes a group known as the "great northern" falcons (*Hierofalco*). Of these the most remarkable is the gyrfalcon (*F. gyrfalco*), whose home is in the Scandinavian mountains, though the young are yearly visitants to the plains of Holland and Germany. In plumage it very much resembles *F. peregrinus*, but its flanks have generally a bluer tinge, and its superiority in size is at once manifest. Nearly allied to it is the Icelander (*F. islandus*), which externally differs in its paler colouring and in almost entirely wanting the black mandibular patch. Its proportions, however, differ a good deal, its body being elongated. Its country is shown by its name, but it also inhabits south Greenland, and not unfrequently makes its way to the British Islands. Very close to this comes the Greenland falcon (*F. candicans*), a native of north Greenland, and perhaps of other countries within the Arctic Circle. Like the last, the Greenland falcon from time to time occurs in the United Kingdom, but it is always to be distinguished by wearing a plumage in which at every age the prevailing colour is pure white. In north-eastern America these birds are replaced by a kindred form (*F. labradorus*), first detected by Audubon and subsequently recognized by Dresser (*Orn. Miscell.* i. 135). It is at once distinguished by its very dark colouring, the lower parts being occasionally almost as deeply tinted at all ages as the upper.

All the birds hitherto named possess one character in common. The darker markings of their plumage are longitudinal before the first real moult takes place, and for ever afterwards are transverse. In other words, when young the markings are in the form of stripes, when old in the form of bars. The variation of tint is very great, especially in *F. peregrinus*; but the experience of falconers, whose business it is to keep their birds in the very highest condition, shows that a falcon of either of these groups if light-coloured in youth is light-coloured when adult, and if dark when young is also dark when old—age, after the first moult, making no difference in the complexion of the bird. The next group is that of the so-called "desert falcons" (*Gemmae*), wherein the difference just indicated does not obtain, for long as the bird may live and often as it may moult, the original style of markings never gives way to any other. Foremost among these are to be considered the lanner and the saker (commonly termed *F. lanarius* and *F. sacer*), both well known in the palmy days of falconry, but only since about 1845 readmitted to full recognition. Both of these birds belong properly to south-eastern Europe, North Africa and south-western Asia. They are, for their bulk, less powerful than the members of the preceding group, and though they may be trained to high flights are naturally captors of humbler game. The precise number of species is very doubtful, but among the many candidates for recognition are especially to be named the lugger (*F. jugger*) of India, and the prairie falcon (*F. mexicanus*) of the western plains of North America.

The systematist finds it hard to decide in what group he should place two somewhat large Australian species (*F. hypoleucus*

¹ It is not to be inferred, as many writers have done, that falcons habitually prey upon birds in which disease has made any serious progress. Such birds meet their fate from the less noble *Accipitres* or predatory animals of many kinds. But when a bird is first affected by any disorder, its power of taking care of itself is at once impaired, and hence in the majority of cases it may become an easy victim under circumstances which would enable a perfectly sound bird to escape from the attack even of a falcon.

and *F. subniger*), both of which are rare in collections—the latter especially.

A small but very beautiful group comes next—the merlins² (*Aesalon* of some writers, *Lithofalco* of others). The European merlin (*F. aesalon*) is perhaps the boldest of the *Accipitres*, not hesitating to attack birds of twice its own size, and even on

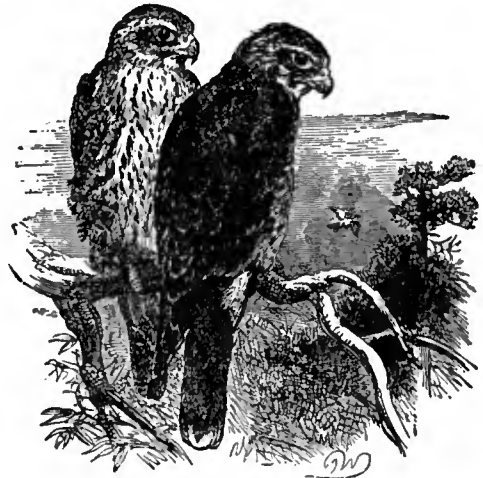

FIG. 2.—Merlin.

occasion threatening human beings. Yet it readily becomes tame, if not affectionate, when reclaimed, and its ordinary prey consists of the smaller *Passeres*. Its "pinion of glossy blue" has become almost proverbial, and a deep ruddy blush suffuses its lower parts; but these are characteristic only of the male—the female maintaining very nearly the sober brown plumage she wore when as a nestling she left her lowly cradle in the heather. Very close to this bird comes the pigeon-hawk (*F. columbarius*) of North America—so close, indeed, that none but an expert ornithologist can detect the difference. The turumti of Anglo-Indians (*F. chicquera*), and its representative from southern Africa (*F. ruficollis*), also belong to this group, but they are considerably larger than either of the former.

Lastly, the Hobbies (*Hypotriorchis*) comprise a greater number of forms—though how many seems to be doubtful.



FIG. 3.—Hobby.

They are in life at once recognizable by their bold upstanding position, and at any time by their long wings. The type of this group is the English hobby (*F. subbuteo*), a bird of great power of flight, chiefly shown in the capture of insects, which form its

² French, *Émerillon*; Icelandic, *Smirill*.

ordinary food. It is a summer visitant to most parts of Europe, including the British Islands, and is most wantonly and needlessly destroyed by gamekeepers. A second European species of the group is the beautiful *F. eleonora*, which hardly comes farther north than the countries bordering the Mediterranean, and, though in some places abundant, is an extremely local bird. The largest species of this section seems to be the Neotropical *F. femoralis*, for *F. diroleucus* though often ranked here, is now supposed to belong to the group of typical falcons. (A. N.)

FALCONE, ANIELLO (1600–1665), Italian battle-painter, was the son of a tradesman, and was born in Naples. He showed his artistic tendency at an early age, received some instruction from a relative, and then studied under Ribera (Lo Spagnoletto), of whom he ranks as the most eminent pupil. Besides battle-pictures, large and small, taken from biblical as well as secular history, he painted various religious subjects, which, however, count for little in his general reputation. He became, as a battle-painter, almost as celebrated as Borgognone (Courtois), and was named "L'Oracolo delle Battaglie." His works have animation, variety, truth to nature, and careful colour. Falcone was bold, generous, used to arms, and an excellent fencer. In the insurrection of Masaniello (1647) he resolved to be bloodily avenged for the death, at the hands of two Spaniards, of a nephew and of a pupil in the school of art which he had established in Naples. He and many of his scholars, including Salvator Rosa and Carlo Coppola, formed an armed band named the *Compagnia della Morte* ("Company of Death"; see ROSA, SALVATOR). They scoured the streets by day, exulting in slaughter; at night they were painters again, and handled the brush with impetuous zeal. Peace being restored, they had to decamp. Falcone and Rosa made off to Rome; here Borgognone noticed the works of Falcone, and became his friend, and a French gentleman induced him to go to France, where Louis XIV. became one of his patrons. Ultimately Colbert obtained permission for the painter to return to Naples, and there he died in 1665. Two of his battle-pieces are to be seen in the Louvre and in the Naples museum; he painted a portrait of Masaniello, and engraved a few plates. Among his principal scholars, besides Rosa and Coppola (whose works are sometimes ascribed to Falcone himself), were Domenico Gargiuolo (named Micco Spadaro), Paolo Porpora and Andrea di Lione.

FALCONER, HUGH (1808–1865), British palaeontologist and botanist, descended from an old Scottish family, was born at Forres on the 29th of February 1808. In 1826 he graduated at Aberdeen, where he manifested a taste for the study of natural history. He afterwards studied medicine in the university of Edinburgh, taking the degree of M.D. in 1829; during this period he zealously attended the botanical classes of Prof. R. Graham (1786–1845), and those on geology by Prof. R. Jameson. Proceeding to India in 1830 as assistant-surgeon on the Bengal establishment of the East India Company, he made on his arrival an examination of the fossil bones from Ava in the possession of the Asiatic Society of Bengal, and his description of the collection, published soon afterwards, gave him a recognized position among the scientists of India. Early in 1831 he was appointed to the army station at Meerut, in the North-Western Provinces, but in the same year he was asked to officiate as superintendent of the botanic garden of Saharanpur, during the ill-health and absence of Dr J. F. Royle; and in 1832 he succeeded to this post. He was thus placed in a district that proved to be rich in palaeontological remains; and he set to work to investigate its natural history and geology. In 1834 he published a geological description of the Siwalik hills, in the Tertiary strata of which he had in 1831 discovered bones of crocodiles, tortoises and other animals; and subsequently, with conjoint labourers, he brought to light a sub-tropical fossil fauna of unexampled extent and richness, including remains of *Mastodon*, the colossal ruminant *Sivatherium*, and the enormous tortoise *Colossochelys Atlas*. For these valuable discoveries he and Captain (afterwards Sir Proby T.) Cautley (1802–1871) received in 1837 the Wollaston medal in duplicate from the Geological Society of London. In 1834 Falconer was appointed

to inquire into the fitness of India for the growth of the tea-plant, and it was on his recommendation that it was introduced into that country.

He was compelled by illness to leave India in 1842, and during his stay in England he occupied himself with the classification and arrangement of the Indian fossils presented to the British Museum and East India House, chiefly by himself and Sir Proby T. Cautley. He then set to work to edit the great memoir by Cautley and himself, entitled *Fauna Antiqua Sivalensis*, of which Part I. text was issued in 1846, and a series of 107 plates during the years 1846–1849. Unfortunately the work, owing partly to Dr Falconer's absence from England and partly to ill-health, was never completed. He was elected F.R.S. in 1845. In 1847 he was appointed superintendent of the Calcutta botanical garden, and professor of botany in the medical college; and on entering on his duties in the following year he was at once employed by the Indian government and the Agricultural and Horticultural Society as their adviser on all matters connected with the vegetable products of India. He prepared an important report on the teak forests of Tenasserim, and this was the means of saving them from destruction by reckless felling; and through his recommendation the cultivation of the cinchona bark was introduced into the Indian empire. Being compelled by the state of his health to leave India in 1855, he spent the remainder of his life chiefly in examining fossil species in England and the Continent corresponding to those which he had discovered in India, notably the species of mastodon, elephant and rhinoceros; he also described some new mammalia from the Purbeck strata, and he reported on the bone-caves of Sicily, Gibraltar, Gower and Brixham. In the course of his researches he became interested in the question of the antiquity of the human race, and actually commenced a work on "Primeval Man," which, however, he did not live to finish. He died on the 31st of January 1865. Shortly after his death a committee was formed for the promotion of a "Falconer Memorial." This took the shape of a marble bust, which was placed in the rooms of the Royal Society of London, and of a Falconer scholarship of the annual value of £100, open for competition to graduates in science or medicine of the university of Edinburgh.

Dr Falconer's botanical notes, with 450 coloured drawings of Kashmir and Indian plants, have been deposited in the library at Kew Gardens, and his *Palaeontological Memoirs and Notes*, comprising all his papers read before learned societies, have been edited, with a biographical sketch, by Charles Murchison, M.D. (London, 1868). Many reminiscences of Dr Falconer, and a portrait of him, were published by his niece, Grace, Lady Prestwich, in her *Essays descriptive and biographical* (1901).

FALCONER, WILLIAM (1732–1769), British poet, was born in Edinburgh on the 11th of February 1732. His father was a wig-maker, and carried on business in one of the small shops with wooden fronts at the Netherbow Port, an antique castellated structure which remained till 1764, dividing High Street from the Canongate. The old man became bankrupt, then tried business as a grocer, and finally died in extreme poverty. William, the son, having received a scanty education, was put to sea. He served on board a Leith merchant vessel, and in his eighteenth year obtained the appointment of second mate of the "Britannia," a vessel employed in the Levant trade, and sailed from Alexandria for Venice. The "Britannia" was overtaken by a dreadful storm off Cape Colonna and was wrecked, only three of the crew being saved. Falconer was happily one of the three, and the incidents of the voyage and its disastrous termination formed the subject of his poem of *The Shipwreck* (1762). Meanwhile, on his return to England, Falconer, in his nineteenth year, printed at Edinburgh an elegy on Frederick, prince of Wales, and afterwards contributed short pieces to the *Gentleman's Magazine*. Some of these descriptive and lyrical effusions possess merit. The fine naval song of "The Storm" ("Cease, rude Boreas"), reputed to be by George Alexander Stevens, the dramatic writer and lecturer, has been ascribed to Falconer, but apparently on no authority. The duke of York, to whom *The Shipwreck* had been dedicated, advised Falconer

to enter the royal navy, and before the end of 1762 the poet-sailor was rated as a midshipman on board the "Royal George." But as this ship was paid off at the peace of 1763, Falconer received an appointment as purser of the "Glory" frigate, a situation which he held until that vessel was laid up on ordinary at Chatham. In 1764 he published a new and enlarged edition of *The Shipwreck*, and in the same year a rhymed political tirade against John Wilkes and Charles Churchill, entitled *The Demagogue*. In 1769 appeared his *Universal Marine Dictionary*, in which *retreal* is defined as a French manoeuvre, "not properly a term of the British marine." While engaged on this dictionary, J. Murray, a bookseller in Fleet Street, father of Byron's munificent publisher and correspondent, wished him to join him as a partner in business. The poet declined the offer, and became purser of the "Aurora" frigate, which had been commissioned to carry out to India certain supervisors or superintendents of the East India Company. Besides his nomination as purser, Falconer was promised the post of private secretary to the commissioners. Before sailing he published a third edition of his *Shipwreck*, which had again undergone "correction," but not improvement. The poet sailed in the "Aurora" from Spithead on the 20th of September 1769. The vessel arrived safely at the Cape of Good Hope, and left on the 27th of December. She was never more heard of, having, as is supposed, foundered at sea. *The Shipwreck*, the poem with which Falconer's name is connected, had a great reputation at one time, but the fine passages which pleased the earlier critics have not saved it from general oblivion.

See his *Poetical Works* in the "Aldine Edition" (1836), with a life by J. Mitford.

FALCONET, ÉTIENNE MAURICE (1716-1791), French sculptor, was born in Paris. His parents were poor, and he was at first apprenticed to a carpenter, but some of his clay-figures, with the making of which he occupied his leisure hours, attracted the notice of the sculptor Lemoine, who made him his pupil. He found time to study Greek and Latin, and also wrote several *brochures* on art. His artistic productions are characterized by the same defects as his writings, for though manifesting considerable cleverness and some power of imagination, they display in many cases a false and fantastic taste, the result, most probably, of an excessive striving after originality. One of his most successful statues was one of Milo of Crotona, which secured his admission to the membership of the Academy of Fine Arts in 1754. At the invitation of the empress Catherine he went in 1766 to St Petersburg, where he executed a colossal statue of Peter the Great in bronze. In 1788 he became director of the French Academy of Painting. Many of Falconet's works, being placed in churches, were destroyed at the time of the French Revolution. His "*Nymph descendant au bain*" is in the Louvre.

Among his writings are *Réflexions sur la sculpture* (Paris, 1768), and *Observations sur la statue de Marc-Aurèle* (Paris, 1771). The whole were collected under the title of *Œuvres littéraires* (6 vols., Lausanne, 1781-1782; 3 vols., Paris, 1787).

FALCONRY (Fr. *fauconnerie*, from Late Lat. *falco*, falcon), the art of employing falcons and hawks in the chase, often termed *Hawking*. Falconry was for many ages one of the principal sports of the richer classes, and, since many more efficacious methods and appliances for the capture of game undoubtedly existed, it is probable that it has always been carried on as a pure sport. The antiquity of falconry is very great. There appears to be little doubt that it was practised in Asia at a very remote period, for which we have the concurrent testimony of various Chinese and Japanese works, some of the latter being most quaintly and yet spiritedly illustrated. It appears to have been known in China some 2000 years B.C., and the records of a king Wen Wang, who reigned over a province of that country 689 B.C., prove that the art was at that time in very high favour. In Japan it appears to have been known at least 600 years B.C., and probably at an equally early date in India, Arabia, Persia and Syria. Sir A. H. Layard, in his *Nineveh and Babylon*, considered that in a bas-relief found by him in the ruins of Khorsabad "there appeared to be a falconer bearing a hawk on his wrist," from which it would appear to have been known

there some 1700 years B.C. In all the above-mentioned countries of Asia it is practised at the present day.

Little is known of the early history of falconry in Africa, but from very ancient Egyptian carvings and drawings it seems to have been known there many ages ago. It was probably also in vogue in the countries of Morocco, Oran, Algiers, Tunis and Egypt, at the same time as in Europe. The older writers on falconry, English and continental, often mention Barbary and Tunisian falcons. It is still practised in Egypt.

Perhaps the oldest records of falconry in Europe are supplied by the writings of Pliny, Aristotle and Martial. Although their notices of the sport are slight and somewhat vague, yet they are quite sufficient to show clearly that it was practised in their days—between the years 384 B.C. and A.D. 40. It was probably introduced into England from the continent about A.D. 860, and from that time down to the middle of the 17th century falconry was followed with an ardour that perhaps no English sport has ever called forth, not even fox-hunting. Stringent laws and enactments, notably in the reigns of William the Conqueror, Edward III., Henry VIII. and Elizabeth, were passed from time to time in its interest. Falcons and hawks were allotted to degrees and orders of men according to rank and station—for instance, to the emperor the eagle and vulture, to royalty the jersfalcons, to an earl the peregrine, to a yeoman the goshawk, to a priest the sparrow-hawk, and to a knave or servant the useless kestrel. The writings of Shakespeare furnish ample testimony to the high and universal estimation in which it was held in his days. About the middle of the 17th century falconry began to decline in England, to revive somewhat at the Restoration. It never, however, completely recovered its former favour, a variety of causes operating against it, such as enclosure of waste lands, agricultural improvements, and the introduction of fire-arms into the sporting field, till it fell, as a national sport, almost into oblivion. Yet it has never been even temporarily extinct, and it is successfully practised even at the present day.

In Europe the game or "quarry" at which hawks are flown consists of grouse (confined to the British Isles), black-game, pheasants, partridges, quails, landrails, ducks, teal, woodcocks, snipes, herons, rooks, crows, gulls, magpies, jays, blackbirds, thrushes, larks, hares and rabbits. In former days geese, cranes, kites, ravens and bustards were also flown at. Old German works make much mention of the use of the Iceland falcon for taking the great bustard, a flight scarcely alluded to by English writers. In Asia the list of quarry is longer, and, in addition to all the foregoing, or their Asiatic representatives, various kinds of bustards, sand grouse, storks, ibises, spoonbills, pea-fowl, jungle-fowl, kites, vultures and gazelles are captured by trained hawks. In Mongolia and Chinese Tartary, and among the nomad tribes of central Asia, the sport still flourishes; and though some late accounts are not satisfactory either to the falconer or the naturalist, yet they leave no doubt that a species of eagle is still trained in those regions to take large game, as antelopes and wolves. Mr Atkinson, in his account of his travels in the country of the Amur, makes particular mention of the sport, as does also Mr Shaw in his work on Yarkand; and in a letter from the Yarkand embassy, under Mr Forsyth, C.B., dated Camp near Yarkand, Nov. 27, 1873, the following passage occurs:—"Hawking appears also to be a favourite amusement, the golden eagle taking the place of the falcon or hawk. This novel sport seemed very successful." It is questionable whether the bird here spoken of is the golden eagle. In Africa gazelles are taken, and also partridges and wildfowl.

The hawks used in England are the three great northern falcons, viz. the Greenland, Iceland and Norway falcons, the peregrine falcon, the hobby, the merlin, the goshawk and the sparrow-hawk. In former days the saker, the lanner and the Barbary or Tunisian falcon were also employed. (See FALCON.)

Of the foregoing the easiest to keep, most efficient in the field, and most suitable for general use are the peregrine falcon and the goshawk.

In all hawks, the female is larger and more powerful than the male.

Hawks are divided by falconers all over the world into two great classes. The first class comprises "falcons," *i.e.* "long-winged hawks," or "hawks of the lure," distinguished by Eastern falconers as "dark-eyed hawks." In these the wings are pointed, the second feather in the wing is the longest, and the iris is of a deep, dark-brown hue. Merlins must, however, be excepted; and here it would seem that the Eastern distinction is the better, for though merlins are much more falcons than they are hawks, they differ from falcons in having the third feather in the wing the longest, while they are certainly "dark-eyed hawks."

The second class is that of "hawks," *i.e.* "short-winged hawks," or "hawks of the fist," called by Eastern falconers "yellow (or rose) eyed hawks." In these the wings are rounded, the fourth feather is the longest in the wing, and the iris is yellow, orange or deep-orange.

The following glossary of the principal terms used in falconry may assist the reader in perusing this notice of the practice of the art. Useless or obsolete terms are omitted:—

Austringan.—A falconer.

Bate.—A hawk is said to "bate" when she flutters off from the fist, perch or block, whether from wildness, or for exercise, or in the attempt to chase.

Bewits.—Straps of leather by which the bells are fastened to a hawk's legs.

Bind.—A hawk is said to "bind" when she seizes a bird in the air and clings to it.

Block.—The conical piece of wood, of the form of an inverted flower-pot, used for hawks to sit upon; for a peregrine it should be about 10 to 12 in. high, 5 to 6 in diameter at top, and 8 to 9 in diameter at base.

Brail.—A thong of soft leather used to secure, when desirable, the wing of a hawk. It has a slit to admit the pinion joint, and the ends are tied together.

Cadge.—The wooden frame on which hawks, when numerous, are carried to the field.

Cadger.—The person who carries the cadge.

Calling off.—Luring a hawk (see *Lure*) from the hand of an assistant.

Carry.—A hawk is said to "carry" when she flies away with the quarry on the approach of the falconer.

Cast.—Two hawks which may be used for flying together are called a "cast," not necessarily a pair.

Casting.—The oblong or egg-shaped ball, consisting of feathers, bones, &c., which all hawks (and insectivorous birds) throw up after the nutritious part of their food has been digested. Also the fur or feathers given them to assist the process.

Cere.—The naked wax-like skin above the beak.

Check.—A hawk is said to fly at "check" when she flies at a bird other than the intended object of pursuit.

Clutching.—Taking the quarry in the feet as the short-winged hawks do. Falcons occasionally "clutch."

Come to.—A hawk is said to "come to" when she begins to get tame.

Coping.—Cutting the beak or talons of a hawk.

Crab.—To fight.

Creance.—A long line or string.

Crop, to put away.—A hawk is said to "put away her crop" when the food passes out of the crop into the stomach.

Deck feathers.—The two centre tail-feathers.

Eyas.—A hawk which has been brought up from the nest (nyas, from Fr. *niais*).

Eyry.—The nest of a hawk.

Foot.—A hawk is said to "foot" well or to be a "good footer" when she is successful in killing. Many hawks are very fine fliers without being "good footers."

Frounce.—A disease in the mouth and throat of hawks.

Get in.—To go up to a hawk when she has killed her quarry.

Hack.—The state of partial liberty in which young hawks must always at first be kept.

Haggard.—A wild-caught hawk in the adult plumage.

Hood.—(See fig.)

Hoodshy.—A hawk is said to be "hoodshy" when she is afraid of, or resists, having her hood put on.

Hunger trace.—A mark, and a defect, in the tail feathers, denoting a weak point; generally due to temporary starvation as a nestling.

Imping.—The process of mending broken feathers is called "imping." (See fig.)

Imping needle.—A piece of tough soft iron wire from about 1½ to 2½ in. long, rough filed so as to be three-sided and tapering from the middle to the ends. (See fig.)

Intermewed.—A hawk moulted in confinement is said to be "intermewed."

Jack.—Mate of the merlin.

Jerkin.—Mate of the jerrfalcon.

Jesses.—Strips of light but very tough leather, some 6 to 8 in. long, which always remain on a hawk's legs—one on each leg. (See fig.)

Jonk.—To sleep.

Leash.—A strong leathern thong, some 2½ or 3 ft. long, with a knot or button at one end, used to secure a hawk. (See fig.)

Lure.—The instrument used for calling long-winged hawks—a dead pigeon, or an artificial lure made of leather and feathers or wings of birds, tied to a string, with meat attached to it.

Mail.—The breast feathers.

Make hawk.—A hawk is called a "make hawk" when, as a thoroughly trained and steady hawk, she is flown with young ones to teach them their work.

Man a hawk.—To tame a hawk and accustom her to strangers.

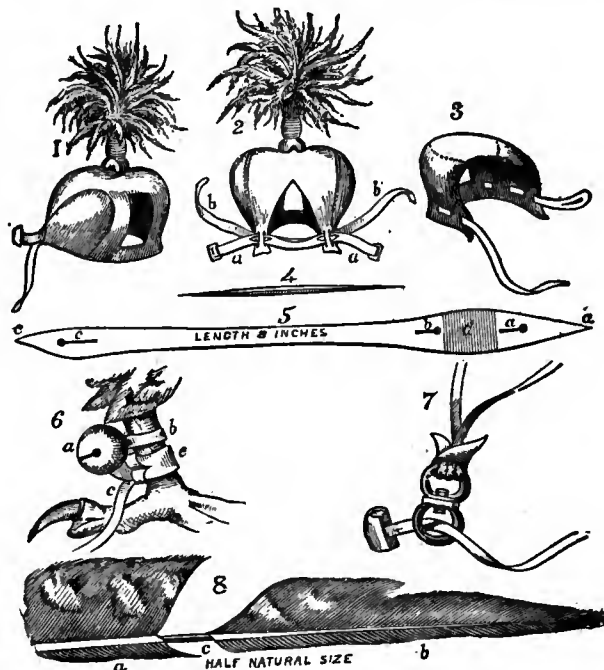

Implements used in Falconry.

- Hood.
- Back view of hood, showing braces *a, a, b, b*; by drawing the braces *b, b*, the hood, now open, is closed.
- Ruffer hood.
- Imping-needle.
- Jess; *d* is the space for the hawk's leg; the point and slit *a, a* are brought round the leg, and passed through slit *b*, after which the point *c* and slit *c*, and also the whole remaining length of jess, are pulled through slits *a* and *b*; *c* is the slit to which the upper ring of swivel is attached.
- Hawk's leg with bell *a*, bewit *b*, jess *c*.
- Jesses, swivel and leash.
- Portion of first wing-feather of male peregrine falcon, "tiercel," half natural size, in process of imping; *a*, the living hawk's feather; *b*, piece supplied from another tiercel, with the imping needle *c* pushed half its length into it and ready to be pushed home into the living bird's feather.

Mantle.—A hawk is said to "mantle" when she stretches out a leg and a wing simultaneously, a common action of hawks when at ease; also when she spreads out her wings and feathers to hide any quarry or food she may have seized from another hawk, or from man. In the last case it is a fault.

Mew.—A hawk is said to "mew" when she moults. The place where a hawk was kept to moult was in olden times called her "mew." Buildings where establishments of hawks were kept were called "mews."

Musket.—Male of the sparrow-hawk.

Mutes (mulings).—Excrement of hawk.

Pannel.—The stomach of a hawk, corresponding with the gizzard of a fowl, is called her pannel. In it the casting is formed.

Passage.—The line herons take over a tract of country on their way to and from the heronry when procuring food in the breeding season.

Passage hawks.—Hawks captured when on their passage or migration.

Pelt.—The dead body of any quarry the hawk has killed.

Pitch.—The height to which a hawk, when waiting for game to be flushed, rises in the air.

Plume.—A hawk is said to "plume" a bird when she pulls off the feathers.

Point.—A hawk "makes her point" when she rises in the air over the spot where quarry has saved itself from capture by dashing into a hedge, or has otherwise secreted itself.

Pounces.—A hawk's claws.

Pull through the hood.—A hawk is said to pull through the hood when she eats with it on.

Put in.—A bird is said to "put in" when it saves itself from the hawk by dashing into covert or other place of security.

Quarry.—The bird or beast flown at.

Rake out.—A hawk is said to "rake out" when she flies, while "waiting on" (see *Wait on*), too far and wide from her master.

Ramage.—Wild.

Red hawk.—Hawks of the first year, in the young plumage, are called "red hawks."

Ring.—A bird is said to "ring" when it rises spirally in the air.

Rufier hood.—An easy fitting hood, not, however, convenient for hooding and unhooding—used only for hawks when first captured. (See fig.)

Sails.—The wings of a hawk.

Seeling.—Closing the eyes by a fine thread drawn through the lid of each eye, the threads being then twisted together above the head—a practice long disused in England.

Serving a hawk.—Driving out quarry which has taken refuge, or has "put in."

Stoop.—The hawk's rapid plunge upon the quarry.

Take the air.—A bird is said to "take the air" when it seeks to escape by trying to rise higher than the falcon.

Tiercel.—The male of various falcons, particularly of the peregrine, also *tarcell*, *tassell* or *tercel*; the term is also applied to the male of the goshawk.

Trussing.—A hawk is said to "truss" a bird when she catches it in the air, and comes to the ground with it in her talons; this term is not applied to large quarry. (See *Bind*.)

Varvels.—Small rings, generally of silver, fastened to the end of the jesses, and engraved with the owner's name.

Wait on.—A hawk is said to "wait on" when she flies above her master waiting till game is sprung.

Weathering.—Hawks are "weathered" by being placed unhooded in the open air. Passage hawks which are not sufficiently reclaimed to be left out by themselves unhooded on blocks are "weathered" by being put out for an hour or two under the falconer's eye.

Yarak.—An Eastern term, generally applied to short-winged hawks. When a hawk is keen, and in hunting condition, she is said to be "in yarak."

The training of hawks affords much scope for judgment, experience and skill on the part of the falconer, who must carefully observe the temper and disposition as well as the constitution of each bird. It is through the appetite principally that hawks, like most wild animals, are tamed; but to fit them for use in the field much patience, gentleness and care must be used. Slovenly taming necessitates starving, and low condition and weakness are the result. The aim of the falconer must be to have his hawks always keen, and the appetite when they are brought into the field should be such as would induce the bird in a state of nature to put forth its full powers to obtain its food, with, as near as possible, a corresponding condition as to flesh. The following is an outline of the process of training hawks, beginning with the management of a wild-caught peregrine falcon. When first taken, a rufier hood should be put on her head, and she must be furnished with jesses, swivel, leash and bell. A thick glove or rather gauntlet must be worn on the left hand (Eastern falconers always carry a hawk on the right), and she must be carried about as much as possible, late into the night, every day, being constantly stroked with a bird's wing or feather, very lightly at first. At night she should be tied to a perch in a room with the window darkened, so that no light can enter in the morning. The perch should be a padded pole placed across the room, about 4½ ft. from the ground, with a canvas screen underneath. She will easily be induced to feed in most cases by drawing a piece of beefsteak over her feet, brushing her legs at the time with a wing, and now and then, as she snaps, slipping a morsel into her mouth. Care must be taken to make a peculiar sound with the lips or tongue, or to use a low whistle as she is in the act of swallowing; she will very soon learn to associate this sound with feeding, and it will be found that directly she hears it, she will gripe with her talons, and bend down to feel for food. When the falconer perceives this and other signs of her "coming to," that she no longer

starts at the voice or touch, and steps quietly up from the perch when the hand is placed under her feet, it will be time to change her rufier hood for the ordinary hood. This latter should be very carefully chosen—an easy fitting one, in which the braces draw closely and yet easily and without jerking. An old one previously worn is to be recommended. The hawk should be taken into a very dark room—one absolutely dark is best—and the change should be made if possible in total darkness. After this she must be brought to feed with her hood off; at first she must be fed every day in a darkened room, a gleam of light being admitted. The first day, the hawk having seized the food and begun to pull at it freely, the hood must be gently slipped off, and after she has eaten a moderate quantity, it must be replaced as slowly and gently as possible, and she should be allowed to finish her meal through the hood. Next day the hood may be twice removed, and so on; day by day the practice should be continued, and more light gradually admitted, until the hawk will feed freely in broad daylight, and suffer the hood to be taken off and replaced without opposition. Next she must be accustomed to see and feed in the presence of strangers and dogs, &c. A good plan is to carry her in the streets of a town at night, at first where the gas-light is not strong, and where persons passing by are few, unhooding and hooding her from time to time, but not letting her get frightened. Up to this time she should be fed on lean beefsteak with no castings, but as soon as she is tolerably tame and submits well to the hood, she must occasionally be fed with pigeons and other birds. This should be done not later than 3 or 4 P.M., and when she is placed on her perch for the night in the dark room, she must be unhooded and left so, of course being carefully tied up. The falconer should enter the room about 7 or 8 A.M. next day, admitting as little light as possible, or using a candle. He should first observe if she has thrown her casting; if so, he will at once take her to the fist, giving her a bite of food, and re-hood her. If her casting is not thrown it is better for him to retire, leaving the room quite dark, and come in again later. She must now be taught to know the voice—the shout that is used to call her in the field—and to jump to the fist for food, the voice being used every time she is fed. When she comes freely to the fist she must be made acquainted with the lure. Kneeling down with the hawk on his fist, and gently unhooding her, the falconer casts out a lure, which may be either a dead pigeon or an artificial lure garnished with beefsteak tied to a string, to a distance of a couple or three feet in front of her. When she jumps down to it, she should be allowed to eat a little on it—the voice being used—the while receiving morsels from the falconer's hand; and before her meal is finished she must be taken off to the hand, being induced to forsake the lure for the hand by a tempting piece of meat. This treatment will help to check her inclination hereafter to carry her quarry. This lesson is to be continued till the falconer feeds very boldly on the lure on the ground, in the falconer's presence—till she will suffer him to walk round her while she is feeding. All this time she will have been held by the leash only, but in the next step a strong, but light creance must be made fast to the leash, and an assistant holding the hawk should unhood her, as the falconer, standing at a distance of 5 to 10 yds., calls her by shouting and casting out the lure. Gradually day after day the distance is increased, till the hawk will come 30 yds. or so without hesitation; then she may be trusted to fly to the lure at liberty, and by degrees from any distance, say 1000 yds. This accomplished, she should learn to stoop at the lure. Instead of allowing the hawk to seize upon it as she comes up, the falconer should snatch the lure away and let her pass by, and immediately put it out that she may readily seize it when she turns round to look for it. This should be done at first only once, and then progressively until she will stoop backwards and forwards at the lure as often as desired. Next she should be entered at her quarry. Should she be intended for rooks or herons, two or three of these birds should be procured. One should be given her from the hand, then one should be released close to her, and a third at a considerable distance. If she take these keenly, she may be flown at a wild bird. Care must, however, be taken to

let her have every possible advantage in her first flights—wind and weather, and the position of the quarry with regard to the surrounding country, must be considered.

Young hawks, on being received by the falconer before they can fly, must be put into a sheltered place, such as an outhouse or shed. Their basket or hamper should be filled with straw. A hamper is best, with the lid so placed as to form a platform for the young hawks to come out upon to feed. This should be fastened to a beam or prop a few feet from the ground. The young hawks must be most plentifully fed on the best fresh food obtainable—good beefsteak and fresh-killed birds; the falconer when feeding them should use his voice as in luring. As they grow old enough they will come out, and perch about the roof of their shed, by degrees extending their flights to neighbouring buildings or trees, never failing to come at feeding time to the place where they are fed. Soon they will be continually on the wing, playing or fighting with one another, and later the falconer will observe them chasing other birds, as pigeons and rooks, which may be passing by. As soon as one fails to come for a meal, it must be at once caught with a bow net or a snare the first time it comes back, or it will be lost. It must be borne in mind that the longer hawks can be left at hack the better they are likely to be for use in the field—those hawks being always the best which have preyed a few times for themselves before being caught. Of course there is great risk of losing hawks when they begin to prey for themselves. When a hawk is so caught she is said to be “taken up” from hack. She will not require a rufter hood, but a good deal of the management described for the passage falcon will be necessary. She must be carefully tamed and broken to the hood in the same manner, and so taught to know the lure; but, as might be expected, very much less difficulty will be experienced. As soon as the eyas knows the lure sufficiently well to come to it sharp and straight from a distance, she must be taught to “wait on.” This is effected by letting the hawk loose in an open place, such as a down. It will be found that she will circle round the falconer looking for the lure she has been accustomed to see—perhaps mount a little in the air, and advantage must be taken of a favourable moment when the hawk is at a little height, her head being turned in towards the falconer, to let go a pigeon which she can easily catch. When the hawk has taken two or three pigeons in this way, and mounts immediately in expectation, in short, begins to wait on, she should see no more pigeons, but be tried at game as soon as possible. Young peregrines should be flown at grouse first in preference to partridges, not only because the season commences earlier, but because, grouse being the heavier birds, they are not so much tempted to “carry” as with partridges.

The training of the great northern falcons, as well as that of merlins and hobbies, is conducted much on the above principles, but the jersfalcons (gerfalcons or gyrfalcons) will seldom wait on well, and merlins will not do it at all.

The training of short-winged hawks is a simpler process. They must, like falcons, be provided with jesses, swivel, leash and bell. In these hawks a bell is sometimes fastened to the tail. Sparrow-hawks can, however, scarcely carry a bell big enough to be of any service. The hood is seldom used for short-winged hawks—never in the field. They must be made as tame as possible by carriage on the fist and the society of man, and taught to come to the fist freely when required—at first to jump to it in a room, and then out of doors. When the goshawk comes freely and without hesitation from short distances, she ought to be called from long distances from the hand of an assistant, but not oftener than twice in each meal, until she will come at least 1000 yds., on each occasion being well rewarded with some food she likes very much, as a fresh-killed bird, warm. When she does this freely, and endures the presence of strangers, dogs, &c., a few bagged rabbits should be given to her, and she will be ready to take the field. Some accustom the goshawk to the use of the lure, for the purpose of taking her if she will not come to the fist in the field when she has taken stand in a tree after being balked of her quarry, but it ought not to be necessary to use it.

Falcons or long-winged hawks are either “flown out of the hood,” *i.e.* unhooded and slipped when the quarry is in sight, or they are made to “wait on” till game is flushed. Herons and rooks are always taken by the former method. Passage hawks are generally employed for flying at these birds, though sometimes good eyases are quite equal to the work. For heron-hawking a well-stocked heronry is in the first place necessary. Next an open country which can be ridden over—over which herons are in the constant habit of passing to and from their heronry on their fishing excursions, or making their “passage.” A heron found at his feeding-place at a brook or pond affords no sport whatever. If there be little water any peregrine falcon that will go straight at him will seize him soon after he rises. It is sometimes advisable to fly a young falcon at a heron so found, but it should not be repeated. If there be much water the heron will neither show sport nor be captured. It is quite a different affair when he is sighted winging his way at a height in the air over an open tract of country free from water. Though he has no chance whatever of competing with a falcon in straight-forward flight, the heron has large concave wings, a very light body proportionately, and air-cells in his bones, and can rise with astonishing rapidity, more perpendicularly, or, in other words, in smaller rings, than the falcon can, with very little effort. As soon as he sees the approach of the falcon, which he usually does almost directly she is cast off, he makes play for the upper regions. Then the falcon commences to climb too to get above him, but in a very different style. She makes very large circles or rings, travelling at a high rate of speed, due to her strength and weight and power of flying, till she rises above the heron. Then she makes her attack by stooping with great force at the quarry, sometimes falling so far below it as the blow is evaded that she cannot spring up to the proper pitch for the next stoop, and has to make another ring to regain her lost command over the heron, which is ever rising, and so on—the “field” meanwhile galloping down wind in the direction the flight is taking till she seizes the heron aloft, “binds” to him, and both come down together. Absurd stories have been told and pictures drawn of the heron receiving the falcon on its beak in the air. It is, however, well known to all practical falconers that the heron has no power or inclination to fight with a falcon in the air; so long as he is flying he seeks safety solely from his wings. When on the ground, however, should the falcon be deficient in skill or strength, or have been mutilated by the coping of her beak and talons, as was sometimes formerly done in Holland with a view to saving the heron's life, the heron may use his dagger-like bill with dangerous effect, though it is very rare for a falcon to be injured. It is never safe to fly the goshawk at a heron of any description. Short-winged hawks do not immediately kill their quarry as falcons do, nor do they seem to know where the life lies, and seldom shift their hold once taken even to defend themselves; and they are therefore easily stabbed by a heron. Rooks are flown in the same manner as herons, but the flight is generally inferior. Although rooks fly very well, they seek shelter in trees or bushes as soon as possible.

For game-hawking eyases are generally used, though undoubtedly passage or wild-caught hawks are to be preferred. The best game hawks we have seen have been passage hawks, but there are difficulties attending the use of them. It may perhaps be fairly said that it is easy to make all passage hawks “wait on” in grand style, but until they have got over a season or two they are very liable to be lost. Among the advantages attending the use of eyases are the following: they are easier to obtain and to train and keep; they also moult far better and quicker than passage hawks, while if lost in the field they will often go home by themselves, or remain about the spot where they were liberated. Experience, and, we must add, some good fortune also, are requisite to make eyases good for waiting on for game. Slight mistakes on the part of the falconer, false points from dogs, or bad luck in serving, will cause a young hawk to acquire bad habits, such as sitting down on the ground, taking stand in a tree, raking out wide, skimming the ground, or lazily flying about at no height. A good game hawk in proper

flying order goes up at once to a good pitch in the air—the higher she flies the better—and follows her master from field to field, always ready for a stoop when the quarry is sprung. Hawks that have been successfully broken and judiciously worked become wonderfully clever, and soon learn to regulate their flight by the movements of their master. Eyases were not held in esteem by the old falconers, and it is evident from their writings that these hawks have been very much better understood and managed in the 19th century than in the middle ages. It is probable that the old falconers procured their passage and wild-caught hawks with such facility, having at the same time more scope for their use in days when quarry was more abundant and there was more waste land than there now is, that they did not find it necessary to trouble themselves about eyases. Here may be quoted a few lines from one of the best of the old writers, which may be taken as giving a fair account of the estimation in which eyases were generally held, and from which it is evident that the old falconers did not understand flying hawks at hack. Simon Latham, writing in 1633, says of eyases :

They will be verie easily brought to familiaritie with the man, not in the house only, but also abroad, hooded or unhooded; nay, many of them will be more gentle and quiet when unhooded than when hooded, for if a man doe but stirre or speake in their hearing, they will crie and bate as though they did desire to see the man. Likewise some of them being unhooded, when they see the man will cowre and crie, shewing thereby their exceeding fondness and fawning love towards him . . .

. . . These kind of hawks be all (for the most part) taken out of the nest while verie young, even in the downe, from whence they are put into a close house, whereas they be alwaies fed and familiarly brought up by the man, untill they bee able to flie, when as the summer approaching verie suddenly they are continued and trained up in the same, the weather being alwaies warm and temperate; thus they are still inured to familiaritie with the man, not knowing from whence besides to fetch their relief or sustenance. When the summer is ended they bee commonly put up into a house again, or else kept in some warm place, for they cannot endure the cold wind to blow upon them. . . . But leaving to speak of these kind of scratching hawks that I never did love should come too neere my fingers, and to return unto the faire conditioned haggard falcon. . . .

The author here describes with accuracy the condition of unhacked eyases, which no modern falconer would trouble himself to keep. Many English falconers in modern times have had eyases which have killed grouse, ducks and other quarry in a style almost equalling that of passage hawks. Rooks also have been most successfully flown, and some herons on passage have been taken by eyases. No sport is to be had at game without hawks that wait on well. Moors, downs, open country where the hedges are low and weak are best suited to game hawking. Pointers or setters may be used to find game, or the hawk may be let go on coming to the ground where game is known to lie, and suffered, if an experienced one, to "wait on" till game is flushed. However, the best plan with most hawks, young ones especially, is to use a dog, and to let the hawk go when the dog points, and to flush the birds as soon as the hawk is at her pitch. It is not by any means necessary that the hawk should be near the birds when they rise, provided she is at a good height, and that she is watching; she will come at once with a rush out of the air at great speed, and either cut one down with the stoop, or the bird will save itself by putting in, when every exertion must be made, especially if the hawk be young and inexperienced, to "serve" her as soon as possible by driving out the bird again while she waits overhead. If this be successfully done she is nearly certain to kill it at the second flight. Perhaps falcons are best for grouse and tiercels for partridges.

Magpies afford much sport. Only tiercels should be used for hunting magpies. A field is necessary—at the very least 4 or 5 runners to beat the magpie out, and perhaps the presence of a horseman is an advantage. Of course in open flight a magpie would be almost immediately caught by a tiercel peregrine, and there would be no sport, but the magpie makes up for his want of power of wing by his cunning and shiftiness; and he is, moreover, never to be found except where he has shelter under his lee for security from a passing peregrine. Once in a hedge

or tree he is perfectly safe from the wild falcon, but the case is otherwise when the falconer approaches with his trained tiercel, perhaps a cast of tiercels, waiting on in the air, with some active runners in his field. Then driven from hedge to hedge, from one kind of shelter to another, stooped at every instant when he shows himself ever so little away from cover by the watchful tiercels overhead, his egg-stealing days are brought to an end by a fatal stroke—sometimes not before the field is pretty well exhausted with running and shouting. The magpie always manœuvres towards some thick wood, from which it is the aim of the field to cut him off. At first hawks must be flown in easy country, but when they understand their work well they will kill magpies in very enclosed country—with a smart active field a magpie may even be pushed through a small wood. Magpie hawking affords excellent exercise, not only for those who run to serve the hawks, but for the hawks also; they get a great deal of flying, and learn to hunt in company with men—any number of people may be present. Blackbirds may be hunted with tiercels in the same way. Woodcock afford capital sport where the country is tolerably open. It will generally be found that after a hawk has made one stoop at a woodcock, the cock will at first try to escape by taking the air, and will show a very fine flight. When beaten in the air it will try to get back to covert again, but when once a hawk has outflown a woodcock, he is pretty sure to kill it. Hawks seem to pursue woodcock with great keenness; something in the flight of the cock tempts them to exertion. The laziest and most useless hawks—hawks that will scarcely follow a slow pigeon—will do their best at woodcock, and will very soon, if the sport is continued, be improved in their style of flying. Snipe may be killed by first-class tiercels in favourable localities. Wild duck and teal are only to be flown at when they can be found in small pools or brooks at a distance from much water—where the fowl can be suddenly flushed by men or dogs while the falcon is flying at her pitch overhead. For duck, falcons should be used; tiercels will kill teal well.

The merlin is used for flying at larks, and there does not seem to be any other use to which this pretty little falcon may fairly be put. It is very active, but far from being, as some authors have stated, the swiftest of all hawks. Its flight is greatly inferior in speed and power to that of the peregrine. Perhaps its diminutive size, causing it to be soon lost to view, and a limited acquaintance with the flight of the wild peregrine falcon, have led to the mistake.

The hobby is far swifter than the merlin, but cannot be said to be efficient in the field; it may be trained to wait on beautifully, and will sometimes take larks; it is very much given to the fault of "carrying."

The three great northern falcons are not easy to procure in proper condition for training. They are very difficult to break to the hood and to manage in the field. They are flown, like the peregrine, at herons and rooks, and in former days were used for kites and hares. Their style of flight is magnificent; they are considerably swifter than the peregrine, and are a most deadly "footers." They seem, however, to lack somewhat of the spirit and dash of the peregrine.

For the short-winged hawks an open country is not required; indeed they may be flown in a wood. Goshawks are flown at hares, rabbits, pheasants, partridges and wild-fowl. Only very strong females are able to take hares; rabbits are easy quarry for any female goshawk, and a little too strong for the male. A good female goshawk may kill from 10 to 15 rabbits in a day, or more. For pheasants the male is to be preferred, certainly for partridges; either sex will take duck and teal, but the falconer must get close to them before they are flushed, or the goshawk will stand a poor chance of killing. Rabbit hawking may be practised by ferreting, and flying the hawk as the rabbits bolt, but care must be taken or the hawk will kill the ferret. Where rabbits sit out on grass or in turnip fields, a goshawk may be used with success, even in a wood when the holes are not too near. From various causes it is impossible, or nearly so, to have goshawks in England in the perfection to which

they are brought in the East. In India, for instance, there is a far greater variety of quarry suited to them, and wild birds are much more approachable; moreover, there are advantages for training which do not exist in England. Unmolested—and scarcely noticed except perhaps by others of his calling or tastes—the Eastern falconer carries his hawk by day and night in the crowded bazaars, till the bird becomes perfectly indifferent to men, horses, dogs, carriages, and, in short, becomes as tame as the domestic animals.

The management of sparrow-hawks is much the same as that of goshawks, but they are far more delicate than the latter. They are flown in England at blackbirds, thrushes and other small birds; good ones will take partridges well till the birds get too wild and strong with the advancing season. In the East large numbers of quail are taken with sparrow-hawks.

It is of course important that hawks from which work in the field is expected should be kept in the highest health, and they must be carefully fed; no bad or tainted meat must on any account be given to them—at any rate to hawks of the species used in England. Peregrines and the great northern falcons are best kept on beefsteak, with a frequent change in the shape of fresh-killed pigeons and other birds. The smaller falcons, the merlin and the hobby, require a great number of small birds to keep them in good health for any length of time. Goshawks should be fed like peregrines, but rats and rabbits are very good as change of food for them. The sparrow-hawk, like the small falcons, requires small birds. All hawks require castings frequently. It is true that hawks will exist, and often appear to thrive, on good food without castings, but the seeds of probable injury to their health are being sown the whole time they are so kept. If there is difficulty in procuring birds, and it is more convenient to feed the hawks on beefsteak, they should frequently get the wings and heads and necks of game and poultry. In addition to the castings which they swallow, tearing these is good exercise for them, and biting the bones prevents the beaks from overgrowing. Most hawks, peregrines especially, require the bath. The end of a cask, sawn off to give a depth of about 6 in., makes a very good bath. Peregrines which are used for waiting on require a bath at least twice a week. If this be neglected, they will not wait long before going off in search of water to bathe, however hungry they may be.

The most agreeable and the best way, where practicable, of keeping hawks is to have them on blocks on the lawn. Each hawk's block should stand in a circular bed of sand—about 8 ft. in diameter; this will be found very convenient for keeping them clean. Goshawks are generally placed on bow perches, which ought not to be more than 8 or 9 in. high at the highest part of the arc. It will be several months before passage or wild-caught falcons can be kept out of doors; they must be fastened to a perch in a darkened room, hooded, but by degrees as they get thoroughly tame may be brought to sit on the lawn. In England (especially in the south) peregrines, the northern falcons and goshawks may be kept out of doors all day and night in a sheltered situation. In very wild boisterous weather, or in snow or sharp frost, it will be advisable to move them to the shelter of a shed, the floor of which should be laid with sand to a depth of 3 or 4 in. Merlins and hobbies are too tender to be kept much out of doors. An eastern aspect is to be preferred—all birds enjoy the morning sun, and it is very beneficial to them. The more hawks confined to blocks out of doors see of persons, dogs, horses, &c., moving about the better, but of course only when there is no danger of their being frightened or molested, or of food being given to them by strangers. Those who have only seen wretched ill-fed hawks in cages as in zoological gardens or menageries, pining for exercise, with battered plumage, torn shoulders and bleeding ceres, from dashing against their prison bars, and overgrown beaks from never getting bones to break, can have little idea of the beautiful and striking-looking birds to be seen pluming their feathers and stretching their wings at their ease at their blocks on the falconer's lawn, watching with their large bright keen eyes everything that moves in the sky and everywhere else within the limits of their view. Contrary

to the prevailing notion, hawks show a good deal of attachment when they have been properly handled. It is true that by hunger they are in a great measure tamed and controlled, and the same may be said of all undomesticated and many domesticated animals. And instinct prompts all wild creatures when away from man's control to return to their former shyness, but hawks certainly retain their tameness for a long time, and their memory is remarkably retentive. Wild-caught hawks have been retaken, either by their coming to the lure or upon quarry, from 2 to 7 days after they had been lost, and eyases after 3 weeks. As one instance of retentiveness of memory displayed by hawks we may mention the case of a wild-caught falcon which was recaptured after being at liberty more than 3 years, still bearing the jesses which were cut short close to the leg at the time she was released; in five days she was flying at the lure again at liberty, and was found to retain the peculiar ways and habits she was observed to have in her former existence as a trained hawk. It is useless to bring a hawk into the field unless she has a keen appetite; if she has not, she will neither hunt effectually nor follow her master. Even wild-caught falcons, however, may sometimes be seen so attached to their owner that, when sitting on their blocks on a lawn with food in their crops, they will on his coming out of the house bate hard to get to him, till he either go up to them and allow them to jump up to his hand or withdraw from their sight. Goshawks are also known to evince attachment to their owner. Another prevailing error regarding hawks is that they are supposed to be lazy birds, requiring the stimulus of hunger to stir them to action. The reverse is the truth; they are birds of very active habits, and exceedingly restless, and the notion of their being lazy has been propagated by those who have seen little or nothing of hawks in their wild state. The wild falcon requires an immense deal of exercise, and to be in wind, in order to exert the speed and power of flight necessary to capture her prey when hungry; and to this end instinct prompts her to spend hours daily on the wing, soaring and playing about in the air in all weathers, often chasing birds merely for play or exercise. Sometimes she takes a siesta when much gorged, but unless she fills her crop late in the evening she is soon moving again—before half her crop is put over. Goshawks and sparrow-hawks, too, habitually soar in the air at about 9 or 10 A.M., and remain aloft a considerable time, but these birds are not of such active habits as the falcons. The frequent bating of thoroughly tame hawks from their blocks, even when not hungry or frightened, proves their restlessness and impatience of repose. So does the wretched condition of the caged falcon (before alluded to), while the really lazy buzzards and kites, which do not in a wild state depend on activity or power of wing for their sustenance, maintain themselves for years, even during confinement if properly fed, in good case and plumage. Such being the habits of the falcon in a state of nature, the falconer should endeavour to give the hawks under his care as much flying as possible, and he should avoid the very common mistake of keeping too many hawks. In this case a favoured few are sure to get all the work, and the others, possibly equally good if they had fair play, are spoiled for want of exercise.

The larger hawks may be kept in health and working order for several years—15 or 20—barring accidents. The writer has known peregrines, shaheens and goshawks to reach ages between 15 and 20 years. Goshawks, however, never fly well after 4 or 5 seasons, when they will no longer take difficult quarry; they may be used at rabbits as long as they live. Shaheens may be seen in the East at an advanced age, killing wild-fowl beautifully. The shaheen is a falcon of the peregrine type, which does not travel, like the peregrine, all over the world. It appears that the jersfalcons also may be worked to a good age. Old Simon Latham tells us of these birds—"I myself have known one of them an excellent Hearnor (killer of herons), and to continue her goodness very near twentie yeeres, or full out that time."

AUTHORITIES.—Schlegel's *Traité de fauconnerie* contains a very large list of works on falconry in the languages of all the principal countries of the Old World. *Bibliotheca accipitraria*, by J. E.

Harting (1891), gives a complete bibliography. See *Coursing and Falconry* in the Badminton Library; and *The Art and Practice of Hawking*, by E. B. Michell (1900), the best modern book on the subject. Perhaps the most useful of the old works are *The Booke of Faulconrie or Hawking*, by George Turberville (1575), and *The Faulcon's Lure and Cure*, by Simon Latham (1633). (E. D. R.)

FALDSTOOL (from the O.H. Ger. *falden* or *fallen*, to fold, and *stool*, Mod. Ger. *Stuhl*, a stool; from the medieval Latin *faldistolium* is derived, through the old form *faudesteuil*, the Mod. Fr. *faulcuil*), properly a folding seat for the use of a bishop when not occupying the throne in his own cathedral, or when officiating in a cathedral or church other than his own; hence any movable folding stool used for kneeling in divine service. The small desk or stand from which the Litany is read is sometimes called a faldstool, and a similar stool is provided for the use of the sovereign at his coronation.

FALERII [mod. *Civiltà Castellana* (q.v.)], one of the twelve chief cities of Etruria, situated about 1 m. W. of the ancient Via Flaminia,¹ 32 m. N. of Rome. According to the legend, it was of Argive origin; and Strabo's assertion that the population, the Falisci (q.v.), were of a different race from the Etruscans is proved by the language of the earliest inscriptions which have been found here. Wars between Rome and the Falisci appear to have been frequent. To one of the first of them belongs the story of the schoolmaster who wished to betray his boys to Camillus; the latter refused his offer, and the inhabitants thereupon surrendered the city. At the end of the First Punic War, the Falisci rose in rebellion, but were soon conquered (241 B.C.) and lost half their territory. Zonaras (viii. 18) tells us that the ancient city, built upon a precipitous hill, was destroyed and another built on a more accessible site on the plain. The description of the two sites agrees well with the usual theory that the original city occupied the site of the present Civiltà Castellana, and that the ruins of Falleri (as the place is now called) are those of the Roman town which was thus transferred 3 m. to the north-west. After this time Falerii hardly appears in history. It became a colony (Junonia Faliscorum) perhaps under Augustus, though according to the inscriptions apparently not until the time of Gallienus. There were bishops of Falerii up till 1033, when the desertion of the place in favour of the present site began, and the last mention of it dates from A.D. 1064.

The site of the original Falerii is a plateau, about 1100 yds. by 400, not higher than the surrounding country (475 ft.) but separated from it by gorges over 200 ft. in depth, and only connected with it on the western side, which was strongly fortified with a mound and ditch; the rest of the city was defended by walls constructed of rectangular blocks of tufa, of which some remains still exist. Remains of a temple were found at Lo Scasato, at the highest point of the ancient town, in 1888, and others have been excavated in the outskirts. The attribution of one of these to Juno Quiritis is uncertain. These buildings were of wood, with fine decorations of coloured terracotta (*Notizie degli scavi*, 1887, p. 92; 1888, p. 414). Numerous tombs hewn in the rock are visible on all sides of the town, and important discoveries have been made in them; many objects, both from the temples and from the tombs, are in the Museo di Villa Giulia at Rome. Similar finds have also been made at Calcata, 6 m. S., and Corchiano, 5 m. N.W. The site of the Roman Falerii is now entirely abandoned. It lay upon a road which may have been (see H. Nissen, *Italische Landeskunde*, ii. 361) the Via Annia, a by-road of the Via Cassia; this road approached it from the south passing through Nepet, while its prolongation to the north certainly bore the name Via Amerina. The circuit of the city is about 2250 yds., its shape roughly triangular, and the walls are a remarkably fine and well-preserved specimen of Roman military architecture. They are constructed

¹ The Roman town lay 3 m. farther N.W. on the Via Annia. The Via Flaminia, which did not traverse the Etruscan city, had two post-stations near it, Aquaviva, some 2½ m. S.E., and Aequum Faliscum, 4½ m. N.N.E.; the latter is very possibly identical with the Etruscan site which G. Dennis (*Cities and Cemeteries of Etruria*, London, 1883, i. 121) identified with Fescennium (q.v.). See O. Cuntz in *Jahreshefte des österr. arch. Inst.* ii. (1899), 87.

of rectangular blocks of tufa two Roman ft. in height; the walls themselves reach in places a height of 56 ft. and are 7 to 9 ft. thick. There were about 80 towers, some 50 of which are still preserved. Two of the gates also, of which there were eight, are noteworthy. Of the buildings within the walls hardly anything is preserved above ground, though the forum and theatre (as also the amphitheatre, the arena of which measured 180 by 108 ft. outside the walls) were all excavated in the 19th century. Almost the only edifice now standing is the 12th-century abbey church of S. Maria. Recent excavations have shown that the plan of the whole city could easily be recovered, though the buildings have suffered considerable devastation (*Notizie degli scavi*, 1903, 14).

See G. Dennis, *Cities and Cemeteries of Etruria* (London, 1883), i. 97; for philology and ethnology see FALISCI. (T. As.)

FALERIO (mod. *Falerone*), an ancient town of Picenum, Italy, about 10 m. S.E. of Urbs Salvia. We know almost nothing of the place except from inscriptions, from which, and from the remains of its buildings, it appears to have been of some importance. It was probably founded as a colony by Augustus after his victory at Actium. A question arose in the time of Domitian between the inhabitants of Falerio and Firmum as to land which had been taken out of the territory of the latter (which was recolonized by the triumvirs), and, though not distributed to the new settlers, had not been given back again to the people of Firmum. The emperor, by a rescript, a copy of which in bronze was found at Falerio, decided in favour of the people of Falerio, that the occupiers of this land should remain in possession of it (Th. Mommsen in *Corp. Inscr. Latin.* ix., Berlin, 1883, No. 5, 420). Considerable remains of a theatre in concrete faced with brickwork, erected, according to an inscription, in 43 B.C., and 161 ft. in diameter, were excavated in 1838 and are still visible; and an amphitheatre, less well preserved, also exists, the arena of which measures about 180 by 150 ft. Between the two is a water reservoir (called Bagno della Regina) connected with remains of baths.

See G. de Minicis in *Giornale Arcadico*, lv. (1832), 160 seq.; *Annali dell' Istituto* (1839), 5 seq. (T. As.)

FALGUIÈRE, JEAN ALEXANDRE JOSEPH (1831-1900), French sculptor and painter, was born at Toulouse. A pupil of the École des Beaux Arts he won the *Prix de Rome* in 1859; he was awarded the medal of honour at the Salon in 1868 and was appointed officer of the Legion of Honour in 1878. His first bronze statue of importance was the "Victor of the Cock-Fight" (1864), and "Tarcisus the Christian Boy-Martyr" followed in 1867; both are now in the Luxembourg Museum. His more important monuments are those to Admiral Courbet (1890) at Abbeville and the famous "Joan of Arc." Among more ideal work are "Eve" (1880), "Diana" (1882 and 1891), "Woman and Peacock," and "The Poet," astride his Pegasus spreading wings for flight. His "Triumph of the Republic" (1881-1886), a vast quadriga for the Arc de Triomphe, Paris, is perhaps more amazingly full of life than others of his works, all of which reveal this quality of vitality in superlative degree. To these works should be added his monuments to "Cardinal Lavignerie" and "General de La Fayette" (the latter in Washington), and his statues of "Lamartine" (1876) and "St Vincent de Paul" (1879), as well as the "Balzac," which he executed for the *Société des gens de lettres* on the rejection of that by Rodin; and the busts of "Carolus-Duran" and "Coquelin cadet" (1896).

Falguière was a painter as well as a sculptor, but somewhat inferior in merit. He displays a fine sense of colour and tone, added to the qualities of life and vigour that he instils into his plastic work. His "Wrestlers" (1875) and "Fan and Dagger" (1882; a defiant Spanish woman) are in the Luxembourg, and other pictures of importance are "The Beheading of St John the Baptist" (1877), "The Sphinx" (1883), "Acis and Galatea" (1885), "Old Woman and Child" (1886) and "In the Bull Slaughter-House." He became a member of the Institute (Académie des Beaux-Arts) in 1882. He died in 1900.

See Léonce Bénédict, *Alexandre Falguière*, Librairie de l'art (Paris).

FALIERO (or **FALIER**), **MARINO** (1279-1355), doge of Venice, belonged to one of the oldest and most illustrious Venetian families and had served the republic with distinction in various capacities. In 1346 he commanded the Venetian land forces at the siege of Zara, where he was attacked by the Hungarians under King Louis the Great and totally defeated them; this victory led to the surrender of the city. In September 1354, while absent on a mission to Pope Innocent IV. at Avignon, Faliero was elected doge, an honour which apparently he had not sought. His reign began, as it was to end, in disaster, for very soon after his election the Venetian fleet was completely destroyed by the Genoese off the island of Sapienza, while plague and a declining commerce aggravated the situation. Although a capable commander and a good statesman, Faliero possessed a violent temper, and after his election developed great ambition. The constitutional restrictions of the ducal power, which had been further curtailed just before his election, and the insolence of the nobility aroused in him a desire to free himself from all control, and the discontent of the arsenal hands at their treatment by the nobles offered him his opportunity. In concert, with a sea-captain named Bertuccio Ixarella (who had received a blow from the noble Giovanni Dandolo), Filippo Calendario, a stonemason, and others, a plot was laid to murder the chief patricians on the 15th of April and proclaim Faliero prince of Venice. But there was much ferment in the city and disorders broke out before the appointed time; some of the conspirators having made revelations, the Council of Ten proceeded to arrest the ringleaders and to place armed guards all over the town. Several of the conspirators were condemned to death and others to various terms of imprisonment. The doge's complicity having been discovered, he was himself arrested; at the trial he confessed everything and was condemned and executed on the 17th of April 1355.

The story of the insult written by Michele Steno on the doge's chair is a legend of which no record is found in any contemporary authority. The motives of Faliero are not altogether clear, as his past record, even in the judgment of the poet Petrarch, showed him as a wise, clear-headed man of no unusual ambition. But possibly the attitude of the aristocracy and the example offered by the tyrants of neighbouring cities may have induced him to attempt a similar policy. The only result of the plot was to consolidate the power of the Council of Ten.

BIBLIOGRAPHY.—An account of Marino Faliero's reign is given in S. Romanin's *Storia documentata di Venezia*, lib. ix. cap. ii. (Venice, 1855); M. Sanudo, *Le Vite dei Dogi* in new edition of Muratori fasc., 3, 4, 5 (Città di Castello, 1900). For special works see V. Lazzarini's "Genealogia d. M. Faliero" in the *Archivio Veneto* of 1892; "M. Faliero avanti il Dogado," *ibid.* (1893), and his exhaustive study "M. Faliero, la Congiura," *ibid.* (1897). The most recent essay on the subject is contained in Horatio Brown's *Studies in Venetian History* (London, 1907), wherein all the authorities are set forth. (L. V.)*

FALISCI, a tribe of Sabine origin or connexions, but speaking a dialect closely akin to Latin, who inhabited the town of Falerii (*q.v.*), as well as a considerable tract of the surrounding country, probably reaching as far south as to include the small town of Capena. But at the beginning of the historical period, *i.e.* from the beginning of the 5th century B.C., and no doubt earlier, the dominant element in the town was Etruscan; and all through the wars of the following centuries the town was counted a member, and sometimes a leading member, of the Etruscan league (cf. Livy iv. 23, v. 17, vii. 17).

In spite of the Etruscan domination, the Faliscans preserved many traces of their Italic origin, such as the worship of the deities Juno Quiritis (Ovid, *Fasti*, vi. 49) and Feronia (Livy xxvi. 11), the cult of *Dis Soranus* by the *Hirpi* or fire-leaping priests on Mount Soracte (Pliny, *Nat. Hist.* vii. 2, 19; Servius, *ad Aen.* xi. 785, 787), above all their language. This is preserved for us in some 36 short inscriptions, dating from the 3rd and 2nd centuries B.C., and is written in a peculiar alphabet derived from the Etruscan, and written from right to left, but showing some traces of the influence of the Latin alphabet. Its most characteristic signs are—

Я a, ꝥ z, ↑ l, Я r, ꝥ i

As a specimen of the dialect may be quoted the words written round the edge of a picture on a patera, the genuineness of which is established by the fact that they were written before the glaze was put on: "foied vino pipafo, cra carefo," *i.e.* in Latin "hodie vinum bibam, cras carebo" (R. S. Conway, *Italic Dialects*, p. 312, b). This shows some of the phonetic characteristics of the Faliscan dialect, *viz.*—

1. The retention of medial *f* which in Latin became *b*;
 2. The representation of an initial *Ind.-Eur. gh* by *f* (*foied*, contrast Latin *hodie*);
 3. The palatalization of *d* + consonant *i* into some sound denoted merely by *i*—the central sound of *foied*, from *fo-died*;
 4. The loss of final *s*, at all events before certain following sounds (*cra* beside Latin *crās*);
- Other characteristics, appearing elsewhere, are:
5. The retention of the velars (Fal. *quando* = Latin *quando*; contrast Umbrian *pan(n)u*);
 6. The assimilation of some final consonants to the initial letter of the next word: "pretod de zenatuo sententiad (Conway, *lib. cit.* 321), *i.e.* "praetor de senatus sententia" (*zenatuo* for *senatuos.*, an archaic genitive). For further details see Conway, *ib.* pp. 370 ff., especially pp. 384-385, where the relation of the names *Falisci*, *Falerii* to the local hero *Halaesus* (*e.g.* Ovid, *Fasti*, iv. 73) is discussed, and where reason is given for thinking that the change of initial *f* (from an original *bh* or *dh*) into an initial *h* was a genuine mark of Faliscan dialect.

It seems probable that the dialect lasted on, though being gradually permeated with Latin, till at least 150 B.C.

In addition to the remains found in the graves (see **FALERII**), which belong mainly to the period of Etruscan domination and give ample evidence of material prosperity and refinement, the earlier strata have yielded more primitive remains from the Italic epoch. A large number of inscriptions consisting mainly of proper names may be regarded as Etruscan rather than Faliscan, and they have been disregarded in the account of the dialect just given. It should perhaps be mentioned that there was a town Feronia in Sardinia, named probably after their native goddess by Faliscan settlers, from some of whom we have a votive inscription found at S. Maria di Falleri (Conway, *ib.* p. 335).

Further information may be sought from W. Deecke, *Die Falisker* (a useful but somewhat uncritical collection of the evidence accessible in 1888); E. Bormann, in *C.I.L.* xi. pp. 465 ff., and Conway, *op. cit.* (R. S. C.)

FALK, JOHANN DANIEL (1768-1826), German author and philanthropist, was born at Danzig on the 28th of October 1768. After attending the gymnasium of his native town, he entered the university of Halle with the view of studying theology, but preferring a non-professional life, gave up his theological studies and went to live at Weimar. There he published a volume of satires which procured him the notice and friendship of Wieland, and admission into literary circles. After the battle of Jena, Falk, on the recommendation of Wieland, was appointed to a civil post under the French official authorities and rendered his townsmen such good service that the duke of Weimar created him a counsellor of legation. In 1813 he established a society for friends in necessity (*Gesellschaft der Freunde in der Not*), and about the same time founded an institute for the care and education of neglected and orphan children, which, in 1829, was taken over by the state and still exists as the *Falksches Institut*. The first literary efforts of Falk took the form chiefly of satirical poetry, and gave promise of greater future excellence than was ever completely fulfilled; his later pieces, directed more against individuals than the general vices and defects of society, gradually degenerated in quality. In 1806 Falk founded a critical journal under the title of *Elysium und Tartarus*. He also contributed largely to contemporary journals. He enjoyed the acquaintance and intimate friendship of Goethe, and his account of their intercourse was posthumously published under the title *Goethe aus näherem persönlichen Umgange dargestellt* (1832) (English by S. Austin). Falk died on the 14th of February 1826.

Falk's *Satirische Werke* appeared in 7 vols. (1817 and 1826); his *Auserlesene Schriften* (3 vols., 1819). See *Johannes Falk: Erinnerungsblätter aus Briefen und Tagebüchern, gesammelt von dessen Tochter Rosalie Falk* (1868); Heinzelmann, *Johannes Falk und die Gesellschaft der Freunde in der Not* (1879); A. Stein, *J. Falk* (1881); S. Schultze, *Falk und Goethe* (1900).

FALK, PAUL LUDWIG ADALBERT (1827–1900), German politician, was born at Matschkau, Silesia, on the 10th of August 1827. In 1847 he entered the Prussian state service, and in 1853 became public prosecutor at Lyck. In 1858 he was elected a deputy, joining the Old Liberal party. In 1868 he became a privy-councillor in the ministry of justice. In 1872 he was made minister of education, and in connexion with Bismarck's policy of the Kultur-kampf he was responsible for the famous May Laws against the Catholics (see GERMANY: *History*). In 1879 his position became untenable, owing to the death of Pius IX. and the change of German policy with regard to the Vatican, and he resigned his office, but retained his seat in the Reichstag till 1882. He was then made president of the supreme court of justice at Hamm, where he died in 1900.

FALKE, JOHANN FRIEDRICH GOTTLIEB (1823–1876), German historian, was born at Ratzeburg on the 20th of April 1823. Entering the university of Erlangen in 1843, he soon began to devote his attention to the history of the German language and literature, and in 1848 went to Munich, where he remained five years, and diligently availed himself of the use of the government library for the purpose of prosecuting his historical studies. In 1856 he was appointed secretary of the German museum at Nuremberg, and in 1859 keeper of the manuscripts. With the aid of the manuscript collections in the museum he now turned his attention chiefly to political history, and, with Johann H. Müller, established an historical journal under the name of *Zeitschrift für deutsche Kulturgeschichte* (4 vols., Nuremberg, 1856–1859). To this journal he contributed a history of German taxation and commerce. On the latter subject he published separately *Geschichte des deutschen Handels* (2 vols., Leipzig, 1859–1860) and *Die Hansa als deutsche See-und Handelsmacht* (Berlin, 1862). In 1862 he was appointed secretary of the state archives at Dresden, and, a little later, keeper. He there began the study of Saxon history, still devoting his attention chiefly to the history of commerce and economy, and published *Die Geschichte des Kurfürsten August von Sachsen in volkswirtschaftlicher Beziehung* (Leipzig, 1868) and *Geschichte des deutschen Zollwesens* (Leipzig, 1869). He died at Dresden on the 2nd of March 1876.

FALKIRK, a municipal and police burgh of Stirlingshire, Scotland. Pop. (1891) 19,769; (1901) 29,280. It is situated on high ground overlooking the fertile Carse of Falkirk, 11 m. S.E. of Stirling, and about midway between Edinburgh and Glasgow. Grangemouth, its port, lies 3 m. to the N.E., and the Forth & Clyde Canal passes to the north, and the Union Canal to the south of the town. Falkirk now comprises the suburbs of Laurieston (E.), Grahamston and Bainsford (N.), and Camelon (W.). The principal structures include the burgh and county buildings, town hall, the Dollar free library and Camelon fever hospital. The present church, with a steeple 146 ft. high, dates only from 1811. In the churchyard are buried Sir John Graham, Sir John Stewart who fell in the battle of 1298, and Sir Robert Munro and his brother, Dr Duncan Munro, killed in the battle of 1746. The town is under the control of a council with provost and bailies, and combines with Airdrie, Hamilton, Lanark and Linlithgow (the Falkirk group of burghs) to return a member to parliament. The district is rich in coal and iron, which supply the predominant industries, Falkirk being the chief seat of the light casting trade in Scotland; but tanning, flour-milling, brewing, distilling and the manufacture of explosives (Nobel's) and chemicals are also carried on. Trysts or sales of cattle, sheep and horses are held thrice a year (August, September and October) on Stenhousemuir, 3 m. N.W. They were transferred hither from Crieff in 1770, and were formerly the most important in the kingdom, but have to a great extent been replaced by the local weekly auction marts. Carron, 2 m. N.N.W., is famous for the iron-works established in 1760 by Dr John Roebuck (1718–1794), whose advising engineers were successively John Smeaton and James Watt. The short iron guns of large calibre designed by General Robert Melville, and first cast in 1779, were called carronades from this their place of manufacture.

Falkirk is a town of considerable antiquity. Its original name

was the Gaelic *Eaglais breac*, "church of speckled or mottled stone," which Simeon of Durham (fl. 1130) transliterated as Eggesbreth. By the end of the 13th century appears the form Faukirke (the present local pronunciation), which is merely a translation of the Gaelic *fau* or *faw*, meaning "dun," "pale red." The first church was built by Malcolm Canmore (d. 1093). Falkirk was made a burgh of barony in 1600 and a burgh of regality in 1646, but on the forfeiture of the earl of Linlithgow in 1715, its superiority was vested in the crown. Callender House, immediately to the S., was the seat of the earl and his ancestors. The mansion was visited by Queen Mary, captured by Cromwell, and occupied by Generals Monk and Hawley. The wall of Antoninus ran through the grounds, and the district is rich in Roman remains, Camelon, about 2 m. W., being the site of a Roman settlement; Merchiston Hall, to the N.W., was the birthplace of Admiral Sir Charles Napier. The eastern suburb of Laurieston was first called Langtoun, then Merchistown, and received its present name after Sir Lawrence Dundas of Kerse, who had promoted its welfare. At Polmont, farther east, which gives the title of baron to the duke of Hamilton, is the school of Blair Lodge, besides coal-mines and other industries.

Battles of Falkirk.—The battle of the 22nd of July 1298 was fought between the forces of King Edward I. of England and those of the Scottish national party under Sir William Wallace. The latter, after long baffling the king's attempts to bring him to battle, had taken up a strong position south of the town behind a morass. They were formed in four deep and close masses ("schiltrons") of pikemen, the light troops screening the front and flanks and a body of men-at-arms standing in reserve. It was perhaps hoped that the English cavalry would plunge into the morass, for no serious precautions were taken as to the flanks, but in any case Wallace desired no more than to receive an attack at the halt, trusting wholly to his massed pikes. The English right wing first appeared, tried the morass in vain, and then set out to turn it by a long détour; the main battle under the king halted in front of it, while the left wing under Antony Bec, bishop of Durham, was able to reach the head of the marsh without much delay. Once on the enemy's side of the obstacle the bishop halted to wait for Edward, who was now following him, but his undisciplined barons, shouting "'Tis not for thee, bishop, to teach us war. Go say mass!" drove off the Scottish archers and men-at-arms and charged the nearest square of pikes, which repulsed them with heavy losses. On the other flank the right wing, its flank march completed, charged with the same result. But Edward, who had now joined the bishop with the centre or "main battle," peremptorily ordered the cavalry to stand fast, and, taught by his experience in the Welsh wars, brought up his archers. The longbow here scored its first victory in a pitched battle. Before long gaps appeared in the close ranks of pike heads, and after sufficient preparation Edward again launched his men-at-arms to the charge. The shaken masses then gave way one after the other, and the Scots fled in all directions.

The second battle of Falkirk, fought on the 17th of January 1746 between the Highlanders under Prince Charles and the British forces under General Hawley, resulted in the defeat of the latter. It is remarkable only for the bad conduct of the British dragoons and the steadiness of the infantry. Hawley retreated to Linlithgow, leaving all his baggage, 700 prisoners and seven guns in the enemy's hands.

FALKLAND, LUCIUS CARY, 2ND VISCOUNT (c. 1610–1643), son of Sir Henry Cary, afterwards 1st Viscount Falkland (d. 1633), a member of an ancient Devonshire family, who was lord deputy of Ireland from 1622 to 1629, and of Elizabeth (1585–1639), only daughter of Sir Lawrence Tanfield, chief baron of the exchequer, was born either in 1609 or 1610, and was educated at Trinity College, Dublin. In 1625 he inherited from his grandfather the manors of Great Tew and Burford in Oxfordshire, and, about the age of 21, married Lettice, daughter of Sir Richard Morrison, of Tooley Park in Leicestershire. Involved in a quarrel with his father, whom he failed to propitiate by

offering to hand over to him his estate, he left England to take service in the Dutch army, but soon returned. In 1633, by the death of his father, he became Viscount Falkland. His mother had embraced the Roman Catholic faith, to which it was now sought to attract Falkland himself, but his studies and reflections led him, under the influence of Chillingworth, to the interpretation of religious problems rather by reason than by tradition or authority. At Great Tew he enjoyed a short but happy period of study, and he assembled round him many gifted and learned men, whom the near neighbourhood of the university and his own brilliant qualities attracted to his house. He was the friend of Hales and Chillingworth, was celebrated by Jonson, Suckling, Cowley and Waller in verse, and in prose by Clarendon, who is eloquent in describing the virtues and genius of the "incomparable" Falkland, and draws a delightful picture of his society and hospitality.

Falkland's intellectual pleasures, however, were soon interrupted by war and politics. He felt it his duty to take part on the king's side as a volunteer under Essex in the campaign of 1639 against the Scots. In 1640 he was returned for Newport in the Isle of Wight to the Short and Long Parliaments, and took an active part on the side of the opposition. He spoke against the exaction of shipmoney on the 7th of December 1640, denouncing the servile conduct of Lord Keeper Finch and the judges.¹ He supported the prosecution of Strafford, at the same time endeavouring on more than one occasion to moderate the measures of the Commons in the interests of justice, and voted for the third reading of the attainder on the 21st of April 1641. On the great question of the church he urged, in the debate of the 8th of February 1641, that the interference of the clergy in secular matters, the encroachments in jurisdiction of the spiritual courts, and the imposition by authority of unnecessary ceremonies, should be prohibited. On the other hand, though he denied that episcopacy existed *jure divino*, he was opposed to its abolition; fearing the establishment of the Presbyterian system, which in Scotland had proved equally tyrannical. Triennial parliaments would be sufficient to control the bishops, if they meditated any further attacks upon the national liberties, and he urged that "where it is not necessary to change, it is necessary not to change." Even Hampden still believed that a compromise with the episcopal principle was possible, and assured Falkland that if the bill taken up to the Lords on the 1st of May 1641, excluding the bishops from the Lords and the clergy from secular offices, were passed, "there would be nothing more attempted to the prejudice of the church." Accordingly the bill was supported by Falkland. The times, however, were not favourable to compromise. The bill was lost in the Lords, and on the 27th of May the Root and Branch Bill, for the total abolition of episcopacy, was introduced in the House of Commons. This measure Falkland opposed, as well as the second bill for excluding the bishops, introduced on the 21st of October. In the discussion on the Grand Remonstrance he took the part of the bishops and the Arminians. He was now opposed to the whole policy of the opposition, and, being reproached by Hampden with his change of attitude, replied "that he had formerly been persuaded by that worthy gentleman to believe many things which he had since found to be untrue, and therefore he had changed his opinion in many particulars as well as to things as to persons."²

On the 1st of January 1642, immediately before the attempted arrest of the five members, of which, however, he was not cognizant, he was offered by the king the secretaryship of state, and was persuaded by Hyde to accept it, thus becoming involved directly in the king's policy, though evidently possessing little influence in his counsels. He was one of the peers who signed the protestation against making war, at York on the 15th of June 1642. On the 5th of September he carried Charles's overtures for peace to the parliament, when he informed the leaders of the opposition that the king consented to a thorough reformation of religion. The secret correspondence connected with the Waller plot passed through his hands. He was present with the

king at Edgehill and at the siege of Gloucester. By this time the hopelessness of the situation had completely overwhelmed him. The aims and principles of neither party in the conflict could satisfy a man of Falkland's high ideals and intellectual vision. His royalism could not suffer the substitution, as the controlling power in the state, of a parliament for the monarchy, nor his conservatism the revolutionary changes in church and state now insisted upon by the opposite faction. The fatal character and policy of the king, the most incapable of men and yet the man upon whom all depended, must have been by now thoroughly understood by Falkland. Compromise had long been out of the question. The victory of either side could only bring misery; and the prolongation of the war was a prospect equally unhappy. Nor could Falkland find any support or consolation in his own inward convictions or principles. His ideals and hopes were now destroyed, and he had no definite political convictions such as inspired and strengthened Strafford and Pym. In fact his sensitive nature shrank from contact with the practical politics of the day and prevented his rise to the place of a leader or a statesman. Clarendon has recorded his final relapse into despair. "Sitting amongst his friends, often, after a deep silence and frequent sighs (he) would with a shrill and sad accent ingeminate the word *Peace, Peace*, and would passionately profess that the very agony of the war, and the view of the calamities and desolation the kingdom did and must endure, took his sleep from him and would shortly break his heart." At Gloucester he had in vain exposed himself to risks. On the morning of the battle of Newbury, on the 20th of September 1643, he declared to his friends, who would have dissuaded him from taking part in the fight, that "he was weary of the times and foresaw much misery to his own Country and did believe he should be out of it ere night."³ He served during the engagement as a volunteer under Sir John Byron, and, riding alone at a gap in a hedge commanded by the enemy's fire, was immediately killed.

His death took place at the early age of 33, which should be borne in mind in every estimate of his career and character. He was succeeded in the title by his eldest son Lucius, 3rd Viscount Falkland, his male descent becoming extinct in the person of Anthony, 5th viscount, in 1694, when the viscountcy passed to Lucius Henry (1687-1730), a descendant of the first viscount, and the present peer is his direct descendant.

Falkland wrote a *Discourse of Infallibility*, published in 1646 (*Thomason Tracts*, E 361 [1]), reprinted in 1650, in 1651 (E 634 [1]) ed. by Triplet with replies, and in 1660 with the addition of two discourses on episcopacy by Falkland. This is a work of some importance in theological controversy, the general argument being that "to those who follow their reason in the interpretation of the Scriptures God will either give his grace for assistance to find the truth or his pardon if they miss it. And then this supposed necessity of an infallible guide (with the supposed damnation for the want of it) fall together to the ground." Also *A Letter ... 30 Sept. 1642 concerning the late conflict before Worcester* (1642); and *Poems*, in which he shows himself a follower of Ben Jonson, edited by A. B. Grosart in *Miscellanies of the Fuller Worthies Library*, vol. iii. (1871).

The chief interest in Falkland does not lie in his writings or in the incidents of his career, but in his character and the distinction of his intellectual position, in his isolation from his contemporaries seeking reformation in the inward and spiritual life of the church and state and not in its outward and material form, and as the leader and chief of rationalism in an age dominated by violent intolerance and narrow dogmatism. His personal appearance, according to Clarendon, was insignificant, "in no degree attractive or promising. His stature was low and smaller than most men; his motion not graceful ... but that little person and small stature was quickly found to contain a great heart. . . all mankind could not but admire and love him."⁴

AUTHORITIES.—There is a *Life and Times* by J. A. R. Marriott (1907); see also S. R. Gardiner's *Hist. of England; Hist. of the Civil War*; the same author's article in the *Dict. of Nat. Biography*

¹ His speeches are in the *Thomason Tracts*, E 196 (9), (26), (36).

² Clarendon's *Hist.* iv. 94, note.

³ Whitelocke, p. 73.

⁴ *Life*, i. 37.

and references there given; Clarendon's *Hist. of the Rebellion*, *passim* and esp. vii. 217-234; Clarendon's *Life*; *Rational Theology . . . in the 17th Century*, by John Tulloch (1874), i. 76; *Life of Lady Falkland from a MS. in the imperial library at Lille* (1861); *Life of the same* by Lady Georgiana Fullerton (1883); Jonson's *Ode Pindaric to the memory and friendship of . . . Sir Lucius Cary and Sir Henry Morrison*; W. J. Courthope, *History of English Poetry* (1903), iii. 291; *Life of Falkland*, by W. H. Trale in the *Englishman's Library*, vol. 22 (1842); D. Lloyd, *Memoires* (1668), 331; and the *Life of Falkland*, by Lady M. T. Lewis in *Lives of the Friends . . . of Lord Chancellor Clarendon*, vol. i. p. 3. John Duncan's account of Lettice, Lady Falkland, was edited in 1908 by M. F. Howard. (P. C. Y.)

FALKLAND, a royal and police burgh of Fifeshire, Scotland. Pop. (1901) 809. It is situated at the northern base of the hill of East Lomond (1471 ft. high), 2½ m. from Falkland Road station (with which there is communication by 'bus), on the North British railway company's main line to Dundee, 21 m. N. of Edinburgh as the crow flies. It is an old-world-looking place, many of the ancient houses still standing. Its industries are chiefly concerned with the weaving of linen and the brewing of ale, for which it was once specially noted; and it has few public buildings save the town hall. The palace of the Stuarts, however—more beautiful than Holyrood and quite as romantic—lends the spot its fame and charm. The older edifice that occupied this site was a hunting-tower of the Macduffs, earls of Fife, and was transferred with the earldom in 1371 to Robert Stewart, earl of Fife and Menteith, afterwards duke of Albany, second son of Robert II. Because of his father's long illness and the incapacity of Robert III., his brother Albany was during many years virtual ruler of Scotland, and, in the hope of securing the crown, caused the heir-apparent—David, duke of Rothesay—to be conveyed to the castle by force and there starved to death, in 1402. The conversion of the Thane's tower into the existing palace was begun by James III. and completed in 1538. The western part had two round towers, similar to those at Holyrood, which were also built by James V., and the southern elevation was ornamented with niches and statues, giving it a close resemblance to the Perpendicular style of the semi-ecclesiastical architecture of England. The palace soon became the favourite summer residence of the Stuarts. From it James V. when a boy fled to Stirling by night from the custody of the earl of Angus, and in it he died in 1542.

Here, too, Queen Mary spent some of her happiest days, playing the country girl in its parks and woods. When the court was held at Falkland the Green was the daily scene of revelry and dance, and "To be Falkland bred" was a proverb that then came into vogue to designate a courtier. James VI. delighted in the palace and especially in the deer. He upset the schemes of the Gowrie conspirators by escaping from Falkland to St Andrews, and it was while His Majesty was residing in the palace that the fifth earl of Bothwell, in 1592, attempted to kidnap him. In September 1596 an intensely dramatic interview took place in the palace between the king and Andrew Melville and other Presbyterian ministers sent by the general assembly at Cupar to remonstrate with him on allowing the Roman Catholic lords to return to Scotland. In 1654 the eastern wing was accidentally destroyed by fire, during its tenancy by the soldiers of Cromwell, by whose orders the fine old oaks in the park were cut down for the building of a fort at Perth. Even in its neglected state the mansion impressed Defoe, who declared the Scottish kings owned more palaces than their English brothers. In 1715 Rob Roy garrisoned the palace and failed not to levy dues on the burgh and neighbourhood. Signs of decay were more evident when Thomas Carlyle saw it, for he likened it to "a black old bit of coffin or protrusive shin-bone striking through the soil of the dead past." But a munificent protector at length appeared in the person of the third marquess of Bute, who acquired the estate and buildings in 1888, and forthwith undertook the restoration of the palace.

Falkland became a royal burgh in 1458 and its charter was renewed in 1595, and before the earlier date it had been a seat of the Templars. It gives the title of viscount to the English family of Cary, the patent having been granted in 1620 by James VI.

The town's most distinguished native was Richard Camcron, the Covenanter. His house—a three-storeyed structure with yellow harled front and thatched roof—still stands on the south side of the square in the main street. The Hackstons of Rathillet also had a house in Falkland.

FALKLAND ISLANDS (Fr. *Malouines*; Span. *Malvinas*), a group of islands in the South Atlantic Ocean, belonging to Britain, and lying about 250 m. E. of the nearest point in the mainland of South America, between 51° and 53° S., and 57° 40' and 61° 25' W. With the uninhabited dependency of South Georgia Island, to the E.S.E., they form the most southerly colony of the British empire. The islands, inclusive of rocks and reefs, exceed 100 in number and have a total area of 6500 sq. m.; but only two are of considerable size; the largest of these, East Falkland, is 95 m. in extreme length, with an average width of 40 m., and the smaller, West Falkland, is 80 m. long and about 25 m. wide. The area of East Falkland is about 3000 sq. m., and that of West Falkland 2300. Most of the others are mere islets, the largest 16 m. long by 8 m. wide. The two principal islands are separated by Falkland Sound, a narrow strait from 18 to 2½ m. in width, running nearly N.E. and S.W. The general appearance of the islands is not unlike that of one of the outer Hebrides. The general colouring, a faded brown, is somewhat dreary, but the mountain heights and promontories of the west display some grandeur of outline. The coast-line of both main islands is deeply indented and many of the bays and inlets form secure and well-protected harbours, some of which, however, are difficult of access to sailing ships.

East Falkland is almost bisected by two deep fjords, Choiseul and Brenton Sounds, which leave the northern and southern portions connected only by an isthmus a mile and a half wide. The northern portion is hilly, and is crossed by a rugged range, the Wickham Heights, running east and west, and rising in some places to a height of nearly 2000 ft. The remainder of the island consists chiefly of low undulating ground, a mixture of pasture and morass, with many shallow freshwater tarns, and small streams running in the valleys. Two fine inlets, Berkeley Sound and Port William, run far into the land at the north-eastern extremity of the island. Port Louis, formerly the seat of government, is at the head of Berkeley Sound, but the anchorage there having been found rather too exposed, about the year 1844 a town was laid out, and the necessary public buildings were erected on Stanley Harbour, a sheltered recess within Port William. West Falkland is more hilly near the east island; the principal mountain range, the Hornby Hills, runs north and south parallel with Falkland Sound. Mount Adam, the highest hill in the islands, is 2315 ft. high.

The little town of Stanley is built along the south shore of Stanley harbour and stretches a short way up the slope; it has a population of little more than 900. The houses, mostly white with coloured roofs, are generally built of wood and iron, and have glazed porches, gay with fuchsias and pelargoniums. Government House, grey, stone-built and slated, calls to mind a manse in Shetland or Orkney. The government barrack is a rather imposing structure in the middle of the town, as is the cathedral church to the east, built of stone and buttressed with brick. Next to Stanley the most important place on East Falkland is Darwin on Choiseul Sound—a village of Scottish shepherds and a station of the Falkland Island Company.

The Falkland Islands consist entirely, so far as is known, of the older Palaeozoic rocks, Lower Devonian or Upper Silurian, slightly metamorphosed and a good deal crumpled and distorted, in the low grounds clay slate and soft sandstone, and on the ridges hardened sandstone passing into the conspicuous white quartzites. There do not seem to be any minerals of value, and the rocks are not such as to indicate any probability of their discovery. Galena is found in small quantity, and in some places it contains a large percentage of silver. The dark bituminous layers of clay slate, which occur intercalated among the quartzites, have led, here as elsewhere, to the hope of coming upon a seam of coal, but it is contrary to experience that coal of any value should be found in rocks of that age.

Many of the valleys in the Falklands are occupied by pale glistening masses which at a little distance much resemble small glaciers. Examined more closely these are found to be vast accumulations of blocks of quartzite, irregular in form, but having a tendency to a rude diamond shape, from 2 to 20 ft. in length, and half as much in width, and of a thickness corresponding with that of the quartzite ridges on the hills above. The blocks are angular, and rest irregularly one upon another, supported in all positions by the angles and edges of those beneath. The whole mass looks as if it were, as it is, slowly sliding down the valley to the sea. These "stone runs" are looked upon with great wonder by the shifting population of the Falklands, and they are shown to visitors with many strange speculations as to their mode of formation. Their origin is attributed by some to the moraine formation of former glaciers. Another out of many theories¹ is that the hard beds of quartzite are denuded by the disintegration of the softer layers. Their support being removed they break away in the direction of natural joints, and the fragments fall down the slope upon the vegetable soil. This soil is spongy, and, undergoing alternate contraction and expansion from being alternately comparatively dry and saturated with moisture, allows the heavy blocks to slip down by their own weight into the valley, where they become piled up, the valley stream afterwards removing the soil from among and over them.

The Falkland Islands correspond very nearly in latitude in the southern hemisphere with London in the northern, but the climatic influences are very different. The temperature is equable, the average of the two midsummer months being about 47° Fahr., and that of the two midwinter months 37° Fahr. The extreme frosts and heats of the English climate are unknown, but occasional heavy snow-falls occur, and the sea in shallow inlets is covered with a thin coating of ice. The sky is almost constantly overcast, and rain falls, mostly in a drizzle and in frequent showers, on about 250 days in the year. The rainfall is not great, only about 20 in., but the mean humidity for the year is 80, saturation being 100. November is considered the only dry month. The prevalent winds from the west, south-west and south blow continuously, at times approaching the force of a hurricane. "A region more exposed to storms both in summer and winter it would be difficult to mention" (Fitzroy, *Voyages of "Adventure" and "Beagle,"* ii. 228). The fragments of many wrecks emphasize the dangers of navigation, which are increased by the absence of beacons, the only lighthouse being that maintained by the Board of Trade on Cape Pembroke near the principal settlement. Kelp is a natural danger-signal, and the sunken rock, "Uranie," is reputed to be the only one not buoyed by the giant seaweed.

Of aboriginal human inhabitants there is no trace in the Falklands, and the land fauna is very scanty. A small wolf, the *loup-renard* of de Bougainville, is extinct, the last having been seen about 1875 on the West Falkland. Some herds of cattle and horses run wild; but these were, of course, introduced, as were also the wild hogs, the numerous rabbits and the less common hares. All these have greatly declined in numbers, being profitably replaced by sheep. Land-birds are few in kind, and are mostly strays from South America. They include, however, the snipe and military starling, which on account of its scarlet breast is locally known as the robin. Sea-birds are abundant, and, probably from the islands having been comparatively lately peopled, they are singularly tame. Gulls and amphibious birds abound in large variety; three kinds of penguin have their rookeries and breed here, migrating yearly for some months to the South American mainland. Stray specimens of the great king penguin have been observed, and there are also mollymauks (a kind of albatross), Cape pigeons and many carrion birds. Kelp and upland geese abound, the latter being edible; and their shooting affords some sport.

The Falkland Islands form essentially a part of Patagonia, with which they are connected by an elevated submarine plateau,

¹ See B. Stechele, in *Münchener geographische Studien*, xx. (1906), and *Geographical Journal* (December 1907).

and their flora is much the same as that of Antarctic South America. The trees which form dense forest and scrub in southern Patagonia and in Fuegia are absent, and one of the largest plants on the islands is a gigantic woolly ragweed (*Senecio candicans*) which attains in some places a height of 3 to 4 ft. A half-shrubby veronica (*V. decussata*) is found in some parts, and has also received cultivation. The greater part of the "camp" (the open country) is formed of peat, which in some places is of great age and depth, and at the bottom of the bed very dense and bituminous. The peat is different in character from that of northern Europe: cellular plants enter but little into its composition, and it is formed almost entirely of the roots and stems of *Empetrum rubrum*, a variety of the common crowberry of the Scottish hills with red berries, called by the Falklanders the "diddle-dee" berry; of *Myrtus nummularia*, a little creeping myrtle whose leaves are used by the shepherds as a substitute for tea; of *Caltha appendiculata*, a dwarf species of marsh-marigold; and of some sedges and sedge-like plants, such as *Astelia pumila*, *Gaimardia australis* and *Bostkovia grandiflora*. Peat is largely used as fuel, coal being obtained only at a cost of £3 a ton.

Two vegetable products, the "balsam bog" (*Bolar glebaria*) and the "tussock grass" (*Dactylis caespitosa*) have been objects of curiosity and interest ever since the first accounts of the islands were given. The first is a huge mass of a bright green colour, living to a great age, and when dead becoming of a grey and stony appearance. When cut open, it displays an infinity of tiny leaf-buds and stems, and at intervals there exudes from it an aromatic resin, which from its astringent properties is used by the shepherds as a vulnerary, but has not been converted to any commercial purpose. The "tussock grass" is a wonderful and most valuable natural production, which, owing to the introduction of stock, has become extinct in the two main islands, but still flourishes elsewhere in the group. It is a reed-like grass, which grows in dense tufts from 6 to 10 ft. high from stool-like root-crowns. It forms excellent fodder for cattle, and is regularly gathered for that purpose. It is of beautiful appearance, and the almost tropical profusion of its growth may have led to the early erroneous reports of the densely-wooded nature of these islands.

The population slightly exceeds 2000. The large majority of the inhabitants live in the East Island, and the predominating element is Scottish—Scottish shepherds having superseded the South American Gauchos. In 1867 there were no settlers on the west island, and the government issued a proclamation offering leases of grazing stations on very moderate terms. In 1868 all the available land was occupied. These lands are fairly healthy, the principal drawback being the virulent form assumed by simple epidemic maladies. The occupation of the inhabitants is almost entirely pastoral, and the principal industry is sheep-farming. Wool forms by far the largest export, and tallow, hides, bones and frozen mutton are also exported. Trade is carried on almost entirely with the United Kingdom; the approximate annual value of exports is £120,000, and of imports a little more than half that sum. The Falkland Islands Company, having its headquarters at Stanley and an important station in the camp at Darwin, carries on an extensive business in sheep-farming and the dependent industries, and in the general import trade. The development of this undertaking necessitated the establishment of stores and workshops at Stanley, and ships can be repaired and provided in every way; a matter of importance since not a few vessels, after suffering injury during heavy weather off Cape Horn, call on the Falklands in distress. The maintenance of the requisite plant and the high wages current render such repairs somewhat costly. A former trade in oil and sealskin has decayed, owing to the smaller number of whales and seals remaining about the islands. Communications are maintained on horseback and by water, and there are no roads except at Stanley. There is a monthly mail to and from England, the passage occupying about four weeks.

The Falkland Islands are a crown colony, with a governor and executive and legislative councils. The legislative council

consists of the governor and three official and two unofficial nominated members, and the executive of the same, with the exception that there is only one unofficial member. The colony is self-supporting, the revenue being largely derived from the drink duties, and there is no public debt. The Falklands are the seat of a colonial bishop. Education is compulsory. The government maintains schools and travelling teachers; the Falkland Islands Company also maintains a school at Darwin, and there is one for those of the Roman Catholic faith in Stanley. There is also on Keppel Island a Protestant missionary settlement for the training in agriculture of imported Fuegians. Stanley was for some years a naval station, but ceased to be so in 1904.

The Falkland Islands were first seen by Davis in the year 1592, and Sir Richard Hawkins sailed along their north shore in 1594. The claims of Amerigo Vespucci to a previous discovery are doubtful. In 1598 Sebald de Wert, a Dutchman, visited them, and called them the Sebald Islands, a name which they bear on some Dutch maps. Captain Strong sailed through between the two principal islands in 1690, landed upon one of them, and called the passage Falkland Sound, and from this the group afterwards took its English name. In 1764 the French explorer De Bougainville took possession of the islands on behalf of his country, and established a colony at Port Louis on Berkeley Sound. But in 1767 France ceded the islands to Spain, De Bougainville being employed as intermediary. Meanwhile in 1765 Commodore Byron had taken possession on the part of England on the ground of prior discovery, and had formed a settlement at Port Egmont on the small island of Saunders. The Spanish and English settlers remained in ignorance, real or assumed, of each other's presence until 1769-1770, when Byron's action was nearly the cause of a war between England and Spain, both countries having armed fleets to contest the barren sovereignty. In 1771, however, Spain yielded the islands to Great Britain by convention. As they had not been actually colonized by England, the republic of Buenos Aires claimed the group in 1820, and subsequently entered into a dispute with the United States of America concerning the rights to the products of these islands. On the representations of Great Britain the Buenos Aires withdrew, and the British flag was once more hoisted at Port Louis in 1833, and since that time the Falkland Islands have been a regular British colony.

In 1845 Mr S. Lafone, a wealthy cattle and hide merchant on the river Plate, obtained from government a grant of the southern portion of the island, a peninsula 600,000 acres in extent, and possession of all the wild cattle on the island for a period of six years, for a payment of £10,000 down, and £20,000 in ten years from January 1, 1852. In 1851 Mr Lafone's interest in Lafonia, as the peninsula came to be called, was purchased for £30,000 by the Falkland Islands Company, which had been incorporated by charter in the same year.

See Pernetz, *Journal historique d'une voyage faite aux îles Malouines en 1763 et 1764* (Berlin, 1767); S. Johnson, *Thoughts on the late Transactions respecting Falkland's Islands* (1771); L. A. de Bougainville, *Voyage autour du monde* (1771); T. Falkner, *Description of Patagonia and the Falkland Islands* (1774); B. Penrose, *Account of the last Expedition to Port Egmont in the Falkland Islands* (1775); *Observations on the Forcible Occupation of Malvinas by the British Government in 1833* (Buenos Ayres, 1833); *Reclamacion del Gobierno de las provincias Unidas de la Plata contra el de S.M. Britanica sobre la soberania y posesion de las Islas Malvinas* (London, 1841); Fitzroy, *Narrative of the Surveying Voyage of H.M.S. "Adventure" and "Beagle"* (1839); Darwin, *Voyage of a Naturalist round the World* (1845); S. B. Sullivan, *Description of the Falkland Islands* (1849); W. Hadfield, *Brazil, the Falkland Islands, &c.* (1854); W. Parker Snow, *Two Years' Cruise off the Tierra del Fuego, the Falkland Islands, &c.* (1857); Sir C. Wyville Thomson, *Voyage of the "Challenger"* (1877); C. P. Lucas, *Historical Geography of the British Colonies*, vol. ii. "The West Indies" (Oxford, 1890); *Colonial Reports Annual*; MS. Sloane, 3295.

FALLACY (Lat. *fall-ax*, apt to mislead), the term given generally to any mistaken statement used in argument; in Logic, technically, an argument which violates the laws of correct demonstration. An argument may be fallacious in *matter* (i.e. misstatement of facts), in *wording* (i.e. wrong use of

words), or in the *process of inference*. Fallacies have, therefore, been classified as: I. Material, II. Verbal, III. Logical or Formal; II. and III. are often included under the general description *Logical*, and in scholastic phraseology, following Aristotle, are called fallacies *in dictione* or *in voce*, as opposed to material fallacies *in re* or *extra dictionem*.

I. *Material*.—The classification widely adopted by modern logicians and based on that of Aristotle, *Organon* (*Sophistici elenchi*), is as follows:—(1) *Fallacy of Accident*, i.e. arguing erroneously from a general rule to a particular case, without proper regard to particular conditions which vitiate the application of the general rule; e.g. if manhood suffrage be the law, arguing that a criminal or a lunatic must, therefore, have a vote; (2) *Converse Fallacy of Accident*, i.e. arguing from a special case to a general rule; (3) *Irrelevant Conclusion*, or *Ignoratio Elenchi*, wherein, instead of proving the fact in dispute, the arguer seeks to gain his point by diverting attention to some extraneous fact (as in the legal story of "No case. Abuse the plaintiff's attorney"). Under this head come the so-called *argumentum* (a) *ad hominem*, (b) *ad populum*, (c) *ad baculum*, (d) *ad verecundiam*, common in platform oratory, in which the speaker obscures the real issue by appealing to his audience on the grounds of (a) purely personal considerations, (b) popular sentiment, (c) fear, (d) conventional propriety. This fallacy has been illustrated by ethical or theological arguments wherein the fear of punishment is subtly substituted for abstract right as the sanction of moral obligation. (4) *Petitio principii* (begging the question) or *Circulus in probando* (arguing in a circle), which consists in demonstrating a conclusion by means of premises which presuppose that conclusion. Jeremy Bentham points out that this fallacy may lurk in a single word, especially in an epithet, e.g. if a measure were condemned simply on the ground that it is alleged to be "un-English"; (5) *Fallacy of the Consequent*, really a species of (3), wherein a conclusion is drawn from premises which do not really support it; (6) *Fallacy of False Cause*, or *Non Sequitur* ("it does not follow"), wherein one thing is incorrectly assumed as the cause of another, as when the ancients attributed a public calamity to a meteorological phenomenon; (7) *Fallacy of Many Questions* (*Plurimum Interrogationum*), wherein several questions are improperly grouped in the form of one, and a direct categorical answer is demanded, e.g. if a prosecuting counsel asked the prisoner "What time was it when you met this man?" with the intention of eliciting the tacit admission that such a meeting had taken place.

II. *Verbal Fallacies* are those in which a false conclusion is obtained by improper or ambiguous use of words. They are generally classified as follows. (1) *Equivocation* consists in employing the same word in two or more senses, e.g. in a syllogism, the middle term being used in one sense in the major and another in the minor premise, so that in fact there are *four* not *three* terms ("All fair things are honourable; This woman is fair; therefore this woman is honourable," the second "fair" being in reference to complexion). (2) *Amphibology* is the result of ambiguity of grammatical structure, e.g. of the position of the adverb "only" in careless writers ("He only said that," in which sentence, as experience shows, the adverb has been intended to qualify any one of the other three words). (3) *Composition*, a species of (1), which results from the confused use of collective terms ("The angles of a triangle are less than two right angles" might refer to the angles separately or added together). (4) *Division*, the converse of the preceding, which consists in employing the middle term distributively in the minor and collectively in the major premise. (5) *Accent*, which occurs only in speaking and consists of emphasizing the wrong word in a sentence ("He is a fairly good pianist," according to the emphasis on the words, may imply praise of a beginner's progress, or an expert's depreciation of a popular hero, or it may imply that the person in question is a deplorable violinist). (6) *Figure of Speech*, the confusion between the metaphorical and ordinary uses of a word or phrase.

III. The purely *Logical* or *Formal* fallacies consist in the violation of the formal rules of the Syllogism (*q.v.*). They are

(a) fallacy of Four Terms (*Quaternio terminarum*); (b) of Undistributed Middle; (c) of Illicit process of the major or the minor term; (d) of Negative Premises.

Of other classifications of Fallacies in general the most famous are those of Francis Bacon and J. S. Mill. Bacon (*Novum organum*, Aph. i. 33, 38 sqq.) divided fallacies into four *Idola* (Idols, i.e. False Appearances), which summarize the various kinds of mistakes to which the human intellect is prone (see BACON, FRANCIS). With these should be compared the *Offendicula* of Roger Bacon, contained in the *Opus maius*, pt. i. (see BACON, ROGER). J. S. Mill discussed the subject in book v. of his *Logic*, and Jeremy Bentham's *Book of Fallacies* (1824) contains valuable remarks.

See Rd. Whately's *Logic*, bk. v.; A. de Morgan, *Formal Logic* (1847); A. Sidgwick, *Fallacies* (1883) and other text-books. See also article LOGIC, and for fallacies of Induction, see INDUCTION.

FALLIÈRES, CLÉMENT ARMAND (1841-), president of the French republic, was born at Mézin in the department of Lot-et-Garonne, where his father was clerk of the peace. He studied law and became an advocate at Nérac, beginning his public career there as municipal councillor (1868), afterwards mayor (1871), and as councillor-general of the department of Lot-et-Garonne (1871). Being an ardent Republican, he lost this position in May 1873 upon the fall of Thiers, but in February 1876 was elected deputy for Nérac. In the chamber he sat with the Republican Left, signed the protestation of the 18th of May 1877, and was re-elected in October by his constituency. In 1880 he became under-secretary of state in the department of the interior in the Jules Ferry ministry (May 1880 to November 1881). From the 7th of August 1882 to the 20th of February 1883 he was minister of the interior, and for a month (from the 29th of January 1883) was premier. His ministry had to face the question of the expulsion of the pretenders to the throne of France, owing to the proclamation by Prince Jérôme Napoleon (January 1883), and M. Fallières, who was ill at the time, was not able to face the storm of opposition, and resigned when the senate rejected his project. In the following November, however, he was chosen as minister of public instruction by Jules Ferry, and carried out various reforms in the school system. He resigned with the ministry in March 1885. Again becoming minister of the interior in the Rouvier cabinet in May 1887, he exchanged his portfolio in December for that of justice. He returned to the ministry of the interior in February 1889, and finally took the department of justice from March 1890 to February 1892. In June 1890 his department (Lot-et-Garonne) elected him to the senate by 417 votes to 23. There M. Fallières remained somewhat apart from party struggles, although maintaining his influence among the Republicans. In March 1899 he was elected president of the senate, and retained that position until January 1906, when he was chosen by a union of the groups of the Left in both chambers as candidate for the presidency of the republic. He was elected on the first ballot by 449 votes against 371 for his opponent, Paul Doumer.

FALL-LINE, in American geology, a line marking the junction between the hard rocks of the Appalachian Mountains and the softer deposits of the coastal plain. The pre-Cambrian and metamorphic rocks of the mountain mass form a continuous ledge parallel to the east coast, where they are subject to denudation and form a series of "falls" and rapids in the river courses all along this line. The relief of the land below the falls is very slight, and this low country rarely rises to a height of 200 ft., so that the rivers are navigable up to the falls, while the falls themselves are a valuable source of power. A line of cities may be traced upon the map whose position will thus be readily understood in relation to the economic importance of the fall-line. They are Trenton on the Delaware, Philadelphia on the Schuylkill, Georgetown on the Potomac, Richmond on the James, and Augusta on the Savannah. It will be readily understood that the softer and more recent rocks of the coastal plain have been more easily washed away, while the harder rocks of the mountains, owing to differential denudation, are left standing high above them, and that the trend of the edge of this great lenticular

mass of ancient rock is roughly parallel to that of the Appalachian system.

FALLMERAYER, JAKOB PHILIPP (1790-1861), German traveller and historical investigator, best known for his opinions in regard to the ethnology of the modern Greeks, was born, the son of a poor peasant, at Tschötsch, near Brixen in Tirol, on the 10th of December 1790. In 1809 he absconded from the cathedral choir school at Brixen and made his way to Salzburg, where he supported himself by private teaching while he studied theology, the Semitic languages, and history. After a year's study he sought to assure to himself the peace and quiet necessary for a student's life by entering the abbey of Kremsmünster, but difficulties put in his way by the Bavarian officials prevented the accomplishment of this intention. At the university of Landshut, to which he removed in 1812, he first applied himself to jurisprudence, but soon devoted his attention exclusively to history and philology. His immediate necessities were provided for by a rich patron. During the Napoleonic wars he joined the Bavarian infantry as a subaltern in 1813, fought at Hanau (30th October 1813), and served throughout the campaign in France. He remained in the army of occupation on the banks of the Rhine until Waterloo, when he spent six months at Orleans as adjutant to General von Spreiti. Two years of garrison life at Lindau on Lake Constance after the peace were spent in the study of modern Greek, Persian and Turkish.

Resigning his commission in 1818, he was successively engaged as teacher in the gymnasium at Augsburg and in the progymnasium and lyceum at Landshut. In 1827 he won the gold medal offered by the university of Copenhagen with his *Geschichte des Kaisertums von Trapezunt*, based on patient investigation of Greek and oriental MSS. at Venice and Vienna. The strictures on priestcraft contained in the preface to this book gave offence to the authorities, and his position was not improved by the liberal views expressed in his *Geschichte der Halbinsel Morea während des Mittelalters* (Stuttgart, 1830-1836, 2 pts.). The three years from 1831 to 1834 he spent in travel with the Russian count Ostermann Tolstoy, visiting Egypt, Palestine, Syria, Cyprus, Rhodes, Constantinople, Greece and Naples. On his return he was elected in 1835 a member of the Royal Bavarian Academy of Sciences, but he soon after left the country again on account of political troubles, and spent the greater part of the next four years in travel, spending the winter of 1839-1840 with Count Tolstoy at Geneva. Constantinople, Trebizond, Athos, Macedonia, Thessaly and Greece were visited by him during 1840-1841; and after some years' residence in Munich he returned in 1847 to the East, and travelled in Palestine, Syria and Asia Minor. The authorities continued to regard him with suspicion, and university students were forbidden to attend the lectures he delivered at Munich. He entered, however, into friendly relations with the crown prince Maximilian, but this intimacy was destroyed by the events following on 1848. At that period he was appointed professor of history in the Munich University, and made a member of the national congress at Frankfort-on-Main. He there joined the left or opposition party, and in the following year he accompanied the rump-parliament to Stuttgart, a course of action which led to his expulsion from his professorate. During the winter of 1849-1850 he was an exile in Switzerland, but the amnesty of April 1850 enabled him to return to Munich. He died on the 26th of April 1861.

His contributions to the medieval history of Greece are of great value, and though his theory that the Greeks of the present day are of Albanian and Slav descent, with hardly a drop of true Greek blood in their veins, has not been accepted in its entirety by other investigators, it has served to modify the opinions of even his greatest opponents. A criticism of his views will be found in Hopf's *Geschichte Griechenlands* (reprinted from Ersch and Gruber's *Encykl.*) and in Finlay's *History of Greece in the Middle Ages*. Another theory which he propounded and defended with great vigour was that the capture of Constantinople by Russia was inevitable, and would lead to the absorption by the Russian empire of the whole of the Balkan and Grecian

peninsula; and that this extended empire would constitute a standing menace to the western Germanic nations. These views he expressed in a series of brilliant articles in German journals. His most important contribution to learning remains his history of the empire of Trebizond. Prior to his discovery of the chronicle of Michael Panaretos, covering the dominion of Alexus Comnenus and his successors from 1204 to 1426, the history of this medieval empire was practically unknown.

His works are—*Geschichte des Kaiserthums Trapezunt* (Munich, 1827–1848); *Geschichte der Halbinsel Morea im Mittelalter* (Stuttgart, 1830–1836); *Über die Entstehung der Neugriechen* (Stuttgart, 1835); "Originalfragmente, Chroniken, u.s.w., zur Geschichte des K. Trapezunts" (Munich, 1843), in *Abhandl. der hist. Classe der K. Bayerisch. Akad. v. Wiss.*; *Fragmente aus dem Orient* (Stuttgart, 1845); *Denkschrift über Golgotha und das heilige Grab* (Munich, 1852), and *Das Todte Meer* (1853)—both of which had appeared in the *Abhandlungen* of the Academy; *Das albanesische Element in Griechenland*, iii. parts, in the *Abhandl.* for 1860–1866. After his death there appeared at Leipzig in 1861, under the editorship of G. M. Thomas, three volumes of *Gesammelte Werke*, containing *Neue Fragmente aus dem Orient*, *Kritische Versuche*, and *Studien und Erinnerungen aus meinem Leben*. A sketch of his life will also be found in L. Steub, *Herbsttage in Tyrol* (Munich, 1867).

FALLOPIUS (or **FALLOPIO**), **GABRIELLO** (1523–1562), Italian anatomist, was born about 1523 at Modena, where he became a canon of the cathedral. He studied medicine at Ferrara, and, after a European tour, became teacher of anatomy in that city. He thence removed to Pisa, and from Pisa, at the instance of Cosmo I., grand-duke of Tuscany, to Padua, where, besides the chairs of anatomy and surgery and of botany, he held the office of superintendent of the new botanical garden. He died at Padua on the 9th of October 1562. Only one treatise by Fallopius appeared during his lifetime, namely the *Observationes anatomicae* (Venice, 1561). His collected works, *Opera genuina omnia*, were published at Venice in 1584. (See ANATOMY.)

FALLOUX, FRÉDÉRIC ALFRED PIERRE, COMTE DE (1811–1886), French politician and author, was born at Angers on the 11th of May 1811. His father had been ennobled by Charles X., and Falloux began his career as a Legitimist and clerical journalist under the influence of Mme Swetchine. In 1846 he entered the legislature as deputy for Maine-et-Loire, and with many other ultra-Catholics he gave real or pretended support to the revolution of 1848. Louis Napoleon made him minister of education in 1849, but disagreements with the president led to his resignation within a year. He had nevertheless secured the passage of the Loi Falloux (March 15, 1850) for the organization of primary and secondary education. This law provided that the clergy and members of ecclesiastical orders, male and female, might exercise the profession of teaching without producing any further qualification. This exemption was extended even to priests who taught in secondary schools, where a university degree was exacted from lay teachers. The primary schools were put under the management of the curés. Falloux was elected to the French Academy in 1856. His failure to secure re-election to the legislature in 1866, 1869, 1870 and 1871 was due to the opposition of the stricter Legitimists, who viewed with suspicion his attempts to reconcile the Orleans princes with Henri, comte de Chambord. In spite of his failure to enter the National Assembly his influence was very great, and was increased by the intimacy of his personal relations with Thiers. But in 1872 he offended both sections of the monarchical party at a conference arranged in the hope of effecting a fusion between the partisans of the comte de Chambord and of the Orleans princes, divided on the vexed question of the flag. He suggested that the comte de Chambord might recede from his position with dignity at the desire of the National Assembly, and not content with this encroachment on royalist principles, he insinuated the possibility of a transitional stage with the duc d'Aumale as president of the republic. His disgrace was so complete that he was excommunicated by the bishop of Angers in 1876. He died on the 16th of January 1886.

Of his numerous works the best known are his *Histoire de Louis XVI* (1840); *Histoire de Saint Pie* (1845); *De la contre-revolution* (1876); and the posthumous *Mémoires d'un royaliste* (2 vols., 1888).

FALLOW, land ploughed and tilled, but left unsown, usually for a year, in order, on the one hand, to disintegrate, aerate and free it from weeds, and, on the other, to allow it to recuperate. The word was probably early confused with "fallow" (from O. Eng. *fealu*, probably cognate with Gr. *πολιός*, grey), of a pale-brown or yellow colour, often applied to soil left untilled and unsown, but chiefly seen in the name of the "fallow deer." The true derivation is from the O. Eng. *fealga*, only found in the plural, a harrow, and the ultimate origin is a Teutonic root meaning "to plough," cf. the German *falgen*. The recognition that continuous growing of wheat on the same area of land robs the soil of its fertility was universal among ancient peoples, and the practice of "fallowing" or resting the soil is as old as agriculture itself. The "Sabbath rest" ordered to be given every seventh year to the land by the Mosaic law is a classical instance of the "fallow." Improvements in crop rotations and manuring have diminished the necessity of the "bare fallow," which is uneconomical because the land is left unproductive, and because the nitrates in the soil unintercepted by the roots of plants are washed away in the drainage waters. At the present time bare fallowing is, in general, only advisable on stiff soils and in dry climates. A "green fallow" is land planted with turnips, potatoes or some similar crop in rows, the space between which may be cleared of weeds by hoeing. The "bastard fallow" is a modification of the bare fallow, effected by the growth of rye, vetches, or some other rapidly growing crop, sown in autumn and fed off in spring, the land then undergoing the processes of ploughing, grubbing and harrowing usual in the bare fallow.

FALLOW-DEER (that is, **DUN DEER**, in contradistinction to the red deer, *Cervus [Dama] dama*), a medium-sized representative of the family *Cervidae*, characterized by its expanded or palmated antlers, which generally have no bez-tine, rather long tail (black above and white below), and a coat spotted with white in summer but uniformly coloured in winter. The shoulder height is about 3 ft. The species is semi-domesticated in British parks, and occurs wild in western Asia, North Africa, the south of Europe and Sardinia. In prehistoric times it occurred throughout northern and central Europe. One park-breed has no spots. Bucks and does live apart except during the pairing-season; and the doe produces one or two, and sometimes three fawns at a birth. These deer are particularly fond of horse-chestnuts, which the stags are said to endeavour to procure by striking at the branches with their antlers. The Persian fallow-deer (*C. [D.] mesopotamicus*), a native of the mountains of Luristan, is larger than the typical species, and has a brighter coat, differing in some details of colouring. The antlers have the trez-tine near the small brow-tine, and the palmation beginning near the former. Here may be mentioned the gigantic fossil deer commonly known as the Irish elk, which is perhaps a giant type of fallow-deer, and if so should be known as *Cervus (Dama) giganteus*. If a distinct type, its title should be *C. (Megaceros) giganteus*. This deer inhabited Ireland, Great Britain, central and northern Europe, and western Asia in Pleistocene and prehistoric times; and must have stood 6 ft. high at the shoulder. The antlers are greatly palmated and of enormous size, fine specimens measuring as much as 11 ft. between the tips.

FALL RIVER, a city of Bristol county, Massachusetts, U.S.A., situated on Mount Hope Bay, at the mouth of the Taunton river, 49 m. S. of Boston. Pop. (1890) 74,398; (1900) 104,863; (estimated, 1906) 105,942;¹ (1910 census) 119,295. It is the third city in size of the commonwealth. Of the population in 1900, 50,042, or 47.7%, were foreign-born, 90,244 were of foreign parentage (i.e. either one or both parents were foreign), and of these 81,721 had both foreign father and foreign mother. Of the foreign-born, 20,172 were French Canadians, 2329 were English Canadians, 12,268 were from England, 1045 were from Scotland, 7317 were from Ireland, 2805 were from Portugal, and 1095 were from Russia, various other countries being represented by smaller

¹ The small increase between 1900 and 1906 was due in large part to the emigration of many of the inhabitants during the great strike of 1904–1905.

numbers. Fall River is served by the New York, New Haven & Hartford railway, and has good steamer connexions with Providence, Newport and New York, notably by the "Fall River Line," which is much used, in connexion with the N.Y., N.H.& H. railway, by travellers between New York and Boston. The harbour is large, deep and easy of access. The city lies on a plateau and on slopes that rise rather steeply from the river, and is irregularly laid out. Granite underlying the city furnishes excellent building material; among the principal buildings are the state armoury, the county court house, the B.M.C. Durfee high school, the custom house, Notre Dame College, the church of Notre Dame, the church of St Anne, the Central Congregational church and the public library. The commonwealth aids in maintaining a textile school (the Bradford Durfee textile school), opened in 1904. The city library contained in 1908 about 78,500 volumes. There is considerable commerce, but it is as a manufacturing centre that Fall River is best known. Above the city, on the plateau, about 2 m. from the bay, are the Watuppa Lakes, 7 m. long and on an average three-fourths of a mile wide, and from them runs the Fall (Quequechan) river, with a constant flow and descending near its mouth through 127 ft. in less than half a mile. The conjunction of water transportation and water power is thus remarkable, and accounts in great part for the city's rapid growth. The waters of the North Watuppa Lake (which is fed by springs and drains out a very small area) are also exceptionally pure and furnish an excellent water-supply. The Fall river runs directly through the city (passing beneath the city hall), and along its banks are long rows of cotton mills; formerly many of these were run by water power, and their wheels were placed directly in the stream bed, but steam power is now used almost exclusively. According to the special census of manufactures of 1905, the value of all factory products for the calendar year 1904 was \$43,473,105, of which amount \$35,442,581, or 81.5%, consisted of cotton goods and dyeing and finishing, making Fall River the largest producer of cotton goods among American cities.¹ A large hat manufactory (the Marshall Brothers' factory) furnishes the United States army with hats. Until forced by the competition of mills in the Southern states to direct attention to finer products, the cotton manufacturers of Fall River devoted themselves almost exclusively to the making of print cloth, in which respect the city was long distinguished from Lawrence and Lowell, whose products were more varied and of higher grade. The number of spindles increased from 265,328 in 1865 to 1,269,043 in 1875, 3,000,000 in 1900, and to about 3,500,000 in 1906. Excellent drainage and sewerage systems contribute to the city's health. The birth-rate was in 1900 the highest (38.75) of any city in the country of above 30,000 inhabitants (three of the four next highest being Massachusetts towns). The social conditions and labour problems of Fall River have long been exceptional. The mills supplement the public schools in the mingling of races and the work for Americanization, and labour disturbances, for which Fall River was once conspicuous, have become less frequent and less bitter, the great strike of 1904-1905—perhaps the greatest in the history of the textile industry in the United States—being marked by little or no violence. Fall River has become a "city of homes," and tenements are giving way to dwellings for one or two families. The lists of the city's corporation stockholders show more than 10,000 names. The municipal police is controlled (as nowhere else in the state save in Boston) by a state board; this arrangement is generally regarded as having worked for better order. Lowell was about three times as large as Fall River in 1850, and Lawrence was larger until after 1870. Fall River was originally a part of Freetown; it was incorporated as a township in 1803 (being known as "Troy" in 1804-1834), and was chartered as a city in 1854. In 1861 it was increased by certain territory secured from Rhode Island,

¹ The above figures do not show adequately the full importance of Fall River as a cotton manufacturing centre, for during six months of the census year the great strike was in progress; this strike, caused by a reduction in wages, lasted from the 25th of July 1904 to the 18th of January 1905.

the city having spread across the state boundary and become subject to a divided jurisdiction. In 1902 the city received a new charter. Its manufactures amounted to little before the War of 1812. A disastrous fire occurred in 1843 (loss above \$500,000). In 1904 Fall River became the see of the Roman Catholic diocese of that name.

See H. H. Earl, *Centennial History of Fall River . . . 1656-1876* (New York, 1877); and the report of Carroll D. Wright on *Fall River, Lowell, and Lawrence*, in 13th annual report of the Massachusetts Bureau of Statistics of Labor (1882), which, however, was regarded as unjust and partial by the manufacturers of Fall River.

FALMOUTH, a municipal and contributory parliamentary borough and seaport of Cornwall, England, 306 m. W.S.W. of London, on a branch of the Great Western railway. Pop. (1901) 11,789. It is finely situated on the west shore of the largest of the many estuaries which open upon the south coast of the county. This is entered by several streams, of which the largest is the Fal. Falmouth harbour lies within Pendennis Point, which shelters the estuary from the more open Falmouth Bay. The Penryn river, coming in from the north-west, forms one of several shallow, winding arms of the estuary, the main channel of which is known as Carrick Roads. To the east Pendennis Castle stands on its lofty promontory, while on the opposite side of the roads the picturesque inlet of the Porthcuel river opens between Castle Point on the north, with St Mawes' Castle, and St Anthony Head and Zoze Point on the south. The shores of the estuary as a rule slope sharply up to about 250 ft., and are beautifully wooded. The entrance is 1 m. across, and the roads form one of the best refuges for shipping on the south coast, being accessible at all times by the largest vessels. Among the principal buildings and institutions in Falmouth are the town hall, market-house, hall of the Cornwall Polytechnic Society, a meteorological and magnetic observatory, and a submarine mining establishment. The Royal Cornwall Yacht Club has its headquarters here, and in the annual regatta the principal prize is a cup given by the prince of Wales as duke of Cornwall. Engineering, shipbuilding, brewing and the manufacture of manure are carried on, and there are oyster and trawl fisheries, especially for pilchard. The inner harbour, under the jurisdiction partly of commissioners and partly of a dock company, is enclosed between two breakwaters, of which the eastern has 23 ft. of water at lowest tides alongside. The area of the harbour is 42 acres, with nearly 700 lineal yards of quays. There are two graving docks, and repairing yards. Grain, timber, coal and guano and other manures are imported, and granite, china clay, copper ore, ropes and fish exported. Falmouth is also in favour as a watering-place. The parliamentary borough of Penryn and Falmouth returns one member. The municipal borough is under a mayor, 4 aldermen and 12 councillors. Area, 790 acres.

Falmouth (Falemuth) as a haven and port has had a place in the maritime history of Cornwall from very early times. The site of the town, which is comparatively modern, was formerly known as Smithick and Pennycomequick and formed part of the manor of Arwenack held by the family of Killigrew. The corporations of Penryn, Truro and Helston opposed the undertaking, but the lords in council, to whom the matter was referred, decided in Killigrew's favour. In 1652 the House of Commons considered that it would be advantageous to the Commonwealth to grant a Thursday market to Smithick. This market was confirmed to Sir Peter Killigrew in 1660 together with two fairs, on the 30th of October and the 27th of July, and also a ferry between Smithick and Flushing. By the charter of incorporation granted in the following year the name was changed to Falmouth, and a mayor, recorder, 7 aldermen and 12 burgesses constituted a common council with the usual rights and privileges. Three years later an act creating the borough a separate ecclesiastical parish empowered the mayor and aldermen to assess all buildings within the town at the rate of sixteen pence in the pound for the support of the rector. This rector's rate occasioned much ill-feeling in modern times, and by act of parliament in 1896 was taken over by the corporation, and provision made for its eventual extinction. The disfranchisement of Penryn, which

had long been a subject of debate in the House of Commons, was settled in 1832, by uniting Penryn with Falmouth for parliamentary purposes and assigning two members to the united boroughs. By the Redistribution of Seats Act 1885, the number of members was reduced to one. The fairs granted in 1660 are no longer held, and a Saturday market has superseded the chartered market. In the 17th and 18th centuries Falmouth grew in importance owing to its being a station of the Packet Service for the conveyance of mails.

FALSE POINT, a landlocked harbour in the Cuttack district of Bengal, India. It was reported by the famine commissioners in 1867 to be the best harbour on the coast of India from the Hugli to Bombay. It derives its name from the circumstance that vessels proceeding up the Bay of Bengal frequently mistook it for Point Palmyras, a degree farther north. The anchorage is safe, roomy and completely landlocked, but large vessels are obliged to lie out at some distance from its mouth in an exposed roadstead. The capabilities of False Point as a harbour remained long unknown, and it was only in 1860 that the port was opened. It was rapidly developed, owing to the construction of the Orissa canals. Two navigable channels lead inland across the Mahanadi delta, and connect the port with Cuttack city. The trade of False Point is chiefly with other Indian harbours, but a large export trade in rice and oil-seeds has sprung up with Mauritius, the French colonies and France. False Point is now a regular port of call for Anglo-Indian coasting steamers. Its capabilities were first appreciated during the Orissa famine of 1866, when it afforded almost the only means by which supplies of rice could be thrown into the province. A lighthouse is situated a little to the south of the anchorage, on the point which screens it from the southern monsoon.

FALSE PRETENCES, in English law, the obtaining from any other person by any false pretence any chattel, money or valuable security, with intent to defraud. It is an indictable misdemeanour under the Larceny Act of 1861. The broad distinction between this offence and larceny is that in the former the owner intends to part with his property, in the latter he does not. This offence dates as a statutory crime practically from 1756. At common law the only remedy originally available for an owner who had been deprived of his goods by fraud was an indictment for the crime of cheating, or a civil action for deceit. These remedies were insufficient to cover all cases where money or other properties had been obtained by false pretences, and the offence was first partially created by a statute of Henry VIII. (1541), which enacted that if any person should falsely and deceitfully obtain any money, goods, &c., by means of any false token or counterfeit letter made in any other man's name, the offender should suffer any punishment other than death, at the discretion of the judge. The scope of the offence was enlarged to include practically all false pretences by the act of 1756, the provisions of which were embodied in the Larceny Act 1861.

The principal points to notice are that the pretence must be a false pretence of some existing fact, made for the purpose of inducing the prosecutor to part with his property (*e.g.* it was held not to be a false pretence to promise to pay for goods on delivery), and it may be by either words or conduct. The property, too, must have been actually obtained by the false pretence. The owner must be induced by the pretence to make over the absolute and immediate ownership of the goods, otherwise it is "larceny by means of a trick." It is not always easy, however, to draw a distinction between the various classes of offences. In the case where a man goes into a restaurant and orders a meal, and, after consuming it, says that he has no means of paying for it, it was usual to convict for obtaining food by false pretences. But *R. v. Jones*, 1898, L.R. 1 Q.B. 119 decided that it is neither larceny nor false pretences, but an offence under the Debtors Act 1869, of obtaining credit by fraud. (See also CHEATING; FRAUD; LARCENY.)

United States.—American statutes on this subject are mainly copied from the English statutes, and the courts there in a general way follow the English interpretations. The statutes of each state must be consulted. There is no Federal statute, though

there are Federal laws providing penalties for false personation of the lawful owner of public stocks, &c., or of persons entitled to pensions, prize money, &c. (U.S. Rev. Stats. § 5435), or the false making of any order purporting to be a money order (*id.* § 5463).

In Arizona, obtaining money or property by falsely personating another is punishable as for larceny (Penal Code, 1901, § 479). Obtaining credit by false pretences as to wealth and mercantile character is punishable by six months' imprisonment and a fine not exceeding three times the value of the money or property obtained (*id.* § 481).

In Illinois, whoever by any false representation or writing signed by him, of his own respectability, wealth or mercantile correspondence or connexions, obtains credit and thereby defrauds any person of money, goods, chattels or any valuable thing, or who procures another to make a false report of his honesty, wealth, &c., shall return the money, goods, &c., and be fined and imprisoned for a term not exceeding one year (Crim. Code, 1903, ch. xxxviii. §§ 96, 97). Obtaining money or property by bogus cheques, the "confidence game" (*Dorr v. People*, 1907, § 228, Ill. 216), or "three card monte," sleight of hand, fortune-telling, &c., is punishable by imprisonment for from one to ten years (*id.* §§ 98, 100). Obtaining goods from warehouse, mill or wharf by fraudulent receipt wrongly stating amount of goods deposited—by imprisonment for not less than one nor more than ten years (*id.* § 124). Fraudulent use of railroad passes is a misdemeanour (*id.* 125a).

In Massachusetts it is simple larceny to obtain by false pretences the money or personal chattel of another (Rev. Laws, 1902, ch. ccviii. § 26). Obtaining by a false pretence with intent to defraud the signature of a person to a written instrument, the false making whereof would be forgery, is punishable by imprisonment in a state prison or by fine (*id.* § 27).

In New York, obtaining property by false pretences, felonious breach of trust and embezzlement are included in the term "larceny" (Penal Code, § 528; *Paul v. Dumar*, 106 N.Y. 508; *People v. Tattlekan*, 1907, 104 N.Y. Suppl. 805), but the methods of proof required to establish each crime remain as before the code. Obtaining lodging and food on credit at hotel or lodging house with intent to defraud is a misdemeanour (Pen. Code, § 382). Purchase of property by false pretences as to person's means or ability to pay is not criminal when in writing signed by the party to be charged (Pen. Code, § 544).

FALTICHENI (*Falticent*), the capital of the department of Suceava, Rumania, situated on a small right-hand tributary of the Sereth, among the hills of north-west Moldavia, and 2 m. S.E. of the frontier of Bukovina. Pop. (1900) 9643, about half being Jews. A branch railway runs for 15 m. to join the main line between Czernowitz in Bukovina, and Galatz. The Suceava department (named after Suceava or Suciava, its former capital, now Suzawa in Bukovina) is densely forested; its considerable timber trade centres in Falticheni. For five weeks, from the 20th July onwards, Russians and Austro-Hungarians, as well as Rumans, attend the fair which is held at Falticheni, chiefly for the sale of horses, carriages and cattle.

FALUN, a town of Sweden, capital of the district (*län*) of Kopparberg, 153 m. N.W. of Stockholm by rail. Pop. (1900) 9606. It is situated in a bare and rocky country near the western shore of lake Runn. Here are the oldest and most celebrated copper mines in Europe. Their produce has gradually decreased since the 17th century, and is now unimportant, but sulphate of copper, iron pyrites, and some gold, silver, sulphur and sulphuric acid, and red ochre are also produced. The mines belong to the Kopparberg Mining Company (*Stora Kopparbergs Bergslags Aktiebolag*, formerly *Kopparbergslagen*). This is the oldest industrial corporation in Sweden, and perhaps the oldest still existing in the world; it is known to have been established before 1347. Since its reorganization as a joint-stock company in 1890 many of the shares have been held by the crown, philanthropic institutions and other public bodies. The company also owns iron mines, limestone and quartz quarries, large iron-works at Domnarfvet and elsewhere, a great extent of forests and

saw-mills, and besides the output of the copper mines it produces manufactured iron and steel, timber, wood-pulp, bricks and charcoal. Falun has also railway rolling-stock factories. There are museums of mineralogy and geology, a lower school of mining, model room and scientific library. The so-called "Gothenburg System" of municipal control over the sale of spirits was actually devised at Falun as early as 1850.

FAMA (Gr. Φήμη, "Ὀσσα), in classical mythology, the personification of Rumour. The Homeric equivalent *Ossa* (*Iliad*, ii. 93) is represented as the messenger of Zeus, who spreads reports with the rapidity of a conflagration. Homer does not personify *PHEME*, which is merely a presage drawn from human utterances, whereas *Ossa* (until later times) is associated with the idea of divine origin. A more definite character is given to *PHEME* by Hesiod (*Works and Days*, 764), who calls her a goddess; in Sophocles (*Oed. Tyr.* 158) she is the immortal daughter of golden Hope and is styled by the orator Aeschines (*Contra Timarchum*, § 128) one of the mightiest of goddesses. According to Pausanias (i. 17. 1) there was a temple of *PHEME* at Athens, and at Smyrna (*ib.* ix. 11, 7), whose inhabitants were especially fond of seeking the aid of divination, there was a sanctuary of *CLEDONES* (sounds or rumours supposed to convey omens).

There does not seem to have been any cult of *FAMA* among the Romans, by whom she was regarded merely as "a figure of poetical religion." The Temple of Fame and Omen (*PHEME* and *CLEDON*) mentioned by Plutarch (*Moralia*, p. 319) is due to a confusion with *Aius Locutius*, the divinity who warned the Romans of the coming attack of the Gauls. There are well-known descriptions of *FAME* in Virgil (*Aeneid*, iv. 173) and Ovid (*Metam.* xii. 39); see also Valerius Flaccus (ii. 116), Statius (*Thebais*, iii. 425). An unfavourable idea gradually became attached to the name; thus Ennius speaks of *FAMA* as the personification of "evil" reputation and the opposite of *GLORIA* (cp. the adjective *famosus*, which is not used in a good sense till the post-Augustan age). Chaucer in his *House of Fame* is obviously imitating Virgil and Ovid, although he is also indebted to Dante's *Divina Commedia*.

FAMAGUSTA (Gr. *Ammochostos*), a town and harbour on the east coast of Cyprus, 2½ m. S. of the ruins of Salamis. The population in 1901 was 818, nearly all being Moslems who live within the walls of the fortress; the Christian population has migrated to a suburb called Varosia (pop. 2948). The foundation of Salamis (q.v.) was ascribed to Teucer: it was probably the most important town in early Cyprus. The revolt of the Jews under Trajan, and earthquakes in the time of Constantius and Constantine the Great helped in turn to destroy it. It was restored by Fl. Constantius II. (A.D. 337-361) as *Constantia*. Another town a little to the south, built by Ptolemy Philadelphus in 274 B.C., and called *Arsinoe* in honour of his sister, received the refugees driven from *Constantia* by the Arabs under Mu'awiyah, became the seat of the orthodox archbishopric, and was eventually known as *Famagusta*. It received a large accession of population at the fall of Acre in 1291; was annexed by the Genoese in 1376; reunited to the throne of Cyprus in 1464; and surrendered, after an investment of nearly a year, to the Turks in 1571. The fortifications, remodelled by the Venetians after 1489, the castle, the grand cathedral church of St. Nicolas, and the remains of the palace and many other churches make *Famagusta* a place of unique interest. Acts ii. and v. of Shakespeare's *Othello* pass there. In 1903 measures were taken to develop the fine natural harbour of *Famagusta*. Basins were dredged to give depths of 15 and 24 ft. respectively at ordinary low tides, and commodious jetties and quays were constructed.

FAMILIAR (through the Fr. *familier*, from Lat. *familiaris*, of or belonging to the *familia*, family), an adjective, properly meaning belonging to the family or household, but in this sense the word is rare. The more usual meanings are: friendly, intimate, well known; and from its application to the easy relations of intimate friends the term may be used in an invidious sense of "free and easy" conduct on the part of any one not justified by any close relationship, friendship or intimacy.

"Familiar" is, however, also used as a substantive, especially of the spirit or demon which attended on a wizard or magician, and was summoned to execute his master's wishes. The idea underlies the notion of the Christian guardian angel and of the Roman *genius natalis* (see **DEMONOLOGY**; **WITCHCRAFT**). In the Roman Church the term is applied to persons attached to the household of the pope or of bishops. These must actually do some domestic service. They are supported by their patron, and enjoy privileges which in the case of the papal familiars are considerable. "Familiars of the Holy Office" were lay officers of the Inquisition, whose functions were chiefly those of police, in making arrests, &c., of persons charged.

FAMILISTS, a term of English origin (later adopted in other languages) to denote the members of the *Familia Caritatis* (*Huis der Liefsten*; *Huis der Liefde*; *Haus der Liebe*; "Family of Love"), founded by Hendrik Niclaes (born on the 9th or 10th of January 1501 or 1502, probably at Münster; died after 1570, not later than 1581, probably in 1580). His calling was that of a merchant, in which he and his son Franz prospered, becoming ultimately wealthy. Not till 1540 did he appear in the character of one divinely endowed with "the spirit of the true love of Jesus Christ." For twenty years (1540-1560) Emden was the headquarters at once of his merchandise and of his propaganda; but he travelled in both interests to various countries, visiting England in 1552 or 1553. To this period belong most of his writings. His primary work was *Den Spiegel der Gherechticheit dorch den Geist der Liefden unde den vergodeden Mensch H.N. uth de hemmelische Warheit betüget*. It appeared in an English form with the author's revision, as *An Introduction to the holy Understanding of the Glasse of Righteousness* (1575?; reprinted in 1649). None of his works bear his name in full; his initials were mystically interpreted as standing for *Homo Novus*. His "glass of righteousness" is the spirit of Christ as interpreted by him. The remarkable fact was brought out by G. Arnold (and more fully by F. Nippold in 1862) that the printer of Niclaes's works was Christopher Plantin, of Antwerp, a specially privileged printer of Roman Catholic theology and liturgy, yet secretly a steadfast adherent of Niclaes. It is true that Niclaes claimed to hold an impartial attitude towards all existing religious parties, and his mysticism, derived from David Joris, was undogmatic. Yet he admitted his followers by the rite of adult baptism, and set up a hierarchy among them on the Roman model (see his *Evangelium Regni*, in English *A Joyfull Message of the Kingdom*, 1574?; reprinted, 1652). His pantheism had an antinomian drift; for himself and his officials he claimed impeccability; but, whatever truth there may be in the charge that among his followers were those who interpreted "love" as licence, no such charge can be sustained against the morals of Niclaes and the other leaders of the sect. His chief apostle in England was Christopher Vitel, a native of Delft, an "illuminated elder," living at Colchester and Southwark, who ultimately recanted. The society spread in the eastern counties, in spite of repressive measures; it revived under the Commonwealth, and lingered into the early years of the 18th century; the leading idea of its "service of love" was a reliance on sympathy and tenderness for the moral and spiritual edification of its members. Thus, in an age of strife and polemics, it seemed to afford a refuge for quiet, gentle spirits, and meditative temperaments.

See F. Nippold, "H. Niclaes u. das Haus der Liebe," in *Zeitschrift für die histor. Theol.* (1862); article "H. Niclaes" in A. J. van der Aa, *Biog. Woordenboek der Nederlanden* (1868); article "H. Nicholas," by C. Fell Smith, in *Dict. Nat. Biog.* (1894); article "Familisten," by Loofs, in *Herzog-Hauck's Realencyklopädie* (1898). (A. Go.*)

FAMILY, a word of which the etymology but partially illustrates the meaning. The Roman *familia*, derived from the Oscan *famel* (*servus*), originally signified the servile property, the thralls, of a master. Next, the term denoted other domestic property, in things as well as in persons. Thus, in the fifth of the laws of the Twelve Tables, the rules are laid down: *ST. INTERSTATO · MORITUR · CUI · SUUS · HERES · NEC · SIT · ADGNATUS ·*

PROXIMUS · FAMILIAM · HABETO, and SI · AGNATUS · NEC · ESCIT · GENTILIS · FAMILIAM · NANCITOR; that is, if a man die intestate, leaving no natural heir who had been under his *potestas*, the nearest agnate, or relative tracing his connexion with the deceased exclusively through males, is to inherit the *familia*, or family fortune of every sort. Failing an agnate, a member of the *gens* of the dead man is to inherit. In a third sense, *familia* was applied to all the persons who could prove themselves to be descended from the same ancestor, and thus the word almost corresponded to our own use of it in the widest meaning, as when we say that a person is "of a good family" (Ulpius, *Dig.* 50, 16, 195 *fin.*).

1. Leaving for awhile the Roman terms, to which it will be necessary to return, we may provisionally define Family, in the

Old theory.

modern sense, as the small community formed by the union of one man with one woman, and by the increase of children born to them. These in modern

times, and in most European countries, constitute the household, and it has been almost universally supposed that little natural associations of this sort are the germ-cell of early society. The Bible presents the growth of the Jewish nation from the one household of Abraham. His patriarchal family differed from the modern family in being polygamous, but, as female chastity was one of the conditions of the patriarchal family, and as descent through males was therefore recognized as certain, the plurality of wives makes no real difference to the argument. In the same way the earliest formal records of Indian, Greek and Roman society present the family as firmly established, and generally regarded as the most primitive of human associations. Thus, Aristotle derives the first household (*οἰκία πρώτη*) from the combination of man's possession of property—in the slave or in domesticated animals—with man's relation to woman, and he quotes Hesiod: *ὄικον μὲν πρόωιστα γυναικά τε βοῶν τ' ἀροτῆρα* (*Politics*, i. 2. 5). The village, again, with him is a colony or offshoot of the household, and monarchical government in states is derived from the monarchy of the eldest male member of the family. Now, though certain ancient terms, introduced by Aristotle in the chapters to which we refer, might have led him to imagine a very different origin of society, his theory is, on the face of it, natural and plausible, and it has been almost universally accepted. The beginning of society, it has been said a thousand times, is the family, a natural association of kindred by blood, composed of father, mother and their descendants. In this family, the father is absolute master of his wife, his children and the goods of the little community; at his death his eldest son succeeds him; and in course of time this association of kindred, by natural increase and by adoption, develops into the clan, *gens*, or *γένος*. As generations multiply, the more distant relations split off into other clans, and these clans, which have not lost the sense of primitive kinship, unite once more into tribes. The tribes again, as civilization advances, acknowledge themselves to be subjects of a king, in whose veins the blood of the original family runs purest. This, or something like this, is the common theory of the growth of society.

2. It was between 1866 and 1880 that the common opinion began to be seriously opposed. John Ferguson McLennan, in his

Modern criticism.

Primitive Marriage and his essays on *The Worship of Plants and Animals* (see his *Studies in Ancient History*, second series), drew attention to the wide prevalence of

the custom of inheriting the kinship name through mothers, not fathers; and to the law of "Exogamy" (*q.v.*). The former usage he attributed to archaic uncertainty as to fatherhood; the natural result of absolute sexual promiscuity, or of Polyandry (*q.v.*). Either practice is inconsistent, *prima facie*, with the primitive existence of the Family, whether polygamous or monogamous, whether patriarchal or modern. The custom of Exogamy, again,—here taken to mean the unwritten law which makes it incest, and a capital offence, to marry within the real or supposed kin denoted by the common name of the kinship,—pointed to an archaic condition of family affairs all unlike our Table of prohibited degrees. This law of Exogamy was found, among many savage races, associated with Totems, that is plants,

animals and other natural objects which give names to the various kinships, and are themselves, in various degrees, revered by members of the kinships. (See TOTEM AND TOTEMISM.) Traces of such kinships, and of Totemism, also of alleged promiscuity in ancient times, were detected by McLennan in the legends, folk-lore and institutions of Greece, Rome and India. Later, Prof. Robertson Smith found similar survivals, or possible survivals, among the Semitic races (*Kinship in Early Arabia*). Others have followed the same trail among the Celts (S. Reinach, *Cultes, mythes et religions*, 1904).

If arguments founded on these alleged survivals be valid, it may be that the most civilized races have passed through the stages of Exogamy, Totemism and reckoning descent in the female line. McLennan explained Exogamy as a result of scarcity of women, due to female infanticide. Women being scarce, the men of a group would steal them from other groups, and it would become shameful, and finally a deadly sin, for a man to marry within his own group-name, or name of kinship, say Wolf or Raven. Meanwhile, owing to scarcity of women, one woman would be the mate of many husbands (polyandry); hence, paternity being undetermined, descent would be reckoned through mothers.

Such are the outlines of McLennan's theory, which, as a whole, has been attacked by many writers, and is now, perhaps, accepted by none. McLennan's was the most brilliant

McLennan's value.

pioneer work; but his supply of facts was relatively scanty, and his friend Charles Darwin stated objections which to many seem final, as regards the past existence of a stage of sexual promiscuity. C. N. Starcke (*The Primitive Family*, 1889), Edward Alexander Westermarck (*History of Human Marriage*, 1891), Ernest Crawley (*The Mystic Rose*), Herbert Spencer, Emile Durkheim, Lord Avebury and many others, have criticized McLennan, who, however, in coining the term Exogamy, and drawing scientific attention to Totemism, and reckoning of kin through mothers, founded the study of early society. Here it must be observed that "Matriarchate" (*q.v.*) is a misleading term, as is "Gynaecocracy," for the custom of deducing descent on the spindle side. Women among totemistic and exogamous savages are in a degraded position, nor does the deriving and inheriting of the kinship name, or anything else, on the spindle side, imply any ignorance of paternal relations; even where, as among Central Australian tribes, the facts of reproduction are said to be unknown.

3. Simultaneous with McLennan's researches and speculations were the works of Lewis H. Morgan. He was the discoverer of a

Lewis Morgan.

custom very important in its bearing on the history of society. In about two-thirds of the globe, persons in addressing a kinsman do not discriminate between grades of relationship. All these grades are merged in large categories. Thus, in what Morgan calls the "Malayan system," "all *consanguinei*, near or far, fall within one of these relationships—grandparent, parent, brother, sister, child and grandchild." No other blood-relationships are recognized (*Ancient Society*). This at once reminds us of the Platonic Republic. "We devised means that no one should ever be able to know his own child, but that all should imagine themselves to be of one family, and should regard as brothers and sisters those who were within a certain limit of age; and those who were of an elder generation they were to regard as parents and grandparents, and those who were of a younger generation as children and grandchildren" (*Timaecus*, 18, Jowett's translation, first edition, vol. ii., 1871). This system prevails in the Polynesian groups and in New Zealand. Next comes what Morgan chooses to call the Turanian system. "It was universal among the North American aborigines," whom he styles Ganowanians. "Traces of it have been found in parts of Africa" (*Ancient Society*), and "it still prevails in South India among the Hindus, who speak the Dravidian language," and also in North India, among other Hindus. The system, Morgan says, "is simply stupendous." It is not exactly the same among all his miscellaneous "Turanians," but, on the whole, assumes the following shapes. Suppose the speaker to be a male, he will style his nephew and

niece in the male line, his brother's children, "son" and "daughter," and his grand-nephews and grand-nieces in the male line, "grandson" and "granddaughter." Here the Turanian and the Malayan systems agree. But change the sex; let the male speaker address his nephews and nieces in the female line,—the children of his sister,—he salutes them as "nephew" and "niece," and they hail him as "uncle." Now, in the Malay system, nephews and nieces on both sides, brother's children or sisters, are alike named "children" of the uncle. If the speaker be a female, using the Turanian style, these terms are reversed. Her sister's sons and daughters are saluted by her as "son" and "daughter," her brother's children she calls "nephew" and "niece." Yet the children of the persons thus styled "nephew" and "niece" are not recognized in conversation as "grand-nephew" and "grand-niece," but as "grandson" and "granddaughter." It is impossible here to do more than indicate these features of the classificatory nomenclature, from which the others may be inferred. The reader is referred for particulars to Morgan's *Systems of Consanguinity and Affinity of the Human Race*.

The existence of the classificatory system is not an entirely novel discovery. Nicolaus Damascenus, one of the inquirers into early society, who lived in the first century of our era, noticed this mode of address among the Galactophagi. Lafitau found it among the Iroquois. To Morgan's perception of the importance of the facts, and to his energetic collection of reports, we owe our knowledge of the wide prevalence of the system. From an examination of the degrees of kindred which seem to be indicated by the "Malayan" and "Turanian" modes of address, he has worked out a theory of the evolution of the modern family. A brief comparison of this with other modern theories will close our account of the family. The main points of the theory are shortly stated in *Systems of Consanguinity, &c.*, and in *Ancient Society*. From the latter work we quote the following description of the five different and successive forms of the family:—

"I. *The Consanguine Family*.—It was founded upon the intermarriage of brothers and sisters, own and collateral, in a group.

"II. *The Punaluan Family*.—It was founded upon the intermarriage of several sisters, own and collateral, with each others' husbands, in a group—the joint husbands not being necessarily kinsmen of each other; also, on the intermarriage of several brothers, own and collateral, with each others' wives in a group—these wives not being necessarily of kin to each other, although often the case in both instances (*sic*). In each case the group of men were conjointly married to the group of women.

"III. *The Syndyasmian or Pairing Family*.—It was founded upon marriage between single pairs, but without an exclusive cohabitation. The marriage continued during the pleasure of the parties.

"IV. *The Patriarchal Family*.—It was founded upon the marriage of one man with several wives, followed in general by the seclusion of the wives.

"V. *The Monogamian Family*.—It was founded upon marriage between single pairs with an exclusive cohabitation.

Three of these forms, namely, the first, second, and fifth, were radical, because they were sufficiently general and influential to create three distinct systems of consanguinity, all of which still exist in living forms. Conversely, these systems are sufficient of themselves to prove the antecedent existence of the forms of the family and of marriage with which they severally stand connected."

Morgan makes the systems of nomenclature proofs of the existence of the Consanguine and Punaluan families. Unhappily, there is no other proof, and the same systems have been explained on a very different principle (McLennan, *Studies in Ancient History*). Looking at facts, we find the Consanguine family nowhere, and cannot easily imagine how early groups abstained from infringing on each other, and created a systematic marriage of brothers and sisters. St Augustine, however (*De civ. Dei*, xv. 16), and Archinus in his *Thessalica (Odyssey*, xi. 7, scholia B, Q) agree more or less with Morgan. Next, how did the Consanguine family change into the Punaluan? Morgan says (*Ancient Society*) brothers ceased to marry their sisters, because "the evils of it could not for ever escape human observation." Thus the Punaluan family was hit upon, and "created a distinct system of consanguinity" (*Ancient Society*), the Turanian.

Again, "marriages in Punaluan groups explain the relationships in the system." But Morgan provides himself with another explanation, "the Turanian system owes its origin to marriage in the group and to the gentile organization." He calls exogamy "the gentile organization," though, in point of fact, the only gentes we know, the Roman gentes, show scarcely a trace of exogamy. Again, "the change of relationships which resulted from substituting Punaluan in the place of Consanguine marriage turns the Malayan into the Turanian system." On the same page Morgan attributes the change to the "gentile organization," and, still on the same page, uses *both* factors in his working out of the problem. Now, if the Punaluan marriage is a sufficient explanation, we do not need the "gentile organization." Both, in Morgan's opinion, were efforts of conscious moral reform. In *Systems of Consanguinity* the gentile organization (there called tribal), that is, exogamy, is said to have been "designed to work out a reformation in the intermarriage of brothers and sisters." But the Punaluan marriage had done that, otherwise it would not have produced (as Morgan says it did) the change from the Malayan to the Turanian system, the difference in the two systems, as exemplified in Seneca and Tamil, being "in the relationships which depended on the intermarriage or non-intermarriage of brothers and sisters" (*Ancient Society*). Yet the Punaluan family, though itself a reform in morals and in "breeding," "did not furnish adequate motives to reform the Malay system," which, as we have seen, it did reform. The Punaluan family, it is suspected, "frequently involved own brothers and sisters"; had it not been so, there would have been no need of a fresh moral reformation,—"the gentile organization." Yet even in the Punaluan family (*Ancient Society*) "brothers ceased to marry their own sisters." What, then, did the "gentile organization" do for men? As they had already ceased to marry their own sisters, and as, under the gentile organization, they were still able to marry their half-sisters, the reformatory "ingenuity" of the inventors of the organizations was at once superfluous and useless. It is impossible to understand the Punaluan system. Its existence is inferred from a system of nomenclature which it does (and does not) produce; it admits (and excludes) own brothers and sisters. Morgan has intended, apparently, to represent the Punaluan marriage as a long transition to the definite custom of exogamy, but it will be seen that his language is not very clear nor his positions assured. He does not adduce sufficient proof that the Punaluan family ever existed as an institution, even in Hawaii. There is, if possible, a greater absence of historical testimony to the existence of the Consanguine family. It is difficult to believe that exogamy was a conscious moral and social reformation, because, *ex hypothesi*, the savages had no moral data, nothing to cause disgust at relations which seem revolting to us. It is as improbable that they discovered the supposed physical evils of breeding in and in. That discovery could only have been made after a long experience, and in the Consanguine family that experience was impossible. Thus, setting moral reform aside as inconceivable, we cannot understand how the Consanguine families ever broke up. Morgan's ingenious speculations as to a transitional step towards the gens (as he calls what we style the totem-kindred), supposed to be found in the "classes" and marriage laws of the Kamilaroi, are vitiated by the weakness and contradictory nature of the evidence (see Pritchard; J. D. Lang's *Queensland*, Appendix; *Proceedings of American Academy of Arts, &c.*, vol. viii. 412; *Nature*, October 29, 1874). Further, though Morgan calls the Australian "gentile organization" "incipient," he admits (*Ancient Society*) that the Narrinyeri have totem groups, in which "the children are of the clan of the father." Far from being "incipient," the gens of the Narrinyeri is on the footing of the gotra of Hindu custom. Lastly, though Morgan frequently declares that the Polynesians have not the gens (for he thinks them not sufficiently advanced), W. W. Gill (*Myths and Songs from the South Pacific*, London, 1876) has shown that unmistakable traces of the totem survive in Polynesian mythology.

4. Morgan's theory was opposed by McLennan (*Studies in Ancient History*, 1876), who maintained that the names for

relationships, in the "classificatory system," were merely terms of address, as among ourselves when a preacher calls any adult male "brother," when an old woman is addressed as "mother," when an elder man calls a junior "my son." He also showed that his own system accounted for the terms. The controversy is still alive; one set of writers regarding the savage terms of relationship as indicating a state of things in which human beings dwelt in a "horde," with promiscuous intercourse; another set holding that the terms do not indicate consanguineous kinship, but degrees of age, status, and reciprocal obligations in a local *tribe*, and therefore that they do not yield any presumption that there was a past of promiscuity or of what is called "group marriage." On Morgan's side (not of course accepting all his details) are L. Fison and A. W. Howitt, and Baldwin Spencer and F. J. Gillen. Against him are Starcke, Westermarck, A. Lang, Dr Durkheim, apparently, Crawley and many others.

5. A second presumption in favour of original promiscuity has been drawn by the eminent Australian students, Baldwin Spencer and F. J. Gillen, and by A. W. Howitt, from the customs of some Australian aborigines. In each tribe, owing to customary laws which are to be examined later, only men and women of a given status are intermarriageable (*nupa*, *noa*, *unawa*) with each other. Though child-betrothals are usual, and though the woman is specialized to one man, who protects and nourishes her and all her children, and though their union is immediately preceded by an extended *jus primae noctis* (such as Herodotus describes among the Nasamones), yet, among certain tribes, the following custom prevails. At great meetings the tribal leaders assign a woman as paramour (with what amount of permanence remains obscure) to a man (*pirrauru*); one woman may have several *pirrauru* men, one man several *pirrauru* women, in addition to their regularly betrothed (*tippa malku*) wives and husbands. The husband occasionally shows fight, and bitter jealousies prevail, but, at the great ceremonial meetings, complaisance is enforced under penalty of strangling. Thenceforth, if the husband permits, the male *pirrauru* has matrimonial rights over the other man's *tippa malku* wife when they meet. A symbolic ceremony of union precedes the junction of the *pirrauru* people. This institution, as far as reported, is peculiar to a group of tribes near Lake Eyre, the Dieri, Urabunna, and their congeners,—or perhaps to all who have the same "phratry" names as the Dieri and Urabunna (*Kiraru* and *Matera*, in various dialectic forms).

Elsewhere the *pirrauru* custom is not known: but almost everywhere there are licentious festivals, in which all marriage rules except those which forbid incest (in our sense of the word, namely between the closest relations) are thrown to the winds. Also a native travelling among alien tribes is lent women of the status into which he may legally marry.

Baldwin Spencer and F. J. Gillen, and A. W. Howitt, regard *pirrauru* as "group marriage" and as a proof that, at one time, all intermarriageable people were actually husbands and wives, while the other examples of licence are also survivals, in a later stage of decay, of promiscuity, and "group marriage." To this it is replied that "group marriage" is a misnomer; that if *pirrauru* be in a sense marriage it is *status*, not *group* marriage. Again, it is urged, *pirrauru* is a modification of *tippa malku*, which comes first; a woman is "specialized" to a man *before* she can be made *pirrauru* to another, and her *tippa malku* husband continues to support her, and to recognize her children as his own, after she has become *pirrauru* to another man or other men. Without the foregoing *tippa malku* union, the *pirrauru* unions are not conceivable; they are mere legalized paramourships, modifying the *tippa malku* marriage (like the Italian *cicisbeismo*), procuring a protector for a woman in her husband's absence, and supplying legal loves for bachelors. The custom is peculiar to a given set of kindred tribes. The festivals are the legalized, restricted and more or less permanent modification of the casual orgies of feasts of licence, or *Saturnalia*, which have their analogies among many people, ancient and modern. *Pirrauru* is no more a survival

of and a proof of primitive promiscuity, than is the legalized incest of ancient Egypt or ancient Peru. If these views be correct the argument for primitive promiscuity derived from *pirrauru* falls to the ground.

6. The questions at issue obviously are, was mankind originally promiscuous, with no objections to marriage between persons of the nearest kin; and was the first step in advance the prohibition of marriage (or of amatory intercourse) between brothers and sisters; or did mankind originally live in very small groups, under a jealous sire, who imposed restrictions on intercourse between the young males, his sons, and all the females of the "hearth-circle," who constituted his harem? The problem has been studied, first, in the institutions of savages, notably of the most backward savages, the black natives of Australia; and next, in the light of the habits of the higher mammalia.

The historical problem.

As regards Australian matrimonial institutions, it has been known since the date of the *Journals of two Expeditions of Discovery*, by Sir George Grey (1837-1839), that they are very complex and peculiar, in points strongly resembling the customary laws of the more backward Red Indian tribes of North America. Information came in, while McLennan was working, from G. Taplin (*The Narrinyeri*, 1874), from A. W. Howitt and L. Fison, and many other inquirers (in Brough Smyth's *Aborigines of Victoria*, 1878), from Howitt and Fison again (in *Kamilaroi and Kurnai*, 1880), and many essays by these authors, and finally, in *Native Tribes of Central Australia* (1899) and *Northern Tribes of Central Australia* (1904), by Baldwin Spencer and F. J. Gillen; and in Howitt's *Native Tribes of South-East Australia* (1904), with R. Roth's *North-West Central Queensland Aborigines* (1897). All of these are works of very high merit. Knowledge is now much more wide, minute and securely based than it was when McLennan's *Studies in Ancient History*, second series, was posthumously published (1896). We know with certainty that in Australia, among archaic savages who have neither metals, agriculture, pottery nor domesticated animals, a graduated scale of matrimonial institutions exists. First there are *local* tribes, each tribe having its own dialect; holding a recognized area of territory; and living on friendly terms with neighbouring tribes. Territorial conquest is never attempted. In many cases a knot of tribes of allied dialects and kindred rites may be, or at least is, spoken of as a "nation" by our authorities.

7. Customary law is administered by the Seniors, the wise, the magically skilled, who in many cases are "headmen" of local groups or of sets of kindred persons may wed within the local tribe, or into a neighbouring local tribe, at will, provided that they obey the restrictions of customary law. The local tribe is neither exogamous nor endogamous, any more than is an English county. The restrictions, except where they have become obsolete, fall into six main categories:—

Primitive restrictions on marriage.

(1) In the most primitive, each tribe consists of two intermarrying and exogamous divisions, which are often styled *phratries*. Each such division has a name, which, when it can be translated, is the name of an animal: in the majority of cases, however, the meaning of the phratry name is lost. In one instance, that of the Euahlayi tribe of north-west New South Wales, the phratry names are said (by Mrs Langloh Parker) to mean "Light Blood" and "Dark Blood." This, as in the theory of the Rev. J. Mathews, *Eagle and Crow*, might be taken to indicate a blending of two distinct *races*.

Taking, for the sake of clearness, tribes whose phratry names mean "Crow" and "Eagle Hawk," every member of the tribe belongs either to Eagle Hawk phratry or to Crow phratry: if to Crow, the man or woman can only marry an Eagle Hawk, if to Eagle Hawk, can only marry a Crow. The children invariably belong to the phratry of the mother, in this most primitive type. Within Eagle Hawk phratry is one set of totem kins, named usually after various species of animals and plants; within Crow phratry is another set of totem kins, named always (except in one region of Central Australia) after a *different* set of plants and animals. With the exception mentioned (that of the Arunta

"nation"), in no tribe does the same totem ever occur in both phratries. Totems and totem names are inherited by the children from the mother, in this primitive type. Thus a man, Eagle Hawk by phratry, Snipe by totem, marries a woman Crow by phratry, Black Duck by totem. His children by her are of phratry Crow, of totem Black Duck. Obviously no person can marry another of his or her own totem, because, in the phratry into which he or she *must* marry, no man or woman of his or her totem exists. The prohibition extends to members of alien and remote tribes, if of the same totem name.

The same rules exist in the more primitive North American tribes, but as the phratry there has generally, though not always, decayed, the rule, where this has occurred, merely forbids marriage within the totem kin.

(2) We find this type of organization, where the child inherits phratry and totem from the father, not from the mother.

(3) We find tribes in which phratry and totem are inherited from the mother, but an additional rule prevails: the rule of "Matrimonial Classes." By this device, in phratry "Dilbi," there are two classes, "Muri" and "Kubi." In phratry "Kupathin" are two classes, "Ipai" and "Kumbo" (all these names are of unknown meaning). Each child inherits its mother's phratry name and totem name, and also the name of that class of the two in the mother's phratry to which the mother does *not* belong. No person may marry into his or her own class—practically into his or her own generation: the rule makes parental and filial marriages impossible,—but these never occur even among more primitive tribes which have not the institution of classes. Suppose that the class names are really names of animals and other objects in nature—as in a few cases they actually are. Then the rules, where classes exist, would amount to this: no person may marry another who, by phratry, totem or generation, owns the same hereditary animal name as himself or herself. In practice, where phratries exist, a man who knows a woman's phratry name knows whether or not he may marry her. Where class names exist (even though the phratry name be lost), a man who knows a woman's class name knows whether or not he may marry her. Nothing can be simpler in practice.

(4) The same rules as under (3) exist, but the phratry, totem and class are inherited through the father: the class of the child of course not being the father's, but the linked class in his phratry.

(5) In the fifth category (Central North Australia), while phratry name (if not lost) and totem name are inherited from the father, by a refinement of law which is spreading southwards there are *four* classes in each phratry (or main exogamous division unnamed), and the choice of a partner in life is thus more restricted than in more primitive tribes.

(6) Finally we reach the institutions of the group of tribes called, from the name of the most powerful tribe in the set, "the Arunta nation." They occupy the Macdonnell

Arunta customs.

Ranges and other territory in the very centre of Australia. The Arunta reckon kinship in the male line: their phratry names they have forgotten, in place of phratries eight matrimonial classes regulate marriage. In these respects they resemble most of the central and northern tribes, but present this unique peculiarity, that the same totems may and do exist in *both* of the opposed intermarrying exogamous divisions consisting of four classes each. It thus results that a man, in the Arunta tribe, may marry a woman of his own totem, if she be in the class with which he may intermarry. This licence is unknown in every other part of the totemic world, and even in the Kaitish tribe of the Arunta nation intertotemic marriages, in practice, almost never occur.

Among the Arunta the totems are only prominent in magical ceremonies, unknown in South-Eastern Australia. At these ceremonies (Intichiuma) the men of the totem do co-operative magic for the benefit of their plant or animal, as part of the tribal food-supply. The members of the totem taste it sparingly on these occasions, apparently under the belief that to do so increases their magical power: the rest of the tribe eat freely. But, as far as denoting kinship or regulating marriage is con-

cerned, the totems, among the Arunta, have no legally important existence. Men and women of the same totem may intermarry, their children need not belong to the totem of either father or mother.

The process by which Arunta totems came thus to differ from those of all other savages is easily understood. Like the other tribes from the centre to the north (including the Urabunna nation, which reckons descent through women), the Arunta believe that the souls of the primal semi-bestial ancestors of the Alcheringa or "dream time" are perpetually reincarnated. This opinion does not affect by itself the usual exogamous character of totemism among the other tribes. The Arunta nation, however, cultivates an additional myth, namely that the primal ancestors, when they sank into the ground, left behind them certain oval stone slabs, with archaic markings, called *churinga nanja*, or "sacred things of the *nanja*." The *nanja*, again, is a tree or rock, fabled to have risen up to mark the spot where a group of primal ancestors, all of one and the same totem in each case (Cats here, Grubs there, Ducks elsewhere), "went into the ground." The souls of these ancestors haunt such spots, especially they haunt the *nanja* tree or rock, and the stone *churinga nanja*. Each district, therefore, has its own *oknanikilla* (or local totem centre of the ghosts), Cat ghosts, Grub ghosts, Hakea flower ghosts and so on. These spirits enter into women and are reborn as children. When a child comes to birth, the mother names the *oknanikilla* in which she conceived it, and, whatever the ghost totem of that place may be, it is the child's totem. Its mother may be a Grub, its father may be a Crow, but if the child was conceived in a Duck, or Cat, or Opossum or Kangaroo locality, it is, by totem, a Cat, Opossum, Duck or Kangaroo. The *churinga nanja* of its primal ancestor is sought for at the place of the child's conception, and is put into the sacred repository of such objects.

Thus the child does not inherit its totem from father, or from mother, as everywhere else, but *does* inherit the right to do ceremonies for the paternal totem: a proof that, of old, totems were inherited, as elsewhere, and that in the male line. If totems among the Arunta, as everywhere else, were once arranged on the plan that the same totem never occurs in both exogamous moieties, that arrangement has been destroyed, as was inevitable, by the existing method of allotting totems to children,—not by inheritance,—but at haphazard. By this means (a consequence of the unique Arunta belief about *churinga nanja*) the same totems have got into *both* exogamous moieties, so that persons of the same totem, but of appropriate matrimonial classes, may marry. This licence is absolutely confined to the limited region in which stone *churinga nanja* occur.

The whole system is impossible except where descent is reckoned in the male line, for there alone is *local* totemism possible, and the Arunta system is based on local totemism, *plus* the *churinga nanja* and reincarnation beliefs. With reckoning of descent in the female line, no locality can possibly have its *local* totem: all the totems indiscriminately distributed everywhere: and thus no woman can say in what totemic locality her child was conceived, for there is not and cannot be, with female descent, any totemic *locality*. Now it is admitted that reckoning by female descent is the earlier method, and it is granted that in rites and ceremonies the Arunta are of a relatively advanced and highly organized pattern. Their social organization is local, and they have a kind of local magistracies, hereditary in the male line.

In spite of these facts, Spencer and Gillen conceive that the peculiar totemism of the Arunta is the most primitive type extant (cp. Spencer, *J.A.I.* (N.S.), vol. i. 275-281; and Frazer, *ibid.* 281-288). It is not easy to understand this position, as, without male kinship and consequent local totemism (which are not primitive), and without the *churinga nanja* (which exist only in a strictly limited area), the Arunta system of non-exogamous totems cannot possibly exist. Again, the other tribes cannot have passed through the Arunta stage, for, if they had, their totems would have existed, as among the Arunta, in *both* exogamous moieties, and would there remain when they came to be inherited;

so that the totems of all these tribes would still be non-exogamous, like those of the Arunta. But this is not the case. Once more, it is clear that the Arunta system has but recently reached their neighbours, the Kaitish, for though they have the *churinga nanja* belief, and the baphazard method of acquiring totems by local accident, these things have not yet overcome the old traditional reluctance to marry within the totem name. It is not unlawful among the Kaitish; but it is hardly ever done.

Despite these objections, however, Spencer and Gillen hold, as we have said, that, originally, there were no restrictions (or no known restrictions) on marriage. Totems were merely the result of the formation of co-operative magical societies, in the interest of the tribal food supply. Then, in some unknown way, regulations as to marriage were introduced for some unknown purpose, or were involved in some manner not understood. "The traditions of the Arunta," says Spencer, "point to a very definite introduction of an exogamous system long after the totemic groups were fully developed, and, further, they point very clearly to the fact that the introduction was due to the deliberate action of certain ancestors. Our knowledge of the natives leads us to the opinion that it is quite possible that this really took place, that the exogamic groups were deliberately introduced so as to regulate marital relations."

Thus the wisdom of men living promiscuously as regards marriage, but organized in magical societies for the benefit of the common food supply of the local *tribe* (a complex institution postulated as already in being at this early stage), induced them to institute exogamy. Why they did this, what harm they saw in their promiscuity, we are not informed. Spencer goes on, "by this we do not mean that the regulations had anything whatever to do with the idea of incest, or of any harm accruing from the union of individuals who were regarded as too nearly related. . . . There was felt the need of some kind of organization, and this gradually resulted in the development of exogamous groups." But as "it is quite possible that the exogamous groups were deliberately introduced to regulate marital relations," and as they could only do so by introducing exogamy, we do not see how that system can be the result of the *gradual* development of an organization *quelconque*,—of unknown nature. A magical organization already existed (*Journal of the Anthropological Institute*, New Series, i. pp. 284-285).

The traditions of the Arunta seem here to be first accepted: "quite possibly" they are correct in stating that an exogamic system was purposefully introduced, long after totemic groups had arisen, by "the deliberate action of certain ancestors," and then that myth is rejected, in favour of the *gradual* development of exogamy, "out of some form of organization," unknown.

People who, like the Arunta, have lost memory of the very names of the phratries, cannot conceivably remember the nature of the origin of exogamy. Accustomed as they now are to tribal councils which introduce new rules, they fancy that, in the beginning, new rules were thus introduced.

Meanwhile the working of magic for the behoof of the totem animals and plants, or rather for the name-giving animals of magical societies, is not known to Howitt among the tribes of primitive social organization, while it is well known among agricultural natives of the Torres Strait Islands and among the advanced Sioux and Omaha of North America. The practice seems to belong rather to the decadence than to the dawn of totemism. On the whole, then, there seem to be insuperable difficulties in the way of Spencer's hypothesis that mankind were promiscuous, as regards marriage, but were organized into co-operative magical groups, athwart which came, in some unexplained way, the rule of exogamy; while, when it did come, all savages except the Arunta arranged matters so that totem kins were exogamous. The reverse was probably the case, totem kins were originally exogamous, and ceased to be so, and even to be kins among the Arunta, in consequence of the *churinga nanja* creed, becoming co-operative magical societies (Hartland, Marrett, Durkheim and others).

8. Spencer and Gillen leave the origin of exogamy an open

question. Howitt supposes that, in the shape of the phratric division of the tribe into two exogamous moieties, the scheme may have been introduced to the tribal headmen by a medicine man "announcing to his fellow headman a command received from some supernatural being . . ." (*Natives of South-East Australia*, pp. 89, 90). The Council, so to speak, of "headmen" accept the divine decree, and the assembled tribe pass the Act. But this explanation explains nothing. Why did the prophet wish to introduce exogamy? Why were names of animals given, in so many cases, to the two exogamous divisions? As Howitt asks (*op. cit.* p. 153), "How was it that men assumed the names of objects, which in fact must have been the commencement of totemism?"

It is apparent that any theory which begins by postulating the existence of early mankind in promiscuous groups or hordes, into which exogamous moieties are introduced by tribal decree, takes for granted that the *tribe*, with its headman, councils and great meetings (not to mention its inspired prophet, with the tribal "All Father" who inspires him), existed before any rules regulating "marital relations" were evolved. Even if all this were probable, we are not told why a promiscuous tribe thought good to establish exogamous divisions. Some native myths attribute the institution to certain wise ancestors; some to the supernatural "All Father," say Baiame; some to a treaty between Eagle Hawk and Crow, beings of cosmogonic legend, who give names to the phratries. Such myths are mere hypotheses. It is impossible to imagine how early savages, *ex hypothesi* promiscuous, saw anything to reform in their state of promiscuity. They now think certain unions wrong, because they are forbidden: they were not forbidden, originally, because they were thought wrong.

Westermarck has endeavoured to escape the difficulty thus: "Among the ancestors of man, as among other animals, there was no doubt a time when blood relationship was no bar to sexual intercourse. But variations here, as elsewhere, would naturally present themselves, and those of our ancestors who avoided in and in breeding would survive," while the others would die out. This appears to be orthodox evolutionary language, but it carries us no further. Human societies are not animals or plants, in whose structure various favourable "accidents" occur, producing better types, which survive. We ask *why* in human society did "variations present themselves"; *why* did certain sets of human beings "avoid in and in breeding"? We are merely told that some of our ancestors became exogamous and survived, while others remained promiscuous and perished. No light is thrown on the problem,—wherefore did some of our ancestors avoid in and in breeding, and become exogamous? Nothing is gained by saying "thus an instinct would be developed which would be powerful enough, as a rule, to prevent injurious unions." There is no "instinct," there is a tribal law of exogamy. If there had been an "instinct," it might account for the avoidance of "in and in breeding"—that is, it might account for exogamy, *ab initio*. But that is left unaccounted for by the theory which, after maintaining that the avoidance produced the instinct, seems to argue that the instinct produced the avoidance. Westermarck goes on to say that "exogamy, as a natural extension of the instinct, would arise when single families united in small hordes." But, if the single families already had the "instinct," they would not marry within the family: they would be exogamous,—marrying only into other families,—before they "united in small hordes." The difficulty of accounting for exogamy does not seem to have been overcome, and no attempt is made to explain the animal names of totem kins and phratries. Westermarck, however, says that "there is no reason why we should assume, as so many anthropologists have done, that primitive men lived in small endogamous groups, practising incest in every degree," although, as he also says, "there was no doubt a time when blood relationship was no bar to sexual intercourse." If there was no bar, people would "practise incest in every degree,"—what was there to prevent them? (*History of Human Marriage*, pp. 352, 353 (1891)).

Origin
of
exogamy.

Westermarck.

Conclusion
as to
Spencer's
hypo-
thesis.

So far we have seen no luminous and consistent account of how mankind became exogamous, if they began by being promiscuous. The theories rest on the idea that man, dwelling in an "undivided horde" (except so far as it was divided into co-operative magical societies), bisected it into two exogamous intermarrying moieties. Durkheim has put forward a theory which is not at all points easily understood. He supposes that, "at the beginning of societies of men, incest was not prohibited . . . before each horde (*peuplade*) divided itself into two primitive 'clans' at least" (*L'Année sociologique*, i. pp. 62, 63). Each of the two "clans" claimed descent from a different animal, which was its totem, and its "god." The two clans were exogamous,—out of respect to the blood of their totem (with which every member of the clan is mystically one), and, being hostile, the two clans raided each other for women. Each clan threw off colonies, which took new totems, new "gods," though still owning some regard to their original clan, from which they had seceded, while abandoning its "god." When the two "primary clans" made alliance and *connubium*, they became the phratries in the local tribe, and their colonies became the totem kins within the phratries.

We are not told why the original horde was disrupted into two hostile and intermarrying "clans": we especially wonder why the horde, if it wanted an animal god, did not choose one animal for the whole community; and we may suspect that a difference of taste in animal "gods" caused the hostility of the two clans. Nor do we see why, if things occurred thus, the totem kins should not represent twenty or thirty differences of religious taste, in the original horde, as to the choice of animal gods. If the horde was going to vary in opinion, it is unlikely that only two factions put forward animal candidates for divinity. Again, a "clan" (a totem kin, with exogamy and descent derived through mothers) cannot overflow its territorial area and be therefore obliged to send out colonies, for such a clan (as Durkheim himself remarks) has no territorial area to overflow. It is not a local institution at all.

While these objections cannot but occur, Durkheim does provide a valid reason for the existence of exogamy. When once the groups (however they got them) had totems, with the usual taboos on any sort of use of the totem by his human kinsfolk, the women of the kin would be tabooed to the men of the same kin. In marrying a maiden of his own totem, a man inevitably violates the sanctity of the blood of the totem (*L'Année sociologique*, i. pp. 47-57. Cf. Reinach, *Cultes, mythes et religions*, vol. i. pp. 162-166).

Here at last we have a theory which accounts for the "religious horror" that attaches to the violation of the rule of totemic exogamy: a mysterious entity, the totem, is hereby offended. But how did totems, animals, plants and so on, come to be mystically *solidaires* with their human namesakes and kinsmen? We do not observe that Dr Durkheim ever explains why two divisions of one horde chose each a different animal god, or why the supposed colonies thrown off by these primary clans deserted their animal gods for others, or why, and on what principle, they all chose new "gods,"—fresh animals, plants and other objects. His hereditary totem is, in practice, the last thing that a savage changes. The only case of change on record is a recent attempt to increase the range of legal marriages in a waning Australian tribe, on whose lands certain species of animals are perishing.

Theories based on a supposed primal state of promiscuity certainly encounter, when explaining the social organization of Australian savages, difficulties which they do not surmount. But Howitt has provided (apparently without fully realizing the merit of his own suggestions) a way out of the perplexities caused by the conception of early mankind dwelling promiscuously in "undivided communes." The way out is practically to say that, in everyday life, they lived in nothing of the sort. Howitt writes (*Native Tribes of South-East Australia*, p. 173): "A study of the evidence . . . has led me to the conclusion that the state of society among the early Australians was that of an 'Undivided Commune' . . .

It is, however, well to guard this expression. I do not desire to imply necessarily the existence of complete and continuous communism between the sexes. The character of the country, the necessity of moving from one point to another in search of game and vegetable food, would cause any Undivided Commune, when it assumed dimensions greater than the immediate locality could provide with food, to break up into two or more Communes of the same character. In addition to this it is clear . . . that in the past as now, individual likes and dislikes must have existed, so that, admitting the existence of common rights between the members of the Commune, these rights would remain in abeyance, so far as the separated parts of the Commune were concerned. But at certain gatherings . . . or on great ceremonial occasions, all the segments of the original Commune would reunite," and would behave in the fashion now common in great licentious festive meetings.

In the early ages contemplated, how can we postulate "great ceremonial occasions" or even peaceful assemblies at fruit-bearing spots? How can we postulate a surviving sense of solidarity among the scattered segments of the Commune, obviously very small, owing to lack of supplies, and perpetually disintegrated? But, taking the original groups as very small, and as ruled by likes and dislikes, by affection and jealousy, we are no longer concerned with a promiscuous horde, but with a little knot of human beings, in whom love, parental affection and the jealousy of sires, would promptly make discriminations between this person and that person, as regards sexual privileges. Thus we have edged away from the hypothesis of the promiscuous indiscriminating horde to the opinion of Darwin. "We may conclude," he says, "from what we know of the jealousy of all male quadrupeds, armed as many of them are with special weapons for battling with their rivals, that promiscuous intercourse in a state of Nature is extremely improbable. . . . The most probable view is that Man originally lived in small communities, each (man) with a single wife, or, if powerful, with several, whom he jealously guarded against all other men." But, in a community of this early type, to guard women jealously would mean constant battle, at least when Man became an animal who makes love all the year round. So Darwin adds: "Or man may not have been a social animal, and yet have lived with several wives, like the Gorilla,—for all the natives agree that but one adult male is seen in a band; when the young male grows up a contest takes place for the mastery, and the strongest, by killing or driving out the others, establishes himself as head of the Community. Younger males, being thus expelled and wandering about, would, when at last successful in finding a partner, prevent too close interbreeding within the limits of the same family" (*Descent of Man*, ii. pp. 361, 363 (1871)).

Here, then, we have practical Exogamy, as regards unions of brothers and sisters, among man still brutish, while the Sire is husband of the whole harem of females, probably unchecked as regards his daughters.

On this Darwinian text J. J. Atkinson builds his theory of the evolution of exogamy and of savage society in his *Primal Law (Social Origins and Primal Law*, by Lang and Atkinson, 1903). Paternal jealousy "gave birth to Primal Law, prohibitory of marriage between certain members of a family or local group, and thus, in natural sequence, led to forced connubial selection beyond its circle, that is, led to Exogamy . . . as a habit, not as an expressed law. . . ." The "expressed law" was necessarily a later development; conditioned by the circumstances which produced totemism, and sanctioned, as on Durkheim's scheme, by the totemic taboo. Atkinson worked out his theory by a minute study of customs of avoidance between near kin by blood or affinity; by observations on the customs of animals, and by hypotheses as to the very gradual evolution of human restrictions through many modifications. He also gave a theory of the "classificatory" system of names for relationships opposed to that of Morgan. The names are based merely "on reference to relativity of age of a class in relation to the group." The exogamous moieties of a tribe (phratries) are not

the result of a reformatory legislative bisection of the tribe, but of the existence of "two intermarrying totem clan groups." The whole treatise, allowing for defects caused by the author's death before the book was printed, is highly original and ingenious. The author, however, did not touch on the evolution of totemism.

9. The following system, as a means of making intelligible the evolution of Australian totemic society, is proposed by the present writer. We may suggest that men originally lived in the state of "the Cyclopean family" of Atkinson; that is, in Darwin's "family group," containing but one adult male, with the females, the adolescent males being driven out, to find each a female mate, or mates, elsewhere if they can. With increase of skill, improvements in implements and mitigation of ferocity, such groups may become larger, in a given area, but men may retain the habit of seeking mates outside the limits of the group of contiguity; the "avoidance" of brothers and sisters may already have arisen. Among the advanced Arunta, now, a man may speak freely to his elder sisters; to younger sisters, or "tribal sisters," he may not speak, "or only at such a distance that the features are indistinguishable." This archaic rule of avoidance would be a step facilitating the permission to adult males to dwell in their paternal group, avoiding their sisters. Such groups, whether habitually exogamous or not, will require names for each other, and various reasons would yield a preference to names derived from animals. These are easily signalled in gesture language; are easily presented in pictographs and tattooing; are even now, among savages and boys, the most usual sort of *personal* nicknames; and are widely employed as *group* names of villagers in European folk-lore. Among European rustics such group sobriquets are usual, but are resented. The savage, with his ideas of the equality or superiority of animals to himself, sees nothing to resent in an animal sobriquet, and the names, originally group sobriquets, would not find more difficulty in being accepted than "Whig," "Tory," "Huguenot," "Cavalier," "Christian," "Cameronian,"—all of them originally nicknames given from without. Again, "Wry Nose" and "Crooked Mouth" are *derisive* nicknames, but they are the translations of the ancient Celtic clan names Cameron and Campbell. The nicknames "Naked Dogs," "Liars," "Buffalo Dung," "Men who do not laugh," "Big Topknots," have been thoroughly accepted by the "gentes" of the Blackfoot Indians, now passing out of Totemism (Grinnell, *Blackfoot Lodge Tales*, pp. 208-225).

As Howitt writes, "the assumption of the names of objects by men must in fact have been the origin of totemism." Howitt does not admit the theory that the totem names came to arise in this way, but this way is a *vera causa*. Names must be given either from within or from without. A group, in savagery, has no need of a name for itself; "we" are "we," or are "The Men"; for all other adjacent groups names are needed. The name of one totem, *Thaballa*, "The Laughing Boy" totem, among the Warramunga and another tribe, is quite transparently a nickname, as is *Karti*, "The Grown-up Men" (Spencer and Gillen, *Northern Tribes of Central Australia*, p. 207).

There is nothing, *prima facie*, which renders this origin of animal, plant and other such names for early savage groups at all improbable. They would not even be resented, as now are the animal names for villagers in the Orkneys, the Channel Islands, France, Cornwall and in ancient Israel (for examples see *Social Origins*, pp. 295-301). The names once accepted, and their origin forgotten, would be inevitably regarded as implying a mystic *rapport* between the bestial and the human namesakes, Crow, Eagle Hawk, Grub, Bandicoot, Opossum, Emu, Kangaroo and so on (see NAME). On this subject it is enough to cite J. G. Frazer, in *The Golden Bough* (2nd ed., vol. i. pp. 404-446). Here will be found a rich and satisfactory collection of proof that community of name implies mystic *rapport*. Professor Rhys is quoted for the statement that probably "the whole Aryan race believed at one time not only that the name was a part of the man, but that it was that part of him which is termed the soul." In such a mental stage the

men "Crows" identify themselves with the actual Crow species: the birds are now "of their flesh," are fabled to be their ancestors, or the men have been evolved out of the birds. The Crow is sacro-sanct, a friend and protector, and a centre of taboos, one of which is the prohibition preventing a Crow man from intercourse with a Crow woman, "however far apart their hunting grounds may have been." All men and women Crows are recognized as brothers and sisters in the Crow, and are not intermarriageable.

On these lines the prohibition to infringe the totem taboo by marriage within the totem name is intelligible, but the system of phratries has yet to be accounted for. It is obvious that the names could only have been given originally to *local* groups: the people who held this or that local habitation received the name. Suppose that the rule of each such group, or heart circle, had been "no marriage within the local group or camp," as in Atkinson's scheme. When the groups accept their new names, the rule becomes, "no marriage within local group Eagle Hawk, group Crow," and so on. So far the animal giving the group name may not yet have become a revered totem. The result of the rule would inevitably be, in three or four generations, that in groups Crow or Eagle Hawk, there were no Crows or Eagle Hawks *by descent*, if the children took the names of descent from their mothers; for the sake of differentiation: the Ant woman's children in local group Crow being Ants, the Grub woman's children being Grubs, the Eagle Hawk woman's children being Eagle Hawks,—all in local group Crow, and inheriting the names of the local groups whence their mothers were brought into local group Crow.

By this means (indicated first by McLennan) each member of a local group would have a *local* group name, say Eagle Hawk, and a name by *female descent*, say Kangaroo, in addition, as now, to his or her personal name. In this way, all members of each local group would find, in any other local group, people of his name of descent, and, as the totem belief grew to maturity, kinsmen of his in the totem. When this fact was realized, it would inevitably make for peace among all contiguous groups. In place of taking women by force, at the risk of shedding kindred blood, peaceful betrothals between men and women of different local group names and of different names by descent could be arranged. Say that local groups Eagle Hawk and Crow took the lead in this arrangement of alliance and *connubium*, and that (as they would naturally flourish in the strength conferred by union) the other local groups came into it, ranging themselves under Eagle Hawk and Crow, we should have the existing primitive type of organization: Local Groups Eagle Hawk (*Mukwara*) and Crow (*Kilpara*) would have become the widely diffused phratries, *Mukwara* and *Kilpara*, with all the totem kins within them.

But, on these lines, some members of any totem kin, say Cat, would be in phratry Eagle Hawk, some would be in phratry *Kilpara* as now (for the different reason already indicated) among the Arunta. Such persons were in a quandary. By *phratry* law, as being in opposite phratries, a Cat in Eagle Hawk phratry could marry a Cat in Crow phratry. But, by totem law, this was impossible. To avoid the clash of law, all Cats had to go into one phratry or the other, either into Eagle Hawk or into Crow.

Two whole totem kins were in the same unhappy position. The persons who were Eagle Hawks *by descent* could not be in Eagle Hawk local group, now phratry, as we have already shown. They were in Crow phratry, they could not, by phratry law, marry in their own phratry, and to marry in Eagle Hawk was to break the old law, "no marriage within the *local* group name." Their only chance was to return to Eagle Hawk phratry, while Crow totem kin went into Crow phratry, and thus we often find, in fact, that in Australian phratries *Mukwara* (Eagle Hawk) there is a totem kin Eagle Hawk, and in *Kilpara* phratry (Crow) there is a totem kin Crow. This arrangement—the totem kin within the phratry of its own name—has long been known to exist in America. The Thlinkets have Raven phratry, with totem kins Raven, Frog, Goose, &c., and Wolf phratry, with

totem kins Wolf, Bear, Eagle, &c. (Frazer, *Totemism*, pp. 61, 62 (1887)). In Australia the fact has hitherto escaped observation, because so many phratry names are not translated, while, though *Mukwara* and *Kilpara* are translated, the Eagle Hawk and Crow totem kins within them bear other names for the same birds, more recent names, or tribal native names, such as *Biliari* and *Waa*, while *Mukwara* and *Kilpara* may have been names borrowed, within the institution of phratries, from some alien tribe now perhaps extinct.

We have now sketched a scheme explanatory of the most primitive type of social organization in Australia. The tendency is for phratries first to lose the meanings of their names, and, next, for their names to lapse into oblivion, as among the Arunta; the work of regulating marriage being done by the opposed Matrimonial Classes.

These classes are obviously an artificial arrangement, intended to restrict marriage to persons on the same level as generations. The meanings of the class names are only known with certainty in two cases, and then are names of animals, while there is reason to suspect that animal names occur in four or five of the eight class-names which, in different dialect forms, prevail in central and northern Australia. Conceivably the new class regulations made use of the old totemic machinery of nomenclature. But until Australian philologists can trace the original meanings of Class names, further speculation is premature.

10. Much might be said about the way out of totemism. When once descent and inheritance are traced through males, the social side of totemism begins to break up. One way out is the Arunta way, where totems no longer designate kinships. In parts of America totems are simply fading into heraldry, or into magical societies, while the "gentes," once totemic, have acquired new names, often local, as among the Sioux, or mere sobriquets, as among the Blackfeet. In Melanesia the phratries, whether named or nameless, have survived, while the totems have left but a few traces which some consider disputable (*Social Origins*, pp. 176-184). Among the Bantu of South Africa the tribes have sacred animals (*Siboko*), which may be survivals of the totems of the chief local totem group, with male descent in the tribe, the whole of which now bears the name of the sacred animal. Even in Australia, among tribes where there is reckoning of descent in the male line, and where there are no matrimonial classes, the tendency is for totems to dwindle, while exogamy becomes local, the rule being to marry out of the district, not out of the kin (Howitt, *Native Tribes of South-East Australia*, pp. 270-272; cf. pp. 135-137).

The problem as to why, among savages all on the same low level of material culture, one tribe derives descent through women, while its nearest neighbouring tribe, with ceremonies, rites, beliefs and myths like its own, and occupying lands of similar character in a similar climate, traces descent through men, seems totally insoluble. Again, we find that the civilized Lycians, as described by Herodotus (book i. ch. 173), reckoned lineage in the female line, while the naked savages of north and central Australia reckon in the male line. Our knowledge does not enable us to explain the change from female to male tracing of lineage. Yet the change was essential for the formation of the family system of civilized life. The change may be observed taking place in the region of North-West America peopled by the Thlinket, Haida and Salish tribes; the first are pure totemists, the last have arrived, practically, in the south, at the modern family, while a curious intermediate stage pervades the inter-jacent region.

The best authority on the Family developed in different shapes in North-West America is Charles Hill-Tout (cf. "Origin of the Totemism of the Aborigines of British Columbia," *Transactions of the Royal Society of Canada*, vol. vii. sect. 11, 1901). He, like many American and some English and continental students, applies the term "totem" not only to the hereditary totem of the exogamous kin, but to the animal familiars of individual men or women, called *manitus*, *naguals*, *nyarongs* and *yunbeai*, among North American Indians, in South America, in Borneo

and in the Euahlayi tribe of New South Wales. These animal familiars are chosen by individuals, obeying the monition of dreams, or are assigned to them at birth, or at puberty, by the tribal magicians. It has often been suggested that totemism arose when the familiar of an individual became hereditary among his descendants. This could not occur under a system of reckoning descent and inheriting the kin name through women, but as a Tsimshian myth says that a man's sister adopted his animal familiar, the bear, and transmitted it to her offspring, Hill-Tout supposes that this may have been the origin of totemism in tribes with reckoning of descent in the female line. Instances, however, are not known to exist in practice, and myths are mere baseless savage hypotheses.

Exogamy, in his opinion, is the result of treaties of political alliance with exclusive *interconnubium* between two sets of kinsfolk by blood, totemism being a mere accidental concomitant. This theory evades the difficulties raised by the hypothesis of deliberate reformatory legislation introducing the bisection of the tribe into exogamous societies.

AUTHORITIES.—The study of the History of the Family has been subject to great fluctuation of opinion, as unexpected evidence has kept pouring in from many quarters. The theory of primal promiscuity, which in 1870 succeeded to Sir Henry Maine's *patriarchal theory*, has endured many attacks, and there is a tendency to return, not precisely to the "patriarchal theory," but to the view that the jealousy of the Sire of the "Cyclopean family," or "Gorilla family" indicated by Darwin, has had much to do with laying the bases of "primal law." The whole subject has been especially studied by English-speaking writers, as the English and Americans are brought most into contact with the most archaic savage societies. Among foreigners, in addition to Starcke, Westermarck and Durkheim, already cited, may be mentioned Professor J. Kohler, *Zur Urgeschichte der Ehe* (Stuttgart, 1897). Professor Kohler is in favour of a remote past of "collective marriage," indicated, as in Morgan's hypothesis, by the existing savage names of relationships, which are expressive of relations of consanguinity. E. S. Hartland (*Primitive Paternity*, 1910) discusses myths of supernatural birth in relation to the history of the Family.

A careful and well-reasoned work by Herr Cunow (*Die Verwandtschafts Organisationen der Australneger*, Stuttgart, 1894) deals with the Matrimonial Classes of Australian tribes. Cunow supposes that descent was originally reckoned in the male line, and that tribes with this organization (such as the Narrinyeri) are the more primitive. In this opinion he has few allies: and on the origin of Exogamy he seems to possess no definite ideas. Pickler's *Ursprung des Totemismus* (Berlin, 1900) explains Totemism as arising from the need of names for early groups of men: names which could be expressed in pictographs and tattooing, to which we may add "gesture language." This is much akin to the theory which we have already suggested, though Pickler seems to think that the pictograph (say of a Crow or an Eagle Hawk) was prior to the group name. But, he remarks, like Howitt, "the germ of Totemism is the naming"; and the community of name between the animal species and the human group led to the belief that there was an important connexion between the men and their name-giving animal.

Other useful sources of information are the annual Reports of the Bureau of Ethnology (Washington), the *Journal of the Institute of the Anthropological Society*, *Folk Lore* (the organ of the Folk Lore Society), and Durkheim's *L'Année sociologique. Tabou et totemisme à Madagascar*, by M. A. van Gennep (Leroux, Paris, 1904) is a valuable contribution to knowledge.

For India, where vestiges of totemism linger in the hill tribes, see Risley and Crooke, *Tribes and Castes*, vols. i., ii., iii., iv.; and Crooke, *Popular Religion*; also Crooke in *J.A.I.* (N.S.), vol. i. pp. 232-244. (A. L.)

FAMINE (Lat. *fames*, hunger), extreme and general scarcity of food, causing distress and deaths from starvation among the population of a district or country. Famines have caused widespread suffering in all countries and ages. A list of the chief famines recorded by history is given farther on. The causes of famine are partly natural and partly artificial. Among the natural causes may be classed all failures of crops due to excess or defect of rainfall and other meteorological phenomena, or to the ravages of insects and vermin. Among the artificial causes may be classed war and economic errors in the production, transport and sale of food-stuffs.

The natural causes of famine are still mainly outside our control, though science enables agriculturists to combat them more successfully, and the improvement in means of transport allows a rich harvest in one land to supplement the defective

crops in another. In tropical countries drought is the commonest cause of a failure in the harvest, and where great droughts are not uncommon—as in parts of India and Australia—the hydraulic engineer comes to the rescue by devising systems of water-storage and irrigation. It is less easy to provide against the evils of excessive rainfall and of frost, hail and the like. The experience of the French in Algiers shows that it is possible to stamp out a plague of locusts, such as is the greatest danger to the farmer in many parts of Argentina. But the ease with which food can nowadays be transported from one part of the world to another minimizes the danger of famine from natural causes, as we can hardly conceive that the whole food-producing area of the world should be thus affected at once.

The artificial causes of famine have mostly ceased to be operative on any large scale. Chief among them is war, which may cause a shortage of food-supplies, either by its direct ravages or by depleting the supply of agricultural labour. But only local famines are likely to arise from this cause. Legislative interference with agricultural operations or with the distribution of food-supplies, currency restrictions and failure of transport, which have all caused famines in the past, are unlikely thus to operate again; nor is it probable that the modern speculators who attempt to make "corners" in wheat could produce the evil effects contemplated in the old statutes against forestallers and regrators.

Such local famines as may occur in the 20th century will probably be attributable to natural causes. It is impossible to regulate the rainfall of any district, or wholly to supply its failure by any system of water-storage. Irrigation is better able to bring fertility to a naturally arid district than to avert the failure of crops in one which is naturally fertile. The true palliative of famine is to be found in the improvement of methods of transport, which make it possible rapidly to convey food from one district to another. But the efficiency of this preventive stops short at the point of saving human life. It cannot prevent a rise in prices, with the consequent suffering among the poor. Still, every year makes it less likely that the world will see a renewal of the great famines of the past, and it is only the countries where civilization is still backward that are in much danger of even a local famine.

Great Famines.—Amongst the great famines of history may be named the following:—

- B.C. 436 Famine at Rome, when thousands of starving people threw themselves into the Tiber.
- A.D. 42 Great famine in Egypt.
- 650 Famine throughout India.
- 879 Universal famine.
- 941, 1022 and 1033 Great famines in India, in which entire provinces were depopulated and man was driven to cannibalism.
- 1005 Famine in England.
- 1016 Famine throughout Europe.
- 1064-1072 Seven years' famine in Egypt.
- 1148-1159 Eleven years' famine in India.
- 1162 Universal famine.
- 1344-1345 Great famine in India, when the Mogul emperor was unable to obtain the necessaries for his household. The famine continued for years and thousands upon thousands of people perished of want.
- 1396-1407 The Durga Devi famine in India, lasting twelve years.
- 1586 Famine in England which gave rise to the Poor Law system.
- 1661 Famine in India, when not a drop of rain fell for two years.
- 1769-1770 Great famine in Bengal, when a third of the population (10,000,000 persons) perished.
- 1783 The Chalisa famine in India, which extended from the eastern edge of the Benares province to Lahore and Jammu.
- 1790-1792 The Doji Bara, or skull famine, in India, so-called because the people died in such numbers that they could not be buried. According to tradition this was one of the severest famines ever known. It extended over the whole of Bombay into Hyderabad and affected the northern districts of Madras. Relief works were first opened during this famine in Madras.

- A.D. 1838 Intense famine in North-West Provinces (United Provinces) of India; 800,000 perished.
- 1846-1847 Famine in Ireland, due to the failure of the potato-crop. Grants were made by parliament amounting to £10,000,000.
- 1861 Famine in North-West India.
- 1866 Famine in Bengal and Orissa; one million perished.
- 1869 Intense famine in Rajputana; one million and a half perished. The government initiated the policy of saving life.
- 1874 Famine in Behar, India. Government relief in excess of the needs of the people.
- 1876-1878 Famine in Bombay, Madras and Mysore; five millions perish. Relief insufficient.
- 1877-1878 Severe famine in north China. Nine and a half millions said to have perished.
- 1887-1889 Famine in China.
- 1891-1892 Famine in Russia.
- 1897 Famine in India. Government policy of saving life successful. Mansion House fund £550,000.
- 1899-1901 Famine in India. One million people perished. Estimated loss to India £50,000,000. The government spent £10,000,000 on relief, and at one time there were 4,500,000 people on the relief works.
- 1905 Famine in Russia.

Famines in India.—Owing to its tropical situation and its almost entire dependence upon the monsoon rains, India is more liable than any other country in the world to crop failures, which upon occasion deepen into famine. Every year sufficient rain falls in India to secure an abundant harvest if it were evenly distributed over the whole country; but as a matter of fact the distribution is so uneven and so uncertain that every year some district suffers from insufficient rainfall. In fact, famine is, to all intents and purposes, endemic in India, and is a problem to reckon with every year in some portion of that vast area. The people depend so entirely upon agriculture, and the harvest is so entirely destroyed by a single monsoon failure, that wherever a total failure occurs the landless labourer is immediately thrown out of work and remains out of work for the whole year. The question is thus one of lack of employment, rather than lack of food. The food is there, perhaps at a slightly enhanced price, but the unemployed labourer has no money to buy it. The problem is very much the same as that met by the British Poor Law system. Every year in England a poor rate of some £22,000,000 is expended for a population of 40 millions; while it is only in an exceptional year in India that £10,000,000 are spent on a population of 300 millions.

Famines seem to recur in India at periodical intervals, which have been held to be in some way dependent on the sun-spot period. Every five or ten years the annual scarcity widens its area and becomes a recognized famine; every fifty or a hundred years whole provinces are involved, loss of life becomes widespread, and a great famine is recorded. In the 140 years since Warren Hastings initiated British rule in India, there have been nineteen famines and five severe scarcities. For the period preceding British rule the records have not been so well preserved, but there is ample evidence to show that famine was just as frequent in its incidence and infinitely more deadly in its effects under the native rulers of India. In the great Bengal famine of 1769-1770, which occurred shortly after the foundation of British rule, but while the native officials were still in power, a third of the population, or ten millions out of thirty millions, perished. From this it may be guessed what occurred in the centuries under Mogul rule, when for years there was no rain, when famine lasted for three, four or twelve years, and entire cities were left without an inhabitant. In the famine of 1901, the worst of recent years, the loss of life in British districts was 3% of the population affected, as against 33% in the Bengal famine of 1770.

The native rulers of India seem to have made no effort to relieve the sufferings of their subjects in times of famine; and even down to 1866 the British government had no settled famine policy. In that year the Orissa famine awakened the public conscience, and the commission presided over by Sir George Campbell laid down the lines upon which subsequent famine-relief was organized. In the Rajputana famine of 1869 the humane principle of saving every possible life was first

enunciated. In the Behar famine of 1874 this principle was even carried to an extreme, the cost was enormous, and the people were in danger of being pauperized. The resulting reaction caused a regrettable loss of life in the Madras and Bombay famines of 1876-1878; and the Famine Commission of 1880, followed by those of 1898 and 1901, laid down the principle that every possible life must be saved, but that the wages on relief works must be so regulated in relation to the market rate of wages as not to undermine the independence of the people. The experience gained in the great famines of 1898 and 1901 has been garnered by these commissions, and stored up in the "famine codes" of each separate province, where rules are provided for the treatment of famine directly a crop failure is seen to be probable. The first step is to open test works; and directly they show the necessity, regular relief works are established, in which the people may earn enough to keep them from starvation, until the time comes to sow the next crop.

As a result of the severe famine of 1878-1879, Lord Lytton's government instituted a form of insurance against famine known as the Famine Insurance Grant. A sum of Rs. 1,500,000 was to be yearly set aside for purposes of famine relief. This scheme has been widely misunderstood; it has been assumed that an entirely separate fund was created, and that in years when the specified sum was not paid into this fund, the purpose of the government was not carried out. But Sir John Strachey, the author of the scheme, explains in his book on India that the original intention was nothing more than the annual application of surplus revenue, of the indicated amount, to purposes of famine relief; and that when the country was free from famine, this sum should be regularly devoted to the discharge of debt, or to the prevention of debt which would otherwise have been incurred for the construction of railways and canals. The sum of 1½ crores is regularly set aside for this purpose, and is devoted as a rule to the construction of protective irrigation works, and for investigating and preparing new projects falling under the head of protective works.

The measures by which the government of India chiefly endeavours to reduce the liability of the country to famine are the promotion of railways; the extension of canal and well irrigation; the reclamation of waste lands, with the establishment of fuel and fodder reserves; the introduction of agricultural improvements; the multiplication of industries; emigration; and finally the improvement where necessary of the revenue and rent systems. In times of famine the function of the railways in distributing the grain is just as important as the function of the irrigation-canal in increasing the amount grown. There is always enough grain within the boundaries of India for the needs of the people; the only difficulty is to transport it to the tract where it is required at a particular moment. Owing to the extension of railways, in the famines of 1898 and 1901 there was never any dearth of food in any famine-stricken tract; and the only difficulty was to find enough rolling-stock to cope with the demand. Irrigation protects large tracts against famine, and has immensely increased the wheat output of the Punjab; the Irrigation Commission of 1903 recommended the addition of 6½ million acres to the irrigated area of India, and that recommendation is being carried out at an annual cost of 1½ millions sterling for twenty years, but at the end of that time the list of works that will return a lucrative interest on capital will be practically exhausted. Local conditions do not make irrigation everywhere possible.

As five-sixths of the whole population of India are dependent upon the land, any failure of agriculture becomes a national calamity. If there were more industries and manufactures in India, the dependence on the land would not be so great and the liability to lack of occupation would not be so uniform in any particular district. The remedy for this is the extension of factories and home industries; but European capital is difficult to obtain in India, and the native capitalist prefers to hoard his rupees. The extension of industries, therefore, is a work of time.

It is sometimes alleged by native Indian politicians that famines are growing worse under British rule, because India is becoming

exhausted by an excessive land revenue, a civil service too expensive for her needs, military expenditure on imperial objects, and the annual drain of some £15,000,000 for "home charges." The reply to this indictment is that the British land revenue is £16,000,000 annually, whereas Aurangzeb's over a smaller area, allowing for the difference in the value of the rupee, was £110,000,000; though the Indian Civil Service is expensive, its cost is more than covered by the fact that India, under British guarantee, obtains her loans at 3½% as against 10% or more paid by native rulers; though India has a heavy military burden, she pays no contribution to the British navy, which protects her seaboard from invasion; the drain of the home charges cannot be very great, as India annually absorbs 6 millions sterling of the precious metals; in 1899-1900, a year of famine, the net imports of gold and silver were 130 millions. Finally, it is estimated by the census commissioners that in the famine of 1901 three million people died in the native states and only one million in British territory.

See Cornelius Walford, "On the Famines of the World, Past and Present" (*Journal of the Statistical Society*, 1878-1879); Romesh C. Dutt, *Famines in India* (1900); Robert Wallace, *Famine in India* (1900); George Campbell, *Famines in India* (1769-1788); *Chronological List of Famines for all India* (Madras Administration Report, 1885); J. C. Geddes, *Administrative Experience in Former Famines* (1874); *Statistical Atlas of India* (1895); F. H. S. Merewether, *Through the Famine Districts of India* (1898); G. W. Forrest, *The Famine in India* (1898); E. A. B. Hodgetts, *In the Track of the Russian Famine* (1892); W. B. Steveni, *Through Famine-stricken Russia* (1892); Vaughan Nash, *The Great Famine* (1900); Lady Hope, *Sir Arthur Cotton* (1900); Lord Curzon in *India* (1905); T. W. Holderness, *Narrative of the Famine of 1896-1897* (c. 8812 of 1898); the Indian Famine Commission reports of 1880, 1898 and 1900; report of the Indian Irrigation Commission (1901-1903); C. W. McMinn, *Famine Truths, Half-Truths, Untruths* (1902); Theodore Morison, *Indian Industrial Organization* (1906).

FAN (Lat. *vannus*; Fr. *éventail*), in its usually restricted meaning, a light implement used for giving motion to the air in order to produce coolness to the face; the word is, however, also applied to the winnowing fan, for separating chaff from grain, and to various engineering appliances for ventilation, &c. *Ventilabrum* and *flabellum* are names under which ecclesiastical fans are mentioned in old inventories. Fans for cooling the face have been in use in hot climates from remote ages. A bas-relief in the British Museum represents Sennacherib with female figures carrying feather fans. They were attributes of royalty along with horse-hair fly-flappers and umbrellas. Examples may be seen in plates of the Egyptian sculptures at Thebes and other places, and also in the ruins of Persepolis. In the museum of Boulak, near Cairo, a wooden fan handle showing holes for feathers is still preserved. It is from the tomb of Amenhotep, of the 18th dynasty, 17th century B.C. In India fans were also attributes of men in authority, and sometimes sacred emblems. A heart-shaped fan, with an ivory handle, of unknown age, and held in great veneration by the Hindus, was given to King Edward VII. when prince of Wales. Large punkahs or screens, moved by a servant who does nothing else, are in common use in hot countries, and particularly India.

Fans were used in the early middle ages to keep flies from the sacred elements during the celebrations of the Christian mysteries. Sometimes they were round, with bells attached—of silver or silver gilt. Notices of such fans in the ancient records of St Paul's, London, Salisbury cathedral and many other churches exist still. For these purposes they are no longer used in the Western church, though they are retained in some Oriental rites. The large feather fans, however, are still carried in the state processions of the supreme pontiff in Rome, though not used during the celebration of the mass. The fan of Queen Theodolinda (7th century) is still preserved in the treasury of the cathedral of Monza. Fans made part of the bridal outfit, or *mundus muliebris*, of Roman ladies.

Folding fans had their origin in Japan, and were imported thence to China. They were in the shape still used—a segment of a circle of paper pasted on a light radiating framework of bamboo, and variously decorated, some in colours, others of white paper on which verses or sentences are written. It is a

compliment in China to invite a friend or distinguished guest to write some sentiment on your fan as a memento of any special occasion, and this practice has continued. A fan that has some celebrity in France was presented by the Chinese ambassador to the comtesse de Clauzel at the coronation of Napoleon I. in 1804. When a site was given in 1635, on an artificial island, for the settlement of Portuguese merchants in Nippo in Japan, the space was laid out in the form of a fan as emblematic of an object agreeable for general use. Men and women of every rank both in China and Japan carry fans, even artisans using them with one hand while working with the other. In China they are often made of carved ivory, the sticks being plates very thin and sometimes carved on both sides, the intervals between the carved parts pierced with astonishing delicacy, and the plates held together by a ribbon. The Japanese make the two outer guards of the stick, which cover the others, occasionally of beaten iron, extremely thin and light, damascened with gold and other metals.

Fans were used by Portuguese ladies in the 14th century, and were well known in England before the close of the reign of Richard II. In France the inventory of Charles V. at the end of the 14th century mentions a folding ivory fan. They were brought into general use in that country by Catherine de' Medici, probably from Italy, then in advance of other countries in all matters of personal luxury. The court ladies of Henry VIII.'s reign in England were used to handling fans. A lady in the "Dance of Death" by Holbein holds a fan. Queen Elizabeth is painted with a round feather fan in her portrait at Gorham-bury; and as many as twenty-seven are enumerated in her inventory (1606). Coryat, the English traveller, in 1608 describes them as common in Italy. They also became of general use from that time in Spain. In Italy, France and Spain fans had special conventional uses, and various actions in handling them grew into a code of signals, by which ladies were supposed to convey hints or signals to admirers or to rivals in society. A paper in the *Spectator* humorously proposes to establish a regular drill for these purposes.

The chief seat of the European manufacture of fans during the 17th century was Paris, where the sticks or frames, whether of wood or ivory, were made, and the decorations painted on mounts of very carefully prepared vellum (incorrectly called *chicken skin*)—a material stronger and tougher than paper, which breaks at the folds. Paris makers exported fans unpainted to Madrid and other Spanish cities, where they were decorated by native artists. Many were exported complete; of old fans called Spanish a great number were in fact made in France. Louis XIV. issued edicts at various times to regulate the manufacture. Besides fans mounted with parchment, Dutch fans of ivory were imported into Paris, and decorated by the heraldic painters in the process called "Vernis Martin," after a famous carriage painter and inventor of colourless lac varnish. Fans of this kind belonging to Queen Victoria and the baroness de Rothschild were exhibited in 1870 at Kensington. A fan of the date of 1660, representing sacred subjects, is attributed to Philippe de Champagne, another to Peter Oliver in England in the 17th century. Cano de Arevalo, a Spanish painter of the 17th century, devoted himself to fan painting. Some harsh expressions of Queen Christina to the young ladies of the French court are said to have caused an increased ostentation in the splendour of their fans, which were set with jewels and mounted in gold. Rosalba Carriera was the name of a fan painter of celebrity in the 17th century. Le Brun and Romanelli were much employed during the same period. Klingstet, a Dutch artist, enjoyed a considerable reputation in the latter part of the 17th and the first thirty years of the 18th century.

The revocation of the edict of Nantes drove many fan-makers out of France to Holland and England. The trade in England was well established under the Stuart sovereigns. Petitions were addressed by the fan-makers to Charles II. against the importation of fans from India, and a duty was levied upon such fans in consequence. This importation of Indian fans, according to Savary, extended also to France. During the reign of Louis XV. carved Indian and China fans displaced to some extent those

formerly imported from Italy, which had been painted on swanskin parchment prepared with various perfumes.

During the 18th century all the luxurious ornamentation of the day was bestowed on fans as far as they could display it. The sticks were made of mother-of-pearl or ivory, carved with extraordinary skill in France, Italy, England and other countries. They were painted from designs of Boucher, Watteau, Lancret and other "genre" painters; Hébert, Rau, Chevalier, Jean Boquet, Mme. Vérité, are known as fan-painters. These fashions were followed in most countries of Europe, with certain national differences. Taffeta and silk, as well as fine parchment, were used for the mounts. Little circles of glass were let into the stick to be looked through, and small telescopic glasses were sometimes contrived at the pivot of the stick. They were occasionally mounted with the finest point lace. An interesting fan (belonging to Madame de Thiac in France), the work of Le Flamand, was presented by the municipality of Dieppe to Marie Antoinette on the birth of her son the dauphin. From the time of the Revolution the old luxury expended on fans died out. Fine examples ceased to be exported to England and other countries. The painting on them represented scenes or personages connected with political events. At a later period fan mounts were often prints coloured by hand. The events of the day mark the date of many examples found in modern collections. Among the fan-makers of modern days the names of Alexandre, Duvelleroy, Fayet, Vanier became well known in Paris; and the designs of Charles Conder (1868-1909) have brought his name to the front in this art. Painters of distinction often design and paint the mounts, the best designs being figure subjects. A great impulse was given to the manufacture and painting of fans in England after the exhibition which took place at South Kensington in 1870. Modern collections of fans take their date from the emigration of many noble families from France at the time of the Revolution. Such objects were given as souvenirs, and occasionally sold by families in straitened circumstances. A large number of fans of all sorts, principally those of the 18th century, French, English, German, Italian, Spanish, &c., have been bequeathed to the South Kensington (Victoria and Albert) Museum.

The sticks of folding fans are called in French *brins*, the two outer guards *panaches*, and the mount *feuille*.

See also Blondel, *Histoire des éventails* (1875); Octave Uzanne, *L'éventail* (1882); and especially G. Wooliscroft Rhead, *History of the Fan* (1909). (J. H. P.)*

FANCY (a shortened form, dating from the 15th century, of "fantasy," which is derived through the O. Fr. *fantasie*, modern *fantaisie*, from the Latinized form of the Gr. *φαντασία*, *φαντάζειν*, *φαίειν*, to show), display, showing forth, as a philosophical term, the presentative power of the mind. The word "fancy" and the older form "fantasy," which is now chiefly used poetically, was in its early application synonymous with imagination, the mental faculty of creating representations or images of things not present to the senses; it is more usually, in this sense, applied to the lighter forms of the imagination. "Fancy" also commonly means inclination, whim, caprice. The more learned form "phantasy," as also such words as "phantom" and "phantasm," is chiefly confined to visionary imaginings.

FANG (FAN, FANWE, PANWE, PAHOUI, PAOUI, MPANGWE), a powerful African people occupying the Gabun district north of the Ogowé river in French Congo. Their name means "men." They call themselves Pa^we, Fa^we and Faⁿ with highly nasalized n. They are a finely-made race of chocolate colour; some few are very dark, but these are of slave origin. They have bright expressive oval faces with prominent cheek-bones. Many of them file their teeth to points. Their hair, which is woolly, is worn by the women long, reaching below the nape of the neck. The men wear it in a variety of shapes, often building it up over a wooden base. The growth of the hair appears abundant, but that on the face is usually removed. Little clothing is worn; the men wear a bark waist-cloth, the women a plantain girdle, sometimes with a bustle of dried grass. A chief wears a leopard's skin round the shoulders. Both sexes tattoo and paint the body,

and delight in ornaments of every kind. The men, whose sole occupations are fighting and hunting, all carry arms—muskets, spears for throwing and stabbing, and curious throwing-knives with blades broader than they are long. Instead of bows and arrows they use crossbows made of ebony, with which they hunt apes and birds. In battle the Fang used to carry elephant hide shields; these have apparently been discarded.

When first met by T. E. Bowdich (1815) the Paamways, as he calls the Fang, were an inland people inhabiting the hilly plateaus north of the Ogové affluents. Now they have become the neighbours of the Mpongwe (*q.v.*) of Glass and Libreville on the Komo river, while south of the Gabun they have reached the sea at several points. Their original home is probably to be placed somewhere near the Congo. Their language, according to Sir R. Burton, is soft and sweet and a contrast to their harsh voices, and the vocabularies collected prove it to be of the Bantu-Negroid linguistic family. W. Winwood Reade (*Sketch Book*, i. p. 108) states that "it is like Mpongwe (a pure Bantu idiom) cut in half; for instance, *njina* (gorilla) in Mpongwe is *nji* in Fan." The plural of the tribal name is formed in the usual Bantu way, Ba-Fang.

Morally the Fang are superior to the negro. Mary Kingsley writes: "The Fan is full of fire, temper, intelligence and go, very teachable, rather difficult to manage, quick to take offence, and utterly indifferent to human life." This latter characteristic has made the Fang dreaded by all their neighbours. They are noted cannibals, and ferocious in nature. Prisoners are badly treated and are often allowed to starve. The Fang are always fighting, but the battles are not bloody. After the fall of two or three warriors the bodies are dragged off to be devoured, and their friends disperse. Burton says that their cannibalism is limited to the consumption of slain enemies; that the sick are not devoured; and that the dead are decently buried, except slaves, whose bodies are thrown into the forest. Mary Kingsley, on the other hand, believed their cannibalism was not limited. She writes: "The Fan is not a cannibal for sacrificial motives, like the negro. He will eat his next door neighbour's relation and sell his own deceased to his next door neighbour in return, but he does not buy slaves and fatten them up for his table as some of the middle Congo tribes do. He has no slaves, no prisoners of war, no cemeteries, so you must draw your own conclusions." Among certain tribes the aged alone are permitted to eat human flesh, which is *taboo* for all others. There is no doubt that the cannibalism of the Fang is diminishing before the advance of civilization. Apart from their ferocity, the Fang are an agreeable and industrious people. They are skillful workers in iron and have a curious coinage called *bikèi*, little iron imitation axeheads tied up in bundles called *nlet*, ten to a bundle; these are used chiefly in the purchase of wives. They are energetic traders and are skilled in pottery and in gardening. Their religion appears to be a combination of primitive animism and ancestor worship, with a belief in sympathetic magic.

BIBLIOGRAPHY.—Paul du Chaillu, *Explorations in Equatorial Africa* (1861); Sir R. Burton, "A Day with the Fans," *Transactions of Ethnological Society*, new series, vols. 3-4; Mary Kingsley, *Travels in West Africa* (1897); Oscar Lenz, *Skizzen aus West Africa* (1878); R. E. Dennett, *Notes on the Folklore of the Fjort* (1898); William Winwood Reade, *The African Sketch Book* (1873); and (chiefly) A. L. Bennett, "Ethnographical Notes on the Fang," *Journ. Anthr. Inst. N.S.*, ii. p. 66, and L. Martron in *Anthropos*, t. i. (1906), fasc. 4.

FANO (anc. *Fanum Fortunae*, *q.v.*), a town and episcopal see of the Marches, Italy, in the province of Pesaro and Urbino, 8 m. S.E. of the former by rail, and 46 ft. above sea-level, on the N.E. coast of Italy. Pop. (1901), town 10,535, commune 24,730. The cathedral has a 13th century portal, but the interior is unimportant. The vestibule of S. Francesco contains the tombs of some members of the Malatesta family. S. Croce and S. Maria Nuova contain works by Giovanni Santi, the father of Raphael; the latter has also two works by Perugino, the predella of one of which is attributed to Raphael. S. Agostino contains a painting of S. Angelo Custode ("the Guardian Angel"), which is the subject of a poem by Robert Browning. The fine Gothic Palazzo della Ragione (1299) has been converted into a theatre.

The palace of the Malatesta, with fine porticos and Gothic windows, was much damaged by an earthquake in 1874. S. Michele, built against the arch of Augustus, is an early Renaissance building (1475-1490), probably by Matteo Nuzio of Fano, with an ornate portal. The façade has an interesting relief showing the colonnade added by Constantine as an upper storey to the arch of Augustus and removed in 1463.

Fano in the middle ages passed through various political vicissitudes, and in the 14th century became subject to the Malatesta. In 1458 Pius II. added it to the states of the Church. Julius II. established here in 1514 the first printing press with movable Arabic type. The harbour was restored by Paul V. but is now unimportant.

FANSHAWE, SIR RICHARD, Bart. (1608-1666), English poet and ambassador, son of Sir Henry Fanshawe, remembrancer of the exchequer, of Ware Park, Hertfordshire, and of Elizabeth, daughter of Thomas Smith or Smythe, was born early in June 1608, and was educated in Cripplegate by the famous schoolmaster, Thomas Farnaby. In November 1623 he was admitted fellow-commoner of Jesus College, Cambridge, and in January 1626 he entered the Inner Temple; but the study of the law being distasteful to him, he travelled in France and Spain. On his return, an accomplished linguist, in 1635, he was appointed secretary to the English embassy at Madrid under Lord Aston. At the outbreak of the Civil War he joined the king, and while at Oxford in 1644 married Anne, daughter of Sir John Harrison of Balls, Hertfordshire. About the same time he was appointed secretary at war to the prince of Wales, with whom he set out in 1645 for the western counties, Scilly, and afterwards Jersey. He compounded in 1646 with the parliamentary authorities, and was allowed to live in London till October 1647, visiting Charles I. at Hampton Court. In 1647 he published his translation of the *Pastor Fido* of Guarini, which he reissued in 1648 with the addition of several other poems, original and translated. In 1648 he was appointed treasurer to the navy under Prince Rupert. In November of this year he was in Ireland, where he actively engaged in the royalist cause till the spring of 1650, when he was despatched by Charles II. on a mission to obtain help from Spain. This was refused, and he joined Charles in Scotland as secretary. On the 2nd of September 1650 he had been created a baronet. He accompanied Charles in the expedition into England, and was taken prisoner at the battle of Worcester on the 3rd of September 1651. After a confinement of some weeks at Whitehall, he was allowed, with restrictions, and under the supervision of the authorities, to choose his own place of residence. He published in 1652 his *Selected Parts of Horace*, a translation remarkable for its fidelity, felicity and elegance. In 1654 he completed translations of two of the comedies of the Spanish poet Antonio de Mendoza, which were published after his death, *Querere per solo querere: To Love only for Love's Sake*, in 1670, and *Fiestas de Aranjuez* in 1671. But the great labour of his retirement was the translation of the *Lusiad*, by Camoens, published in 1655. It is in ottava rima, with the translation prefixed to it of the Latin poem *Furor Petroniensis*. In 1658 he published a Latin version of the *Faithful Shepherdess* of Fletcher.

In April 1659 Fanshawe left England for Paris, re-entered Charles's service and accompanied him to England at the Restoration, but was not offered any place in the administration. In 1661 he was returned to parliament for the university of Cambridge, and the same year was sent to Portugal to negotiate the marriage between Charles II. and the infanta. In January 1662 he was made a privy councillor of Ireland, and was appointed ambassador again to Portugal in August, where he remained till August 1663. He was sworn a privy councillor of England on the 1st of October. In January 1664 he was sent as ambassador to Spain, and arrived at Cadiz in February of that year. He signed the first draft of a treaty on the 17th of December, which offered advantageous concessions to English trade, but of which one condition was that it should be confirmed by his government before a certain date. In January 1666 Fanshawe went to Lisbon to procure the adherence of Portugal to this agreement. He

returned to Madrid, having failed in his mission, and was almost immediately recalled by Clarendon on the plea that he had exceeded his instructions. He died very shortly afterwards before leaving Madrid, on the 26th of June 1666. He had a family of fourteen children, of whom five only survived him, Richard, the youngest, succeeding as second baronet and dying unmarried in 1694.

As a translator, whether from the Italian, Latin, Portuguese or Spanish, Fanshawe has a considerable reputation. His *Pastor Fido* and his *Lusiad* have not been superseded by later scholars, and his rendering of the latter is praised by Southey and Sir Richard Burton. As an original poet also the few verses he has left are sufficient evidence of exceptional literary talent.

AUTHORITIES.—*Memoirs of Lady Fanshawe*, written in 1676 and published 1829 (from an inaccurate transcript); these were reprinted from the original manuscript and edited by H. C. Fanshawe (London, 1907); article in the *Dict. of Nat. Biography* and authorities there quoted; *Biographia Brit.* (Kippis); *Original Letters of Sir R. F.* (2 vols., 1724), the earlier edition of 1702 with portrait being only vol. i. of this edition; *Notes Genealogical and Historical of the Fanshawe Family* (1868-1872); funeral sermon by H. Bagshaw; *Nicholas Papers* (Camden Society); *Quarterly Review*, xxvii. 1; *Macmillan's Mag.* lvii. 279; *Camoen's Life and Lusiards*, by Sir F. Burton, i. 135; Clarendon's *State Papers, Calendars of State Papers, Autobiography and Hist. of the Rebellion*; *Athenaeum* (1883), i. 121; *Add. MSS. British Museum*, 15,228 (poems); *Harl. MSS. Brit. Mus.* 7010 (letters). (P. C. Y.)

FANTAN, a form of gambling highly popular among the Chinese. The game is simple. A square is marked in the centre of an ordinary table, or a square piece of metal is laid on it, the sides being marked 1, 2, 3 and 4. The banker puts on the table a double handful of small coins—in China "cash"—or similar articles, which he covers with a metal bowl. The players bet on the numbers, setting their stakes on the side of the square which bears the number selected. When all have staked, the bowl is removed, and the banker or croupier with a small stick removes coins from the heap, four at a time, till the final batch is reached. If it contains four coins, the backer of No. 4 wins; if three, the backer of No. 3 wins, and so on. Twenty-five per cent is deducted from the stake by the banker, and the winner receives five times the amount of his stake thus reduced. In Macao, the Monte Carlo of China, play goes on day and night, every day of the week, and bets can be made from 5 cents to 500 dollars, which are the limits.

Fantan is also the name of a card game, played with an ordinary pack, by any number of players up to eight. The deal decided, the cards are dealt singly, any that are left over forming a stock, and being placed face downwards on the table. Each player contributes a fixed stake or "ante." The first player can enter if he has an ace; if he has not he pays an "ante" and takes a card from the stock; the second player is then called upon and acts similarly till an ace is played. This (and the other aces when played) is put face upwards on the table, and the piles are built up from the ace to the king. The pool goes to the player who first gets rid of all his cards. If a player fails to play, having a playable card, he is fined the amount of the ante for every card in the other players' hands.

FANTASIA (Italian for "fantasy," a causing to be seen, from Greek, *φαίνω*, to show), a name in music sometimes loosely used for a composition which has little structural form, and appears to be an improvisation; and also for a combination or medley of familiar airs connected together with original passages of more or less brilliance. The word, however, was originally applied to more formal compositions, based on the madrigal, for several instruments. Fantasias appear as distinct compositions in Bach's works, and also joined to a fugue, as in the "Great Fantasia and Fugue" in A minor, and the "Fantasia cromatica" in D minor. Brahms used the name for his shorter piano pieces. It is also applied to orchestral compositions "not long enough to be called symphonic poems and not formal enough to be called overtures" (Sir C. Hubert Parry, in *Grove's Dictionary of Music*, ed. 1906). The Italian word is still used in Tunis, Algeria and Morocco, with the meaning of "showing off," for an acrobatic exhibition of horsemanship by the Arabs.

The riders fire their guns, throw them and their lances into the air, and catch them again, standing or kneeling in the saddle, all at a full gallop.

FANTI, MANFREDO (1806-1865), Italian general, was born at Carpi and educated at the military college of Modena. In 1831 he was implicated in the revolutionary movement organized by Ciro Menotti (see FRANCIS IV., of Modena), and was condemned to death and hanged in effigy, but escaped to France, where he was given an appointment in the French corps of engineers. In 1833 he took part in Mazzini's abortive attempt to invade Savoy, and in 1835 he went to Spain to serve in Queen Christina's army against the Carlists. There he remained for thirteen years, distinguishing himself in battle and rising to a high staff appointment. But on the outbreak of the war between Piedmont and Austria in 1848 he hurried back to Italy, and although at first his services were rejected both by the Piedmontese government and the Lombard provisional government, he was afterwards given the command of a Lombard brigade. In the general confusion following on Charles Albert's defeat on the Mincio and his retreat to Milan, where the people rose against the unhappy king, Fanti's courage and tact saved the situation. He was elected member of the Piedmontese chamber in 1849, and on the renewal of the campaign he again commanded a Lombard brigade under General Ramorino. After the Piedmontese defeat at Novara (23rd of March) peace was made, but a rising broke out at Genoa, and Fanti with great difficulty restrained his Lombards from taking part in it. But he was suspected as a Mazzinian and a soldier of fortune by the higher Piedmontese officers, and they insisted on his being court-martialled for his operations under Ramorino (who had been tried and shot). Although honourably acquitted, he was not employed again until the Crimean expedition of 1855. In the second Austrian war in 1859 Fanti commanded the 2nd division, and contributed to the victories of Palestro, Magenta and San Martino. After the peace of Villafranca he was sent to organize the army of the Central Italian League (composed of the provisional governments of Tuscany, Modena, Parma and Romagna), and converted it in a few months into a well-drilled body of 45,000 men, whose function was to be ready to intervene in the papal states on the outbreak of a revolution. He showed statesmanlike qualities in steering a clear course between the exaggerated prudence of Baron Ricasoli, who wished to recall the troops from the frontier, and the impetuosity of Garibaldi, his second-in-command, who was anxious to invade Romagna prematurely, even at the risk of Austrian intervention. Fanti's firmness led to Garibaldi's resignation. In January 1860 Fanti became minister of war and marine under Cavour, and incorporated the League's army in that of Piedmont. In the meanwhile Garibaldi had invaded Sicily with his Thousand, and King Victor Emmanuel decided at last that he too must intervene; Fanti was given the chief command of a strong Italian force which invaded the papal states, seized Ancona and other fortresses, and defeated the papal army at Castelfidardo, where the enemy's commander, General Lamoricière, was captured. In three weeks Fanti had conquered the Marche and Umbria and taken 28,000 prisoners. When the army entered Neapolitan territory the king took the chief command, with Fanti as chief of the staff. After defeating a large Neapolitan force at Mola and organizing the siege operations round Gaeta, Fanti returned to the war office at Turin to carry out important army reforms. His attitude in opposing the admission of Garibaldi's 7000 officers into the regular army with their own grades made him the object of great unpopularity for a time, and led to a severe reprimand from Cavour. On the death of the latter (7th of June 1861) he resigned office and took command of the VII. army corps. But his health had now broken down, and after four years' suffering he died in Florence on the 5th of April 1865. His loss was greatly felt in the war of 1866.

See Carandini, *Vita di M. Fanti* (Verona, 1872); A. Di Giorgio, *Il Generale M. Fanti* (Florence, 1906). (L.V.)*

FANTI, a nation of Negroes, inhabiting part of the seaboard of the Gold Coast colony, British West Africa, and about 20,000

sq. m. of the interior. They number about a million. They have many traditions of early migrations. It seems probable that the Fanti and Ashanti were originally one race, driven from the north-east towards the sea by more powerful races, possibly the ancestors of Fula and Hausa. There are many words in Fanti for plants and animals not now existing in the country, but which abound in the Gurunsi and Moshi countries farther north. These regions have been always haunted by slave-raiders, and possibly these latter may have influenced the exodus. At any rate, the Fanti were early driven into the forests from the open plains and slopes of the hills. The name Fanti, an English version of *Mfantsi*, is supposed to be derived from *fan*, a wild cabbage, and *ti, di or dz*, to eat; the story being that upon the exile of the tribe the only available food was some such plant. They are divided into seven tribes, obviously totemic, and with rules as to exogamy still in force. (1) *Kwonna*, buffalo; (2) *Etchwi*, leopard; (3) *Eso*, bush-cat; (4) *Nitchwa*, dog; (5) *Nnuna*, parrot; (6) *Ebradzi*, lion; and (7) *Abrutu*, corn-stalk; these names are obsolete, though the meanings are known. The tribal marks are three gashes in front of the ear on each side in a line parallel to the jaw-bone. The Fanti language has been associated by A. B. Ellis with the Ashanti speech as the principal descendant of an original language, possibly the Tshi (pronounced Tchwi), which is generally considered as the parent of Ashanti, Fanti, Akim, Akwapim and modern Tshi.

The average Fanti is of a dull brown colour, of medium height, with negroid features. Some of the women, when young, are quite pretty. The women use various perfumes, one of the most usual being prepared from the excrement of snakes. There are no special initiatory rites for the youthful Fanti, only a short seclusion for girls when they reach the marriageable age. Marriage is a mere matter of sale, and the maidens are tricked out in all the family finery and walk round the village to indicate that they are ready for husbands. The marriages frequently end in divorce. Polygamy is universally practised. The care of the children is left exclusively to the mothers, who are regarded by the Fanti with deep veneration, while little attention is paid to the fathers. Wives never eat with their husbands, but always with the children. The rightful heir in native law is the eldest nephew, *i.e.* the eldest sister's eldest son, who invariably inherits wives, children and all property. As to tenure of land, the source of ownership of land is derived from the possession of the chief's "stool," which is, like the throne of a king, the symbol of authority, and not even the chief can alienate the land from the stool. Females may succeed to property, but generally only when the acquisition of such property is the result of their succeeding to the stool of a chief. The Fanti are not permanent cultivators of the soil. Three or at most five years will cover the period during which land is continuously cultivated. The commonest native dishes are palm-oil chop, a bowl of palm oil, produced by boiling freshly ground palm nuts, in which a fowl or fish is then cooked; and *fūū*, "white," a boiled mash of yams or plantains. The Fanti have a taste for shark-flesh, called locally "stink-fish." It is sliced up and partly sun-dried, and is eaten in a putrid state. The Fanti are skilful sailors and fishermen, build excellent canoes, and are expert weavers. Pottery and goldsmithery are trades also followed. Their religion is fetishism, every Fanti having his own "fetish" or familiar spirit, but there is a belief in a beneficent Creative Being. Food is offered the dead, and a ceremony of purification is said to be indulged in at funerals, the bearers and mourners plunging into the sea or river after the interment.

See *Journal of Anthropological Institute of Great Britain*, vol. 26, pp. 128 et seq.; A. B. Ellis, *The Tshi-speaking Peoples of the Gold Coast* (London, 1887).

FANTIN-LATOURE, IGNACE HENRI JEAN THÉODORE (1836-1904), French artist, was born at Grenoble on the 14th of January 1836. He studied first with his father, a pastel painter, and then at the drawing school of Lecoq de Boisbaudran, and later under Couture. He was the friend of Ingres, Delacroix, Corot, Courbet and others. He exhibited in the Salon of 1861, and many of his more important canvases appeared on its walls

in later years, though 1863 found him with Harpignies, Manet, Legros and Whistler in the Salon des Refusés. Whistler introduced him to English artistic circles, and he lived for some time in England, many of his portraits and flower pieces being in English galleries. He died on the 28th of August 1904. His portrait groups, arranged somewhat after the manner of the Dutch masters, are as interesting from their subjects as they are from the artistic point of view. "*Hommage à Delacroix*" showed portraits of Whistler and Legros, Baudelaire, Champfleury and himself; "*Un Atelier à Batignolles*" gave portraits of Monet, Manet, Zola and Renoir, and is now in the Luxembourg; "*Un Coin de table*" presented Verlaine, Rimbaud, Camille Peladan and others; and "*Autour du Piano*" contained portraits of Chabrier, D'Indy and other musicians. His paintings of flowers are perfect examples of the art, and form perhaps the most famous section of his work in England. In his later years he devoted much attention to lithography, which had occupied him as early as 1862, but his examples were then considered so revolutionary, with their strong lights and black shadows, that the printer refused to execute them. After "*L'Anniversaire*" in honour of Berlioz in the Salon of 1876, he regularly exhibited lithographs, some of which were excellent examples of delicate portraiture, others being elusive and imaginative drawings illustrative of the music of Wagner (whose cause he championed in Paris as early as 1864), Berlioz, Brahms and other composers. He illustrated Adolphe Jullien's *Wagner* (1886) and *Berlioz* (1888). There are excellent collections of his lithographic work at Dresden, in the British Museum, and a practically complete set given by his widow to the Louvre. Some were also exhibited at South Kensington in 1898-1899, and at the Dutch gallery in 1904.

A catalogue of the lithographs of Fantin-Latour was drawn up by Germain Hédiard in *Les Maîtres de la lithographie* (1898-1899). A volume of reproductions, in a limited edition, was published (Paris, 1907) as *L'Œuvre lithographique de Fantin-Latour*. See A. Jullien, *Fantin-Latour, sa vie et ses amitiés* (Paris, 1909).

FANUM FORTUNAE (mod. *Fano*), an ancient town of Umbria, Italy, at the point where the Via Flaminia reaches the N.E. coast of Italy. Its name shows that it was of Roman origin, but of its foundation we know nothing. It is first mentioned, with Pisaurum and Ancona, as held by Julius Caesar in 49 B.C. Augustus planted a colony there, and round it constructed a wall (of which some remains exist), as is recorded in the inscription on the triple arch erected in his honour at the entrance to the town (A.D. 9-10), which is still standing. Vitruvius tells us that there was, during Augustus's lifetime, a temple in his honour and a temple of Jupiter, and describes a basilica of which he himself was the architect. The arch of Augustus bears a subsequent inscription in honour of Constantine, added after his death by L. Turcius Secundus, *corrector Flaminiae et Piceni*, who also constructed a colonnade above the arch. Several Roman statues and heads, attributable to members of the Julio-Claudian dynasty, were found in the convent of S. Filippo in 1899. These and other objects are now in the municipal museum (E. Brizio in *Notizie degli scavi*, 1899, 249 seq.). Of the temple of Fortune from which the town took its name no traces have been discovered. (T. As.)

FAN VAULT, in architecture, a method of vaulting used in the Perpendicular style, of which the earliest example is found in the cloisters of Gloucester cathedral, built towards the close of the 14th century. The ribs are all of one curve and equidistant, and their divergency, resembling that of an open fan, has suggested the name. One of the finest examples, though of later date (1640), is the vault over the staircase of Christ Church, Oxford. For the origin of its development see VAULT.

FĀRĀBĪ [Abū Naṣr Muḥammad ibn Tarkhān ul-Fārābī] (ca. 870-950), Arabian philosopher, was born of Turkish stock at Fārāb in Turkestan, where also he spent his youth. Thence he journeyed to Bagdad, where he learned Arabic and gave himself to the study of mathematics, medicine and philosophy, especially the works of Aristotle. Later he went to the court of the Ḥamdānī Saif addaula, from whom he received a warm welcome and a small pension. Here he lived a quiet if not an ascetic life.

He died in Damascus, whither he had gone with his patron. His works are very clear in style, though aphoristic rather than systematic in the treatment of subjects. Unfortunately the success of Avicenna seems to have led to the neglect of much of his work. In Europe his compendium of Aristotle's *Rhetoric* was published at Venice, 1484. Two of his smaller works appear in *Alfarabii opera omnia* (Paris, 1638), and two are translated in F. A. Schmölders' *Documenta philosophiae Arabum* (Bonn, 1836). More recently Fr. Dieterici has published at Leiden: *Alfarabi's philosophische Abhandlungen* (1890; German trans. 1892); *Alfarabi's Abhandlung des Musterstaats* (1895; German trans. with an essay "Über den Zusammenhang der arabischen und griechischen Philosophie," 1900); *Die Staatsleitung von Alfarabi* in German, with an essay on "Das Wesen der arabischen Philosophie" (1904).

For Fārābī's life see McG. de Slane's translation of Ibn Khallikān (vol. 3, pp. 307 ff.); and for further information as to his works M. Steinschneider's article in the *Mémoires de l'Académie* (St Petersburg, série 7, tom. 13, No. 4, 1869); and C. Brockelmann's *Gesch. der arab. Litteratur*, vol. i. (Weimar, 1898), pp. 210-213. (G. W. T.)

FARADAY, MICHAEL (1791-1867), English chemist and physicist, was born at Newington, Surrey, on the 22nd of September 1791. His parents had migrated from Yorkshire to London, where his father worked as a blacksmith. Faraday himself became apprenticed to a bookbinder. The letters written to his friend Benjamin Abbott at this time give a lucid account of his aims in life, and of his methods of self-culture, when his mind was beginning to turn to the experimental study of nature. In 1812 Mr Dance, a customer of his master, took him to hear four lectures by Sir Humphry Davy. Faraday took notes of these lectures, and afterwards wrote them out in a fuller form. Under the encouragement of Mr Dance, he wrote to Sir H. Davy, enclosing these notes. "The reply was immediate, kind and favourable." He continued to work as a journeyman bookbinder till the 1st of March 1813, when he was appointed assistant in the laboratory of the Royal Institution of Great Britain on the recommendation of Davy, whom he accompanied on a tour through France, Italy and Switzerland from October 1813 to April 1815. He was appointed director of the laboratory in 1825; and in 1833 he was appointed Fullerian professor of chemistry in the institution for life, without the obligation to deliver lectures. He thus remained in the institution for fifty-four years. He died at Hampton Court on the 25th of August 1867.

Faraday's earliest chemical work was in the paths opened by Davy, to whom he acted as assistant. He made a special study of chlorine, and discovered two new chlorides of carbon. He also made the first rough experiments on the diffusion of gases, a phenomenon first pointed out by John Dalton, the physical importance of which was more fully brought to light by Thomas Graham and Joseph Loschmidt. He succeeded in liquefying several gases; he investigated the alloys of steel, and produced several new kinds of glass intended for optical purposes. A specimen of one of these heavy glasses afterwards became historically important as the substance in which Faraday detected the rotation of the plane of polarization of light when the glass was placed in the magnetic field, and also as the substance which was first repelled by the poles of the magnet. He also endeavoured with some success to make the general methods of chemistry, as distinguished from its results, the subject of special study and of popular exposition. See his work on *Chemical Manipulation*.

But Faraday's chemical work, however important in itself, was soon completely overshadowed by his electrical discoveries. The first experiment which he has recorded was the construction of a voltaic pile with seven halfpence, seven disks of sheet zinc, and six pieces of paper moistened with salt water. With this pile he decomposed sulphate of magnesia (first letter to Abbott, July 12, 1812). Henceforward, whatever other subjects might from time to time claim his attention, it was from among electrical phenomena that he selected those problems to which he applied the full force of his mind, and which he kept persistently in view,

even when year after year his attempts to solve them had been baffled.

His first notable discovery was the production of the continuous rotation of magnets and of wires conducting the electric current round each other. The consequences deducible from the great discovery of H. C. Oersted (21st July 1820) were still in 1821 apprehended in a somewhat confused manner even by the foremost men of science. Dr W. H. Wollaston indeed had formed the expectation that he could make the conducting wire rotate on its own axis, and in April 1821 he came with Sir H. Davy to the laboratory of the Royal Institution to make an experiment. Faraday was not there at the time, but coming in afterwards he heard the conversation on the expected rotation of the wire.

In July, August and September of that year Faraday, at the request of R. Phillips, the editor of the *Annals of Philosophy*, wrote for that journal an historical sketch of electro-magnetism, and he repeated almost all the experiments he described. This led him in the beginning of September to discover the method of producing the continuous rotation of the wire round the magnet, and of the magnet round the wire. He did not succeed in making the wire or the magnet revolve on its own axis. This first success of Faraday in electro-magnetic research became the occasion of the most painful, though unfounded, imputations against his honour. Into these we shall not enter, referring the reader to the *Life of Faraday*, by Dr Bence Jones.

We may remark, however, that although the fact of the tangential force between an electric current and a magnetic pole was clearly stated by Oersted, and clearly apprehended by A. M. Ampère, Wollaston and others, the realization of the continuous rotation of the wire and the magnet round each other was a scientific puzzle requiring no mean ingenuity for its original solution. For on the one hand the electric current always forms a closed circuit, and on the other the two poles of the magnet have equal but opposite properties, and are inseparably connected, so that whatever tendency there is for one pole to circulate round the current in one direction is opposed by the equal tendency of the other pole to go round the other way, and thus the one pole can neither drag the other round and round the wire nor yet leave it behind. The thing cannot be done unless we adopt in some form Faraday's ingenious solution, by causing the current, in some part of its course, to divide into two channels, one on each side of the magnet, in such a way that during the revolution of the magnet the current is transferred from the channel in front of the magnet to the channel behind it, so that the middle of the magnet can pass across the current without stopping it, just as Cyrus caused his army to pass dryshod over the Gyndes by diverting the river into a channel cut for it in his rear.

We must now go on to the crowning discovery of the induction of electric currents.

In December 1824 he had attempted to obtain an electric current by means of a magnet, and on three occasions he had made elaborate but unsuccessful attempts to produce a current in one wire by means of a current in another wire or by a magnet. He still persevered, and on the 29th of August 1831 he obtained the first evidence that an electric current can induce another in a different circuit. On the 23rd of September he writes to his friend R. Phillips: "I am busy just now again on electro-magnetism, and think I have got hold of a good thing, but can't say. It may be a weed instead of a fish that, after all my labour, I may at last pull up." This was his first successful experiment. In nine more days of experimenting he had arrived at the results described in his first series of "Experimental Researches" read to the Royal Society on the 24th of November 1841. By the intense application of his mind he had thus brought the new idea, in less than three months from its first development, to a state of perfect maturity.

During his first period of discovery, besides the induction of electric currents, Faraday established the identity of the electrification produced in different ways; the law of the definite electrolytic action of the current; and the fact, upon which he

laid great stress, that every unit of positive electrification is related in a definite manner to a unit of negative electrification, so that it is impossible to produce what Faraday called "an absolute charge of electricity" of one kind not related to an equal charge of the opposite kind. He also discovered the difference of the capacities of different substances for taking part in electric induction. Henry Cavendish had before 1773 discovered that glass, wax, rosin and shellac have higher specific inductive capacities than air, and had actually determined the numerical ratios of these capacities, but this was unknown both to Faraday and to all other electricians of his time, since Cavendish's *Electrical Researches* remained unpublished till 1879.

The first period of Faraday's electrical discoveries lasted ten years. In 1841 he found that he required rest, and it was not till 1845 that he entered on his second great period of research, in which he discovered the effect of magnetism on polarized light, and the phenomena of diamagnetism.

Faraday had for a long time kept in view the possibility of using a ray of polarized light as a means of investigating the condition of transparent bodies when acted on by electric and magnetic forces. Dr Bence Jones (*Life of Faraday*, vol. i. p. 362) gives the following note from his laboratory book on the 10th of September 1822:—

"Polarized a ray of lamplight by reflection, and endeavoured to ascertain whether any depolarizing action (was) exerted on it by water placed between the poles of a voltaic battery in a glass cistern; one Wollaston's trough used; the fluids decomposed were pure water, weak solution of sulphate of soda, and strong sulphuric acid; none of them had any effect on the polarized light, either when out of or in the voltaic circuit, so that no particular arrangement of particles could be ascertained in this way."

Eleven years afterwards we find another entry in his notebook on the 2nd of May 1833 (*Life*, by Dr Bence Jones, vol. ii. p. 29). He then tried not only the effect of a steady current, but the effect on making and breaking contact.

"I do not think, therefore, that decomposing solutions or substances will be found to have (as a consequence of decomposition or arrangement for the time) any effect on the polarized ray. Should now try non-decomposing bodies, as solid nitre, nitrate of silver, borax, glass, &c., whilst solid, to see if any internal state induced, which by decomposition is destroyed, *i.e.* whether, when they cannot decompose, any state of electrical tension is present. My borate of glass good, and common electricity better than voltaic."

On the 6th of May he makes further experiments, and concludes: "Hence I see no reason to expect that any kind of structure or tension can be rendered evident, either in decomposing or non-decomposing bodies, in insulating or conducting states."

At last, in 1845, Faraday attacked the old problem, but this time with complete success. Before we describe this result we may mention that in 1862 he made the relation between magnetism and light the subject of his very last experimental work. He endeavoured, but in vain, to detect any change in the lines of the spectrum of a flame when the flame was acted on by a powerful magnet.

This long series of researches is an instance of his persistence. His energy is shown in the way in which he followed up his discovery in the single instance in which he was successful. The first evidence which he obtained of the rotation of the plane of polarization of light under the action of magnetism was on the 13th of September 1845, the transparent substance being his own heavy glass. He began to work on the 30th of August 1845 on polarized light passing through electrolytes. After three days he worked with common electricity, trying glass, heavy optical glass, quartz, Iceland spar, all without effect, as on former trials. On the 13th of September he worked with lines of magnetic force. Air, flint, glass, rock-crystal, calcareous spar were examined, but without effect.

"Heavy glass was experimented with. It gave no effects when the *same magnetic poles* or the *contrary poles* were on opposite sides (as respects the course of the polarized ray), nor when the same poles were on the same side either with the constant or intermitting current. But when contrary magnetic poles were on the same side there was an effect produced on the polarized ray, and thus magnetic force and light were proved to have relations to each other. This

fact will most likely prove exceedingly fertile, and of great value in the investigation of the conditions of natural force."

He immediately goes on to examine other substances, but with "no effect," and he ends by saying, "Have got enough for to-day." On the 18th of September he "does an excellent day's work." During September he had four days of work, and in October six, and on the 6th of November he sent in to the Royal Society the nineteenth series of his "Experimental Researches," in which the whole conditions of the phenomena are fully specified. The negative rotation in ferro-magnetic media is the only fact of importance which remained to be discovered afterwards (by M. E. Verdet in 1856).

But his work for the year was not yet over. On the 3rd of November a new horseshoe magnet came home, and Faraday immediately began to experiment on the action in the polarized ray through gases, but with no effect. The following day he repeated an experiment which had given no result on the 6th of October. A bar of heavy glass was suspended by silk between the poles of the new magnet. "When it was arranged, and had come to rest, I found I *could* affect it by the magnetic forces and give it position." By the 6th of December he had sent in to the Royal Society the twentieth, and on the 24th of December the twenty-first, series of his "Researches," in which the properties of diamagnetic bodies are fully described. Thus these two great discoveries were elaborated, like his earlier one, in about three months.

The discovery of the magnetic rotation of the plane of polarized light, though it did not lead to such important practical applications as some of Faraday's earlier discoveries, has been of the highest value to science, as furnishing complete dynamical evidence that wherever magnetic force exists there is matter, small portions of which are rotating about axes parallel to the direction of that force.

We have given a few examples of the concentration of his efforts in seeking to identify the apparently different forces of nature, of his far-sightedness in selecting subjects for investigation, of his persistence in the pursuit of what he set before him, of his energy in working out the results of his discoveries, and of the accuracy and completeness with which he made his final statement of the laws of the phenomenon.

These characteristics of his scientific spirit lie on the surface of his work, and are manifest to all who read his writings. But there was another side of his character, to the cultivation of which he paid at least as much attention, and which was reserved for his friends, his family and his church. His letters and his conversation were always full of whatever could awaken a healthy interest, and free from anything that might rouse ill-feeling. When, on rare occasions, he was forced out of the region of science into that of controversy, he stated the facts and let them make their own way. He was entirely free from pride and undue self-assertion. During the growth of his powers he always thankfully accepted a correction, and made use of every expedient, however humble, which would make his work more effective in every detail. When at length he found his memory failing and his mental powers declining, he gave up, without ostentation or complaint, whatever parts of his work he could no longer carry on according to his own standard of efficiency. When he was no longer able to apply his mind to science, he remained content and happy in the exercise of those kindly feelings and warm affections which he had cultivated no less carefully than his scientific powers.

The parents of Faraday belonged to the very small and isolated Christian sect which is commonly called after Robert Sandeman. Faraday himself attended the meetings from childhood; at the age of thirty he made public profession of his faith, and during two different periods he discharged the office of elder. His opinion with respect to the relation between his science and his religion is expressed in a lecture on mental education delivered in 1854, and printed at the end of his *Researches in Chemistry and Physics*.

"Before entering upon the subject, I must make one distinction which, however it may appear to others, is to me of the utmost importance. High as man is placed above the creatures around

him, there is a higher and far more exalted position within his view; and the ways are infinite in which he occupies his thoughts about the fears, or hopes, or expectations of a future life. I believe that the truth of that future cannot be brought to his knowledge by any exertion of his mental powers, however exalted they may be; that it is made known to him by other teaching than his own, and is received through simple belief of the testimony given. Let no one suppose for an instant that the self-education I am about to commend, in respect of the things of this life, extends to any considerations of the hope set before us, as if man by reasoning could find out God. It would be improper here to enter upon this subject further than to claim an absolute distinction between religious and ordinary belief. I shall be reproached with the weakness of refusing to apply those mental operations which I think good in respect of high things to the very highest. I am content to bear the reproach. Yet even in earthly matters I believe that 'the invisible things of Him from the creation of the world are clearly seen, being understood by the things that are made, even His eternal power and Godhead'; and I have never seen anything incompatible between those things of man which can be known by the spirit of man which is within him and those higher things concerning his future, which he cannot know by that spirit."

Faraday gives the following note as to this lecture:—

"These observations were delivered as a lecture before His Royal Highness the Prince Consort and the members of the Royal Institution on the 6th of May 1854. They are so immediately connected in their nature and origin with my own experimental life, considered either as cause or consequence, that I have thought the close of this volume not an unfit place for their reproduction."

As Dr Bence Jones concludes—

"His standard of duty was supernatural. It was not founded on any intuitive ideas of right and wrong, nor was it fashioned upon any outward experiences of time and place, but it was formed entirely on what he held to be the revelation of the will of God in the written word, and throughout all his life his faith led him to act up to the very letter of it."

Published Works.—*Chemical Manipulation, being Instructions to Students in Chemistry* (1 vol., John Murray, 1st ed. 1827, 2nd 1830, 3rd 1842); *Experimental Researches in Electricity*, vols. i. and ii., Richard and John Edward Taylor, vols. i. and ii. (1844 and 1847); vol. iii. Richard Taylor and William Francis (1855); *Experimental Researches in Chemistry and Physics*, Taylor and Francis (1859); *Lectures on the Chemical History of a Candle* (edited by W. Crookes) (Griffin, Bohn & Co., 1861); *On the Various Forces in Nature* (edited by W. Crookes) (Chatto & Windus, no date).

BIOGRAPHIES.—*Faraday as a Discoverer*, by John Tyndall (Longmans, 1st ed. 1868, 2nd ed. 1870); *The Life and Letters of Faraday*, by Dr Bence Jones, secretary of the Royal Institution, in 2 vols. (Longmans, 1870); *Michael Faraday*, by J. H. Gladstone, Ph.D., F.R.S. (Macmillan, 1872); *Michael Faraday; his Life and Work*, by S. P. Thompson (1898). (J. C. M.)

FARAH, a river of Afghanistan. It rises in the southern slopes of Siah-Koh, which forms the southern wall of the valley of Herat, and after a south-westerly course of about 200 m. falls into the Seistan Hamun. At the town of Farah it has a width of 150 yds. in the dry season with 2 ft. of water and a clear swift stream. It is liable to floods, when it becomes impassable for weeks. The lower valley of the Farah Rud is fertile and well cultivated.

FARAH, a town of Afghanistan. It is situated on the river that bears its name on the main road between Herat and Kandahar, 160 m. S. of Herat and 225 m. W. of Kandahar. It is a place of some strategical importance, as it commands the approaches to India and Seistan from Herat. The town (2460 ft. above sea-level) is a square walled enclosure standing in the middle of the plain, surrounded with a walled rampart. Owing to its unhealthiness it is now almost deserted, being only occupied by the Afghan regiment quartered there. It is a place of great antiquity, being probably the Phra mentioned by Isidore of Charax in the 1st century A.D. It was sacked by the armies of Jenghiz Khan, and the survivors transported to a position farther north, where there are still great ruins. The population returned to the original site after the destruction of the medieval city by Shah Abbas, and the city prospered again until its bloody siege by Nadir Shah. Subsequently under constant attacks it declined, and in 1837 the population amounting to 6000 was carried off to Kandahar. The sole industry of the town at present is the manufacture of gunpowder. In the districts east of Farah are to be found the most fanatical of the Durani Afghan tribes.

FARAZDAQ [Hammām ibn Ghālib ibn Sa'sa', known as al-Farazdaq] (ca. 641—ca. 728), Arabian poet, was born at Basra. He was of the Dārim, one of the most respected divisions of the bani Tamīm, and his mother was of the tribe of Dabba. His grandfather Sa'sa' was a Bedouin of great repute, his father Ghālib followed the same manner of life until Basra was founded, and was famous for his generosity and hospitality. At the age of fifteen Farazdaq was known as a poet, and though checked for a short time by the advice of the caliph Ali to devote his attention to the study of the Koran, he soon returned to making verse. In the true Bedouin spirit he devoted his talent largely to satire and attacked the bani Nahshal and the bani Fuqaim. When Ziyād, a member of the latter tribe, became governor of Basra, the poet was compelled to flee, first to Kufa, and then, as he was still too near Ziyād, to Medina, where he was well received by Sa'id ibn ul-Āsi. Here he remained about ten years, writing satires on Bedouin tribes, but avoiding city politics. But he lived a prodigal life, and his amorous verses led to his expulsion by the caliph Merwan I. Just at that time he learned of the death of Ziyād and returned to Basra, where he secured the favour of Ziyād's successor 'Obaidallāh ibn Ziyād. Much of his poetry was now devoted to his matrimonial affairs. He had taken advantage of his position as guardian and married his cousin Nawār against her will. She sought help in vain from the court of Basra and from various tribes. All feared the poet's satires. At last she fled to Mecca and appealed to the pretender 'Abdallah ibn Zobair, who, however, succeeded in inducing her to consent to a confirmation of the marriage. Quarrels soon arose again. Farazdaq took a second wife, and after her death a third, to annoy Nawār. Finally he consented to a divorce pronounced by Hasan al-Baṣri. Another subject occasioned a long series of verses, namely his feud with his rival Jarīr (*q.v.*) and his tribe the bani Kulaib. These poems are published as the *Naka'id of Jarīr and al-Farazdaq* (ed. A. A. Bevan, Leiden, 1906 ff.). In political life Farazdaq was prevented by fear from taking a large part. He seems, however, to have been attached to the house of Ali. During the reign of Moawiya I. he avoided politics, but later gave his allegiance to 'Abdallah ibn Zobair.

The fullest account of his life is contained in J. Hell's *Das Leben Farazdaq nach seinen Gedichten* (Leipzig, 1903); Arabian stories of him in the *Kitab ul-Aghāni* and in Ibn Khallikān. A portion of his poems was edited with French translation by R. Boucher (Paris, 1870); the remainder have been published by J. Hell (Munich, 1900). (G. W. T.)

FARCE, a form of the comic in dramatic art, the object of which is to excite laughter by ridiculous situations and incidents rather than by imitation with intent to ridicule, which is the province of burlesque, or by the delineation of the play of character upon character, which is that of comedy. The history of the word is interesting. Its ultimate origin is the Latin *farciare*, to stuff, and with the meaning of "stuffing" or forcemeat it appears in old cookery books in English. In medieval Latin *farsa* and *farsia* were applied to the expansion of the *Kyrie eleison* in litanies, &c., by interpolating words and phrases between those two words; later, to words, phrases and rhymed verses, sometimes in the vernacular, also interpolated in various parts of the service. The French *farce*, the form to which we owe our word, was originally the "gag" that the actors in the medieval drama inserted into their parts, generally to meet the popular demand for a lightening of humour or buffoonery. It has thus been used for the lighter form of comic drama (see **DRAMA**), and also figuratively for a piece of idle buffoonery, sham, or mockery.

FAREHAM, a market town in the Fareham parliamentary division of Hampshire, England, 76 m. S.W. from London by the London & South Western railway. Pop. of urban district (1901) 8246. It lies at the head of a creek opening into the north-western corner of Portsmouth harbour. The principal industries are the manufacture of sackings, ropes, bricks, coarse earthenware, terra-cotta, tobacco-pipes and leather. Fareham has a considerable trade in corn, timber and coal; the creek being accessible to vessels of 300 tons. Three miles E. of Fareham, on Portsmouth harbour, are the interesting ruins of Porchester

Castle, an extensive walled enclosure retaining its Norman keep, and exhibiting in its outer walls considerable evidence of Roman workmanship; Professor Haverfield, however, denies that it occupies the site of the Roman *Portus Magnus*. The church of St Mary has some fine Norman portions. It belonged to an Augustinian priory founded by Henry I. At Titchfield, 3 m. W. of Fareham, are ruins of the beautiful Tudor mansion, Place House, built on the site of a Premonstratensian abbey of the 13th century, of which there are also fragments.

The fact that Fareham (Fernham, Ferham) formed part of the original endowment of the see of Winchester fixes its existence certainly as early as the 9th century. It is mentioned in the Domesday Survey as subject to a reduced assessment on account of its exposed position and liability to Danish attacks. There is evidence to show that Fareham had become a borough before 1264, but no charter can be found. It was a mesne borough held of the bishop of Winchester, but it is probable that during the 18th century the privileges of the burgesses were allowed to lapse, as by 1835 it had ceased to be a borough. Fareham returned two members to the parliament of 1306, but two years later it petitioned against representation on the ground of expense. A fair on the 31st of October and the two following days was held under grant of Henry III. The day appears to have been afterwards changed to the 29th of June, and in the 18th century was mainly important for the sale of toys. It was abolished in 1871. Fareham owed its importance in medieval times to its facilities for commerce. It was a free port and had a considerable trade in wool and wine. Later its shipping declined and in the 16th century it was little more than a fishing village. Its commercial prosperity in modern times is due to its nearness to Portsmouth.

FAREL, GUILLAUME (1489-1565), French reformer, was born of a noble family near Gap in Dauphiné in 1489. His parents meant him for the military profession, but his bent being for study he was allowed to enter the university of Paris. Here he came under the influence of Jacobus Faber (Stapulensis), on whose recommendation he was appointed professor in the college of Cardinal Lemoine. In 1521, on the invitation of Bishop Briçonnet, he repaired to Meaux, and took part in efforts of reform within the Roman communion. The persecuting measures of 1523, from which Faber found a refuge at Meaux, determined Farel to leave France. Oecolampadius welcomed him to Basel, where in 1524 he put forth thirteen theses sharply antagonizing Roman doctrine. These he defended with great ability, but with so much heat that Erasmus joined in demanding his expulsion from the city. He thought of going to Wittenberg, but his first halt was at Strassburg, where Bucer and Capito received him kindly. At the call of Duke Ulrich of Württemberg he went as preacher to Montbéliard. Displaying the same qualities which had driven him from Basel, he was forced to leave Montbéliard in the spring of 1525.

He retraced his steps to Strassburg and Basel; and, at the end of 1526, obtained a preacher's post at Aigle, then a dependency of Bern. Deeming it wise to suppress his name, he adopted the pseudonym Ursinus, with reference to his protection by Bern. Despite strenuous opposition by the monastic orders, he obtained in 1528 a licence from the authorities to preach anywhere within the canton of Bern. He extended his labours to the cantons of Neuchâtel and Vaud. His vehement missionary addresses were met by mob violence, but he persevered with undaunted zeal. In October 1530 he broke into the church of Neuchâtel with an iconoclastic mob, thus planting the Reformation in that city. In 1532 he visited the Waldenses. On the return journey he halted at Geneva, then at a crisis of political and religious strife. On the 30th of June 1532 the council of two hundred had ordained that in every church and cloister of the city "the pure Gospel" should be preached; against this order the bishop's vicar led the opposition. Reaching Geneva in October 1532, Farel (described in a contemporary monastic chronicle as "un chétif malheureux prédicant, nommé maistre Guillaume") at once began to preach in a room of his lodging, and soon attracted "un grand nombre de gens qui estoient advertis de sa venue et déjà infects de son hérésie." Summoned before the bishop's

vicar, his trial was a scene of insult and clamour, ending in his being violently thrust from the court and bidden to leave the city within three hours. He escaped with difficulty to Orbe by boat. Through the intervention of the government of Bern, liberty of worship was granted on the 28th of March 1533 to the Reformation party in Geneva. Farel, returning, achieved in a couple of years a complete supremacy for his followers. On New Year's Day 1534 the bishop interdicted all preaching unauthorized by himself, and ordered the burning of all Protestant Bibles. This was the signal for public disputations in which Farel took the leading part on the Reformation side, with the result that by decree of the 27th of August 1535 the mass was suppressed and the reformed religion established. Calvin, on his way to Basel for a life of study, touched at Geneva, and by the importunity of Farel was there detained to become the leader of the Genevan Reformation. The severity of the disciplinary measures which followed procured a reaction under which Farel and Calvin were banished the city in 1538. Farel was called to Neuchâtel in July 1538, but his position there was made untenable, though he remained at his post during a visitation of the plague. When (1541) Calvin was recalled to Geneva, Farel also returned; but in 1542 he went to Metz to support the Reformation there. It is said that when he preached in the Dominican church of Metz, the bells were rung to drown his voice, but his voice outdid the bells, and on the next occasion he had three thousand hearers. His work was checked by the active hostility of the duke of Lorraine, and in 1544 he returned to Neuchâtel. No one was more frequently and confidentially consulted by Calvin. When the trial of Servetus was in progress (1553), Calvin was anxious for Farel's presence, but he did not arrive till sentence had been passed. He accompanied Servetus to the stake, vainly urging him to a recantation at the last moment. A coolness with Calvin was created by Farel's marriage, at the age of sixty-nine, with a refugee widow from Rouen, of unsuitable age. By her, six years later, he had one son, who died in infancy. The vigour and fervency of his preaching were unabated by length of years. Calvin's death, in 1564, affected him deeply. Yet in his last year he revisited Metz, preaching amid great enthusiasm, with all his wonted fire. The effort was too much for him; he left the church exhausted, took to his bed, and died at Metz on the 13th of September 1565.

Farel wrote much, but usually in haste, and for an immediate purpose. He takes no rank as a scientific theologian, being a man of activity rather than of speculation or of much insight. His *Sommaire* was re-edited from the edition of 1534 by J. G. Baum in 1867. Others of his works (all in French) were his treatise on purgatory (1534), on the Lord's Prayer (1543), on the Supper (1555). He "was remarkable for boldness and energy both in preaching and prayer" (M. Young, *Life of Paleario*). As an orator, he was denunciatory rather than suasive; thus while on the one hand he powerfully impressed, on the other hand he stimulated opposition. A monument to him was unveiled at Neuchâtel on the 4th of May 1876.

Lives of Farel are numerous; it may suffice to mention C. Ancillon, *Vie de G. Farel* (1691); the article in Bayle; M. Kirchhofer, *Das Leben W. Farel's* (1831-1833); Ch. Schmidt, *Études sur Farel* (1834); F. Bevan, *W. Farel* (1893); J. J. Herzog, in *Herzog-Hauck's Realencyklopädie* (1898). (A. Go.*)

FAREY, JOHN (1766-1826), English geologist, was born at Woburn in Bedfordshire in 1766. He was educated at Halifax in Yorkshire, and showed such aptitude in mathematics, drawing and surveying, that he was brought under the notice of John Smeaton (1724-1792). In 1792 he was appointed agent to the duke of Bedford for his Woburn estates. After the decease of the duke, Farey in 1802 removed to London, and settled there as a consulting surveyor and geologist. That he was enabled to take this step was due largely to his acquaintance with William Smith (*q.v.*), who in 1801 had been employed by the duke of Bedford in works of draining and irrigation. The duke, appreciating Smith's knowledge of the strata, commissioned him in 1802 to explore the margin of the chalk-hills south of Woburn in order to determine the true succession of the strata; and he instructed Farey to accompany him. Farey has remarked

that Smith was his "Master and Instructor in Mineral Surveying," and his subsequent publications show how well he had profited by the teachings he received. Farey prepared the *General View of the Agriculture and Minerals of Derbyshire* in two vols. (1811-1813) for the Board of Agriculture. In the first of these volumes (1811) he gave an able account of the upper part of the British series of strata, and a masterly exposition of the Carboniferous and other strata of Derbyshire. In this classic work, and in a paper published in the *Phil. Mag.* vol. li. 1818, p. 173, on "Mr Smith's Geological Claims stated," he zealously called attention to the importance of the discoveries of William Smith. Farey died in London on the 6th of January 1826.

See Biographical Notice, by W. S. Mitchell, in *Geol. Mag.* 1873, p. 25.

FARGO, WILLIAM GEORGE (1818-1881), pioneer American expressman, was born in Pompey, New York, on the 20th of May 1818. From the age of thirteen he had to support himself, obtaining little schooling, and for several years he was a clerk in grocery stores in Syracuse. He became a freight agent for the Auburn & Syracuse railway company at Auburn in 1841, an express messenger between Albany and Buffalo a year later, and in 1843 a resident agent in Buffalo. In 1844 he organized, with Henry Wells (1805-1878) and Daniel Dunning, the first express company (Wells & Co.; after 1845 Livingston & Fargo) to engage in the carrying business west of Buffalo. The lines of this company (which first operated only to Detroit, via Cleveland) were rapidly extended to Chicago, St Louis, and other western points. In March 1850, when through a consolidation of competing lines the American Express Company was organized, Wells became president and Fargo secretary. In 1851, with Wells and others, he organized the firm of Wells, Fargo & Company to conduct an express business between New York and San Francisco by way of the Isthmus of Panama and on the Pacific coast, where it long had a virtual monopoly. In 1861 Wells, Fargo & Co. bought and reorganized the Overland Mail Co., which had been formed in 1857 to carry the United States mails, and of which Fargo had been one of the original promoters. From 1862 to 1866 he was mayor of Buffalo, and from 1868 to his death, in Buffalo, on the 3rd of August 1881, he was president of the American Express Company, with which in 1868 the Merchants Union Express Co. was consolidated. He was a director of the New York Central and of the Northern Pacific railways.

FARGO, a city and the county-seat of Cass county, North Dakota, U.S.A., about 254 m. W. of Duluth, Minnesota. Pop. (1890) 5664; (1900) 9589, of whom 2564 were foreign-born; (1910 census) 14,331. It is served by the Northern Pacific, the Great Northern, and the Chicago, Milwaukee & St Paul railways. The city is situated on the W. bank of the Red river of the North, which in 1909 had a navigable depth of only about 2 ft. from Fargo to Grank Forks, and the navigation of which was obstructed at various places by fixed bridges. In the city are Island and Oakgrove parks, the former of which contains a statue (erected by Norwegians in 1908) of Henrik Arnold Wergeland, the Norwegian poet. Fargo is the seat of the North Dakota agricultural college (coeducational), founded in 1890 under the provisions of the Federal "Morrill Act" of 1862; it receives both Federal and state support (the former under the Morrill Act of 1890), and in connexion with it a United States Agricultural Experiment Station is maintained. In 1907-1908 the college had 988 students in the regular courses (including the students in the Academy), 117 in the summer course in steam engineering, and 68 in correspondence courses. At Fargo, also, are Fargo College (non-sectarian, 1887; founded by Congregationalists), which has a college department, a preparatory department, and a conservatory of music, and in 1908 had 310 students, of whom 211 were in the conservatory of music; the Oak Grove Lutheran ladies' seminary (1906) and the Sacred Heart Academy (Roman Catholic). The city is the see of both a Roman Catholic bishop and a Protestant Episcopal bishop; and it is the centre of masonic interests in the state, having a fine masonic temple. There are a public library and a large Y.M.C.A. building. St

John's hospital is controlled by Roman Catholic sisters, and St Luke's hospital by the Lutheran Church. Fargo is in a rich agricultural (especially wheat) region, is a busy grain-trading and jobbing centre, is one of the most important wholesale distributing centres for agricultural implements and machinery in the United States, and has a number of manufactures, notably flour. The total value of the city's factory products in 1905 was \$1,160,832. Fargo, named in honour of W. G. Fargo of the Wells Fargo Express Company, was first settled as a tent city in 1871, when the Red river was crossed by the Northern Pacific, but was not permanently settled until after the extinction in 1873 of the Indian title to the reservation on which it was situated. It was chartered as a city in 1875. The Milwaukee railway was completed to Fargo in 1884. In June 1893 a large part of the city was destroyed by fire, the loss being more than \$3,000,000.

FARIA Y SOUSA, MANUEL DE (1590-1649), Spanish and Portuguese historian and poet, was born of an ancient Portuguese family, probably at Pombeiro, on the 18th of March 1590, attended the university of Braga for some years, and when about fourteen entered the service of the bishop of Oporto. With the exception of about four years from 1631 to 1634, during which he was a member of the Portuguese embassy in Rome, the greater part of his later life was spent at Madrid, and there he died, after much suffering, on the 3rd of June 1649. He was a laborious, peaceful man; and a happy marriage with Catharina Machado, the Albania of his poems, enabled him to lead a studious domestic life, dividing his cares and affections between his children and his books. His first important work, an *Epitome de las historias Portuguezas* (Madrid, 1628), was favourably received; but some passages in his enormous commentary upon *Os Lusíadas*, the poem of Luis de Camoens, excited the suspicion of the inquisitors, caused his temporary incarceration, and led to the permanent loss of his official salary. In spite of the enthusiasm which is said to have prescribed to him the daily task of twelve folio pages, death overtook him before he had completed his greatest enterprise, a history of the Portuguese in all parts of the world. Several portions of the work appeared at Lisbon after his death, under the editorship of Captain Faria y Sousa:—*Europa Portuguesa* (1667, 3 vols.); *Asia Portuguesa* (1666-1675, 3 vols.); *Africa Portuguesa* (1681). As a poet Faria y Sousa was nearly as prolific; but his poems are vitiated by the prevailing Gongorism of his time. They were for the most part collected in the *Noches claras* (Madrid, 1624-1626), and the *Fuente de Aganipe*, of which four volumes were published at Madrid in 1644-1646. He also wrote, from information supplied by P. A. Semmedo, *Imperio de China i cultura evangelica en él* (Madrid, 1642); and translated and completed the *Nobiliario* of the count of Barcellos.

There are English translations by J. Stevens of the *History of Portugal* (London, 1698), and of *Portuguese Asia* (London, 1695).

FARIBAULT, a city and the county-seat of Rice county, Minnesota, U.S.A., on the Cannon river, at the mouth of the Straight river, about 45 m. S. of St Paul. (Pop. 1890) 6520; (1900) 7868, of whom 1586 were foreign-born; (1905) 8279; (1910) 9001. Faribault is served by the Chicago Great Western, the Chicago, Milwaukee & St Paul, and the Chicago, Rock Island & Pacific railways. The city is attractively situated near a lake region widely known for its summer resorts. Faribault is the seat of the Minnesota institute for defectives, embracing the state school for the deaf (1863), the state school for the blind (1874), and the state school for the feeble-minded (1879); of three institutions under control of the Protestant Episcopal Church—the Seabury divinity school (incorporated 1860), the Shattuck school (1867; incorporated in 1905), a military school for boys, and St Mary's hall (1866), a school for girls, founded by Bishop Whipple; and of the Roman Catholic (Dominican) Bethlehem Academy for girls. In the city are the cathedral of our Merciful Saviour (1868-1869), the first Protestant Episcopal church in the United States built and used as a cathedral from its opening; and the hospital and nurses' training school of the Minnesota District of the Evangelical

Synod. The city has a public library, and owns and operates its own water-supply system. There is a good water power, and among the city's manufactures are flour, beer, shoes, furniture, rattan-ware, warehouse trucks, canned goods, cane syrup, waggons and carriages, gasolene engines, wind-mills, pianos and woollen goods. Faribault, named in honour of Jean Baptiste Faribault, a French fur-trader and pioneer who made his headquarters in the region in the latter part of the 18th century, was permanently settled about 1848, and was chartered as a city in 1872. A French millwright, N. La Croix, introduced here, about 1860, a new process of making flour, which revolutionized the industry in the United States, but his mill was soon destroyed by flood and he removed to Minneapolis, where the process was first successful on a large scale. Faribault was for many years the home of Bishop Henry Benjamin Whipple (1822-1901), the pioneer bishop (1859-1901) of the Protestant Episcopal Church in Minnesota, famous for his missionary work among the Indians.

FARIDKOT, a native state of India in the Punjab. It ranks as one of the Cis-Sutlej states, which came under British influence in 1809. Its area is 642 sq. m., and its population in 1901 was 124,912. It is bounded on the W. and N.E. by the British district of Ferozepore, and on the S. by Nabha state. During the Sikh wars in 1845 the chief, Raja Pahar Singh, exerted himself in the British cause, and was rewarded with an increase of territory. In the Mutiny of 1857, too, his son and successor, Wazir Singh, did good service by guarding the Sutlej ferries, and in attacking a notorious rebel, whose stronghold he destroyed. The estimated gross revenue is £28,300; there is no tribute. The territory is traversed by the Rewari-Ferozepore railway, and also crossed by the Fazilka line, which starts from Kotkapura, the old capital. It is irrigated by a branch of the Sirhind canal. The town of Faridkot has a railway station, 84 m. from Lahore.

FARIDPUR, or **FURREEDPORE**, a town and district of British India, in the Dacca division of eastern Bengal and Assam. The town, which has a railway station, stands on an old channel of the Ganges. Pop. (1901) 11,649. There are a Baptist mission and a government high school. The district comprises an area of 2281 sq. m. The general aspect is flat, tame and uninteresting, although in the northern tract the land is comparatively high, with a light sandy soil, covered with water during the rainy season, but dry during the cold and hot weather. From the town of Faridpur the ground slopes, until in the south, on the confines of Backergunje, it becomes one immense swamp, never entirely dry. During the height of the inundations the whole district may be said to be under water. The villages are built on artificially raised sites, or the high banks of the deltaic streams. Along many of the larger rivers the line of hamlets is unbroken for miles together, so that it is difficult to say where one ends and another begins. The huts, however, except in markets and bazaars, are seldom close together, but are scattered amidst small garden plots, and groves of mango, date and betel-nut trees. The plains between the villages are almost invariably more or less depressed towards the centre, where usually a marsh, or lake, or deep lagoon is found. These marshes, however, are gradually filling up by the silt deposited from the rivers; in the north of the district there now only remain two or three large swamps, and in them the process may be seen going on. The climate of Faridpur is damp, like that of the other districts of eastern Bengal; the average annual rainfall is 66 in. and the average mean temperature 76.0° F.

The principal rivers of Faridpur are the Ganges, the Arial Khan and the Haringhata. The Ganges, or Padma as it is locally called, touches the extreme north-west corner of the district, flows along its northern boundary as far as Goalanda, where it receives the waters of the Jamuna or main stream of the Brahmaputra, and whence the united stream turns southwards and forms the eastern boundary of the district. The river is navigable by large cargo boats throughout the year, and has an average breadth during the rainy season of 1600 yds. Rice is the great crop of the district. In 1901 the population was

1,937,646, showing an increase of 6% in the decade. The north of the district is crossed by the line of the Eastern Bengal railway to Goalanda, the port of the Brahmaputra steamers, and a branch runs to Faridpur town. But most of the trade is conducted by river.

FARĪD UD-DĪN 'ATTĀR, or **FERID EDDIN-ATHAR** (1119-1229), Persian poet and mystic, was born at Nishapur, 513 A.H. (1119 A.D.), and was put to death 627 A.H. (1229 A.D.), thus having reached the age of 110 years. The date of his death is, however, variously given between the years 1193 and 1235, although the majority of authorities support 1229; it is also probable that he was born later than 1119, but before 1150. His real name was Abu Ṭalib (or Abu Ḥamid) Mahommed ben Ibrahim, and Farid ud-dīn was simply an honourable title equivalent to Pearl of Religion. He followed for a time his father's profession of druggist or perfumer, and hence the name 'Attar (one who sold 'itr, otto of roses; hence, simply, dealer in drugs), which he afterwards employed as his poetical designation. According to the account of Dawlatshah, his interest in the great mystery of the higher life of man was awakened in the following way. One day a wandering fakir gazed sadly into his shop, and, when ordered to be gone, replied: "It is nothing for me to go; but I grieve for thee, O druggist, for how wilt thou be able to think of death, and leave all these goods of thine behind thee?" The word was in season; and Mahommed ben Ibrahim the druggist soon gave up his shop and began to study the mystic theosophy of the Sufis under Sheik Rukneddin. So thoroughly did he enter, into the spirit of that religion that he was before long recognized as one of its principal representatives. He travelled extensively, visited Mecca, Egypt, Damascus and India, and on his return was invested with the Sufi mantle by Sheik Majd-ud-din of Bagdad. The greater portion of his life was spent in the town of Shadyakh, but he is not unfrequently named Nishapuri, after the city of his boyhood and youth. The story of his death is a strange one. Captured by a soldier of Jenghiz Khan, he was about to be sold for a thousand dirhems, when he advised his captor to keep him, as doubtless a larger offer would yet be made; but when the second bidder said he would give a bag of horse fodder for the old man, he asserted that he was worth no more, and had better be sold. The soldier, irritated at the loss of the first offer, immediately slew him. A noble tomb was erected over his grave, and the spot acquired a reputation for sanctity. Farid was a voluminous writer, and left no fewer than 120,000 couplets of poetry, though in his later years he carried his asceticism so far as to deny himself the pleasures of poetical composition. His most famous work is the *Mantiḳ uḥfair*, or language of birds, an allegorical poem containing a complete survey of the life and doctrine of the Sufis. It is extremely popular among Mahommedans both of the Sunnite and Shiite sects, and the manuscript copies are consequently very numerous. The birds, according to the poet, were tired of a republican constitution, and longed for a king. As the lapwing, having guided Solomon through the desert, best knew what a king should be, he was asked whom they should choose. The Simorg in the Caucasus, was his reply. But the way to the Caucasus was long and dangerous, and most of the birds excused themselves from the enterprise. A few, however, set out; but by the time they reached the great king's court, their number was reduced to thirty. The thirty birds (*si morg*), wing-weary and hunger-stricken, at length gained access to their chosen monarch the Simorg; but only to find that they strangely lost their identity in his presence—that they are he, and he is they. In such strange fashion does the poet image forth the search of the human soul after absorption into the divine.

The text of the *Mantiḳ uḥfair* was published by Garcin de Tassy in 1857, a summary of its contents having already appeared as *La Poésie philosophique et religieuse chez les Persans* in 1856; this was succeeded by a complete translation in 1863. Among Farid ud-dīn's other works may be mentioned his *Pandnāma* (Book of Counsel), of which a translation by Silvestre de Sacy appeared in 1819; *Bulbul Nama* (Book of the Nightingale); *Wasaiḥ Nama* (Book of Conjunctions); *Khusru va Gul* (The King and the Rose); and *Tadhkiratu 'l Awliyā* (Memoirs of the Saints) (ed. R. A. Nicholson in

Persian Historical Texts). See Sir Gore Ouseley, *Biographical Notices of Persian Poets* (1846), p. 236; Von Hammer Purgstall, *Geschichte der schönen Redekünste Persiens* (Vienna, 1818), p. 140; the *Oriental Collections*, ii. (London, 1798), pp. 84, 124, containing translations of part of the *Pandnāma*; E. H. Palmer, *Oriental Mysticism* (1867); E. G. Browne, *Literary History of Persia* (1906).

FARINA, SALVATORE (1846–), Italian novelist, was born in Sardinia, and after studying law at Turin and Pavia devoted himself to a literary life at Milan. Farina has often been compared as a sentimental humorist with Dickens, and his style of writing has given him a special place in modern Italian fiction. His masterpiece is *Il Signor Io* (1880), a delightful portrait of an egoist; *Don Chisciottino, Amore bendato, Capelli biondi, Oro nascosto, Il Tesoro di Donnina, Amore a cent'occhi, Mio figlio, Il numero 13*, are some of his other volumes.

FARINATO, PAOLO (1522–1606), Italian painter and architect, was a native of Verona. He is sometimes named Farinato degli Uberti, as he came from the ancient Florentine stock to which the Ghibelline leader Farinata degli Uberti, celebrated in Dante's *Commedia*, belonged. He flourished at the same time that the art of Verona obtained its greatest lustre in the works of Paolo Cagliari (Paul Veronese), succeeded by other members of the Cagliari family, of whom most or all were outlived by Farinato. He was instructed by Niccolò Giolfinio, and probably by Antonio Badile and Domenico del Riccio (Brusatorci). Proceeding to Venice, he formed his style partly on Titian and Giorgione, though he was never conspicuous as a colourist, and in form he learned more from the works of Giulio Romano. His nude figures show knowledge of the antique; he affected a bronzed tone in the complexions, harmonizing with the general gravity of his colour, which is more laudable in fresco than in oil-painting. Vasari praised his thronged compositions and merit of draughtsmanship. His works are to be found not only in Venice and principally in Verona, but also in Mantua, Padua and other towns belonging or adjacent to the Venetian territory. He was a prosperous and light-hearted man, and continually progressed in his art, passing from a comparatively dry manner into a larger and bolder one, with much attraction of drapery and of landscape. The "Miracle of the Loaves and Fishes," painted in the church of S. Giorgio in Verona, is accounted his masterpiece; it was executed at the advanced age of seventy-nine, and is of course replete with figures, comprising those of the painter's own family. A saloon was painted by him in S. Maria in Organo, in the same city, with the subjects of "Michael expelling Lucifer" and the "Massacre of the Innocents"; in Piacenza is a "St Sixtus"; in Berlin a "Presentation in the Temple"; and in the communal gallery of Verona one of his prime works, the "Marriage of St Catherine." Farinato executed some sculptures, and various etchings of sacred and mythologic subjects; his works of all kinds were much in request, including the wax models which he wrought as studies for his painted figures. He is said to have died at the same hour as his wife. His son Orazio was also a painter of merit.

FARINELLI (1705–1782), whose real name was CARLO BROSCHI, one of the most extraordinary singers that ever lived, was born on the 24th of January 1705, at Naples. He was the nephew of Cristiano Farinelli, the composer and violinist, whose name he took. Having been prepared for the career of a soprano, he soon acquired, under the instruction of N. A. Porpora, a voice of marvellous beauty, and became famous throughout southern Italy as *il ragazzo* (the boy). In 1722 he made his first appearance at Rome in his master's *Eumene*, creating the greatest enthusiasm by surpassing a popular German trumpet-player, for whom Porpora had written an obligato to one of the boy's songs, in holding and swelling a note of prodigious length, purity and power, and in the variations, roulades and trills which he introduced into the air. In 1724 he appeared at Vienna, and at Venice in the following year, returning to Naples shortly afterwards. He sang at Milan in 1726, and at Bologna in 1727, where he first met and acknowledged himself vanquished by the singer Antonio Bernacchi (b. 1700), to whose instruction he was much indebted. With ever-increasing success and fame Farinelli appeared in nearly all the great cities of Italy; and

returned a third time to Vienna in 1731. He now modified his style, it is said on the advice of Charles VI., from mere *bravura* of the Porpora school to one of pathos and simplicity. He visited London in 1734, arriving in time to lend his powerful support to the faction which in opposition to Handel had set up a rival opera with Porpora as composer and Senesino as principal singer. But not even his aid could make the undertaking successful. His first appearance at the Lincoln's Inn Fields theatre was in *Artaserse*, much of the music of which was by his brother, Riccardo Broschi. His success was instantaneous, and the prince of Wales and the court loaded him with favours and presents. Having spent three years in England, Farinelli set out for Spain, staying a few months on the way in France, where he sang before Louis XV. In Spain, where he had only meant to stay a few months, he ended by passing nearly twenty-five years. His voice, employed by the queen to cure Philip V. of his melancholy madness, acquired for him an influence with that prince which gave him eventually the power, if not the name, of prime minister. This power he was wise and modest enough to use discreetly. For ten years, night after night, he had to sing to the king the same six songs, and never anything else. Under Ferdinand VI. he held a similar position, and was decorated (1750) with the cross of Calatrava. He utilized his ascendancy over this king by persuading him to establish an Italian opera. After the accession of Charles III. Farinelli retired with the fortune he had amassed to Bologna, and spent the remainder of his days there in melancholy splendour, dying on the 15th of July 1782. His voice was of large compass, possessing seven or eight notes more than those of ordinary singers, and was sonorous, equal and clear; he also possessed a great knowledge of music.

FARINGDON, properly GREAT FARINGDON, a market town in the Abingdon parliamentary division of Berkshire, England, 17 m. W.S.W. of Oxford by road. Pop. (1901) 2900. It lies on the slope of a low range of hills which borders the valley of the Thames on the south. It is the terminus of a branch of the Great Western railway from Uffington. The church of All Saints is a large cruciform building with low central tower. Its period is mainly Transitional Norman and Early English, and though considerably altered by restoration it contains some good details, with many monuments and brasses. Faringdon House, close to the church, was built by Henry James Pye (1745–1813), poet laureate from 1790 to 1813, who also caused to be planted the conspicuous group of fir-trees on the hill east of the town called Faringdon Clump, or locally (like other similar groups) the Folly. The trade of Faringdon is agricultural.

FARINI, LUIGI CARLO (1812–1866), Italian statesman and historian, was born at Russi, near Ravenna, on the 22nd of October 1812. After completing a brilliant university course at Bologna, which he interrupted to take part in the revolution of 1831 (see CARBONARI), he practised as a physician at Russi and at Ravenna. He acquired a considerable reputation, but in 1843 his political opinions brought him under the suspicion of the police and caused his expulsion from the papal states. He resided successively in Florence and Paris, and travelled about Europe as private physician to Prince Jerome Bonaparte, but when Pius IX. was elected to the Holy See and began his reign with apparently Liberal and nationalist tendencies, Farini returned to Italy and was appointed secretary-general to G. Recchi, the minister of the interior (March 1848). But he held office for little more than a month, since like all the other Italian Liberals he disapproved of the pope's change of front in refusing to allow his troops to fight against Austria, and resigned with the rest of the ministry on the 20th of April. Pius, wishing to counteract the effect of this policy, sent Farini to Charles Albert, king of Sardinia, to hand over the command of the papal contingent to him. Elected member of parliament for Faenza, he was again appointed secretary to the ministry of the interior in the Mamiani cabinet, and later director-general of the public health department. He resigned office on the proclamation of the republic after the flight of the pope to Gaeta in 1849, resumed it for a while when Pius returned to Rome with the protection

of French arms, but when a reactionary and priestly policy was instituted, he went into exile and took up his residence at Turin. There he became convinced that it was only through the House of Savoy that Italy could be liberated, and he expounded his views in Cavour's paper *Il Risorgimento*, in *La Frusta* and *Il Piemonte*, of which latter he was at one time editor. He also wrote his chief historical work, *Lo Stato Romano dal 1815 al 1850*, in four volumes (Turin, 1850). In 1851 he was appointed minister of public instruction in the D'Azeglio cabinet, an office which he held till May 1852. As a member of the Sardinian parliament and as a journalist Farini was one of the staunchest supporters of Cavour (*q.v.*), and strongly favoured the proposal that Piedmont should participate in the Cimean War, if indeed he was not actually the first to suggest that policy (see G. B. Ercolani's letter in E. Parri's memoir of Farini). In 1856 and 1857 he published two letters to Mr Gladstone on Italian affairs, which created a sensation, while he continued to propagate his views in the Italian press. When on the outbreak of the war of 1859 Francis V., duke of Modena, was expelled and a provisional government set up, Farini was sent as Piedmontese commissioner to that city; but although recalled after the peace of Villafranca he was determined on the annexation of central Italy to Piedmont and remained behind, becoming a Modenese citizen and dictator of the state. He negotiated an alliance with Parma, Romagna and Tuscany, when other provisional governments had been established, and entrusted the task of organizing an army for this central Italian league to General Fanti (*q.v.*). Annexation to Piedmont having been voted by *plébiscite* and the opposition of Napoleon III. having been overcome, Farini returned to Turin, when the king conferred on him the order of the Annunziata and Cavour appointed him minister of the interior (June 1860), and subsequently viceroy of Naples; but he soon resigned on the score of ill-health. Cavour died in 1861, and the following year Farini succeeded Rattazzi as premier, in which office he endeavoured to carry out Cavour's policy. Over-exertion, however, brought on softening of the brain, which compelled him to resign office on the 24th of March 1863, and ultimately resulted in his death on the 1st of August 1866. He was buried at Turin, but in 1878 his remains were removed to his native village of Russi.

His son Domenico Farini had a distinguished political career and was at one time president of the chamber.

BIBLIOGRAPHY.—Several letters from Farini to Mr Gladstone and Lord John Russell were reprinted in a *Mémoire sur les affaires d'Italie* (1859), and a collection of his political correspondence was published under the title of *Lettres sur les affaires d'Italie* (Paris, 1860). His historical work was translated into English in part by Mr Gladstone and in part under his superintendence. See E. Parri, *Luigi Carlo Farini* (Rome, 1878); L. Carpi in *Il Risorgimento Italiano*, vol. iv. (Milan, 1888); and G. Finali's article, "Il 27 Aprile 1859," in the *Nuova Antologia* for the 16th of May 1903. (L. V.*)

FARM, in the most generally used sense, a portion of land leased or held for the purpose of agriculture; hence "farming" is equivalent to the pursuit of agriculture, and "farmer" to an agriculturist. This meaning is comparatively modern. The origin of the word has perhaps been complicated by an Anglo-Saxon *feorm*, meaning provisions or food supply, and more particularly a payment of provisions for the sustenance of the king, the *cyninges feorm*. In Domesday this appears as a food rent: *firma unius noctis or diei*. According to the *New English Dictionary* there is no satisfactory Teutonic origin for the word. It has, however, been sometimes connected with a word which appears in the older forms of some Teutonic languages, meaning "life." The present form "farm" certainly comes, through the French *ferme*, from the medieval Lat. *firma* (*firmus*, fixed), a fixed or certain payment in money or kind. The Anglo-Saxon *feorm* may be not an original Teutonic word but an early adaptation of the Latin. The *feorm*, originally a tax, seems, as the king "booked" his land, to have become a rent (see F. W. Maitland, *Domesday Book and After*, 1897, p. 236 ff., and J. H. Round, *Feudal England*, 1895, p. 109 ff.). The word *firma* is thus used of the composition paid by the sheriff in respect of the dues to be collected from the shire. From the use of the word for the

fixed sum paid as rent for a portion of land leased for cultivation, "farm" was applied to the land itself, whether held on lease or otherwise, and always with the meaning of agricultural land. The aspect of the fixity of the sum paid leads to a secondary meaning, that of a certain sum paid by a taxable person, community, state, &c., in respect of the taxes or dues that will be imposed, or to such a sum paid as a rent by a contractor for the right of collecting such taxes. This method of indirect collection of the revenue by contractors instead of directly by the officials of the state is that known as "farming the taxes." The system is best known through the *publicani* of Rome, who formed companies or syndicates to farm not only the indirect taxation of the state, but also other sources of the state revenues, such as mines, fisheries, &c. (see **PUBLICANI**).

In monarchical Europe, which grew out of the ruins of the Roman empire, the revenue was almost universally farmed, but the system was gradually narrowed down until only indirect taxes became the subject of farming. France from the 16th to the 18th centuries is the most interesting modern example. Owing to the hopeless condition of its revenues, the French government was continually in a state of anticipating its resources, and was thus entirely in the hands of financiers. In 1681 the indirect taxes were farmed collectively to a single company of forty capitalists (*ferme générale*), increased to sixty in 1755, and reduced to the original number in 1780. These farmers-general were appointed by the king for six years, and paid an annual fixed sum every year in advance. The taxes which they collected were the customs (*douanes* or *traites*), the *gabelle* or salt tax, local taxes or octrois (*entrées*, &c.), and various smaller taxes. They were under the management of a controller-general, who had a central office in Paris. The office of farmer-general was the object of keen competition, notwithstanding that the successful candidates had to share a considerable part of the profits of the post with ministers, courtiers, favourites, and even the sovereign, in the shape of gifts (*croupes*) and pensions. The rapacity of the farmers-general was proverbial, and the loss to the revenue by the system was great, while very considerable hardships were inflicted on the poorer contributors by the unscrupulous methods of collection practised by the underlings of the farmers. In addition, the unpopular nature of the taxes caused deep discontent, and the detestation in which the farmers-general were held culminated in the execution of thirty-two of them during the French Revolution and the sweeping away of the system.

See also **AGRICULTURE**, **DAIRY** AND **DAIRY-FARMING**, **FRUIT** AND **FLOWER FARMING**, &c.

FARM BUILDINGS. The best laying out of a farm, and the construction of its buildings, are matters which, from the variety of needs and circumstances, involve practical considerations and expert knowledge, too detailed in their nature for more than a brief reference in this work. It may be said generally that the best aspect for farm buildings is S. or S.S.E., and with a view to easy disposal of drainage they should be built on a slight slope. The supply of water, whether it be provided from wells by engine or windmill power, by hydraulic rams or other means, is a prime consideration, and it should if possible be laid on at different suitable points or at any rate the central source of supply should be in the most accessible and convenient place as regards stables and cow-sheds. The buildings should be constructed on or within easy distance of the public road, in order to save the upkeep of private roads, and should be as near as possible to the centre of the farm. On mixed farms of ordinary size (200 to 500 acres) the building may be advantageously planned in one rectangular block, the stock-yards being placed in the centre separated by the cow-sheds, and surrounded by the cart-sheds, stables, stores and barn, cattle-boxes, piggeries and minor buildings. On farms of larger size and on dairy farms special needs must be taken into account, while in all cases the local methods of farming must influence the grouping and arrangement of the steading.

For a more detailed treatment of the subject reference may be made to the following works:—S. Taylor, *Modern Homesteads*:

a *Treatise on the Designing of Farm Buildings* (London, 1905); A. D. Clarke, *Modern Farm Buildings* (London, 1899); P. Roberts, *The Farmstead*, in the "Rural Science Series" (New York, 1900), and articles in the *Standard Cyclopaedia of Agriculture*, vol. 3, and in the *Cyclopaedia of American Agriculture*, vol. 1.

FARMER, RICHARD (1735-1797), Shakespearian commentator, the son of a rich maltster, was born at Leicester on the 28th of August 1735. He was educated at the free grammar school of his native town, and at Emmanuel College, Cambridge. He graduated in 1757 a senior optime; three years later he proceeded M.A. and became classical tutor, and in 1775 master of his college, in succession to William Richardson, the biographer of the English bishops. In the latter year also he was appointed vice-chancellor, and three years afterwards chief librarian of the university. In 1780 he was appointed to a prebendal stall in Lichfield, and two years later to one at Canterbury; but the second office he exchanged in 1788 for that of a canon residentiary of St Paul's. Cambridge, where he usually resided, was indebted to him for improvements in lighting, paving and watching; but perhaps London and the nation have less reason to be grateful for his zealous advocacy of the custom of erecting monuments to departed worthies in St Paul's. In 1765 he issued a prospectus for a history of the town of Leicester; but this work, based on materials collected by Thomas Staveley, he never even began; it was carried out by the learned printer John Nichols. In 1766 he published his famous *Essay on the Learning of Shakespeare*, in which he proved that the poet's acquaintance with ancient and modern Continental literature was exclusively derived from translations, of which he copied even the blunders. "Shakespeare," he said, "wanted not the stilts of language to raise him above all other men." "He came out of nature's hand, like Pallas out of Jove's head, at full growth and mature." "One might," he said—by way of ridiculing the Shakespearian criticism of the day—"with equal wisdom, study the Talmud for an exposition of *Tristram Shandy*." The essay fully justifies the author's description of himself in the preface to the second edition: "I may consider myself as the pioneer of the commentators; I have removed a deal of learned rubbish, and pointed out to them Shakespeare's track in the very pleasant paths of nature." Farmer died at Cambridge on the 8th of September 1797. He was, it appears, twice offered a bishopric by Pitt, but declined the preferment. Farmer was immensely popular in his own college, and loved, it was said, above all other things, old port, old clothes and old books.

FARMERS' MOVEMENT, in American political history, the general name for a movement between 1867 and 1896 remarkable for a radical socio-economic propaganda that came from what was considered the most conservative class of American society. In this movement there were three periods, popularly known as Granger, Alliance and Populist.

The GRANGE, or Order of the Patrons of Husbandry (the latter the official name of the national organization, while the former was the name of local chapters, including a supervisory National Grange at Washington), was a secret order founded in 1867 to advance the social needs and combat the economic backwardness of farm life. It grew remarkably in 1873-1874, and in the latter year attained a membership of perhaps 800,000. In the causes of its growth—much broader than those that issued in the financial crisis of 1873—a high tariff, railway freight-rates and other grievances were mingled with agricultural troubles like the fall of wheat prices and the increase of mortgages. The condition of the farmer seemed desperate. The original objects of the Grange were primarily educational, but these were soon overborne by an anti-middleman, co-operative movement. Grange agents bought everything from farm machinery to women's dresses; hundreds of grain elevators and cotton and tobacco warehouses were bought, and even steamboat lines; mutual insurance companies were formed and joint-stock stores. Nor was co-operation limited to distributive processes; crop-reports were circulated, co-operative dairies multiplied, flour-mills were operated, and patents were purchased, that the Grange might manufacture farm machinery. The outcome in some

states was ruin, and the name Grange became a reproach. Nevertheless these efforts in co-operation were exceedingly important both for the results obtained and for their wider significance. Nor could politics be excluded, though officially tabooed; for economics must be considered by social idealists, and economics everywhere ran into politics. Thus it was with the railway question. Railways had been extended into frontier states; there were heavy crops in sparsely settled regions where freight-rates were high, so that—given the existing distributive system—there were "over production" and waste; there was notorious stock manipulation and discrimination in rates; and the farmers regarded "absentee ownership" of railways by New York capitalists much as absentee ownership of land has been regarded in Ireland. The Grange officially disclaimed enmity to railways; but though the organization did not attack them, the Grangers—through political "farmers' clubs" and the like—did. About 1867 began the efforts to establish regulation of the railways, as common-carriers, by the states. Such laws were known as "Granger laws," and their general principles, soon endorsed (1876) by the Supreme Court of the United States, have become an important chapter in the laws of the land. In a declaration of principles in 1874 Grangers were declared to be "not enemies of railroads," and their cause to stand for "no communism, no agrarianism." To conservatives, however, co-operation seemed communism, and "Grange laws" agrarianism; and thus in 1873-1874 the growth of the movement aroused extraordinary interest and much uneasiness. In 1874 the order was reorganized, membership being limited to persons directly interested in the farmers' cause (there had been a millionaire manufacturers' Grange on Broadway), and after this there were constant quarrels in the order; moreover, in 1875 the National Grange largely lost control of the state Granges, which discredited the organization by their disastrous co-operation ventures. Thus by 1876 it had already ceased to be of national political importance. About 1880 a renaissance began, particularly in the Middle States and New England; this revival was marked by a recurrence to the original social and educational objects. The national Grange and state Granges (in all, or nearly all, of the states) were still active in 1909, especially in the old cultural movement and in such economic movements—notably the improvement of highways—as most directly concern the farmers. The initiative and referendum, and other proposals of reform politics in the direction of a democratic advance, also enter in a measure into their propaganda.

The ALLIANCE carried the movement farther into economics. The "National Farmers' Alliance and Industrial Union," formed in 1889, embraced several originally independent organizations formed from 1873 onwards; it was largely confined to the South and was secret. The "National Farmers' Alliance," formed in 1880, went back similarly to 1877, was much smaller, Northern and non-secret. The "Colored Farmers' National Alliance and Co-operative Union" (formed 1888, merged in the above "Southern" Alliance in 1890) was the second greatest organization. With these three were associated many others, state and national, including an annual, non-partisan, deliberative and advisory Farmers' National Congress. The Alliance movement reached its greatest power about 1890, in which year twelve national farmers' organizations were represented in conventions in St Louis, and the six leading ones alone probably had a membership of 5,000,000.¹

As with the Grange, so in the ends and declarations of the whole later movement, concrete remedial legislation for agricultural or economic ills was mingled with principles of vague radical tendency and with lofty idealism.² Among the principles

¹ Membership usually included males or females above 16 years of age.

² Thus, the "Southern" Alliance in 1890 (the chief platforms were the one at Ocala, Florida, and that of 1889 at St Louis, in conjunction with the Knights of Labor) declared its principles to be: "(1) To labour for the education of the agricultural classes in the science of economical government in a strictly non-partisan way, and to bring about a more perfect union of such classes. (2) To

advocated about 1890, practically all the great organizations demanded the abolition of national banks, the free coinage of silver, a "sufficient" issue of government paper money, tariff revision, and a secret ballot (the last was soon realized); only less commonly demanded were an income tax, taxation of evidence of debt, and government loans on lands. All of these were principles of the two great Alliances (the Northern and the Southern), as were also pure food legislation, abolition of land-holding by aliens, reclamation of unused or unearned land grants (to railways, *e.g.*), and either rigid federal regulation of railways and other means of communication or government ownership thereof. The "Southern" Alliance put in the forefront a "sub-treasury" scheme according to which cheap loans should be made by government from local sub-treasuries on non-perishable farm products (such as grain and cotton) stored in government warehouses; while the "Northern" Alliance demanded restriction of the liquor traffic and (for a short time) woman suffrage. Still other issues were a modification of the patent laws (*e.g.* to prevent the purchase of patents to stifle competition), postal currency exchange, the eight-hour day, inequitable taxation, the single-tax on land, "trusts," educational qualification for suffrage, direct popular election of federal judges, of senators, and of the president, special-interest lobbying, &c.

In 1889-1890 the political (non-partisan) movement developed astonishing strength; it captured the Republican stronghold of Kansas, brought the Democratic Party to vassalage in South Carolina, revolutionized legislatures even in conservative states like Massachusetts, and seemed likely completely to dominate the South and West. All its work in the South was accomplished within the old-party organizations, but in 1890 the demand became strong for an independent third party, for which various consolidations since 1887 had prepared the way, and by 1892 a large part of the strength of the farmers' organizations, with that of various industrial and radical orders, was united in the People's Party (perhaps more generally known as the POPULIST Party), which had its beginnings in Kansas in 1890, and received national organization in 1892. This party emphasized free silver, the income tax, eight-hour day, reclamation of land grants, government ownership of railways, telephones and telegraphs, popular election of federal senators, and the initiative and referendum. In the presidential election of 1892 it cast 1,047,021 votes (in a total of 12,036,089), and elected 22 presidential electors, the first chosen by any third party since 1856. In 1896 the People's Party "fused" with the Democratic Party (*q.v.*) in the presidential campaign, and again in 1900; during this period, indeed, the greatest part of the People's Party was reabsorbed into the two great parties from which its membership had originally been drawn,—in some northern states apparently largely into the Republican ranks, but mainly into the Democratic Party, to which it gave a powerful radical impulse.

The Farmers' movement was much misunderstood, abused and ridiculed. It accomplished a vast amount of good. The movement—and especially the Grange, for on most important points the later movements only followed where it had led—contributed the initial impulse and prepared the way for the establishment of travelling and local rural libraries, reading courses, lyceums, farmers' institutes (a steadily increasing influence) and rural free mail delivery (inaugurated experimentally in 1896 and adopted as part of the permanent postal system of the country in 1902); for agricultural exhibits and an improved agricultural press; for encouragement to and increased profit from the work of agricultural colleges, the establishment (1885) and great services of the United States Department of Agri-

demand equal rights to all, and special privileges to none. (3) To endorse the motto: 'In things essential, unity; in all things, charity.' (4) To develop a better state, mentally, morally, socially and financially. . . . (6) To suppress personal, local, sectional and national prejudices." For the Southern farmer a chief concrete evil was the pre-crop mortgages by which cotton farmers remained in debt to country merchants; in the North the farmer attacked a wide range of "capitalistic" legislation that hurt him, he believed, for the benefit of other classes—notably legislation sought by railways.

culture,—in short, for an extraordinary lessening of rural isolation and betterment of the farmers' opportunities; for the irrigation of the semi-arid West, adopted as a national policy in 1902, the pure-food laws of 1906, the interstate-commerce law of 1887, the railway-rate laws of 1903 and 1906, even the great Bureau of Commerce-and-Labor law of 1903, and the Anti-trust laws of 1903 and later. The Alliance and Populist movements were bottomed on the idea of "ethical gains through legislation." In its local manifestations the whole movement was often marked by eccentric ideas, narrow prejudices and weaknesses in economic reasoning. It is not to be forgotten that owing to the movement of the frontier the United States has always been "at once a developed country and a primitive one. The same political questions have been put to a society advanced in some regions and undeveloped in others. . . . On specific political questions each economic area has reflected its peculiar interests" (Prof. F. J. Turner). That this idea must not, however, be over-emphasized, is admirably enforced by observing the great mass of farmer radicalism that has, since about 1896, become an accepted Democratic and Republican principle over the whole country. The Farmers' movement was the beginning of widespread, effective protest against "the menace of privilege" in the United States.

American periodicals, especially in 1890-1892, are particularly informing on the growth of the movement; see F. M. Drew in *Political Science Quarterly* (1891), vi. p. 282; C. W. Pierson in *Popular Science Monthly* (1888), xxxii. pp. 199, 368; C. S. Walker and F. J. Foster in *Annals of American Academy* (1894), iv. p. 790; Senator W. A. Peffer in *Cosmopolitan* (1890), x. p. 694; and on agricultural discontent, *Political Science Quarterly*, iv. (1889), p. 433, by W. F. Mappin; v. (1890), p. 65, by J. P. Dunn; xi. (1896), pp. 433, 601, xii. (1897), p. 93, and xiv. (1899), p. 444, by C. F. Emerick; Prof. E. W. Bemis in *Journal of Political Economy* (1893), i. p. 193; A. H. Peters in *Quarterly Journal of Economics* (1890), iv. p. 18; C. W. Davis in *Forum* (1890), ix. pp. 231, 291, 348.

FARNABY (or FARNABIE), **THOMAS** (c. 1575-1647), English grammarian, was the son of a London carpenter; his grandfather, it is said, had been mayor of Truro, his great-grandfather an Italian musician. Between 1590 and 1595 he appears successively as a student of Merton College, Oxford, a pupil in a Jesuit college in Spain, and a follower of Drake and Hawkins. After some military service in the Low Countries "he made shift," says Wood, "to be set on shore in the western part of England; where, after some wandering to and fro under the name of Tho. Bainrafe, the anagram of his surname, he settled at Martock, in Somersetshire, and taught the grammar school there for some time with success. After he had gotten some feathers at Martock, he took his flight to London," and opened a school in Goldsmiths' Rents, Cripplegate. From this school, which had as many as 300 pupils, there issued, says Wood, "more churchmen and statesmen than from any school taught by one man in England." In the course of his London career "he was made master of arts of Cambridge, and soon after incorporated at Oxon." Such was his success that he was enabled to buy an estate at Otford near Sevenoaks, Kent, to which he retired from London in 1636, still, however, carrying on his profession of schoolmaster. In course of time he added to his Otford estate and bought another near Horsham in Sussex. In politics he was a royalist; and, suspected of participation in the rising near Tunbridge, 1643, he was imprisoned in Ely House, Holborn. He died at Sevenoaks on the 12th of June 1647.

The details of his life were derived by Anthony à Wood from Francis, Farnaby's son by a second marriage (see Wood's *Athenae Oxonienses*, ed. Bliss, iii. 213). His works chiefly consisted of annotated editions of Latin authors—Juvenal, Persius, Seneca, Martial, Lucan, Virgil, Ovid and Terence, which enjoyed extraordinary popularity. His *Systema grammaticum* was published in London in 1641. On the 6th of April 1632, Farnaby was presented with a royal patent granting him, for the space of twenty-one years, the sole right of printing and publishing certain of his works.

FARNBOROUGH, **THOMAS ERSKINE MAY**, **BARON** (1815-1886), English Constitutional historian, was born in London on the 8th of February 1815 and educated at Bedford grammar school. In 1831 he was nominated by Manners Sutton, speaker of the House of Commons, to the post of assistant librarian, so that his long connexion with parliament began in his youth.

He studied for the bar, and was called at the Middle Temple in 1838. In 1844 he published the first edition of his *Treatise on the Law, Privilege, Proceedings and Usage of Parliament*. This work, which has passed through many editions, is not only an invaluable mine of information for the historical student, but it is known as the text-book of the law by which parliament governs its proceedings. In 1846 Erskine May was appointed examiner of petitions for private bills, and the following year taxing-master of the House of Commons. He published his *Remarks to Facilitate Public Business in Parliament* in 1849; a work *On the Consolidation of Election Laws* in 1850; and his *Rules, Orders and Forms of the House of Commons* was printed by command of the House in 1854. In 1856 he was appointed clerk assistant at the table of the House of Commons. He received the companionship of the Bath in 1860 for his parliamentary services, and became a knight commander in 1866. His important work, *The Constitutional History of England since the Accession of George III.* (1760-1860), was published in 1861-1863, and it received frequent additions in subsequent editions. In 1871 Sir Erskine May was appointed clerk of the House of Commons. His *Democracy in Europe: a History* appeared in 1877, but it failed to take the same rank in critical esteem as his *Constitutional History*. He retired from the post of clerk to the House of Commons in April 1886, having for fifteen years discharged the onerous duties of the office with as much knowledge and energy as unflinching tact and courtesy. Shortly after his retirement from office he was raised to the peerage under the title of Baron Farnborough of Farnborough, in the county of Southampton, but he only survived to enjoy the dignity for a few days. He died in London on the 17th of May 1886, and as he left no issue the title became extinct.

FARNBOROUGH, an urban district in the Basingstoke parliamentary division of Hampshire, England, 33 m. S.W. by W. from London, on the London & South Western and the South Eastern & Chatham railways. Pop. (1901) 11,500 (including 5070 military). The church of St Peter ranges from Early English to Perpendicular in style. St Michael's Catholic memorial church, erected in 1887 by the ex-empress Eugénie, contains the remains of Napoleon III. and the prince imperial. An adjoining abbey is occupied by Benedictine fathers of the French congregation; the convent is a ladies' boarding-school. Aldershot North Camp is within the parish.

FARNE ISLANDS [also FEARNE, FERN, or THE STAPLES], a group of rocky islands and reefs off the coast of Northumberland, England, included in that county. In 1901 they had only eleven inhabitants. They extend in a line of some 6 m. in a northeasterly direction from the coast, on which the nearest villages are Bamborough and North Sunderland. The Fairway, 1½ m. across, separates the largest island, Farne, or House, from the mainland. Farne is 16 acres in area, and has precipitous cliffs up to 80 ft. in height on the east, but the shore is otherwise low. The other principal islets are Staple, Brownsman, North and South Wamses, Longstone and Big Harcar. On Farne is a small ancient chapel, with a square tower near it built for purposes of defence in the 15th century. The chapel is believed to occupy the site of St Cuthbert's hermitage, whither he retired from the priory on the neighbouring Holy Island or Lindisfarne. He was with difficulty persuaded to leave it on his elevation to the bishopric of Lindisfarne, and returned to it to die (687). Longstone rock, with its lighthouse, is famous as the scene of the bravery of Grace Darling in rescuing some of the survivors of the wreck of the "Forfarshire" (1838). The rocks abound in sea-birds, including eider duck.

FARNESE, the name of one of the most illustrious and powerful Italian families, which besides including eminent prelates, statesmen and warriors among its members, ruled the duchy of Parma for two centuries. The early history of the family is involved in obscurity, but they are first heard of as lords of Farneto or Farnese, a castle near the lake of Bolsena, and they played an important part as consuls and signori of Orvieto. They seem to have always been Guelphs, and in the civil broils of Orvieto they sided with the Monaldeschi faction against

the Ghibelline Filippeschi. One Pietro Farnese commanded the papal armies under Paschal II. (1099-1118); another Pietro led the Florentines to victory against the Pisans in 1363. Ranuccio Farnese served Eugene IV. so well that the pope endowed him with large fiefs, and is reported to have said, "The Church is ours because Farnese has given it back to us."

The family derived further advantages at the time of Pope Alexander VI., who was the lover of the beautiful Giulia Farnese, known as Giulia Bella, and created her brother Alessandro a cardinal (1493). The latter was elected pope as Paul III. in 1534, and it is from that moment that the great importance of the family dates. An unblushing nepotist, he alienated immense fiefs belonging to the Holy See in favour of his natural children. Of these the most famous was Pierluigi Farnese (1503-1547), who served in the papal army in various campaigns, but also took part in the sack of Rome in 1527. On his father's elevation to the papacy he was made captain-general of the Church, and received the duchy of Castro in the Maremma, besides Frascati, Nepi, Montalto and other fiefs. A shameless rake and a man of uncontrollable temper, his massacre of the people of Perugia after a rebellion in 1540 and the unspeakable outrage he committed on the bishop of Fano are typical of his character. In 1545 his father conferred on him the duchy of Parma and Piacenza, which likewise belonged to the Holy See, and his rule proved cruel and tyrannical. He deprived the nobles of their privileges, and forced them to dwell in the towns, but to some extent he improved the conditions of the lower classes. Pierluigi being an uncompromising opponent of the emperor Charles V., Don Ferrante Gonzaga, the imperial governor of Milan, was ever on the watch for a pretext to deprive him of Piacenza, which the emperor greatly coveted. When the duke proceeded to build a castle in that town in order to overawe its inhabitants, the nobles were furiously indignant, and a plot to murder him was organized by the marquis Anguissola and others with the support both of Gonzaga and of Andrea Doria (*q.v.*), Charles's admiral, who wished to be revenged on Pierluigi for the part he had played in the Fiesco conspiracy (see FIESCO). The deed was done while the duke was superintending the building of the above-mentioned citadel, and his corpse was flung into the street (December 10th, 1547). Piacenza was thereupon occupied by the imperialists.

Pierluigi had several children, for all of whom Paul made generous provision. One of them, Alessandro (1520-1589), was created cardinal at the age of fourteen; he was a man of learning and artistic tastes, and lived with great splendour surrounded by scholars and artists, among whom were Annibal Caro, Paolo Giovio, Mons. Della Casa, Bembo, Vasari, &c. It was he who completed the magnificent Farnese palace in Rome. He displayed diplomatic ability on various missions to foreign courts, but failed to get elected to the papacy.

Orazio, Pierluigi's third son, was made duke of Castro when his father became duke of Parma, and married Diane, a natural daughter of Henry II. of France. Ottavio, the second son (1521-1586), married Margaret, the natural daughter of Charles V. and widow of Alessandro de' Medici, at the age of fifteen, she being a year older; at first she disliked her youthful bridegroom, but when he returned wounded from the expedition to Algiers in 1541 her aversion was turned to affection (see MARGARET OF AUSTRIA). Ottavio had been made lord of Camerino in 1540, but he gave up that fief when his father became duke of Parma. When, on the murder of the latter in 1547, Piacenza was occupied by the imperialists, Paul determined to make an effort to regain the city; he set aside Ottavio's claims to the succession of Parma, where he appointed a papal legate, giving him back Camerino in exchange, and then claimed Piacenza of the emperor, not for the Farnesi, but for the Church. But Ottavio would not be put off; he attempted to seize Parma by force, and having failed, entered into negotiations with Gonzaga. This unnatural rebellion on the part of one grandson, combined with the fact that it was supported by the other grandson, Cardinal Alessandro, hastened the pope's death, which occurred on the 10th of November 1549. During the interregnum that followed Ottavio

again tried to induce the governor of Parma to give up the city to him, but met with no better success; however, on the election of Giovan Maria Ciochi (Julius III.) the duchy was conferred on him (1551). This did not end his quarrel with the emperor, for Gonzaga refused to give up Piacenza and even threatened to occupy Parma, so that Ottavio was driven into the arms of France. Julius, who was anxious to be on good terms with Charles on account of the council of Trent which was then sitting, ordered Farnese to hand Parma over to the papal authorities once more, and on his refusal hurled censures and admonitions at his head, and deprived him of his Roman fiefs, while Charles did the same with regard to those in Lombardy. A French army came to protect Parma, war broke out, and Gonzaga at once laid siege to the city. But the duke came to an arrangement with his father-in-law, by which he regained Piacenza and his other fiefs. The rest of his life was spent quietly at home, where the moderation and wisdom of his rule won for him the affection of his people. At his death in 1586 he was succeeded by his son Alessandro Farnese (1545-1592), the famous general of Philip II. of Spain, who spent the whole of his reign in the Flemish wars.

The first years of the reign of his son and successor Ranuccio I. (1569-1622), who had shown much spirit in a controversy with Pope Sixtus V., were uneventful, but in 1611 a conspiracy was formed against him by a group of discontented nobles supported by the dukes of Modena and Mantua. The plot was discovered and the conspirators were barbarously punished, many being tortured and put to death, and their estates confiscated. Ranuccio was a reserved and gloomy bigot; he instituted savage persecutions against supposed witches and heretics, and lived in perpetual terror of plots. His eldest son Alessandro being deaf and dumb, the succession devolved on his second son Odoardo (1612-1646), who fought on the French side in the war against Spain. His failure to pay the interest of the money borrowed in Rome, and the desire of Urban VIII. to obtain Castro for his relatives the Barberini (*q.v.*), resulted in a war between that pope and Odoardo. His son and successor Ranuccio II. (1630-1694) also had a war with the Holy See about Castro, which was eventually razed to the ground. His son Francesco Maria (1678-1727) suffered from the wars between Spain and Austria, the latter's troops devastating his territory; but although this obliged him to levy some burdensome taxes, he was a good ruler and practised economy in his administration. Having no children, the succession devolved at his death on his brother Antonio (1679-1731), who was also childless. The powers had agreed that at the death of the latter the duchy should pass to Don Carlos of Bourbon, son of King Philip V. of Spain by Elisabetta Farnese (1692-1766), granddaughter of Ranuccio II. Antonio died in 1731, and with him the line of Farnese came to an end.

The Palazzo Farnese in Rome, one of the finest specimens of Roman Renaissance architecture, was begun under Paul III., while he was cardinal, by Antonio da San Gallo, and completed by his nephew Cardinal Alessandro under the direction of Michelangelo (1526). It was inherited by Don Carlos, afterwards king of Naples and Spain, and most of the pictures were removed to Naples. It now contains the French embassy to the Italian court, as well as the French school of Rome.

BIBLIOGRAPHY.—F. Odorici gives a detailed history of the family in P. Litta's *Famiglie celebri italiane*, vol. x. (Milan, 1868), to which an elaborate bibliography is appended, including manuscript sources; a more recent bibliography is S. Lottici and G. Sitti, *Bibliografia generale per la storia parmense* (Parma, 1904); much information will be found in A. von Reumont's *Geschichte der Stadt Rom*, vol. iii. (Berlin, 1868), and in F. Gregorovius's *Geschichte der Stadt Rom* (Stuttgart, 1872). (L. V. *)

FARNESE, ALEXANDER (1545-1592), duke of Parma, general, statesman and diplomatist, governor-general of the Netherlands under Philip II. of Spain, was born at Rome on the 27th of August 1545, and died at the abbey of St Waast, near Arras, on the 3rd of December 1592. He was the son of Ottavio Farnese, duke of Parma, and Margaret of Austria, natural daughter of Charles V. He accompanied his mother to Brussels when she was appointed governor of the Netherlands, and in

1565 his marriage with the princess Maria of Portugal was celebrated in Brussels with great splendour. Alexander Farnese had been brought up in Spain with his cousin, the ill-fated Don Carlos, and his uncle Don John of Austria, both of whom were about the same age as himself, and after his marriage he took up his residence at once at the court of Madrid. He fought with much personal distinction under the command of Don John in 1571 at the battle of Lepanto. It was seven years, however, before he had again an opportunity for the display of his great military talents. In the meantime the provinces of the Netherlands had revolted against the arbitrary and oppressive Spanish rule, and Don John of Austria, who had been sent as governor-general to restore order, had found himself helpless in face of the superior talent and personal influence of the prince of Orange, who had succeeded in uniting all the provinces in common resistance to the civil and religious tyranny of Philip. In the autumn of 1577 Farnese was sent to join Don John at the head of reinforcements, and it was mainly his prompt decision at a critical moment that won the battle of Gemblours (1578). Shortly afterwards Don John, whose health had broken down through disappointment and ill-health, died, and Farnese was appointed to take his place.

It is scarcely possible to exaggerate the difficulties with which he found himself confronted, but he proved himself more than equal to the task. In military ability the prince of Parma was inferior to none of his contemporaries, as a skilful diplomatist he was the match even of his great antagonist William the Silent, and, like most of the leading statesmen of his day, was unscrupulous as to the means he employed so long as he achieved his ends. Perceiving that there were divisions and jealousies in the ranks of his opponents between Catholic and Protestant, Fleming and Walloon, he set to work by persuasion, address and bribery, to foment the growing discord, and bring back the Walloon provinces to the allegiance of the king. He was successful, and by the treaty of Arras, January 1579, he was able to secure the support of the "Malcontents," as the Catholic nobles of the south were styled, to the royal cause. The reply to the treaty of Arras was the Union of Utrecht, concluded a few weeks later between the seven northern provinces, who abjured the sovereignty of King Philip and bound themselves to use all their resources to maintain their independence of Spanish rule.

Farnese, as soon as he had obtained a secure basis of operations in Hainaut and Artois, set himself in earnest to the task of reconquering Brabant and Flanders by force of arms. Town after town fell into his power. Tournai, Maastricht, Breda, Bruges and Ghent opened their gates, and finally he laid siege to the great seaport of Antwerp. The town was open to the sea, was strongly fortified, and was defended with resolute determination and courage by the citizens. They were led by the famous Philip de Marnix, lord of St Aldegonde, and had the assistance of an ingenious Italian engineer, by name Gianibelli. The siege began in 1584 and called forth all the resources of Farnese's military genius. He cut off all access to Antwerp from the sea by constructing a bridge of boats across the Scheldt from Calloo to Oordam, in spite of the desperate efforts of the besieged to prevent its completion. At last, on the 15th of August 1585, Antwerp was compelled by famine to capitulate. Favourable conditions were granted, but all Protestants were required to leave the town within two years. With the fall of Antwerp, for Malines and Brussels were already in the hands of Farnese, the whole of the southern Netherlands was brought once more to recognize the authority of Philip. But Holland and Zeeland, whose geographical position made them unassailable except by water, were by the courage and skill of their hardy seafaring population, with the help of English auxiliaries sent by Queen Elizabeth, able to defy his further advance.

In 1586 Alexander Farnese became duke of Parma by the death of his father. He applied for leave to visit his paternal territory, but Philip would not permit him. He could not replace him in the Netherlands; but while retaining him in his command at the head of a formidable army, the king would not give his sanction to his great general's desire to use it for the reconquest

of the Northern Provinces. Never was there a better opportunity than the end of 1586 for an invading army to march through the country almost without opposition. The misgovernment and lack of high statesmanship of the earl of Leicester had caused faction to be rampant in the United Provinces; and on his return to England he left the country without organized forces or experienced generals to oppose an advance of a veteran army under the greatest commander of his time. But Philip's whole thoughts and energies were already directed to the preparation of an Invincible Armada for the conquest of England, and Parma was ordered to collect an enormous flotilla of transports and to keep his army concentrated and trained for the projected invasion of the island realm of Queen Elizabeth. Thus the critical period passed by unused, and when the tempests had finally dispersed the defeated remnants of the Great Armada the Dutch had found a general, in the youthful Maurice of Nassau, worthy to be the rival in military genius even of Alexander of Parma. Moreover, the accession to the throne of France of Henry of Navarre had altogether altered the situation of affairs, and relieved the pressure upon the Dutch by creating a diversion, and placing Parma and his army between hostile forces. The ruinous expenditure upon the Great Armada had also depleted the Spanish treasury and Philip found himself virtually bankrupt. In 1590 the condition of the Spanish troops had become intolerable. Farnese could get no regular supplies of money from the king for the payment of the soldiery, and he had to pledge his own jewels to meet the demand. A mutiny broke out, but was suppressed. In the midst of these difficulties Parma received orders to abandon the task on which he had spent himself for so many years, and to raise the siege of Paris, which was blockaded by Henry IV. He left the Netherlands on the 3rd of August 1590 at the head of 15,000 troops. By brilliant generalship he outwitted Henry and succeeded in relieving Paris; but owing to lack of money and supplies he was compelled immediately to retreat to the Netherlands, abandoning on the march many stragglers and wounded, who were killed by the peasantry, and leaving all the positions he had taken to be recaptured by Henry.

Again in 1591, in the very midst of a campaign against Maurice of Nassau, sorely against his will, the duke of Parma was obliged to give up the engrossing struggle and march to relieve Rouen. He was again successful in his object, but was wounded in the arm before Caudebec, and was finally compelled to withdraw his army with considerable losses through the privations the troops had to undergo. He himself was shattered in health by so many years of continuous campaigning and exposure, and by the cares and disappointments which had befallen him. He died at Arras on the 3rd of December 1592, in the forty-seventh year of his age. The feeling that his immense services had not won for him either the gratitude or confidence of his sovereign hastened his end. He was honoured by a splendid funeral at Brussels, but his body was interred at his own capital city of Parma. He left two sons, Ranuce, who succeeded him, and Edward, who was created a cardinal in 1591 by Pope Gregory XIV. His daughter Margaret married Vincent, duke of Mantua.

See L. P. Gachard, *Correspondance d'Alexandre Farnese, Prince de Parme, gouverneur général des Pays-Bas, avec Philippe II, 1578-1579* (Brussels, 1850); Fra Pietro, *Alessandro Farnese, duca di Parma* (Rome, 1836).

FARNESE, ELIZABETH (1692-1766), queen of Spain, born on the 25th of October 1692, was the only daughter of Odoardo II., prince of Parma. Her mother educated her in strict seclusion, but seclusion altogether failed to tame her imperious and ambitious temper. At the age of twenty-one (1714) she was married by proxy at Parma to Philip V. of Spain. The marriage was arranged by Cardinal Alberoni (*q.v.*), with the concurrence of the Princess des Ursins, the *Camerara Mayor*. On arriving at the borders of Spain, Elizabeth was met by the Princess des Ursins, but received her sternly, and, perhaps in accordance with a plan previously concerted with the king, at once ordered her to be removed from her presence and from Spain. Over the

weak king Elizabeth quickly obtained complete influence. This influence was exerted altogether in support of the policy of Alberoni, one chief aim of which was to recover the ancient Italian possessions of Spain, and which actually resulted in the seizure of Sardinia and Sicily. So vigorously did she enter into this policy that, when the French forces advanced to the Pyrenees, she placed herself at the head of one division of the Spanish army. But Elizabeth's ambition was grievously disappointed. The Triple Alliance thwarted her plans, and at length in 1720 the allies made the banishment of Alberoni a condition of peace. Sicily also had to be evacuated. And finally, all her entreaties failed to prevent the abdication of Philip, who in 1724 gave up the throne to his heir, and retired to the palace of La Granja. Seven months later, however, the death of the young king recalled him to the throne. During his later years, when he was nearly imbecile, she directed the whole policy of Spain so as to secure thrones in Italy for her sons. In 1736 she had the satisfaction of seeing her favourite scheme realized in the accession of her son Don Carlos (afterwards Charles III. of Spain) to the throne of the Two Sicilies and his recognition by the powers in the treaty of Vienna. Her second son, Philip, became duke of Parma. Elizabeth survived her husband twenty years, dying in 1766.

See *Mémoires pour servir à l'histoire d'Espagne sous le règne de Philippe V*, by the Marquis de St Philippe, translated by Maudave (Paris, 1756); *Memoirs of Elizabeth Farnese* (London, 1746); and E. Armstrong, *Elizabeth Farnese, the Termagant of Spain* (1892).

FARNHAM, a market town in the Guildford parliamentary division of Surrey, England, 37½ m. S.W. by W. from London by the London & South Western railway. Pop. of urban district (1901) 6124. It lies on the left bank of the river Wey, on the southern slope of a hill rising about 700 ft. above the sea-level. The church of St Andrew is a spacious transitional Norman and Early English building, with later additions, and was formerly a chapel of ease to Waverley Abbey, of which a crypt and fragmentary remains, of Early English date, stand in the park attached to a modern residence of the same name. This was the earliest Cistercian house in England, founded in 1128 by William Gifford, bishop of Winchester. The *Annales Waverlienses*, published by Gale in his *Scriptores* and afterwards in the Record series of *Chronicles*, are believed to have suggested to Sir Walter Scott the name of his first novel. Farnham Castle, on a hill north of the town, the seat of the bishops of Winchester, was first built by Henry de Blois, bishop of Winchester, and brother of King Stephen; but it was razed by Henry III. It was rebuilt and garrisoned for Charles I. by Denham, from whom it was taken in 1642 by Sir W. Waller; and having been dismantled, it was restored by George Morley, bishop of Winchester (1662-1684). Farnham has a town hall and exchange in Italian style (1866), a grammar school of early foundation, and a school of science and art. It was formerly noted for its cloth manufacture. Hops of fine quality are grown in the vicinity. William Cobbett was born in the parish (1766), and is buried in the churchyard of St Andrew's. The neighbouring mansion of Moor Park was the residence of Sir William Temple (d. 1699), and Swift worked here as his secretary. Hester Johnson, Swift's "Stella," was the daughter of Temple's steward, whose cottage still stands. The town has grown in favour as a residential centre from the proximity of Aldershot Camp (3 m. N.E.).

Though there is evidence of an early settlement in the neighbourhood, the town of Farnham (Fernehām) seems to have grown up round the castle of the bishops of Winchester, who possessed the manor at the Domesday Survey. Its position at the junction of the Pilgrim's Way and the road from Southampton to London was important. In 1205 Farnham had bailiffs, and in 1207 it was definitely a mesne borough under the bishops of Winchester. In 1247 the bishop granted the first charter, giving, among other privileges, a fair on All Saints' Day. The burgesses surrendered the proceeds of the borough court and other rights in 1365 in return for respite of the fee farm rent; these were recovered in 1405 and rent again paid. Bishop Waynflote is said to have confirmed the original charter in 1452, and in 1566 Bishop Horne

granted a new charter by which the burgesses elected 2 bailiffs and 12 burgesses annually and did service at their own courts every three weeks, the court leet being held twice a year. In resisting an attack made by the bishop in 1660 on their right of toll, the burgesses could only claim Farnham as a borough by prescription as their charters had been mislaid, but the charters were subsequently found, and after some litigation their rights were established. In the 18th century the corporation, a close body, declined, its duties being performed by the vestry, and in 1789 the one survivor resigned and handed over the town papers to the bishop. Farnham sent representatives to parliament in 1311 and 1460, on both occasions being practically the bishop's pocket borough. In accordance with the grant of 1247 a fair was held on All Saints' day and also on Holy Thursday; the former was afterwards held on All Souls' Day. Farnham was early a market of importance, and in 1216 a royal grant changed the market day from Sunday to Thursday in each week. It was famous in the early 17th century for wheat and oats; hop-growing began in 1597.

FARNWORTH, an urban district in the Radcliffe-cum-Farnworth parliamentary division of Lancashire, England, on the Irwell, 3 m. S.E. of Bolton by the Lancashire & Yorkshire railway. Pop. (1901) 25,925. Cotton mills, iron foundries, brick and tile works, and collieries employ the large industrial population.

FARO, the capital of a district bearing the same name, in southern Portugal; at the terminus of the Lisbon-Faro railway, and on the Atlantic Ocean. Pop. (1900) 11,789. Faro is an episcopal see, with a Renaissance cathedral of great size, an ecclesiastical seminary, and a ruined castle surrounded by Moorish fortifications. Its broad but shallow harbour is protected on the south by the long island of Cães, and a number of sandy islets, which, being constantly enlarged by silt from the small river Feroso, render the entrance of large vessels impossible. Fishing is an important industry, and fish, with wine, fruit, cork, baskets and sumach, are the principal articles of export. Little has been done to develop the mineral resources of the district, which include tin, lead, antimony and auriferous quartz. Faro was taken from the Moors by Alphonso III. of Portugal (1248-1279). It was sacked by the English in 1596, and nearly destroyed by an earthquake in 1755.

The administrative district of Faro coincides with the ancient kingdom and province of Algarve (*q.v.*); pop. (1900) 255,191; area, 1937 sq. m.

FARO (from *Pharaoh*, a picture of the Egyptian king appearing on a card of the old French pack), a game of cards, played with a full pack. Originally the pack was held in the dealer's left hand, but nowadays very elaborate and expensive implements are used. The dealer places the pack, after shuffling and cutting, in a dealing-box face upwards, and the cards are taken from the top of the box in couples through a slit in the side. The exposed card on top is called *soda*, and the last card left in the box is *in hoc*. The implements include counters of various colours and values, a dealing-box, a case or frame manipulated by a "case-keeper," upon which the cards already played are arranged in sight, a shuffling-board, and score-sheets for the players. Upon the table is the "lay-out," a complete suit of spades enamelled on green cloth, upon or near which to place the stakes. The dealer takes two cards from the box, placing the first one near it and the second close beside it. Each deal of two cards is called a *turn*, and there are twenty-five such, *soda* and *hoc* not counting. The players stake upon any card they please, or in such manner as to take in several cards, reducing the amount, but increasing the chances, of winning, as at roulette. The dealer, having waved the hand, after which no more bets may be made, deals the turn, and then proceeds to gather in the stakes won by him, and to pay those he has lost. The chances as between dealer and punters, or players, are equal, except that the banker wins half the money staked on the cards of a turn should they chance to be alike. Faro is played considerably in parts of the United States, whither it is said to have been taken from France, where it had a great vogue during the reign

of Louis XIV. Owing to the dishonest methods of many gambling "clubs" the game is in disrepute.

FARQUHAR, GEORGE (1677-1707), British dramatist, son of William Farquhar, a clergyman, was born in Londonderry, Ireland, in 1677. When he was seventeen he was entered as a sizar at Trinity College, Dublin, under the patronage of Dr Wiseman, bishop of Dromore. He did not long continue his studies, being, according to one account, expelled for a profane joke. Thomas Wilkes, however, states that the abrupt termination of his studies was due to the death of his patron. He became an actor on the Dublin stage, but in a fencing scene in Dryden's *Indian Emperor* he forgot to exchange his sword for a foil, with results which narrowly escaped being fatal to a fellow-actor. After this accident he never appeared on the boards. He had met Robert Wilks, the famous comedian, in Dublin. Though he did not, as generally stated, go to London with Wilks, it was at his suggestion that he wrote his first play, *Love and a Bottle*, which was performed at Drury Lane, perhaps through Wilks's interest, in 1698. He received from the earl of Orrery a lieutenancy in his regiment, then in Ireland, but in two letters of his dated from Holland in 1700 he says nothing of military service. His second comedy, *The Constant Couple: or a Trip to the Jubilee* (1699), ridiculing the preparations for the pilgrimage to Rome in the Jubilee year, met with an enthusiastic reception. Wilks as Sir Harry Wildair contributed substantially to its success. In 1701 Farquhar wrote a sequel, *Sir Harry Wildair*. Leigh Hunt says that Mrs Oldfield, like Wilks, played admirably well in it, but the original Lady Lurewell was Mrs Verbruggen. Mrs Oldfield is said to have been the "Penelope" of Farquhar's letters. In 1702 Farquhar published a slight volume of miscellanies—*Love and Business; in a Collection of Occasional Verse and Epistolary Prose*—containing, among other things, "A Discourse on Comedy in reference to the English Stage," in which he defends the English neglect of the dramatic unities. "The rules of English comedy," he says, "don't lie in the compass of Aristotle or his followers, but in the pit, box and galleries." In 1702 he borrowed from Fletcher's *Wild Goose Chase*, *The Inconstant, or the Way to win Him*, in which he followed his original fairly closely except in the last act. In 1703 he married, in the expectation of a fortune, but found too late that he was deceived. It is said that he never reproached his wife, although the marriage increased his liabilities and the rest of his life was a constant struggle against poverty. His other plays are: *The Stage Coach* (1704), a one-act farce adapted from the French of Jean de la Chapelle in conjunction with Peter Motteux; *The Twin Rivals* (Drury Lane, 1702); *The Recruiting Officer* (Drury Lane, 1706); and *The Beaux' Stratagem* (Haymarket, 1707). *The Recruiting Officer* was suggested to him by a recruiting expedition (1705) in Shropshire, and is dedicated to his "friends round the Wrekin." *The Beaux' Stratagem* is the best of all his plays, and long kept the stage. Genest notes nineteen revivals up to 1828. Two embarrassed gentlemen travel in the country disguised as master and servant in the hope of mending their fortune. The play gives vivid pictures of the Lichfield inn with its rascally landlord, and of the domestic affairs of the Sullens. Archer, the supposed valet, whose adventurous spirit secures full play, was one of Garrick's best parts.

Meanwhile one of his patrons, said to have been the duke of Ormond, had advised Farquhar to sell out of his regiment, and had promised to give him a captaincy in his own. Farquhar sold his commission, but the duke's promise remained unfulfilled. Before he had finished the second act of *The Beaux' Stratagem* he knew that he was stricken with a mortal illness, but it was necessary to persevere and to be "consumedly lively to the end." He had received in advance £30 for the copyright from Lintot the bookseller. The play was staged on the 8th of March, and Farquhar lived to have his third night, and there was an extra benefit on the 29th of April, the day of his death. He left his two children to the care of his friend Wilks. Wilks obtained a benefit at the theatre for the dramatist's widow, but he seems to have done little for the daughters. They were apprenticed to a mantua-maker, and one of them was, as late as 1764, in

receipt of a pension of £20 solicited for her by Edmund Chaloner, a patron of Farquhar. She was then described as a maidservant and possessed of sentiments "fitted to her humble situation."

The plots of Farquhar's comedies are ingenious in conception and skilfully conducted. He has no pretensions to the brilliance of Congreve, but his amusing dialogue arises naturally out of the situation, and its wit is never strained. Sergeant Kite in the *Recruiting Officer*, Scrub, Archer and Boniface in *The Beaux' Stratagem* are distinct, original characters which had a great success on the boards, and the unexpected incidents and adventures in which they are mixed up are represented in an irresistibly comic manner by a man who thoroughly understood the resources of the stage. The spontaneity and verve with which his adventurous heroes are drawn have suggested that in his favourite type he was describing himself. His own disposition seems to have been most lovable, and he was apparently a much gayer person than the reader might be led to suppose from the "Portrait of Himself" quoted by Leigh Hunt. The code of morals followed by these characters is open to criticism, but they are human and genial in their roguery, and compare far from unfavourably with the cynical creations of contemporary drama. The advance which he made on his immediate predecessors in dramatic construction and in general moral tone is more striking when it is remembered that he died before he was thirty.

Farquhar's dramatic works were published in 1728, 1742 and 1772, and by Thomas Wilkes with a biography in 1775. They were included in the *Dramatic Works of Wycherley, Congreve, Vanbrugh and Farquhar* (1849), with biographical and critical notices, by Leigh Hunt. See also *The Dramatic Works of George Farquhar, with Life and Notes*, by A. C. Ewald (2 vols., 1892); *The Best Plays of George Farquhar* (Mermaid series, 1906), with biographical and critical introductions, by William Archer; *The Beaux' Stratagem*, edited (1898) by H. Macaulay Fitzgibbon for "The Temple Dramatists"; and D. Schmid, "George Farquhar, sein Leben und seine Original-dramen" (1904) in *Wiener Beiträge zur engl. Philol.*

FARR, WILLIAM (1807-1883), English statistician, was born at Kenley, in Shropshire, on the 30th of November 1807. When nineteen he became the pupil of a doctor in Shrewsbury, also acting as dresser in the infirmary there. He then went to Paris to study medicine, but after two years returned to London, where, in 1832, he qualified as L.S.A. Next year he began to practise, but without very brilliant results, for five years later he definitely abandoned the exercise of his profession on accepting the post of compiler of abstracts in the registrar-general's office. The commissioners for the 1841 census consulted him on several points, but did not in every case follow his advice. For the next two decennial censuses he acted as assistant-commissioner; for that of 1871 he was a commissioner, and he wrote the greater part of the reports of all. He had an ambition to become registrar-general; and when that post became vacant in 1879, he was so disappointed at the selection of Sir Brydges Henniker instead of himself, that he refused to stay any longer in the registrar's office. He died of paralysis of the brain a year or two later, on the 14th of April 1883. A great part of Farr's literary production is to be found in the papers which, from 1839 to 1880, he wrote for each annual report of the registrar-general on the cause of the year's deaths in England. He was also the author of many papers on general statistics and on life-tables for insurance, some read before the Royal Statistical Society, of which he was president in 1871 and 1872, some contributed to the *Lancet* and other periodicals. A selection from his statistical writings was published in 1885 under the editorship of Mr Noël Humphreys.

FARRAGUT, DAVID GLASGOW (1801-1870), first admiral of the United States navy, was the son of Major George Farragut, a Catalan by descent, a Minorquin by birth, who had emigrated to America in 1776, and, after the peace, had married a lady of Scottish family and settled near Knoxville, in Tennessee; there Farragut was born on the 5th of July 1801. At the early age of nine he entered the navy, under the protection of his name-father, Captain David Porter, with whom he served in the "Essex" during her cruise in the Atlantic in 1812, and afterwards in the Pacific, until her capture by the "Phoebe," in Valparaiso

Bay, on the 28th of March 1814. He afterwards served on board the "Washington" (74) carrying the broad pennant of Commodore Chauncey in the Mediterranean, and pursued his professional and other studies under the instruction of the chaplain, Charles Folsom, with whom he contracted a lifelong friendship. Folsom was appointed from the "Washington" as U.S. consul at Tunis, and obtained leave for his pupil to pay him a lengthened visit, during which he studied not only mathematics, but also French and Italian, and acquired a familiar knowledge of Arabic and Turkish. He is said to have had a great natural aptitude for languages and in after years to have spoken several fluently.

After more than four years in the Mediterranean, Farragut returned to the States in November 1820. He then passed his examination, and in 1822 was appointed for service in what was called the "mosquito" fleet, against the pirates, who then infested the Caribbean Sea. The service was one of great exposure and privation; for two years and a half, Farragut wrote, he never owned a bed, but lay down to rest wherever he found the most comfortable berth. By the end of that time the joint action of the British and American navies had driven the pirates off the sea, and when they took to marauding on shore the Spanish governors did the rest. In 1825 he was promoted to the rank of lieutenant, whilst serving in the navy yard at Norfolk, where, with some breaks in sea-going ships, he continued till 1832; he then served for a commission on the coast of Brazil, and was again appointed to the yard at Norfolk.

It is needless to trace the ordinary routine of his service step by step. The officers of the U.S. navy have one great advantage which British officers are without; when on shore they are not necessarily parted from the service, but are employed in their several ranks in the different dockyards, escaping thus not only the private grievance and pecuniary difficulties of a very narrow half-pay, but also, what from a public point of view is much more important, the loss of professional aptitude, and of that skill which comes from unceasing practice. On the 8th of September 1841 Farragut was promoted to the rank of commander, and on the 14th of September 1855 to that of captain. At this time he was in charge of the navy yard, Mare Island, California, from which post he was recalled in 1858, and appointed to the "Brooklyn" frigate, the command of which he held for the next two years. When the war of secession broke out in 1861, he was "waiting orders" at Norfolk. By birth and marriage he was a Southerner, and the citizens of Norfolk counted on his throwing in his lot with them; but professional pride, and affection for the flag under which he had served for more than fifty years, held him true to his allegiance; he passionately rejected the proposals of his fellow-townsmen, and as it was more than hinted to him that his longer stay in Norfolk might be dangerous, he hastily quitted that place, and offered his services to the government at Washington. These were at once accepted; he was requested to sit on the Naval Retiring Board—a board then specially constituted for clearing the navy of unfit or disloyal officers—and a few months later was appointed to the command of the "Western Gulf Blockading Squadron," with the rank of flag-officer, and ordered to proceed forthwith, in the "Hartford," to the Gulf of Mexico, to collect such vessels as could be spared from the blockade, to proceed up the Mississippi, to reduce the defences which guarded the approaches to New Orleans, and to take and hold the city. All this Farragut executed to the letter, with a skill and caution that won for him the love of his followers, and with a dash and boldness that gained him the admiration of the public and the popular name of "Old Salamander." The passage of the Mississippi was forced on the 24th of April 1862, and New Orleans surrendered on the 26th; this was immediately followed by the operations against Vicksburg, from which, however, Farragut was compelled to withdraw, having learnt the old lesson that against heavy earthworks, crowning hills of sufficient height, a purely naval attack is unavailing; it was not till the following summer, and after a long siege, that Vicksburg surrendered to a land force under General Grant. During this time the service on the Mississippi continued both difficult and irksome; nor until the river was cleared could

Farragut seriously plan operations against Mobile, a port to which the fall of New Orleans had given increased importance. Even then he was long delayed by the want of monitors with which to oppose the ironclad vessels of the enemy. It was the end of July 1864 before he was joined by these monitors; and on the 5th of August, undismayed by the loss of his leading ship, the monitor "Tecumseh," sunk by a torpedo, he forced the passage into the bay, destroyed or captured the enemy's ships, including the ram "Tennessee" bearing Admiral Buchanan's flag, and took possession of the forts. The town was not occupied till the following April, but with the loss of its harbour it ceased to have any political or strategical importance.

With this Farragut's active service came to an end; for though in September 1864 he was offered the command of the force intended for the reduction of Wilmington, the state of his health, after the labours and anxieties of the past three years, in a trying climate, compelled him to decline it and to ask to be recalled. He accordingly returned to New York in December, and was received with the wildest display of popular enthusiasm. It was then that the Government instituted the rank of vice-admiral, previously unknown in the American service. Farragut was promoted to it, and in July 1866 was further promoted to the rank of admiral. In 1867, with his flag flying in the "Franklin," he visited Europe. The appointment was an honourable distinction without political or naval import: the "Franklin" was, to all intents, for the time being, a yacht at Farragut's disposal; and her arrival in the different ports was the signal for international courtesies, entertainments and social gaiety. She returned to America in 1868, and Farragut retired into private life. Two years later, on the 14th of August 1870, he died at Portsmouth, New Hampshire.

Farragut was twice married, and left, by his second wife, a son, Loyall Farragut, who, in 1878, published a *Life* of his father "embodying his Journal and Letters." Another *Life* (1892), by Captain A. T. Mahan, though shorter, has a greater value from the professional point of view, by reason of the critical appreciation of Farragut's services. (J. K. L.)

FARRANT, RICHARD, composer of English church music, flourished during the 16th century. Very little is known about him. Fétils gives 1530 as the date of his birth, but on what authority does not appear. He became a gentleman of the Chapel Royal in the reign of Edward VI., but resigned his post in 1564 on being appointed master of the children of St George's chapel, Windsor. In this capacity he presented a play before the queen at Shrovetide 1568, and again at Christmas of the same year, receiving on each occasion the sum of £6: 13: 4d. In November 1569 he was reinstated as gentleman of the Chapel Royal. It is stated by Hawkins (*History of Music*, vol. iii. 279) that Farrant was also one of the clerks and organists of St George's chapel, Windsor, and that he retained these posts till his death. Many of his compositions are printed in the collections of Barnard and Boyce. Among the most admired of them are a service in G minor, and the anthems "Call to remembrance" and "Hide not thou thy face." It is doubtful whether Farrant is entitled to the credit of the authorship of the beautiful anthem "Lord, for thy tender mercies' sake." No copy of the music under his name appeared in print till 1800, although it had been earlier attributed to him. Some writers have named John Hilton, and others Thomas Tallis, as the composer. From entries in the *Old Check Book of the Chapel Royal* (edited for the Camden Society by Dr Rimbault) it appears that Farrant died, not in 1585, as Hawkins states, but on the 30th of November 1580 or 1581.

FARRAR, FREDERIC WILLIAM (1831-1903), English divine, was born on the 7th of August 1831, in the Fort of Bombay, where his father, afterwards vicar of Sidcup, Kent, was then a missionary. His early education was received in King William's College, Castletown, Isle of Man, a school whose external surroundings are reproduced in his popular schoolboy tale, *Eric; or, Little by Little*. In 1847 he entered King's College, London. Through the influence of F.D. Maurice he was led to the study of Coleridge, whose writings had a profound influence upon his faith and opinions. He proceeded to Trinity College, Cambridge,

in October 1851, and in the following year took the degree of B.A. at the university of London. In 1854 he took his degree as fourth junior optime, and fourth in the first class of the classical tripos. In addition to other college prizes he gained the chancellor's medal for the English prize poem on the search for Sir John Franklin in 1852, the Le Bas prize and the Norrisian prize. He was elected fellow of Trinity College in 1856.

On leaving the university Farrar became an assistant-master under G. E. L. Cotton at Marlborough College. In November 1855 he was appointed an assistant-master at Harrow, where he remained for fifteen years. He was elected a fellow of the Royal Society in 1864, university preacher in 1868, honorary chaplain to the queen in 1869 and Hulsean lecturer in 1870. In 1871 he was appointed headmaster of Marlborough College, and in the following year he became chaplain-in-ordinary to the queen. In 1876 he was appointed canon of Westminster and rector of St Margaret's, Westminster. He took his D.D. degree in 1874, the first under the new regulations at Cambridge. Farrar began his literary labours with the publication of his schoolboy story *Eric* in 1858, succeeded in the following year by *Julian Home* and *Lyrics of Life*, and in 1862 by *St Winifred's; or the World of School*. He had already published a work on *The Origin of Language*, and followed it up by a series of works on grammar and scholastic philology, including *Chapters on Language* (1865); *Greek Grammar Rules* (1865); *Greek Syntax* (1866); and *Families of Speech* (1869). He edited *Essays on a Liberal Education* in 1868; and published *Seekers after God* in the Sunday Library (1869). It was by his theological works, however, that Farrar attained his greatest popularity. His Hulsean lectures were published in 1870 under the title of *The Witness of History to Christ. The Life of Christ*, which was published in 1874, speedily passed through a great number of editions, and is still in much demand. It reveals considerable powers of imagination and eloquence, and was partly inspired by a personal knowledge of the sacred localities depicted. In 1877 appeared *In the Days of My Youth*, sermons preached in the chapel of Marlborough College; and during the same year his volume of sermons on *Eternal Hope*—in which he called in question the dogma of everlasting punishment—caused much controversy in religious circles and did much to mollify the harsh theology of an earlier age. There is little doubt that his boldness and liberality of thought barred his elevation to the episcopate. In 1879 appeared *The Life and Works of St Paul*, and this was succeeded in 1882 by *The Early Days of Christianity*. Then came in order of publication the following works: *Everyday Christian Life; or, Sermons by the Way* (1887); *Lives of the Fathers* (1888); *Sketches of Church History* (1889); *Darkness and Dawn*, a story of the Neronian persecution (1891); *The Voice from Sinai* (1892); *The Life of Christ as Represented in Art* (1894); a work on Daniel (1895); *Gathering Clouds*, a tale of the days of Chrysostom (1896); and *The Bible, its Meaning and Supremacy* (1896). Farrar was a copious contributor of articles to various magazines, encyclopaedias and theological commentaries. In 1883 he was made archdeacon of Westminster and rural dean; in 1885 he was appointed Bampton lecturer at Oxford, and took for his subject "The History of Interpretation." He was appointed dean of Canterbury in 1895. From 1890 to 1895 he was chaplain to the speaker of the House of Commons, and in 1894 he was appointed deputy-clerk of the closet to Queen Victoria. He died at Canterbury on the 22nd of March 1903.

As a theologian Farrar occupied a position midway between the Evangelical party and the Broad Church; while as a somewhat rhetorical preacher and writer he exerted a commanding influence over wide circles of readers. He was an ardent temperance and social reformer, and was one of the founders of the institution known as the Anglican Brotherhood, a religious band with modern aims and objects.

See his *Life*, by his son R. Farrar (1904).

FARREN, ELIZABETH (c. 1759-1829), English actress, was the daughter of George Farren, an actor. Her first London appearance was in 1777 as Miss Hardcastle in *She Stoops to Conquer*. Subsequent successes established her reputation

and she became the natural successor to Mrs Abington when the latter left Drury Lane in 1782. The parts of Hermione, Olivia, Portia and Juliet were in her repertory, but her Lady Betty Modish, Lady Townly, Lady Fanciful, Lady Teazle and similar parts were her favourites. In 1797 she married Edward, 12th earl of Derby (1752-1834).

FARREN, WILLIAM (1786-1861), English actor, was born on the 13th of May 1786, the son of an actor (b. 1725) of the same name, who played leading rôles from 1784 to 1795 at Covent Garden. His first appearance on the stage was at Plymouth at the Theatre Royal, then under the management of his brother, in *Love à la mode*. His first London appearance was in 1818 at Covent Garden as Sir Peter Teazle, a part with which his name is always associated. He played at Covent Garden every winter until 1828, and began in 1824 a series of summer engagements at the Haymarket which also lasted some years. At these two theatres he played an immense variety of comedy characters. From 1828 until 1837 he was at Drury Lane, where he essayed a wider range, including Polonius and Caesar. He was again at Covent Garden for a few years, and next joined Benjamin Webster at the Haymarket, as stage-manager as well as actor. In 1843 at the close of his performance of the title-part in Mark Lemon's *Old Parr*, he was stricken with paralysis on the stage. He was, however, able to reappear the following year, and he remained at the Haymarket ten years more, though his acting never again reached its former level. For a time he managed the Strand, and, 1850-1853, was lessee of the Olympic. During his later years he confined himself to old men parts, in which he was unrivalled. In 1855 he made his final appearance at the Haymarket, as Lord Ogleby in a scene from the *Clandestine Marriage*. He died in London on the 24th of September 1861. In 1825 he had married the actress Mrs Faucit, mother of Miss Helena Saville Faucit (Lady Martin), and he left two sons, Henry (1826-1860) and William (1825-1908), both actors. The former was the father of Ellen [Nellie] Farren (1848-1904), long famous for boy's parts in Gaiety musical burlesques, in the days of Edward Terry and Fred Leslie. As Jack Sheppard, and in similar rôles, she had a unique position at the Gaiety, and was an unrivalled public favourite. From 1892 her health failed, and her retirement, coupled with Fred Leslie's death, brought to an end the type of Gaiety burlesque associated with them.

FARRER, THOMAS HENRY FARRER, 1ST BARON (1819-1890), English civil servant and statistician, was the son of Thomas Farrer, a solicitor in Lincoln's Inn Fields. Born in London on the 24th of June 1819, he was educated at Eton and Balliol College, Oxford, where he graduated in 1840. He was called to the bar at Lincoln's Inn in 1844, but retired from practice in the course of a few years. He entered the public service in 1850 as secretary to the naval (renamed in 1853 the marine) department of the Board of Trade. In 1865 he was promoted to be one of the joint secretaries of the Board of Trade, and in 1867 became permanent secretary. His tenure of this office, which he held for upwards of twenty years, was marked by many reforms and an energetic administration. Not only was he an advanced Liberal in politics, but an uncompromising Free-trader of the strictest school. He was created a baronet for his services at the Board of Trade in 1883, and in 1886 he retired from office. During the same year he published a work entitled *Free Trade versus Fair Trade*, in which he dealt with an economic controversy then greatly agitating the public mind. He had already, in 1883, written a volume on *The State in its Relation to Trade*. In 1889 he was co-opted by the Progressives an alderman of the London County Council, of which he became vice-chairman in 1890. His efficiency and ability in this capacity were warmly recognized; but in the course of time divergencies arose between his personal views and those of many of his colleagues. The tendency towards socialistic legislation which became apparent was quite at variance with his principles of individual enterprise and responsibility. He consequently resigned his position. In 1893 he was raised to the peerage. From this time forward he devoted much of his energy and leisure to advocating his views at the Cobden Club, the Political Economy Club,

on the platform, and in the public press. Especially were his efforts directed against the opinions of the Fair Trade League, and upon this and other controversies on economic questions he wrote able, clear, and uncompromising letters, which left no doubt that he still adhered to the doctrines of free trade as advocated by its earliest exponents. In 1898 he published his *Studies in Currency*. He died at Abinger Hall, Dorking, on the 11th of October 1899. He was succeeded in the title by his eldest son Thomas Cecil (b. 1859).

FARRIER, and FARRIERY (from Lat. *ferrarius*, a blacksmith, *ferrum*, iron). Farrier is the name given generally either to the professional shoer of horses or in a more extended sense to a practitioner of the veterinary art; and farriery is the term for his business. Primarily the art of farriery is identical with that of the blacksmith, in so far as he makes and fixes shoes on horses (see HORSE-SHOES); he is liable in law for negligence, as one who holds himself out as skilled; and he has a lien on the animal for his expenses. William the Conqueror is supposed to have introduced horse-shoeing into England, and the art had an important place through the middle ages, the days of chivalry, and the later developments of equitation. In modern times it has been closely allied with the general progress in veterinary science, and in the knowledge of the anatomy and physiology of the horse's foot and hoof.

See Fisher, *The Farrier* (1893); Lungwitz, *Text-Book of Horse-shoeing* (Eng. trans., 1898).

FARS (the name *Farsistan* is not used), one of the five *mamlikats* (great provinces) of Persia, extending along the northern shore of the Persian Gulf and bounded on the west by Arabistan, on the north by Isfahan and on the east by Kerman. It lies between 49° 30' and 56° 10' E. and 26° 20' and 31° 45' N. and has an area of nearly 60,000 sq. m. Fars is the same word as the Greek *Persis*, and, originally the name of only a part of the Persian empire (Iran), has become the name which Europeans have applied to the whole (see PERSIS). The province is popularly, but not for administrative purposes, divided according to climate into *germsir* and *sardsir*, or the warm and cold regions. The former extends from the sea to the central chain of hills and contains all the lowlands and many mountainous districts, some of the latter rising to an elevation of between 3000 and 4000 ft. and the *sardsir* comprises the remaining and northern districts of the province.

In Arrian's relation of the voyage of Nearchus (*Indica*, 40), these two regions are well described. "The first part of Persis which lies along the Persian Gulf is hot, sandy and barren and only the date palm thrives there. The other part comprehends inner Persis lying northwards; it enjoys a pleasant climate and has fertile and well-watered plains, gardens with trees of all kinds, rich pasturages and forests abounding with game; with the exception of the olive all fruits are produced in profusion, particularly the vine. Horses and other draught animals are reared in the province, and there are several lakes frequented by water-fowl, and streams of clear water flow through it, as for instance the Kyros (Kur) formed by the junction of the Medos and Araxes."

The mountains of Fars may be considered as a continuation of the Zagros and run parallel to the shores of the Persian Gulf. They comprise several ranges which the roads from the sea to the interior have to cross at right angles, thereby rendering communication and transport very difficult. The highest of the mountains of Fars (14,000 ft.) is the Kuh Dinā in the north-western part of the province. Of the rivers of Fars only three important ones flow into the sea: (1) the Mand (Arrian's Sitakos), Karaaghach in its upper course; (2) the Shapur or Khisht river (Granis); (3) the Tah (Oroatis). Some rivers, notably the Kur (Kyros, Araxes) which flows into the Bakhtegan lake east of Shiraz, drain into inland depressions or lakes.

The capital of the province is Shiraz, and the subdivision in districts, the chief places of the districts and their estimated population, and the number of inhabited villages in each as they appear in lists dated 1884 and 1905 are shown on the following page.

	Name of District.	Chief Place or Seat of Government.		Number of inhabited Villages in District.		Name of District.	Chief Place or Seat of Government.		Number of inhabited Villages in District.			
		Name.	Popula-tion.				Name.	Popula-tion.				
1	Abādeh Iklīd	Abādeh	4,000	33	43	Maimand	Maimand	5,000	14			
2	Abādeh-Tashk	Tashk	600	8	44	Maliki	Bander Assalu	1,000	25			
3	Abarj	Dashtek	2,000	6	45	Mamasenni (Shūlistan)						
4	Abbāsi					(1) Bekesh			8			
	(1) Bander Abbāsi ¹ and villages	Bander Abbāsi	10,000	14		(2) Javidi or Jāvi			6			
	(2) Issīn and Taziān	Issīn		6		(3) Dushmanziaris	Kal'ah Safid		16			
	(3) Shamil	Shamil	1,000	18		(4) Rustami			26			
	(4) Moghistan	Ziarat		10		(5) Fahlian			7			
	(5) Mināb	Mināb	4,000	23		(6) Kākān			5			
	(5) Mināb	Nimdeh		12	46	Māyin		Māyin		8		
5	Afzar	Nimdeh		12	47	Mervast and Herāt	Mervast		14			
6	'AleMrūd	Sabzpushan	1,000	16	48	Mervdasht						
7	Arb'ah (the four)					(1) Upper Khafrek	Fathabad	1,250	14			
	(1) Deh Rūd	Deh Ram	1,500	19		(2) Lower Khafrek					16	
	(2) Deh Ram									(3) Mervdasht		
	(3) Hengam							49	Meshhed Mader Sulimān	Murghāb	800	6
	(4) Rudbāl							50	Niriz	Niriz	9,000	24
8	Ardakān	Ardakān	5,000	10	51	Ramjird	Jashian		36			
9	Arsinjan	Arsinjan	5,000	25	52	Rūdan and Ahmedi	Dehbariz		21			
10	Asir	Asir	500	10	53	Sab'ah (the seven)						
11	Baiza	Baiza	2,000	55		(1) Bivunj (Bivanej)	Durz		14			
12	Bīdshahr and Juvīm	Bīdshahr	3,000	23		(2) Hasanabad	Hasanabad		7			
13	Bovanāt	Suriān	500	23		(3) Tarom	Tarun	2,000	15			
14	Darāb	Darāb	5,000	62		(4) Fāraghān	Fāraghān	1,500	13			
15	Dashti					(5) Forg	Forg	3,000	18			
	(1) Bardistan	Bander Dair	1,000	28		(6) Fīn and Guhrah.	Fīn		13			
	(2) Buluk	Bushgān		18		(7) Gīleh Gāh (abandoned)	Ziaret	1,000	11			
	(3) Māndistan	Kāki	1,500	40	54	Sarchahān						
	(4) Tassūj	Tang Bagh	500	11	55	Sarhad Chahār Dungeh						
	(5) Shumbeh	Shumbeh		15		(1) Dasht Ujān	Kūshk Zard					
16	Dashtistān					(2) Dasht Khosro va Shirin				31		
	(1) Angāli	Haftjūsh		10		(3) Dasht Khūngasht						
	(2) Ahrom	Ahrom	1,500	5		(4) Dasht Kūshk Zard						
	(3) Borazjan	Borazjan	4,000	19	56	Sarhad Shesh Nahīyeh						
	(4) Bushire ¹	Bushire	25,000	20		(1) Pādīnā (foot of Mount Dinā).	Khūr Hennā Samīram Felārd Germabad Vank					
	(5) Daliki	Daliki	1,500	7		(2) Hennā				24		
	(6) Gonāvah	Gonāvah	1,000	12		(3) Samīram						
	(7) Hayāt Daūd	Bander Rig	1,000	6		(4) Felārd						
	(8) Khurmuj	Khurmuj	1,000	5		(5) Vardasht						
	(9) Rūd Hillah	Kelat Sukhteh		10		(6) Vank						
	(10) Shaban Kareh	Deh Kohneh		27	57	Sarvistan	Sarvistan	4,500	23			
	(11) Tangistan	Tangistan	1,000	31	58	Shīraz (town) in 1884		53,607 ²				
	(12) Zengeneh	Samal	750	4	59	Siyākh	Darinjān		13			
	(13) Zirāh	Zirāh		6	60	Simkān	Dūzeh		28			
17	Dizkurd	Cherkes	500	6								
18	Famur	Pagah	300	3								
19	Ferrashband	Ferrashband	1,000	14								
20	Fessa	Fessa	5,000	40								
21	Firuzabad	Firuzabad	4,000	20								
22	Gillehdār	Gillehdār	1,000	43								
23	Hūmeh of Shiraz	Zerkān	1,000	89								
24	Istahbanat	Istahbanat	10,000	12								
25	Jahrum	Jahrum	10,000	33								
26	Jireh	Ishfāyikān		23								
27	Kamfiruz	Palangeri		34								
28	Kamin	Kalilek		11								
29	Kazerun	Kazerun	8,000	46								
30	Kavār	Kavār		26								
31	Kir and Karzin	Kir	1,000	23								
32	Khafr	Khafr	1,000	41								
33	Khajeh	Zanjiran	500	15								
34	Khisht	Khisht	2,500	25								
35	Khunj	Khunj	1,500	27								
36	Kongān	Bander Kongān		12								
37	Kuh Gilū and Beh-bahan	Behbahan	10,000	182								
38	Kurbāl	Gavkan	600	67								
39	Kuh i Marreh Shikeft	Shikeft		41								
40	Kunkuri	Kazian		29								
41	Laristan											
	(1) Lar	Lar	8,000	34								
	(2) Bikhah Ihsam	Bairam		11								
	(3) Bikhah Fal	Ishkenān		10								
	(4) Jehāngiriyeh	Bastak	4,000	30								
	(5) Shib Kūh	Bander Chārak		36								
	(6) Fūmistan or Gavbandi	Gāvbandi		13								
	(7) Kauristān	Kauristān		4								
	(8) Lingah ¹	Bander Lingah	10,000	11								
	(9) Mazāyijan	Mazāyijan		6								
42	Mahūr Milāti	Jemalgird		5								

¹ Are forming separate administrative division of "Persian Gulf Ports."

² Persian census in 1884; 25,284 males, 28,323 females.

The above sixty districts are grouped into eighteen sub-provinces under governors appointed by the governor-general of Fars, but the towns of Bushire, Lingah and Bander Abbasi, together with the villages in their immediate neighbourhood, form a separate government known as that of the "Persian Gulf Ports" (Benādir i Khalij i Fars), under a governor appointed from Teheran. The population of the province has been estimated at 750,000 and the yearly revenue it pays to the state amounts to about £150,000. Many districts are fertile, but some, particularly those in the south-eastern part of the province, do not produce sufficient grain for the requirements of the sparse population. In consequence of droughts, ravages of locusts and misgovernment by local governors the province has been much impoverished and hundreds of villages are in ruins and deserted. About a third of the population is composed of turbulent and lawless nomads who, when on the march between their winter and summer camping grounds, frequently render the roads insecure and occasionally plunder whole districts, leaving the inhabitants without means of subsistence.

The province produces much wheat, barley, rice, millet, cotton, but the authorities every now and then prohibiting the export of cereals, the people generally sow just as much as they think will suffice for their own wants. Much tobacco of excellent quality, principally for consumption in Persia, is also grown (especially in Fessa, Darab and Jahrom) and a considerable quantity of opium, much of it for export to China, is produced. Salt, lime and gypsum are abundant. There are also some oil

wells at Daliki, near Bushire, but several attempts to tap the oil have been unsuccessful. There are no valuable oyster-banks in Persian waters, and all the Persian Gulf pearls are obtained from banks on the coast of Arabia and near Bahrein. (A. H.-S.)

FARTHING (A.S. *feórtha*, fourth, +*ing*, diminutive), the smallest English coin, equal to the fourth of a penny. It became a regular part of the coinage from the reign of Edward I., and was, up to the reign of Mary, a silver coin. No farthing was struck in the reign of Elizabeth, but a silver three-farthing piece was issued in that reign, with a profile bust of the queen crowned, with a rose behind her head, and inscribed "E.D.G. Rosa sine spina." The copper farthing was first introduced in the reign of James I., a patent being given to Lord Harington of Exton in 1613 for the issue of copper tokens of this denomination. It was nominally of six grains' weight, but was usually heavier. Properly, however, the copper farthing dates from the reign of Charles II., in whose reign also was issued a tin farthing, with a small copper plug in the centre, and an inscription on the edge, "Nummorum famulus 1684." No farthings were actually issued in the reign of Queen Anne, though a number of patterns were prepared (see NUMISMATICS: *medieval section, England*). In 1860 the copper farthing was superseded by one struck in bronze. In 1842 a proclamation was issued giving currency to half-farthings, and there were several issues, but they were demonetized in 1869. In 1897 the practice was adopted of darkening farthings before issue, to prevent their being mistaken for half-sovereigns.

FARTHINGALE (from the O. Fr. *verdagalle*, or *vertugalle*, a corruption of the Spanish name of the article, *verdago*, from *verdago*, a rod or stick), a case or hoop, originally of bent rods, but afterwards made of whalebone, upon which were hung the voluminous skirts of a woman's dress. The fashion was introduced into England from Spain in the 16th century. In its most exaggerated shape, at the beginning of the 17th century, the top of the farthingale formed a flat circular surface projecting at right angles to the bodice (see COSTUME).

FARUKHABAD, **FARRAKHABAD**, or **FURRUCKABAD**, a city and district of British India in the Agra division of the United Provinces. The city is near the right bank of the Ganges, 87 m. by rail from Cawnpore. It forms a joint municipality with Fatehgarh, the civil headquarters of the district with a military cantonment. Pop. (1901) 67,338. At Fatehgarh is the government gun-carriage factory; and other industries include cotton-printing and the manufacture of gold lace, metal vessels and tents.

The DISTRICT OF FARUKHABAD has an area of 1685 sq. m. It is a flat alluvial plain in the middle Doab. The principal rivers are: the Ganges, which has a course of 87 m. either bordering on or passing through the district, but is not at all times navigable by large boats throughout its entire course; the Kali-nadi (84 m.) and the Isan-nadi (42 m.), both tributaries of the Ganges; and the Arind-nadi, which, after a course of 20 m. in the south of the district, passes into Cawnpore. The principal products are rice, wheat, barley, millets, pulses, cotton, sugar-cane, potatoes, &c. The grain crops, however, are insufficient for local wants, and grain is largely imported from Oudh and Rohilkhand. The district is, therefore, liable to famine, and it was severely visited by this calamity six times during the 19th century—in 1803-1804, 1815-1816, 1825-1826, 1837-1838, 1868-1869 and 1899-1900. Farukhabad is one of the healthiest districts in the Doab, but fevers are prevalent during August and September. The average annual mean temperature is almost 80° F.; the average annual rainfall, 29.4 in.

In the early part of the 18th century, when the Mogul empire was breaking up, Mahommed Khan, a Bangash Afghan from a village near Kaimganj, governor of Allahabad and later of Malwa, established a considerable state of which the present district of Farukhabad was the nucleus, founding the city of Farukhabad in 1714. After his death in 1743, his son and successor Kaim Khan was embroiled by Safdar Jang, the nawab wazir of Oudh, with the Rohillas, in battle with whom he lost his life in 1749. In 1750 his brother, Ahmad Khan, recovered

the Farukhabad territories; but Safdar Jang called in the Mahrattas, and a struggle for the possession of the country began, which ended in 1771, on the death of Ahmad Khan, by its becoming tributary to Oudh. In 1801 the nawab wazir ceded to the British his lands in this district, with the tribute due from the nawab of Farukhabad, who gave up his sovereign rights in 1802. In 1804 the Mahrattas, under Holkar, ravaged this tract, but were utterly routed by Lord Lake at the town of Farukhabad. During the mutiny Farukhabad shared the fate of other districts, and passed entirely out of British hands for a time. The native troops, who had for some time previously evinced a seditious spirit, finally broke into rebellion on the 18th of June 1857, and placed the titular nawab of Farukhabad on the throne. The English military residents took shelter in the fort, which they held until the 4th of July, when, the fort being undermined, they endeavoured to escape by the river. One boat succeeded in reaching Cawnpore, but only to fall into the hands of Nana. Its occupants were made prisoners, and perished in the massacre of the 10th of July. The other boat was stopped on its progress down the river, and all those in it were captured or killed, except four who escaped. The prisoners were conveyed back to Fatehgarh, and murdered there by the nawab on the 19th of July. The rebels were defeated in several engagements, and on the 3rd of January 1858 the English troops recaptured Fatehgarh fort; but it was not till May that order was thoroughly re-established. In 1901 the population was 925,812, showing an increase of 8% in one decade. Part of the district is watered by distributaries of the Ganges canal; it is traversed throughout its length by the Agra-Cawnpore line of the Rajputana railway, and is also served by a branch of the East Indian system. Tobacco, opium, potatoes and fruit, cotton-prints, scent and saltpetre are among the principal exports.

FASCES, in Roman antiquities, bundles of elm or birch rods from which the head of an axe projected, fastened together by a red strap. Nothing is known of their origin, the tradition that represents them as borrowed by one of the kings from Etruria resting on insufficient grounds. As the emblem of official authority, they were carried by the lictors, in the left hand and on the left shoulder, before the higher Roman magistrates; at the funeral of a deceased magistrate they were carried behind the bier. The lictors and the fasces were so inseparably connected that they came to be used as synonymous terms. The fasces originally represented the power over life and limb possessed by the kings, and after the abolition of the monarchy, the consuls, like the kings, were preceded by twelve fasces. Within the precincts of the city the axe was removed, in recognition of the right of appeal (*provocatio*) to the people in a matter of life and death; outside Rome, however, each consul retained the axe, and was preceded by his own lictors, not merely by a single *accensus* (supernumerary), as was originally the case within the city when he was not officiating. Later, the lictors preceded the officiating consul, and walked behind the other. Valerius Publicola, the champion of popular rights, further established the custom that the fasces should be lowered before the people, as the real representatives of sovereignty (Livy ii. 7; Florus i. 9; Plutarch, *Publicola*, 10); lowering the fasces was also the manner in which an inferior saluted a superior magistrate. A dictator, as taking the place of the two consuls, had 24 fasces (including the axe even within the city); most of the other magistrates had fasces varying in number, with the exception of the censors, who, as possessing no executive authority, had none. Fasces were given to the Flamen Dialis and (after 42 B.C.) even to the Vestals. During the times of the republic, a victorious general, who had been saluted by the title of imperator by his soldiers, had his fasces crowned with laurel (Cicero, *Pro Ligario*, 3). Later, under the empire, when the emperor received the title for life on his accession, it became restricted to him, and the laurel was regarded as distinctive of the imperial fasces (see Mommsen, *Römisches Staatsrecht*, i., 1887, p. 373).

FASCIA (Latin for a bandage or fillet), a term used for many objects which resemble a band in shape; thus in anatomy it is applied to the layers of fibrous connective tissue which sheathe

the muscles or cover various parts or organs in the body, and in zoology, and particularly in ornithology, to bands or stripes of colour. In architecture the word is used of the bands into which the architrave of the Ionic and Corinthian orders is subdivided; their origin would seem to have been derived from the superimposing of two or more beams of timber to span the opening between columns and to support a superincumbent weight; the upper beam projected slightly in front of the lower, and similar projections were continued in the stone or marble beam though in one block. In the Roman Corinthian order the fasciae, still projecting one in front of the other, were subdivided by small mouldings sometimes carved. The several bands are known as the first or upper fascia, the second or middle fascia and the third or lower fascia. The term is sometimes applied to flat projecting bands in Renaissance architecture when employed as string courses. It is also used, though more commonly in the form "facia," of the band or plate over a shop-front, on which the name and occupation of the tradesman is written.

FASCINATION (from Lat. *fascinare*, to bewitch, probably connected with the Gr. *βαρκαίνειν*, to speak ill of, to bewitch), the art of enchanting or bewitching, especially through the influence of the "evil eye," and so properly of the exercise of an evil influence over the reason or will. The word is thus used of the supposed paralysing attraction exercised by some reptiles on their victims. It is also applied to a particular hypnotic condition, marked by muscular contraction, but with consciousness and power of remembrance left. In a quite general sense, fascination means the exercise of any charm or strong attraction.

FASCINE (from the Lat. *fascina*, *fascis*, a bundle of sticks), a large faggot of brushwood used in the revetments of earthworks and for other purposes of military engineering. The British service pattern of fascine is 18 ft. long; it is tied as tightly as possible at short intervals, and the usual diameter is 9 in. Similar bundles of wood formed part of the foundations of the early lake-dwellings, and in modern engineering fascines are used in making rough roads over marshy ground and in building river and sea walls and breakwaters.

FASHION (adapted from Fr. *façon*, Lat. *factio*, making, *facere*, to do or make), the action of making, hence the shape or form which anything takes in the process of making. It is thus used in the sense of the pattern, kind, sort, manner or mode in which a thing is done. It is particularly used of the common or customary way in which a thing is done, and so is applied to the manner or custom prevalent at or characteristic of a particular period, especially of the manner of dress, &c., current at a particular period in any rank of society, for which the French term is *modes* (see **COSTUME**).

FASHODA (renamed, 1904, **KODOK**), a post on the west bank of the Upper Nile, Anglo-Egyptian Sudan, in 9° 53' N., 32° 8' E., 459 m. S., by river, of Khartoum. It is the headquarters of the mudiria (province) of the Upper Nile. The station is built on a flat peninsula connected by a narrow strip of land with a ridge which runs parallel with the river. The surrounding country is mostly deep swamp and the station is most unhealthy; mosquitoes are present in millions. The climate is always damp and the temperature rarely below 98° in the shade. The government offices are well-built brick structures. In front of the station is a long low island, and when the Nile is at its lowest this channel becomes dry. Several roads from Kordofan converge on the Nile at this point, and near the station is the residence of the *mek*, or king, of the Shilluk tribe, whose designation of the post was adopted when it was decided to abandon the use of Fashoda. At Lul, 18 m. farther up stream, is an Austrian Roman Catholic mission station.

An Egyptian military post was established at Fashoda in 1865. It was then a trading station of some importance, slaves being the chief commodity dealt in. In 1883-1884 the place fell into the hands of the Mahdists. On the 10th of July 1898 it was occupied by a French force from the Congo under Commandant J. B. Marchand, a circumstance which gave rise to a state of great tension between Great Britain and France. On the 11th of December following the French force withdrew, returning home

via Abyssinia (see **AFRICA**, § 5, and **EGYPT**: *History*, and *Military Operations*).

FAST AND LOOSE, a cheating game played at fairs by sharpers. A strap, usually in the form of a belt, is rolled or doubled up with a loop in the centre, and laid edgewise on a table. The swindler then bets that the loop cannot be caught with a stick or skewer as he unrolls the belt. As this looks to be easy to do the bet is often taken, but the sharper unrolls the belt in such a manner as to make the catching of the loop practically impossible. Centuries ago it was much practised by gipsies, a circumstance alluded to by Shakespeare in *Anthony and Cleopatra* (iv. 12):

"Like a right gipsy, hath, at fast and loose,
Beguiled me to the very heart of loss."

From this game is taken the colloquial expression "to play fast and loose." At the present day it is called "prick the garter" or "prick the loop."

FASTI, in Roman antiquities, plural of the Latin adjective *fastus*, but more commonly used as a substantive, derived from *fas*, meaning what is binding, or allowable, by divine law, as opposed to *jus*, or human law. *Fasti dies* thus came to mean the days on which law business might be transacted without impiety, corresponding to our own "lawful days"; the opposite of the *dies fasti* were the *dies nefasti*, on which, on various religious grounds, the courts could not sit. The word *fasti* itself then came to be used to denote lists or registers of various kinds, which may be divided into two great classes.

1. *Fasti Diurni*, divided into *urbani* and *rustici*, a kind of official year-book, with dates and directions for religious ceremonies, court-days, market-days, divisions of the month, and the like. Until 304 B.C. the lore of the *calendaria* remained the exclusive and lucrative monopoly of the priesthood; but in that year Gnaeus Flavius, a pontifical secretary, introduced the custom of publishing in the forum tables containing the requisite information, besides brief references to victories, triumphs, prodigies, &c. This list was the origin of the public Roman calendar, in which the days were divided into weeks of eight days each, and indicated by the letters A-H. Each day was marked by a certain letter to show its nature; thus the letters F., N., N.P., F.P., Q. Rex C.F., C., EN., stood for *fastus*, *nefastus*, *nefastus* in some unexplained sense, *fastus priore*, *quando rex (sacrorum) comitiavit fastus*, *comitialis* and *intercisus*. The *dies intercisus* were partly *fasti* and partly *nefasti*. Ovid's *Fasti* is a poetical description of the Roman festivals of the first six months, written to illustrate the *Fasti* published by Julius Caesar after he remodelled the Roman year. Upon the cultivators fewer feasts, sacrifices, ceremonies and holidays were enjoined than on the inhabitants of cities; and the rustic *fasti* contained little more than the ceremonies of the calends, nones and ides, the fairs, signs of zodiac, increase and decrease of the days, the tutelary gods of each month, and certain directions for rustic labours to be performed each month.

2. *Fasti Magistrales*, *Annales* or *Historici*, were concerned with the several feasts, and everything relating to the gods, religion and the magistrates; to the emperors, their birthdays, offices, days consecrated to them, with feasts and ceremonies established in their honour or for their prosperity. They came to be denominated *magni*, by way of distinction from the bare calendar, or *fasti diurni*. Of this class, the *fasti consulares*, for example, were a chronicle or register of time, in which the several years were denoted by the respective consuls, with the principal events which happened during their consulates. The *fasti triumphales* and *sacerdotales* contained a list in chronological order of persons who had obtained a triumph, together with the name of the conquered people, and of the priests. The word *fasti* thus came to be used in the general sense of "annals" or "historical records." A famous specimen of the same class are the *fasti Capitolini*, so called because they were deposited in the Capitol by Alexander Farnese, after their excavation from the Roman forum in 1547. They are chiefly a nominal list of statesmen, victories, triumphs, &c., from the expulsion of the kings to the death of Augustus. A considerable number of *fasti*

of the first class have also been discovered; but none of them appear to be older than the time of Augustus. The Praenestine calendar, discovered in 1770, arranged by the famous grammarian Verrius Flaccus, contains the months of January, March, April and December, and a portion of February. The tablets give an account of festivals, as also of the triumphs of Augustus and Tiberius. There are still two complete calendars in existence, an official list by Furius Dionysius Philocalus (A.D. 354), and a Christian version of the official calendar, made by Polemius Silvius (A.D. 448). But some kinds of fasti included under the second general head were, from the very beginning, written for publication. The *Annales Pontificum*—different from the *calendaria* properly so called—were “annually exhibited in public on a white table, on which the memorable events of the year, with special mention of the prodigies, were set down in the briefest possible manner.” Any one was allowed to copy them. Like the pontifices, the augurs also had their books, *libri augurales*. In fact, all the state offices had their fasti corresponding in character to the consular fasti named above.

For the best text and account of the fragments of the Fasti see *Corpus Inscriptionum Latinarum*, i. (2nd ed.); on the subject generally, Teuffel-Schwabe, *Hist. of Roman Literature*, §§ 74, 75, and article by Bouché-Leclercq in Daremberg and Saglio, *Dictionnaire des antiquités*.

FASTING (from “fast,” derived from old Teutonic *fastējan*; synonyms being the Gr. *νηστεύειν*, late Lat. *jejunare*), an act which is most accurately defined as an abstention from meat, drink and all natural food for a determined period. So it is defined by the Church of England, in the 16th homily, on the authority of the Council of Chalcedon¹ and of the primitive church generally. In a looser sense the word is employed to denote abstinence from certain kinds of food merely; and this meaning, which in ordinary usage is probably the more prevalent, seems also to be at least tolerated by the Church of England when it speaks of “fast or abstinence days,” as if fasting and abstinence were synonymous.² More vaguely still, the word is occasionally used as an equivalent for moral self-restraint generally. This secondary and metaphorical sense (*νηστεύειν κακότητος*) occurs in one of the fragments of Empedocles. For the physiology of fasting, see DIETETICS; NUTRITION; also CORPULENCE.

Starvation itself (see also HUNGER AND THIRST) is of the nature of a disease which may be prevented by diet; nevertheless there are connected with it a few peculiarities of scientific and practical interest. “Inedia,” as it is called in the nomenclature of diseases by the London College of Physicians, is of two kinds, arising from *want of food* and from *want of water*. When entirely deprived of nutriment the human body is ordinarily capable of supporting life under ordinary circumstances for little more than a week. In the spring of 1869 this was tried on the person of a “fasting girl” in South Wales. The parents made a show of their child, decking her out like a bride on a bed, and asserting that she had eaten no food for two years. Some reckless enthusiasts for truth set four trustworthy hospital nurses to watch her; the Celtic obstinacy of the parents was roused, and in defence of their imposture they allowed death to take place in eight days. Their trial and conviction for manslaughter may be found in the daily periodicals of the date; but, strange to say, the experimental physiologists and nurses escaped scot-free. There is no doubt that in this instance the unnatural quietude, the grave-like silence, and the dim religious light in which the victim was kept contributed to defer death.

One thing which remarkably prolongs life is a supply of water.

¹ “The Fathers assembled there . . . decreed in that council that every person, as well in his private as public fast, should continue all the day without meat and drink, till after the evening prayer. And whosoever did eat or drink before the evening prayer was ended should be accounted and reputed not to consider the purity of his fast. This canon teacheth so evidently how fasting was used in the primitive church as by words it cannot be more plainly expressed” (*Of Good Works; and first, of Fasting*).

² As indeed they are, etymologically; but, prior to the Reformation, a conventional distinction between *abstinentia* and *jejunium naturale* had long been recognized. “Exceptio eduliorum quorundam portionale jejunium est” (Tertullian).

Dogs furnished with as much as they wished to drink were found by M. Chossat (*Sur l'inanition*, Paris, 1843) to live three times as long as those who were deprived of solids and liquids at the same time. Even wetting the skin with sea-water has been found useful by shipwrecked sailors. Four men and a boy of fourteen who got shut in the Tynewydd mine near Porth, in South Wales, in the winter of 1876–1877 for ten days without food, were not only alive when released, but several of them were able to walk, and all subsequently recovered. The thorough saturation of the narrow space with aqueous vapour, and the presence of drain water in the cutting, were probably their chief preservatives—assisted by the high even temperature always found in the deeper headings of coal mines, and by the enormous compression of the confined air. This doubtless prevented evaporation, and retarded vital processes dependent upon oxidation. The accumulation of carbonic acid in the breathed air would also have a similar arrestive power over destructive assimilation. These prisoners do not seem to have felt any of the severer pangs of hunger, for they were not tempted to eat their candles. With the instinctive feeling that darkness adds a horror to death, they preferred to use them for light. At the wreck of the “Medusa” frigate in 1876, fifteen people survived on a raft for thirteen days without food.

It is a paradoxical fact, that the supply of the stomach even from the substance of the starving individual's body should tend to prolong life. In April 1874 a case was recorded of exposure in an open boat for 32 days of three men and two boys, with only ten days' provisions, exclusive of old boots and jelly-fish. They had a fight in their delirium, and one was severely wounded. As the blood gushed out he lapped it up; and instead of suffering the fatal weakness which might have been expected from the hæmorrhage, he seems to have done well. Experiments were performed by a French physiologist, M. Anselmier (*Archives gén. de médecine*, 1860, vol. i. p. 169), with the object of trying to preserve the lives of dogs by what he calls “artificial auto-phagy.” He fed them on the blood taken from their own veins daily, depriving them of all other food, and he found that the fatal cooling incident to starvation was thus postponed, and existence prolonged. Life lasted till the emaciation had proceeded to six-tenths of the animal's weight, as in Chossat's experiments, extending to the fourteenth day, instead of ending on the tenth day, as was the case with other dogs which were not bled.

Various people have tried, generally for exhibition purposes, how long they could fast from food with the aid merely of water or some medicinal preparation; but these exhibitions cannot be held to have proved anything of importance. A man named Jacques in this way fasted at Edinburgh for thirty days in 1888, and in London for forty-two days in 1890, and for fifty days in 1891; and an Italian named Succi fasted for forty days in 1890.

Religious Fasts.—Fasting is of special interest when considered as a discipline voluntarily submitted to for moral and religious ends. As such it is very widely diffused. Its modes and motives vary considerably according to climate, race, civilization and other circumstances; but it would be difficult to name any religious system of any description in which it is wholly unrecognized.³ The origin of the practice is very obscure.⁴ In his *Principles of Sociology* Herbert Spencer collected, from the accounts we have of various savage tribes in widely separated

³ Confucianism ought perhaps to be named as one. Zoroastrianism is frequently given as another, but hardly correctly. In the *Liber Sader*, indeed (Porta xxv.), we read, “Cavendum est tibi a jejuniis; nam a mane ad vesperam nihil comedere non est bonum in religione nostra”; but according to the Père de Chinon (Lyons, 1671) the Parsee religion enjoins, upon the priesthood at least, no fewer than five yearly fasts. See Hyde, *Veterum Persarum religio*, pp. 449, 548 (ed. 1700).

⁴ During the middle ages the prevalent notion was that it had its origin in paradise. The germ at least of this idea is to be found in Tertullian, who says: “Acceperat Adam a Deo legem non gustandi de arbore agnitionis boni et mali, moriturus si gustasset; verum et ipse tunc in psychicum reversus . . . facilius ventri quam Deo cessit, pabulo potius quam precepto annuit, salutem gula vendidit, manducavit denique et periit, salvus alioquin si uni arbusculæ jejunare maluisset” (*De jejuniis*, c. 3).

parts of the globe, a considerable body of evidence, from which he suggested that it may have arisen out of the custom of providing refreshments for the dead, either by actually feeding the corpse, or by leaving eatables and drinkables for its use. It is suggested that the fasting which was at first the natural and inevitable result of such sacrifice on behalf of the dead may eventually have come to be regarded as an indispensable concomitant of all sacrifice, and so have survived as a well-established usage long after the original cause had ceased to operate.¹ But this theory is repudiated by the best authorities; indeed its extreme precariousness at once becomes evident when it is remembered that, now at least, it is usual for religious fasts to precede rather than to follow sacrificial and funeral feasts, if observed at all in connexion with these. Spencer himself (p. 284) admits that "probably the practice arises in more ways than one," and proceeds to supplement the theory already given by another—that adopted by E. B. Tylor—to the effect that it originated in the desire of the primitive man to bring on at will certain abnormal nervous conditions favourable to the seeing of those visions and the dreaming of those dreams which are supposed to give the soul direct access to the objective realities of the spiritual world.² Probably, if we leave out of sight the very numerous and obvious cases in which fasting, originally the natural reflex result of grief, fear or other strong emotion, has come to be the usual conventional symbol of these, we shall find that the practice is generally resorted to, either as a means of somehow exalting the higher faculties at the expense of the lower, or as an act of homage to some object of worship. The axiom of the Amazulu, that "the continually stuffed body cannot see secret things," meets even now with pretty general acceptance; and if the notion that it is precisely the food which the worshipper foregoes that makes the deity more vigorous to do battle for his human friend be confined only to a few scattered tribes of savages, the general proposition that "fasting is a work of reverence toward God" may be said to be an article of the Catholic faith.³

Although fasting as a religious rite is to be met with almost everywhere, there are comparatively few religions, and those only of the more developed kind, which appoint definite public fasts, and make them binding at fixed seasons upon all the faithful. Brahmanism, for example, does not appear to enforce any stated fast upon the laity.⁴ Among the ancient Egyptians fasting seems to have been associated with many religious festivals, notably with that of Isis (Herod. ii. 40), but it does not appear that, so far as the common people were concerned, the observance of these festivals (which were purely local) was compulsory. The *moreia* on the third day of the Thesmophoria at Athens was observed only by the women attending the festival (who were permitted to eat cakes made of sesame and honey). It is doubtful whether the fast mentioned by Livy (xxxvi. 37) was intended to be general or sacerdotal merely.

Jewish Fasts.—While remarkable for the cheerful, non-ascetic character of their worship, the Jews were no less distinguished from all the nations of antiquity by their annual solemn fast appointed to be observed on the 10th day of the 7th month (Tisri), the penalty of disobedience being death. The rules, as laid down in Lev. xvi. 29-34, xxiii. 27-32 and Numb. xxix. 7-11, include a special injunction of strict abstinence ("ye shall afflict your souls"⁵) from evening to evening. This fast was intimately associated with the chief feast of the year. Before that feast

¹ *Principles of Sociology*, i. pp. 170, 284, 285. Compare the passage in the appendix from Hanusch, *Slavischer Mythos*, p. 408.

² Spencer, *Prin. of Sociology*, i. 256, &c.; E. B. Tylor, *Primitive Culture*, i. 277, 402; ii. 372, &c.

³ Hooker, *E.P.* v. 72. In the Westminster Assembly's Larger Catechism fasting is mentioned among the duties required by the second commandment.

⁴ The Brahmins themselves on the eleventh day after the full moon and the eleventh day after the new "abstain for sixty hours from every kind of sustenance"; and some have a special fast every Monday in November. See Picart, *The Religion and Manners of the Brahmins*.

⁵ עָפַר is here to be taken as substantially equivalent to "desire," "appetite."

could be entered upon, the sins of the people had to be confessed and (sacramentally) expiated. The fast was a suitable concomitant of that contrition which befitted the occasion. The practice of stated fasting was not in any other case enjoined by the law; and it is generally understood to have been forbidden on Sabbath.⁶ At the same time, private and occasional fasting, being regarded as a natural and legitimate instinct, was regulated rather than repressed. The only other provision about fasting in the Pentateuch is of a regulative nature, Numb. xxx. 14 (13), to the effect that a vow made by a woman "to afflict the soul" may in certain circumstances be cancelled by her husband.

The history of Israel from Moses to Ezra furnishes a large number of instances in which the fasting instinct was obeyed both publicly and privately, locally and nationally, under the influence of sorrow, or fear, or passionate desire. See, for example, Judg. xx. 26; 1 Sam. vii. 6 (where the national fast was conjoined with the ceremony of pouring out water before the Lord); Jer. xxxvi. 6, 9; and 2 Sam. xii. 16.⁷ Sometimes the observance of such fasts extended over a considerable period of time, during which, of course, the stricter *jejunium* was conjoined with *abstinentia* (Dan. x. 2). Sometimes they lasted only for a day. In Jonah iii. 6, 7, we have an illustrative example of the rigour with which a strict fast might be observed; and such passages as Joel ii. and Isa. lviii. 5 enable us to picture with some vividness the outward accompaniments of a Jewish fast day before the exile.

During the exile many occasional fasts were doubtless observed by the scattered communities, in sorrowful commemoration of the various sad events which had issued in the downfall of the kingdom of Judah. Of these, four appear to have passed into general use—the fasts of the 10th, 4th, 5th and 7th months—commemorating the beginning of the siege of Jerusalem, the capture of the city, the destruction of the temple, the assassination of Gedaliah. As time rolled on they became invested with increasing sanctity; and though the prophet Zechariah, when consulted about them at the close of the exile (Zech. viii. 19), had by no means encouraged the observance of them, the rebuilding of the temple does not appear to have been considered an achievement of sufficient importance to warrant their discontinuance. It is worthy of remark that Ezekiel's prophetic legislation contains no reference to any fast day; the book of Esther (ix. 31), on the other hand, records the institution of a new fast on the 13th of the 12th month.

In the post-exile period private fasting was much practised by the pious, and encouraged by the religious sentiment of the time (see Judith viii. 6; Tob. xii. 8, and context; Sirach xxxiv. 26; Luke ii. 37 and xviii. 12). The last reference contains an allusion to the weekly fasts which were observed on the 2nd and 5th days of each week, in commemoration, it was said, of the ascent and descent of Moses at Sinai. The real origin of these fasts and the date of their introduction are alike uncertain; it is manifest, however, that the observance of them was voluntary, and never made a matter of universal obligation. It is probable that the Sadducees, if not also the Essenes, wholly neglected them. The second book (*Seder Moed*) of the Mishna contains two tractates bearing upon the subject of fasting. One (*Yoma*, "the day") deals exclusively with the rites which were to be observed on the great day of expiation or atonement; the other (*Taanith*, "fast") is devoted to the other fasts, and

⁶ See Judith viii. 6. "And yet it may be a question whether they (the Jews) did not always fast upon Sabbath," says Hooker (*E.P.* v. 72, 7), who gives a curious array of evidence pointing in this direction. He even makes use of Neh. viii. 9-12, which might be thought to tell the other way. Justinian's phrase, "Sabbata Judaeorum a Mose in omne aevum jejuniu dicata" (l. xxxvi. c. 2; comp. Suetonius, *Augustus*, 76) may be accounted for by the fact that the day of atonement is called Sabbath Sabbathon ("a perfect Sabbath").

⁷ There is, as Graf (*Gesch. Bücher des A.T.* p. 41) has pointed out, no direct evidence that the fast on the 10th of the 7th month was ever observed before the exile. But the inference which he draws from this silence of the historical books is manifestly a precarious one at best. Block calls Lev. xvi. "ein deutliches Beispiel Mosaischer Abfassung" (*Einleitung*, p. 31, ed. 1878).

deals especially with the manner in which occasional fasting is to be gone about if no rain shall have fallen on or before the 17th day of Marcheshwan. It is enacted that in such a case the rabbis shall begin with a light fast of three days (Monday, Thursday, Monday), *i.e.* a fast during which it is lawful to work, and also to wash and anoint the person. Then, in the event of a continued drought, fasts of increasing intensity are ordered; and as a last resort the ark is to be brought into the street and sprinkled with ashes, the heads of the Nasi and Ab-beth-din being at the same time similarly sprinkled.¹ In no case was any fast to be allowed to interfere with new-moon or other fixed festival. Another institution treated with considerable fulness in the treatise *Taanith* is that of the *צומי שבת* (*virii stationis*), who are represented as having been laymen severally representing the twenty-four classes or families into which the whole commonwealth of the laity was divided. They used to attend the temple in rotation, and be present at the sacrifices; and as this duty fell to each in his turn, the men of the class or family which he represented were expected in their several cities and places of abode to engage themselves in religious exercises, and especially in fasting. The suggestion will readily occur that here may be the origin of the Christian *stationes*. But neither Tertullian nor any other of the fathers seems to have been aware of the existence of any such institution among the Jews; and very probably the story about it may have been a comparatively late invention. It ought to be borne in mind that the Aramaic portion of the *Megillath Taanith* (a document considerably older than the treatises in the Mishna) gives a catalogue only of the days on which fasting was forbidden. The Hebrew part (commented on by Maimonides), in which numerous fasts are recommended, is of considerably later date. See Reland, *Antiq. Hebr.* p. iv. c. 10; Derenbourg, *Hist. de Palestine*, p. 439.

Practice of the Early Christian Church.—Jesus Himself did not inculcate asceticism in His teaching, and the absence of that distinctive element from His practice was sometimes a subject of hostile remark (Matt. xi. 19). We read, indeed, that on one occasion He fasted forty days and forty nights; but the expression, which is an obscure one, possibly means nothing more than that He endured the privations ordinarily involved in a stay in the wilderness. While we have no reason to doubt that He observed the one great national fast prescribed in the written law of Moses, we have express notice that neither He nor His disciples were in the habit of observing the other fasts which custom and tradition had established. See Mark ii. 18, where the correct reading appears to be—"The disciples of John, and the Pharisees, were fasting" (some customary fast). He never formally forbade fasting, but neither did He ever enjoin it. He assumed that, in certain circumstances of sorrow and need, the fasting instinct would sometimes be felt by the community and the individual; what He was chiefly concerned about was to warn His followers against the mistaken aims which His contemporaries were so apt to contemplate in their fasting (Matt. vi. 16-18). In one passage, indeed, He has been understood as practically commanding resort to the practice in certain circumstances. It ought to be noted, however, that Matt. xvii. 21 is probably spurious; and that in Mark ix. 29 the words "and fasting" are omitted by Westcott and Hort as well as by Tischendorf on the evidence of the Cod. Sinaiticus (first hand) and Cod. Vaticanus.² The reference to "the fast" in Acts xxvii. 9 has generally been held to indicate that the apostles continued to observe the yearly Jewish fast. But this inference is by no means a necessary one. According to Acts xiii. 2, 3, xiv. 23, they conjoined fasting with prayer at ordinations, and doubtless also on some other solemn occasions; but at the same time the liberty of the Christian "in respect of an holiday, or of the new moon, or of the Sabbath" was strongly insisted on, by one of them at least, who declared that meat whether taken or abstained from commendeth not to God (Col.

¹ The allusion to the ark warns us to be cautious in assuming the laws of the Mishna to have been ever in force.

² The idea, however, is found in the *Clementine Homilies*, ix. 9. Compare Tertullian *De jejuniis*, c. 8: "Docuit etiam adversus diriora daemonia jejuniis praeliandum."

ii. 16-23; 1 Cor. viii. 8; Rom. xiv. 14-22; 1 Tim. iv. 3-5). The fastings to which the apostle Paul alludes in 2 Cor. vi. 5, xi. 27, were rather of the nature of inevitable hardships cheerfully endured in the discharge of his sacred calling. The words which appear to encourage fasting in 1 Cor. vii. 5 are absent from all the oldest manuscripts and are now omitted by all critics;³ and on the whole the precept and practice of the New Testament, while recognizing the propriety of occasional and extraordinary fasts, seem to be decidedly hostile to the imposition of any of a stated, obligatory and general kind.

The usage of the Christian church during the earlier centuries was in this, as in so many other matters, influenced by traditional Jewish feeling, and by the force of old habit, quite as much as by any direct apostolic authority or supposed divine command. Habitual temperance was of course in all cases regarded as an absolute duty; and "the bridegroom" being absent, the present life was regarded as being in a sense one continual "fast." Fasting in the stricter sense was not unknown; but it is certain that it did not at first occupy nearly so prominent a place in Christian ritual as that to which it afterwards attained. There are early traces of the customary observance of the Wednesday and Friday fasts—the *dies stationum* (Clem. Alex. *Strom.* vii. 877), and also of a "quadragesimal" fast before Easter. But the very passage which proves the early origin of "quadragesima," conclusively shows how uncertain it was in its character, and how unlike the Catholic "Lent." Irenaeus, quoted by Eusebius (v. 24), informs us with reference to the customary yearly celebration of the mystery of the resurrection of our Lord, that disputes prevailed not only with respect to the day, but also with respect to the manner of fasting in connexion with it. "For some think that they ought to fast only one day, some two, some more days; some compute their day as consisting of forty hours night and day; and this diversity existing among those that observe it is not a matter that has just sprung up in our times, but long ago among those before us." It was not pretended that the apostles had legislated on the matter, but the general and natural feeling that the anniversaries of the crucifixion and the resurrection of Christ ought to be celebrated by Christians took expression in a variety of ways according to the differing tastes of individuals. No other stated fasts, besides those already mentioned, can be adduced from the time before Irenaeus; but there was also a tendency—not unnatural in itself, and already sanctioned by Jewish practice—to fast by way of preparation for any season of peculiar privilege. Thus, according to Justin Martyr (*Apol.* ii. 93), catechumens were accustomed to fast before baptism, and the church fasted with them. To the same feeling the quadragesimal fast which (as already stated) preceded the joyful feast of the resurrection, is to be, in part at least, attributed. As early as the time of Tertullian it was also usual for communicants to prepare themselves by fasting for receiving the eucharist. But that Christian fasts had not yet attained to the exaggerated importance which they afterwards assumed is strikingly shown in the well-known *Shepherd of Hermas* (lib. iii. sim. v.), where it is declared that "with merely outward fasting nothing is done for true virtue"; the believer is exhorted chiefly to abstain from evil and seek to cleanse himself from feelings of covetousness, and impurity, and revenge: "on the day that thou fastest content thyself with bread, vegetables and water, and thank God for these. But reckon up on this day what thy meal would otherwise have cost thee, and give the amount that it comes to to some poor widow or orphan, or to the poor." The right of bishops to ordain special fasts, "*ex aliqua sollicitudinis ecclesiasticae causa*" (Tertullian), was also recognized.

Later Practice of the Church.—According to an expression preserved by Eusebius (*H.E.* v. 18), Montanus was the first to give laws (to the church) on fasting. Such language, though rhetorical in form, is substantially correct. The treatise of Tertullian,—*Concerning Fasting: against the Carnal*,—written as

³ On the manuscript evidence the words "I was fasting," in Acts x. 30, must also be regarded as doubtful. They are rejected by Lachmann, Tregelles and Tischendorf.

it was under Montanistic influence, is doubly interesting, first as showing how free the practice of the church down to that time had been, and then as foreshadowing the burdensome legislation which was destined to succeed. In that treatise (c. 15) he approves indeed of the church practice of not fasting on Saturdays and Sundays (as elsewhere, *De corona*, c. 3, he had expressed his concurrence in the other practice of observing the entire period between Easter and Pentecost as a season of joy); but otherwise he evinces great dissatisfaction with the indifference of the church as to the number, duration and severity of her fasts.¹ The church thus came to be more and more involved in discussions as to the number of days to be observed, especially in "Lent," as fast days, as to the hour at which a fast ought to terminate (whether at the 3rd or at the 9th hour), as to the rigour with which each fast ought to be observed (whether by abstinence from flesh merely, *abstinentia*, or by abstinence from lactinia, *xerophagia*, or by literal *jejunium*), and as to the penalties by which the laws of fasting ought to be enforced. Almost a century, however, elapsed between the composition of the treatise of Tertullian (*cir.* 212) and the first recorded instances of ecclesiastical legislation on the subject. These, while far from indicating that the church had attained unanimity on the points at issue, show progress in the direction of the later practice of catholicism. About the year 306 the synod of Illiberis in its 26th canon decided in favour of the observance of the Saturday fast.² The council of Ancyra in 314, on the other hand, found it necessary to legislate in a somewhat different direction,—by its 14th canon enjoining its priests and clerks at least to taste meat at the love feasts.³ The synod of Laodicea framed several rules with regard to the observance of "Lent," such as that "during Lent the bread shall not be offered except on Saturday and Sunday" (can. 49), that "the fast shall not be relaxed on the Thursday of the last week of Lent, thus dishonouring the whole season; but the fast shall be kept throughout the whole period" (can. 50), that "during the fast no feasts of the martyrs shall be celebrated" (can. 51), and that "no wedding or birthday feasts shall be celebrated during Lent" (can. 52). The synod of Hippo (393 A.D.) enacted that the sacrament of the altar should always be taken fasting, except on the Thursday before Easter. Protests in favour of freedom were occasionally raised, not always in a very wise manner, or on very wise grounds, by various individuals such as Eustathius of Sebaste (c. 350), Aerius of Pontus (c. 375), and Jovinian, a Roman monk (c. 388). Of the Eustathians, for example (whose connexion with Eustathius can hardly be doubted), the complaint was made that "they fast on Sundays, but eat on the fast-days of the church." They were condemned by the synod of Gangra in Paphlagonia in the following canons:—Can. 19, "If any one fast on Sunday, let him be anathema."⁴ Can. 20, "If any one do not keep the fasts universally commanded and observed by the whole church, let him be anathema." Jovinian was very moderate. He "did not allow himself to be hurried on by an inconsiderate zeal to condemn fasting, the life of celibacy, monachism, considered purely in themselves. . . . He merely sought to show that men were

wrong in recommending so highly and indiscriminately the life of celibacy and fasting, though he was ready to admit that both under certain circumstances might be good and useful" (Neander). He was nevertheless condemned (390) both by Pope Siricius at a synod in Rome, and by Ambrose at another in Milan. The views of Aerius, according to the representations of his bitter opponent Epiphanius (*Haer.* 75, "Adv. Aerium"), seem on this head at least, though unpopular, to have been characterized by great wisdom and sobriety. He did not condemn fasting altogether, but thought that it ought to be resorted to in the spirit of gospel freedom according as each occasion should arise. He found fault with the church for having substituted for Christian liberty a yoke of Jewish bondage.⁵

Towards the beginning of the 5th century we find Socrates (439) enumerating (*H.E.* v. 22) a long catalogue of the different fasting practices of the church. The Romans fasted three weeks continuously before Easter (Saturdays and Sundays excepted). In Illyria, Achaia and Alexandria the quadragesimal fast lasted six weeks. Others (the Constantinopolitans) began their fasts seven weeks before Easter, but fasted only on alternate weeks, five days at a time. Corresponding differences as to the manner of abstinence occurred. Some abstained from all living creatures; others ate fish; others fish and fowl. Some abstained from eggs and fruit; some confined themselves to bread; some would not take even that. Some fasted till three in the afternoon, and then took whatever they pleased. "Other nations," adds the historian, "observe other customs in their fasts, and that for various reasons. And since no one can show any written rule about this, it is plain the apostles left this matter free to every one's liberty and choice, that no one should be compelled to do a good thing out of necessity and fear." When Leo the Great became pope in 440, a period of more rigid uniformity began. The imperial authority of Valentinian helped to bring the whole West at least into submission to the see of Rome; and ecclesiastical enactments had, more than formerly, the support of the civil power. Though the introduction of the four Ember seasons was not entirely due to him, as has sometimes been asserted, it is certain that their widespread observance was due to his influence, and to that of his successors, especially of Gregory the Great. The tendency to increased rigour may be discerned in the 2nd canon of the synod of Orleans (541), which declares that every Christian is bound to observe the fast of Lent, and, in case of failure to do so, is to be punished according to the laws of the church by his spiritual superior; in the 9th canon of the synod of Toledo (653), which declares the eating of flesh during Lent to be a mortal sin; in Charlemagne's law for the newly conquered Saxony, which attaches the penalty of death to wanton disregard of the holy season.⁶ Baronius mentions that in the 11th century those who ate flesh during Lent were liable to have their teeth knocked out. But it ought to be remembered that this severity of the law early began to be tempered by the power to grant dispensations. The so-called Butter Towers (*Tours de beurre*) of Rouen, 1485–1507, Bourges and other cities, are said to have been built with money raised by sale of dispensations to eat *lactinia* on fast days.

It is probable that the apparent severity of the medieval Latin Church on this subject was largely due to the real strictness of the Greek Church, which, under the patriarch Photius in 864, had taken what was virtually a new departure in its fasting praxis. The rigour of the fasts of the modern Greek Church is well known; and it can on the whole be traced back to that comparatively early date. Of the nine fundamental laws of that

¹ Quinam isti (adversarii) sint, semel nominabo: exteriores botuli psychicorum . . . Arguunt nos quod *jejunia propria* custodiamus, quod stationes plerumque in vesperam *producamus*, quod etiam *xerophagias* observemus, siccantes cibum ab omni carne et omni jurulenta et uvidioribus quibusque pomis, nec quid vinositatis vel edamus vel potemus; lavacri quoque abstinentiam congruentem arido victui.

² The language of the canon is ambiguous; but this interpretation seems to be preferable, especially in view of canon 23, which enacts that *jejunii superpositiones* are to be observed in all months except July and August. See Hefele, *Councils*, i. 148 (Engl. trs.).

³ Compare the 52nd [51st] of the Apostolical canons. "If any bishop or presbyter or deacon, or indeed any one of the sacerdotal catalogue, abstains from flesh and wine, not for his own exercise but out of hatred of the things, forgetting that all things were very good . . . either let him reform, or let him be deprived and be cast out of the church. So also a layman." To this particular canon Hefele is disposed to assign a very early date.

⁴ Compare canon 64 of the (supposed) fourth synod of Carthage: "He who fasts on Sunday is not accounted a Catholic" (Hefele, ii. 415).

⁵ Priscillian, whose widespread heresy evoked from the synod of Saragossa (418) the canon, "No one shall fast on Sunday, nor may any one absent himself from church during Lent and hold a festival of his own," appears, on the question of fasting, not to have differed from the Encratites and various other sects of Manichean tendency (c. 406).

⁶ Cap. iii. pro partib. Saxoniae: "Si quis sanctum quadragesimale jejunium pro despectu Christianitatis contempserit et carnem comederit, morte moriatur. Sed tamen contemneretur a sacerdote ne forte causa necessitatis hoc cuilibet proveniat, ut carnem comedat." See Augusti, *Christliche Archäologie*, x. p. 374.

church (ένέα παραγγέλματα τῆς ἐκκλησίας) two are concerned with fasting. Besides fasts of an occasional and extraordinary nature, the following are recognized as of stated and universal obligation:—(1) The Wednesday and Friday fasts throughout the year (with the exception of the period between Christmas and Epiphany, the Easter week, the week after Whitsunday, the third week after Epiphany); (2) The great yearly fasts, viz. that of Lent, lasting 48 days, from the Monday of Sexagesima to Easter eve; that of Advent, 39 days, from November 15 to Christmas eve; that of the Theotokos (νηστεία τῆς Θεοτόκου), from August 1 to August 15; that of the Holy Apostles, lasting a variable number of days from the Monday after Trinity; (3) The minor yearly fasts before Epiphany, before Whitsunday, before the feasts of the transfiguration, the invention of the cross, the beheading of John the Baptist. During even the least rigid of these the use of flesh and lactinia is strictly forbidden; fish, oil and wine are occasionally conceded, but not before two o'clock in the afternoon. The practice of the Coptic church is almost identical with this. A week before the Great Fast (Lent), a fast of three days is observed in commemoration of that of the Ninevites, mentioned in the book of Jonah. Some of the Copts are said to observe it by total abstinence during the whole period. The Great Fast continues fifty-five days; nothing is eaten except bread and vegetables, and that only in the afternoon, when church prayers are over. The Fast of the Nativity lasts for twenty-eight days before Christmas; that of the Apostles for a variable number of days from the Feast of the Ascension; and that of the Virgin for fifteen days before the Assumption. All Wednesdays and Fridays are also fast days except those that occur in the period between Easter and Whitsunday. The Armenians are equally strict; but (adds Rycaut) "the times seem so confused and without rule that they can scarce be recounted, unless by those who live amongst them, and strictly observe them, it being the chief care of the priest, whose learning principally consists in knowing the appointed times of fasting and feasting, the which they never omit on Sundays to publish unto the people."¹

At the council of Trent no more than a passing allusion was made to the subject of fasting. The faithful were simply enjoined to submit themselves to church authority on the subject; and the clergy were exhorted to urge their flocks to the observance of frequent jejunia, as conducive to the mortification of the flesh, and as assuredly securing the divine favour. R. F. R. Bellarmine (*De jejuniis*) distinguishes *jejunium spirituale* (*abstinentia a vitiis*), *jejunium morale* (*parsimonia et temperantia cibi et potus*), *jejunium naturale* (*abstinentia ab omni prorsus cibo et potu, quacunq; ratione sumpto*), and *jejunium ecclesiasticum*. The last he defines simply as an abstinence from food in conformity with the rule of the church. It may be either voluntary or compulsory; and compulsory either because of a vow or because of a command. But the definition given by Alexander Halensis, which is much fuller, still retains its authority:—"Jejunium est abstinentia a cibo et potu secundum formam ecclesiae, intuitu satisfaciendi pro peccato et acquirendi vitam aeternam." It was to this last clause that the Reformers most seriously objected. They did not deny that fasting might be a good thing, nor did they maintain that the church or the authority might not ordain fasts, though they deprecated the imposition of needless burdens on the conscience. What they protested against was the theory of the *opus operatum* et *meritorium* as applied to fasting. As matter of fact, the Reformed churches in no case gave up the custom of observing fast days, though by some churches the number of such days was greatly reduced. In many parts of Germany the seasons of Lent and Advent are still marked by the use of emblems of mourning in the churches, by the frequency of certain phrases (Kyrie eleison, Agnus Dei) and the absence of others (Hallelujah, Gloria in excelsis) in the liturgical services, by abstinence from some of the usual social festivities, and by the non-celebration of marriages. And occasional fasts are more

¹ See Fink's article "Fasten" in Ersch and Gruber's *Encyclopädie*; Lane, *Modern Egyptians*; and Rycaut, *Present State of the Armenian Church*.

or less familiar. The Church of England has retained a considerable list of fasts; though Hooker (*E.P.* v. 72) had to contend with some who, while approving of fastings undertaken "of men's own free and voluntary accord as their particular devotion doth move them thereunto," yet "yearly or weekly fasts such as ours in the Church of England they allow no further than as the temporal state of the land doth require the same for the maintenance of seafaring men and preservation of cattle; because the decay of the one and the waste of the other could not well be prevented but by a politic order appointing some such usual change of diet as ours is."

In the practice of modern Roman Catholicism the following are recognized as fasting days, that is to say, days on which one meal only, and that not of flesh, may be taken in the course of twenty-four hours:—The forty days of Lent (Sundays excepted), all the Ember days, the Wednesdays and Fridays in Advent, and the vigils of certain feasts, namely, those of Whitsuntide, of St Peter and St Paul, of the Assumption of the Blessed Virgin Mary, of All Saints and of Christmas day. The following are simply days of abstinence, that is to say, days on which flesh at all events must not be eaten:—The Sundays in Lent, the three Rogation days, the feast of St Mark (unless it falls in Easter week), and all Fridays which are not days of fasting. In the Anglican Church, the "days of fasting or abstinence" are the forty days of Lent, the Ember days, the Rogation days, and all the Fridays in the year, except Christmas day. The evens or vigils before Christmas, the Purification of the Blessed Virgin Mary, the Annunciation of the Blessed Virgin Mary, Easter day, Ascension day, Pentecost, St Matthias, the Nativity of St John Baptist, St Peter, St James, St Bartholomew, St Matthew, St Simon and St Jude, St Andrew, St Thomas, and All Saints are also recognized as "fast days." By the 64th canon it is enacted that "every parson, vicar or curate, shall in his several charge declare to the people every Sunday at the time appointed in the communion-book [which is, after the Nicene creed has been repeated] whether there be any holy-days or fast-days the week following." The 72nd canon ordains that "no minister or ministers shall, without licence and direction of the bishop under hand and seal, appoint or keep any solemn fasts, either publicly or in any private houses, other than such as by law are or by public authority shall be appointed, nor shall be wittingly present at any of them under pain of suspension for the first fault, of excommunication for the second, and of deposition from the ministry for the third." While strongly discouraging the arbitrary multiplication of public or private fasts, the English Church seems to leave to the discretion of the individual conscience every question as to the manner in which the fasts she formally enjoins are to be observed. In this connexion the homily *Of Fasting* may be again referred to. By a statute of the reign of Queen Elizabeth it was enacted that none should eat flesh on "fish days" (the Wednesdays, Fridays and Saturdays throughout the year) without a licence, under a penalty. In the Scottish Presbyterian churches days of "fasting, humiliation and prayer" are observed by ecclesiastical appointment in each parish once or twice every year on some day of the week preceding the Sunday fixed for the administration of the sacrament of the Lord's Supper. In some of the New England States, it has been usual for the governor to appoint by proclamation at some time in spring a day of fasting, when religious services are conducted in the churches. National fasts have more than once been observed on special occasions both in this country and in the United States of America.

On the subject of fasting the views of Aerius are to a large extent shared by modern Protestant moralists. R. Rothe, for example, who on this point may be regarded as a representative thinker, rejects the idea that fasting is a thing meritorious in itself, and is very doubtful of its value even as an aid to devotional feeling. Of course when bodily health and other circumstances require it, it becomes a duty; and as a means of self-discipline it may be used with due regard to the claims of other duties, and to the fitness of things. In this last aspect, however, habitual temperance will generally be found to be much more

beneficial than occasional fasting. It is extremely questionable, in particular, whether fasting be so efficient as it is sometimes supposed to be in protecting against temptation to fleshly sin. The practice has a well-ascertained tendency to excite the imagination; and in so far as it disturbs that healthy and well-balanced interaction of body and mind which is the best or at least the normal condition for the practice of virtue, it is to be deprecated rather than encouraged (*Theologische Ethik*, sec. 873-875).

Mahommedan Fasts.—Among the Mahommedans, the month Ramadan, in which the first part of the Koran is said to have been received, is by command of the prophet observed as a fast with extraordinary rigour. No food or drink of any kind is permitted to be taken from daybreak until the appearance of the stars at nightfall. Extending as it does over the whole "month of raging heat," such a fast manifestly involves considerable self-denial; and it is absolutely binding upon all the faithful whether at home or abroad. Should its observance at the appointed time be interfered with by sickness or any other cause, the fast must be kept as soon afterwards as possible for a like number of days. It is the only one which Mahommedanism enjoins; but the doctors of the law recommend a considerable number of voluntary fasts, as for example on the tenth day of the month Moharram. This day, called the "Yom Ashoorā," is held sacred on many accounts:—"because it is believed to be the day on which the first meeting of Adam and Eve took place after they were cast out of paradise; and that on which Noah went out from the ark; also because several other great events are said to have happened on this day; and because the ancient Arabs, before the time of the prophet, observed it by fasting. But what, in the opinion of most modern Moslems, and especially the Persians, confers the greatest sanctity on the day of Ashoorā is the fact of its being that on which El-Hoseyn, the prophet's grandson, was slain a martyr at the battle of the plain of Karbala." It is the practice of many Moslems to fast on this day, and some do so on the preceding day also. Mahomet himself called fasting the "gate of religion," and forbade it only on the two great festivals, namely, on that which immediately follows Ramadan and on that which succeeds the pilgrimage. (See Lane, *Modern Egyptians*, chaps. iii., xxiv.)

FASTOLF, SIR JOHN (d. 1459), English soldier, has enjoyed a more lasting reputation as in some part the prototype of Shakespeare's Falstaff. He was son of a Norfolk gentleman, John Fastolf of Caister, is said to have been squire to Thomas Mowbray, duke of Norfolk, before 1398, served with Thomas of Lancaster in Ireland during 1405 and 1406, and in 1408 made a fortunate marriage with Millicent, widow of Sir Stephen Scrope of Castle Combe in Wiltshire. In 1413 he was serving in Gascony, and took part in all the subsequent campaigns of Henry V. in France. He must have earned a good repute as a soldier, for in 1423 he was made governor of Maine and Anjou, and in February 1426 created a knight of the Garter. But later in this year he was superseded in his command by John Talbot. After a visit to England in 1428, he returned to the war, and on the 12th of February 1429 when in charge of the convoy for the English army before Orleans defeated the French and Scots at the "battle of herrings." On the 18th of June of the same year an English force under the command of Fastolf and Talbot suffered a serious defeat at Patay. According to the French historian Waurin, who was present, the disaster was due to Talbot's rashness, and Fastolf only fled when resistance was hopeless. Other accounts charge him with cowardice, and it is true that John of Bedford at first deprived him of the Garter, though after inquiry he was honourably reinstated. This incident was made unfavourable use of by Shakespeare in *Henry VI.* (pt. i. act iv. sc. i.). Fastolf continued to serve with honour in France, and was trusted both by Bedford and by Richard of York. He only came home finally in 1440, when past sixty years of age. But the scandal against him continued, and during Cade's rebellion in 1451 he was charged with having been the cause of the English disasters through minishing the garrisons of Normandy. It is suggested that he had made much money

in the war by the hire of troops, and in his later days he showed himself a grasping man of business. A servant wrote of him:—"cruel and vengible he hath been ever, and for the most part without pity and mercy" (*Paston Letters*, i. 389). Besides his share in his wife's property he had large estates in Norfolk and Suffolk, and a house at Southwark, where he also owned the Boar's Head Inn. He died at Caister on the 5th of November 1459. There is some reason to suppose that Fastolf favoured Lollardry, and this circumstance with the tradition of his braggart cowardice may have suggested the use of his name for the boon companion of Prince Hal, when Shakespeare found it expedient to drop that of Oldcastle. In the first two folios the name of the historical character in the first part of *Henry VI.* is given as "Falstaffe" not Fastolf. Other points of resemblance between the historic Fastolf and the Falstaff of the dramatist are to be found in their service under Thomas Mowbray, and association with a Boar's Head Inn. But Falstaff is in no true sense a dramatization of the real soldier.

The facts of Fastolf's early career are to be found chiefly in the chronicles of Monstrelet and Waurin. For his later life there is much material, including a number of his own letters, in the *Paston Letters*. There is a full life by W. Oldys in the *Biographia Britannica* (1st ed., enlarged by Gough in Kippis's edition). See also Dawson Turner's *History of Caister Castle*, Scrope's *History of Castle Combe*, J. Gairdner's essay *On the Historical Element in Shakespeare's Falstaff*, ap. *Studies in English History*, Sidney Lee's article in the *Dictionary of National Biography*, and D. W. Duthie, *The Case of Sir John Fastolf and other Historical Studies* (1907). (C. L. K.)

FAT (O.E. *fætt*; the word is common to Teutonic languages, cf. Dutch *vet*, Ger. *Fell*, &c., and may be ultimately related to Greek *πῶν* and *πῆπος*, and Sanskrit *pīvan*), the name given to certain animal and vegetable products which are oily solids at ordinary temperatures, and are chemically distinguished as being the glyceryl esters of various fatty acids, of which the most important are stearic, palmitic, and oleic; it is to be noticed that they are non-nitrogenous. Fat is a normal constituent of animal tissue, being found even before birth; it occurs especially in the intra-muscular, the abdominal and the subcutaneous connective tissues. In the vegetable kingdom fats especially occur in the seeds and fruits, and sometimes in the roots. Physiological subjects concerned with the part played by fats in living animals are treated in the articles **CONNECTIVE TISSUES**; **NUTRITION**; **CORPULENCE**; **METABOLIC DISEASES**. The fats are chemically similar to the fixed oils, from which they are roughly distinguished by being solids and not liquids (see **OILS**). While all fats have received industrial applications, foremost importance must be accorded to the fats of the domestic animals—the sheep, cow, ox and calf. These, which are extracted from the bones and skins in the first operation in the manufacture of gluc, are the raw materials of the soap, candle and glycerin industries.

FATALISM (Lat. *fatum*, that which is spoken, decreed), strictly the doctrine that all things happen according to a pre-arranged fate, necessity or inexorable decree. It has frequently been confused with determinism (*q.v.*), which, however, differs from it categorically in assigning a certain function to the will. The essence of the fatalistic doctrine is that it assigns no place at all to the initiative of the individual, or to rational sequence of events. Thus an oriental may believe that he is fated to die on a particular day; he believes that, whatever he does and in spite of all precautions he may take, nothing can avert the disaster. The idea of an omnipotent fate overruling all affairs of men is present in various forms in practically all religious systems. Thus Homer assumes a single fate (*Μοῖρα*), an impersonal power which makes all human concerns subject to the gods: it is not powerful over the gods, however, for Zeus is spoken of as weighing out the fate of men (*Il.* xxii. 209, viii. 69). Hesiod has three Fates (*Μοῖραι*), daughters of Night, Clotho, Lachesis and Atropos. In Aeschylus fate is powerful even over the gods. The Epicureans regarded fate as blind chance, while to the Stoics everything is subject to an absolute rational law.

The doctrine of fate appears also in what are known as the higher religions, e.g. Christianity and Mahommedanism. In the

former the ideas of personality and infinite power have vanished, all power being conceived as inherent in God. It is recognized that the moral individual must have some kind of initiative, and yet since God is omnipotent and omniscient man must be conceived as in some sense foreordained to a certain moral, mental and physical development. In the history of the Christian church emphasis has from time to time been laid specially on the latter aspect of human life (cf. the doctrines of election, foreordination, determinism). Even those theologians, however, who have laid special stress on the limitations of the human will have repudiated the strictly fatalistic doctrine which is characteristic of Oriental thought and is the negation of all human initiative (see PREDESTINATION; AUGUSTINE, SAINT; WILL). In Islam fate is an absolute power, known as *Kismet*, or *Nasib*, which is conceived as inexorable and transcending all the physical laws of the universe. The most striking feature of the Oriental fatalism is its complete indifference to material circumstances: men accept prosperity and misfortune with calmness as the decree of fate.

FATE, in Roman mythology, the spoken word (*fatum*) of Jupiter, the unalterable will of heaven. The plural (*Fata*, the Fates) was used for the "destinies" of individuals or cities, and then for the three goddesses who controlled them. Thus, *Fata Scribunda* were the goddesses who wrote down a man's destiny at his birth. In this connexion, however, *Fata* may be singular, the masculine and feminine *Fatus*, *Fata*, being the usual forms in popular and ceremonial language. The Fates were also called *Parcae*, the attributes of both being the same as those of the Greek *Moerae*.

FATEHPUR, **FATHIPUR** or **FUTTEHPOOR**, a town and district of British India, in the Allahabad division of the United Provinces. The town is 73 m. by rail N.W. of Allahabad. Pop. (1901) 19,281. The district has an area of 1618 sq. m. It is situated in the extreme south-eastern corner of the Doab or tract of country between the Ganges and the Jumna, which respectively mark its northern and southern boundaries. The whole district consists of an alluvial plain formed by the deposits of the two great rivers. The central part is almost perfectly level, and consists of highly cultivated land interspersed with jungle and with tracts impregnated with saltpetre (*usar*). A ridge of higher land, forming the watershed of the district, runs along it from east to west at an average distance of about 5 m. from the Ganges. Fatehpur therefore consists of two inclined planes, the one 5 m. broad, sloping down rapidly to the Ganges, and the other from 15 to 20 m. broad, falling gradually to the Jumna. The country near the banks of the two rivers is cut up into ravines and nullahs running in all directions, and is almost entirely uncultivable. Besides the Ganges and Jumna the only rivers of importance are the Pandu, a tributary of the Ganges, and the Arind and Nun, which both fall into the Jumna. The climate is more humid than in the other districts of the Doab, and although fevers are common, it is not considered an unhealthy district. The average annual rainfall is 34 in.

The tract in which this district is comprised was conquered in 1194 by the Pathans; but subsequently, after a desperate resistance, it was wrested from them by the Moguls. In the 18th century it formed a part of the *subah* of Korah, and was under the government of the wazir of Oudh. In 1736 it was overrun by the Mahrattas, who retained possession of it until, in 1750, they were ousted by the Pathans of Fatehpur. In 1753 it was reconquered by the nawab of Oudh. In 1765, by a treaty between the East India Company and the nawab, Korah was made over to the Delhi emperor, who retained it till 1774, when it was again restored to the nawab wazir's dominions. Finally in 1801, the nawab, by treaty, reconveyed it to the Company in commutation of the amount which he had stipulated to pay in return for the defence of his country. In June 1857 the district rose in rebellion, and the usual murders of Europeans took place. Order was established after the fall of Lucknow, on the return of Lord Clyde's army to Cawnpore. In 1901 the population was 686,391, showing a decrease of 2 % in the decade. The district is traversed by the main line of the East Indian railway from

Allahabad to Cawnpore. Trade is mainly agricultural, but the town of Fatehpur is noted for the manufacture of ornamental whips, and Jafarganj for artistic curtains, &c.

FATEHPUR SIKRI, a town in the Agra district in the United Provinces of India, on the road from Agra to Jaipur. Pop. (1901) 7147. It is a ruined city, and is interesting only from an archaeological point of view. It was founded by Akbar in 1569 as a thank-offering for the birth of a son, Selim, afterwards the emperor Jahangir, foretold by Selim Chisti, a famous Mahomedan saint. The principal building is the great mosque, which is said by Fergusson to be hardly surpassed by any in India. "It measures 550 ft. east and west by 470 ft. north and south, over all. The mosque itself, 250 ft. by 80 ft., is crowned by three domes. In its courtyard, which measures 350 ft. by 440 ft., stand two tombs. One is that of Selim Chisti, built of white marble, and the windows with pierced tracery of the most exquisite geometrical patterns. It possesses besides a deep cornice of marble, supported by brackets of the most elaborate design. The other tomb, that of Nawab Islam Khan, is soberer and in excellent taste, but quite eclipsed by its surroundings. Even these parts, however, are surpassed in magnificence by the southern gateway. As it stands on a rising ground, when looked at from below its appearance is noble beyond that of any portal attached to any mosque in India, perhaps in the whole world." Among other more noteworthy buildings the following may be mentioned. The palace of Jodh Bai, the Rajput wife of Akbar, consists of a courtyard surrounded by a gallery, above which rise buildings roofed with blue enamel. A rich gateway gives access to a terrace on which are the "houses of Birbal and Miriam"; and beyond these is another courtyard, where are Akbar's private apartments and the exquisite palace of the Turkish sultana. Here are also the Panch Mahal or five-storeyed building, consisting of five galleries in tiers, and the audience chamber. The special feature in the architecture of the city is the softness of the red sandstone, which could be carved almost as easily as wood, and so lent itself readily to the elaborate Hindu embellishment. Fatehpur Sikri was a favourite residence of Akbar throughout his reign, and his establishment here was of great magnificence. After Akbar's death Fatehpur Sikri was deserted within 50 years of its foundation. The reason for this was that frequent cause in the East, lack of water. The only water obtainable was so brackish and corroding as to cause great mortality among the inhabitants. The buildings are situated within an enclosure, walled on three sides and about 7 m. in circumference. They are all now more or less in ruins, and their elaborate painting and other decoration has largely perished, but some modern restoration has been effected.

See E. B. Havell, *A Handbook to Agra and the Taj, Sikandra, Fatehpur Sikri*, &c. (1904).

FATHER, the begetter of a child, the male parent. The word is common to Teutonic languages, and, like the other words for close family relationship, mother, brother, son, sister, daughter, appears in most Indo-European languages. The O. Eng. form is *fæder*, and it appears in Ger. *Vater*, Dutch *vader*, Gr. *πατήρ*, Lat. *pater*, whence Romanic Fr. *père*, Span. *padre*, &c. The word is used of male ancestors more remote than the actual male parent, and of ancestors in general. It is applied to God, as the Father of Jesus Christ, and as the Creator of the world, and is thus the orthodox term for the First Person of the Trinity. Of the transferred uses of the word many have religious reference; thus it is used of the Christian writers, usually confined to those of the first five centuries, the Fathers of the Church (see below), of whom those who flourished at the end of, or just after the age of, the apostles are known as the Apostolic Fathers. One who stands as a spiritual parent to another is his "father," e.g. god-father, or in the title of bishops or archbishops, Right or Most Reverend Father in God. The pope is, in the Roman Church, the Holy Father. In the Roman Church, father is strictly applied to a "regular," a member of one of the religious orders, and so always in Europe, in English usage, often applied to a confessor, whether regular or secular, and to any Roman priest, and sometimes used of sub-members of a religious society or fraternity

in the English Church. Of transferred uses, other than religious, may be mentioned the application to the first founders of an institution, constitution, epoch, &c. Thus the earliest settlers of North America are the Pilgrim Fathers, and the framers of the United States constitution are the Fathers of the Constitution. In ancient Rome the members of the senate are the *Patres conscripti*, the "Conscript fathers." The senior member or doyen of a society is often called the father. Thus the member of the English House of Commons, and similarly, of the House of Representatives in the United States, America, who has sat for the longest period uninterruptedly, is the Father of the House.

FATHERS OF THE CHURCH. The use of the word "father" as a title of respect is found in the Old Testament, where it is applied to patriarchs (Gen. i. 24 (Septuagint); Exod. iii. 13, 15; Deut. i. 8), priests (Judg. xvii. 10, xviii. 19), prophets (2 Kings ii. 12, vi. 21, xiii. 14), and distinguished ancestors (*Ecclus.* xlv. 1). In the time of our Lord the scribes claimed the name with an arrogance which He disapproved (Matt. xxiii. 9); in the rabbinic literature "the fathers" are the more eminent of the earlier rabbis whose sayings were handed down for the guidance of posterity.¹ The Christian Church, warned perhaps by the words of Christ, appears at first to have avoided a similar use of the term, while St Paul, St Peter and St John speak of their converts as spiritual children (1 Cor. iv. 14 f., Gal. iv. 19, 1 Pet. v. 13, 1 John ii. 12); they did not assume, so far as we know, the official style of "fathers in God." Nor is this title found in the age which succeeded to that of the apostles. When Polycarp, bishop of Smyrna, was martyred (A.D. 155), the crowd shouted, "This is the father of the Christians"²; but the words were probably prompted by the Jews, who took a prominent part in the martyrdom, and who naturally viewed Polycarp in the light of a great Christian rabbi, and gave him the title which their own teachers bore. In the next century members of the episcopal order were sometimes addressed in this manner: thus Cyprian is styled *papas* or *papa* by his Roman correspondents.³ The bishops who sat in the great councils of the 4th century were known as "the 318 fathers" of Nicaea, and "the 150 fathers" of Constantinople. Meanwhile the custom was growing up of appealing to eminent Church writers of a past generation under this name. Thus Athanasius writes (*ad Afros* vi.): "We have the testimony of fathers (the two Dionysii, bishops of Alexandria and Rome, who wrote in the previous century) for the use of the word *ἡμῶν*." Such quotations were multiplied, as theologians learnt to depend increasingly upon their predecessors, until the testimony of "our holy father" Athanasius, or Gregory the Divine, or John the Golden-mouthed, came to be regarded as decisive in reference to controverted points of faith and practice.

In the narrower sense thus indicated the "fathers" of the Church are the great bishops and other eminent Christian teachers of the earlier centuries, who were conspicuous for soundness of judgment and sanctity of life, and whose writings remained as a court of appeal for their successors. A list of fathers drawn up on this principle will begin with the Christian writers of the 1st century whose writings are not included in the New Testament: where it ought to end is a more difficult point to determine. Perhaps the balance of opinion is in favour of regarding Gregory the Great (d. 604) as the last of the Latin fathers, and John of Damascus (d. c. 760) as the last of the fathers of the Greek Church. A more liberal estimate might include John Scotus Erigena or even Anselm or Bernard of Clairvaux in the West and Photius in the East. The abbé Migne carried his Latin patrology down to the time of Innocent III. (d. 1216), and his Greek patrology to the fall of Constantinople (1453); but, while this large extension of the field is much to the advantage of his readers, it undoubtedly stretches the meaning of *patrologia* far beyond its natural limits. For ordinary purposes it is best to make the patristic period coterminous with the life

of the ancient Catholic Church. In the West the Church enters the medieval stage of its history with the death of Gregory, while in the East even John of Damascus is rather a compiler of patristic teaching than a true "father."

A further question arises. Are all the Christian writers of a given period to be included among the "fathers," or those only who wrote on religious subjects, and of whose orthodoxy there is no doubt? Migne, following the example of the editors of *bibliothecae patrum* who preceded him, swept into his great collection all the Christian writings which fell within his period; but he is careful to state upon his title-page that his patrologies include the ecclesiastical writers as well as the fathers and doctors of the Church. For a comprehensive use of the term "ecclesiastical writers" he has the authority of Jerome, who enumerates among them⁴ such heresiarchs or leaders of schism as Tatian, Bardaisan, Novatus, Donatus, Photinus and Eunomius. This may not be logical, but long usage has made it permissible or even necessary. It is often difficult, if not impracticable, to draw the line between orthodox writers and heterodox; on which side, it might be asked, is Origen to be placed? and in the case of a writer like Tertullian who left the Church in middle life, are we to admit certain of his works into our patrology and refuse a place to others? It is clear that in the circumstances the terms "father," "patristic," "patrology" must be used with much elasticity, since it is now too late to substitute for them any more comprehensive terms.

By the "fathers," then, we understand the whole of extant Christian literature from the time of the apostles to the rise of scholasticism or the beginning of the middle ages. However we may interpret the lower limit of this period, the literature which it embraces is immense. Some method of subdivision is necessary, and the simplest and most obvious is that which breaks the whole into two great parts, the ante-Nicene and the post-Nicene. This is not an arbitrary cleavage; the Council of Nicaea (A.D. 325) is the watershed which actually separates two great tracts of Christian literature. The ante-Nicene age yields priceless records of the early struggles of Christianity; from it we have received specimens of the early apologetic and the early polemic of the Church, the first essays of Christian philosophy, Christian correspondence, Christian biblical interpretation: we owe to it the works of Justin, Irenaeus, the Alexandrian Clement, Origen, Tertullian, Cyprian. In these products of the 2nd and 3rd centuries there is much which in its own way was not surpassed by any of the later patristic writings. Yet the post-Nicene literature, considered as literature, reaches a far higher level. Both in East and West, the 4th and 5th centuries form the golden age of dogmatic theology, of homiletic preaching, of exposition, of letter-writing, of Church history, of religious poetry. Two causes may be assigned for this fact. The conversion of the empire gave the members of the Church leisure and opportunities for the cultivation of literary taste, and gradually drew the educated classes within the pale of the Christian society. Moreover, the great Christological controversies of the age tended to encourage in Christian writers and preachers an intellectual acuteness and an accuracy of thought and expression of which the earlier centuries had not felt the need.

The ante-Nicene period of patristic literature opens with the "apostolic fathers,"⁵ i.e. the Church writers who flourished toward the end of the apostolic age and during the half century that followed it, including Clement of Rome, Ignatius of Antioch, Polycarp of Smyrna and the author known as "Barnabas." Their writings, like those of the apostles, are epistolary; but editions of the apostolic fathers now usually admit also the early Church order known as the *Didachē*, the allegory entitled the *Shepherd*, and a short anonymous apology addressed to one Diognetus. A second group, known as the "Greek Apologists," embraces Aristides, Justin, Tatian, Athenagoras and Theophilus; and a third consists of the early polemical writers, Irenaeus and

⁴ In his book *De viris illustribus*.

⁵ The term *patres apostolici* is due to the patristic scholars of the 17th century: see Lightfoot, *St. Clement of Rome*, i. p. 3. "Sub-apostolic" is perhaps a more accurate designation.

¹ See Buxtorf, *s.v. Abh*, and cf. the title of the tract *Pirke Aboth* (ed. Taylor, p. 3).

² *Polyc. Mart.* 8.

³ *Studia biblica*, iv. p. 273.

Hippolytus. Next come the great Alexandrians, Clement, Origen, Dionysius; the Carthaginians, Tertullian and Cyprian; the Romans, Minucius Felix and Novatian; the last four laid the foundations of a Latin Christian literature. Even the stormy days of the last persecution yielded some considerable writers, such as Methodius in the East and Lactantius in the West. This list is far from complete; the principal collections of the ante-Nicene fathers include not a few minor and anonymous writers, and the fragments of many others whose works as a whole have perished.

In the post-Nicene period the literary output of the Church was greater. Only the more representative names can be mentioned here. From Alexandria we get Athanasius, Didymus and Cyril; from Cyrene, Synesius; from Antioch, Theodore of Mopsuestia, John Chrysostom and Theodoret; from Palestine, Eusebius of Caesarea and Cyril of Jerusalem; from Cappadocia, Basil, Gregory of Nyssa and Gregory of Nazianzus. The Latin West was scarcely less productive; it is enough to mention Hilary of Poitiers, Ambrose of Milan, Augustine of Hippo, Leo of Rome, Jerome, Rufinus, and a father lately restored to his place in patristic literature, Niceta of Remesiana.¹ Gaul alone has a goodly list of Christian authors to show: John Cassian, Vincent of Lerins, Hilary of Arles, Prosper of Aquitaine, Salvian of Marseilles, Sidonius Apollinaris of Auvergne, Caesarius of Arles, Gregory of Tours. The period ends in the West with two great Italian names, Cassiodorus and Pope Gregory I., after Leo the greatest of papal theologians.

The reader to whom the study is new will gain some idea of the bulk of the extant patristic literature, if we add that in Migne's collection ninety-six large volumes are occupied with the Greek fathers from Clement of Rome to John of Damascus, and seventy-six with the Latin fathers from Tertullian to Gregory the Great.²

For a discussion of the more important fathers the student is referred to the articles which deal with them separately. In this place it is enough to consider the general influence of the patristic writings upon Christian doctrine and biblical interpretation. Can any authority be claimed for their teaching or their exegesis, other than that which belongs to the best writers of every age. The decree of the council of Trent³ (*ut nemo . . . contra unanimum consensum patrum ipsam scripturam sacram interpretari audeat*) is studiously moderate, and yet it seems to rule that under certain circumstances it is not permitted to the Church of later times to carry the science of biblical interpretation beyond the point which it had reached at the end of the patristic period. Roman Catholic writers,⁴ however, have explained the prohibition to apply to matters of faith only, and in that case the Tridentine decree is little else than another form of the Vincentian canon which has been widely accepted in the Anglican communion: *curandum est ut id teneamus quod ubique, quod semper, quod ab omnibus creditum est*. The fathers of the first six or seven centuries, so far as they agree, may be fairly taken to represent the main stream of Christian tradition and belief during the period when the apostolic teaching took shape in the great creeds and dogmatic decisions of Christendom. The English reformers realized this fact; and notwithstanding their insistence on the unique authority of the canon of Scripture, their appeal to the fathers as representatives of the teaching of the undivided Church was as wholehearted as that of the Tridentine divines. Thus the English canon of 1571 directs preachers "to take heed that they do not teach anything in their sermons as though they would have it completely held and believed by the people, save what is agreeable to the doctrine of the Old and New Testaments, and what the Catholic Fathers and ancient Bishops have gathered from that doctrine." Depreciation of the fathers was characteristic, not of the Anglican reformation, but of the

revolt against some of its fundamental principles which was led by the Puritan reaction.⁵

Now that the smoke of these controversies has passed away, it is possible to form a clearer judgment upon the merits of the patristic writings. They are no longer used as an armoury from which opposite sides may draw effective weapons, offensive or defensive; nor on the other hand are they cast aside as the rubbish of an ignorant and superstitious age. All patristic students now recognize the great inequality of these authors, and admit that they are not free from the faults of their times; it is not denied that much of their exegesis is untenable, or that their logic is often feeble and their rhetoric offensive to modern taste. But against these disadvantages may be set the unique services which the fathers still render to Christian scholars. Their works comprise the whole literature of our faith during the decisive centuries which followed the apostolic age. They are important witnesses to the text of the New Testament, to the history of the canon, and to the history of interpretation. It is to their pages that we owe nearly all that we know of the life of ancient Christianity. We see in them the thought of the ancient Church taking shape in the minds of her bishops and doctors; and in many cases they express the results of the great doctrinal controversies of their age in language which leaves little to be desired.⁶

AUTHORITIES.—The earliest writer on patristics was Jerome, whose book *De viris illustribus* gives a brief account of one hundred and thirty-five Church writers, beginning with St Peter and ending with himself. Jerome's work was continued successively by Gennadius of Marseilles, Isidore of Seville, and Hedefonsus of Toledo; the last-named writer brings the list down to the middle of the 7th century. Since the revival of learning books on the fathers have been numerous; among the more recent and most accessible of these we may mention Smith and Wace's *Dictionary of Christian Biography*, Hauck-Herzog's *Realencyklopädie*, Bardenhewer's *Patrologie und Geschichte der altkirchlichen Litteratur*, Harnack's *Geschichte der altchristlichen Litteratur bei Eusebius* and Ehrard's *Die altchristliche Litteratur und ihre Erforschung*. A record of patristic collections and editions down to 1839 may be found in Dowling's *Notitia Scriptorum SS. Patrum*. The contents of the volumes of Migne's patrologies are given in the *Catalogue général des livres de l'abbé Migne*, and a useful list in alphabetical order of the writers in the Greek *Patrologia* has been compiled by Dr J. B. Pearson (Cambridge, 1882). Migne's texts are not always satisfactory, but since the completion of his great undertaking two important collections have been begun on critical lines—the Vienna edition of the Latin Church writers,⁷ and the Berlin edition of the Greek writers of the ante-Nicene period.⁸

For English readers there are three series of translations from the fathers, which cover much of the ground; the Oxford *Library of the Fathers*, the *Ante Nicene Christian Library* and the *Select Library of Nicene and Post-Nicene Fathers*. Satisfactory lexicons of patristic Greek and Latin are still a desideratum: but assistance may be obtained in the study of the Greek fathers from Suicer's *Thesaurus*, the *Lexicon of Byzantine Greek* by E. A. Sophocles, and the *Lexicon Graecum supplementum et dialecticum* of Van Herwerden; whilst the new great *Latin Lexicon*, published by the Berlin Academy, is calculated to meet the needs of students of Latin patristic literature. For a fuller list of books useful to the reader of the Greek and Latin fathers see H. B. Swete's *Patristic Study* (2nd ed., 1902). (H. B. S.)

FATHOM (a word common, in various forms, to Scandinavian and Teutonic languages; cf. Danish *favn*, Dutch *vaam* and Ger. *Faden*, and meaning "the arms extended"; the ultimate origin is a root *pel*, seen in the Gr. *περαυύβαιναι*, to spread), a measure of length, being the distance from the tip of one middle finger to the tip of the other, when the arms are stretched out to their widest extent. This length has been standardized to a measure of 6 ft., and as such is used mainly in soundings as a unit for measuring the depth of the sea. "Fathom" is also used in the measurement of timber, when it is equivalent to 6 ft. sq.; similarly, in mining, a fathom is a portion of ground running the whole thickness of the vein of ore, and is 6 ft. in breadth and thickness. The verb "to fathom," *i.e.* to sound or measure with a fathom-line, is used figuratively, meaning to go into a subject deeply, to penetrate, or to explore thoroughly.

⁵ See J. J. Blunt, *Right Use of the Fathers*, p. 15 ff.

⁶ See Stanton, *Place of Authority in Religion*, p. 165 f.

⁷ *Corpus scriptorum ecclesiasticorum Latinorum*.

⁸ *Griechischen christlichen Schriftstellern der ersten drei Jahrhunderte*.

¹ The *editio princeps* of Niceta's works was published by Dr A. E. Burn in 1905.

² The Greek patrology contains, however, besides the text, a Latin translation, and in both patrologies there is much editorial matter.

³ Sess. iv.

⁴ E. G. Möhler, *Symbolism* (E. tr.) § 42.

FATIMITES, or **FATIMIDES**, the name of a dynasty called after Fatima, daughter of the prophet Mahomet, from whom and her husband the caliph Ali, son of Abu Talib, they claimed descent. The dynasty is also called 'Obaidi (Ubaidi) after 'Obaidallah, the first sovereign, and 'Alawi, a title which it shares with other dynasties claiming the same ancestry. For a list of sovereigns see **EGYPT**, section *History* (Mahomedan period); three, however, must be prefixed who reigned in north-western Africa before the annexation of Egypt: al-Mahdi 'Obaidallah 297 (909); al-Qā'im Mahommed 322 (934); al-Mansur Ismā'il 334 (945).

The dynasty owed its rise to the attachment to the family of the prophet which was widespread in the Moslem world, and the belief that the sovereignty was the right of one of its members. Owing, however, to the absence of the principle of primogeniture there was difference of opinion as to the person whose claim should be enforced, and a number of sects arose maintaining the rights of different branches of the family. The Fatimites were supported by those who regarded the sovereignty as vested in Ismā'il, son of Ja'far al-Sādiq, great-great-grandson of Ali, through his second son Hosain (Ḥusain). Of this Ismā'il the first Fatimite caliph was supposed to be the great-grandson. The line of ancestors between him and Ismā'il is, however, variously given, even his father's name being quite uncertain, and in some of the pedigrees even Ismā'il does not figure. Apparently when the family first became of political importance their Alid descent was not disputed at Bagdad, and the poet al-Sharif al-Radi (d. A.H. 406: A.D. 1015), in whose family the office of Naqib (registrar of the Alids) was hereditary, appears to have acknowledged it (*Diwan*, ed. Beirut, p. 972). When their success became a menace to the caliphs of Bagdad, genealogists were employed to demonstrate the falsity of the claim, and a considerable literature, both official and unofficial, rose in consequence. The founder of the dynasty was made out to be a scion of a family of heretics from whom the terrible Carmathian sect had originated: later on (perhaps owing to the rôle played by Jacob, son of Killis, in bringing the Fatimites to Egypt), the founder was made out to have been a Jew, either as having been adopted by the heretic supposed to be his father, or as having been made to personate the real 'Obaidallah, who had been killed in captivity. While the stories that make him of either Jewish or Carmathian origin may be neglected, as the product of malice, the uncertainty of the genealogies offered by their partisans renders any positive solution of the problem impossible. What seems to be clear is that secretly within the Abbasid empire propaganda was carried on in favour of one or other Alid aspirant, and the danger which any such aspirant incurred by coming forward openly led to his whereabouts being concealed except from a very few adherents. What is known then is that towards the end of the 3rd Islamic century the leader of the sect of Ismā'ilites (Assassins, *q.v.*) who afterwards mounted a throne, lived at Salamia, near Emesa (Homs), having agents spread over Arabia, Persia and Syria, and frequently receiving visits from pious adherents, who had been on pilgrimage to the grave of Hosain (Ḥusain). Such visitors received directions and orders such as are usual in secret societies. One of these agents, Abū Abdallah al-Hosain called al-Shi'i, said to have filled the office of censor (*muhāsib*) at Basra, received orders to carry on a mission in Arabia, and at Mecca is said to have made the acquaintance of some members of the Berber tribe Kutama, south of the bay of Bougie. These persons persuaded him to travel home with them in the character of teacher of the Koran, but according to some authorities the ground had already been prepared there for a political mission. He arrived in the Kutama country in June 893, and appears very soon to have been made chief, thereby exciting the suspicion of the Aghlabite ruler of Kairawān, Ibrāhīm b. Aḥmad, which, however, was soon allayed. His success provoked a civil war among the Berbers, but he was protected by a chief named Ḥasan b. Hārūn, and displayed sufficient military ability to win respect. Nine years after his arrival he made use of the unrest following on the death of the Aghlabite Ibrāhīm to attack the town of Mila,

which he took by treachery, and turned into his capital; the son and successor of Ibrāhīm, Abu'l-'Abbās 'Abdallah, sent his son al-Aḥwal to deal with the new power, and he defeated al-Shi'i in some battles, but in 903 al-Aḥwal was recalled by his brother Ziyādattallah, who had usurped the throne, and put to death.

At some time after his first successes al-Shi'i sent a messenger (apparently his brother) to the head of his sect at Salamia, bidding him come to the Kutama country, and place himself at the head of affairs, since al-Shi'i's followers had been taught to pay homage to a Mahdi who would at some time be shown them. It is said that 'Obaidallah, who now held this post, was known to the court at Bagdad, and that on the news of his departure orders were sent to the governor of Egypt to arrest him: but by skilful simulation 'Obaidallah succeeded in escaping this danger, and with his escort reached Tripoli safely. Instructions had by this time reached the Aghlabite Ziyādattallah to be on the watch for the Mahdi, who was finally arrested at Sijilmāsa (Tafilalt) in the year A.H. 292 (A.D. 905); his companion, al-Shi'i's brother, had been arrested at an earlier point, and the Mahdi's journey to the south-west must have been to elude pursuit.

The invitation to the Mahdi turned out to have been premature; for Ziyādattallah had sent a powerful army to oppose al-Shi'i, which, making Constantine its headquarters, had driven al-Shi'i into the mountains: after six months al-Shi'i secured an opportunity for attacking it, and won a complete victory. Early in 906 another army was sent to deal with al-Shi'i, and an earnest appeal came from the caliph Muqtafi (Moktafi), addressed to all the Moslems of Africa, to aid Ziyādattallah against the usurper. The operations of the Aghlabite prince were unproductive of any decided result, and by September 906 al-Shi'i had got possession of the important fortress Tubna and some others. Further forces were immediately sent to the front by Ziyādattallah, but these were defeated by al-Shi'i and his officers, to whom other towns capitulated, till Ziyādattallah found it prudent to retire from Al-Urbus or Laribus, which had been his headquarters, and entrench himself in Raqqāda, one of the two capitals of his kingdom, Kairawān being the other. Ziyādattallah is charged by the chroniclers with dissoluteness and levity, and even cowardice: after his retreat the fortresses and towns in what now constitute the department of Constantine and in Tunisia fell fast into al-Shi'i's hands, and he was soon able to threaten Raqqāda itself.

By March 909 Raqqāda had become untenable, and Ziyādattallah resolved to flee from his kingdom; taking with him his chief possessions, he made for Egypt, and thence to 'Irak: his final fate is uncertain. The cities Raqqāda and Kairawān were immediately occupied by Al-Shi'i, who proceeded to send governors to the other places of importance in what had been the Aghlabite kingdom, and to strike new coins, which, however, bore no sovereign's name. Orders were given that the Shi'ite peculiarities should be introduced into public worship.

In May 909 al-Shi'i led a tremendous army westwards to the kingdom of Tahert, where he put an end to the Rustamite dynasty, and appointed a governor of his own: he thence proceeded to Sijilmāsa where 'Obaidallah lay imprisoned, with the intention of releasing him and placing him on the throne. After a brief attempt at resistance, the governor fled, and al-Shi'i entered the city, released 'Obaidallah and presented him to the army as the long-promised Imām. The day is given as the 26th of August 909. 'Obaidallah had been in prison more than three years. Whether his identity with the Mahdi for whom al-Shi'i had been fighting was known to the governor of Sijilmāsa is uncertain. If it was, the governor and his master the Aghlabite sovereign might have been expected to make use of their knowledge and outwit al-Shi'i by putting his Mahdi to death. Opponents of the Fatimites assert that this was actually done, and that the Mahdi presented to the army was not the real 'Obaidallah, but (as usual) a Jewish captive, who had been suborned to play the rôle.

The chief command was now assumed by 'Obaidallah, who took the title "al-Mahdi, Commander of the Faithful," thereby claiming the headship of the whole Moslem world: Raqqāda

was at the first made the seat of the court, and the Shī'ite doctrines were enforced on the inhabitants, not without encountering some opposition. Revolts which arose in different parts of the Aghlabite kingdom were, however, speedily quelled.

The course followed by 'Obaidallah in governing independently of al-Shī'ī soon led to dissatisfaction on the part of the latter, who, urged on it is said by his brother, decided to dethrone their Mahdī, and on the occasion of an expedition to Ténés, which al-Shī'ī commanded, organized a conspiracy with that end. The conspiracy was betrayed to 'Obaidallah, who took steps to defeat it, and on the last day of July 911 contrived to assassinate both al-Shī'ī and his brother. Thus the procedure which had characterized the accession of the 'Abbāsīd dynasty was repeated. It has been conjectured that these assassinations lost the Fatimites the support of the organization that continued to exist in the East, whence the Carmathians figure as an independent and even hostile community, though they appear to have been amenable to the influence of the African caliph.

'Obaidallah had now to face the dissatisfaction of the tribes whose allegiance al-Shī'ī had won, especially the Kutāma, Zenāta and Lawāta: the uprising of the first assumed formidable proportions, and they even elected a Mahdī of their own, one Kādū b. Mu'arik al-Māwatī, who promulgated a new revelation for their guidance. They were finally defeated by 'Obaidallah's son Abu'l-Qāsim Mahommed, who took Constantine, and succeeded in capturing the new Mahdī, whom he brought to Raqqāda. Other opponents were got rid of by 'Obaidallah by ruthless executions. By the middle of the year 913 by his own and his son's efforts he had brought his kingdom into order. After the style of most founders of dynasties he then selected a site for a new capital, to be called after his title Mahdiā (*q.v.*), on a peninsula called Ḥamma (Cape Africa) S.S.E. of Kairawān. Eight years were spent in fortifying this place, which in 921 was made the capital of the empire.

After defeating internal enemies 'Obaidallah turned his attention to the remaining 'Abbāsīd possessions in Africa, and his general Habāsah b. Yūsuf in the year 913 advanced along the northern coast, taking various places, including the important town of Barca, his progress, it is said, being marked by great cruelty. He then advanced towards Egypt, and towards the end of July 914, being reinforced by Abu'l-Qāsim, afterwards al-Qā'im, entered Alexandria. The danger led to measures of unusual energy being taken by the Bagdad caliph Moqtadir, an army being sent to Egypt under Mu'nīs, and a special post being organized between that country and Bagdad to convey messages uninterruptedly. The Fatimite forces were defeated, partly owing to the insubordination of the general Habāsah, in the winter of 914, and returned to Barca and Kairawān with great loss.

A second expedition was undertaken against Egypt in the year 919, and on the 10th of July Alexandria was entered by Abu'l-Qāsim, who then advanced southward, seizing the Fayum and Ushmūnain (Eshmunain). He was presently reinforced by a fleet, which, however, was defeated at Rosetta in March of the year 920 by a fleet despatched from Tarsus by the 'Abbāsīd caliph Moqtadir, most of the vessels being burned. Through the energetic measures of the caliph, who sent repeated reinforcements to Fostat, Abu'l-Qāsim was compelled in the spring of 921 to evacuate the places which he had seized, and return to the west with the remains of his army, which had suffered much from plague as well as defeat on the field. On his return he found that the court had migrated from Raqqāda to the new capital Mahdiā (*q.v.*). Meanwhile other expeditions had been despatched by 'Obaidallah towards the west, and Nekor (Nakur) and Fez had been forced to acknowledge his sovereignty.

The remaining years of 'Obaidallah's reign were largely spent in dealing with uprisings in various parts of his dominions, the success of which at times reduced the territory in which he was recognized to a small area.

'Obaidallah died on the 4th of March 933, and was succeeded by Abu'l-Qāsim, who took the title al-Qā'im bi-amr Allah. He immediately after his accession occupied himself with the

reconquest of Fez and Nekor, which had revolted during the last years of the former caliph. He also despatched a fleet under Ya'qūb b. Ishāq, which ravaged the coast of France, took Genoa, and plundered the coast of Calabria before returning to Africa. A third attempt made by him to take Egypt resulted in a disastrous defeat at Dhāt al-Humān, after which the remains of the expedition retreated in disorder to Barca.

The later years of the reign of Qā'im were troubled by the uprising of Abū Yazīd Makhhlad al-Zenātī, a leader who during the former reign had acquired a following among the tribes inhabiting the Jebel Aures, including adherents of the 'Ibādī sect. After having fled for a time to Mecca, this person returned in 937 to Tazuzar (Touzer), the original seat of his operations, and was imprisoned by Qā'im's order. His sons, aided by the powerful tribe Zenāta, succeeded in forcing the prison, and releasing their father, who continued to organize a conspiracy on a vast scale, and by the end of 943 was strong enough to take the field against the Fatimite sovereign, whom he drove out of Kairawān. Abū Yazīd proclaimed himself a champion of Sunnī doctrine against the Shī'is, and ordered the legal system of Mālik to be restored in place of that introduced by the Fatimites. Apparently the doctrines of the latter has as yet won little popularity, and Abū Yazīd won an enormous following, except among the Kutāma, who remained faithful to Qā'im. On the last day of October 944, an engagement was fought between Kairawān and Mahdiā at a place called al-Akhawān, which resulted in the rout of Qā'im's forces, and the caliph's being shortly after shut up in his capital, the suburbs of which he defended by a trench. Abū Yazīd's forces were ill-suited to maintain a protracted siege, and since, owing to the former caliph's forethought, the capital was in a condition to hold out for a long time, many of them deserted and the besiegers gained no permanent advantage. After the siege had lasted some ten months Abū Yazīd was compelled to raise it (September 945); the struggle, however, did not end with that event, and for a time the caliph and Abū Yazīd continued to fight with varying fortune, while anarchy prevailed over most of the caliph's dominions. On the 13th of January 946, Abū Yazīd shut up Qā'im's forces in Susa which he began to besiege, and attempted to take by storm.

On the 18th of May 945, while Abū Yazīd was besieging Susa, the caliph al-Qā'im died at Mahdiā, and was succeeded by his son Ismā'īl, who took the title Manṣūr. He almost immediately relieved Susa by sending a fleet, which joining with the garrison inflicted a severe defeat on Abū Yazīd, who had to evacuate Kairawān also; but though the cities were mainly in the hands of Fatimite prefects, Abū Yazīd was able to maintain the field for more than two years longer, while his followers were steadily decreasing in numbers, and he was repeatedly driven into fastnesses of the Sahara. In August 947 his last stronghold was taken, and he died of wounds received in defending it. His sons carried on some desultory warfare against Manṣūr after their father's death. A town called Manṣūra or Ṣābrā was built adjoining Kairawān to celebrate the decisive victory over Abū Yazīd, which, however, did not long preserve its name. The exhausted condition of north-west Africa due to the protracted civil war required some years of peace for recuperation, and further exploits are not recorded for Manṣūr, who died on the 19th of March 952.

His son, Abū Tamīm Ma'add, was twenty-two years of age at the time, and succeeded his father with the title Mo'izz lidīn Allah. His authority was acknowledged over the greater part of the region now constituting Morocco, Algeria and Tunisia, as well as Sicily, and he appears to have had serious thoughts of endeavouring to annex Spain. At an early period in his reign he made Jauhar, who had been secretary under the former caliph, commander of the forces, and the services rendered by this person to the dynasty made him count as its second founder after al-Shī'ī. In the years 958 and 959 he was sent westwards to reduce Fez and other places where the authority of the Fatimite caliph had been repudiated, and after a successful expedition advanced as far as the Atlantic. As early as 966 the plan of

attempting a fresh invasion of Egypt was conceived, and preparations made for its execution; but it was delayed, it is said at the request of the caliph's mother, who wished to make a pilgrimage to Mecca first; and her honourable treatment by Kāfūr when she passed through Egypt induced the caliph to postpone the invasion till that sovereign's death.

In August 972 Mo'izz resolved to follow Jauhar's pressing invitation to enter his new capital Cairo. With his arrival there the centre of the Fatimite power was transferred from Mahdia and Kairawān to Egypt, and their original dominion became a province called al-Maghrib, which immediately fell into the hands of a hereditary dynasty, the Zeirids, acknowledging Fatimite suzerainty. The first sovereign was Bulukkīn, also called Abu'l-Futūh Yūsuf, appointed by Mo'izz as his viceroy on the occasion of his departure for Egypt: separate prefects were appointed for Sicily and Tripoli; and at the first the minister of finance was to be an official independent of the governor of the Maghrib. On the death of Bulukkīn in 984 he was succeeded by a son who took the royal title al-Manṣūr, under whose rule an attempt was made by the Kutāma, instigated by the caliph, to shake off the yoke of the Zeirids, who originated from the Sanhaja tribe. This attempt was defeated by the energy of Manṣūr in 988; and the sovereignty of the Fatimites in the Maghrib became more and more confined to recognition in public prayer and on coins, and the payment of tribute and the giving of presents to the viziers at Cairo. The fourth ruler of the Zeirid dynasty, called Mo'izz, endeavoured to substitute 'Abbāsīd suzerainty for Fatimite: his land was invaded by Arab colonies sent by the Fatimite caliph, with whom in 1051 Mo'izz fought a decisive engagement, after which the dominion of the Zeirids was restricted to the territory adjoining Mahdia; a number of smaller kingdoms rising up around them. The Zeirids were finally overthrown by Roger II. of Sicily in 1148.

After the death of al-Ādid, the last Fatimite caliph in Egypt, some attempts were made to place on the throne a member of the family, and at one time there seemed a chance of the Assassins, who formed a branch of the Fatimite sect, assisting in this project. In 1174 a conspiracy for the restoration of the dynasty was organized by 'Umarah of Yemen, a court poet, with the aid of eight officials of the government: it was discovered and those who were implicated were executed. Two persons claiming Fatimite descent took the royal titles al-Mo'taṣim billah and al-Hāmid lillah in the years 1175 and 1176 respectively; and as late as 1192 we hear of pretenders in Egypt. Some members of the family are traceable till near the end of the 7th century of Islam.

The doctrines of the Fatimites as a sect, apart from their claim to the sovereignty in Islam, are little known, and we are not justified in identifying them with those of the Assassins, the Carmathians or the Druses, though all these sects are connected with them in origin. A famous account is given by Maqriẓī of a system of education by which the neophyte had doubts gently instilled into his mind till he was prepared to have the allegorical meaning of the Koran set before him, and to substitute some form of natural for revealed religion. In most accounts of the early days of the community it is stated that the permission of wine-drinking and licentiousness, and the community of wives and property formed part of its tenets. There is little in the recorded practice of the Fatimite state to confirm or justify these assertions; and they appear to have differed from orthodox Moslems rather in small details of ritual and law than in deep matters of doctrine.

AUTHORITIES.—F. Wüstenfeld, *Geschichte der Fatimiden Chalifen* (Göttingen, 1881); E. Mercier, *Histoire de l'Afrique Septentrionale* (Paris, 1888); M. J. de Goeje, *Mémoire sur les Carmathes de Bahraïn et les Fatimides* (2nd ed., Leiden, 1886); P. Casanova, "Mémoire sur les derniers Fatimides," *Mém. Miss. archéologique au Caire*, vol. vi.; for the lives of 'Obaidallah and Abū Yazīd, Cherbonneau in the *Journal Asiatique*, sér. iv. vol. 20, and sér. v. vol. 5. See also *EGYPT: History*, sect. Mahomedan. (D. S. M.)*

FAUBOURG, the French name for a portion of a town which lies outside the walls, hence properly a suburb. The name survives in certain parts of Paris, such as the Faubourg St

Antoine, and the Faubourg St Germain, &c., which have long since ceased to be suburbs and have become portions of the town itself. The origin of the word is doubtful. The earlier spelling *faux-bourg*, and the occurrence in medieval Latin of *falsus-burgus* (see Ducange, *Glossarium*, s.v. "Falsus-Burgus"), was taken as showing its obvious origin and meaning, the sham or quasi-borough. The generally accepted derivation is from *fors*, outside (Lat. *foris*, outside the gates), and *bourg*. It is suggested that the word is the French adaptation of the Ger. *Pfahlbürger*, the burghers of the pale, *i.e.* outside the walls but within the pale.

FAUCES (a Latin plural word for "throat"; the singular *faux* is rarely found), in anatomy, the hinder part of the mouth, which leads into the pharynx; also an architectural term given by Vitruvius to narrow passages on either side of the tablinum, through which access could be obtained from the atrium to the peristylar court in the rear.

FAUCHER, LÉONARD JOSEPH [LÉON] (1803–1854), French politician and economist, was born at Limoges on the 8th of September 1803. When he was nine years old the family removed to Toulouse, where the boy was sent to school. His parents were separated in 1816, and Léon Faucher, who resisted his father's attempts to put him to a trade, helped to support himself and his mother during the rest of his school career by designing embroidery and needlework. As a private tutor in Paris he continued his studies in the direction of archaeology and history, but with the revolution of 1830 he was drawn into active political journalism on the Liberal side. He was on the staff of the *Temps* from 1830 to 1833, when he became editor of the *Constitutionnel* for a short time. A Sunday journal of his own, *Le Bien public*, proved a disastrous financial failure; and his political independence having caused his retirement from the *Constitutionnel*, he joined in 1834 the *Courrier français*, of which he was editor from 1839 until 1842, when the paper changed hands. Faucher belonged in policy to the dynastic Left, and consistently preached moderation to the more ardent Liberals. On resigning his connexion with the *Courrier français* he gave his attention chiefly to economic questions. He advocated a customs union between the Latin countries to counter-balance the German Zollverein, and in view of the impracticability of such a measure narrowed his proposal in 1842 to a customs union between France and Belgium. In 1843 he visited England to study the English social system, publishing the results of his investigations in a famous series of *Études sur l'Angleterre* (2 vols., 1845), published originally in the *Revue des deux mondes*. He helped to organize the Bordeaux association for free-trade propaganda, and it was as an advocate of free trade that he was elected in 1847 to the chamber of deputies for Reims. After the revolution of 1848 he entered the Constituent Assembly for the department of Marne, where he opposed many Republican measures—the limitation of the hours of labour, the creation of the national relief works in Paris, the abolition of the death penalty and others. Under the presidency of Louis Napoleon he became minister of public works, and then minister of the interior, but his action in seeking to influence the coming elections by a circular letter addressed to the prefects was censured by the Constituent Assembly, and he was compelled to resign office on the 14th of May 1849. In 1851 he was again minister of the interior until Napoleon declared his intention of resorting to universal suffrage. After the *coup d'état* of December he refused a seat in the consultative commission instituted by Napoleon. He had been elected a member of the Academy of Moral and Political Science in 1849, and his retirement from politics permitted a return to his writings on economics. He had been to Italy in search of health in 1854, and was returning to Paris on business when he was seized by typhoid at Marseilles, where he died on the 14th of December 1854.

His miscellaneous writings were collected (2 vols., 1856) as *Mélanges d'économie politique et de finance*, and his speeches in the legislature are printed in vol. ii. of *Léon Faucher, biographie et correspondance* (2 vols., 2nd ed., Paris, 1875).

FAUCHET, CLAUDE (1530–1601), French historian and antiquary, was born at Paris on the 3rd of July 1530. Of his early life few particulars are known. He applied himself to the study of the early French chroniclers, and proposed to publish extracts which would throw light on the first periods of the monarchy. During the civil wars he lost a large part of his books and manuscripts in a riot, and was compelled to leave Paris. He then settled at Marseilles. Attaching himself afterwards to Cardinal de Tournon, he accompanied him in 1554 to Italy, whence he was several times sent on embassies to the king, with reports on the siege of Siena. His services at length procured him the post of president of the chambre des monnaies, and thus enabled him to resume his literary studies. Having become embarrassed with debt, he found it necessary, at the age of seventy, to sell his office; but the king, amused with an epigram, gave him a pension, with the title of historiographer of France. Fauchet has the reputation of an impartial and scrupulously accurate writer; and in his works are to be found important facts not easily accessible elsewhere. He was, however, entirely uncritical, and his style is singularly inelegant. His principal works (1579, 1599) treat of Gaulish and French antiquities, of the dignities and magistrates of France, of the origin of the French language and poetry, of the liberties of the Gallican church, &c. A collected edition was published in 1610. Fauchet took part in a translation of the *Annals* of Tacitus (1582). He died at Paris about the close of 1601.

FAUCHET, CLAUDE (1744–1793), French revolutionary bishop, was born at Dornes (Nièvre) on the 22nd of September 1744. He was a curate of the church of St Roch, Paris, when he was engaged as tutor to the children of the marquis of Choiseul, brother of Louis XV.'s minister, an appointment which proved to be the first step to fortune. He was successively grand vicar to the archbishop of Bourges, preacher to the king, and abbot of Montfort-Lacarre. The "philosophic" tone of his sermons caused his dismissal from court in 1788 before he became a popular speaker in the Parisian sections. He was one of the leaders of the attack on the Bastille, and on the 5th of August 1789 he delivered an eloquent discourse by way of funeral sermon for the citizens slain on the 14th of July, taking as his text the words of St Paul, "Ye have been called to liberty." He blessed the tricolour flag for the National Guard, and in September was elected to the Commune, from which he retired in October 1790. During the next winter he organized within the Palais Royal the "Social Club of the Society of the Friends of Truth," presiding over crowded meetings under the self-assumed title of *procureur général de la vérité*. Nevertheless, events were marching faster than his opinions, and the last occasion on which he carried his public with him was in a sermon preached at Notre Dame on the 14th of February 1791. In May he became constitutional bishop of Calvados, and was presently returned by the department to the Legislative Assembly, and afterwards to the Convention. At the king's trial he voted for the appeal to the people and for the penalty of imprisonment. He protested against the execution of Louis XVI. in the *Journal des amis* (January 26, 1793), and next month was denounced to the Convention for prohibiting married priests from the exercise of the priesthood in his diocese. He remained secretary to the Convention until the accusation of the Girondists in May 1793. In July he was imprisoned on the charge of supporting the federalist movement at Caen, and of complicity with Charlotte Corday, whom he had taken to see a sitting of the Convention on her arrival in Paris. Of the second of these charges he was certainly innocent. With the Girondist deputies he was brought before the revolutionary tribunal on the 30th of October, and was guillotined on the following day.

See *Mémoires . . . ou Lettres de Claude Fauchet* (5th ed., 1793); *Notes sur Claude Fauchet* (Caen, 1842).

FAUCIT, HELENA SAVILLE (1817–1898), English actress, the daughter of John Saville Faucit, an actor, was born in London. Her first London appearance was made on the 5th of January 1836 at Covent Garden as Julia in *The Hunchback*. Her success

in this was so definitely confirmed by her subsequent acting of Juliet, Lady Teazle, Beatrice, Imogen and Hermione, that within eighteen months she was engaged by Macready as leading lady at Covent Garden. There, besides appearing in several Shakespearian characters, she created the heroine's part in Lytton's *Duchess de la Vallière* (1836), *Lady of Lyons* (1838), *Richelieu* (1839), *The Sea Captain* (1839), *Money* (1840), and Browning's *Strafford* (1837). After a visit to Paris and a short season at the Haymarket, she joined the Drury Lane company under Macready early in 1842. There she played Lady Macbeth, Constance in *King John*, Desdemona and Imogen, and took part in the first production of Westland Marston's *Patrician's Daughter* (1842) and Browning's *Blot on the Scutcheon* (1843). Among her successful tours was included a visit to Paris in 1844–1845, where she acted with Macready in several Shakespearian plays. In 1851 she was married to Mr (afterwards Sir) Theodore Martin, but still acted occasionally for charity. One of her last appearances was as Beatrice, on the opening of the Shakespeare Memorial at Stratford-on-Avon on the 23rd of April 1879. In 1881 there appeared in *Blackwood's Magazine* the first of her *Letters on some of Shakespeare's Heroines*, which were published in book form as *On Some of Shakespeare's Female Characters* (1885). Lady Martin died at her home near Llangollen in Wales on the 31st of October 1898. There is a tablet to her in the Shakespeare Memorial with a portrait figure, and the marble pulpit in the Shakespeare church—with her portrait as Saint Helena—was given in her memory by her husband.

See Sir Theodore Martin's *Helena Faucit* (1900).

FAUJAS DE SAINT-FOND, BARTHÉLEMY (1741–1819), French geologist and traveller, was born at Montélimart on the 17th of May 1741. He was educated at the Jesuits' College at Lyons; afterwards he went to Grenoble, applied himself to the study of law, and was admitted advocate to the parliament. He rose to be president of the seneschal's court (1765), a post which he honourably filled, but the duties of which became irksome, as he had early developed a love of nature and his favourite relaxation was found in visits to the Alps. There he began to study the forms, structure, composition and superposition of rocks. In 1775 he discovered in the Velay a rich deposit of pozzuolana, which in due course was worked by the government. In 1776 he put himself in communication with Buffon, who was not slow to perceive the value of his labours. Invited by Buffon to Paris, he quitted the law, and was appointed by Louis XVI. assistant naturalist to the museum, to which office was added some years later (1785, 1788) that of royal commissioner for mines. One of the most important of his works was the *Recherches sur les volcans éteints du Vivarais et du Velay*, which appeared in 1778. In this work, rich in facts and observations, he developed his theory of the origin of volcanoes. In his capacity of commissioner for mines Faujas travelled in almost all the countries of Europe, everywhere devoting attention to the nature and constituents of the rocks. It was he who first recognized the volcanic nature of the basaltic columns of the cave of Fingal (Staffa), although the island was visited in 1772 by Sir Joseph Banks, who remarked that the stone "is a coarse kind of *Basalt*, very much resembling the Giants' Causeway in Ireland" (Pennant's *Tour in Scotland and Voyage to the Hebrides*). Faujas's *Voyage en Angleterre, en Écosse et aux Îles Hébrides* (1797) is full of interest—containing anecdotes of Sir Joseph Banks and Dr John Whitehurst, and an amusing account of "The Dinner of an Academic Club" (the Royal Society), and has been translated into English (2 vols., 1799). Having been nominated in 1793 professor at the Jardin des Plantes, he held this post till he was nearly eighty years of age, retiring in 1818 to his estate of Saint-Fond in Dauphiné. Faujas took a warm interest in the balloon experiments of the brothers Montgolfier, and published a very complete *Description des expériences de la machine aérostatique de MM. Montgolfier, &c.* (1783, 1784). He contributed many scientific memoirs to the *Annales* and the *Mémoires* of the museum of natural history. Among his separate works, in addition to those already named are—*Histoire naturelle de la province de Dauphiné* (1781, 1782); *Minéralogie des volcans*

(1784); and *Essai de géologie* (1803-1809). Faujas died on the 18th of July 1819.

FAULT (Mid. Eng. *faute*, through the French, from the popular Latin use of *fallere*, to fail; the original of the Latin being replaced in English in the 15th century), a failing, mistake or defect.

In geology, the term is given to a plane of dislocation in a portion of the earth's crust; synonyms used in mining are "trouble," "throw" and "heave"; the German equivalent is *Verwerfung*, and the French *faille*. Faults on a small scale are

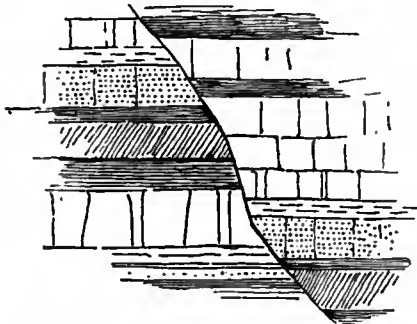

FIG. 1.—Section of clean-cut fault.

sometimes sharply-defined planes,¹ as if the rocks had been sliced through and fitted together again after being shifted (fig. 1). In such cases, however, the harder portions of the dislocated rocks will usually be found "slickensided." More frequently some disturbance has occurred on one or both sides

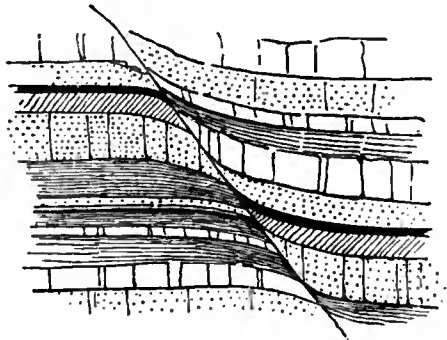

FIG. 2.—Section of strata, bent at a line of fault.

of the fault. Sometimes in a series of strata the beds on the side which has been pushed up are bent down against the fault, while those on the opposite side are bent up (fig. 2). Most commonly the rocks on both sides are considerably broken, jumbled and crumpled, so that the line of fracture is marked by a belt or wall-like mass of fragmentary rock, *fault-rock*, which may be several yards in breadth. Faults are to be distinguished from joints and fissures by the fact that there must have been a movement of the rock on one side of the fault-plane relatively to that on the other side. The trace of a fault-plane at the surface of the earth is a line (or belt of fault-rock), which in geological mapping is often spoken of as a "fault-line" or "line of fault." Fig. 3



FIG. 3.—Plan of simple fault.

represents the plan of a simple fault; quite frequently, however, the main fault subdivides at the extremities into a number of minor faults (fig. 4), or the main fault may be accompanied by

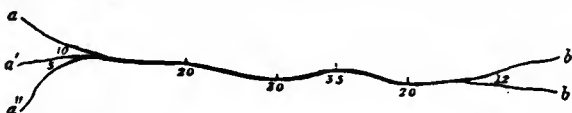

FIG. 4.—Plan of a fault splitting into minor faults.

lateral subordinate faults (fig. 5), some varieties of which have been termed *flaws* or *Blatts*.

"Fault-planes" are sometimes perpendicular to the horizon, but more usually they are inclined at a greater or lesser angle. The angle made by the fault-plane with the vertical is the *hade* of the

¹ The *fault-plane* is not a plane surface in the mathematical sense; it may curve irregularly in more than one direction.

fault (if the angle of inclination were measured from the horizon, as in determining the "dip" of strata, this would be expressed as the "dip of the fault"). In figs. 1 and 2 the faults are hading



FIG. 5.—Plan of main fault, with branches.

towards the right of the reader. The amount of dislocation as measured along a fault-plane is the *displacement* of the fault (for an illustration of these terms see fig. 18, where they are applied to a thrust fault); the vertical displacement is the *throw* (Fr. *rejet*); the horizontal displacement, which even with vertical movement must arise in all cases where the faults are not perpendicular to the horizon and the strata are not horizontal, is known as the *heave*. In fig. 6 the displacement is equal to the throw in the fault A; in the fault B the displacement is more than

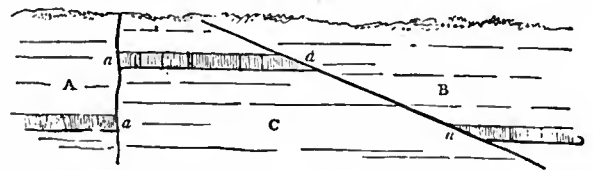

FIG. 6.—Section of a vertical and inclined fault.

twice as great as in A, while the throw is the same in both; the fault A has no heave, in B it is considerable. The rock on that side of a fault which has dropped relatively to the rock on the other is said to be upon the downthrow side of the fault; conversely, the relatively uplifted portion is the upthrow side. The two fault faces are known as the "hanging-wall" and the "foot-wall."

The relationship that exists between the hade and the direction of throw has led to the classification of faults into "normal faults," which hade under the downthrow side, or in other words, those in which the hanging-wall has dropped; and "reversed faults," which hade beneath the upthrow side, that is to say, the foot-wall exhibits a relative sinking. Normal faults are exemplified in figs. 1, 2, and 6; in the latter the masses A and B are on the downthrow sides, C is upthrown. Fig. 7 represents a small reversed fault. Normal faults are

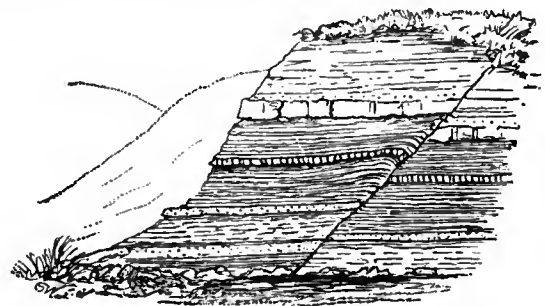

FIG. 7.—Reversed fault, Liddesdale.

so called because they are more generally prevalent than the other type; they are sometimes designated "drop" or "gravity" faults, but these are misleading expressions and should be discontinued. Normal faults are regarded as the result of stretching of the crust, hence they have been called "tension" faults as distinguished from reversed faults, which are assumed to be due to pressure. It is needful, however, to exercise great caution in accepting this view except in a restricted and localized sense, for there are many instances in which the two forms are intimately associated (see fig. 8), and a whole complex system of faults may be the result of horizontal (tangential) pressure alone or even of direct vertical uplift. It is often tacitly assumed

that most normal and reversed faults are due to simple vertical movements of the fractured crust-blocks; but this is by no means the case. What is actually observed in examining a fault is the *apparent* direction of motion; but the present position of the dislocated masses is the result of *real* motion or series of

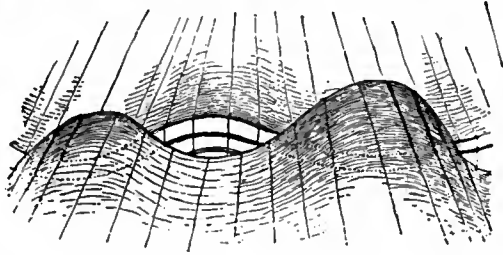

FIG. 8.—Diagram of gently undulating strata cut by a fault, with alternate throw in opposite directions.

motions, which have taken place along the fault-plane at various angles from horizontal to vertical; frequently it can be shown that these movements have been extremely complicated. The striations and "slickensides" on the faces of a fault indicate only the direction of the last movement.

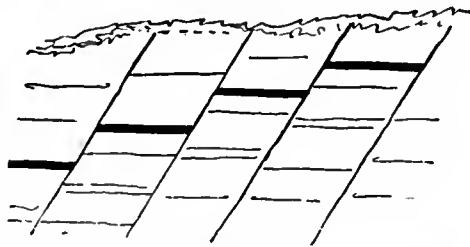

FIG. 9.—Section of strata cut by step faults.

A broad monoclinical fold is sometimes observed to pass into a fault of gradually increasing throw; such a fault is occasionally regarded as pivoted at one end. Again, a faulted mass may be on the downthrow side towards one end, and on the upthrow side towards the other, the movement having taken place about

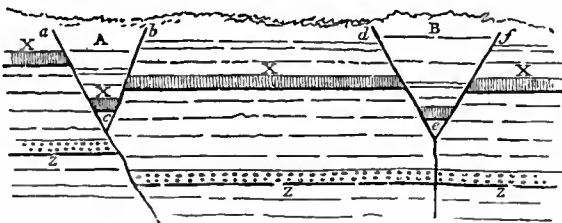

FIG. 10.—Trough faults.

an axis approximately normal to the fault-plane, the "pivot" in this case being near the centre. From an example of this kind it is evident that the same fault may at the same time be both "normal" and "reversed" (see fig. 8). When the principal movement along a highly inclined fault-plane has been approxi-

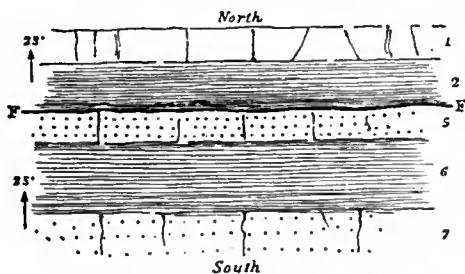
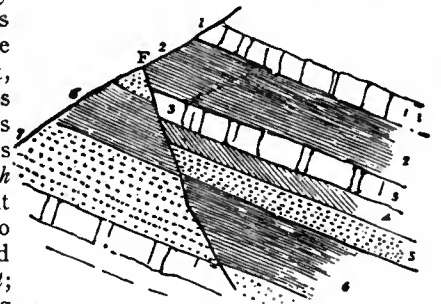

FIG. 11.—Plan of a strike fault.

mately horizontal, the fault has been variously styled a *lateral-shift*, *transcurrent fault*, *transverse thrust* or a *heave fault*. The horizontal component in faulting movements is more common than is often supposed.

A single normal fault of large throw is sometimes replaced by a series of close parallel faults, each throwing a small amount in the same direction; if these subordinate faults occur within a narrow width of ground they are known as *distribution faults*; if they are more widely separated they are called *step faults* (fig. 9). Occasionally two normal faults hade towards one another and intersect, and the rock mass between them has been let down; this is described as a *trough fault* (fig. 10). A fault running parallel to the strike of bedded rocks is a *strike fault*; one which runs along the direction of the



dip is a *dip fault*; a so-called *diagonal fault* takes a direction intermediate between these two directions. Although the effects of these types of fault upon the outcrops of strata differ, there are no intrinsic differences between the faults themselves.

The effect of normal faults upon the outcrop may be thus briefly summarized:—a strike fault that hade with the direction of the dip may cause beds to be cut out at the surface on the

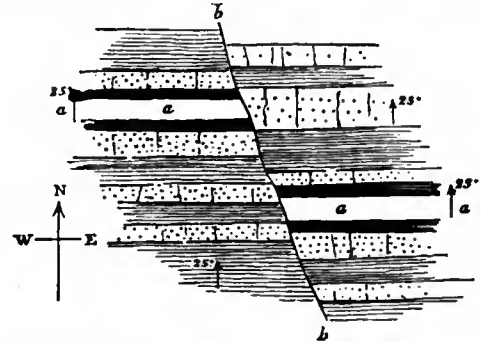

FIG. 13.—Plan of strata cut by a dip fault.

upthrow side; if it hade against the dip direction it may repeat some of the beds on the upthrow side (figs. 11 and 12). With dip faults the crop is carried forward (down the dip) on the upthrow side. The perpendicular distance between the crop of the bed (dike or vein) on opposite sides of the fault is the "offset." The offset decreases with increasing angle of dip and increases with increase in the throw of the fault (fig. 13).

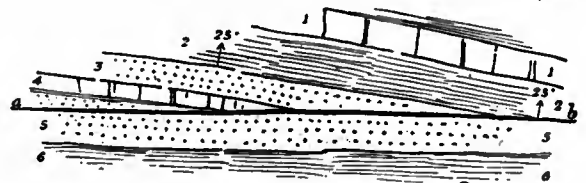

FIG. 14.—Plan of strata traversed by a diminishing strike fault.

Faults which run obliquely across the direction of dip, if they hade with the dip of the strata, will produce offset with "gap" between the outcrops; if they hade in the opposite direction to the dip, offset with "overlap" is caused: in the latter case the crop moves forward (down dip) on the denuded upthrow side, in the former it moves backward. The effect of a strike fault of diminishing throw is seen in fig. 14. Faults crossing folded strata cause the outcrops to approach on the upthrow side of a syncline and tend to separate the outcrops of an anticline (figs. 15, 16, 17).

In the majority of cases the upthrown side of a fault has been so reduced by denudation as to leave no sharp upstanding ridge; but examples are known where the upthrown side still

exists as a prominent cliff-like face of rock, a "fault-scarp"; familiar instances occur in the Basin ranges of Utah, Nevada, &c., and many smaller examples have been observed in the areas affected by recent earthquakes in Japan, San Francisco and other places. But although there may be no sharp cliff, the effect of faulting upon topographic forms is abundantly evident

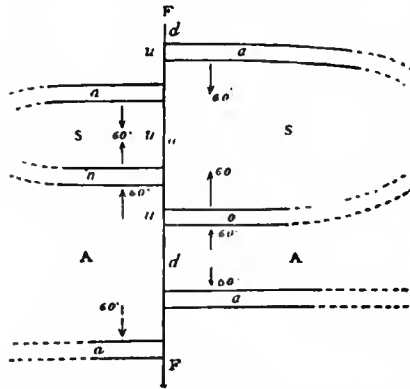

FIG. 15.—Plan of an anticline (A) and syncline (S), dislocated by a fault.

wherever a harder series of strata has been brought in juxtaposition to softer rocks. By certain French writers, the upstanding side of a faulted piece of ground is said to have a *regard*, thus the faults of the Jura Mountains have a "*regard français*," and in the same region it has been observed that in curved faults the convexity is directed the same way as the *regard*. Occasionally one or more parallel faults have let down an intervening strip of rock, thereby forming "fault valleys" or *Graben* (*Grabensenken*); the Great Rift Valley is a striking example. On the other hand, a large area of rock is sometimes lifted up, or surrounded by a system of faults, which have let down the encircling ground; such a fault-block is known also as a *horst*; a considerable area of Greenland stands up in this manner.

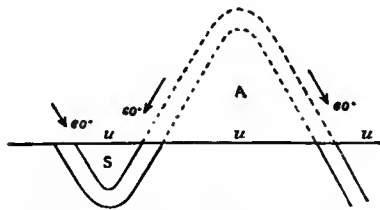

FIG. 16.—Section along the upcast side of the fault in fig. 15.

Faults have often an important influence upon water-supply by bringing impervious beds up against pervious ones or vice versa, thus forming underground dams or reservoirs, or allowing water to flow away that would otherwise be conserved. Springs often rise along the outcrop of a fault. In coal and metal

mining it is evident from what has already been said that faults must act sometimes beneficially, sometimes the reverse. It is a common occurrence for fault-fissures and fault-rock to appear as valuable mineral lodes through the infilling or impregnation of the spaces and broken ground with mineral ores.

In certain regions which have been subjected to very great crustal disturbance a type of fault is found which possesses a very low hade—sometimes only a few degrees from the horizontal—and, like a reversed fault, has beneath the upthrown mass; these are termed *thrusts*, *overthrusts*, or *overthrust faults* (Fr. *recouvrements*, *failles de chevauchement*, *charriages*; Ger. *Überschiebungen*, *Übersprünge*, *Wechsel*, *Fallenverwerfungen*). Thrusts should not be confused with reversed faults, which have a strong hade. Thrusts play a very important

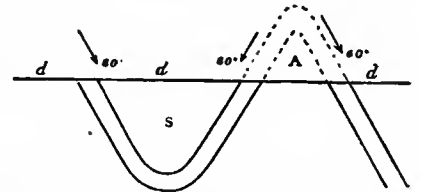

FIG. 17.—Section along the downcast side of same fault.

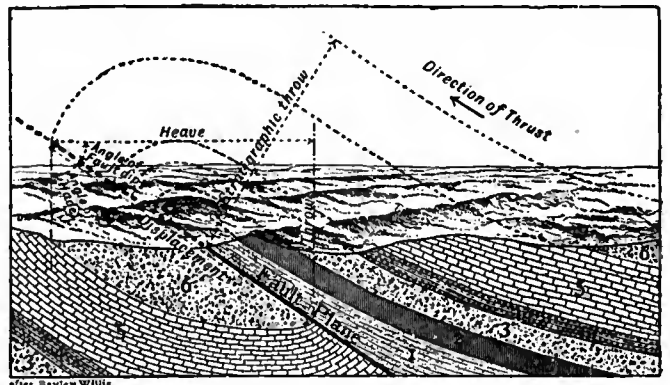

FIG. 18.—Diagram to illustrate the terminology of faults and thrusts.

part in the N.W. highlands of Scotland, the Scandinavian highlands, the western Alps, the Appalachians, the Belgian coal region, &c. By the action of thrusts enormous masses of rock have been pushed almost horizontally over underlying rocks, in some cases for several miles. One of the largest of the Scandinavian thrust

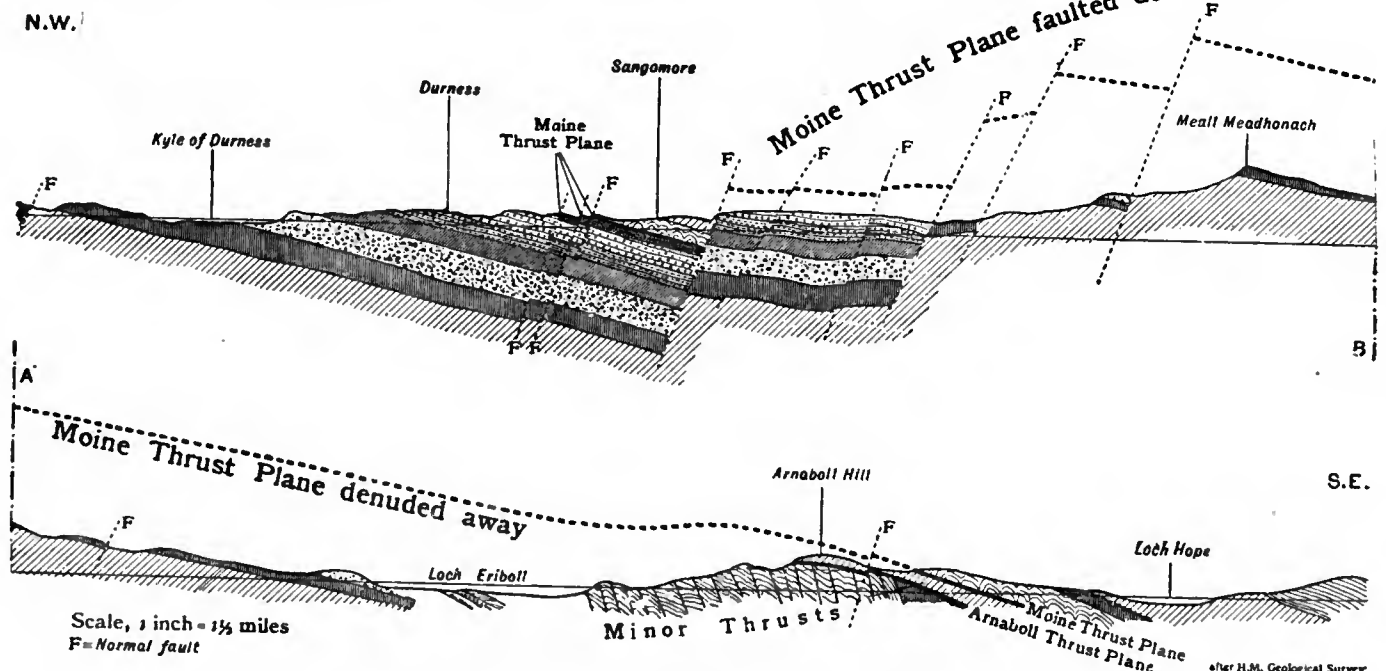

FIG. 19.—Section of a very large thrust in the Durness Eriboll district, Scotland.

masses is 1120 m. long, 80 m. broad, and 5000 ft. thick. In Scotland three grades of thrusts are recognized, maximum, major, and minor thrusts; the last have very generally been truncated by those of greater magnitude. Some of these great thrusts have received distinguishing names, e.g. the Moine thrust (fig. 19) and the Ben More thrust; similarly in the coal basin of Mons and Valenciennes we find the *faille de Boussu* and the *Grande faille du midi*. Overturned folds are frequently seen passing into thrusts. Bayley Willis has classified thrusts as (1) Shear thrusts, (2) Break thrusts, (3) Stretch thrusts, and (4) Erosion thrusts.

Dr J. E. Marr ("Notes on the Geology of the English Lake District," *Proc. Geol. Assoc.*, 1900) has described a type of fault which may be regarded as the converse of a thrust fault. If we consider a series of rock masses A, B, C—of which A is the oldest and undermost—undergoing thrusting, say from south to north, should the mass C be prevented from moving forward as rapidly as B, a low-hanging fault may form between C and B and the mass C may lag behind; similarly the mass B may lag behind A. Such faults Dr Marr calls "lag faults." A mass of rock suffering thrusting or lagging may yield unequally in its several parts, and those portions tending to travel more rapidly than the adjoining masses in the same sheet may be cut off by fractures. Thus the faster-moving blocks will be separated from the slower ones by faults approximately normal to the plane of movement: these are described as "tear faults."

Faults may occur in rocks of all ages; small local dislocations are observable even in glacial deposits, alluvium and loess. A region of faulting may continue to be so through more than one geological period. Little is known of the mechanism of faulting or of the causes that produce it; the majority of the text-book explanations will not bear scrutiny, and there is room for extended observation and research. The sudden yielding of the strata along a plane of faulting is a familiar cause of earthquakes.

See E. de Margerie and A. Heim, *Les Dislocations de l'écorce terrestre* (Zürich, 1888); A. Rothpletz, *Geotektonische Probleme* (Stuttgart, 1894); B. Willis, "The Mechanics of Appalachian Structure," *13th Ann. Rep. U.S. Geol. Survey* (1891-1892, pub. 1893). A prolonged discussion of the subject is given in *Economic Geology*, Lancaster, Pa., U.S.A., vols. i. and ii. (1906, 1907). (A. GE.; J. A. H.)

FAUNA, the name, in Roman mythology, of a country goddess of the fields and cattle, known sometimes as the sister, sometimes as the wife of the god Faunus; hence the term is used collectively for all the animals in any given geographical area or geological period, or for an enumeration of the same. It thus corresponds to the term "flora" in respect to plant life.

FAUNTLEROY, HENRY (1785-1824), English banker and forger, was born in 1785. After seven years as a clerk in the London bank of Marsh, Sibbald & Co., of which his father was one of the founders, he was taken into partnership, and the whole business of the firm was left in his hands. In 1824 the bank suspended payment. Fauntleroy was arrested on the charge of appropriating trust funds by forging the trustees' signatures, and was committed for trial, it being freely rumoured that he had appropriated £250,000, which he had squandered in debauchery. He was tried at the Old Bailey, and, the case against him having been proved, he admitted his guilt, but pleaded that he had used the misappropriated funds to pay his firm's debts. He was found guilty and sentenced to be hanged. Seventeen merchants and bankers gave evidence as to his general integrity at the trial, and after his conviction powerful influence was brought to bear on his behalf, and his case was twice argued before judges on points of law. An Italian named Angelini even offered to take Fauntleroy's place on the scaffold. The efforts of his many friends were, however, unavailing, and he was executed on the 30th of November 1824. A wholly unfounded rumour was widely credited for some time subsequently to the effect that he had escaped strangulation by inserting a silver tube in his throat, and was living comfortably abroad.

See A. Griffith's *Chronicles of Newgate*, ii. 294-300, and Pierce Egan's *Account of the Trial of Mr Fauntleroy*.

FAUNUS (i.e. the "kindly," from Lat. *favere*, or the "speaker," from *fari*), an old Italian rural deity, the bestower of fruitfulness on fields and cattle. As such he is akin to or identical with Inuus ("fructifier") and Lupercus (see LUPERCALIA). Faunus also revealed the secrets of the future by strange sounds from the woods, or by visions communicated to those who slept within his precincts in the skin of sacrificed lambs; he was then called Fatuus, and with him was associated his wife or daughter Fatua. Under Greek influence he was identified with Pan, and just as there was supposed to be a number of Panisci, so the existence of many Fauni was assumed—misshapen and mischievous goblins of the forest, with pointed ears, tails and goat's feet, who loved to torment sleepers with hideous nightmares. In poetical tradition Faunus is an old king of Latium, the son of Picus (Mars) and father of Latinus, the teacher of agriculture and cattle-breeding, and the introducer of the religious system of the country, honoured after death as a tutelary divinity. Two festivals called Faunalia were celebrated in honour of Faunus, one on the 13th of February in his temple on the island in the Tiber, the other in the country on the 5th of December (Ovid, *Fasti*, ii. 193; Horace, *Odes*, iii. 18. 10). At these goats were sacrificed to him with libations of wine and milk, and he was implored to be propitious to fields and flocks. The peasants and slaves at the same time amused themselves with dancing in the meadows.

FAURE, FRANÇOIS FÉLIX (1841-1899), President of the French Republic, was born in Paris on the 30th of January 1841, being the son of a small furniture maker. Having started as a tanner and merchant at Havre, he acquired considerable wealth, was elected to the National Assembly on the 21st of August 1881, and took his seat as a member of the Left, interesting himself chiefly in matters concerning economics, railways and the navy. In November 1882 he became under-secretary for the colonies in M. Ferry's ministry, and retained the post till 1885. He held the same post in M. Tirard's ministry in 1888, and in 1893 was made vice-president of the chamber. In 1894 he obtained cabinet rank as minister of marine in the administration of M. Dupuy. In the January following he was unexpectedly elected president of the Republic upon the resignation of M. Casimir-Périer. The principal cause of his elevation was the determination of the various sections of the moderate republican party to exclude M. Brisson, who had had a majority of votes on the first ballot, but had failed to obtain an absolute majority. To accomplish this end it was necessary to unite among themselves, and union could only be secured by the nomination of some one who offended nobody. M. Faure answered perfectly to this description. His fine presence and his tact on ceremonial occasions rendered the state some service when in 1896 he received the Tsar of Russia at Paris, and in 1897 returned his visit, after which meeting the momentous Franco-Russian alliance was publicly announced. The latter days of M. Faure's presidency were embittered by the Dreyfus affair, which he was determined to regard as *chose jugée*. But at a critical moment in the proceedings his death occurred suddenly, from apoplexy, on the 16th of February 1899. With all his faults, and in spite of no slight amount of personal vanity, President Faure was a shrewd political observer and a good man of business. After his death, some alleged extracts from his private journals, dealing with French policy, were published in the Paris press.

See E. Maillard, *Le Président F. Faure* (Paris, 1897); P. Blyuysen, *Félix Faure intime* (1898); and F. Martin-Ginouvier, *F. Faure devant l'histoire* (1895).

FAURÉ, GABRIEL (1845-), French musical composer, was born at Pamiers on the 13th of May 1845. He studied at the school of sacred music directed by Niedermeyer, first under Dietsch, and subsequently under Saint-Saëns. He became "maître de chapelle" at the church of the Madeleine in 1877, and organist in 1896. His works include a symphony in D minor (Op. 40), two quartets for piano and strings (Opp. 15 and 45), a suite for orchestra (Op. 12), sonata for violin and piano (Op. 13), concerto for violin (Op. 14), berceuse for violin, élégie for violoncello, pavane for orchestra, incidental music for Alexandre Dumas' *Caligula* and De Haraucourt's *Shylock*,

a requiem, a cantata, *The Birth of Venus*, produced at the Leeds festival in 1898, a quantity of piano music, and a large number of songs. Fauré occupies a place by himself among modern French composers. He delights in the *imprévu*, and loves to wander through labyrinthine harmonies. There can be no denying the intense fascination and remarkable originality of his music. His muse is essentially aristocratic, and suggests the surroundings of the boudoir and the perfume of the hot-house.

FAURIEL, CLAUDE CHARLES (1772–1844), French historian, philologist and critic, was born at St Étienne on the 21st of October 1772. Though the son of a poor joiner, he received a good education in the Oratorian colleges of Tournon and Lyons. He was twice in the army—at Perpignan in 1793, and in 1796–1797 at Briçon, as private secretary to General J. Servan de Gerbey (1741–1808); but he preferred the civil service and the companionship of his friends and his books. In 1794 he returned to St Étienne, where, but only for a short period, he filled a municipal office; and from 1797 to 1799 he devoted himself to strenuous study, more especially of the literature and history, both ancient and modern, of Greece and Italy. Having paid a visit to Paris in 1799, he was introduced to Fouché, minister of police, who induced him to become his private secretary. Though he discharged the duties of this office to Fouché's satisfaction, his strength was overtaken by his continued application to study, and he found it necessary in 1801 to recruit his health by a three months' trip in the south. In resigning his office in the following year he was actuated as much by these considerations as by the scruples he put forward in serving longer under Napoleon, when the latter, in violation of strict republican principles, became consul for life. This is clearly shown by the fragments of Memoirs discovered by Ludovic Lalanne and published in 1886.

Some articles which Fauriel published in the *Décade philosophique* (1800) on a work of Madame de Staël's—*De la littérature considérée dans ses rapports avec les institutions sociales*—led to an intimate friendship with her. About 1802 he contracted with Madame de Condorcet a liaison which lasted till her death (1822). It was said of him at the time that he gave up all his energies to love, friendship and learning. The salon of Mme de Condorcet was throughout the Consulate and the first Empire a rallying point for the dissentient republicans. Fauriel was introduced by Madame de Staël to the literary circle of Auteuil, which gathered round Destutt de Tracy. Those who enjoyed his closest intimacy were the physiologist Cabanis (Madame de Condorcet's brother-in-law), the poet Manzoni, the publicist Benjamin Constant, and Guizot. Later Tracy introduced to him Aug. Thierry (1821) and perhaps Thiers and Mignet. During his connexion with Auteuil, Fauriel's attention was naturally turned to philosophy, and for some years he was engaged on a history of Stoicism, which was never completed, all the papers connected with it having accidentally perished in 1814. He also studied Arabic, Sanskrit and the old South French dialects. He published in 1810 a translation of the *Parthenais* of the Danish poet Baggesen, with a preface on the various kinds of poetry; in 1823 translations of two tragedies of Manzoni, with a preface "*Sur la théorie de l'art dramatique*"; and in 1824–1825 his translation of the popular songs of modern Greece, with a "*Discours préliminaire*" on popular poetry.

The Revolution of July, which put his friends in power, opened to him the career of higher education. In 1830 he became professor of foreign literature at the Sorbonne. The *Histoire de la Gaule méridionale sous la domination des conquérants germains* (4 vols., 1836) was the only completed section of a general history of southern Gaul which he had projected. In 1836 he was elected a member of the Academy of Inscriptions, and in 1837 he published (with an introduction the conclusions of which would not now all be endorsed) a translation of a Provençal poem on the Albigenian war. He died on the 15th of July 1844. After his death his friend Mary Clarke (afterwards Madame J. Möhl) published his *Histoire de la littérature provençale* (3 vols., 1846)—his lectures for 1831–1832. Fauriel was biased in this work by

his preconceived and somewhat fanciful theory that Provence was the cradle of the *chansons de geste* and even of the Round Table romances; but he gave a great stimulus to the scientific study of Old French and Provençal. *Dante et les origines de la langue et de la littérature italiennes* (2 vols.) was published in 1854.

Fauriel's *Mémoires*, found with Condorcet's papers, are in the Institute library. They were written at latest in 1804, and include some interesting fragments on the close of the consulate, Moreau, &c. Though anonymous, Lalanne, who published them (*Les Derniers Jours du Consulat*, 1886), proved them to be in the same handwriting as a letter of Fauriel's in 1803. The same library has Fauriel's correspondence, catalogued by Ad. Régnier (1900). Benjamin Constant's letters (1802–1823) were published by Victor Glachant in 1906. For Fauriel's correspondence with Guizot see *Nouvelle Rev.* (Dec. 1, 1901, by V. Glachant), and for his love-letters to Miss Clarke (1822–1844) the *Revue des deux mondes* (1908–1909) by E. Rod.) See further Sainte-Beuve, *Portraits contemporains*, ii.; Antoine Guillois, *Le Salon de Mme Helvétius* (1894) and *La Marquise de Condorcet* (1897); O'Meara, *Un Salon à Paris: Mme Möhl* (undated); and J. B. Galley, *Claude Fauriel* (1909).

FAUST, or **FAUSTUS**, the name of a magician and charlatan of the 16th century, famous in legend and in literature. The historical Faust forms little more than the nucleus round which a great mass of legendary and imaginative material gradually accumulated. That such a person existed there is, however, sufficient proof.¹ He is first mentioned in a letter, dated August 20, 1507, of the learned Benedictine Johann Trithemius or Trithemius (1462–1516), abbot of Spanheim, to the mathematician and astrologer Johann Windung, at Hasfurt, who had apparently written about him. Trithemius, himself reputed a magician, and the author of a mystical work (published at Darmstadt in 1621 under the title of *Steganographica* and burnt by order of the Spanish Inquisition), speaks contemptuously of Faust, who called himself Magister Georgius Sabellicus Faustus Junior, as a fool rather than a philosopher (*fatuum non philosophum*), a vain babbler, vagabond and mountebank who ought to be whipped, and who had fled from the city rather than confront him. The insane conceit of the man was proved by his boast that, were all the works of Aristotle and Plato blotted from the memory of men, he could restore them with greater elegance, and that Christ's miracles were nothing to marvel at, since he could do the like whenever and as often as he pleased; his debased character by the fact that he had been forced to flee from the school of which he had been appointed master by the discovery of his unnatural crimes. The same unflattering estimate is contained in the second extant notice of Faust, in a letter of the jurist and canon Konrad Mudt (Mutianus Rufus), of the 3rd of October 1513, to Heinrich Urbanus. Mudt, like Trithemius, simply regards Faust as a charlatan. Similar is the judgment of another contemporary, Philipp Begardi, who in the fourth chapter of his *Index sanitatis* (Worms, 1539) ranks Faust, with Theophrastus Paracelsus, among the "wicked, cheating, useless and unlearned doctors."

It was Johann Gast (d. 1572), a worthy Protestant pastor of Basel, who like Mudt claims to have come into personal contact with Faust, who in his *Sermones convivales* (Basel, 1543) first credited the magician with genuine supernatural qualities. Gast, a man of some learning and much superstition, believed Faust to be in league with the devil, by whom about 1525 he was ultimately carried off, and declared the performing horse and dog by which the necromancer was accompanied to be familiar and evil spirits. Further information was given to the world by Johann Mannel or Manlius (d. 1560), councillor and historian to the emperor Maximilian II., in his *Locorum communium collectanea* (Basel, undated). Manlius reports a conversation of Melanchthon, which there is no reason to suspect of being other than genuine, in which the Reformer speaks of Faust as "a disgraceful beast and sewer of many devils," as having been born at Kundling (Kundlingen or Knittlingen), a little town near his own native town (of Bretten), and as having studied magic at Cracow. The rest of the information given can hardly be regarded as historical, though Melanchthon, who, like Luther,

¹ The opinion, long maintained by some, that he was identical with Johann Fust, the printer, is now universally rejected.

was no whit less superstitious than most people of his time, evidently believed it to be so. According to him, among other marvels, Faust was killed by the devil wringing his neck. While he lived he had taken about with him a dog, which was really a devil. A similar opinion would seem to have been held of Faust by Luther also, who in Widmann's Faust-book is mentioned as having declared that, by God's help, he had been able to ward off the evils which Faust with his sorceries had sought to put upon him. The passage, with the omission of Faust's name, occurs word for word in Luther's Table-talk (ed. C. E. Förstemann, vol. i. p. 50). It is not improbable, then, that Widmann, in supplying the name of the necromancer omitted in the Table-talk, may be giving a fuller account of the conversation. Bullinger also, in his *Theatrum de beneficiis* (Frankf., 1569) mentions Faust as one of those "of whom the Scriptures speak, in various places, calling them *magi*." Lastly Johann Weiher, Wierus or Piscinarius (1515-1588)—a pupil of Cornelius Agrippa, body physician to the duke of Cleves and a man of enlightenment, who opposed the persecution of witches—in his *De practigiis daemonum* (Basel, 1563, &c.), speaks of Faust as a drunken vagabond who had studied magic at Cracow, and before 1540 had practised "this beautiful art shamelessly up and down Germany, with unspeakable deceit, many lies and great effect." He goes on to tell how the magician had revenged himself on an unhappy parish priest, who had refused to supply him any longer with drink, by giving him a depilatory which removed not only the beard but the skin, and further, how he had insulted a poor wretch, for no better reason than that he had a black beard, by greeting him as his cousin the devil. Of his superhuman powers Weiher evidently believes nothing, but he tells the tale of his being found dead with his neck wrung, after the whole house had been shaken by a terrific din.

The sources above mentioned, which were but the first of numerous works on Faust, of more or less value, appearing throughout the next two centuries, give a sufficient picture of the man as he appeared to his contemporaries: a wandering charlatan who lived by his wits, cheiromantist, astrologer, diviner, spiritualist medium, alchemist, or, to the more credulous, a necromancer whose supernatural gifts were the outcome of a foul pact with the enemy of mankind. Whatever his character, his efforts to secure a widespread notoriety had, by the time of his death, certainly succeeded. By the latter part of the 16th century he had become the necromancer *par excellence*, and all that legend had to tell about the great wizards of the middle ages, Virgil, Pope Silvester, Roger Bacon, Michael Scot, or the mythic Klingsor, had become for ever associated with his name. When in 1587, the oldest Faust-book was published, the Faust legend was, in all essential particulars, already complete.

The origin of the main elements of the legend must be sought far back in the middle ages and beyond. The idea of a compact with the devil, for the purpose of obtaining superhuman power or knowledge, is of Jewish origin, dating from the centuries immediately before and after the Christian era which produced the Talmud, the Kabbalah and such magical books as that of Enoch. In the mystical rites—in which blood, as the seat of life, played a great part—that accompanied the incantations with which the Jewish magicians evoked the Satanim—the lowest grade of those elemental spirits (*shedim*) who have their existence beyond the dimensions of time and space—we have the prototypes and originals of all the ceremonies which occupy the books of magic down to the various versions of the *Höllenzwang* ascribed to Faust. The other principle underlying the Faust legend, the belief in the essentially evil character of purely human learning, has existed ever since the triumph of Christianity set divine revelation above human science. The legend of Theophilus—a Cilician archdeacon of the 6th century, who sold his soul to Satan for no better reason than to clear himself of a false charge brought against him by his bishop—was immensely popular throughout the middle ages, and in the 8th century formed the theme of a poem in Latin hexameters by the nun Hroswitha of Gandersheim, who, especially in her description of the ritual of Satan's court, displays a sufficiently lively and

original imagination. Equally widespread were the legends which gathered round the great name of Gerbert (Pope Silvester II.). Gerbert's vast erudition, like Roger Bacon's so far in advance of his age, naturally cast upon him the suspicion of traffic with the infernal powers; and in due course the suspicion developed into the tale, embellished with circumstantial and harrowing details, of a compact with the arch-fiend, by which the scholar had obtained the summit of earthly ambition at the cost of his immortal soul. These are but the two most notable of many similar stories,¹ and, in an age when the belief in witchcraft and the ubiquitous activity of devils was still universal, it is natural that they should have been retold in all good faith of a notorious wizard who was himself at no pains to deny their essential truth. The Faust legend, however, owes something of its peculiar significance also to the special conditions of the age which gave it birth: the age of the Renaissance and the Reformation. The opinion that the religious reformers were the champions of liberty of thought against the obscurantism of Rome is the outgrowth of later experience. To themselves they were the protagonists of "the pure Word of God" against the corruptions of a church defiled by the world and the devil, and the sceptical spirit of Italian humanism was as abhorrent to them as to the Catholic reactionaries by whom it was again trampled under foot. If then, in Goethe's drama, Faust ultimately develops into the type of the unsatisfied yearning of the human intellect for "more than earthly meat and drink," this was because the great German humanist deliberately infused into the old story a spirit absolutely opposed to that by which it had originally been inspired. The Faust of the early Faust-books, of the ballads, the dramas and the puppet-plays innumerable which grew out of them, is irrevocably damned because he deliberately prefers human to "divine" knowledge; "he laid the Holy Scriptures behind the door and under the bench, refused to be called doctor of Theology, but preferred to be styled doctor of Medicine." The orthodox moral of the earliest versions is preserved to the last in the puppet-plays. The Voice to the right cries: "Faust! Faust! desist from this proposal! Go on with the study of Theology, and you will be the happiest of mortals." The Voice to the left answers: "Faust! Faust! leave the study of Theology. Betake you to Necromancy, and you will be the happiest of mortals!" The Faust legend was, in fact, the creation of orthodox Protestantism; its moral, the inevitable doom which follows the wilful revolt of the intellect against divine authority as represented by the Holy Scriptures and its accredited interpreters. Faust, the contemner of Holy Writ, is set up as a foil to Luther, the champion of the new orthodoxy, who with well-directed inkpot worsted the devil when he sought to interrupt the sacred work of rendering the Bible into the vulgar tongue.

It was doubtless this orthodox and Protestant character of the Faust story which contributed to its immense and immediate popularity in the Protestant countries. The first edition of the *Historia von D. Johann Fausten*, by an unknown compiler, published by Johann Spies at Frankfort in 1587, sold out at once. Though only placed on the market in the autumn, before the year was out it had been reprinted in four pirated editions. In the following year a rhymed version was printed at Tübingen, a second edition was published by Spies at Frankfort and a version in low German by J. J. Balhorn at Lübeck. Reprints and amended versions continued to appear in Germany every year, till they culminated in the pedantic compilation of Georg Rudolf Widmann, who obscured the dramatic interest of the story by an excessive display of erudition and by his well-meant efforts to elaborate the orthodox moral. Widmann's version of 1599 formed the basis of that of Johann Nicholas Pfitzer, published at Nuremberg in 1674, which passed through six editions, the last appearing in 1726. Like Widmann, Pfitzer was more zealous for imparting information than for perfecting a work of art, though he had the good taste to restore the episode of the evocation of Helen, which Widmann had expunged as unfit for Christian readers. Lastly there appeared, about

¹ Many are given in Kiesewetter's *Faust*, p. 112, &c.

1712, what was to prove the most popular of all the Faust-books: *The League with the Devil established by the world-famous Arch-necromancer and Wizard Dr Johann Faust*. By a Christian Believer (*Christlich Meynenden*). This version, which bore the obviously false date of 1525, passed through many editions, and was circulated at all the fairs in Germany. Abroad the success of the story was scarcely less striking. A Danish version appeared in 1588; in England the *History of the Damnable Life and Deserved Death of Dr John Faustus* was published some time between 1588 and 1594; in France the translation of Victor Palma Cayet was published at Paris in 1592 and, in the course of the next two hundred years, went through fifteen editions; the oldest Dutch and Flemish versions are dated 1592; and in 1612 a Czech translation was published at Prague.

Besides the popular histories of Faust, all more or less founded on the original edition of Spies, numerous ballads on the same subject were also soon in circulation. Of these the most interesting for the English reader is *A Ballad of the life and death of Dr Faustus the great congerer*, published in 1588 with the imprimatur of the learned Aylmer, bishop of London. This ballad is supposed to have preceded the English version of Spies's Faust-book, mentioned above, on which Marlowe's drama was founded.

To Christopher Marlowe, it would appear, belongs the honour of first realizing the great dramatic possibilities of the Faust legend. *The Tragicall History of D. Faustus as it hath bene acted by the Right Honourable the Earle of Nottingham his servants* was first published by Thomas Bushall at London in 1604. As Marlowe died in 1593, the play must have been written shortly after the appearance of the English version of the Faust story on which it was based. The first recorded performance was on the 30th of September 1594.

As Marlowe's *Faustus* is the first, so it is incomparably the finest of the Faust dramas which preceded Goethe's masterpiece. Like most of Marlowe's work it is, indeed, very unequal. At certain moments the poet seems to realize the great possibilities of the story, only to sacrifice them to the necessity for humouring the prevailing public taste of the age. Faustus, who in one scene turns disillusioned from the ordinary fountains of knowledge, or flies in a dragon-drawn chariot through the Empyrean to search out the mysteries of the heavens, in another is made to use his superhuman powers to satisfy the taste of the groundlings for senseless buffoonery, to swindle a horse-dealer, or cheat an ale-wife of her score; while Protestant orthodoxy is conciliated by irrelevant insults to the Roman Church and by the final catastrophe, when Faustus pays for his revolt against the Word of God by the forfeit of his soul. This conception, which followed that of the popular Faust histories, underlay all further developments of the Faust drama for nearly two hundred years. Of the serious stage plays founded on this theme, Marlowe's *Faustus* remains the sole authentic example until near the end of the 18th century; but there is plenty of evidence to prove that in Germany the *Comedy of Dr Faust*, in one form or another, was and continued to be a popular item in the repertoires of theatrical companies until far into the 18th century. It is supposed, with good reason, that the German versions were based on those introduced into the country by English strolling players early in the 17th century. However this may be, the dramatic versions of the Faust legend followed much the same course as the prose histories. Just as these gradually degenerated into chap-books hawked at fairs, so the dramas were replaced by puppet-plays, handed down by tradition through generations of showmen, retaining their original broad characteristics, but subject to infinite modification in detail. In this way, in the puppet-shows, the traditional Faust story retained its popularity until far into the 19th century, long after, in the sphere of literature, Goethe had for ever raised it to quite another plane.

It was natural that during the literary revival in Germany in the 18th century, when German writers were eagerly on the look-out for subjects to form the material of a truly national literature, the Faust legend should have attracted their attention. Lessing was the first to point out its great possibilities;¹ and

¹ In the *Literaturbrief* of Feb. 16, 1759.

he himself wrote a Faust drama, of which unfortunately only a fragment remains, the MS. of the completed work having been lost in the author's lifetime. None the less, to Lessing, not to Goethe, is due the new point of view from which the story was approached by most of those who, after about the year 1770, attempted to tell it. The traditional Faust legend represented the sternly orthodox attitude of the Protestant reformers. Even the mitigating elements which the middle ages had permitted had been banished by the stern logic of the theologians of the New Religion. Theophilus had been saved in the end by the intervention of the Blessed Virgin; Pope Silvester, according to one version of the legend, had likewise been snatched from the jaws of hell at the last moment. Faust was irrevocably damned, since the attractions of the *studium theologicum* proved insufficient to counteract the fascinations of the classic Helen. But if he was to become, in the 18th century, the type of the human intellect face to face with the deep problems of human life, it was intolerable that his struggles should issue in eternal reprobation. Error and heresy had ceased to be regarded as crimes; and stereotyped orthodoxy, to the age of the Encyclopaedists, represented nothing more than the atrophy of the human intellect. *Es irrt der Mensch so lang er strebt*, which sums up in one pregnant line the spirit of Goethe's *Faust*, sums up also the spirit of the age which killed with ridicule the last efforts of persecuting piety, and saw the birth of modern science. Lessing, in short, proclaimed that the final end of Faust must be, not his damnation, but his salvation. This revolutionary conception is the measure of Goethe's debt to Lessing. The essential change which Goethe himself introduced into the story is in the nature of the pact between Faust and Mephistopheles, and in the character of Mephistopheles himself. The Mephistopheles of Marlowe, as of the old Faust-books, for all his brave buffoonery, is a melancholy devil, with a soul above the unsavoury hell in which he is forced to pass a hopeless existence. "Tell me," says Faust, in the puppet-play, to Mephistopheles, "what would you do if you could attain to everlasting salvation?" And the devil answers, "Hear and despair! Were I able to attain everlasting salvation, I would mount to heaven on a ladder, though every rung were a razor edge!" Goethe's Mephistopheles would have made no such reply. There is nothing of the fallen angel about him; he is perfectly content with his past, his present and his future; and he appears before the throne of God with the same easy insolence as he exhibits in Dame Martha's back-garden. He is, in fact, according to his own definition, the Spirit of Denial, the impersonation of that utter scepticism which can see no distinction between high and low, between good and bad, and is therefore without aspiration because it knows no "divine discontent." And the compact which Faust makes with this spirit is from the first doomed to be void. Faustus had bartered away his soul for a definite period of pleasure and power. The conception that underlies the compact of Faust with Mephistopheles is far more subtle. He had sought happiness vainly in the higher intellectual and spiritual pursuits; he is content to seek it on a lower plane since Mephistopheles gives him the chance; but he is confident that nothing that "such a poor devil" can offer him could give him that moment of supreme satisfaction for which he craves. He goes through the traditional mummerly of signing the bond with scornful submission; for he knows that his damnation will not be the outcome of any formal compact, but will follow inevitably, and only then, when his soul has grown to be satisfied with what Mephistopheles can purvey him.

"Canst thou with lying flattery rule me
 Until self-pleased myself I see,
 Canst thou with pleasure mock and fool me,
 Let that hour be the last for me!
 When thus I hail the moment flying:
 'Ah, still delay, thou art so fair!
 Then bind me in thy chains undying,
 My final ruin then declare!"²

It is because Mephistopheles fails to give him this self-satisfaction

² Bayard Taylor's trans.

or to absorb his being in the pleasures he provides, that the compact comes to nothing. When, at last, Faust cries to the passing moment to remain, it is because he has forgotten self in enthusiasm for a great and beneficent work, in a state of mind the very antithesis of all that Mephistopheles represents. In the old Faust-books, Faust had been given plenty of opportunity for repentance, but the inducements had been no higher than the exhibition of a throne in heaven on the one hand and the tortures of hell on the other. Goethe's *Faust*, for all its Christian setting, departs widely from this orthodox standpoint. Faust shows no signs of "repentance"; he simply emerges by the innate force of his character from a lower into a higher state. The triumph, foretold by "the Lord" in the opening scene, was inevitable from the first, since, though

"Man errs so long as he is striving,
A good man through obscurest aspiration
Is ever conscious of the one true way."

A man, in short, must be judged not by the sins and follies which may be but accidents of his career, but by the character which is its essential outcome.

This idea, which inspired also the kindred theme of Browning's *Paracelsus*, is the main development introduced by Goethe into the Faust legend. The episode of Gretchen, for all its tragic interest, does not belong to the legend at all; and it is difficult to deny the pertinency of Charles Lamb's criticism, "What has Margaret to do with Faust?" Yet in spite of all that may be said of the irrelevancies, and of the discussions of themes of merely ephemeral interest, with which Goethe overloaded especially the second part of the poem, his *Faust* remains for the modern world the final form of the legend out of which it grew, the magnificent expression of the broad humanism which, even in spheres accounted orthodox, has tended to replace the peculiar *studium theologicum* which inspired the early Faust-books.

See Karl Engel, *Zusammenstellung der Faust-Schriften vom 16. Jahrhundert bis Mitte 1884*—a second edition of the *Bibliotheca Faustiana* (1874)—(Oldenburg, 1885), a complete bibliography of all published matter concerned, even somewhat remotely, with Faust; Goethe's *Faust*, with introduction and notes by K. J. Schröder (2nd ed., Heilbronn, 1886); Carl Kiesewetter, *Faust in der Geschichte und Tradition* (Leipzig, 1893). The last book, besides being a critical study of the material for the historical and legendary story of Faust, aims at estimating the relation of the Faust-legend to the whole subject of occultism, ancient and modern. It is a mine of information on necromancy and its kindred subjects, as well as on eminent theurgists, wizards, crystal-gazers and the like of all ages.

(W. A. P.)

FAUSTINA, ANNIA GALERIA, the younger, daughter of Antoninus Pius, and wife of Marcus Aurelius Antoninus. She is accused by Dio Cassius and Capitolinus of gross profligacy, and was reputed to have instigated the revolt of Avidius Cassius against her husband. She died in 175 or 176 (so Clinton, *Fasti rom.*) at Halala, near Mount Taurus, in Cappadocia, whither she had accompanied Aurelius. Charitable schools for orphan girls (hence called *Faustinianae*) were founded in her honour, like those established by her father Antoninus in honour of his wife, the elder Faustina. Her statue was placed in the temple of Venus, and she was numbered among the tutelary deities of Rome. From the fact that Aurelius was always devoted to her and was heartbroken at her death, it has been inferred that the unfavourable estimate of the historians is prejudiced or at least mistaken.

See Capitolinus, *Marcus Aurelius*; Dio Cassius lxxi. 22, lxxiv. 3; E. Renan, in *Mélanges d'histoire et des voyages*, 169-195.

FAVARA, a town of Sicily, in the province of Girgenti, 5 m. E. of Girgenti by road. Pop. (1901) 20,398. It possesses a fine castle of the Chiaramonte family, erected in 1280. The town has a considerable agricultural trade, and there are sulphur and other mines in the neighbourhood.

FAVART, CHARLES SIMON (1710-1792), French dramatist, was born in Paris on the 13th of November 1710, the son of a pastry-cook. He was educated at the college of Louis-le-Grand, and after his father's death carried on the business for a time. His first success in literature was *La France délivrée par la Pucelle d'Orléans*, a poem which obtained a prize of the Académie des Jeux Floraux. After the production of his first vaudeville, *Les Deux Jumelles* (1734), circumstances enabled him to relinquish

business and devote himself entirely to the drama. He provided many pieces anonymously for the lesser theatres, and first put his name to *La Chercheuse d'esprit*, which was produced in 1741. Among his most successful works were *Annette et Lubin*, *Le Coq du village* (1743), *Ninette à la cour* (1753), *Les Trois Sultanes* (1761) and *L'Anglais à Bordeaux* (1763). Favart became director of the Opéra Comique, and in 1745 married MARIE JUSTINE BENOÎTE DURONCERAY (1727-1772), a beautiful young dancer, singer and actress, who as "Mlle Chantilly" had made a successful début the year before. By their united talents and labours the Opéra Comique rose to such a height of success that it aroused the jealousy of the rival Comédie Italienne and was suppressed. Favart, left thus without resources, accepted the proposal of Maurice de Saxe, and undertook the direction of a troupe of comedians which was to accompany his army into Flanders. It was part of his duty to compose from time to time impromptu verses on the events of the campaign, amusing and stimulating the spirits of the men. So popular were Favart and his troupe that the enemy became desirous of hearing his company and sharing his services, and permission was given to gratify them, battles and comedies thus curiously alternating with each other. But the marshal, who was an admirer of Mme Favart, began to persecute her with his attentions. To escape him she went to Paris, and the wrath of Saxe fell upon the husband. A *lettre de cachet* was issued against him, but he fled to Strassburg and found concealment in a cellar. Mme Favart meanwhile had been established by the marshal in a house at Vaugirard; but as she proved a fickle mistress she was suddenly arrested and confined in a convent, where she was brought to unconditional surrender in the beginning of 1750. Before the year was out the marshal died, and Mme Favart reappeared at the Comédie Italienne, where for twenty years she was the favourite actress. To her is largely due the beginnings of the change in this theatre to performances of a lyric type adapted from Italian models, which developed later into the genuine French comic opera. She was also a bold reformer in matters of stage costume, playing the peasant with bare arms, in wooden shoes and linen dress, and not, as heretofore, in court costume with enormous hoops, diamonds and long white kid gloves. With her husband, and other authors, she collaborated in a number of successful pieces, and one—*La Fille mal gardée*—she produced alone.

Favart survived his wife twenty years. After the marshal's death in 1750 he had returned to Paris, and resumed his pursuits as a dramatist. It was at this time that the abbé de Voisenon became intimate with him and took part in his labours, to what extent is uncertain. He had grown nearly blind in his last days, and died in Paris on the 12th of May 1792. His plays have been several times republished in various editions and selections (1763-1772, 12 vols.; 1810, 3 vols.; 1813; 1853). His correspondence (1750-1763) with Count Durazzo, director of theatres at Vienna, was published in 1808 as *Mémoires et correspondance littéraire, dramatique et anecdotique de C. S. Favart*. It furnishes valuable information on the state of the literary and theatrical worlds in the 18th century.

Favart's second son, CHARLES NICOLAS JOSEPH JUSTIN FAVART (1740-1806), was an actor of moderate talent at the Comédie Française for fifteen years. He wrote a number of successful plays:—*Le Diable boiteux* (1782), *Le Mariage singulier* (1787) and, with his father, *La Vieillesse d'Annette* (1791). His son Antoine Pierre Charles Favart (1780-1867) was in the diplomatic service, and assisted in editing his grandfather's memoirs; he was a playwright and painter as well.

FAVERSHAM, a market town and river-port, member of the Cinque Port of Dover, and municipal borough in the Faversham parliamentary division of Kent, England, on a creek of the Swale, 9 m. W.N.W. of Canterbury on the South-Eastern & Chatham railway. Pop. (1901) 11,290. The church of St Mary of Charity, restored by Sir G. G. Scott in 1874, is of Early English architecture, and has some remains on one of the columns of frescoes of the same period, while the 14th-century paintings in the chancel are in better preservation. Some of the brasses are very fine, and there is one commemorating King Stephen, as well as

a tomb said to be his. He was buried at the abbey he founded here, of which only a wall and the foundations below ground remain. At Davington, close to Faversham, there are remains, incorporated in a residence, of the cloisters and other parts of a Benedictine priory founded in 1153. Faversham has a free grammar school founded in 1527 and removed to its present site in 1877. Faversham Creek is navigable up to the town for vessels of 200 tons. The shipping trade is considerable, chiefly in coal, timber and agricultural produce. The oyster fisheries are important, and are managed by a very ancient guild, the Company of Free Dredgemen of the Hundred and Manor of Faversham. Brewing, brickmaking and the manufacture of cement are also carried on, and there are several large powder mills in the vicinity. The town is governed by a mayor, 4 aldermen and 12 councillors. Area, 686 acres.

There was a Romano-British village on the site of Faversham. The town (Fauresfeld, Faveresham) owed its early importance to its situation as a port on the Swale, to the fertile country surrounding it, and to the neighbourhood of Watling Street. In 811 it was called the king's town, and a witenagemot was held here under Æthelstan. In 1086 it was assessed as royal demesne, and a market was held here at this date. An abbey was built by Stephen in 1147, in which he and Matilda were buried. They had endowed it with the manor and hundred of Faversham; this grant caused many disputes between the abbot and men of Faversham concerning the abbot's jurisdiction. Faversham was probably a member of Dover from the earliest association of the Cinque Ports, certainly as early as Henry III., who in 1252 granted among other liberties of the Cinque Ports that the barons of Faversham should plead only in Shepway Court, but ten years later transferred certain pleas to the abbot's court. In this reign also the abbot appointed the mayor, but from the reign of Edward I. he was elected by the freemen and then installed by the abbot. The corporation was prescriptive, and a hallmote held in 1293 was attended by a mayor and twelve jurats. All the liberties of the Cinque Ports were granted to the barons of Faversham by Edward I. in 1302, and confirmed by Edward III. in 1365, and by later monarchs. The governing charter till 1835 was that of Henry VIII., granted in 1545 and confirmed by Edward VI.

FAVORINUS (2nd century A.D.), Greek sophist and philosopher, flourished during the reign of Hadrian. A Gaul by birth, he was a native of Arelate (Arles), but at an early age began his lifelong travels through Greece, Italy and the East. His extensive knowledge, combined with great oratorical powers, raised him to eminence both in Athens and in Rome. With Plutarch, who dedicated to him his treatise *Περὶ τοῦ πρώτου ψυχροῦ*, with Herodes Atticus, to whom he bequeathed his library at Rome, with Demetrius the Cynic, Cornelius Fronto, Aulus Gellius, and with Hadrian himself, he lived on intimate terms; his great rival, whom he violently attacked in his later years, was Polemon of Smyrna. It was Favorinus who, on being silenced by Hadrian in an argument in which the sophist might easily have refuted his adversary, subsequently explained that it was foolish to criticize the logic of the master of thirty legions. When the servile Athenians, feigning to share the emperor's displeasure with the sophist, pulled down a statue which they had erected to him, Favorinus remarked that if only Socrates also had had a statue at Athens, he might have been spared the hemlock. Of the very numerous works of Favorinus, we possess only a few fragments (unless the Κορινθιακὸς λόγος attributed to his tutor Dio Chrysostom is by him), preserved by Aulus Gellius, Diogenes Laërtius, Philostratus, and Suidas, the second of whom borrows from his *Παντοδαπὴ ἱστορία* (miscellaneous history) and his *Ἀπομνημονεύματα* (memoirs). As a philosopher, Favorinus belonged to the sceptical school; his most important work in this connexion appears to have been *Πυρρῶνεοι τρόποι* (the Pyrrhonian Tropes) in ten books, in which he endeavours to show that the methods of Pyrrho were useful to those who intended to practise in the law courts.

See Philostratus, *Vitae sophistarum*, i. 8; Suidas, s.v.; frags. in C. W. Müller, *Frag. Hist. Graec.* iii. 4; monographs by L. Legré (1900), T. Colardeau (1903).

FAVRAS, THOMAS DE MAHY, MARQUIS DE (1744-1790), French royalist, was born on the 26th of March 1744, at Blois. He belonged to a poor family whose nobility dated from the 12th century. At seventeen he was a captain of dragoons, and saw some service in the closing campaign of the Seven Years' War. In 1772 he became first lieutenant of the Swiss guards of the count of Provence (afterwards Louis XVIII.). Unable to meet the expenses of his rank, which was equivalent to the grade of colonel in the army, he retired in 1775. He married in 1776 Victoria Hedwig Caroline, princess of Anhalt-Bernburg-Schaumburg, whose mother, deserted by her husband Prince Carl Ludwig in 1749, had found refuge with her daughter in the house of Marshal Soubise. After his marriage he went to Vienna to press the restitution of his wife's rights, and spent some time in Warsaw. In 1787 he was authorized to raise a patriotic legion to help the Dutch against the stadtholder William IV. and his Prussian allies. Returning to Paris at the outbreak of the Revolution, he became implicated in schemes for the escape of Louis XVI. from Paris and the dominance of the National Assembly. He was commissioned by the count of Provence through one of his gentlemen, the comte de la Châtre, to negotiate a loan of two million francs from the bankers Schaumel and Sartorius. Favras took into his confidence certain officers by whom he was betrayed; and, with his wife, he was arrested on Christmas Eve 1789 and imprisoned in the Abbaye. A fortnight later they were separated, Favras being removed to the Châtelet. It was stated in a leaflet circulated throughout Paris that Favras had organized a plot of which the count of Provence was the moving spirit. A force of 30,000 was to be raised, La Fayette and Bailly, the mayor of Paris, were to be assassinated, and Paris was to be starved into submission by cutting off supplies. The count hastened publicly to disavow Favras in a speech delivered before the commune of Paris and in a letter to the National Assembly, although there is no reasonable doubt of his complicity in the plot that did exist. In the course of a trial of nearly two months' duration the witnesses disagreed, and even the editor of the *Révolutions de Paris* (No. 30) admitted that the evidence was insufficient; but an armed attempt of the Royalists on the Châtelet on the 26th of January, which was defeated by La Fayette, roused the suspicious temper of the Parisians to fury, and on the 18th of February 1790, in spite of the courageous defence of his counsel, Favras was condemned to be hanged. He refused to give any information of the alleged plot, and the sentence was carried out on the Place de Grève the next day, to the delight of the populace, since it was the first instance when no distinction in the mode of execution was allowed between noble and commoner. Favras was generally regarded as a martyr to his refusal to implicate the count of Provence, and Madame de Favras was pensioned by Louis XVI. She left France, and her son Charles de Favras served in the Austrian and the Russian armies. He received an allowance from Louis XVIII. Her daughter Caroline married Rüdiger, Freiherr von Stillfried Ratènic, in 1805.

The official *dossier* of Favras's trial for high treason against the nation disappeared from the Châtelet, but its substance is preserved in the papers of a clerk.

BIBLIOGRAPHY.—For particulars see A. Tuetey, *Répertoire général des sources manuscrites de l'histoire de Paris pendant la Révolution Française* (vol. i., 1890, pp. 175-177); M. Tourneux, *Bibl. de l'histoire de Paris pendant la Révolution Française* (vol. i. pp. 196-198, 1890). His brother, M. Mahy de Cormère, published a *Mémoire justificatif* in 1790 and a *Justification* in 1791. See also a memoir by Eduard, Freiherr v. Stillfried Ratènic (Vienna, 1881), and an article by Alexis de Valon in the *Revue des deux mondes* (15th June 1851).

FAVRE, JEAN ALPHONSE (1815-1890), Swiss geologist, was born at Geneva on the 31st of March 1815. He was for many years professor of geology in the academy at Geneva, and afterwards president of the Federal Commission with charge of the geological map of Switzerland. One of his earliest papers was *On the Anthracites of the Alps* (1841), and later he gave special attention to the geology of Savoy and of Mont Blanc, and to the ancient glacial phenomena of those Alpine regions. His elucidation of the geological structure demonstrated that

certain anomalous occurrences of fossils were due to repeated interfoldings of the strata and to complicated overthrust faults. In 1867 he published *Recherches géologiques dans les parties de la Savoie, du Piémont et de la Suisse voisines du Mont Blanc*. He died at Geneva in June 1890.

His son ERNEST FAVRE (b. 1845) has written on the palaeontology and geology of Galicia, Savoy and the Fribourg Alps, and of the Caucasus and Crimea.

FAVRE, JULES CLAUDE GABRIEL (1809–1880), French statesman, was born at Lyons on the 21st of March 1809, and began his career as an advocate. From the time of the revolution of 1830 he openly declared himself a republican, and in political trials he seized the opportunity to express his opinions. After the revolution of 1848 he was elected deputy for Lyons to the Constituent Assembly, where he sat among the moderate republicans, voting against the socialists. When Louis Napoleon was elected President of France, Favre made himself conspicuous by his opposition, and on the 2nd of December 1851 he tried with Victor Hugo and others to organize an armed resistance in the streets of Paris. After the *coup d'état* he withdrew from politics, resumed his profession, and distinguished himself by his defence of Felice Orsini, the perpetrator of the attack against the life of Napoleon III. In 1858 he was elected deputy for Paris, and was one of the "Five" who gave the signal for the republican opposition to the Empire. In 1863 he became the head of his party, and delivered a number of addresses denouncing the Mexican expedition and the occupation of Rome. These addresses, eloquent, clear and incisive, won him a seat in the French Academy in 1867. With Thiers he opposed the declaration of war against Prussia in 1870, and at the news of the defeat of Napoleon III. at Sedan he demanded from the Legislative Assembly the deposition of the emperor. In the government of National Defence he became vice-president under General Trochu, and minister of foreign affairs, with the onerous task of negotiating peace with victorious Germany. He proved to be less adroit as a diplomat than he had been as an orator, and committed several irreparable blunders. His famous statement on the 6th of September 1870 that he "would not yield to Germany an inch of territory nor a single stone of the fortresses" was a piece of oratory which Bismarck met on the 19th by his declaration to Favre that the cession of Alsace and of Lorraine was the indispensable condition of peace. He also made the mistake of not having an assembly elected which would have more regular powers than the government of National Defence, and of opposing the removal of the government from Paris during the siege. In the peace negotiations he allowed Bismarck to get the better of him, and arranged for the armistice of the 28th of June 1871 without knowing the situation of the armies, and without consulting the government at Bordeaux. By a grave oversight he neglected to inform Gambetta that the army of the East (80,000 men) was not included in the armistice, and it was thus obliged to retreat to neutral territory. He gave no proof whatever of diplomatic skill in the negotiations for the treaty of Frankfurt, and it was Bismarck who imposed all the conditions. He withdrew from the ministry, discredited, on the 2nd of August 1871, but remained in the chamber of deputies. Elected senator on the 30th of January 1876, he continued to support the government of the republic against the reactionary opposition, until his death on the 20th of January 1880.

His works include many speeches and addresses, notably *La Liberté de la Presse* (1849), *Défense de F. Orsini* (1866), *Discours de réception à l'Académie française* (1868), *Discours sur la liberté intérieure* (1869). In *Le Gouvernement de la Défense Nationale*, 3 vols., 1871–1875, he explained his rôle in 1870–1871. After his death his family published his speeches in 8 volumes.

See G. Hanotaux, *Histoire de la France contemporaine* (1903, &c.); also E. Benoit-Lévy, *Jules Favre* (1884).

FAVUS (Lat. for honeycomb), a disease of the scalp, but occurring occasionally on any part of the skin, and even at times on mucous membranes. The uncomplicated appearance is that of a number of yellowish, circular, cup-shaped crusts (scutula) grouped in patches like a piece of honeycomb, each about the

size of a split pea, with a hair projecting in the centre. These increase in size and become crusted over, so that the characteristic lesion can only be seen round the edge of the scab. Growth continues to take place for several months, when scab and scutulum come away, leaving a shining bare patch destitute of hair. The disease is essentially chronic, lasting from ten to twenty years. It is caused by the growth of a fungus, and pathologically is the reaction of the tissues to the growth. It was the first disease in which a fungus was discovered—by J. L. Schönlein in 1839; the discovery was published in a brief note of twenty lines in *Müllers Archiv* for that year (p. 82), the fungus having been subsequently named by R. Remak *Achorion Schönleinii* after its discoverer. The achorion consists of slender, mycelial threads matted together, bearing oval, nucleated gonidia either free or jointed. The spores would appear to enter through the unbroken cutaneous surface, and to germinate mostly in and around the hair-follicle and sometimes in the shaft of the hair. In 1892 two other species of the fungus were described by P. G. Unna and Frank, the *Favus griseus*, giving rise to greyish-yellow scutula, and the *Favus sulphureus celerior*, causing sulphur-yellow scutula of a rapid growth. Favus is commonest among the poorer Jews of Russia, Poland, Hungary, Galicia and the East, and among the same class of Mahomedans in Turkey, Asia Minor, Syria, Persia, Egypt, Algiers, &c. It is not rare in the southern departments of France, in some parts of Italy, and in Scotland. It is spread by contagion, usually from cats, often, however, from mice, fowls or dogs. Lack of personal cleanliness is an almost necessary factor in its development, but any one in delicate health, especially if suffering from phthisis, seems especially liable to contract it. Before treatment can be begun the scabs must be removed by means of carbolized oil, and the head thoroughly cleansed with soft soap. The cure is then brought about by the judicious use of parasiticides. If the nails are affected, avulsion will probably be needed before the disease can be reached.

FAWCETT, HENRY (1833–1884), English politician and economist, was born at Salisbury on the 25th of August 1833. His father, William Fawcett, a native of Kirkby Lonsdale, in Westmorland, started life as a draper's assistant at Salisbury, opened a draper's shop on his own account in the market-place there in 1825, married a solicitor's daughter of the city, became a prominent local man, took a farm, developed his north-country sporting instincts, and displayed his shrewdness by successful speculations in Cornish mining. His second son, Henry, inherited a full measure of his shrewdness, along with his masculine energy, his straightforwardness, his perseverance and his fondness for fishing. The father was active in electioneering matters, and his wife was an ardent reformer. Henry Fawcett was educated locally and at King's College school, London, and proceeded to Peterhouse, Cambridge, in October 1852, migrating in 1853 to Trinity Hall. He was seventh wrangler in 1856, and was elected to a fellowship at his college.

He had already attained some prominence as an orator at the Cambridge Union. Before he left school he had formed the ambition of entering parliament, and, being a poor man, he resolved to approach the House of Commons through a career at the bar. He had already entered Lincoln's Inn. His prospects, however, were shattered by a calamity which befell him in September 1858, when two stray pellets from his father's fowling-piece passed through the glasses he was wearing and blinded him for life. Within ten minutes after his accident he had made up his mind "to stick to his old pursuits as much as possible." He kept up all recreations contributing to the enjoyment of life; he fished, rowed, skated, took abundant walking and horse exercise, and learnt to play cards with marked packs. Soon after his accident he established his headquarters at Trinity Hall, Cambridge, entered cordially into the social life of the college, and came to be regarded by many as a typical Cambridge man. He gave up mathematics (for which he had little aptitude), and specialized in economic history. He paid comparatively little attention to economic history, but he was in the main a

devout believer in economic theory, as represented by Ricardo and his school. The later philosophy of the subject he believed to be summed up in one book, Mill's *Principles of Political Economy*, which he regarded as the indispensable "vade mecum" of every politician. He was not a great reader, and Mill probably never had a serious rival in his regard, though he was much impressed by Buckle's *History of Civilization* and Darwin's *Origin of Species* when they severally appeared. He made a great impression in 1859 with a paper at the British Association, and he soon became a familiar figure there and at various lecture halls in the north as an exponent of orthodox economic theory. Of the sincerity of his faith he gave the strongest evidence by his desire at all times to give a practical application to his views and submit them to the test of experiment. Among Mill's disciples he was, no doubt, far inferior as an economic thinker to Cairnes, but as a popularizer of the system and a demonstrator of its principles by concrete examples he had no rival. His power of exposition was illustrated in his *Manual of Political Economy* (1863), of which in twenty years as many as 20,000 copies were sold. Alexander Macmillan had suggested the book, and it appeared just in time to serve as a credential, when, in the autumn of 1863, Fawcett stood and was elected for the Chair of Political Economy at Cambridge. The appointment attached him permanently to Cambridge, gave him an income, and showed that he was competent to discharge duties from which a blind man is often considered to be debarred. He was already a member of the Political Economy Club, and was becoming well known in political circles as an advanced Radical. In January 1863, after a spirited though abortive attempt in Southwark, he was only narrowly beaten for the borough of Cambridge. Early in 1864 he was adopted as one of the Liberal candidates at Brighton, and at the general election of 1865 he was elected by a large majority. Shortly after his election he became engaged to Millicent, daughter of Mr Newson Garrett of Aldeburgh, Suffolk, and in 1867 he was married. Mrs Fawcett (b. 1847) became well known for her social and literary work, and especially as an advocate, in the press and on the platform, of women's suffrage and the higher education and independent employment of women. And after her husband's death, as well as during his lifetime, she was a prominent leader in these movements.

Fawcett entered parliament just in time to see the close of Palmerston's career and to hail the adoption by Gladstone of a programme of reform to which most of the *laissez-faire* economists gave assent. He was soon known as a forcible speaker, and quickly overcame the imputation that he was academic and doctrinaire, though it is true that a certain monotony in delivery often gave a slightly too didactic tone to his discourses. But it was as the uncompromising critic of the political shifts and expedients of his leaders that he attracted most attention. He constantly insisted upon the right of exercising private judgment, and he especially devoted himself to the defence of causes which, as he thought, were neglected both by his official leaders and by his Radical comrades. Re-elected for Brighton to the parliament of 1868-1874, he greatly hampered the government by his persistence in urging the abolition of clerical fellowships and the payment of election expenses out of the rates, and by opposing the "permissive compulsion" clauses of the Elementary Education Bill, and the exclusion of agricultural children from the scope of the act. His hatred of weak concessions made him the terror of parliamentary wirepullers, and in 1871 he was not undeservedly spoken of in *The Times* as the most "thorough Radical now in the House." His liberal ideals were further shocked by the methods by which Gladstone achieved the abolition of Army Purchase. His disgust at the supineness of the cabinet in dealing with the problems of Indian finance and the growing evil of Commons Enclosures were added to the catalogue of grievances which Fawcett drew up in a powerful article, "On the Present Position of the Government," in the *Fortnightly Review* for November 1871. In 1867 he had opposed the expenses of a ball given to the sultan at the India office being charged upon the Indian

budget. In 1870 he similarly opposed the taxation of the Indian revenue with the cost of presents distributed by the duke of Edinburgh in India. In 1871 he went alone into the lobby to vote against the dowry granted to the princess Louise. The soundness of his principles was not impeached, but his leaders looked askance at him, and from 1871 he was severely shunned by the government whips. Their suspicion was justified when in 1873 Fawcett took a leading share in opposing Gladstone's scheme for university education in Ireland as too denominational, and so contributed largely to a conclusive defeat of the Gladstone ministry.

From 1869 to 1880 Fawcett concentrated his energies upon two important subjects which had not hitherto been deemed worthy of serious parliamentary attention. The first of these was the preservation of commons, especially those near large towns; and the second was the responsibility of the British government for the amendment of Indian finance. In both cases the success which he obtained exhibited the sterling sense and shrewdness which made up such a great part of Fawcett's character. In the first case Fawcett's great triumph was the enforcement of the general principle that each annual Enclosure Act must be scrutinized by parliament and judged in the light of its conformity to the interests of the community at large. Probably no one did more than he did to prevent the disafforestation of Epping Forest and of the New Forest. From 1869 he regularly attended the meetings of the Commons Preservation Society, and he remained to the end one of its staunchest supporters. His intervention in the matter of Indian finance, which gained him the sobriquet of the "member for India," led to no definite legislative achievements, but it called forth the best energies of his mind and helped to rouse an apathetic and ignorant public to its duties and responsibilities. Fawcett was defeated at Brighton in February 1874. Two months later, however, he was elected for Hackney, and retained the seat during his life. He was promptly replaced on the Indian Finance Committee, and continued his searching inquiries with a view to promote a stricter economy in the Indian budget, and a more effective responsibility in the management of Indian accounts.

As an opponent of the Disraeli government (1874-1880) Fawcett came more into line with the Liberal leaders. In foreign politics he gave a general adhesion to Gladstone's views, but he continued to devote much attention to Indian matters, and it was during this period that he produced two of his best publications. His *Free Trade and Protection* (1878) illustrated his continued loyalty to Cobdenite ideas. At the same time his admiration for Palmerston and his repugnance to schemes of Home Rule show that he was not by any means a peace-at-any-price man. He thought that the Cobdenites had deserved well of their country, but he always maintained that their foreign politics were biased to excess by purely commercial considerations. As befitted a writer whose linguistic gifts were of the slenderest, Fawcett's English was a sound homespun, clear and unpretentious. In a vigorous employment of the vernacular he approached Cobbett, whose writing he justly admired. The second publication was his *Indian Finance* (1880), three essays reprinted from the *Nineteenth Century*, with an introduction and appendix. When the Liberal party returned to power in 1880 Gladstone offered Fawcett a place in the new government as postmaster-general (without a seat in the cabinet). On Egyptian and other questions of foreign policy Fawcett was often far from being in full harmony with his leaders, but his position in the government naturally enforced reserve. He was, moreover, fully absorbed by his new administrative functions. He gained the sympathy of a class which he had hitherto done little to conciliate, that of public officials, and he showed himself a most capable head of a public department. To his readiness in adopting suggestions, and his determination to push business through instead of allowing it to remain permanently in the stage of preparation and circumlocution, the public is mainly indebted for five substantial postal reforms:—(1) The parcels post, (2) postal orders, (3) sixpenny telegrams, (4) the banking

of small savings by means of stamps, (5) increased facilities for life insurance and annuities. In connexion with these last two improvements Fawcett, in 1880, with the assistance of Mr James Cardin, took great pains in drawing up a small pamphlet called *Aids to Thrift*, of which over a million copies were circulated gratis. A very useful minor innovation of his provided for the announcement on every pillar-box of the time of the "next collection." In the post office, as elsewhere, he was a strong advocate of the employment of women. Proportional representation and the extension of franchise to women were both political doctrines which he adopted very early in his career, and never abandoned. Honours were showered upon him during his later years. He was made an honorary D.C.L. of Oxford, a fellow of the Royal Society, and was in 1883 elected lord rector of Glasgow University. But the stress of departmental work soon began to tell upon his health. In the autumn of 1882 he had a sharp attack of diphtheria complicated by typhoid, from which he never properly recovered. He resumed his activities, but on the 6th of November 1884 he succumbed at Cambridge to an attack of congestion of the lungs. He was buried in Trumpington churchyard, near Cambridge, and to his memory were erected a monument in Westminster Abbey, a statue in Salisbury market-place, and a drinking fountain on the Thames embankment.

In economic matters Fawcett's position can best be described as transitional. He believed in co-operation almost as a panacea. In other matters he clung to the old *laissez-faire* theorists, and was a strong anti-socialist, with serious doubts about free education, though he supported the Factory Acts and wished their extension to agriculture. Apparent inconsistencies were harmonized to a great extent by his dominating anxiety to increase the well-being of the poor. One of his noblest traits was his kindness and genuine affection for the humble and oppressed, country labourers and the like, for whom his sympathies seemed always on the increase. Another was his disposition to interest himself in and to befriend younger men. In the great affliction of his youth Fawcett bore himself with a fortitude which it would be difficult to parallel. The effect of his blindness was, as the event proved, the reverse of calamitous. It brought the great aim and purpose of his life to maturity at an earlier date than would otherwise have been possible, and it had a mellowing influence upon his character of an exceptional and beneficent kind. As a youth he was rough and canny, with a suspicion of harshness. The kindness evoked by his misfortune, a strongly reciprocated family affection, a growing capacity for making and keeping friends—these and other causes tended to ripen all that was best, and apparently that only, in a strong but somewhat stern character. His acerbity passed away, and in later life was reserved exclusively for official witnesses before parliamentary committees. Frank, helpful, conscientious to a fault, a shrewd gossip, and a staunch friend, he was a man whom no one could help liking. Several of his letters to his father and mother at different periods of his career are preserved in Leslie Stephen's admirable *Life* (1885), and show a goodness of heart, together with a homely simplicity of nature, which is most touching. In appearance Fawcett was gaunt and tall, over 6 ft. 3 in. in height, large of bone, and massive in limb. (T. SE.)

FAWCETT, JOHN (1768–1837), English actor and playwright, was born on the 29th of August 1768, the son of an actor of the same name (d. 1793). At the age of eighteen he ran away from school and appeared at Margate as Courtall in *The Belle's Stratagem*; afterwards he joined Tate Wilkinson's company and turned from tragedy to low comedy parts. In 1791 he appeared at Covent Garden, and in 1794 at the Haymarket. Colman, then manager of that house, wrote a number of parts designed to suit his talents, and two of Fawcett's greatest successes were as Dr. Pangloss in *The Heir at Law* (1797) and as Dr Ollapod in *The Poor Gentleman* (1798). He retired from the stage in 1830.

FAWKES, FRANCIS (1720–1777), English poet and divine, was born at Warmsworth, near Doncaster, Yorkshire, where

his father was rector, and was baptized on the 4th of April 1720. After studying at Jesus College, Cambridge, where he graduated M.A. in 1745, he took holy orders, and was successively curate of Bramham, curate of Croydon, vicar of Orpington, and rector of Hayes, and finally was made one of the chaplains to the princess of Wales. His first publication is said to have been *Bramham Park, a Poem*, in 1745; a volume of poems and translations appeared in 1761; and *Partridge Shooting*, an eclogue, in 1764. His translations of the minor Greek poets—Anacreon, Sappho, Bion and Moschus, Musaeus, Theocritus and Apollonius—acquired for him considerable fame, but they are less likely to be remembered than his fine song, "Dear Tom, this brown jug, that now foams with mild ale." Fawkes died on the 26th of August 1777.

FAWKES, GUY (1570–1606), English "gunpowder plot" conspirator, son of Edward Fawkes of York, a member of a good Yorkshire family and advocate of the archbishop of York's consistory court, was baptized at St Michael le Belfrey at York on the 16th of April 1570. His parents were Protestants, and he was educated at the free school at York, where, it is said, John and Christopher Wright and the Jesuit Tesimond *alias* Greenway, afterwards implicated in the conspiracy, were his schoolfellows. On his father's death in 1579 he inherited his property. Soon afterwards his mother married, as her second husband, Dionis Baynbridge of Scotton in Yorkshire, to which place the family removed. Fawkes's stepfather was connected with many Roman Catholic families, and was probably a Roman Catholic himself, and Fawkes himself became a zealous adherent of the old faith. Soon after he had come of age he disposed of his property, and in 1593 went to Flanders and enlisted in the Spanish army, assisting at the capture of Calais by the Spanish in 1596 and gaining some military reputation. According to Father Greenway he was "a man of great piety, of exemplary temperance, of mild and cheerful demeanour, an enemy of broils and disputes, a faithful friend and remarkable for his punctual attendance upon religious observances," while his society was "sought by all the most distinguished in the archduke's camp for nobility and virtue." He is described as "tall, with brown hair and auburn beard."

In 1604 Thomas Winter, at the instance of Catesby, in whose mind the gunpowder plot had now taken definite shape, introduced himself to Fawkes in Flanders, and as "a confident gentleman," "best able for this business," brought him on to England as assistant in the conspiracy. Shortly afterwards he was initiated into the plot, after taking an oath of secrecy, meeting Catesby, Thomas Winter, Thomas Percy and John Wright at a house behind St Clement's (see GUNPOWDER PLOT and CATESBY, ROBERT). Owing to the fact of his being unknown in London, to his exceptional courage and coolness, and probably to his experience in the wars and at sieges, the actual accomplishment of the design was entrusted to Fawkes, and when the house adjoining the parliament house was hired in Percy's name, he took charge of it as Percy's servant, under the name of Johnson. He acted as sentinel while the others worked at the mine in December 1604, probably directing their operations, and on the discovery of the adjoining cellar, situated immediately beneath the House of Lords, he arranged in it the barrels of gunpowder, which he covered over with firewood and coals and with iron bars to increase the force of the explosion. When all was ready in May 1605 Fawkes was despatched to Flanders to acquaint Sir William Stanley, the betrayer of Deventer, and the intriguer Owen with the plot. He returned in August and brought fresh gunpowder into the cellars to replace any which might be spoilt by damp. A slow match was prepared which would give him a quarter of an hour in which to escape from the explosion. On Saturday, the 26th of October, Lord Monteagle (*q.v.*) received the mysterious letter which revealed the conspiracy and of which the conspirators received information the following day. They, nevertheless, after some hesitation, hoping that the government would despise the warning, determined to proceed with their plans, and were encouraged in their resolution by Fawkes, who visited the cellar on the 30th and

reported that nothing had been moved or touched. He returned accordingly to his lonely and perilous vigil on the 4th of November. On that day the earl of Suffolk, as lord chamberlain, visited the vault, accompanied by Monteagle, remarked the quantity of faggots, and asked Fawkes, now described as "a very tall and desperate fellow," who it was that rented the cellar. Percy's name, which Fawkes gave, aroused fresh suspicions and they retired to inform the king. At about ten o'clock Robert Keyes brought Fawkes from Percy a watch, that he might know how the anxious hours were passing, and very shortly afterwards he was arrested, and the gunpowder discovered, by Thomas Knyvett, a Westminster magistrate. Fawkes was brought into the king's bedchamber, where the ministers had hastily assembled, at one o'clock. He maintained an attitude of defiance and of "Roman resolution," smiled scornfully at his questioners, making no secret of his intentions, replied to the king, who asked why he would kill him, that the pope had excommunicated him, that "dangerous diseases require a desperate remedy," adding fiercely to the Scottish courtiers who surrounded him that "one of his objects was to blow back the Scots into Scotland." His only regret was the failure of the scheme. "He carrieth himself," writes Salisbury to Sir Charles Cornwallis, ambassador at Madrid, "without any feare or perturbation . . . ; under all this action he is noe more dismayed, nay scarce any more troubled than if he was taken for a poor robbery upon the highway," declaring "that he is ready to die, and rather wisheth 10,000 deaths, than willingly to accuse his master or any other." He refused stubbornly on the following days to give information concerning his accomplices; on the 8th he gave a narrative of the plot, but it was not till the 9th, when the fugitive conspirators had been taken at Holbeche, that torture could wring from him their names. His imperfect signature to his confession of this date, consisting only of his Christian name and written in a faint and trembling hand, is probably a ghastly testimony to the severity of the torture ("per gradus ad ima") which James had ordered to be applied if he would not otherwise confess and the "gentler tortures" were unavailing,—a horrible practice unrecognized by the law of England, but usually employed and justified at this time in cases of treason to obtain information. He was tried, together with the two Winters, John Grant, Ambrose Rokewood, Robert Keyes and Thomas Bates, before a special commission in Westminster Hall on the 27th of January 1606. In this case there could be no defence and he was found guilty. He suffered death in company with Thomas Winter, Rokewood and Keyes on the 31st, being drawn on a hurdle from the Tower to the Parliament House, opposite which he was executed. He made a short speech on the scaffold, expressing his repentance, and mounted the ladder last and with assistance, being weak from torture and illness. The usual barbarities practised upon him after he had been cut down from the gallows were inflicted on a body from which all life had already fled.

BIBLIOGRAPHY.—*Hist. of England*, by S. R. Gardiner, vol. i.; and the same author's *What Gunpowder Plot was* (1897); *What was the Gunpowder Plot?* by J. Gerard (1897); *The Gunpowder Plot*, by D. Jardine (1857); *Calendar of State Pap. Dom. 1603-1610*; *State Trials*, vol. ii.; *Archaeologia*, xii. 200; R. Winwood's *Memorials*; *Notes and Queries*, vi. ser. vii. 233, viii. 136; *The Fawkeses of York in the 16th Century*, by R. Davies (1850); *Dict. of Nat. Biog.* and authorities cited there. The official account (untrustworthy in details) is the *True and Perfect Relation of the Whole Proceedings against the late most Barbarous Traitors* (1606), reprinted by Bishop Barlow of Lincoln as *The Gunpowder Treason* (1679). See also GUNPOWDER PLOT.

The lantern said to be Guy Fawkes's is in the Bodleian library at Oxford. (P. C. Y.)

FÁY, ANDRÁS (1786-1864), Hungarian poet and author, was born on the 30th of May 1786, at Kohány in the county of Zemplin, and was educated for the law at the Protestant college of Sárospatak. His *Mesék* (*Fables*), the first edition of which appeared at Vienna in 1820, evinced his powers of satire and invention, and won him the well-merited applause of his countrymen. These fables, which, on account of their originality and simplicity, caused Fáy to be regarded as the Hungarian Aesop,

were translated into German by Petz (Raab, 1825), and partly into English by E. D. Butler, *Hungarian Poems and Fables* (London, 1877). Fáy wrote also numerous poems, the chief of which are to be found in the collections *Bokréta* (*Nosegay*) (Pest, 1807), and *Fris Bokréta* (*Fresh Nosegay*) (Pest, 1818). He also composed plays and romances and tales. In 1835 Fáy was elected to the Hungarian diet, and was for a time the leader of the opposition party. It is to him that the Pest Savings Bank owes its origin, and he was one of the chief founders of the Hungarian National theatre. He died on the 26th of July 1864. His earlier works were collected at Pest (1843-1844, 8 vols.). The most noteworthy of his later works is a humorous novel entitled *Jávör orvos és Bakator Ambros szolgáia* (*Jávör the Doctor and his servant Ambrose Bakator*), (Pest 1855, 2 vols.).

FAYAL (*Faial*), a Portuguese island in the Atlantic Ocean, forming part of the Azores archipelago. Pop. (1900) 22,262; area, 63 sq. m. Fayal, *i.e.* "the beech wood," was so called from the former abundance of the *Myrica faya*, which its discoverers mistook for beech trees. It is one of the most frequented of the Azores, for it lies directly in the track of vessels crossing the Atlantic, and has an excellent harbour at Horta (*q.v.*), a town of 6574 inhabitants. Cedros (3278) and Fêteira (2002) are the other chief towns. The so-called "Fayal wine," which was largely exported from the Azores in the 19th century, was really the produce of Pico, a larger island lying to the east. The women of Fayal manufacture fine lace from the agave thread. They also execute carvings in snow-white fig-tree pith, and carry on the finer kinds of basket-making. A small valley, called Flemengos, perpetuates the name of the Flemish settlers, who have left their mark on the physical appearance of the inhabitants. (See AZORES.)

FAYETTEVILLE, a city and the county-seat of Washington county, Arkansas, U.S.A., about 150 m. N.W. of Little Rock. Pop. (1890) 2942; (1900) 4061; (1910) 4471. It is served by the St Louis & San Francisco railway. The city lies about 1400 ft. above the sea, in the Ozark Mountain region. There is much fine scenery in the neighbourhood, there are mineral springs near by, and the place has become known as a summer resort. Fayetteville is the seat of the University of Arkansas (incorporated 1871; opened 1872; co-educational), which includes the following departments: at Fayetteville, a college of liberal arts, science and engineering, a conservatory of music and art, a preparatory school, and an agricultural college and agricultural experiment station; at Little Rock, a medical school and a law school, and at Pine Bluff, the Branch Normal College for negroes. In 1908 the university had 122 instructors and a total enrolment of 1725 students. In Fayetteville there are a National cemetery with 1236 soldiers' graves (782 "unknown") and a Confederate cemetery with 725 graves and a memorial monument. In the vicinity of Fayetteville there are deposits of coal; and the city is in a fine fruit-growing region, apples being the principal crop. Much of the surrounding country is still covered with timber. Among manufactures are lumber, spokes, handles, waggons, lime, evaporated fruit and flour.

The first settlement on the site of what is now Fayetteville was made between 1820 and 1825; when Washington county was created in 1828 the place became the county-seat, and it was called Washington Court-house until 1829, when it received its present name. The citizens of Fayetteville were mainly Confederate sympathizers; Fayetteville was raided by Federal cavalry on the 14th of July 1862, and was permanently occupied by Federal troops in the autumn of the same year. Confederate cavalry under Brigadier-General William Lewis Cabell attacked the city on the 18th of April 1863, but were driven off. The town was burned in August 1863, and shelled on the 3rd of November 1864, after the battle of Pea Ridge, by a detachment of General Price's army. Fayetteville was incorporated as a town in 1841, and in 1859 received a city charter, which was abolished by act of the Legislature in 1867; under a general law of 1869 the town was re-incorporated; and in 1906 it became a city of the first class.

FAYETTEVILLE, a city and the county-seat of Cumberland county, North Carolina, U.S.A., on the W. bank of the Cape Fear river (at the head of steamboat navigation), about 80 m. N.W. of Wilmington. Pop. (1890) 4222; (1900) 4670, including 2221 negroes; (1910) 7045. It is served by the Atlantic Coast Line railway and the short Raleigh & Southport railway, and by steamboat lines to Wilmington. A scheme was set on foot for the improvement by canalization of the Cape Fear river above Wilmington under a Federal project of 1902, which provided for a channel 8 ft. deep at low water from Wilmington to Fayetteville. Below Wilmington the improvement of the river channel, 270 ft. wide and 16 ft. deep, was completed in 1889, and the project of 1889 provided for an increase in depth to 20 ft. Pine forests surround the town, and oaks and elms of more than a century's growth shade its streets. Fayetteville has two hospitals (each with a training school for nurses), and is the seat of a state coloured normal school and of the Donaldson military school. Several creeks and the upper Cape Fear river furnish considerable water-power, and in or near Fayetteville are manufactories of cotton goods, silk, lumber, wooden-ware, turpentine, carriages, wagons, ploughs, edge tools and flour. In the earlier half of the 19th century Fayetteville was a great inland market for the western part of the state, for eastern Tennessee and for south-western Virginia. There is a large vineyard in the vicinity; truck-gardening is an important industry in the surrounding country; and Fayetteville is a shipping centre for small fruits and vegetables, especially lettuce, melons and berries. The municipality owns its water-works and its electric-lighting plant. The vicinity was settled between 1729 and 1747 by Highlanders, the settlement called Cross Creek lying within the present limits of Fayetteville. In 1762, by an act of the assembly, a town was laid out including Cross Creek, and was named Campbelltown (or "Campbelltown"); but in 1784, when Lafayette visited the town, its name was changed in his honour to Fayetteville, though the name Cross Creek continued to be used locally for many years. Flora McDonald, the famous Scottish heroine, came to Campbelltown in April 1775 with her husband and children, and here she seems to have lived during the remainder of that year. The general assembly of the state met at Fayetteville in 1787, 1788 and 1789 (Newbern, Tarboro, Hillsboro and Fayetteville all being rivals at this time for the honour of becoming the permanent capital); and in 1789 the Federal constitution was here ratified for North Carolina. In 1831 most of the town was burned. At the outbreak of the Civil War, the state authorities seized the United States Arsenal at Fayetteville, which contained 37,000 muskets and a complete equipment for a battery of light artillery. In March 1865 General W. T. Sherman and his army took possession of the town, destroyed the arsenal, and did considerable damage to property. Fayetteville was chartered as a city in 1893. A serious flood occurred in August 1908.

FAYRER, SIR JOSEPH, Bart. (1824-1907), English physician, was born at Plymouth on the 6th of December 1824. After studying medicine at Charing Cross hospital, London, he was in 1847 appointed medical officer of H.M.S. "Victory," and soon afterwards accompanied the 3rd Lord Mount-Edgcombe on a tour through Europe, in the course of which he saw fighting at Palermo and Rome. Appointed an assistant surgeon in Bengal in 1850, he went through the Burmese campaign of 1852 and was political assistant and Residency surgeon at Lucknow during the Mutiny. From 1859 to 1872 he was professor of surgery at the Medical College of Calcutta, and when the prince of Wales made his tour in India he was appointed to accompany him as physician. Returning from India, he acted as president of the Medical Board of the India office from 1874 to 1895, and in 1896 he was created a baronet. Sir Joseph Fayrer, who became a fellow of the Royal Society in 1877, wrote much on subjects connected with the practice of medicine in India, and was especially known for his studies on the poisonous snakes of that country and on the physiological effects produced by their virus (*Thanatophidia of India*, 1872). In 1900 appeared his *Recollections of my Life*. He died at Falmouth on the 21st of May 1907.

FAYUM, a mudiria (province) of Upper Egypt, having an area of 490 sq. m. and a population (1907) of 441,583. The capital, Medinet-el-Fayum, is 81 m. S.S.W. of Cairo by rail. The Fayum proper is an oasis in the Libyan Desert, its eastern border being about 15 m. west of the Nile. It is connected with that river by the Bahr Yusuf, which reaches the oasis through a gap in the hills separating the province from the Nile Valley. South-west of the Fayum, and forming part of the mudiria, is the Gharak depression. Another depression, entirely barren, the Wadi Rayan, covering 280 sq. m., lies west of the Gharak. The whole region is below sea-level, and save for the gap mentioned is encircled by the Libyan hills. The lowest part of the province, the north-west end, is occupied by the Birket el Kerun, or Lake of the Horns, whose surface level is 140 ft. below that of the sea. The lake covers about 78 sq. m.

Differing from the typical oasis, whose fertility depends on water obtained from springs, the cultivated land in the Fayum is formed of Nile mud brought down by the Bahr Yusuf. From this channel, 15 m. in length from Lahun, at the entrance of the gap in the hills, to Medina, several canals branch off and by these the province is irrigated, the drainage water flowing into the Birket el Kerun. Over 400 sq. m. of the Fayum is cultivated, the chief crops being cereals and cotton. The completion of the Assuan dam by ensuring a fuller supply of water enabled 20,000 acres of land, previously unirrigated and untaxed, to be brought under cultivation in the three years 1903-1905. Three crops are obtained in twenty months. The province is noted for its figs and grapes, the figs being of exceptionally good quality. Olives are also cultivated. Rose trees are very numerous and most of the attar of roses of Egypt is manufactured in the province. The Fayum also possesses an excellent breed of sheep. Lake Kerun abounds in fish, notably the *bulti* (Nile carp), of which considerable quantities are sent to Cairo.

Medinet el-Fayum (or Medina), the capital of the province, is a great agricultural centre, with a population which increased from 26,000 in 1882 to 37,320 in 1907, and has several large bazaars, mosques, baths and a much-frequented weekly market. The Bahr Yusuf runs through the town, its banks lined with houses. There are two bridges over the stream: one of three arches, which carries the main street and bazaar, and one of two arches over which is built the Kait Bey mosque. Mounds north of the town mark the site of Arsinoë, earlier Crocodilopolis, where was worshipped the sacred crocodile kept in the Lake of Moeris. Besides Medina there are several other towns in the province, among them Senuris and Tomia to the north of Medina and Senaru and Abuksa on the road to the lake, all served by railways. There are also, especially in the neighbourhood of the lake, many ruins of ancient villages and cities. The Fayum is the site of the Lake of Moeris (*q.v.*) of the ancient Egyptians—a lake of which Birket el Kerun is the shrunken remnant.

See *The Fayum and Lake Moeris*, by Major (Sir) R. H. Brown, R.E. (London, 1892), a valuable contribution as to the condition of the province at that date, its connexion with Lake Moeris and its possibilities in the future; *The Assuan Reservoir and Lake Moeris* (London, 1904), by Sir William Willcocks—with text in English, French and Arabic—a consideration of irrigation possibilities; *The Topography and Geology of the Fayum Province of Egypt*, by H. J. L. Beadnell (Cairo, 1905).

FAZOGLI, or FAZOKI, a district of the Anglo-Egyptian Sudan, cut by 11° N. and bounded E. and S. by Abyssinia. It forms part of the foot-hills of the Abyssinian plateau and is traversed by the Blue Nile and its affluent the Tumat. Immediately south is the auriferous Beni Shangul country. The chief gold-washings lie (in Abyssinian territory) on the west slope of the hills draining to the White Nile. Here is the steep Jebel-Dul, which appears to contain rich gold-bearing reefs, as gold is found in all the ravines on its flanks. The auriferous region extends into Sudanese territory, gold dust being found in all the khors coming from Jebel Faronge on the S.E. frontier. The inhabitants of Fazogli, who are governed, under the Sudan administration, by their own meks or kings, are Berta and other Shangalla tribes with an admixture of Funj blood, the country having been conquered by the Funj rulers of Sennar at the close of the 15th

century. There are also Arab settlements. Fazogli, the residence of the principal mek, is a straggling town built some 800 yds. from the left bank of the Blue Nile near the Tumat confluence, 434 m. by river above Khartum and opposite Famaka, the headquarters of the Egyptians in this region between 1839 and 1883. Above Famaka and near the Abyssinian frontier is the prosperous town of Kiri, while Abu Shaneina on the Nile below Fazogli is the spot where the trade route from Beni Shangul strikes the river. The chief imports from Abyssinia are coffee, cattle, transport animals and gold. Durra and tobacco are the principal crops. The local currency includes rings of gold, specially made as a circulating medium.

FEA, CARLO (1753-1836), Italian archaeologist, was born at Pigna in Piedmont on the 2nd of February 1753, and studied law in Rome. He received the degree of doctor of laws from the university of La Sapienza, but archaeology gradually absorbed his attention, and with the view of obtaining better opportunities for his researches in 1798 he took orders. For political reasons he was obliged to take refuge in Florence; on his return in 1799 he was imprisoned by the Neapolitans, at that time in occupation of Rome, as a Jacobin, but shortly afterwards liberated and appointed Commissario delle Antichità and librarian to Prince Chigi. He died at Rome on the 18th of March 1836.

Fea revised, with notes, an Italian translation of J. J. Winckelmann's *Geschichte der Kunst*, and also added notes to some of G. L. Bianconi's works. Among his original writings the principal are:—*Miscellanea filologica, critica, e antiquaria*; *L'Integrità del Panteone rivendicata a M. Agrippa*; *Frammenti di fasti consolari*; *Iscrizioni di monumenti pubblici*; and *Descrizione di Roma*.

FEARNE, CHARLES (1742-1794), English jurist, son of Charles Fearne, judge-advocate of the admiralty, was born in London in 1742, and was educated at Westminster school. He adopted the legal profession, but, though well fitted by his talents to succeed as a barrister, he neglected his profession and devoted most of his attention and his patrimony to the prosecution of scientific experiments, with the vain hope of achieving discoveries which would reward him for his pains and expense. He died in 1794, leaving his widow and family in necessitous circumstances. His *Essay on the Learning of Contingent Remainders and Executory Devises*, the work which has made his reputation as a legal authority, and which has passed through numerous editions, was called forth by a decision of Lord Mansfield in the case of *Perrin v. Blake*, and had the effect of reversing that decision.

A volume entitled *Fearne's Posthumous Works* was published by subscription in 1797 for the benefit of his widow.

FEASTS AND FESTIVALS. A festival or feast¹ is a day or series of days specially and publicly set apart for religious observances. Whether its occurrence be casual or periodic, whether its ritual be grave or gay, carnal as the orgies of Baal and Astarte, or spiritual as the worship of a Puritan Sabbath, it is to be regarded as a festival or "holy day" as long as it is professedly held in the name of religion.

To trace the festivals of the world through all their variations would be to trace the entire history of human religion and human civilization. Where no religion is, there can of course be no feasts; and without civilization any attempt at festival-keeping must necessarily be fitful and comparatively futile. But as religion develops, festivals develop with it, and assume their distinctive character; and an advancing civilization, at least in its earlier stages, will generally be found to increase their number, enrich their ritual, fix more precisely the time and order of their recurrence, and widen the area of their observance.

Some uncivilized tribes, such as the Juángs of Bengal; the Fuegians and the Andamanese, have been described as having no word for God, no idea of a future state, and consequently no religious ceremonies of any kind whatever. But such cases, doubtful at the best, are confessedly exceptional. In the vast majority of instances observed and recorded, the religiosity

¹ "To feast" is simply to keep a festum or festival. The etymology of the word is uncertain; but probably it has no connexion with the Gr. *ἑστιᾶν*.

of the savage is conspicuous. Even when incapable of higher manifestations, it can at least take the form of reverence for the dead; the grave-heap can become an altar on which offerings of food for the departed may be placed, and where in acts of public and private worship the gifts of survivors may be accompanied with praises and with prayers. That the custom of ghost-propiation by some sort of sacrifice is even now very widely diffused among the lower races at least, and that there are also many curious "survivals" of such a habit to be traced among highly civilized modern nations, has been abundantly shown of late by numerous collectors of folk-lore and students of sociology; and indications of the same phenomena can be readily pointed out in the Rig-Veda, the Zend-Avesta and the Pentateuch, as well as in the known usages of the ancient Egyptians, Greeks and Romans.² In many cases the ceremonial observed is of the simplest; but it ever tends to become more elaborate; and above all it calls for repetition, and repetition, too, at regular intervals. Whenever this last demand has made itself felt, a calendar begins to take shape. The simplest calendar is obviously the lunar. "The Naga tribes of Assam celebrate their funeral feasts month by month, laying food and drink on the graves of the departed." But it soon comes to be combined with the solar. Thus the Karens, "while habitually making oblations, have also annual feasts for the dead, at which they ask the spirits to eat and drink." The natives of the Mexican valley in November lay animals, edibles and flowers on the graves of their dead relatives and friends. The common people in China have a similar custom on the arrival of the winter solstice. The ancient Peruvians had the custom of periodically assembling the embalmed bodies of their dead emperors in the great square of the capital to be feasted in company with the people. The Athenians had their annual *Νεκύσια* or *Νεκύσεια* and the Romans their *Feralia* and *Lemuralia*. The Egyptians observed their three "festivals of the seasons," twelve "festivals of the month," and twelve "festivals of the half month," in honour of their dead. The Parsees, too, were required to render their afringans (blessings which were to be recited over a meal to which an angel or the spirit of a deceased person was invited) at each of the six seasons of the year, and also on certain other days.³

In the majority of recorded instances, the religious feeling of the savage has been found to express itself in other forms besides that of reverence towards the dead. The oldest literatures of the world, at all events, whether Aryan or Semitic, embody a religion of a much higher type than ancestor worship. The hymns of the Rig-Veda, for example, while not without traces of the other, yet indicate chiefly a worship of the powers of nature, connected with the regular recurrence of the seasons. Thus in iv. 57 we have a hymn designed for use at the commencement of the ploughing time;⁴ and in the *Aitareya-Bráhmaṇa*, the earliest treatise on Hindu ceremonial, we already find a complete series of sattras or sacrificial sessions exactly following the course of the solar year. They are divided into two distinct sections, each consisting of six months of thirty days each. The sacrifices are allowed to commence only at certain lucky constellations and in certain months. So, for instance, as a rule, no great sacrifice can commence during the sun's southern progress. The great sacrifices generally take place in spring, in the months of April and May.⁵ In the Parsee Scriptures⁶ the year is divided into six seasons or gahanbárs of two months each, concluding with February, the season at which "great expiatory sacrifices were offered for the growth of the whole creation in the last two months of the year." We have no means of knowing precisely what were the arrangements of the Phœnician calendar, but it

² See Spencer, *Principles of Sociology*, i. 170, 280, 306.

³ Haug, *Parsis*, 224, 225.

⁴ "May the heavens, the waters, the firmament, be kind to us; may the lord of the field be gracious to us . . . May the oxen (draw) happily, the men labour happily; may the traces bind happily, wield the goad happily" (Wilson's translation, iii. 224).

⁵ See Haug's *Aitareya-bráhmaṇam of the Rig-Veda*; Max Müller's *Chips from a German Workshop*, i. 115.

⁶ Visperad. See Haug, *Parsis*, 192; Richardson's *Dissertation on the Language, &c., of Eastern Nations*, p. 184; Morier's *Journey through Persia*.

is generally admitted that the worship was solar, the principal festivals taking place in spring and in autumn. Among the most characteristic celebrations of the Egyptians were those which took place at the *ἀφανισμός* or disappearance of Osiris in October or November, at the search for his remains, and their discovery about the winter solstice, and at the date of his supposed entrance into the moon at the beginning of spring. The Phrygian festivals were also arranged on the theory that the deity was asleep during the winter and awake during the summer; in the autumn they celebrated his retiring to rest, and in spring with mirth and revelry they roused him from his slumbers.¹ The seasonal character of the Teutonic Ostern, the Celtic Beltein and the Scandinavian Yule is obvious. Nor was the habit of observing such festivals peculiar to the Aryan or the Semitic race. The Mexicans, who were remarkable for the perfection of their calendar, in addition to this had an elaborate system of movable and immovable feasts distributed over the entire year; the principal festivals, however, in honour of their chief gods, Tezcatlipoca, Huitzilopochtli and Tlaloc, were held in May, June and December. Still more plainly connected with the revolutions of the seasons was the public worship of the ancient Peruvians, who, besides the ordinary feast at each new moon, observed four solar festivals annually. Of these the most important was the Yntip-Raymi (Sun-feast), which, preceded by a three days' fast, began with the summer solstice, and lasted for nine days. Its ceremonies have been often described. A similar but less important festival was held at the winter solstice. The Cusqui-Raymi, held after seedtime, as the maize began to appear, was celebrated with sacrifices and banquets, music and dancing. A fourth great festival, called Citua, held on the first new moon after the autumnal equinox, was preceded by a strict fast and special observances intended for purposes of purification and expiation, after which the festivities lasted until the moon entered her second quarter.

Greek Festivals.—Perhaps the annual Attic festival in honour of Erechtheus alluded to in the *Iliad* (ii. 550) ought to be regarded as an instance of ancestor-worship; but the seasonal character of the *ἑορτή* or new-moon feast in *Od.* xx. 156, and of the *θαλῶσια* or harvest-festival in *Il.* ix. 533, is generally acknowledged. The older Homeric poems, however, give no such express indications of a fully-developed system of festivals as are to be met with in the so-called "Homeric" hymns, in the *Works and Days* of Hesiod, in the pages of Herodotus, and so abundantly in most authors of the subsequent period; and it is manifest that the calendar of Homer or even of Herodotus must have been a much simpler matter than that of the Tarentines, for example, came to be, of whom we are told by Strabo that their holidays were in excess of their working days. Each demos of ancient Greece during the historical period had its own local festivals (*ἑορταὶ δημοτικάι*), often largely attended and splendidly solemnized, the usages of which, though essentially alike, differed very considerably in details. These details have in many cases been wholly lost, and in others have reached us only in a very fragmentary state. But with regard to the Athenian calendar, the most interesting of all, our means of information are fortunately very copious. It included some 50 or 60 days on which all business, and especially the administration of justice, was by order of the magistrates suspended. Among these *ἑορμηναίαι* were included—in Gamelion (January), the *Lenaea* or festival of vats in honour of Dionysus; in Anthesterion (February), the *Anthesteria*, also in honour of Dionysus, lasting three days (Pithoigia, Choes and Chytri); the *Diasia* in honour of Zeus, and the lesser *Eleusinia*; in Elaphebolion (March), the *Pandia* (? of Zeus), the *Elaphebolia* of Artemis, and the greater *Dionysia*; in Munychion, the *Munychia* of Artemis as the moon goddess (*Μουνυχία*) and the *Delphinia* of Apollo; in Thargelion (May), the *Thargelia* of Apollo and the *Plynteria* and *Callynteria* of Athena; in Scirophorion (June), the *Diipolia* of Zeus and the *Scirophoria* of Athena; in Hekatombaion, hecatombs were offered to Apollo the summer-god, and the *Cronia* of Cronus and the *Panathenaea*

¹ Plutarch, *De Iside et Osiride*; Macrobius, *Saturnalia*, i. 21.

of Athena were held; in Metageitnion, the *Metageitnia* of Apollo; in Boëdromion, the *Boëdromia* of Apollo the helper,² the *Nekusia* or *Nemeseia* (the festival of the dead), and the greater *Eleusinia*; in Pyanepsion, the *Pyanepsia* of Apollo, the *Oschophoria* of Dionysus (probably), the *Chalkeia* or *Atheneaea* of Athena, the *Thesmophoria* of Demeter, and the *Apaturia*; in Maimacterion, the *Maimacteria* of Zeus; and in Poseidcon (December), the lesser *Dionysia*.

Of these some are commemorative of historical events, and one at least may perhaps be regarded as a relic of ancestor-worship; but the great majority are nature-festivals, associating themselves in the manner that has already been indicated with the phenomena of the seasons, the equinoxes and the solstices.³ In addition to their numerous public festivals, the Greeks held various family celebrations, also called *ἑορταί*, in connexion with weddings, births and similar domestic occurrences. For the great national *πανηγύρεις*—Olympian, Pythian, Nemean and Isthmian—see the article GAMES, CLASSICAL.

Roman Festivals.—For the purpose of holding *comitia* and administering justice, the days of the Roman year were regarded as being either *dies fasti* or *dies nefasti*—the *dies fasti* being the days on which it was lawful for the praetors to administer justice in the public courts, while on the *dies nefasti* neither courts of justice nor meetings of *comitia* were allowed to be held. Some days were *fasti* during one portion and *nefasti* during another; these were called *dies intercesi*. For the purposes of religion a different division of the year was made; the days were treated as *festi* or as *profesti*,—the former being consecrated to acts of public worship, such as sacrifices, banquets and games, while the latter (whether *fasti* or *nefasti*) were not specially claimed for religious purposes. The *dies festi* or *feriae publicae*⁴ were either *stativae*, *conceptivae* or *imperativae*. The *stativae* were such as were observed regularly, each on a definite day; the *conceptivae* were observed annually on days fixed by the authorities for the time being; the *imperativae* were publicly appointed as occasion called for them. In the Augustan age the *feriae stativae* were very numerous, as may be seen from what we possess of the *Fasti* of Ovid. The number was somewhat fluctuating. Festivals frequently fell into desuetude or were revived, were increased or diminished, were shortened or prolonged at the will of the emperor, or under the caprice of the popular taste. Thus Augustus restored the Compitalia and Lupercalia; while Marcus Antoninus in his turn found it expedient to diminish the number of holidays.

The following is an enumeration of the stated festivals as given by Ovid and contemporary writers. The first day of January was observed somewhat as is the modern New Year's day: clients sent presents to their patrons, slaves to their masters, friends and relatives to one another. On the 9th the *Agonalia* were held, apparently in honour of Janus. On the 11th the *Carmentalia* were kept as a half-holiday, but principally by women; so also on the 15th. On the 13th of February were the *Faunalia*, on the 15th the *Lupercalia*, on the 17th the *Quirinalia*, on the 18th the *Feralia*, on the 23rd (at one time the last day of the Roman year) the *Terminalia*, on the 24th the *Regifugium* or *Fugalia*, and on the 27th the *Equiria* (of Mars). On the 1st of March were the *Matronalia*, on the 14th a repetition of the *Equiria*, on the 15th the festival of Anna Perenna, on the 17th the *Liberalia* or *Agonalia*, and from the 19th to the 23rd the *Quinquatria* (of Minerva). On the 4th of April were the *Megalesia* (of Cybele), on the 12th the *Cerealia*, on the 21st the *Palilia*, on the 23rd the *Vinalia*, on the 25th the *Robigalia*, and on the 28th the *Floralia*. The 1st of May was the festival of the *Lares Praestites*; on the 9th, 11th and 13th the *Lemuria* were celebrated; on the 12th the *Ludi Martiales*, and on the 15th those of Mercury. June 5 was sacred to *Semo Sancus*; the *Vestalia* occurred on the 9th, the *Matralia* on the 11th, and the

² In this month the anniversaries of the battle of Marathon, and of the downfall of the thirty tyrants, were also publicly celebrated.

³ See Schoemann, *Griechische Allertümer*, ii. 439 seq.; Mommsen, *Heortologie*.

⁴ *Feriae privatae*, such as anniversaries of births, deaths and the like, were observed by separate clans, families or individuals.

Quinquatrus Minusculae on the 13th. The *Ludi Apollinares* were on the 5th, and the *Neptunalia* on the 23rd of July. On the 13th of August were the *Nemoralia*, in honour of Diana; on the 18th the *Consualia*, on the 19th the *Vinalia Rustica*, and on the 23rd the *Vulcanalia*. The *Ludi Magni*, in honour of Jupiter, Juno and Minerva, began on September 4. The *Meditrinalia* (new wine) were on the 11th of October, the *Faunalia* on the 13th, and the *Equiria* on the 15th. The *Epulum Jovis* was on 13th November. The December festivals were—on the 5th *Faunalia*, and towards the close *Opalia*, *Saturnalia*, *Larentalia*.

The calendar as it stood at the Augustan age was known to contain many comparatively recent accessions, brought in under the influence of two "closely allied powers, the foreign priest and the foreign cook" (Mommsen). The *Megalesia*, for example, had been introduced 204 B.C. The *Ludi Apollinares* could not be traced farther back than 208 B.C. The *Floralia* and *Cerealia* had not come in much earlier. Among the oldest feasts were undoubtedly the *Lupercalia*, in honour of Lupercus, the god of fertility; the *Equiria*, in honour of Mars; the *Palilia*; the great September festival; and the *Saturnalia*.

Among the *feriae conceptivae* were the very ancient *feriae Latinae*, held in honour of Jupiter on the Alban Mount, and attended by all the higher magistrates and the whole body of the senate. The time of their celebration greatly depended on the state of affairs at Rome, as the consuls were not allowed to take the field until they had held the *Latinae*, which were regarded as days of a sacred truce. The *feriae secentivae* were held in the spring, and the *Ambarvalia* in autumn, both in honour of Ceres. The *Paganalia* of each *pagus*, and the *Compitalia* of each *vicus* were also *conceptivae*. Of *feriae imperativae*,—that is to say, festivals appointed by the senate, or magistrates, or higher priests to commemorate some great event or avert some threatened disaster,—the best known is the *Novendiale*, which used to be celebrated as often as stones fell from heaven (Livy xxi. 62, xxv. 7, &c.). In addition to all those already mentioned, there occasionally occurred *ludi votivi*, which were celebrated in fulfilment of a vow; *ludi funebres*, sometimes given by private persons; and *ludi seculares*, to celebrate certain periods marked off in the Etrusco-Roman religion.

Feasts of the Jews.—By Old Testament writers a festival or feast is generally called either חג (compare the Arabic Hadj), from חג to rejoice, or מִצְוָה , from צו , to appoint. The words חַגְגִּים and מִצְוֹת are also occasionally used. In the Talmud the three principal feasts are called $\text{שְׁלוֹשָׁת הַמִּצְוֹת}$, after Exod. xxiii. 14. Of the Jewish feasts which are usually traced to a pre-Mosaic origin the most important and characteristic was the weekly Sabbath, but special importance was also attached from a very early date to the lunar periods. It is probable that other festivals also, of a seasonal character, were observed (see Exod. v. 1). In common with most others, the Mosaic system of annual feasts groups itself readily around the vernal and autumnal equinoxes. In Lev. xxiii., where the list is most fully given, they seem to be arranged with a conscious reference to the sacred number seven (compare Numb. xxviii.). Those belonging to the vernal equinox are three in number; a preparatory day, that of the Passover, leads up to the principal festival, that of unleavened bread, which again is followed by an after-feast, that of Pentecost (see PASSOVER, PENTECOST). Those of the autumnal equinox are four; a preparatory day on the new moon of the seventh month (the Feast of Trumpets) is followed by a great day of rest, the day of Atonement (which, however, was hardly a *festival* in the stricter sense of the word), by the Feast of Tabernacles, and by a great concluding day (Lev. xxiii. 36; John vii. 37). If the feast of the Passover be excepted, it will be seen that all these celebrations or commemorations associate themselves more readily with natural than with historical events.¹ There was

¹ In the "parallel" passages, there is considerable variety in the designation and arrangement of these feasts. While Ex. xii. approximates most closely to Lev. xxiii. and Num. xxviii., Ex. xxiii. has stronger affinities with Deut. xvi. The relations of these passages are largely discussed by Graf, *Die geschichtlichen Bücher des A. T.*, pp. 34-41, and by other recent critics.

also a considerable number of post-Mosaic festivals, of which the principal were that of the Dedication (described in 1 Macc. iv. 52-59; comp. John x. 22) and that of Purim, the origin of which is given in the book of Esther (ix. 20 seq.). It has probably no connexion with the Persian festival Furdigán (see ESTHER).²

Earlier Christian Festivals.—While making it abundantly manifest that Christ and his disciples observed the appointed Jewish feasts, the New Testament nowhere records the formal institution of any distinctively Christian festival. But we have unambiguous evidence of the actual observance, from a very early period, of the first day of the week as a holy day (John xx. 19, 26; 1 Cor. xvi. 2; Acts xx. 7; Rev. i. 10). Pliny in his letter to Trajan describes the Christians of Bithynia as meeting for religious purposes on a set day; that this day was Sunday is put beyond all reasonable doubt by such a passage as that in the *Apology* of Justin Martyr, where he says that "on Sunday ($\tau\eta\ \tau\omicron\upsilon\ \eta\lambda\iota\omicron\upsilon\ \lambda\epsilon\gamma\omicron\mu\acute{\epsilon}\nu\eta\ \eta\mu\acute{\epsilon}\rho\alpha$) all the Christians living either in the city or the country met together." The Jewish element, in some churches at least, and especially in the East, was strong enough to secure that, along with the *dies dominica*, the seventh day should continue to be kept holy. Thus in the *Apostolic Constitutions* (ii. 59) we find the Saturday specially mentioned along with the Sunday as a day for the assembling of the church; in v. 15 it is ordained that there shall be no fasting on Saturday, while in viii. 33 it is added that both on Saturday and Sunday slaves are to have rest from their labours. The 16th canon of the council of Laodicea almost certainly means that solemn public service was to be held on Saturday as well as on Sunday. In other quarters, however, the tendency to regard both days as equally sacred met with considerable resistance. The 36th canon of the council of Illiberis, for example, deciding that Saturday should be observed as a fast-day, was doubtless intended to enforce the distinction between Saturday and Sunday. At Milan in Ambrose's time Saturday was observed as a [festival]; but Pope Innocent is found writing to the bishop of Eugubium to urge that it should be kept as a fast. Ultimately the Christian church came to recognize but one weekly festival.

The numerous yearly festivals of the later Christian church, when historically investigated, can be traced to very small beginnings. Indeed, while it appears to be tolerably certain that Jewish Christians for the most part retained all the festivals which had been instituted under the old dispensation, it is not at all probable that either they or their Gentile brethren recognized any yearly feasts as of distinctively Christian origin or obligation. It cannot be doubted, however, that gradually, in the course of the 2nd century, the universal church came to observe the anniversaries of the death and resurrection of Christ—the πάσχα σταυρώσιμον and the πάσχα ἀναστάσιμον , as they were respectively called (see EASTER and GOOD FRIDAY). Not long afterwards Whitsunday also came to be fixed in the usage of Christendom as a great annual festival. Even Origen (in the 8th book *Against Celsus*) enumerates as Christian festivals the Sunday, the παρασκευή , the Passover with the feast of the Resurrection, and Pentecost; under which latter term, however, he includes the whole period between Easter and Whitsuntide. About Cyprian's time we find individual Christians commemorating their departed friends, and whole churches commemorating their martyrs; in particular, there are traces of a local and partial observance of the feast of the Innocents. Christmas day and Epiphany were among the later introductions, the feast of the Epiphany being somewhat the earlier of the two. Both are alluded to indeed by Clemens Alexandrinus (i. 340), but only in a way which indicates that even in his time the precise date of Christ's birth was unknown, that its anniversary was not usually observed, and that the day of his baptism was kept as a festival only by the followers of Basilides (see EPIPHANY).

When we come down to the 4th century we find that, among the 50 days between Easter and Pentecost, Ascension Day has

² On the whole subject of Jewish festivals see Reland, *Antiq. Hebr.*; Knobel, *Leviticus* (c. 23); George, *Die jüdischen Feste*; Edersheim, *The Temple; its Ministry and Services*; Ewald, *Altertümer des Volkes Israel*; articles in Bible dictionaries.

come into new prominence. Augustine, for example, enumerates as anniversaries celebrated by the whole church those of Christ's passion, resurrection and ascension, along with that of the outpouring of the Holy Ghost, while he is silent with regard to Christmas and Epiphany. The general tendency of this and the following centuries was largely to increase the festivals of the Church, and by legislation to make them more fixed and uniform. Many passages, indeed, could be quoted from Chrysostom, Jerome and Augustine to show that these fathers had not by any means forgotten that comparative freedom with regard to outward observances was one of the distinctive excellences of Christianity as contrasted with Judaism and the various heathen systems (compare Socrates, *H.E.* v. 22). But there were many special circumstances which seemed to the leaders of the Church at that time to necessitate the permission and even legislative sanction of a large number of new feasts. The innovations of heretics sometimes seemed to call for rectification by the institution of more orthodox observances; in other instances the propensity of rude and uneducated converts from paganism to cling to the festal rites of their forefathers proved to be invincible, so that it was seen to be necessary to seek to adapt the old usages to the new worship rather than to abolish them altogether;¹ moreover, although the empire had become Christian, it was manifestly expedient that the old holidays should be recognized as much as possible in the new arrangements of the calendar. Constantine soon after his conversion enacted that on the *dies dominica* there should be no suits or trials in law; Theodosius the Great added a prohibition of all public shows on that day, and Theodosius the younger extended the prohibition to Epiphany and the anniversaries of martyrdoms, which at that time included the festivals of St Stephen, and of St Peter and St Paul, as also that of the Maccabees. In the 21st canon of the council of Agde (506), besides Easter, Christmas, Epiphany, Ascension and Pentecost, we find the Nativity of John the Baptist already mentioned as one of the more important festivals on which attendance at church was regarded as obligatory. To these were added, in the centuries immediately following, the feasts of the Annunciation, the Purification, and the Assumption of the Virgin; as well as those of the Circumcision, of St Michael and of All Saints.

Festivals were in practice distinguished from ordinary days in the following ways: all public and judicial business was suspended,² as well as every kind of game or amusement which might interfere with devotion; the churches were specially decorated; Christians were expected to attend public worship, attired in their best dress; love feasts were celebrated, and the rich were accustomed to show special kindness to the poor; fasting was strictly forbidden, and public prayers were said in a standing posture.

Later Practice.—In the present calendar of the Roman Catholic Church the number of feast days is very large. Each is celebrated by an appropriate office, which, according to its character, is either duplex, semi-duplex or simplex. A duplex again may be either of the first class or of the second, or a major or a minor. The distinctions of ritual for each of these are given with great minuteness in the general rubrics of the breviary; they turn chiefly on the number of Psalms to be sung and of lessons to be read, on the manner in which the antiphons are to be given and on similar details. The duplicia of the first class are the Nativity, the Epiphany, Easter with the three preceding and two following days, the Ascension, Whitsunday and the two following days, Corpus Christi, the Nativity of John Baptist, Saints Peter and Paul, the Assumption of the Virgin, All Saints, and, for each church, the feast proper to its patron or title and the feast of its dedication. The duplicia of the second class are the Circumcision, the feast of the Holy Name of Jesus, of the Holy Trinity, and of the Most Precious Blood of Christ, the feasts of the Purifica-

tion, Annunciation, Visitation, Nativity and Conception of the Virgin, the Natalitia of the Twelve Apostles, the feasts of the Evangelists, of St Stephen, of the Holy Innocents, of St Joseph and of the Patrocinium of Joseph, of St Lawrence, of the Invention of the Cross and of the Dedication of St Michael. The *Dominicae majores* of the first class are the first Sunday in Advent, the first in Lent, Passion Sunday, Palm Sunday, Easter Sunday, Dominica in Albis, Whitsunday and Trinity Sunday; the *Dominicae majores* of the second class are the second, third and fourth in Advent, Septuagesima, Sexagesima and Quinquagesima Sundays, and the second, third and fourth Sundays in Lent.

In the canons and decrees of the council of Trent repeated allusions are made to the feast days, and their fitness, when properly observed, to promote piety. Those entrusted with the cure of souls are urged to see that the feasts of the Church be devoutly and religiously observed, the faithful are enjoined to attend public worship on Sundays and on the greater festivals at least, and parish priests are bidden to expound to the people on such days some of the things which have been read in the office for the day. Since the council of Trent the practice of the Church with respect to the prohibition of servile work on holidays has varied considerably in different Catholic countries, and even in the same country at different times. Thus in 1577, in the diocese of Lyons, there were almost forty annual festivals of a compulsory character. By the concordat of 1802 the number of such festivals was for France reduced to four, namely, Christmas day, Ascension day, the Assumption of the Virgin, and All Saints day.

The calendar of the Greek Church is even fuller than that of the Latin, especially as regards the *ἑορταὶ τῶν ἀγίων*. Thus on the last Sunday in Advent the feast of All Saints of the Old Covenant is celebrated; while Adam and Eve, Job, Elijah, Isaiah, &c., have separate days. The distinctions of ritual are analogous to those in the Western Church. In the Coptic Church there are seven great festivals, Christmas, Epiphany, the Annunciation, Palm Sunday, Easter Sunday, Ascension and Whitsunday, on all of which the Copts "wear new clothes (or the best they have), feast and give alms" (Lane). They also observe, as minor festivals, Maundy Thursday, Holy Saturday, the feast of the Apostles (11th July), and that of the Discovery of the Cross.

In common with most of the churches of the Reformation, the Church of England retained a certain number of feasts besides all Sundays in the year. They are, besides Monday and Tuesday both in Easter-week and Whitsun-week, as follows: the Circumcision, the Epiphany, the Conversion of St Paul, the Purification of the Blessed Virgin, St Matthias the Apostle, the Annunciation of the Blessed Virgin, St Mark the Evangelist, St Philip and St James (Apostles), the Ascension, St Barnabas, the Nativity of St John Baptist, St Peter the Apostle, St James the Apostle, St Bartholomew, St Matthew, St Michael and all Angels, St Luke the Evangelist, St Simon and St Jude, All Saints, St Andrew, St Thomas, Christmas, St Stephen, St John the Evangelist, the Holy Innocents. The 13th canon enjoins that all manner of persons within the Church of England shall from henceforth celebrate and keep the Lord's day, commonly called Sunday, and other holy days, according to God's holy will and pleasure, and the orders of the Church of England prescribed in that behalf, that is, in hearing the Word of God read and taught, in private and public prayers, in acknowledging their offences to God and amendment of the same, in reconciling themselves charitably to their neighbours where displeasure hath been, in oftentimes receiving the communion of the body and blood of Christ, in visiting of the poor and sick, using all godly and sober conversation. (Compare Hooker, *E.P.* v. 70.) In the *Directory for the Public Worship of God* which was drawn up by the Westminster Assembly, and accepted by the Church of Scotland in 1645, there is an appendix which declares that there is no day commanded in Scripture to be kept holy under the gospel but the Lord's day, which is the Christian Sabbath; festival days, vulgarly called holy-days, having no warrant in the Word of God,

¹ As, at a later period (601), Gregory the Great instructed his Anglo-Saxon missionaries so to Christianize the temples, festivals, &c., of the heathen "ut durae mentes gradibus vel passibus, non autem saltibus, cleventur."

² Manumission, however, was lawful on any day.

are not to be continued; nevertheless it is lawful and necessary, upon special emergent occasions, to separate a day or days for public fasting or thanksgiving, as the several eminent and extraordinary dispensations of God's providence shall administer cause and opportunity to his people.

Several attempts have been made at various times in western Europe to reorganize the festival system on some other scheme than the Christian. Thus at the time of the French Revolution, during the period of Robespierre's ascendancy, it was proposed to substitute a tenth day (*Décadi*) for the weekly rest, and to introduce the following new festivals: that of the Supreme Being and of Nature, of the Human Race, of the French people, of the Benefactors of Mankind, of Freedom and Equality, of the Martyrs of Freedom, of the Republic, of the Freedom of the World, of Patriotism, of Hatred of Tyrants and Traitors, of Truth, of Justice, of Modesty, of Fame and Immortality, of Friendship, of Temperance, of Heroism, of Fidelity, of Unselfishness, of Stoicism, of Love, of Conjugal Fidelity, of Filial Affection, of Childhood, of Youth, of Manhood, of Old Age, of Misfortune, of Agriculture, of Industry, of our Forefathers, of Posterity and Felicity. The proposal, however, was never fully carried out, and soon fell into oblivion.

Mahommedan Festivals.—These are chiefly two—the 'Eed es-Sagheer (or minor festival) and the 'Eed el-Kebeer (or great festival), sometimes called 'Eed el-Kurban. The former, which lasts for three days, immediately follows the month Ramadan, and is generally the more joyful of the two; the latter begins on the tenth of Zu-l-Heggeh (the last month of the Mahommedan year), and lasts for three or four days. Besides these festivals they usually keep holy the first ten days of Moharram (the first month of the year), especially the tenth day, called Yom Ashoora; the birthday of the prophet, on the twelfth day of the third month; the birthday of El-Hoseyn, in the fourth month; the anniversary of the prophet's miraculous ascension into heaven, in the seventh month; and one or two other anniversaries. Friday, called the day of El-Gumah (the assembly), is a day of public worship; but it is not usual to abstain from public business on that day except during the time of prayer.

Hindu and Buddhist Festivals.—In modern India the leading popular festivals are the Holi, which is held in March or April and lasts for five days, and the Dasahara, which occurs in October. Although in its origin Buddhism was a deliberate reaction against all ceremonial, it does not now refuse to observe festivals. By Buddhists in China, for example, three days in the year are especially observed in honour of the Buddha,—the eighth day of the second month, when he left his home; the eighth day of the fourth month, the anniversary of his birthday; and the eighth of the twelfth, when he attained to perfection and entered Nirvāna. In Siam the eighth and fifteenth days of every month are considered holy, and are observed as days for rest and worship. At Trut, the festival of the close of the year, visiting and play-going are universal. The new year (January) is celebrated for three days; in February is another holiday; in April is a sort of Lent, ushering in the rainy season; on the last day of June presents are made of cakes of the new rice; in August is the festival of the angel of the river, "whose forgiveness is then asked for every act by which the waters of the Meinam have been rendered impure." See Bowring's *Siam* and Carné's *Travels in Indo-China and the Chinese Empire*. Copious details of the elaborate festival-system of the Chinese may be found in Doolittle's *Social Life of the Chinese*.

LITERATURE.—For Christian feasts see K. A. H. Kellner, *Heortologie* (Freiburg im Breisgau, 1906); Hippolyte Delehaye, *Les Légendes hagiographiques* (Brussels, 1905); J. Rendel Harris, *The Cult of the Heavenly Twins* (Cambridge, 1906); de Rossi-Duchesne, *Martyrologium Hieronymianum*.

FEATHER (O. Eng. *fether*, Ger. *Feder*, from an Indo-European root seen also in Gr. *πτερόν*, and *πέρεσθαι*, to fly), a horny outgrowth of the skin of birds homologous with the scale of the reptile. The body-covering of birds is, without exception, comprised of feathers, and by this character alone birds may be distinguished from all other animals.

The most perfect form of feather is made up of a long, tapering

rod, fringed on either side, for the greater part of its length, by a secondary series of slender and tapering rods forming a more or less acute angle with the central axis. This fringe is known as the *vexillum* or "vane" (fig. 1 a). The central axis is divisible into two distinct parts,—a hollow, cylindrical, transparent *calamus*, or "quill," the base of which is inserted into the skin, and a solid, quadrangular *rachis* or "shaft" which supports the vane. At the lower end of the quill is a small hole—the lower *umbilicus*—through which the nutritive pulp passes during the growth of the feather: while at the upper end, where it passes into the shaft, a similar hole will be found,—the upper *umbilicus*—and from this the last remains of the capsules which contained the nutritive pulp may sometimes be seen protruding. If the quill is cut open a series of these capsules will be found fitting one into the other throughout the whole length of the tubular chamber.

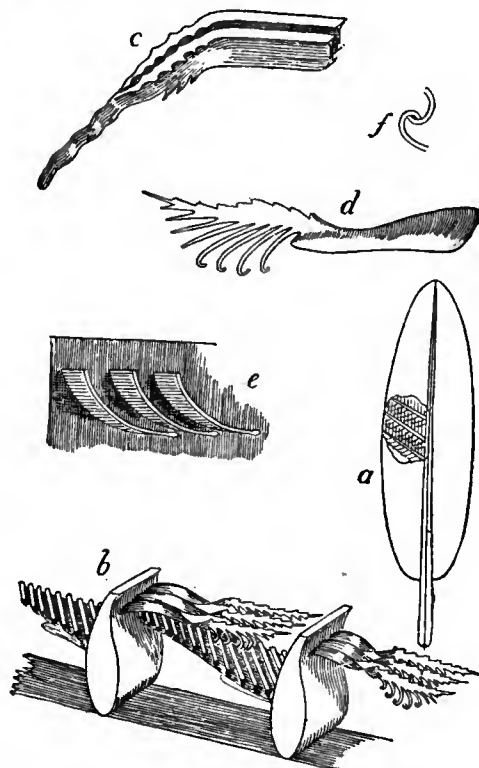

FIG. 1.—Diagrams of Feather-Barbs.

- a, Outline of a feather showing the relation of the barbs and barbules to the central axis or shaft.
 b, Section across two of the barbs shown in a, highly magnified.
 c, Two barbules of the posterior series—seen only in cross-section in b.
 d, A barbule of the anterior series.
 e, Section across the base of three anterior barbules showing attachment to barb.
 f, A portion of the hooklet of the anterior series showing the method of interlocking with the barbules of the posterior series.

The rods comprising the lateral fringe, or vane, are known as the *rami* or the "barbs," and will be found, on microscopic examination, to be lath-shaped and to taper to a point. Further, each barb supports a double series of smaller outgrowths known as the *radii*, or "barbules"; so that each barb may be likened to a feather in miniature. These "barbules," however, differ markedly in structure on the two sides of the barb, those pointing towards the tip of the feather—the "anterior barbules"—being ribbon-shaped from the base outwards for about half their length, when they become cut up to form a series of long and very delicate hooklets (fig. 1 d). On the opposite side of the barb the barbules are also ribbon-shaped for about half their length, but the ribbon is curved trough-fashion, so that the whole series of posterior barbules forms a number of deep valleys, and into these the hooklets are thrust so as to catch hold of the upper edges of the troughs, which are set so that the

upper edge is towards the upper, and the lower edge towards the under surface of the feather. The manner in which this beautiful mechanism works may be seen in fig. 1 b.

In one of the primary or "quill" feathers of the wing of a crane, each barb of the inner side of the vane was found to bear about 600 pairs of barbules, which would make about 800,000 barbules for the inner web of the vane alone, or more than a million for the whole feather (H. F. Gadow). It is to the agency of these hooklets alone that the closely-knit, elastic vanes of the flight feathers and the body feathers are due. Where these hooklets are wanting the barbs do not adhere together, resulting in a loose "discontinuous" vane such as, for example, is found in the plumes of the ostrich.

Many feathers, in addition to the main axis, bear a second, generally much shorter axis, supporting a loose discontinuous vane; this shorter branch is known as the "aftershaft" and arises from the under surface of the feather. Only in the cassowary and emu among adult birds is the aftershaft as large as the main shaft.

There are several different kinds of feathers—contour feathers, semiplumes, down-feathers, filoplumes and powder-down. Contour feathers, as their name implies, are those which form the contour or outline of the body, and are all that can generally be seen. Those which form the "flight feathers" of the wing, and the tail feathers, are the most perfectly developed. Semiplumes are degenerate contour feathers. The down-feathers are generally completely hidden by the contour feathers: they form in many birds, such as gulls and ducks, a thick underclothing comparable to the under-fur of mammals such as the seals. In all cases they are of a loose, soft, "fluffy" structure, the barbs being of great length and slenderness, while the barbules are often long and provided with knob-like thickenings answering to the hooklets of the more perfectly developed contour feathers; these thickenings help to "felt" the separate down-feathers together, the barbs of one down-feather interlocking with those of its neighbour. Down-feathers differ from semiplumes both in their relation to contour feathers and in that they do not possess a main axis, all the barbs arising from a common centre.

Filoplumes are degenerate structures having a superficial resemblance to hairs, but they always bear a minute vane at the tip. They occur in all birds, in clusters of varying number, about the bases of contour feathers. In some birds they attain a great length, and may project beyond the contour feathers, sometimes forming conspicuous white patches, as for example in the necks of cormorants. In their early stages of development they often possess a large aftershaft made up of a number of barbs, but these quickly disappear, leaving only the degenerate main shaft. The eyelashes and bristles round the mouth found in many birds appear to be akin to filoplumes.

Powder-down feathers are degenerate down-feathers which appear to secrete a dry, waxy kind of powder. This powder rapidly disintegrates and becomes distributed over the plumage, adding thereto a quite peculiar bloom. In birds of the heron tribe powder-down feathers have reached a high degree of development, forming large patches in the breast and thighs, while in some hawks, and in the parrots, these mysterious feathers are scattered singly over the greater part of the body.

The nature of the covering of nestling birds is of a more complex character than has hitherto been suspected. The majority of young birds, as is well known, either emerge from the egg clothed in down-feathers, or they develop these within a day or two afterwards. But this covering, though superficially similar in all, may, as a matter of fact, differ widely in its constitution, even in closely related forms, while only in a very few species can the complete history of these feathers be made out.

The brown or tawny owl (*Syrnium aluco*) is one of these. At hatching, the young of this species is thickly clad in white, woolly down-feathers, of the character known as umbelliform—that is to say, the central axis or main shaft is wanting, so that the barbs all start from a common centre. These feathers

occupy the position of the ultimate contour feathers. They are shortly replaced by a second down-like covering, superficially resembling, and generally regarded as, true down. But they differ in that their barbs spring from a central axis as in typical contour feathers. Feathers of this last description indeed have now made their appearance in the shape of the "flight" or quill feathers (*remiges*) and of the tail feathers. This plumage is worn until the autumn, when the downy feathers give place to the characteristic adult plumage. The down feathers which appear at hatching-time are known as *pre-pennae*, or *pre-plumulae*, as the case may be; the first generation of pre-pennae, in the case of the tawny owl for example, is made up of *protoptyles*, while the succeeding plumage is made up of *mesoptyles*, and these in turn give place to the *teleoptyles* or adult feathers. The two forms of nestling plumage—pre-pennae and pre-plumulae—may be collectively called "neossoptyles," a term coined by H. F. Gadow to distinguish the plumage of the nestling from that of the adult—the "teleoptyle" plumage.

As a rule the nestling develops but one of these generations of neossoptyles, and this generally answers to the mesoptyle plumage, though this is of a degenerate type. In some birds, as in the Megapodes, the "protoptyle" or first of these two generations of pre-pennae is developed and shed while the chick is yet in the shell, so that at hatching the mesoptyle plumage is well developed. But in the majority of birds, probably, the mesoptyle plumage only is developed, while the earlier, and apparently more degenerate, dress is suppressed. In the penguins both of these nestling plumages are developed, but the mesoptyle dress has degenerated so that umbelliform feathers now take the place of feathers having a central axis.

The Anatidae show traces of the earlier, first generation of feathers in one or two species only, e.g. *Cloëphaga rubidiceps*. In all the remaining species mesoptyles only occur. And this is true also of the game-birds. In both the Tinamous, the duck-tribe and the game-birds this mesoptyle plumage shows, in different species, every gradation between feathers having a well-developed main shaft and aftershaft, and those which are mere umbelliform tufts.

As development proceeds and the contour feathers make their appearance they thrust the mesoptyle feathers out of their follicles—the pockets in the skin in which they were rooted—and these will often be found adhering to the tips of the contour feathers for many weeks after the bird has left the nest. This occurs because the development of the contour feather begins before that of the mesoptyles has completed.

The plumage in nestling birds is still further complicated by the fact that it may be almost, or entirely, composed of pre-plumulae; that is to say, of down-feathers which are later succeeded by adult down-feathers. This is the case among the accipitrine birds for example, and thereby it differs entirely from that of the owls, which develop neither pre-plumulae nor adult down. The cormorants are, so far as is known, the only birds which have a nestling plumage composed entirely of pre-plumulae.

In variety and brilliancy the colours of birds are not surpassed by those of any other group of animals. Yet the pigments to which these colours are due are but few in number, while a large number of the most resplendent hues are produced by structural peculiarities of the colourless horny surface of the feathers, and hence are known as subjective or optical colours.

The principal colour pigments are (a) *melanin* pigments, derived possibly from the haemoglobin of the blood, but more probably from the blood plasma, and (b) *lipochrome* or "fat" pigments, which are regarded as reserve products; though in the case of birds it is exceedingly doubtful whether they have this significance.

The melanin pigments (*zoomelanin*) occur in the form of granules and give rise to the black, brown and grey tones; or they may combine with those of the lipochrome series.

The lipochrome pigments (*zoonerythrin* and *zooxanthin*) tend to be diffused throughout the substance of the feather, and give rise respectively to the red and yellow colours.

The colours of feathers.

Nestling down.

In addition to these must be reckoned *turacin*, a reddish-purple pigment consisting of the same elements as zoomelanin, but remarkable for the fact that it contains from 5 to 8% of copper, which can be extracted by a weak alkaline solution, such as ammonia, and with the addition of acetic acid it can be filtered off as a metallic red or blue powder. The presence of metallic copper is indicated by the green flame of these red feathers when burnt. Turacin was discovered by Sir A. H. Church in the quill-feathers of the wings of Touracoes or "plantain eaters." These feathers, he showed, lose their colour after they have become wet, but regain it on drying. But turacin is not, as was supposed, confined to the feathers of the plantain eaters, since it has been obtained from a cuckoo, *Dasylophus superciliosus*.

What effect food may have on colour in birds in a wild state we have no means of knowing, but it is significant that flamingoes and linnets in confinement never regain their bright hues after their first moult in captivity. If cayenne pepper be mixed with the food of certain strains of canaries, from the time the birds are hatched onwards, the yellow colour of the feathers becomes intensified, till it takes on a deep orange hue. Bullfinches, if fed on hemp-seed, turn black. According to Darwin, the natives of the Amazonian region feed the common green parrot on the fat of large Siluroid fishes, and as a result the feathers become beautifully variegated with red and yellow. Similarly, in the Malay Archipelago, the natives of Giolo change the colours of another parrot.

With but rare exceptions bright colours are confined to the exposed portions of the plumage, but in some of the Bustards the down is of a bright pink colour.

Structural colours include all metallic or prismatic colours, blue, green, white, some yellows, and, in part, glossy black.

In metallic feathers the radii (barbules) are modified in various ways, frequently to form flattened, overlapping plates or tiles, while the surfaces of the plates are either smooth, finely striated or pitted. But, save only in the case of white feathers, beneath this colourless, glazed outer coat there is always a layer of pigment.

The only green pigment known to occur in feathers is *turacoverdin*, found in the feathers of the plantain eaters; it contains a relatively large amount of iron, but no copper. In all other cases the green colour of feathers is due to yellow, orange or greyish-brown pigment occurring with a special superstructure consisting of narrow ridges, as in some parrots and pittas (ant-brushes), or the surface of the barbs and barbules is smooth and transparent, while between it and the pigment there exists a layer of small polygonal, colourless bodies having highly refractory, and often striated, surfaces.

Blue is unknown as a pigment in feathers. Blue feathers contain only orange or brownish pigment (Gadow), the blue colour being caused by the combination of pigment corpuscles and colourless striated polygonal bodies, as in green feathers.

While in many birds the coloration takes the form either of a uniform hue or of bands and patches of colour more or less brilliant, in others the coloration is sombre, and made up of dark longitudinal stripes or transverse bars on a lighter ground. The latter is the more primitive, and there seems good reason to believe that longitudinal stripes preceded transverse bars. This is indicated by the fact that the nestlings of the more primitive groups are longitudinally striped, and that young hawks in their first plumage are so striped, while the adults are barred.

There is also evidence to show that the evolution of brilliant plumage began with the males, and has, in many cases, been more or less perfectly acquired by the females, and also by the young, as for example in the kingfishers, where parents and offspring wear the same livery. Often, where the parents are alike in plumage, the young wear a different and duller livery, as in the case of the common starling (*Sturnus vulgaris*). But where the female differs from the male in coloration the young resemble the female parent.

The physiological explanation of complete disappearance of pigment in adult life, e.g. gannet, is not yet apparent.

At least once annually birds renew their feathers completely by a process known as a moult. Until the new feathers have attained at least half their full length they are invested in a soft sheath, and, as development proceeds, the sheath breaks up from the tip of the feather downwards, so that for a time the new feathers have almost a brush-like appearance. Generally this replacement takes place gradually, new and old feathers occurring side by side, and on this account it is not always possible to see whether a moult is proceeding without raising the old feathers.

The "quill" feathers of the wing and tail are renewed in pairs, so that flight is little, if at all, impaired, the change taking place in the wing from the region of the wrist inwards, as to the primaries, and from the body outwards, towards the tip of the wing, as to the secondaries. In certain birds, however, as in the duck tribe and the rails, for example, all the quill-feathers of the wing are shed at once, so that for some time flight is impossible.

In the penguins this simultaneous method of moulting is carried still further. That is to say, the old feathers covering the body are not replaced gradually, but *en masse*. This method of ecdysis is, however, still further remarkable in that the old feathers do not drop out, to be succeeded by spine-like stumps which, later, split at the tip, liberating the barbs of the new feathers. They are, on the contrary, thrust out upon the tips of the new feathers, the barbs of which are never enclosed within an envelope such as that just described. When their growth has practically completed, and not till then, the old feathers are removed in large patches by the aid of the bird's beak; exposing thereby a perfectly developed plumage. In the cassowary, and emeu, the old feathers similarly adhere for a time to the tips of the new; but in these birds the feathers are moulted singly as in other birds.

Some birds moult twice within the year, the additional moult taking place in the spring, as in the case of the "warblers" (Sylviidae) and Limicolae, for example. But when this is the case the spring moult is only partial, since the quill feathers of the wings and the tail feathers are not renewed.

At this spring moult a special "nuptial" plumage is often assumed, as for example in many of the Limicolae, e.g. godwits, knots, dunlin, ruff.

The sequel to this habit of assuming a nuptial dress is an interesting one. Briefly, this plumage, at first assumed at the mating period by the males only, and doffed soon after the young appear, has become retained for longer and longer periods, so that the succeeding plumage, often conspicuously dull compared with the nuptial dress, is worn only for a few weeks, instead of many months, as in the case of many of the ducks, for example; wherein the males, as soon as the young are hatched, assume what C. Waterton has aptly called an "eclipse" dress. This, instead of being worn till the following spring, as in the waders, is shed again in the autumn and replaced by what answers to the waders' "nuptial" dress. In the game-birds but a trace of this "eclipse" plumage remains; and this, apparently, only in jungle-fowl, the common grey partridge (*Perdix cinerea*) and the blackcock (*Lyrurus*), in whose case the head and neck for a short period following the breeding season are clothed only by dull feathers. Further, this more highly developed plumage becomes transferred, first to the female, then to the young, so that, in many groups, the dull phase of plumage is entirely eliminated.

But the assumption at the breeding season of a conspicuously brilliant plumage is not always due to a moult. In many birds, notably many Passerines, this change is brought about by shedding the tips of the feathers, which are of a duller hue than the rest of the feather. In this way the bright rose pink of the linnet's breast, the blue and black head of the chaffinch, and the black throat and chestnut-and-black markings of the back of the sparrow, are assumed—to mention but a few instances. These birds moult but once a year, in the autumn, when the new feathers have broad brown fringes; as the spring advances these drop off, and with them the barbicels from the barbules

of the upper surface of the feather, thus revealing the hidden tints.

According to some authorities, however, some birds acquire a change of colour without a moult by the ascent of pigment from the base of the feather. The black head assumed by many gulls in the spring is, for example, said to be gained in this way. There is, however, not only no good evidence in support of the contention, but the whole structure of the feather is against the probability of any such change taking place.

Feathers correspond with the scales of reptiles rather than with the hairs of mammals, as is shown by their development. They make their first appearance in the developing chick about the sixth day of incubation, in the shape of small papillae. In section each papilla is found to be made up of a cluster of dermal cells—that is to say, of cells of the deeper layer of the skin—capped by cells of the epidermis. These last form a single superficial layer of flattened cells—the *epitrichium*—overlying the cells of the Malpighian layer, which are cylindrical in shape and rapidly increase to form several layers. As development proceeds the papillae assume a cone-shape with its apex directed backwards, while the base of this cone sinks down into the skin, or rather is carried down by the growth of the Malpighian cells, so that the cone is now sunk in a deep pit. Thereby these Malpighian cells become divided into two portions: (1) those taking part in the formation of the walls of the pit or "feather follicle," and (2) those enclosed within the cone. These last surround the central mass or core formed by the dermis. This mass constitutes the nutritive pulp for the development of the growing feather, and is highly vascular. The cells of the Malpighian layer within the cone now become differentiated into three layers. (1) An inner, extremely thin, forming a delicate sheath for the pulp, and found in the fully developed feather in the form of a series of hollow, transparent caps enclosed within the calamus; (2) a thick layer which forms the feather itself; and (3) a thin layer which forms the investing sheath of the feather. It is this sheath which gives the curious spine-covered character to many nestling birds and birds in moult. As growth proceeds the cells of this middle layer arrange themselves in longitudinal rows to form the barbules, while the barbules are formed by a secondary splitting. At their bases these rudimentary barbs meet to form the calamus. Finally the tips of the barbs break through the investing sheath and the fully formed down-feather emerges.

A part of the pulp and Malpighian cells remains over after the complete growth of the down-feather, and from this succeeding generations of feathers are developed. The process of this development differs from that just outlined chiefly in this: that of the longitudinal rows which in the down-feather form the barbs, two on the dorsal and two on the ventral aspect of the interior of the cylinder become stronger than the rest, combining to form the main- and after-shaft respectively. The remainder of the rods form the barbs and barbules as in the down-feather.

The reproductive power of the feather follicle appears to be almost inexhaustible, since it is not diminished appreciably by age, nor restricted to definite moulting periods, as is shown by the cruel and now obsolete custom of plucking geese alive, no less than three times annually, for the sake of their feathers. The growth of the feathers is, however, certainly affected by the general health of the bird, mal-nutrition causing the appearance of peculiar transverse V-shaped grooves, at more or less regular intervals, along the whole length of the feather. These are known as "hunger-marks," a name given by falconers, to whom this defect was well known.

It would seem that while the feather germ may be artificially stimulated to produce three successive generations of feathers within a year, it may, on the other hand, be induced artificially to maintain a continuous activity extending over long periods. That is to say, the normal quiescent period, and periodic moult, may be suspended, so that the feather maintains a steady and continuous growth till it attains a length of several feet. The only known instance of this kind is that furnished by a domesticated breed of jungle-fowl known as the "Japanese long-tailed fowls" or as "Yokohamas." In this breed the upper tail coverts are in some way, as yet unknown to Europeans, induced to go on growing until they have attained a length of from 12 to 18 or even 20 ft. In this abnormal growth the "hackles" of the lower part of the back also share, though they do not attain a similar length.

The feathers of birds are not uniformly distributed over the body, but grow only along certain definite tracts known as *pterylae*, leaving bare spaces or *apteria*. These *pterylae* differ considerably in their conformation in different groups of birds, and hence are of service in systematic ornithology.

The principal *pterylae* are as follows:—

- (1) The head tract (*pt. capitis*), which embraces the head only.
- (2) The spinal tract (*pt. spinalis*), which extends the whole length of the vertical column. It is one of the most variable in its modifications, especially in so far as the region from the base of the neck to the tail is concerned. In its simplest form it runs down the back in the form of a band of almost uniform width, but generally it

expands considerably in the lumbar region, as in Passeres. Frequently it is divided into two portions; an upper, terminating in the region of the middle of the back in a fork, and a lower, which commences either as a fork, e.g. plover, barbet, or as a median band, e.g. swallow. Very commonly the dorsal region of this tract encloses a more or less extensive featherless space (*apterion*), e.g. swift, auk. While, as a rule, the dorsal region of this tract is relatively narrow, it is in some of great breadth, e.g. grebe, pigeon, colly.

(3) The ventral tract (*pt. ventralis*), which presents almost as many variations as the spinal tract.

In its simplest form it runs from the throat backwards in the form of a median band as far as the base of the neck where it divides, sending a branch to each side of the breast. This branch commonly again divides into a short, broad outer branch which lodges the "flank" feathers, and a long, narrow, inner branch which runs backwards to join its fellow of the opposite side in front of the cloacal aperture. This branch lodges the abdominal feathers. The median space which divides the inner branches of the tract may be continued forwards as far as the middle of the neck, or even up to the throat, e.g. plover. Only in a few cases is the neck continuously covered by the fusion of the dorsal and ventral tracts, e.g. flamingo, Anseres, Ciconidae, Pygopodes.

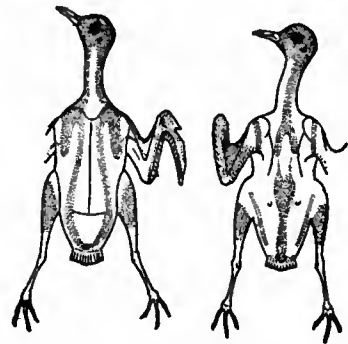

FIG. 2.—Pterylosis of the plover.

For convenience sake the cervical portions of the spinal and ventral tracts are generally regarded as separate tracts, the *pt. colli dorsalis* and *pt. colli ventralis* respectively.

(4) The humeral tract (*pt. humeralis*), which gives rise to the "scapular" feathers.

(5) The femoral tract (*pt. femoralis*), which forms an oblique band across the thigh.

(6) The crural tract (*pt. cruralis*), which clothes the rest of the leg.

(7) The tail tract (*pt. caudalis*), including the tail feathers and their coverts; and

(8) The wing tract (*pt. alaris*). The wing tract presents many peculiar features. Each segment—arm, forearm and hand—bears feathers essential to flight, and these are divided into *remiges*, or "quill" feathers, and *tectrices*, or "coverts."

The *remiges* of the arm, more commonly described as "tertiaries," are, technically, collectively known as the *parapteron* and *hypopteron*, and are composed respectively of long, quill-like feathers forming a double series, the former arranged along the upper, and the latter along the lower aspect of the humerus. They serve to fill up the gap which, in long-winged birds, would otherwise occur during flight between the quill-feathers of the forearm and the body, a gap which would make flight impossible. In short-winged birds these two series are extremely reduced.

The *remiges* range in number from 16, as in humming-birds, to 48 as in the albatross, according, in short, to the length of the wing. But these numerical differences depend, in flying birds, rather upon the length of the forearm, since the quills of the hand never exceed 12 and never fall below 10, though the tenth may be reduced to a mere vestige.

The quills of the forearm are known as "secondaries," those of the hand as "primaries." The former are attached by their bases at relatively wide distances apart to the ulna, while the primaries are crowded close together and attached to the skeleton of the hand. The six or seven which rest upon the fused metacarpals II.-III. are known as "metacarpals." The next succeeding feather is borne by the phalanx of digit III. and hence is known as the addigital. Phalanx I. of digit II. always supports two quills, the "middigitals," while the remaining feathers—one or two—are borne by the last phalanx of digit II. and are known as pre-digitals, while the whole series of primaries are known as the metacarpo-digitals.

In their relation one to another the *remiges*, it must be noted, are always so placed that they overlap one another, the free edge of each, when the wing is seen from its upper surface, being turned towards the tip of the wing. Thus, in flight, the air passes through the wing as it is raised, while in the downstroke the feathers are forced together to form a homogeneous surface.

Birds which fly much have the outer primaries of great length, giving the wing a pointed shape, as in swifts, while in species which fly but little, or frequent thickets, the outer primaries are very short, giving the wing a rounded appearance. This adaptation to environment is commonly lost sight of by taxonomers, who not infrequently use the form of the wing as a factor in classification.

The *tectrices*, or covert feathers of the wing, are arranged in several series, decreasing in size from behind forwards. The number of rows on the dorsal aspect and the method of their overlap, afford characters of general importance in classification.

The first row of the series is formed by the *major coverts*; these, like the primaries, have their free-edges directed towards the tip of the wing, and hence are said to have a distal overlap. The next row is formed by the *median coverts*. These, on the forearm, commonly overlap as to the outer half of the row distally, and as to the inner half proximally. On the hand this series is incomplete. Beyond the median are four or five rows of coverts known as the *minor coverts*. These may have either a proximal or a distal overlap. The remaining rows of small feathers are known as the *marginal coverts*, and they always have a distal overlap.

The three or four large quill-like feathers borne by the thumb form what is known as the "bastard-wing," *ala spuria*.

The coverts of the under follow an arrangement similar to that of the upper surface, but the minor coverts are commonly but feebly developed, leaving a more or less bare space which is covered by the great elongation of the marginal series.

One noteworthy fact about the coverts of the under side of the wing is that all save the major and median coverts have what answers to the dorsal surfaces of the feather turned towards the body, and what answers to the ventral surface of the feather turned towards the under surface of the wing. In the major and median coverts, however, the ventral surfaces of these feathers are turned ventralwards, that is to say, in the extended wing they, like the remiges, have the ventral surfaces turned downwards or towards the body in the closed wing.

But the most remarkable fact in connexion with the pterylosis of the wing is the fact that in all, save the Passerine and Galliform types, and some few other isolated exceptions, the secondary series of remiges appears always to lack the fifth remex, counting from the wrist inwards, inasmuch as, when such wings are examined, there is always found, in the place of the fifth remex, a pair of major coverts only, while throughout the rest of the series each such pair of coverts embraces a quill.

This extraordinary fact was first discovered by the French naturalist Z. Gerbe, and was later rediscovered by R. S. Wray. Neither of these, however, was able to offer any explanation thereof. This, however, has since been attempted, simultaneously, by P. C. Mitchell and W. P. Pycraft. The former has aptly coined the word *diastataxic* to denote the gap in the series, and *eutaxic* to denote such wings as have an uninterrupted series of quills. While both authors agree that there is no evidence of any loss in the number of the quills in diastataxic wings, they differ in the interpretation as to which of the two conditions is the more primitive and the means by which the gap has been brought about.

According to Mitchell the diastataxic is the more primitive condition, and he has conclusively shown a way in which diastataxic wings may become eutaxic. Pycraft on the other hand contends that the diastataxic wing has been derived from the eutaxic type, and has produced evidence showing, on the one hand, the method by which this transition is effected, and on the other that by which the diastataxic wing may again recover the eutaxic condition, though in this last particular the evidence adduced by Mitchell is much more complete. The matter is, however, one of considerable difficulty, but is well worth further investigation.

The wings of struthious birds differ from those of the Carinatae, just described, in many ways. All are degenerate and quite useless as organs of flight. In some cases indeed they have become reduced to mere vestiges.

Those of the ostrich and Rhea are the least degraded.

In the ostrich ankylosis has prevented the flexion of the hand at the wrist joint so that the quills—primaries and secondaries—form an unbroken series of about forty in number. Of these sixteen belong to the primary or metacarpo-digital series, a number exceeding that of any other bird. What the significance of this may be with regard to the primitive wing it is impossible to say at present. The coverts, in their disposition, bear a general resemblance to those of Carinate wings; but they differ on account of the great length of the feathers and the absence of any definite overlap.

The wing of the South American Rhea more nearly resembles that of flying birds since the hand can be flexed at the wrist joint, and the primaries are twelve in number, as in grebes, and some storks, for example.

The coverts, as in the African ostrich, are remarkable for their great length, those representing the major series being as long as the remiges, a fact probably due to the shortening of the latter. They are not, however, arranged in quincunx, as is the rule among the Carinatae, but in parallel, transverse rows, in which respect they resemble the owls.

In both ostrich and Rhea, as well as in all the other struthious birds, the under surface of the wing is entirely bare.

The wing of the cassowary, emeu and apteryx has undergone complete degeneration; so much so that only a vestige of the hand remains.

Remiges in the cassowary are represented by a few spine-like shafts—three primaries and two secondaries. These are really hypertrophied calami. This is shown by the fact that in the nestling these remiges have a normal calamus, rhachis and vane; but as development proceeds the rhachis with its vane sloughs off, while the calamus becomes enormously lengthened and solid.

In the emeu the wing is less atrophied than in the cassowary,

but is not yet completely degenerate. Altogether seventeen remiges are represented, of which seven correspond to primaries. Since, however, these feathers have each an aftershaft as long as the main shaft—like the rest of the body feathers—it may be that they answer not to remiges, but to major coverts.

The wing of apteryx, like that of the cassowary, has become extremely reduced. The remiges are thirteen in number, four of which answer to primaries. These feathers are specially interesting, inasmuch as they retain throughout life a stage corresponding to that seen in the very young cassowary, the calamus being greatly swollen, and supporting a very degenerate rhachis and vane.

The penguins afford another object-lesson in degeneration of this kind. Here the wing has become transformed into a paddle, clothed on both sides with a covering of small, close-set feathers. A pollex is wanting, as in the cassowary, emeu and apteryx, while it is impossible to say whether remiges are represented or not.

AUTHORITIES.—The following authors should be consulted for further details on this subject:—

For General Reference as to Structure, Colour, Development and Pterylosis.—H. Gadow, in Newton's *Dictionary of Birds* (1896); W. P. Pycraft, "The Interlocking of the Barbs of Feathers," *Natural Science* (1893).

On the Colours of Feathers.—J. L. Bonhote, "On Moults and Colour Change in Birds," *Ibis* (1900); A. H. Church, "Researches on Turacin, an Animal Pigment containing Copper," *Phil. Trans.* clix. (1870), pt. ii.; H. Gadow, "The Coloration of Feathers as affected by Structure," *Proc. Zool. Soc.* (1882); Newbegin, *Colour in Nature* (1898); R. M. Strong, "The Development of Color in the Definitive Feather," *Bull. Mus. Zool. Harvard College*, vol. xl.

On Moulting.—J. Dwight, "The Sequences of Plumage and Moults of the Passerine Birds of New York," *Annals N. Y. Acad. Sci.*, vol. xiii. (1900); W. E. De Winton, "On the Moulting of the King Penguin," *Proc. Zool. Soc.* (1898-1899); W. P. Pycraft, "On some Points in the Anatomy of the Emperor and Adélie Penguins," *Report National Antarctic Expedition*, vol. ii. (1907).

On Development of Embryonic, Nestling and Adult Feathers.—T. H. Studer, "Die Entwicklung der Federn," *Inaug.-Diss.* (Bern, 1873); "Beiträge zur Entwickl. der Feder," *Zeitsch. f. wiss. Zool.*, Bd. xxx.; J. T. Cunningham, "Observations and Experiments on Japanese Long-tailed Fowls," *Proc. Zool. Soc.* (1903); H. R. Davies, "Beitrag zur Entwicklung der Feder," *Morph. Jahrb.* xiv. (1888), xv. (1889); W. P. Pycraft, "A Contribution towards our Knowledge of the Morphology of the Owls," *Trans. Linn. Soc.* (1898); W. P. Pycraft, "A Contribution towards our Knowledge of the Pterytography of the Megapodii," *Report Willey's Zoological Results*, pt. iv. (1900); W. P. Pycraft, "Nestling Birds and some of the Problems they Present," *British Birds* (1907).

On Pterylosis.—H. Gadow, "Remarks on the Numbers and on the Phylogenetic Development of the Remiges of Birds," *Proc. Zool. Soc.* (1888); Z. Gerbe, "Sur les plumes du vol et leur mue," *Bull. Soc. Zool. France*, vol. ii. (1877); J. G. Goodchild, "The Cubital Coverts of the Euornithae in relation to Taxonomy," *Proc. Roy. Phys. Edinb.* vol. x. (1890-1891); Meijere, "Über die Federn der Vögel," *Morphol. Jahrb.* xxiii. (1895); P. C. Mitchell, "On so-called 'Quinto-cubitalism' in the Wing of Birds," *Journ. Linn. Soc. Zool.* vol. xxvii. (1899); "On the Anatomy of the Kingfishers, with special reference to the Conditions known as Eutaxy and Diastataxy," *Ibis* (1901); C. L. Nitzsch, "Pterytography," *Ray Soc.* (1867); W. P. Pycraft, "Some Facts concerning the so-called 'Aquinto-cubitalism' of the Bird's Wing," *Journ. Linn. Soc.* vol. xxvii.; C. J. Sundevall, "On the Wings of Birds," *Ibis* (1886); R. S. Wray, "On some Points in the Morphology of the Wings of Birds," *Proc. Zool. Soc.* (1887). (W. P. P.)

Commercial Applications of Feathers.—The chief purposes for which feathers become commercially valuable may be comprehended under four divisions:—(1) bed and upholstery feathers; (2) quills for writing; (3) ornamental feathers; and (4) miscellaneous uses of feathers.

Bed and Upholstery Feathers.—The qualities which render feathers available for stuffing beds, cushions, &c., are lightness, elasticity, freedom from matting and softness. These are combined in the most satisfactory degree in the feathers of the goose and of several other allied aquatic birds, whose bodies are protected with a warm downy covering. Goose feathers and down, when plucked in spring from the living bird, are most esteemed, being at once more elastic, cleaner and less liable to taint than those obtained from the bodies of killed geese. The down of the eider duck, *Anas mollissima*, is valued above all other substances for lightness, softness and elasticity; but it has some tendency to mat, and is consequently more used for quilts and in articles of clothing than unmixed for stuffing beds. The feathers of swans, ducks and of the common domestic fowl are also largely employed for beds; but in the case of the latter bird, which is of course non-aquatic, the feathers are harsher

and less downy than are those of the natatorial birds generally. Feathers which possess strong or stiff shafts cannot without some preliminary preparation be used for stuffing purposes, as the stiff points they present would not only be highly uncomfortable, but would also pierce and cause the escape of the feathers from any covering in which they might be enclosed. The barbs are therefore stripped or cut from these feathers, and when so prepared they, in common with soft feathers and downs, undergo a careful process of drying and cleaning, without which they would acquire an offensive smell, readily attract damp, and harbour vermin. The drying is generally done in highly heated apartments or stoves, and subsequently the feathers are smartly beaten with a stick, and shaken in a sieve to separate all dust and small debris.

Quills for Writing.—The earliest period at which the use of quill feathers for writing purposes is recorded is the 6th century; and from that time till the introduction of steel pens in the early part of the 19th century they formed the principal writing implements of civilized communities. It has always been from the goose that quills have been chiefly obtained, although the swan, crow, eagle, owl, hawk and turkey all have more or less been laid under contribution. Swan quills, indeed are better and more costly than are those from the goose, and for fine lines crow quills have been much employed. Only the five outer wing feathers of the goose are useful for writing, and of these the second and third are the best, while left-wing quills are also generally more esteemed than those of the right wing, from the fact that they curve outward and away from the writer using them. Quills obtained in spring, by plucking or otherwise, from living birds are by far the best, those taken from dead geese, more especially if fattened, being comparatively worthless. To take away the natural greasiness to remove the superficial and internal pellicles of skin, and to give the necessary qualities of hardness and elasticity, quills require to undergo some processes of preparation. The essential operation consists in heating them, generally in a fine sand-bath, to from 130° to 180° F. according to circumstances, and scraping them under pressure while still soft from heat, whereby the outer skin is removed and the inner shrivelled up. If the heating has been properly effected, the quills are found on cooling to have become hard, elastic and somewhat brittle. While the quills are soft and hot, lozenge-shaped patterns, ornamental designs, and names are easily and permanently impressed on them by pressure with suitable instruments or designs in metal stamps.

Ornamental Feathers.—Feathers do not appear to have been much used, in Europe at least, for ornamental purposes till the close of the 13th century. They are found in the conical caps worn in England during the reigns of Edward III. and Richard II.; but not till the period of Henry V. did they take their place as a part of military costume. Towards the close of the 15th century the fashion of wearing feathers in both civil and military life was carried to an almost ludicrous excess. In the time of Henry VIII. they first appeared in the bonnets of ladies; and during Elizabeth's reign feathers began to occupy an important place as head-dress ornaments of women. From that time down to the present, feathers of endless variety have continued to be leading articles of ornamentation in female head-attire; but, except for military plumes, they have long ceased to be worn in ordinary male costume. At the present day, the feathers of numerous birds are, in one way or another, turned to account by ladies for the purpose of personal ornament. Ostrich feathers, however, hold, as they have always held, a pre-eminent position among ornamental feathers; and the ostrich is the only bird which may be said to be reared exclusively for the sake of its feathers. Ostrich farming is one of the established industries of South Africa, and is also practised in Kordofan and other semi-desert regions of North Africa, in Argentina, and in Arizona and California in North America. The feathers are generally plucked from the living animal—a process which does not appear to cause any great inconvenience. In the male bird, the long feathers of the rump and wings are white, and the short feathers of the body are jet black; while the rump and

wing feathers of the female are white tinged with a dusky grey, the general body colour being the latter hue. The feathers of the male are consequently much more valuable than those of the female, and they are separately classified in commerce. The art of the plumassier embraces the cleaning, bleaching, dyeing, curling and making up of ostrich and other plumes and feathers. White feathers are simply washed in bundles in hot soapy water, run through pure warm water, exposed to sulphurous fumes for bleaching, thereafter blued with indigo solution, rinsed in pure cold water, and hung up to dry. When dry the shafts are pared or scraped down to give the feathers greater flexibility, and the barbs are curled by drawing them singly over the face of a blunt knife or by the cautious application of a heated iron. Dull-coloured feathers are usually dyed black. Feathers which are dyed light colours are first bleached by exposure in the open air. Much ingenuity is displayed in the making up of plumes, with the general result of producing the appearance of full, rich, and long feathers from inferior varieties and from scraps and fragments of ostrich feathers; and so dexterously can factitious plumes be prepared that only an experienced person is able to detect the fabrication.

In addition to those of the ostrich, the feathers of certain other birds form articles of steady commercial demand. Among these are the feathers of the South American ostrich, *Rhea americana*, the marabout feathers of India obtained from *Leptoptilos argala* and *L. javanica*, the aigrettes of the heron, the feathers of the various species of birds of paradise, and of numerous species of humming-birds. Swan-down and the skins of various penguins and grebes and of the albatross are used, like fur, for muffs and collarettes.

The Chinese excel in the preparation of artificial flowers and other ornaments from bright natural-coloured or dyed feathers; and the French also skilfully work fragments of feathers into bouquets of artificial flowers, imitation butterflies, &c.

Miscellaneous Applications of Feathers.—Quills of various sizes are extensively employed as holders for the sable and camel hair brushes used by artists, &c. Feather brushes and dusters are made from the wing-feathers of the domestic fowl and other birds; those of a superior quality, under the name of vulture dusters, being really made of American ostrich feathers. A minor application of feathers is found in the dressing of artificial fly-hooks for fishing. As steel pens came into general use it became an object of considerable importance to find applications for the supplanted goose-quills, and a large field of employment for them was found in the preparation of toothpicks. (J. PA; W. P. P.)

FEATHERSTONE, an urban district in the Osgoldcross parliamentary division of the West Riding of Yorkshire, England, 6 m. E. of Wakefield on the Lancashire & Yorkshire railway. Pop. (1901) 12,093. The industrial population is employed in large collieries in the vicinity; and here, on the 7th of September 1893, serious riots during a strike resulted in the destruction of some of the colliery works belonging to Lord Masham, and were not quelled without military intervention and some bloodshed.

FEATLEY (or FAIRCLOUGH) **DANIEL** (1582–1645), English divine, was born at Charlton, Oxfordshire, on the 15th of March 1582. He was a scholar of Corpus Christi College, Oxford, and probationer fellow in 1602, after which he went to France as chaplain to the English ambassador. For some years he was domestic chaplain to George Abbot, archbishop of Canterbury, and held also the rectories of Lambeth (1619), Allhallows, Bread Street (c. 1622), and Acton (1627), this last after leaving the archbishop's service in 1625. His varied activities included a "scholastick duel" with James I. in 1625, and the publication of (1) the report of a conference with some Jesuits in 1624, (2) a devotional manual entitled *Ancilla Pietatis* (1626), (3) *Mystica Clavis, a Key opening divers Difficult Texts of Scripture in 70 Sermons* (1636). He was appointed provost of Chelsea College in 1630, and in 1641 was one of the sub-committee "to settle religion." In the course of this work he had a disputation with four Baptists at Southwark which he commemorated in his book

Καταβαπτιστά καταπτυστοί, *The Dippers dipt or the Anabaptists duckt and plunged over head and ears* (1645). He sat in the Westminster Assembly 1643, and was the last of the Episcopal members to remain. For revealing its proceedings he was expelled and imprisoned. He died at Chelsea on the 17th of April 1645.

FEBRONIANISM, the name given to a powerful movement within the Roman Catholic Church in Germany, in the latter part of the 18th century, directed towards the "nationalizing" of Catholicism, the restriction of the monarchical power usurped by the papacy at the expense of the episcopate, and the reunion of the dissident churches with Catholic Christendom. It was thus, in its main tendencies, the equivalent of what in France is known as Gallicanism (*q.v.*). The name is derived from the pseudonym of "Justinus Febronius" adopted by Johann Nikolaus von Hontheim (*q.v.*), coadjutor bishop of Treves (Trier), in publishing his work *De statu ecclesiae et legitima potestate Romani pontificis*. This book, which roused a vast amount of excitement and controversy at the time, exercised an immense influence on opinion within the Roman Catholic Church, and the principles it proclaimed were put into practice by the rulers of that Church in various countries during the latter part of the 18th and the beginning of the 19th century.

The main propositions defended by "Febronius" were as follows. The constitution of the Church is not, by Christ's institution, monarchical, and the pope, though entitled to a certain primacy, is subordinate to the universal Church. Though as the "centre of unity" he may be regarded as the guardian and champion of the ecclesiastical law, and though he may propose laws, and send legates on the affairs of his primacy, his sovereignty (*principatus*) over the Church is not one of jurisdiction, but of order and collaboration (*ordinis et consociationis*). The Roman (ultramontane) doctrine of papal infallibility is not accepted "by the other Catholic Churches" and, moreover, "has no practical utility." The Church is based on the one episcopacy common to all bishops, the pope being only *primus inter pares*. It follows that the pope is subject to general councils, in which the bishops are his colleagues (*conjudices*), not merely his consultors; nor has he the exclusive right to summon such councils. The decrees of general councils need not be confirmed by the pope nor can they be altered by him; on the other hand, appeal may be made from papal decisions to a general council. As for the rights of the popes in such matters as appeals, reservations, the confirmation, translation and deposition of bishops, these belong properly to the bishops in provincial synods, and were usurped by the papacy gradually as the result of a variety of causes, notably of the False Decretals. For the health of the Church it is therefore necessary to restore matters to their condition before the False Decretals, and to give to the episcopate its due authority. The main obstacle to this is not the pope himself, but the Curia, and this must be fought by all possible means, especially by thorough popular education (*primum adversus abusum ecclesiasticae potestatis remedium*), and by the assembling of national and provincial synods, the neglect of which is the main cause of the Church's woes. If the pope will not move in the matter, the princes, and notably the emperor, must act in co-operation with the bishops, summon national councils even against the pope's will, defy his excommunication, and in the last resort refuse obedience in those matters over which the papacy has usurped jurisdiction.

It will be seen that the views of Febronius had but little originality. In the main they were those that predominated in the great general councils of Constance and Basel in the 15th century; but they were backed by him with such a wealth of learning, and they fitted so well into the intellectual and political conditions of the time, that they found a widespread acceptance. The book, indeed, was at once condemned at Rome (February 1764), and by a brief of the 21st of May the pope commanded all the bishops of Germany to suppress it. The papal condemnation met with a very mixed reception; in some dioceses the order to prohibit the book was ignored, in others action upon it was postponed pending an independent examination, in yet others

(nine in all) it was at once obeyed "for political reasons," though even in these the forbidden book became the "breviary of the governments." The Febronian doctrine, in fact, exactly fitted the views of the German bishops, which were by no means disinterested. It must be remembered that the bishops were at this time great secular princes rather than Catholic prelates; with rare exceptions, they made no pretence of carrying out their spiritual duties; they shared to the full in the somewhat shallow "enlightenment" of the age. As princes of the Empire they had asserted their practical independence of the emperor; they were irked by what they considered the unjustifiable interference of the Curia with their sovereign prerogatives, and wished to establish their independence of the pope also. In the ranks of the hierarchy, then, selfish motives combined with others more respectable to secure the acceptance of the Febronian position. Among secular rulers the welcome given to it was even less equivocal. Even so devout a sovereign as Maria Theresa refused to allow "Febronius" to be forbidden in the Habsburg dominions; her son, the emperor Joseph II., applied the Febronian principles with remorseless thoroughness. In Venice, in Tuscany, in Naples, in Portugal, they inspired the vigorous efforts of "enlightened despots" to reform the Church from above; and they gave a fresh impetus to the movement against the Jesuits, which, under pressure of the secular governments, culminated in the suppression of the Society by Pope Clement XIV. in 1773. "Febronius," too, inspired the proceedings of two notable ecclesiastical assemblies, both held in the year 1786. The reforming synod which met at Pistoia under the presidency of the bishop, Scipione de' Ricci, is dealt with elsewhere (see PISTOIA). The other was the so-called congress of Ems, a meeting of the delegates of the four German archbishops, which resulted, on the 25th of August, in the celebrated "Punctuation of Ems," subsequently ratified and issued by the archbishops. This document was the outcome of several years of controversy between the archbishops and the papal nuncios, aroused by what was considered the unjustifiable interference of the latter in the affairs of the German dioceses. In 1769 the three archbishop-electors of Mainz, Cologne and Treves (Trier) had drawn up in thirty articles their complaints against the Curia, and after submitting them to the emperor Joseph II., had forwarded them to the new pope, Clement XIV. These articles, though "Febronius" was prohibited in the archdioceses, were wholly Febronian in tone; and, indeed, Bishop von Hontheim himself took an active part in the diplomatic negotiations which were their outcome. In drawing up the "Punctuation" he took no active part, but it was wholly inspired by his principles. It consisted of XXIII. articles, which may be summarized as follows. Bishops have, in virtue of their God-given powers, full authority within their dioceses in all matters of dispensation, patronage and the like; papal bulls, briefs, &c., and the decrees of the Roman Congregations are only of binding force in each diocese when sanctioned by the bishop; nunciatures, as hitherto conceived, are to cease; the oath of allegiance to the pope demanded of bishops since Gregory VII.'s time is to be altered so as to bring it into conformity with episcopal rights; annates and the fees payable for the pallium and confirmation are to be lowered and, in the event of the pallium or confirmation being refused, German archbishops and bishops are to be free to exercise their office under the protection of the emperor; with the Church tribunals of first and second instance (episcopal and metropolitan) the nuncios are not to interfere, and, though appeal to Rome is allowed under certain "national" safe-guards, the opinion is expressed that it would be better to set up in each archdiocese a final court of appeal representing the provincial synod; finally the emperor is prayed to use his influence with the pope to secure the assembly of a national council in order to remove the grievances left unredressed by the council of Trent.

Whether this manifesto would have led to a reconstitution of the Roman Catholic Church on permanently Febronian lines must for ever remain doubtful. The French Revolution intervened; the German Church went down in the storm; and in

1803 the secularizations carried out by order of the First Consul put an end to the temporal ambitions of its prelates. Febronianism indeed, survived. Karl Theodor von Dalberg, prince primate of the Confederation of the Rhine, upheld its principles throughout the Napoleonic epoch and hoped to establish them in the new Germany to be created by the congress of Vienna. He sent to this assembly, as representative of the German Church, Bishop von Wessenberg, who in his diocese of Constance had not hesitated to apply Febronian principles in reforming, on his own authority, the services and discipline of the Church. But the times were not favourable for such experiments. The tide of reaction after the Revolutionary turmoil was setting strongly in the direction of traditional authority, in religion as in politics; and that ultramontane movement which, before the century was ended, was to dominate the Church, was already showing signs of vigorous life. Moreover, the great national German Church of which Dalberg had a vision—with himself as primate—did not appeal to the German princes, tenacious of their newly acquired status as European powers. One by one these entered into concordats with Rome, and Febronianism from an aggressive policy subsided into a speculative opinion. As such it survived strongly, especially in the universities (Bonn especially had been, from its foundation in 1774, very Febronian), and it reasserted itself vigorously in the attitude of many of the most learned German prelates and professors towards the question of the definition of the dogma of papal infallibility in 1870. It was, in fact, against the Febronian position that the decrees of the Vatican Council were deliberately directed, and their promulgation marked the triumph of the ultramontane view (see VATICAN COUNCIL, ULTRAMONTANISM, PAPACY). In Germany, indeed, the struggle against the papal monarchy was carried on for a while by the governments on the so-called *Kulturkampf*, the Old Catholics representing militant Febronianism. The latter, however, since Bismarck "went to Canossa," have sunk into a respectable but comparatively obscure sect, and Febronianism, though it still has some hold on opinion within the Church in the chapters and universities of the Rhine provinces, is practically extinct in Germany. Its revival under the guise of so-called Modernism drew from Pope Pius X. in 1908 the scathing condemnation embodied in the encyclical *Pascendi gregis*.

AUTHORITIES.—See Justinus Febronius, *De statu ecclesiae et legitima potestate Romani pontificis* (Bullioni, 1765), second and enlarged edition, with new prefaces addressed to Pope Clement XIII., to Christian kings and princes, to the bishops of the Catholic Church, and to doctors of theology and canon law; three additional volumes, published in 1770, 1772 and 1774 at Frankfurt, are devoted to vindications of the original work against the critics. In the *Revue des deux mondes* for July 1903 (tome xvi. p. 266) is an interesting article under the title of "L'Allemagne Catholique," from the papal point of view, by Georges Goyau. For the congress of Ems see Herzog-Hauck, *Realencyklopädie* (Leipzig, 1898), s.v. "Emsser Kongress." Further references are given in the article on Honthheim (q.v.).

FEBRUARY, the second month of the modern calendar. In ordinary years it contains 28 days; but in bissextile or leap year, by the addition of the intercalary day, it consists of 29 days. This month was not in the Romulian calendar. In the reign of Numa two months were added to the year, namely, January at the beginning, and February at the end; and this arrangement was continued until 452 B.C., when the decemvirs placed February after January. The ancient name of *Februarius* was derived from *februare*, to purify, or from *Februa*, the Roman festival of general expiation and lustration, which was celebrated during the latter part of this month. In February also the Lupercalia were held, and women were purified by the priests of Pan Lyceus at that festival. The Anglo-Saxons called this month Sprout-Kale from the sprouting of the cabbage at this season. Later it was known as *Solmonath*, because of the return of the sun from the low latitudes. The most generally noted days of February are the following:—the 2nd, Candlemas day, one of the fixed quarter days used in Scotland; the 14th, St Valentine's day; and the 24th, St Matthias. The church festival of St Matthias was formerly observed on the 25th of February in bissextile years, but it is now invariably celebrated on the 24th.

FEBVRE, ALEXANDRE FRÉDÉRIC (1835–), French actor, was born in Paris, and after the usual apprenticeship in the provinces and in several Parisian theatres in small parts, was called to the Comédie Française in 1866, where he made his début as Philip II. in *Don Juan d'Aurliche*. He soon became the most popular leading man in Paris, not only in the classical répertoire, but in contemporary novelties. In 1804 he toured the principal cities of Europe, and, in 1895, of America. He was also a composer of light music for the piano, and published several books of varying merit. He married Mdlle Harville, daughter of one of his predecessors at the Comédie Française, herself a well-known actress.

FÉCAMP, a seaport and bathing resort of northern France, in the department of Seine-Inférieure, 28 m. N.N.E. of Havre on the Western railway. Pop. (1906) 15,872. The town, which is situated on the English Channel at the mouth of the small river Fécamp, consists almost entirely of one street upwards of 2 m. in length. It occupies the bottom and sides of a narrow valley opening out towards the sea between high cliffs. The most important building is the abbey church of La Trinité, dating for the most part from 1175 to 1225. The central tower and the south portal (13th century) are the chief features of its simple exterior; in the interior, the decorative work, notably the chapel-screens and some fine stained glass, is remarkable. The hotel-de-ville with a municipal museum and library occupy the remains of the abbey buildings (18th century). The church of St Étienne (16th century) and the Benedictine liqueur distillery,¹ a modern building which also contains a museum, are of some interest. A tribunal and chamber of commerce, a board of trade-arbitrators and a nautical school, are among the public institutions. The port consists of an entrance channel nearly 400 yds. long leading to a tidal harbour and docks capable of receiving ships drawing 26 ft. at spring-tide, 19 ft. at neap-tide. Fishing for herring and mackerel is carried on and the town equips a large fleet for the codbanks of Newfoundland and Iceland. The chief exports are oil-cake, flint, cod and Benedictine liqueur. Imports include coal, timber, tar and hemp. Steam sawing, metal-founding, fish-salting, shipbuilding and repairing, and the manufacture of ship's-biscuits and fishing-nets are among the industries.

The town of Fécamp grew up round the nunnery founded in 658 to guard the relic of the True Blood which, according to the legend, was found in the trunk of a fig-tree drifted from Palestine to this spot, and which still remains the most precious treasure of the church. The original convent was destroyed by the Northmen, but was re-established by Duke William Longsword as a house of canons regular, which shortly afterwards was converted into a Benedictine monastery. King Richard I. greatly enlarged this, and rebuilt the church. The town achieved some prosperity under the dukes of Normandy, who improved its harbour, but after the annexation of Normandy to France it was overshadowed by the rising port of Havre.

FECHNER, GUSTAV THEODOR (1801–1887), German experimental psychologist, was born on the 19th of April 1801 at Gross-Särchen, near Muskau, in Lower Lusatia, where his father was pastor. He was educated at Sorau and Dresden and at the university of Leipzig, in which city he spent the rest of his life. In 1834 he was appointed professor of physics, but in 1839 contracted an affection of the eyes while studying the phenomena of colour and vision, and, after much suffering, resigned. Subsequently recovering, he turned to the study of mind and the relations between body and mind, giving public lectures on the subjects of which his books treat. He died at Leipzig on the 18th of November 1887. Among his works may be mentioned: *Das Büchlein vom Leben nach dem Tode* (1836, 5th ed., 1903), which has been translated into English; *Nanna, oder über das Seelenleben der Pflanzen* (1848, 3rd ed., 1903); *Zendavesta, oder*

¹ The liqueur is said to have been manufactured by the Benedictine monks of the abbey as far back as 1510; since the Revolution it has been produced commercially by a secular company. The familiar legend D. O. M. (*Deo Optimo Maximo*) on the bottles preserves the memory of its original makers.

über die Dinge des Himmels und des Jenseits (1851, 2nd ed. by Lasswitz, 1901); *Über die physikalische und philosophische Atomenlehre* (1853, 2nd ed., 1864); *Elemente der Psychophysik* (1860, 2nd ed., 1889); *Vorschule der Ästhetik* (1876, 2nd ed., 1898); *Die Tagesansicht gegenüber der Nachtansicht* (1879). He also published chemical and physical papers, and translated chemical works by J. B. Biot and L. J. Thénard from the French. A different but essential side of his character is seen in his poems and humorous pieces, such as the *Vergleichende Anatomie der Engel* (1825), written under the pseudonym of "Dr Mises." Fechner's epoch-making work was his *Elemente der Psychophysik* (1860). He starts from the Spinozistic thought that bodily facts and conscious facts, though not reducible one to the other, are different sides of one reality. His originality lies in trying to discover an exact mathematical relation between them. The most famous outcome of his inquiries is the law known as Weber's or Fechner's law which may be expressed as follows:—"In order that the intensity of a sensation may increase in arithmetical progression, the stimulus must increase in geometrical progression." Though holding good within certain limits only, the law has been found immensely useful. Unfortunately, from the tenable theory that the intensity of a sensation increases by definite additions of stimulus, Fechner was led on to postulate a unit of sensation, so that any sensation s might be regarded as composed of n units. Sensations, he argued, thus being representable by numbers, psychology may become an "exact" science, susceptible of mathematical treatment. His general formula for getting at the number of units in any sensation is $s = c \log r$, where s stands for the sensation, r for the stimulus numerically estimated, and c for a constant that must be separately determined by experiment in each particular order of sensibility. This reasoning of Fechner's has given rise to a great mass of controversy, but the fundamental mistake in it is simple. Though stimuli are composite, sensations are not. "Every sensation," says Professor James, "presents itself as an indivisible unit; and it is quite impossible to read any clear meaning into the notion that they are masses of units combined." Still, the idea of the exact measurement of sensation has been a fruitful one, and mainly through his influence on Wundt, Fechner was the father of that "new" psychology of laboratories which investigates human faculties with the aid of exact scientific apparatus. Though he has had a vast influence in this special department, the disciples of his general philosophy are few. His world-conception is highly animistic. He feels the thrill of life everywhere, in plants, earth, stars, the total universe. Man stands midway between the souls of plants and the souls of stars, who are angels. God, the soul of the universe, must be conceived as having an existence analogous to men. Natural laws are just the modes of the unfolding of God's perfection. In his last work Fechner, aged but full of hope, contrasts this joyous "daylight view" of the world with the dead, dreary "night view" of materialism. Fechner's work in aesthetics is also important. He conducted experiments to show that certain abstract forms and proportions are naturally pleasing to our senses, and gave some new illustrations of the working of aesthetic association. Fechner's position in reference to predecessors and contemporaries is not very sharply defined. He was remotely a disciple of Schelling, learnt much from Herbart and Weisse, and decidedly rejected Hegel and the monadism of Lotze.

See W. Wundt, *G. Th. Fechner* (Leipzig, 1901); A. Elsas, "Zum Andenken G. Th. Fechners," in *Grenzbote*, 1888; J. E. Kuntze, *G. Th. Fechner* (Leipzig, 1892); Karl Lasswitz, *G. Th. Fechner* (Stuttgart, 1896 and 1902); E. B. Titchener, *Experimental Psychology* (New York, 1905); G. F. Stout, *Manual of Psychology* (1898), bk. ii. ch. vii.; R. Falckenberg, *Hist. of Mod. Phil.* (Eng. trans., 1895), pp. 601 foll.; H. Höffding, *Hist. of Mod. Phil.* (Eng. trans., 1900), vol. ii. pp. 524 foll.; Liebe, *Fechners Mctaphysik, im Umriss dargestellt* (1903). (H. Sr.)

FECHTER, CHARLES ALBERT (1824-1879), Anglo-French actor, was born, probably in London, on the 23rd of October 1824, of French parents, although his mother was of Piedmontese and his father of German extraction. The boy would probably

have devoted himself to a sculptor's life but for the accident of a striking success made in some private theatricals. The result was an engagement in 1841 to play in a travelling company that was going to Italy. The tour was a failure, and the company broke up; whereupon Fechter returned home and worked assiduously at sculpture. At the same time he attended classes at the Conservatoire with the view of gaining admission to the Comédie Française. Late in 1844 he won the grand medal of the Académie des Beaux-Arts with a piece of sculpture, and was admitted to make his début at the Comédie Française as Seide in Voltaire's *Mahomet* and Valère in Molière's *Tartuffe*. He acquitted himself with credit; but, tired of the small parts he found himself condemned to play, returned again to his sculptor's studio in 1846. In that year he accepted an engagement to play with a French company in Berlin, where he made his first decisive success as an actor. On his return to Paris in the following year he married the actress Eléonore Rabut (d. 1895). Previously he had appeared for some months in London, in a season of French classical plays given at the St James's theatre. In Paris for the next ten years he fulfilled a series of successful engagements at various theatres, his chief triumph being his creation at the Vaudeville on the 2nd of February 1852 of the part of Armand Duval in *La Dame aux camélias*. For nearly two years (1857-1858) Fechter was manager of the Odéon, where he produced *Tartuffe* and other classical plays. Having received tempting offers to act in English at the Princess's theatre, London, he made a diligent study of the language, and appeared there on the 27th of October 1860 in an English version of Victor Hugo's *Ruy Blas*. This was followed by *The Corsican Brothers* and *Don César de Bazan*; and on the 20th of March 1861 he first attempted *Hamlet*. The result was an extraordinary triumph, the play running for 115 nights. This was followed by *Othello*, in which he played alternately the Moor and Iago. In 1863 he became lessee of the Lyceum theatre, which he opened with *The Duke's Motto*; this was followed by *The King's Butterfly*, *The Mountebank* (in which his son Paul, a boy of seven, appeared), *The Roadside Inn*, *The Master of Ravenswood*, *The Corsican Brothers* (in the original French version, in which he had created the parts of Louis and Fabian dei Franchi) and *The Lady of Lyons*. After this he appeared at the Adelphi (1868) as Obenreizer in *No Thoroughfare*, by Charles Dickens and Wilkie Collins, as Edmond Dantes in *Monte Cristo*, and as Count de Leyrac in *Black and White*, a play in which the actor himself collaborated with Wilkie Collins. In 1870 he visited the United States, where (with the exception of a visit to London in 1872) he remained till his death. His first appearance in New York was at Niblo's Garden in the title rôle of *Ruy Blas*. He played in the United States between 1870 and 1876 in most of the parts in which he had won his chief triumphs in England, making at various times attempts at management, rarely successful, owing to his ungovernable temper. The last three years of his life were spent in seclusion on a farm which he had bought at Rockland Centre, near Quakertown, Pennsylvania, where he died on the 5th of August 1879. A bust of the actor by himself is in the Garrick Club, London.

FECKENHAM, JOHN (c. 1515-1584), English ecclesiastic, last abbot of Westminster, was born at Feckenham, Worcestershire, of ancestors who, by their wills, seem to have been substantial yeomen. The family name was Howman, but, according to the English custom, Feckenham, on monastic profession, changed it for the territorial name by which he is always known. Learning his letters first from the parish priest, he was sent at an early age to the claustral school at Evesham and thence, in his eighteenth year, to Gloucester Hall, Oxford, as a Benedictine student. After taking his degree in arts, he returned to the abbey, where he was professed; but he was at the university again in 1537 and took his B.D. on the 11th of June 1539. Returning to Evesham he was there when the abbey was surrendered to the king (27th of January 1540); and then, with a pension of £10 a year, he once more went back to Oxford, but soon after became chaplain to Bishop Bell of Worcester and then served Bonner in that same capacity from 1543 to 1549.

In 1544 Bonner gave him the living of Solihull; and Feckenham established a reputation as a preacher and a disputant of keen intellect but unvarying charity. About 1549 Cranmer sent him to the Tower of London, and while there "he was borrowed out of prison" to take part in seven public disputations against Hooper, Jewel and others. Released by Queen Mary (5th of September 1553), he returned to Bonner and became prebendary of St Paul's, rector of Finchley, then of Greenford Magna, chaplain and confessor to the queen, and dean of St Paul's (10th of March 1554). He took part, with much charity and mildness, in the Oxford disputes against Cranmer, Latimer and Ridley; but he had no liking for the fierce bigotry and bloody measures then in force against Protestants. Feckenham used all his influence with Mary "to procure pardon of the faults or mitigation of the punishment for poor Protestants" (Fuller), and he was sent by the queen to prepare Lady Jane Grey for death. When Elizabeth was sent to the Tower (18th of March 1554), Feckenham interceded for her life and liberty, even at the cost of displeasing the queen.

The royal abbey of Westminster having been restored to its primitive use, Feckenham was appointed abbot, and the old life began again within its hallowed walls on the 21st of November 1556. The abbey school was reopened and the shrine of St Edward restored. On the accession of Elizabeth Feckenham consistently opposed all the legislation for changes in religion, and, when the hour of trial came, he refused the oath of supremacy, rejecting also Elizabeth's offer to remain with his monks at Westminster if he would conform to the new laws. The abbey was dissolved (12th of July 1559), and within a year Feckenham was sent by Archbishop Parker to the Tower (20th of May 1560), according to Jewel, "for having obstinately refused attendance on public worship and everywhere declaiming and railing against that religion which we now profess" (Parker Society, first series, p. 79). Henceforth, except for some brief periods when he was a prisoner at large, Feckenham spent the rest of his life in confinement either in some recognized prison, or in the more distasteful and equally rigorous keeping of the bishops of Winchester and Ely. After fourteen years' confinement, he was released on bail and lived in Holborn, where his benevolence was shown by all manner of works of charity. "He relieved the poor wheresoever he came, so that flies flock not thicker to spilt honey than beggars constantly crowd about him" (Fuller). He set up a public aqueduct in Holborn, and a hospice for the poor at Bath; he distributed every day to the sick the milk of twelve cows, took care of orphans, and encouraged manly sports on Sundays among the youth of London by giving prizes. In 1577 he was committed to the care of Cox of Ely with strict rules for his treatment; and the bishop (1578) could find no fault with him except that "he was a gentle person but in the popish religion too, too obstinate." In 1580 he was removed to Wisbeach Castle, and there exercised such an influence of charity and peace among his fellow-prisoners that was remembered when, in after years, the notorious Wisbeach Stirs broke out under the Jesuit Weston. Even here Feckenham found a means of doing public good; at his own cost he repaired the road and set up a market cross in the town. After twenty-four years of suffering for his conscience he died in prison and was buried in an unknown grave in the parish church at Wisbeach on the 16th of October 1584.

The fullest account of Feckenham is to be found in E. Taunton's *English Black Monks of St Benedict* (London, 1897), vol. i. pp. 160-222. (E. TN.)

FEDCHENKO, ALEXIS PAVLOVICH (1844-1873), Russian naturalist and traveller, well known for his explorations in central Asia, was born at Irkutsk, in Siberia, on the 7th of February 1844; and, after attending the gymnasium of his native town, proceeded to the university of Moscow, for the study more especially of zoology and geology. In 1868 he travelled through Turkestan, the district of the lower Syr-Darya and Samarkand; and shortly after his return he set out for Khokand, where he visited a large portion of territory till then unknown. Soon after his return to Europe he perished on Mont

Blanc while engaged in an exploring tour in Switzerland, on the 15th of September 1873.

Accounts of the explorations and discoveries of Fedchenko have been published by the Russian government,—his *Journeys in Turkestan* in 1874, *In the Khanat of Khokand* in 1875, and *Botanical Discoveries* in 1876. See Petermann's *Mittheilungen* (1872-1874).

FEDERAL GOVERNMENT (Lat. *foedus*, a league), a form of government of which the essential principle is that there is a union of two or more states under one central body for certain permanent common objects. In the most perfect form of federation the states agree to delegate to a supreme federal government certain powers or functions inherent in themselves in their sovereign or separate capacity, and the federal government, in turn, in the exercise of those specific powers acts directly, not only on the communities making up the federation, but on each individual citizen. So far as concerns the residue of powers unallotted to the central or federal authority, the separate states retain unimpaired their individual sovereignty, and the citizens of a federation consequently owe a double allegiance, one to the state, and the other to the federal government. They live under two sets of laws, the laws of the state and the laws of the federal government (J. Bryce, *Studies in History and Jurisprudence*, ii. 490). The word "confederation," as distinct from "federation" has been sometimes, though not universally, used to distinguish from such a federal state (*Bundesstaat*) a mere union of states (*Staatenbund*) for mutual aid, and the promotion of interests common to all (see CONFEDERATION).

The history of federal government practically begins with Greece. This, however, is due to the fact that the Greek federations are the only ones of which we have any detailed information. The obvious importance, especially to scattered villages or tribes, of systematic joint action in the face of a common danger makes it reasonable to infer that federation in its elementary forms was a widespread device. This view is strengthened by what we can gather of the conditions obtaining in such districts as Aetolia, Acarnania and Samnium, as in modern times among primitive peoples and tribes. The relatively detailed information which we possess concerning the federal governments of Greece makes it necessary to pay special attention to them.

In ancient Greece the most striking tendency of political development was the maintenance of separate city states, each striving for absolute autonomy, though all spoke practically the same language and shared to some extent in the same traditions, interests and dangers. This centrifugal tendency is most marked in the cases of the more important states, Athens, Sparta, Argos, Corinth, but Greek history is full of examples of small states deliberately sacrificing what must have been obvious commercial advantage for the sake of a precarious autonomy. Such examples as existed of even semi-federal union were very loose in structure, and the selfishness of the component units was the predominant feature. Thus the Spartan hegemony in the Peloponnese was not really a federation except in the broadest sense. The states did, it is true, meet occasionally for discussion, but their relation, which had no real existence save in cases of immediate common danger, was really that between a paramount leader and unwilling and suspicious allies. The Athenian empire again was a thinly disguised autocracy. The synod (see DELIAN LEAGUE) of the "allies" soon degenerated into a mere form; of comprehensive united policy there was none, at all events after the League had achieved its original purpose of expelling the Persians from Europe.

None the less it is possible, even in the early days of political development in Greece, to find some traces of a tendency towards united action. Thus the unions of individual villages, known as synoecisms, such as took place in Attica and Elis in early times were partly of a federal character: they resulted in the establishment of a common administration, and no doubt in some degree of commercial and military unity. On the other hand, it is likely that these unions lacked the characteristic of federation in that the units could hardly be described as having any sovereign power: at the most they had some municipal autonomy as in the case of the Cleisthenic demes. The union was rather national than federal. Again the Amphictyonic unions had one of the

characteristic elements of federation, namely that they were free sovereign states combining for a particular purpose with an elaborate system of representation (see ΑΜΦΙΧΤΥΟΝΥ). But these unions, at all events in historic times, were mainly concerned with religion, and the authority of the councils did not seriously affect the autonomy of the individual states.

Thus among the city-states as well as among scattered villages the principle of cohesion was not unknown. On the other hand the golden mean between an easily dissoluble relationship, more like an alliance than a federation, and a national system resulting from synoecism was practically never attained in early Greek history. There are, however, examples in Greece proper, and one, Lycia in Asia Minor, of real federal unions. The chief Greek federations were those of Thessaly, Boeotia, Acarnania, Olynthus, Arcadia, Aetolia, Achaea, the most important as well as the most complete in respect of organization being the Aetolian League and the Achaean League.

1. The Thessalian League originated in the deliberate choice by village aristocracies of a single monarch who belonged from time to time to several of the so-called Heracleid families. Soon after the Persian War this monarchy (dynasty of the Aleuadae, Herod. v. 63 and vii. 6) disappeared, and in 424 we find Athens in alliance with a sort of democratic federal council representing τὸ κοινὸν Θετταλῶν (cf. Thuc. i. 102, ii. 22, iv. 78), and probably composed of delegates from the towns. The local feudal nobles, however, seem to have put an end to this government by council, and a dictator (*lagus*) was appointed, with authority over the whole military force of the federation. Three such officers, Lycophron, Jason and Alexander, all of Pherae, endeavoured vainly to administer the collective affairs of the federation, the last by means of a revived republican council. The final failure of this scheme coincided with the disappearance of Thessaly as a sovereign state (see THESSALY).

2. The form and the history of the Boeotian federation are treated fully under Boeotia (*q.v.*). It may probably have originated in religious associations, but the guiding power throughout was the imperial policy of Thebes, especially during its short-lived supremacy after 379 B.C.

3. The federation of Acarnania is of peculiar interest as being formed by scattered villages or tribes, without settled, still less fortified, habitation. In the early part of the 4th century a κοινὸν τῶν Ἀκαρνανῶν met at Stratus (Xen. *Hell.* iv. 6. 4). Late in the same century towns began to form, without, however, disturbing the federation, which existed as late as the 2nd century B.C., governed by a representative council (βουλὰ), and a common assembly (κοινόν) at which any citizen might be present.

4. The foundation of the Olynthian federation was due to the need of protection against the northern invaders (see OLYNTHUS). It was in many respects based on liberal principles, but Olynthus did not hesitate to exercise force against recalcitrants such as Acanthus.

5. The 4th century Arcadian league, which was no doubt a revival of an older federation, was the result of the struggle for supremacy between Thebes and Sparta. The defeat of Sparta at Leuctra removed the pressure which had kept separate the Arcadian tribes, and τὸ κοινὸν τῶν Ἀρκάδων was established in the new city, Megalopolis (*q.v.*, also ARCADIA).

6 and 7. The Aetolian and Achaean leagues (see AETOLIA, and ACHAEAN LEAGUE) were in all respects more important than the preceding and constitute a new epoch in European politics. Both belong to a period in Greek history when the great city states had exhausted themselves in the futile struggle against Macedonia and Rome, and both represent a conscious popular determination in the direction of systematic government. This characteristic is curious in the Aetolian tribes which were famous in all time for habitual brigandage; there was, however, among them the strong link of a racial feeling. The governing council (τὸ κοινὸν τῶν Αἰτωλῶν) was the permanent representative body; there was also a popular assembly (παραίτωλικόν), partly of a primary, partly of a representative kind, any one being free to attend, but each state having only one official representative and one vote. Of all the federal governments of

Greece, this league was the most certainly democratic in constitution. There was a complete system of federal officers, at the head of whom was a Strategus entrusted with powers both military and civil. This officer was annually elected, and, though the chief executive authority, was strictly limited in the federal deliberations to presidential functions (cf. Livy xxxv. 25, "ne praetor, quum de bello consulisset, ipse sententiam diceret"). The Achaean League was likewise highly organized; joint action was strictly limited, and the individual cities had sovereign power over internal affairs. There were federal officers, all the military forces of the cities were controlled by the league, and federal finance was quite separate from city finance.

8. Of the Lycian federation, its origin and duration, practically nothing is known. We know of it in 188-168 B.C. as dependent on Rhodes, and, from 168 till the time when the emperor Claudius absorbed it in the provincial system, as an independent state under Roman protection. The federation was a remarkable example of a typical Hellenic development among a non-Hellenic people. Strabo (p. 665) informs us that the federation, composed of twenty-three cities, was governed by a council (κοινὸν συνέδριον) which assembled from time to time at that city which was most convenient for the purpose in hand. The cities were represented according to size by one, two or three delegates, and bore proportionate shares in financial responsibility. The Lycian league was, therefore, in this respect rather national than federal.

Of ancient federal government outside Greece we know very little. The history of Italy supplies a few examples, of which the chief is perhaps the league of the cities of Latium (*q.v.*; see also ETRURIA).

See E. A. Freeman, *Federal Government in Greece and Rome* (2nd ed., 1893, J. B. Bury), and works quoted in the special articles.

Among the later European confederations the Swiss republic is one of the most interesting. As now constituted it consists of twenty-two sovereign states or cantons. The government is vested in two legislative chambers, a senate or council of state (*Ständerat*), and a national council (*Nationalrat*), constituting unitedly the federal assembly. The executive council (*Bundesrat*) of seven members elects the president and vice-president for a term of three years (see SWITZERLAND: *Government*). Before the French Revolution the German empire was a complex confederation, with the states divided into electoral colleges, consisting—(1) of the ecclesiastical electors and of the secular electors, including the king of Bohemia; (2) of the spiritual and temporal princes of the empire next in rank to the electors; and (3) of the free imperial cities. The emperor was elected by the first college alone. This imposing confederation came to an end by the conquests of Napoleon; and the Confederation of the Rhine was established in 1806 with the French emperor as protector. But in 1815 the Germanic confederation (*Deutscher Bund*) was established by the congress of Vienna, which in its turn has been displaced by the present German empire. This, in its new organization, conferred on Germany the long-coveted unity and coherence the lack of which had been a source of weakness. The constitution dates, in its latest form, from the treaties entered into at Versailles in 1871. A federation was then organized with the king of Prussia as president, under the hereditary title of German emperor. Delegates of the various federated governments form the Bundesrath; the Reichstag, or popular assembly, is directly chosen by the people by universal suffrage; and the two assemblies constitute the federal parliament. This body has power to legislate for the whole empire in reference to all matters connected with the army, navy, postal service, customs, coinage, &c., all political laws affecting citizens, and all general questions of commerce, navigation, passports, &c. The emperor represents the federation in all international relations, with the chancellor as first minister of the empire, and has power, with consent of the Bundesrath, to declare war in name of the empire.

The United States of America more nearly resembles the Swiss confederacy, though retaining marks of its English origin. The original thirteen states were colonies wholly independent of each

other. By the Articles of Confederation and Perpetual Union adopted by the Continental Congress in 1777, and in effect in 1781-1789, the states bound themselves in a league of common defence. By the written Constitution, drafted in 1787 and in operation since 1789, a stronger and more centralized union was established—in theory a federal republic formed by the voluntary combination of sovereign states. A common citizenship was recognized for the whole union; but the federal government was to exercise only such powers as were expressly delegated to it (Amendment of 1791). The powers of the central government are entrusted to three distinct authorities—executive, legislative and judicial. The president, elected for a term of four years by electors chosen for that purpose by each state, is the executive head of the republic. The vice-president, *ex officio* president of the Senate, assumes the presidency in case of resignation or death. Legislative power is vested in a Congress, consisting of two Houses: a Senate, composed of two members elected by each state for a term of six years; and a House of Representatives, consisting of representatives in numbers proportionate to the population of each state, holding their seats for two years. The supreme judicial authority is vested in a Supreme Court, which consists of a chief justice and eight associate justices, all appointed for life by the president, subject to confirmation by the Senate.

The extension of responsible constitutional government by Great Britain to her chief colonies, under a governor or viceregal representative of the crown, has been followed in British North America by the union of the Canadian, maritime and Pacific provinces under a federal government—with a senate, the members of which are nominated by the crown, and a house of commons elected by the different provinces according to their relative population. The governor-general is appointed by the crown for a term of five years, and represents the sovereign in all matters of federal government. The lieutenant-governors of the provinces are nominated by him; and all local legislation is carried on by the provincial parliaments. The remarkable federation of the Dominion of Canada which was thus originated presented the unique feature of a federal union of provinces practically exercising sovereign rights in relation to all local self-government, and sustaining a constitutional autonomy, while cherishing the colonial relationship to Great Britain.

The Commonwealth of Australia (*q.v.*), proclaimed in 1901, is another interesting example of self-governing states federating into a united whole. There is, however, a striking difference to be observed in the powers of the federal governments of Canada and Australia. The federal parliament of Canada has jurisdiction over all matters not specially assigned to the local legislatures, while the federal parliament of Australia has only such jurisdiction as is expressly vested in it or is not expressly withdrawn from the local legislatures. This jurisdiction is undoubtedly extensive, comprising among others, power to legislate concerning trade and industry, criminal law, taxation, quarantine, marriage and divorce, weights and measures, legal tender, copyrights and patents, and naturalization and aliens. There was also an early attempt to federate the South African colonies, and an act was passed for that purpose (South African Act 1877), but it expired on the 18th of August 1882, without having been brought into effect by the sovereign in council; in 1908, however, the Closer Union movement (see SOUTH AFRICA) ripened, and in 1909 a federating Act was successfully passed.

See also Bluntschli, *The Theory of the State*; W. Wilson, *The State*; Wheaton, *International Law*.

FEDERALIST PARTY, in American politics, the party that organized the national government of the United States under the constitution of 1787. It may be regarded as, in various important respects, the lineal predecessor of the American Whig and Republican parties. The name *Federalists* (see ANTI-FEDERALISTS) was first given to those who championed the adoption of the Constitution. They brought to the support of that instrument "the areas of intercourse and wealth" (Libby), the influence of the commercial towns, the greater planters, the army officers, creditors and property-holders generally,—in short, of interests that had felt the evils of the weak government of the

Confederation,—and also of some few true nationalists (few, because there was as yet no general national feeling), actuated by political principles of centralization independently of motives of expediency and self-interest. Most of the Federalists of 1787-1788 became members of the later Federalist Party.

The Federalist Party, which may be regarded as definitely organized practically from 1791, was led, leaving Washington aside, by Alexander Hamilton (*q.v.*) and John Adams. A nationalization of the new central government to the full extent warranted by a broad construction of the powers granted to it by the constitution, and a correspondingly strict construction of the powers reserved to the states and the citizens, were the basic principles of Hamilton's policy. The friends of individual liberty and local government naturally found in the assumption by the central government of even the minimum of its granted powers constant stimulus to their fears (see DEMOCRATIC PARTY); while the financial measures of Hamilton—whose wish for extreme centralization was nowise satisfied by the government actually created in 1787—were calculated to force an immediate and firm assumption by that government, to the limit, of every power it could be held to possess. To the Republicans (Democratic Republicans) they seemed intended to cause a usurpation of powers ungranted. Hence these measures became the issues on which the first American parties were formed. Their effect was supplemented by the division into French and British sympathizers; the Republicans approving the aims and condoning the excesses of the French Revolution, the Federalists siding with British reaction against French democracy. The Federalists controlled the government until 1801. They, having the great opportunity of initiative, organized it in all its branches, giving it an administrative machinery that in the main endures to-day; established the doctrine of national neutrality toward European conflicts (although the variance of Federalist and Republican opinion on this point was largely factitious); and fixed the practice of a liberal construction of the Constitution,¹—not only by Congress, but above all by the United States Supreme Court, which, under the lead of John Marshall (who had been appointed chief-justice by Pres. John Adams), impressed enduringly on the national system large portions of the Federalist doctrine. These are the great claims of the party to memory. After 1801 it never regained power. In attempts to do so, alike in national and in state politics, it impaired its morale by internal dissension, by intrigues, and by inconsistent factious opposition to Democratic measures on grounds of ultra-strict construction. It took up, too, the Democratic weapon of states' rights, and in New England carried sectionalism dangerously near secession in 1808, and in 1812-1814, during the movement, in opposition to the war of 1812, which culminated in the Hartford Convention (see HARTFORD). It lost, more and more, its influence and usefulness, and by 1817 was practically dead as a national party, although in Massachusetts it lingered in power until 1823. It is sometimes said that Federalism died because the Republicans took over its principles of nationality. Rather it fell because its great leaders, John Adams and Alexander Hamilton, became bitter enemies; because neither was even distantly comparable to Jefferson as a party leader; because the party could not hold the support of its original commercial, manufacturing and general business elements; because the party opposed sectionalism to a growing nationalism on the issues that ended in the war of 1812; and, above all, because the principles of the party's leaders (*e.g.* of Hamilton) were out of harmony, in various respects, with American ideals. Their conservatism became increasingly a reactionary fear of democracy; indeed, it is not a strained construction of the times to regard the entire Federalist period from the American point of view as reactionary—a reaction against the doctrines of natural rights, individualism, and states' rights, and the financial looseness of the period of the War of Independence and the succeeding years of the Confederation. The Federalists were charged by the Republicans with being aristocrats and monarchists, and it is certain that their leaders

¹ Even the Democratic party has generally been liberal; although less so in theory (hardly less so in practice) than its opponents.

(who were really a very remarkable body of men) distrusted democratic government; that their Sedition Law was outrageous in itself, and (as well as the Alien Law) bad as a party measure; that in disputes with Great Britain they were true English Tories when contrasted with the friendly attitude toward America held by many English Liberals; and that they persisted in New England as a pro-British, aristocratic social-cult long after they lost effective political influence. In short, the country was already thoroughly democratic in spirit, while Federalism stood for obsolescent social ideas and was infected with political "Toryism" fatally against the times.

Besides the standard general histories see O. G. Libby, *Geographical Distribution of the Vote of the Thirteen States on the Federal Constitution, 1787-1788* (Madison, Wis., 1894); the *Memoirs of Oliver Wolcott* (ed. by Gibbs); C. D. Hazen, *Contemporary American Opinion of the French Revolution* ("J.H.U. Studies," Baltimore, 1897); Henry Adams, *Documents relating to New England Federalism, 1800-1815* (Boston, 1878); A. E. Morse, *The Federalist Party in Massachusetts* (Princeton, N.J., 1909); and the biographies and writings of George Cabot, Fisher Ames, Gouverneur Morris, John Jay, Rufus King, Timothy Pickering, Theodore Sedgwick, C. C. Pinckney and J. A. Bayard.

FEDERICI, CAMILLO (1749-1802), Italian dramatist and actor, was born at Garesio, a small town in Piedmont, on the 9th of April 1749. His real name was Giovanni Battista Viassolo, and that by which he is now known and which he transmitted to his children was taken from the title of one of his first pieces, *Camillo e Federico*. He was educated at Turin, and showed at an early age a great fondness for literature and especially for the theatre. The praises bestowed on his early attempts determined his choice of a career, and he obtained engagements with several companies both as writer and actor. He made a happy marriage in 1777, and soon after left the stage and devoted himself entirely to composition. He settled at Padua, and the reputation of his numerous comedies rapidly spread in Italy, and for a time seemed to eclipse that of his predecessors. Most of his pieces were of the melodramatic class, and he too often resorted to the same means of exciting interest and curiosity. He caught, however, something of the new spirit which was manifesting itself in German dramatic literature in the works of Schiller, Iffland and Kotzebue, and the moral tone of his plays is generally healthy. Fortune did not smile upon him; but he found a helpful friend in a wealthy merchant of Padua, Francis Barisan, for whose private theatre he wrote many pieces. He was attacked in 1791 with a dangerous malady which disabled him for several years; and he had the misfortune to see his works, in the absence of any copyright law, published by others without his permission. At length, in 1802, he undertook to prepare a collected edition; but of this four volumes only were completed when he was again attacked with illness, and died at Padua (December 23).

The publication of his works was completed in 14 volumes in 1816. Another edition in 26 volumes was published at Florence in 1826-1827. A biographical memoir of Federici by Neymar appeared at Venice in 1838.

FEE, an estate in land held of a superior lord on condition of the performance of homage or service (see FEUDALISM). In English law "fee" signifies an estate of inheritance (*i.e.* an estate descendable to the heirs of the grantee so long as there are any in existence) as opposed to an estate for life. It is divisible into three species: (1) fee simple; (2) conditional fee; (3) fee tail. (See ESTATE.) A fee farm rent is the rent reserved on granting a fee farm, *i.e.* land in fee simple, to be held by the tenant and his heirs at a yearly rent. It is generally at least one-fourth of the value of the land at the time of its reservation. (See RENT.)

The word "fee" has also the sense of remuneration for services, especially the *honorarium* paid to a doctor, lawyer or member of any other profession. It is also used of a fixed sum paid for the right to enter for an examination, or on admission to membership of a university or other society. This sense of the word is taken by the *New English Dictionary* to be due to a use of "fee" in its feudal sense, and to represent a sum paid to the holder of an office "in fee."

The etymology of the Med. Lat. *feudum*, *feodum* or *feum*, of its French equivalent *fief*, and English "fee," in Scots law "feu" (*q.v.*), is extremely obscure. (See the *New English Dictionary*, *s.v.* "Fee.") There is a common Teutonic word represented in Old English as *feoh* or *féo*, in Old High German as *fehū*, meaning property in the shape of cattle (cf. modern Ger. *Vieh*, Dutch *vee*). The old Aryan *péku* gives Sanskrit *paçu*, Lat. *pecus*, cattle, whence *pecunia*, money. The O. Eng. *feoh*, in the sense of money, possibly survives in "fee," honorarium, though this is not the view of the *New English Dictionary*. The common explanation of the Med. Lat. *feudum* or *feodum*, of which Ducange (*Glossarium*, *s.v.*) gives an example from a constitution of the emperor Charles the Fat of the year 884, is that it is formed from the Teutonic *fehū*, property, and *ôd*, wealth (cf. ALLODIUM and UDAL). This would apparently restrict the original meaning to movable property, while the early applications of *feudum* are to the enjoyment of something granted in return for service (*beneficium*). Another theory takes the origin to be *fehū* alone, in a particular sense of wages, payment for services. This leaves the *d-* of *feudum* unexplained. Some have taken the origin to be a verbal form *feudare=feum dare*. Another theory finds the source in the O. High Ger. *fehôn*, to eat, feed upon, "take for one's enjoyment."

FEHLING, HERMANN VON (1812-1885), German chemist, was born at Lübeck on the 9th of June 1885. With the intention of taking up pharmacy he entered Heidelberg University about 1835, and after graduating went to Giessen as *préparateur* to Liebig, with whom he elucidated the composition of paraldehyde and metaldehyde. In 1839 on Liebig's recommendation he was appointed to the chair of chemistry in the polytechnic at Stuttgart, and held it till within three years of his death, which happened at Stuttgart on the 1st of July 1885. His earlier work included an investigation of succinic acid, and the preparation of phenyl cyanide (benzotrile), the simplest nitrile of the aromatic series; but later his time was mainly occupied with questions of technology and public health rather than with pure chemistry. Among the analytical methods worked up by him the best known is that for the estimation of sugars by "Fehling's solution," which consists of a solution of cupric sulphate mixed with alkali and potassium-sodium tartrate (Rochelle salt). He was a contributor to the *Handwörterbuch* of Liebig, Wöhler and Poggendorff, and to the Graham-Otto *Textbook of Chemistry*, and for many years was a member of the committee of revision of the *Pharmacopoeia Germanica*.

FEHMARN, an island of Germany, belonging to the Prussian province of Schleswig-Holstein, in the Baltic, separated from the north-east corner of Holstein by a strait known as the Fehmarn-Sund, less than a quarter of a mile in breadth. It is a gently undulating tract of country, about 120 sq. m. in area, bare of forest but containing excellent pasture-land, and rears cattle in considerable numbers. Pop. 10,000.

FEHMIC COURTS (Ger. *Femgerichte*, or *Vehmgerichte*, of disputed origin, but probably, according to J. Grimm, from O. High Ger. *feme* or *feime*, a court of justice), certain tribunals which, during the middle ages, exercised a powerful and sometimes sinister jurisdiction in Germany, and more especially in Westphalia. Their origin is uncertain, but is traceable to the time of Charlemagne and in all probability to the old Teutonic free courts. They were, indeed, also known as free courts (*Freigerichte*), a name due to the fact that all free-born men were eligible for membership and also to the fact that they claimed certain exceptional liberties. Their jurisdiction they owed to the emperor, from whom they received the power of life and death (*Blutbann*) which they exercised in his name. The sessions were often held in secret, whence the names of secret court (*heimliches Gericht*, *Stillgericht*, &c.); and these the uninitiated were forbidden to attend, on pain of death, which led to the designation forbidden courts (*verbotene Gerichte*). Legend and romance have combined to exaggerate the sinister reputation of the Femic courts; but modern historical research has largely discounted this, proving that they never employed torture, that their sittings were only sometimes secret, and that

their meeting-places were always well known. They were, in fact, a survival of an ancient and venerable German institution; and if, during a certain period, they exercised something like a reign of terror over a great part of Germany, the cause of this lay in the sickness of the times, which called for some powerful organization to combat the growing feudal anarchy. Such an organization the Westphalian free courts, with their discipline of terror and elaborate system of secret service, were well calculated to supply. Everywhere else the power of life and death, originally reserved to the emperor alone, had been usurped by the territorial nobles; only in Westphalia, called "the Red Earth" because here the imperial blood-ban was still valid, were capital sentences passed and executed by the Fehmlic courts in the emperor's name alone.

The system, though ancient, began to become of importance only after the division of the duchy of Saxony on the fall of Henry the Lion, when the archbishop of Cologne, duke of Westphalia from 1180 onwards, placed himself as representative of the emperor at the head of the Fehme. The organization now rapidly spread. Every free man, born in lawful wedlock, and neither excommunicate nor outlaw, was eligible for membership. Princes and nobles were initiated; and in 1429 even the emperor Sigismund himself became "a true and proper *Freischöffe* of the Holy Roman Empire." By the middle of the 14th century these *Freischöffen* (Latin *scabini*), sworn associates of the Fehme, were scattered in thousands throughout the length and breadth of Germany, known to each other by secret signs and pass-words, and all of them pledged to serve the summons of the secret courts and to execute their judgment.

The organization of the Fehme was elaborate. The head of each centre of jurisdiction (*Freistuhl*), often a secular or spiritual prince, sometimes a civic community, was known as the *Stuhlherr*, the archbishop of Cologne being, as stated above, supreme over all (*Oberststuhlherr*). The actual president of the court was the *Freigraf* (free count) chosen for life by the *Stuhlherr* from among the *Freischöffen*, who formed the great body of the initiated. Of these the lowest rank were the *Fronboten* or *Freifronen*, charged with the maintenance of order in the courts and the duty of carrying out the commands of the *Freigraf*. The immense development of the Fehme is explained by the privileges of the *Freischöffen*; for they were subject to no jurisdiction but those of the Westphalian courts, whether as accused or accuser they had access to the secret sessions, and they shared in the discussions of the general chapter as to the policy of the society. At their initiation these swore to support the Fehme with all their powers, to guard its secrets, and to bring before its tribunal anything within its competence that they might discover. They were then initiated into the secret signs by which members recognized each other, and were presented with a rope and with a knife on which were engraved the mystic letters S.S.G.G., supposed to mean *Strick, Stein, Gras, Grün* (rope, stone, grass, green).

The procedure of the Fehmlic courts was practically that of the ancient German courts generally. The place of session, known as the *Freistuhl* (free seat), was usually a hillock, or some other well-known and accessible spot. The *Freigraf* and *Schöffen* occupied the bench, before which a table, with a sword and rope upon it, was placed. The court was held by day and, unless the session was declared secret, all freemen, whether initiated or not, were admitted. The accusation was in the old German form; but only a *Freischöffe* could act as accuser. If the offence came under the competence of the court, *i.e.* was punishable by death, a summons to the accused was issued under the seal of the *Freigraf*. This was not usually served on him personally, but was nailed to his door, or to some convenient place where he was certain to pass. Six weeks and three days' grace were allowed, according to the old Saxon law, and the summons was thrice repeated. If the accused appeared, the accuser stated the case, and the investigation proceeded by the examination of witnesses as in an ordinary court of law. The judgment was put into execution on the spot if that was possible. The secret court, from whose procedure the whole institution

has acquired its evil reputation, was closed to all but the initiated, although these were so numerous as to secure quasi-publicity; any one not a member on being discovered was instantly put to death, and the members present were bound under the same penalty not to disclose what took place. Crimes of a serious nature, and especially those that were deemed unfit for ordinary judicial investigation—such as heresy and witchcraft—fell within its jurisdiction, as also did appeals by persons condemned in the open courts, and likewise the cases before those tribunals in which the accused had not appeared. The accused if a member could clear himself by his own oath, unless he had revealed the secrets of the Fehme. If he were one of the uninitiated it was necessary for him to bring forward witnesses to his innocence from among the initiated, whose number varied according to the number on the side of the accuser, but twenty-one in favour of innocence necessarily secured an acquittal. The only punishment which the secret court could inflict was death. If the accused appeared, the sentence was carried into execution at once; if he did not appear, it was quickly made known to the whole body, and the *Freischöffe* who was the first to meet the condemned was bound to put him to death. This was usually done by hanging, the nearest tree serving for gallows. A knife with the cabalistic letters was left beside the corpse to show that the deed was not a murder.

That an organization of this character should have outlived its usefulness and issued in intolerable abuses was inevitable. With the growing power of the territorial sovereigns and the gradual improvement of the ordinary process of justice, the functions of the Fehmlic courts were superseded. By the action of the emperor Maximilian and of other German princes they were, in the 16th century, once more restricted to Westphalia, and here, too, they were brought under the jurisdiction of the ordinary courts, and finally confined to mere police duties. With these functions, however, but with the old forms long since robbed of their impressiveness, they survived into the 19th century. They were finally abolished by order of Jerome Bonaparte, king of Westphalia, in 1811. The last *Freigraf* died in 1835.

AUTHORITIES.—P. Wigand, *Das Femgericht Westfalens* (Hamm, 1825, 2nd ed., Halle, 1893); L. Tross, *Sammlung merkwürdiger Urkunden für die Geschichte der Femgerichte* (Hanover, 1826); F. P. Usener, *Die frei- und heimlichen Gerichte Westfalens* (Frankfurt, 1832); K. G. von Wächter, *Beiträge zur deutschen Gesch., insbesondere . . . des deutschen Strafrechts* (Tübingen, 1845); O. Wächter, *Femgerichte und Hexenprozesse in Deutschland* (Stuttgart, 1882); T. Lindner, *Die Feme* (Münster and Paderborn, 1888); F. Thudichum, *Femgericht und Inquisition* (Giessen, 1889) whose theory concerning the origin of the Fehme is combated in T. Lindner's *Der angebliche Ursprung der Femgerichte aus der Inquisition* (Paderborn, 1890). For works on individual aspects see further Dahmann-Waitz, *Quellenkunde* (ed. Leipzig, 1906), p. 401; also *ib.* supplementary vol. (1907), p. 78.

FEHRBELLIN, a town of Germany, in the kingdom of Prussia, on the Rhine, 40 m. N.W. from Berlin on the railway to Neuruppin. Pop. (1905) 1602. It has a Protestant and a Roman Catholic church and some small industries, among them that of wooden shoes. Fehrbellin is memorable in history as the scene of the famous victory gained, on the 18th of June 1675, by the great elector, Frederick William of Prussia, over the Swedes under Field-Marshal Wrangel. A monument was erected in 1879 on the field of battle, near the village of Hakenberg, to commemorate this great feat of arms.

See A. von Witzleben and P. Hassel, *Zum 200-jährigen Gedenktage von Fehrbellin* (Berlin, 1875); G. Sello, "Fehrbellin," in *Deutsche Zeitschrift für Geschichtswissenschaften*, vii.; M. Jähns, "Der Grosse Kurfürst bei Fehrbellin, &c.," in *Hohenzollern Jahrbuch*, i.

FEIJÓO Y MONTENEGRO, BENITO JERÓNIMO (1676–1764), Spanish monk and scholar was born at Santa María de Melias, near Orense, on the 8th of October 1676. At the age of twelve he entered the Benedictine order, devoted himself to study, and waged war against the superstition and ignorance of his countrymen in the *Teatro crítico* (1726–1730) and the *Cartas eruditas* (1742–1760). These exposures of a retrograde system called forth embittered protests from narrow-minded patriots like Salvador José Maner, and others; but the opposition was

futile, and Feijó's services to the cause of knowledge were universally recognized long before his death, which took place at Oviedo on the 26th of September 1764. He was not a great genius, nor a writer of transcendent merit; his name is connected with no important discovery, and his style is undistinguished. But he uprooted many popular errors, awakened an interest in scientific methods, and is justly regarded as the initiator of educational reform in Spain.

FEITH, RHIJNVIS (1753–1824), Dutch poet, was born of an aristocratic family at Zwolle, the capital of the province Overijssel, on the 7th of February 1753. He was educated at Harderwijk and at the university of Leiden, where he took his degree in 1770. In 1772 he settled at his birthplace, and married. In 1780, in his twenty-seventh year, he became burgomaster of Zwolle. He built a luxurious villa, which he named Boschwijk, in the outskirts of the town, and there he lived in the greatest comfort. His first important production was *Julia*, in 1783, a novel written in emulation of *Werther*, and steeped in *Weltschmerz* and despair. This was followed by the tragedy of *Thirsa* (1784); *Ferdinand and Constantia* (1785), another *Werther* novel; and *The Patriots* (1784), a tragedy. *Bilderdijsk* and other writers attacked his morbid melancholy, and Johannes Kinker (1764–1845) parodied his novels, but his vogue continued. In 1791 he published a tragedy of *Lady Jane Grey*; in 1792 a didactic poem, *The Grave*, in four cantos; in 1793 *Inez de Castro*; in 1796 to 1814 five volumes of *Odes and Miscellaneous Poems*; and in 1802 *Old Age*, in six cantos. He died at Zwolle on the 8th of February 1824.

His works were collected (Rotterdam, 11 vols.) in 1824, with a biographical notice by N. G. van Kampen.

FEJÉR, GYORGY (1766–1851), Hungarian author, was born on the 23rd of April 1766, at Keszthely, in the county of Zala. He studied philosophy at Pest, and theology at Pressburg; eventually, in 1808, he obtained a theological professorship at Pest University. Ten years later (1818) he became chief director of the educational circle of Raab, and in 1824 was appointed librarian to the university of Pest. Fejér's works, which are nearly all written either in Latin or Hungarian, exceed one hundred and eighty in number. His most important work, *Codex diplomaticus Hungariae ecclesiasticus ac civilis*, published from 1829 to 1844, in eleven so-called tomes, really exceeds forty volumes. It consists of old documents and charters from A.D. 104 to the end of 1439, and forms an extraordinary monument of patient industry. This work and many others relating to Hungarian national history have placed Fejér in the foremost rank of Hungarian historians. He died on the 2nd of July 1851. His latest works were *A Kunok eredete* (*The Origin of the Huns*), and *A politikai forradalmak okai* (*The Causes of Political Revolutions*), both published in 1850. The latter production, on account of its liberal tendencies, was suppressed by the Austrian government.

See *Magyar Irók: Életrajz-gyűjtemény* (Pest, 1856), and *A magyar nemzeti irodalomtörténet vázlatá* (Pest, 1861).

FELANITX, or FELANICHE, a town of Spain, in the south-east of the island of Majorca, Balearic Islands; about 5 m. inland from its harbour, Puerto Colon. Pop. (1900) 11,294. A range of low hills intervenes between Felanitx and the Mediterranean; upon one summit, the Puig de San Sebastian, stands a Moorish castle with a remarkable series of subterranean vaults. From the 3rd century B.C., and possibly for a longer period, earthenware water-coolers and other pottery have been manufactured in the town, and many of the vessels produced are noteworthy for their beauty of form and antiquity of design. There is a thriving trade in wine, fruit, wheat, cattle, brandy, chalk and soap.

FELDKIRCH, a small town in the Austrian province of the Vorarlberg, some 20 m. S. of the S. end of the Lake of Constance. It is situated in a green hollow, on the Ill river, between the two narrow rocky gorges through which it flows out into the broad valley of the Rhine. Hence, though containing only about 4000 inhabitants (German-speaking and Romanist), the town is of great military importance, since it commands the entrance into Tirol from the west, over the Arlberg Pass (5012 ft.), and has been the scene of many conflicts, the last in 1799, when the

French, under Oudinot and Masséna, were driven back by the Austrians under Hotze and Jellachich. It is a picturesque little town, overshadowed by the old castle of Schattensburg (now a poor-house), built about 1200 by the count of Montfort, whose descendant in 1375 sold it to the Habsburgs. The town contains many administrative offices, and is the residence of a suffragan bishop, who acts as vicar-general of the diocesan, the bishop of Brixen. Among the principal buildings are the parish church, dating from 1487, and possessing a "Descent from the Cross" (1521), which has been attributed to Holbein, the great Jesuit educational establishment called "Stella Matutina," and a Capuchin convent and church. There is a considerable amount of transit trade at Feldkirch, which by rail is 11 m. from Buchs (Switzerland), through the principality of Liechtenstein, 24 m. from Bregenz, and 99½ m. from Innsbruck by tunnel beneath the Arlberg Pass. The town also possesses numerous industrial establishments, such as factories for cotton-spinning, weaving, bell-founding, dyeing, &c. (W. A. B. C.)

FÉLIBIEN, ANDRÉ (1619–1695), sieur des Avaux et de Javeroy, French architect and historiographer, was born at Chartres in May 1619. At the age of fourteen he went to Paris to continue his studies; and in 1647 he was sent to Rome in the capacity of secretary of embassy to the Marquis de Marueil. His residence at Rome he turned to good account by diligent study of its ancient monuments, by examination of the literary treasures of its libraries, and by cultivating the acquaintance of men eminent in literature and in art, with whom he was brought into contact through his translation of Cardinal Barberini's *Life of Pius V.* Among his friends was Nicholas Poussin, whose counsels were of great value to him. On his return to France he married, and was ultimately induced, in the hope of employment and honours, to settle in Paris. Both Fouquet and Colbert in their turn recognized his abilities; and he was one of the first members (1663) of the Academy of Inscriptions. Three years later Colbert procured him the appointment of historiographer to the king. In 1671 he was named secretary to the newly-founded Academy of Architecture, and in 1673 keeper of the cabinet of antiques in the palace of Brion. To these offices was afterwards added by Louvois that of deputy controller-general of roads and bridges. Félibien found time in the midst of his official duties for study and research, and produced many literary works. Among these the best and the most generally known is the *Entretiens sur les vices et sur les ouvrages des plus excellents peintres anciens et modernes*, which appeared in successive livraisons, the first in 1666, and the fifth in 1688. It was republished with several additions at Amsterdam in 1706, and again at Trévoux in 1725. Félibien wrote also *Origine de la peinture* (1660), *Principes de l'architecture, de la sculpture, de la peinture*, &c. (1676–1690), and descriptions of Versailles, of La Trappe, and of the pictures and statues of the royal residences. Among other literary works, he edited the *Conférences* of the Academy of Painting, and translated the *Castle of the Soul* from the Spanish of St Theresa. His personal character commanded the highest esteem, agreeing with the motto which he adopted—*Bene facere et vera dicere*. He died in Paris on the 11th of June 1695.

His son, Jean François Félibien (c. 1658–1733), was also an architect who left a number of works on his subject; and a younger son, Michel Félibien (c. 1666–1719), was a Benedictine of Saint Germain-des-Prés whose fame rests on his *Histoire de l'abbaye royale de S. Denys en France*, and also his *L'Histoire de la ville de Paris* in 5 vols., a work indispensable to the student of Paris.

FELIX, the name of five popes.

FELIX I., pope from January 269 until his death in January 274. He has been claimed as a martyr, and as such his name is given in the Roman calendar and elsewhere, but his title to this honour is by no means proved, and he has been probably confused with another bishop of the same name. He appears in connexion with the dispute in the church of Antioch between Paul of Samosata, who had been deprived of his bishopric by a council of bishops for heresy, and his successor Domnus. Paul refused to give way, and in 272 the emperor Aurelian was asked to decide between the

rivals. He ordered the church building to be given to the bishop who was "recognized by the bishops of Italy and of the city of Rome" (Felix). See Eusebius, *Hist. Ecc.* vii. 30.

FELIX II., antipope, was in 356 raised from the archdeaconate of Rome to the papal chair, when Liberius was banished by the emperor Constantius for refusing to subscribe the sentence of condemnation against Athanasius. His election was contrary to the wishes both of the clergy and of the people, and the consecration ceremony was performed by certain prelates belonging to the court. In 357 Constantius, at the urgent request of an influential deputation of Roman ladies, agreed to the release of Liberius on condition that he signed the semi-Arian creed. Constantius also issued an edict to the effect that the two bishops should rule conjointly, but Liberius, on his entrance into Rome in the following year, was received by all classes with so much enthusiasm that Felix found it necessary to retire at once from Rome. Regarding the remainder of his life little is known, and the accounts handed down are contradictory, but he appears to have spent the most of it in retirement at his estate near Porto. He died in 365.

FELIX III., pope, was descended from one of the most influential families of Rome, and was a direct ancestor of Gregory the Great. He succeeded Simplicius in the papal chair on the 2nd of March 483. His first act was to repudiate the Henoticon, a deed of union, originating, it is supposed, with Acacius, patriarch of Constantinople, and published by the emperor Zeno with the view of allaying the strife between the Monophysites and their opponents in the Eastern church. He also addressed a letter of remonstrance to Acacius; but the latter proved refractory, and sentence of deposition was passed against him. As Acacius, however, had the support of the emperor, a schism arose between the Eastern and Western churches, which lasted for 34 years. Felix died in 492.

FELIX IV., pope, a native of Beneventum, was, on the death of John in 526, raised to the papal chair by the emperor Theodoric in opposition to the wishes of the clergy and people. His election was followed by serious riots. To prevent a recrudescence of these, Felix, on his death-bed, thought it advisable to nominate his own successor. His choice fell upon the archdeacon Boniface (pope as Boniface II.). But this proceeding was contrary to all tradition and roused very serious opposition. Out of two old buildings adapted by him to Christian worship, Felix made the church of SS. Cosimo and Damiano, near the Via Sacra. He died in September 530.

FELIX V., the name taken by Amadeus (1383–1451), duke of Savoy, when he was elected pope in opposition to Eugenius IV. in 1439. Amadeus was born at Chambéry on the 4th of December 1383, and succeeded his father, Amadeus VII., as count of Savoy in 1391. Having added largely to his patrimonial possessions he became very powerful, and in 1416 the German king Sigismund erected Savoy into a duchy; after this elevation Amadeus added Piedmont to his dominions. Then suddenly, in 1434, the duke retired to a hermitage at Ripaille, near Thonon, resigning his duchy to his son Louis (d. 1465), although he seems to have taken some part in its subsequent administration. It is said, but some historians doubt the story, that, instead of leading a life of asceticism, he spent his revenues in furthering his own luxury and enjoyment. In 1439, when Pope Eugenius IV. was deposed by the council of Basel, Amadeus, although not in orders, was chosen as his successor, and was crowned in the following year as Felix V. In the stormy conflict between the rival popes which followed, the German king, Frederick IV., after some hesitation sided with Eugenius, and having steadily lost ground Felix renounced his claim to the pontificate in 1449 in favour of Nicholas V., who had been elected on the death of Eugenius. He induced Nicholas, however, to appoint him as apostolic vicar-general in Savoy, Piedmont and other parts of his own dominions, and to make him a cardinal. Amadeus died at Geneva on the 7th of January 1451.

FELIX, a missionary bishop from Burgundy, sent into East Anglia by Honorius of Canterbury (630–631). Under King Sigebert his mission was successful, and he became first bishop of

East Anglia, with a see at Dunwich, where he died and was buried, 647–648. It is noteworthy that the Irish monk Furseus preached in East Anglia at the same time, and Bede notices the admiration of Felix for Aidan.

See Bede, *Hist. Eccl.* (Plummer), ii. 15, iii. 18, 20, 25; *Saxon Chronicle* (Earle and Plummer), s.a. 636.

FELIX, of Urgella (fl. 8th century), Spanish bishop, the friend of Elipandus and the propagator of his views in the great Adoptian Controversy (see **ADOPTIANISM**).

FELIX, of Valois (1127–1212), one of the founders of the monastic order of Trinitarians or Redemptionists, was born in the district of Valois, France, on the 19th of April 1127. In early manhood he became a hermit in the forest of Galerresse, where he remained till his sixty-first year, when his disciple Jean de Matha (1160–1213) suggested to him the idea of establishing an order of monks who should devote their lives to the redemption of Christian captives from the Saracens. They journeyed to Rome about the end of 1197, obtained the sanction of the pope, and on their return to France founded the monastery of Cerfroi in Picardy. Felix remained to govern and propagate the order, while Jean de Matha superintended the foreign journeys. A subordinate establishment was also founded by Felix in Paris near a chapel dedicated to St Mathurin, on which account his monks were also called St Mathurins. He died at Cerfroi on the 4th of November 1212, and was canonized.

FELIX, ANTONIUS, Roman procurator of Judaea (A.D. 52–60), in succession to Ventidius Cumanus. He was a freedman either of the emperor Claudius—according to which theory Josephus (*Antiq.* xx. 7) calls him Claudius Felix—or more probably of the empress Antonia. On entering his province he induced Drusilla, wife of Azizus of Iloms (Emesa), to leave her husband and live with him as his wife. His cruelty and licentiousness, coupled with his accessibility to bribes, led to a great increase of crime in Judaea. To put down the Zealots he favoured an even more violent sect, the Sicarii ("Dagger-men"), by whose aid he contrived the murder of the high-priest Jonathan. The period of his rule was marked by internal feuds and disturbances, which he put down with severity. The apostle Paul, after being apprehended in Jerusalem, was sent to be judged before Felix at Caesarea, and kept in custody for two years (*Acts* xxiv.). On returning to Rome, Felix was accused of having taken advantage of a dispute between the Jews and Syrians of Caesarea to slay and plunder the inhabitants, but through the intercession of his brother, the freedman Pallas, who had great influence with the emperor Nero, he escaped unpunished.

See Tacitus, *Annals*, xx. 54, *Hist.* v. 9; Suetonius, *Claudius*, 28; E. Schürer, *History of the Jewish People* (1890–1891); article in Hastings' *Dict. of the Bible* (A. Robertson); commentaries on the *Acts of the Apostles*; Sir W. M. Ramsay, *St Paul the Traveller*; Carl v. Weizsäcker, *Apostolic Age* (Eng. trans., 1894); art. **JEW**s.

FÉLIX, LIA (1830–), French actress, was the third sister and the pupil of the great Rachel. She had hardly been given any trial when, by chance, she was called on to create the leading woman's part in Lamartine's *Toussaint Louverture* at the Porte St Martin on the 6th of April 1850. The play did not make a hit, but the young actress was favourably noticed, and several important parts were immediately entrusted to her. She soon came to be recognized as one of the best comediennes in Paris. Rachel took Lia to America with her to play second parts, and on returning to Paris she played at several of the principal theatres, although her health compelled her to retire for several years. When she reappeared at the Gaiété in the title-rôle of Jules Barbier's *Jeanne d'Arc* she had an enormous success.

FELIXSTOWE, a seaside resort of Suffolk, England; fronting both to the North Sea and to the estuary of the Orwell, where there are piers. Pop. of urban district of Felixstowe and Walton (1901), 5815. It is 85 m. N.E. by E. from London by a branch line from Ipswich of the Great Eastern railway; and is in the Woodbridge parliamentary division of the county. It has good golf links, and is much frequented by visitors for its bracing climate and sea-bathing. There is a small dock, and phosphatic of lime is extensively dug in the neighbourhood and

exported for use as manure. The neighbouring village of Walton, a short distance inland, receives many visitors. The vicinity has yielded numerous Roman remains, and there was a Roman fort in the neighbourhood (now destroyed by the sea), forming part of the coast defence of the Litus Saxonicum in the 4th century.

FELL, JOHN (1625–1686), English divine, son of Samuel Fell, dean of Christ Church, Oxford, was born at Longworth in Berkshire and received his first education at the freeschool at Thame in Oxfordshire. In 1636 he obtained a studentship at Christ Church, and in 1640 he was specially allowed by Archbishop Laud on account of his "known desert," when wanting one term's residence, to proceed to his degree of B. A. He obtained his M.A. in 1643 and took holy orders (deacon 1647, priest 1649). During the Civil War he bore arms for the king and held a commission as ensign. In 1648 he was deprived of his studentship by the parliamentary visitors, and during the next few years he resided chiefly at Oxford with his brother-in-law, Dr T. Willis, at whose house opposite Merton College he and his friends Allestree and Dolben kept up the service of the Church of England through the Commonwealth.

At the Restoration Fell was made prebendary of Chichester, canon of Christ Church (July 27, 1660), dean (Nov. 30), master of St Oswald's hospital, Worcester, chaplain to the king, and D.D. He filled the office of vice-chancellor from 1666 to 1669, and was consecrated bishop of Oxford, in 1676, retaining his deanery *in commendam*. Some years later he declined the primacy of Ireland. Fell showed himself a most capable and vigorous administrator in his various high employments, and a worthy disciple of Archbishop Laud. He restored in the university the good order instituted by the archbishop, which in the Commonwealth had given place to anarchy and a general disregard of authority. He ejected the intruders from his college or else "fixed them in loyal principles." "He was the most zealous man of his time for the Church of England," says Wood, "and none that I yet know of did go beyond him in the performance of the rules belonging thereunto." He attended chapel four times a day, restored to the services, not without some opposition, the organ and surplice, and insisted on the proper academical dress which had fallen into disuse. He was active in recovering church property, and by his directions a children's catechism was drawn up by Thomas Marshall for use in his diocese. "As he was among the first of our clergy," says Burnet, "that apprehended the design of bringing in popery, so he was one of the most zealous against it." He was forward in making converts from the Roman Catholics and Nonconformists. On the other hand, it is recorded to his honour that he opposed successfully the incorporation of Titus Oates as D.D. in the university in October 1679; and according to the testimony of William Nichols, his secretary, he disapproved of the Exclusion Bill. He excluded the undergraduates, whose presence had been irregularly permitted, from convocation. He obliged the students to attend lectures, instituted reforms in the performances of the public exercises in the schools, kept the examiners up to their duties, and himself attended the examinations. He encouraged the students to act plays. He entirely suppressed "*coursing*," *i.e.* disputations in which the rival parties "ran down opponents in arguments," and which commonly ended in blows and disturbances. He was an excellent disciplinarian and possessed a special talent for the education of young men, many of whom he received into his own family and watched over their progress with paternal care. Tom Browne, author of the *Dialogues of the Dead*, about to be expelled from Oxford for some offence, was pardoned by Fell on the condition of his translating extempore the 33rd epigram from Martial:—

"Non amo te, Sabidi, nec possum dicere quare;
Hoc tantum possum dicere, non amo te."

To which he immediately replied with the well-known lines:—

"I do not love you, Dr Fell,
But why, I cannot tell,
But this I know full well,
I do not love you, Dr Fell."¹

Delinquents, however, were not always treated thus mildly by Fell, and Acton Cremer, for the crime of courting a wife while only a bachelor of arts, was set as an imposition the translation into English of the whole of Scheffer's history of Lapland. As vice-chancellor, Fell himself visited the drinking taverns and ordered out the students. In the university elections he showed great energy in suppressing corruption.

Fell's building operations almost rivalled the plans of the great ecclesiastical architects of the middle ages. In his own college he completed in 1665 the north side of Wolsey's great quadrangle, already begun by his father but abandoned during the Commonwealth; he rebuilt in 1672 the east side of the Chaplain's quadrangle "with a straight passage under it leading from the cloister into the field," occupied now by the new Meadow Buildings; the lodgings of the canon of the 3rd stall in the passage uniting the Tom and Peckwater quadrangles (*c.* 1674); a long building joining the Chaplain's quadrangle on the east side in 1677–1678; and lastly the great tower gate, begun in June 1681 on the foundation laid by Wolsey and finished in November 1682, to which the bell "great Tom," after being recast, was transferred from the cathedral in 1683. In 1670 he planted and laid out the Broad Walk. He spent large sums of his own on these works, gave £500 for the restoration of Banbury church, erected a church at St Oswald's, Worcester, and the parsonage house at Woodstock at his own expense, and rebuilt Cuddesdon palace. Fell disapproved of the use of St Mary's church for secular purposes, and promoted the building of the Sheldonian theatre by Archbishop Sheldon. He was treasurer during its construction, presided at the formal opening on the 9th of July 1669, and was nominated with Wren curator in July 1670. In the theatre was placed the University Press, the establishment of which had been a favourite project of Laud, which now engaged a large share of Fell's energy and attention, and which as curator he practically controlled. "Were it not you ken Mr Dean extraordinarily well," writes Sir L. Jenkins to J. Williamson in 1672, "it were impossible to imagine how assiduous and drudging he is about his press."² He sent for type and printers from Holland, declaring that "the foundation of all success must be laid in doing things well, which I am sure will not be done with English letters." Many works, including a Bible, editions of the classics and of the early fathers, were produced under his direction and editing, and his press became noted not only in England but abroad. He published annually one work, generally a classical author annotated by himself, which he distributed to all the students of his college on New Year's day. On one occasion he surprised the Press in printing surreptitiously Aretino's *Postures*, when he seized and destroyed the plates and impressions. Ever "an eager defender and maintainer of the university and its privileges," he was hostile to the Royal Society, which he regarded as a possible rival, and in 1686 he gave an absolute refusal to Obadiah Walker, afterwards the Roman Catholic master of University College, though licensed by James II., to print books, declaring he would as soon "part with his bed from under him" as his press. He conducted it on strict business principles, and to the criticism that more great works were not produced replied that they would not sell. He was, however, not free from fads, and his new spelling (of which one feature was the substitution of *i* for *y* in such words as *cies*, *daies*, *maiest*) met with great disapproval.

Fell also did much to encourage learning in the university. While still a young man at Christ Church he had shown both his zeal and his charity by reading gratuitously with the poor and neglected students of the college. He bore himself a high reputation as a Grecian, a Latinist and a philologist, and he found time, in spite of his great public employments, to bring out with the collaboration of others his great edition of St Cyprian in 1682, an English translation of *The Unity of the Church* in 1681, editions of *Nemesius of Emesa* (1671), of *Aratus* and of *Erato-sthenes* (1672), *Theocritus* (1676), *Alcinous on Plato* (1677), *St Clement's Epistles to the Corinthians* (1677), *Athenagoras* (1682), *Clemens Alexandrinus* (1683), *St Theophilus of Antioch* (1684),

² *Cal. of State Pap. Dom.*, 1672, p. 478, and 1670, p. 26.

¹ J. T. Browne, *Works* (9th ed. by J. Drake), iv. 99–100; T. Forde, *Virtus rediviva* (1661), 106.

Grammatica rationis sive institutiones logicae (1673 and 1685), and a critical edition of the New Testament in 1675. The first volumes of *Kerum Anglicarum scriptores* and of *Historiae Britannicae*, &c. were compiled under his patronage in 1684. He had the MSS. of St. Augustine in the Bodleian and other libraries at Oxford generously collated for the use of the Benedictines at Paris, then preparing a new edition of the father.

Fell spent such large sums in his building, in his noble patronage of learning, and in charities, that sometimes there was little left for his private use. Occasionally in his schemes he showed greater zeal than prudence. He was the originator of a mission to India which was warmly taken up by the East India Company. He undertook himself to train as missionaries four scholars at Oxford, procured a set of Arabic types, and issued from these the Gospels and Acts in the Malay language in 1677. But this was scarcely the best method of communicating the gospel to the natives of India, and the mission collapsed. He affected to despise public opinion, and was masterful and despotic in his dealings with others, especially with those upon whom he was conferring favours. Having generously undertaken at his own charge to publish a Latin version of Wood's *History and Antiquities of the University of Oxford*, with the object of presenting the history of the university in a manner worthy of the great subject to European readers, and of extending its fame abroad, he arrogated to himself the right of editing the work. "He would correct, alter, dash out what he pleased. . . . He was a great man and carried all things at his pleasure." In particular he struck out all the passages which Wood had inserted in praise of Hobbes, and substituted some disparaging epithets. He called the philosopher's *Leviathan* "monstrosissimus" and "publico damnō notissimus." To the printed remonstrance of Hobbes, Fell inserted an insulting reply in the *History* to "irritabile illud et vanissimum Malmesburiense animal," and to the complaint of Wood at this usage answered only that Hobbes "was an old man, had one foot in the grave; that he should mind his latter end, and not trouble the world any more with his papers." In small things as in great he loved to rule and direct. "Let not Fell," writes R. South to R. Bathurst, "have the fingering and altering of them (*i.e.* his Latin verses), for I think that, bating the want of *siquidem* and *quinetiams*, they are as good as his Worship can make." Wood styles him "a valde vult person." He was not content with ruling his own college, but desired to govern the whole university. He prevented Gilbert Ironside, who "was not pliable to his humour," from holding the office of vice-chancellor. He "endeavoured to carry all things by a high hand; scorn'd in the least to court the Masters when he had to have anything pass'd the convocation. Severe to other colleges, blind as to his own, very partial and with good words, and flatterers and tell-tales could get anything out of him." According to Bishop Burnet, who praises his character and his administration, Fell was "a little too much heated in the matter of our disputes with the dissenters." "He had much zeal for reforming abuses, and managed it perhaps with too much heat and in too peremptory a way." "But," he adds, "we have so little of that among us that no wonder if such men are censured by those who love not such patterns nor such severe task-masters." And Wood, whose adverse criticism must be discounted a little on account of the personal dispute,—after declaring that Fell "was exceeding partial in his government even to corruption; went thro' thick and thin; grasped at all yet did nothing perfect or effectually; cared not what people said of him, was in many things very rude and in most pedantic and pedagogical,"—concludes with the acknowledgment, "yet still aimed at the public good." Roger North, who paid Fell a visit at Oxford, speaks of him in terms of enthusiasm:—"The great Dr Fell, who was truly great in all his circumstances, capacities, undertakings and learning, and above all for his superabundant public spirit and goodwill. . . . O the felicity of that age and place when his authority swayed!"

In November 1684, at the command of the king, Fell deprived Locke, who had incurred the royal displeasure by his friendship with Shaftesbury, and was suspected as the author of certain

seditious pamphlets, of his studentship at Christ Church, summarily and without hearing his defence. Fell had in former years cultivated Locke's friendship, had kept up a correspondence with him, and in 1663 had written a testimonial in his favour; and the ready compliance of one who could on occasion offer a stout resistance to any invasion of the privileges of the university has been severely criticised. It must, however, be remembered in extenuation that the legal status of a person on the foundation of a collegiate body had not then been decided in the law-courts. With regard to the justice of the proceeding Fell had evidently some doubts, and he afterwards expressed his regret for the step which he was now compelled to take. But such scruples, however strong, would, with a man of Fell's political and religious opinions, yield immediately to an order from the sovereign, who possessed special authority in this case as a visitor to the college; and such subservience, however strange to modern notions, would probably only be considered natural and proper at that period.

Fell, who had never married, died on the 10th of July 1686, worn out, according to Wood, by his overwhelming public duties. He was buried in the divinity chapel in the cathedral, below the seat which he had so often occupied when living, where a monument and an epitaph, now moved elsewhere, were placed to his memory. "His death," writes John Evelyn, "was an extraordinary losse to the poore church at this time"; but for himself Fell was fortunate in the time of his departure; for a few months more of life would have necessitated a choice, most painful to a man of his character and creed, between fidelity to his sovereign and to his church. With all his faults, which were the defects which often attend eminent qualities such as his, Fell was a great man, "the greatest governor," according to Speaker Onslow, "that has ever been since his time in either of the universities," and of his own college, to which he left several exhibitions for the maintenance of poor scholars, he was a second founder. He was a worthy upholder of the Laudian tradition at Oxford, an enlightened and untiring patron of learning, and a man of exemplary morals and great piety which remained unsullied in the midst of a busy life and much contact with the world. A sum of money was left by John Cross to perpetuate Fell's memory by an annual speech in his praise, but the *Fellii laudes* have been discontinued since 1866. There are two interesting pictures of Fell at Christ Church, one where he is represented with his two friends Allestree and Dolben, and another by Vandyck. The statue placed on the N.E. angle of the Great Quadrangle bears no likeness to the bishop, who is described by Hearne as a "thin grave man."

Besides the learned works already mentioned Fell wrote the lives of his friends Dr Henry Hammond (1661), Richard Allestree, prefixed to his edition of the latter's sermons (1684), and Dr Thomas Willis, in Latin. His *Seasonable advice to Protestants showing the necessity of maintaining the Established Religion in opposition to Popery* was published in 1688. Some of his sermons, which Evelyn found dull, were printed, including *Character of the Last Daies*, preached before the king, 1675, and a *Sermon preached before the House of Peers Dec. 22, 1680*. *The Interest of England stated* (1659), advocating the restoration of the king,¹ and *The Vanity of Scoffing* (1674), are also attributed to him. Fell probably had some share in the composition of *The Whole Duty of Man*, and in the subsequent works published under the name of the author of *The Whole Duty*, which included *Reasons of the Decay of Christian Piety*, *The Ladies Calling*, *The Gentleman's Calling*, *The Government of the Tongue*, *The Art of Contentment*, and *The Lively Oracles given us*, all of which were published in one volume with notes and a preface by Fell in 1684.

AUTHORITIES.—Wood's *Athenae Oxonienses* and *Fasti* (ed. Bliss); Wood's *Life and Times*, ed. by A. Clark; Burnet's *Hist. of His Own Time*, ed. 1833; J. Welch, *Alumni Westmonasteriensis*; Thomas Hearne, *Collections*, ed. by C. E. Doble and others; *History of the Univ. of Oxford* (1814); *Christ Church*, by Rev. H. L. Thompson; *Fortnightly Review*, lix. 689 (May 1896); *Macmillan's Magazine* (Aug. 1875); *A Specimen of the several sorts of Letter given to the*

¹ F. Maseres, *Tracts of the Civil War*, ii. 673.

University by Dr J. Fell (1695); *Notes and Queries*, ser. vi. 2, and ser. vii. 166; *Calendars of State Papers, Dom. Series* (1660-1675). Fell's books and papers were bequeathed by his nephew Henry Jones to the Bodleian library. A few of his letters are to be found in *Add. MSS. Brit. Mus.* 11046, and some are printed in *Life of James II.*, by Ch. J. Fox, *Appendix; Gent. Mag.* 77, p. 633; *Academy*, 8, p. 141; *Athenaeum* for 1887 (2), p. 311; J. Gutch, *Collectanea Curiosa*, i. 269; and in *Cal. of State Papers, Dom. Series.* (P. C. Y.)

FELL. (1) (Through the O. Fr. *fel*, from Low Lat. *fello*, felon), savage, ruthless, deadly; only used now in poetry. (2) (Of Scandinavian origin, cf. Danish *fjeld*, probably connected with a Teutonic root appearing in German *fels*, rock), a hill, as in the names of mountains in the Lake District in England, e.g. Scawfell; also a lofty moorland down. (3) (A word common to Teutonic languages, cf. Ger. *fell*, and Dutch *vel*, cognate with Lat. *pellis*, skin), the pelt or hide of an animal, with the hair or wool and skin; also used of any thick shaggy covering, like a matted fleece. (4) To cause to "fall," a word common to Teutonic languages and akin to the root of the Lat. *fallere* and Gr. *σφάλλειν*, to cause to stumble, to deceive. As a substantive "fell" is used of a flat seam laid level with the surface of the fabric; also, in weaving, of the end of the web.

FELLAH (pl. Fellahin), Arabic for "ploughman" or "tiller," the word used in Arabic-speaking countries to designate peasantry. It is employed especially of the peasantry of Egypt, "Fellahin" in modern English usage being almost equivalent to "Egyptians." In Egypt the name is applied to the peasantry as opposed to the Arabs of the desert (and even those who have settled on the land), the Turks and the townsfolk. Fellah is used by the Arabs as a term of reproach, somewhat like the English "boor," but rather implying a slavish disposition; the fellahin, however, are not ashamed of the name and may pride themselves on being of good fellah descent, as a "fellah of a fellah." They may be classified as Hamito-Semites, and preserve to some extent the blood of the ancient Egyptians. They form the bulk of the population of Egypt and are mainly Mahomedan, though some villages in Upper Egypt are almost exclusively Copt (Christian). Their hybridism is well shown by their great divergence of colour, fellahin in the Delta being sometimes lighter than Arabs, while in Upper Egypt the prevailing complexion is dark brown. The average fellah is somewhat above medium height, big-boned, of clumsy but powerful build, with head and face of fine oval shape, cheek-bones high, forehead broad, short flattish nose with wide nostrils, and black but not woolly hair. The eyebrows are always straight and smooth, never bushy. The mouth is thick-lipped and large but well formed. The eyes are large and black, and are remarkable for the closeness of the eyelashes. The women and girls are particularly noted for their graceful and slender figures and their fine carriage, due to the custom of carrying burdens, especially water-jars, on their heads. The men's heads are usually shaved. The women are not as a rule closely veiled; they generally paint the lips a deep blue, and tattoo a floral device on the chin, sometimes on the forehead and other parts of the body. All but the poorest wear necklaces of cheap pearls, coins or gilt disks. The men wear a blue or brown cotton shirt, linen drawers and a plain skull-cap, or on occasion the tarbush or fez, round which sometimes a turban is wound; the women wear a single cotton smock. The common fellah's home is a mere mud hut, roofed with durra straw. Inside are a few mats, a sheepskin, baskets and some earthenware and wooden vessels. He lives almost entirely on vegetables, millet bread, beans, lentils, dates and onions. But some of the sheikhs are wealthy, and have large houses built of crude brick and whitewashed with lime, with courtyard, many apartments and good furniture. The fellah is laborious in the fields, and abominates absence from his occupations, which generally means loss of money to him. Military service on the old oriental plan was both ruinous and distasteful to him; hence voluntary mutilations to avoid conscription were formerly common and the ingrained prejudice against military service remains. Trained by British officers the fellahin make, however, excellent soldiers, as was proved in

the Sudan campaigns of 1896-98. The fellah is intelligent, cheerful and sober, and as hospitable as his poverty allows. (See **COPTS** and **EGYPT**.)

FELLENBERG, PHILIPP EMANUEL VON (1771-1844), Swiss educationist, was born on the 27th of June 1771 at Bern, in Switzerland. His father was of patrician family, and a man of importance in his canton, and his mother was a granddaughter of the Dutch admiral Van Tromp. From his mother and from Pfeffel, the blind poet of Colmar, he received a better education than falls to the lot of most boys, while the intimacy of his father with Pestalozzi gave to his mind that bent which it afterwards followed. In 1790 he entered the university of Tübingen, where he distinguished himself by his rapid progress in legal studies. On account of his health he afterwards undertook a walking tour in Switzerland and the adjoining portions of France, Swabia and Tirol, visiting the hamlets and farmhouses, mingling in the labours and occupations of the peasants and mechanics, and partaking of their rude fare and lodging. After the downfall of Robespierre, he went to Paris and remained there long enough to be assured of the storm impending over his native country. This he did his best to avert, but his warnings were disregarded, and Switzerland was lost before any efficient means could be taken for its safety. Fellenberg, who had hastily raised a levy *en masse*, was proscribed; a price was set upon his head, and he was compelled to fly into Germany. Shortly afterwards, however, he was recalled by his countrymen, and sent on a mission to Paris to remonstrate against the rapacity and cruelty of the agents of the French republic. But in this and other diplomatic offices which he held for a short time, he was witness to so much corruption and intrigue that his mind revolted from the idea of a political life, and he returned home with the intention of devoting himself wholly to the education of the young. With this resolution he purchased in 1799 the estate of Hofwyl, near Bern, intending to make agriculture the basis of a new system which he had projected, for elevating the lower and rightly training the higher orders of the state, and welding them together in a closer union than had hitherto been deemed attainable. For some time he carried on his labours in conjunction with Pestalozzi, but incompatibility of disposition soon induced them to separate. The scheme of Fellenberg at first excited a large amount of ridicule, but gradually it began to attract the notice of foreign countries; and pupils, some of them of the highest rank, began to flock to him from every country in Europe, both for the purpose of studying agriculture and to profit by the high moral training which he associated with his educational system. For forty-five years Fellenberg, assisted by his wife, continued his educational labours, and finally raised his institution to the highest point of prosperity and usefulness. He died on the 21st of November 1844.

See Hamm, *Fellenberg's Leben und Wirken* (Bern, 1845); and Schöni, *Der Stifter von Hofwyl, Leben und Wirken Fellenberg's*.

FELLER, FRANÇOIS XAVIER DE (1735-1802), Belgian author, was born at Brussels on the 18th of August 1735. In 1752 he entered a school of the Jesuits at Reims, where he manifested a great aptitude for mathematics and physical science. He commenced his novitiate two years afterwards, and in testimony of his admiration for the apostle of India added Xavier to his surname. On the expiry of his novitiate he became professor at Luxembourg, and afterwards at Liège. In 1764 he was appointed to the professorship of theology at Tynau in Hungary, but in 1771 he returned to Belgium and continued to discharge his professorial duties at Liège till the suppression of the Jesuits in 1773. The remainder of his life he devoted to study, travel and literature. On the invasion of Belgium by the French in 1794 he went to Paderborn, and remained there two years, after which he took up his residence at Ratisbon, where he died on the 23rd of May 1802.

Feller's works exceed 120 volumes. In 1773 he published, under the assumed name Flexier de Reval (an anagram of Xavier de Feller), his *Catéchisme philosophique*; and his principal work, *Dictionnaire historique et littéraire* (published in 1781 at Liège in 8 volumes, and afterwards several times reprinted and continued

down to 1848), appeared under the same name. Among his other works the most important are *Cours de morale chrétienne et de littérature religieuse* and his *Coup d'œil sur congrès d'Ems*. The *Journal historique et littéraire*, published at Luxembourg and Liège from 1774 to 1794 in 70 volumes, was edited and in great part written by him.

FELLING, an urban district in the Jarrow parliamentary division of Durham, England, forming an eastern suburb of Gateshead. Pop. (1901) 22,467. Its large industrial population is employed in the neighbouring collieries and the various attendant manufactures.

FELLOE, the outer rim of a wheel, to which the spokes are attached. The word is sometimes spelled and usually pronounced "felly." It is a Teutonic word, in O. Eng. *felg*, cognate with Dutch *velge*, Ger. *Felge*; the original Teutonic root from which these are derived probably meant "to fit together."

FELLOW, properly and by origin a partner or associate, hence a companion, comrade or mate, as in "fellow-man," "fellow-countryman," &c. The word from the 15th century has also been applied, generally and colloquially, to any male person, often in a contemptuous or pitying sense. The Old English *fēolage* meant a partner in a business, *i.e.* one who lays (*lag*) money or property (*fēoh*, fee) together for a common purpose. The word was, therefore, the natural equivalent for *socius*, a member of the foundation of an incorporated college, as Eton, or a college at a university. In the earlier history of universities both the senior and junior members of a college were known as "scholars," but later, as now, "scholar" was restricted to those members of the foundation still *in statu pupillari*, and "fellow" to those senior graduate members who have been elected to the foundation by the corporate body, sharing in the government and receiving a fixed emolument out of the revenues of the college. It is in this sense that "fellow" is used at the universities of Oxford and Cambridge and Trinity, Dublin. At these universities the college teaching is performed by those fellows who are also "tutors." At other universities the term is applied to the members of the governing body or to the holders of certain sums of money for a fixed number of years to be devoted to special study or research. By analogy the word is also used of the members of various learned societies and institutions.

FELLOWS, SIR CHARLES (1799–1860), British archaeologist, was born in August 1799 at Nottingham, where his family had an estate. When fourteen he drew sketches to illustrate a trip to the ruins of Newstead Abbey, which afterwards appeared on the title-page of Moore's *Life of Lord Byron*. In 1820 he settled in London, where he became an active member of the British Association. In 1827 he discovered the modern ascent of Mont Blanc. After the death of his mother in 1832 he passed the greater portion of his time in Italy, Greece and the Levant. The numerous sketches he executed were largely used in illustrating *Childe Harold*. In 1838 he went to Asia Minor, making Smyrna his headquarters. His explorations in the interior and the south led him to districts practically unknown to Europeans, and he thus discovered ruins of a number of ancient cities. He entered Lycia and explored the Xanthus from the mouth at Patara upwards. Nine miles from Patara he discovered the ruins of Xanthus, the ancient capital of Lycia, finely situated on hills, and abounding in magnificent remains. About 15 m. farther up he came upon the ruins of Tlos. After taking sketches of the most interesting objects and copying a number of inscriptions, he returned to Smyrna through Caria and Lydia. The publication of *A Journal written during an Excursion in Asia Minor* (London, 1839) roused such interest that Lord Palmerston, at the request of the British Museum authorities, asked the British consul at Constantinople to get leave from the sultan to ship a number of the Lycian works of art. Late in 1839 Fellows, under the auspices of the British Museum, again set out for Lycia, accompanied by George Scharf, who assisted him in sketching. This second visit resulted in the discovery of thirteen ancient cities, and in 1841 appeared *An Account of Discoveries in Lycia, being a Journal kept during a Second Excursion in Asia Minor*. A third visit was made late in 1841, after Fellows had obtained a *firman* by personal application at Constantinople. He shipped

a number of works of art for England, and in the fourth and most famous expedition (1844) twenty-seven cases of marbles were despatched to the British Museum. His chief discoveries were at Xanthus, Pinara, Patara, Tlos, Myra and Olympus. In 1844 he presented to the British Museum his portfolios, accounts of his expeditions, and specimens of natural history illustrative of Lycia. In 1845 he was knighted "as an acknowledgment of his services in the removal of the Xanthian antiquities to this country." He paid his own expenses in all his journeys and received no public reward. Fellows was twice married. He died in London on the 8th of November 1860.

In addition to the works above mentioned, Fellows published the following: *The Xanthian Marbles; their Acquisition and Transmission to England* (1843), a refutation of false statements that had been published; *An Account of the Ionic Trophy Monument excavated at Xanthus* (1848); a cheap edition of his two *Journals*, entitled *Travels and Researches in Asia Minor, particularly in the Province of Lycia* (1852); and *Coins of Ancient Lycia before the Reign of Alexander; with an Essay on the Relative Dates of the Lycian Monuments in the British Museum* (1855). See C. Brown's *Lives of Nottinghamshire Worthies* (1882), pp. 352–353, and *Journ. of Roy. Geog. Soc.*, 1861.

FELON DE SE (M.L. a felon, *i.e.* murderer, of himself), one who commits murder upon himself. The technical conditions of murder apply to this crime; *e.g.*, "if one commits any unlawful malicious act, the consequence of which is his own death, as if attempting to kill another he runs upon his antagonist's sword, or shooting at another the gun bursts and kills himself," he is a *felo de se*. The horror inspired by this crime led to the revolting punishment of an "ignominious burial on the highway, with a stake driven through the body." This was abolished by an act of 1823, which ordered the burial of the body of a person found to be *felo de se* within 24 hours after the coroner's inquest, between the hours of 9 and 12 at night, and without Christian rites of sepulture. This act was again superseded in 1882 by the Interments (*Felo de se*) Act, which permits the interment of any *felo de se* in the churchyard or other burial ground of the parish or place in which by the law or custom of England he might have been interred but for the verdict. The interment is carried out in accordance with the Burial Laws Amendment Act 1880 (see BURIAL AND BURIAL ACTS). The act does not authorize the performance of any of the rites of Christian burial, but a special form of service may be used. Formerly the goods and chattels, but not the land, of a *felo de se* were forfeited to the crown, but such forfeitures were abolished by the Forfeiture Act 1870. (See also SUICIDE.)

FELONY (O. Fr. *felonie*, from *felson*, a word meaning "wicked," common to Romanic languages, cf. Italian *fello*, *fellone*, the ultimate origin of which is obscure, but is possibly connected either with Lat. *fel*, gall, or *fallere*, to deceive. The English "fell" cruel or fierce, is also connected; and the Greek φῆλος, an impostor, has also been suggested). Legal writers have sought to throw light on the nature of felony by examining the supposed etymology of the word. Coke says it is *crimen animo felleo perpetratum* [a crime committed with malicious or evil intent (*see lohn*)]. Spelman connects it with the word *fee*, signifying fief or feud; and felony in this way would be equivalent to *pretium feudi*, an act for which a man lost or gave up his fee (see Stephen's *Commentaries*, vol. iv. p. 7). And acts involving forfeiture were styled felonies in feudal law, although they had nothing of a criminal character about them. A breach of duty on the part of the vassal, neglect of service, delay in seeking investiture, and the like were felonies: so were injuries by the lord against the vassal. Modern writers are now disposed to accept Coke's definition. In English law, crimes are usually classified as treason, felony, misdemeanour and summary offence. Some writers—and with some justice—treat treason merely as a grave form of felony and it is so dealt with in the Juries Detention Act 1897. But owing to legislation in and since the time of William and Mary, the procedure for the trial of most forms of treason differs from that of felony. The expression summary offence is ambiguous. Many offences which are at common law or by statute felonies, or misdemeanours indictable at common law or by statute, may under certain conditions be tried by a court

of summary jurisdiction (*q.v.*), and many merely statutory offences which would ordinarily be punishable summarily may at the election of the accused be tried by a jury on indictment (Summary Jurisdiction Act 1879, s. 17).

The question whether a particular offence is felony or misdemeanour can be answered only by reference to the history of the offence and not by any logical test. For instance, killing a horse in an unlicensed place is still felony under a statute of 1786. But most crimes described as felonies are or have been capital offences at common law or by statute, and have also entailed on the offender attain and forfeiture of goods. A few felonies were not punishable by death, *e.g.* petty larceny and mayhem. Where an offence is declared a felony by statute, the common law punishments and incidents of trial attach, unless other statutory provision is made (Blackstone, *Commentaries*, iv. 94).

The chief common law felonies are: homicide, rape, larceny (*i.e.* in ordinary language, theft), robbery (*i.e.* theft with violence), burglary and kindred offences. Counterfeiting the coin has been made a felony instead of being treason; and forgery of most documents has been made a felony instead of being, as it was at common law, a misdemeanour. At the beginning of the 19th century felony was almost equivalent to capital crime; but during that century capital punishment was abolished as to all felonies, except wilful murder, piracy with violence (7 W. IV. & 1 Vict. c. 88, s. 2) and offences against the Dockyards, &c., Protection Act 1772; and by the Forfeiture Act 1870, a felon no longer forfeits land or goods on conviction, though forfeiture on outlawry is not abolished. The usual punishment for felony under the present law is penal servitude or imprisonment with or without hard labour. "Every person convicted of any felony for which no punishment is specially provided by the law in force for the time being is liable upon conviction thereof to be sentenced to penal servitude for any period not exceeding seven years, or to be imprisoned with or without hard labour for any term not exceeding two years" (Stephen, *Dig. Cr. Law* (6th ed.), art 18, Penal Servitude Act 1891). A felon may not be fined or whipped on conviction nor put under recognizance to keep the peace or be of good behaviour except under statutory provision. (See Offences against the Person Act 1861, ss. 5, 71.)

The result of legislative changes is that at the present time the only practical distinctions between felony and misdemeanour are:—

1. That a private person may arrest a felon without judicial authority and that bail on arrest is granted as a matter of discretion and not as of right. Any one who has obtained a drove of oxen or a flock of sheep by false pretences may go quietly on his way and no one, not even a peace officer, can apprehend him without a warrant, but if a man offers to sell another a bit of dead fence supposed to have been stolen, he not only may but is required to be apprehended by that person (Greaves, *Criminal Law Consolidation Acts*). (See ARREST, BAIL.)

2. That on an indictment for felony counts may not be joined for different felonies unless they form part of the same transaction. (See INDICTMENT.)

3. That on a trial for felony the accused has a right peremptorily to challenge, or object to, the jurors called to try him, up to the number of twenty. (See JURY.)

4. That a felon cannot be tried *in absentia*, and that the jury who try him may not separate during the trial without leave of the court, which may not be given in cases of murder.

5. That a special jury cannot be empanelled to try a felony.

6. That peers charged with felony are tried in a special manner. (See PEERAGE.)

7. That the costs of prosecuting all felonies (except treason felony) are paid out of public funds: and that a felon may be condemned to pay the costs of his prosecution and to compensate up to £100 for any loss of property suffered by any person through or by means of the felony. In the Criminal Code Bills of 1878–1880 it was proposed to abolish the term felony altogether: and in the Queensland Criminal Code 1899 the term

"crime" is substituted, and within its connotation are included not only treason and piracy but also perjury.

8. That a sentence of a felon to death, or to penal servitude or imprisonment with hard labour or for over twelve months, involves loss of and disqualification for certain offices until the sentence has been served or a free pardon obtained. (Forfeiture Act 1870.)

It is a misdemeanour (i.) to compound a felony or to agree for valuable consideration not to prosecute or to show favour in such prosecution; (ii.) to omit to inform the authorities of a felony known to have been committed (see MISPRISON), and, (iii.) not to assist in the arrest of a felon at the call of an officer of the law. (See CRIMINAL LAW; MISDEMEANOUR; MISPRISON.)

FELSITE, in petrology, a term which has long been generally used by geologists, especially in England, to designate fine-grained igneous rocks of acid (or subacid) composition. As a rule their ingredients are not determinable by the unaided eye, but they are principally feldspar and quartz as very minute particles. The rocks are pale-coloured (yellowish or reddish as a rule), hard, splintery, much jointed and occasionally nodular. Many felsites contain porphyritic crystals of clear quartz in rounded blebs, more or less idiomorphic feldspar, and occasionally biotite. Others are entirely fine-grained and micro- or crypto-crystalline. Occasionally they show a fluxional banding; they may also be spherulitic or vesicular. Those which carry porphyritic quartz are known as quartz-felsites; the term soda-felsites has been applied to similar fine-grained rocks rich in soda-feldspar.

Although there are few objections to the employment of felsite as a field designation for rocks having the above characters, it lacks definiteness, and has been discarded by many petrologists as unsuited for the exact description of rocks, especially when their microscopic characters are taken into consideration. The felsites accordingly are broken up into "granite-porphyrries," "orthophyres" and "orthoclase-porphyrries," "felsitic-rhyolites," "keratophyres," "granophyres," "microgranites," &c. But felsite or microfelsite is still the generally accepted designation for that very fine-grained, almost crypto-crystalline substance which forms the ground-mass of so many rhyolites, dacites and porphyries.

In the hand specimen it is a dull, lustreless, stony-looking aggregate. Under the microscope even with high powers and the very thinnest modern sections, it often cannot be resolved into its components. In places it may contain determinable minute crystals of quartz; less commonly it may show grains which can be proved to be feldspar, but usually it consists of an ultra-microscopic aggregate of fibres, threads and grains, which react to polarized light in a feeble and indefinite manner. Spherulitic, spotted, streaky and fluidal structures may appear in it, and many different varieties have been established on such characters as these but without much validity.

Its association with the acid rocks, its hardness, method of weathering and chemical composition, indicate that it is an intermixture of quartz and acid feldspar, and the occasional presence of these two minerals in well-defined grains confirms this. Moreover, in many dikes, while the ground-mass is microcrystalline and consists of quartz and feldspar near the centre of the mass, towards the margins, where it has been rapidly chilled by contact with the cold surrounding rocks, it is felsitic. The very great viscosity of acid magmas prevents their molecules, especially when cooling takes place suddenly, from arranging themselves to form discrete crystals, and is the principal cause of the production of felsitic ground-masses. In extreme cases these conditions hinder crystallization altogether, and glassy rocks result. Some rocks are felsitic in parts but elsewhere glassy; and it is not always clear whether the felsite is an original substance or has arisen by the devitrification of primary glass. The presence of perlitic structure in some of these felsites points to the latter conclusion, and the results of an examination of ancient glasses and of artificial glass which has been slowly cooled are in accordance with this view. It has been argued that felsite is a eutectic mixture of quartz and feldspar, such that when solidification takes place and the excess of feldspar (or quartz) has

crystallized out it remains liquid till the temperature has fallen to its freezing point, and then consolidates simultaneously. This may be so, but analyses show that it has not always the same composition and consequently that the conditions which determine its formation are not quite simple. Felsitic rocks are sometimes silicified and have their matrix replaced by granular aggregates of cloudy quartz. (J. S. F.)

FELSPAR, or **FELDSPAR**, a name applied to a group of mineral silicates of much importance as rock-constituents. The name, taken from the Ger. *Feldspath*, was originally written with a "d" but in 1794 it was written "felspar" by R. Kirwan, on the assumption that it denoted a mineral of the "fels" rather than of the "field," and this corrupted form is now in common use in England. By some of the earlier mineralogists it was written "feltspars," from the Swedish form *fältspat*.

The felspar-group is divided into two subgroups according to the symmetry of the crystals. Although the crystals of all felspars present a general resemblance in habit, they are usually regarded as belonging to two systems, some felspars being monoclinic and others anorthic. Figures of the crystals are given in the articles on the different species. Two cleavages are generally well marked. In the monoclinic or monosymmetric felspars these, being parallel to the basal pinacoid and clinopinacoid, necessarily make an angle of 90° , whence the name orthoclase applied to these minerals; whilst in the anorthic or asymmetric felspars the corresponding angle is never exactly 90° , and from this obliquity of the principal cleavages they are termed plagioclase (see **ORTHOCLASE** and **PLAGIOCLASE**). There are consequently two series of felspars, one termed orthoclastic or orthotomous, and the other plagioclastic or clinotomous. F. E. Mallard suggested that all felspars are really asymmetric, and that orthoclase presents only a pseudo-monosymmetric habit, due to twinning. Twin-crystals are very common in all the felspars, as explained under their respective headings.

The two divisions of the felspar-group founded on differences of crystalline symmetry are subdivided according to chemical composition. All the felspars are silicates containing aluminium with some other metallic base or bases, generally potassium, sodium or calcium, rarely barium, but never magnesium or iron. The monoclinic series includes common potash-felspar or orthoclase (KAlSi_3O_8) and hyalophane, a rare felspar containing barium ($\text{K}_2\text{BaAl}_4\text{Si}_8\text{O}_{24}$). The anorthic series includes at one end the soda-felspar albite ($\text{NaAlSi}_3\text{O}_8$) and at the other extremity the lime-felspar anorthite ($\text{CaAl}_2\text{Si}_2\text{O}_8$). It was suggested by G. Tschermak in 1864 that the other plagioclastic felspars are isomorphous mixtures in various proportion of albite (Ab) and anorthite (An). These intermediate members are the lime-soda felspars known as oligoclase, andesine, labradorite and bytownite. There are also placed in the anorthic class a potash-felspar called microcline, and a rare soda-potash-felspar known as anorthoclase.

The specific gravity of the felspars has been shown by G. Tschermak and V. Geldschmidt to vary according to their chemical composition, rising steadily from 2.57 in orthoclase to 2.75 in anorthite. All the felspars have a hardness of 6 to 6.5, being therefore rather less hard than quartz. Pure felspar is colourless, but the mineral is usually white, yellow, red or green. Certain felspars are used as ornamental stones on account of their colour (see **AMAZON STONE**). Other felspars are prized for their pearly opalescence (see **MOONSTONE**), or for their play of iridescent colours (see **LABRADORITE**), or for their spangled appearance, like aventurine (see **SUN-STONE**).

Felspar is much used in the manufacture of porcelain by reason of its fusibility. In England the material employed is mostly orthoclase from Scandinavia, often known as "Swedish spar." The high translucency of "ivory porcelain" depends on the large proportion of felspar in the body. The mineral is also an important constituent of most ceramic glazes. The melting points of felspars have been investigated by Prof. J. Joly, Prof. C. A. Doelter y Cisterich and especially by A. L. Day and E. T. Allen in the Geophysical Laboratory of the Carnegie Institute at Washington.

Among the applications of felspar is that of pure orthoclase in the manufacture of artificial teeth.

Felspar readily suffers chemical alteration, yielding kaolin (*q.v.*). The turbidity of orthoclase is usually due to partial kaolinization. Secondary mica is also a common result of alteration, and among other products are pinite, epidote, saussurite, chlorite, wollastonite and various zeolites.

See **ALBITE**, **AMAZON STONE**, **ANDESINE**, **ANORTHITE**, **BYTOWNITE**, **LABRADORITE**, **MICROCLINE**, **MOONSTONE**, **OLIGOCLASE**, **ORTHOCLASE**, **PLAGIOCLASE**, **SUN-STONE**.

FELSTED, or **FELSTEAD**, a village of Essex, England, between Dunmow and Braintree, and 10 m. from Chelmsford; with a station on the Great Eastern railway. Felsted is only noteworthy by reason of its important public school, dating back to its foundation as a grammar school in 1564 by Richard 1st Baron Rich, who as lord chancellor and chancellor of the court of augmentations had enriched himself with the spoil of the adjoining abbey and priory of Little Lee at the dissolution of the monasteries. It became a notable educational centre for Puritan families in the 17th century, numbering a hundred or more pupils, under Martin Holbeach (1600-1670), headmaster from 1627-1649, and his successors C. Glasscock (from 1650 to 1690), and Simon Lydiatt (1690 to 1702). John Wallis and Isaac Barrow were educated here, and also four sons of Oliver Cromwell, Robert, Oliver, Richard (the Protector), and Henry. Another era of prosperity set in under the headmastership of William Trivett (1745-1830) between 1778 and 1794; but under his successors W. J. Carless (from 1794 to 1813) and E. Squire (from 1813 to 1829) the numbers dwindled. As the result of the discovery by T. Surridge (headmaster 1835-1850), from research among the records, that a larger income was really due to the foundation, a reorganization took place by act of parliament, and in 1851, under the headmastership of Rev. A. H. Wratistaw, the school was put under a new governing body (a revised scheme coming into operation in 1876). The result under Rev. W. S. Grignon (1823-1907), the headmaster from 1856 to 1875, who may be considered almost the second founder, was the rapid development of Felsted into one of the regular public schools of the modern English type. New buildings on an elaborate scale arose, the numbers increased to more than 200, and a complete transformation took place, which was carried on under his successors D. S. Ingram (from 1875 to 1890), H. A. Dalton (to 1906), and F. Stephenson, under whom large extensions to the buildings and playing-fields were made.

See John Sargeant, *History of Felsted School* (1889); and *Alumni Felstedenses*, by R. J. Beevor, E. T. Roberts and others (1903).

FELT (cognate with Ger. *Filz*, Du. *vill*, Swed. and Dan. *fill*; the root is unknown; the word has given Med. Lat. *filtrum*, "filter"), a fabric produced by the "matting" or "felting" together of fibrous materials such as wools, hairs, furs, &c. Most textile fibres (see **FIBRES**) possess the quality of matting to some extent, but wools, furs and some few hairs are the only fibres which can be felted satisfactorily. It is probable that the quality of felting must be attributed to the scale structure and waviness of the wools, furs and hairs referred to. When it is desired to incorporate non-felting fibres in felt cloths, wool must be employed to "carry" them.

There are two distinct classes of felts, viz. woven or "thread-structure" felts, and "fibre" or true felts. In the manufacture of thread-structure felts, wools possessing the quality of felting in a high degree are naturally selected, carefully scoured so that the felting quality is not seriously damaged, spun into woollen yarn possessing the necessary fibre arrangement and twist, woven into cloth of such a character that subsequently satisfactory shrinking or felting may be effected, and finally scoured, milled in the stocks of machine of both, dyed and finished on the lines of an ordinary woven fabric. The lighter styles of woven felts may be composed of a single cloth only, but for the heavier styles two or more cloths are woven, one on top of the other, at one and the same time, arrangements being made to stitch the cloths together during the weaving operation.

Fibre felts are exceedingly interesting from the historical point of view. It is now generally admitted that the art of

weaving preceded that of spinning, and it must further be conceded that the art of felting preceded that of weaving, so that the felt fabric is probably one of the oldest of the various styles of recognized fabrics. The inhabitants of the middle and northern regions of Asia seem to have employed felt from time immemorial, as clothing and also as a covering for their habitations. Most of the classical writers refer to it and some of them actually describe its manufacture. Felt was also largely employed by the ancients for their hats, outer garments, and sometimes as a species of armour.

Fibre felts may be divided into three classes, viz. ordinary felts; hat felts; and impregnated felts. As all felts are based upon the ordinary felt, the process of manufacture of this will first be described. Of the wools employed the principal are:—East Indian, German or mid-European, New Zealand cross-breeds, and Australian, Cape and Buenos Aires merinos. Vegetable fibres and silk are also employed, but wool must be used to "carry" them; thus a good felting wool may be made to carry its own weight of cotton, hemp, &c. Hairs and furs are principally used in the hat felts. The average loss upon the wool from the raw state to the finished felt is 40 to 50%. The order of the manufacturing processes is as follows:—mixing, willowing, teasing, scribbling and carding. It is interesting to note that it is not usual to scour felting wools. This is not because they are really clean—some are dirty—but because the felting property is liable to be interfered with in the scouring operation. Some wools, however, must be scoured to ensure satisfactory working in the machines. From the card the wool is delivered as a gossamer-like film from 50 to 60 in. wide on to an endless sheet from 30 to 60 yds. long, upon which the felt is built up film upon film until the required thickness—perhaps 4 in.—is obtained. To harden this somewhat tender sheet of felt it is now passed through an ironing process, effected by either steam-heated rollers—to which a rotatory and vibratory motion is given—playing upon the continually drawn-through cloth; or a huge vibrating flat-iron, to which the cloth is automatically fed, held in position and then wound up while the following length to be treated is drawn under the iron. Soaping, fulling or "felting" and the ordinary finishing operations—including dyeing and printing if desirable—now follow, so that ultimately a strong firm fabric is turned out. It must be admitted, however, that the strength is much greater lengthwise than cross-wise, owing to the parallelization of the fibres induced in the scribbling and carding operations. Of course, the true felting or contraction occurs in the fulling or felting stock, the fabric being perpetually "hammered" in the presence of fulling agents such as soap, fuller's earth, &c., for a considerable time. The reduction in width, length and thickness is remarkable. This may be controlled within certain limits. The principal styles of ordinary fibre-felts are—linings for coats, furniture and rubber shoes; saddlery; seatings for carriages and pews; carpets, surrounds and under-felts for carpets; mantles, dresses and table-cloths; felt-slippers; mattress felts; chest-preservers, and shoulder-pads; steam-engine packing, motor-car and anti-vibration felts, shipbuilding felts; drawing-roller felts and gun-wad felts.

Hat felts may be divided into two classes, viz. those made from wool and fur respectively. Wool "bodies" used for the lower quality hats are manufactured in the same way as ordinary felts, but the "shape" upon which the film issuing from the carder is built up takes the form of a double cone and thus approximates to the shape of the two hats ultimately formed. The shape is further controlled and developed in the fulling or felting operation. In the fur hat felts an air-blast is employed to carry the finely separated fibres on to the shape required, upon which shape the fibres are held in position by suction until the required thickness is obtained. The structure is then further developed and "stiffened," i.e. impregnated with certain stiffening agents according to requirements. If desirable the exterior fibres blown on to any shape may be of a different material from the body fabric.

Impregnated felts are simply felts made in the ordinary way

but subsequently impregnated with certain agents which give a special quality to the fabric. Messrs McNeill & Co., of London, were the originators of "asphalted-felt" for roofing and, among other styles, place on the market sheathing felt, inodorous felt, dry hair felt, foundation felt, &c., &c. A later development, however, is the impregnated iron-felt manufactured by Messrs Mitchells, Ashworth, Stansfield & Co., of Waterfoot, near Manchester, who not only produce from 70 to 80 % of the ordinary felts manufactured in Great Britain, but also place on the market several specialties of which this "iron-felt" is largely used in the construction of bridges, &c., and as a substitute for rubber, it being apparently more durable. (A. F. B.)

FELTHAM, or **FELLTHAM**, **OWEN** (d. 1668), English moralist, was the son of Thomas Feltham or Felltham of Mutford in Suffolk. The date of his birth is given variously as 1602 and 1609. He is famous chiefly as the author of a volume entitled *Resolves, Divine, Moral and Political*, containing one hundred short and pithy essays. To later issues of the *Resolves* Feltham appended *Lusoria*, a collection of forty poems. Hardly anything is known of his life except that T. Randolph, the adopted "son" of Ben Jonson, addressed a poem of compliment to him, and became his friend, and that Feltham attacked Ben Jonson in an ode shortly before the aged poet's death, but contributed a flattering elegy to the *Jonsonus Virbius* in 1638. Early in life Feltham visited Flanders, and published observations in 1652 under the title of *A Brief Character of the Low Countries*. He was a strict high-churchman and a royalist; he even described Charles I. as "Christ the Second." Hallam stigmatized Feltham as one of our worst writers. He has not, indeed, the elegance of Bacon, whom he emulated, and he is often obscure and affected; but his copious imagery and genuine penetration give his reflections a certain charm. To the middle classes of the 17th century he seemed a heaven-sent philosopher and guide, and was only less popular than Francis Quarles the poet.

Eleven editions of the *Resolves* appeared before 1700. Later editions by James Cumming (London, 1806; much garbled; has account of Feltham's life and writings), and O. Smeaton in "Temple Classics" series (London, 1904).

FELTON, **CORNELIUS CONWAY** (1807–1862), American classical scholar, was born on the 6th of November 1807, in West Newbury, Massachusetts. He graduated at Harvard College in 1827, having taught school in the winter vacations of his sophomore and junior years. After teaching in the Livingstone high school of Geneseo, New York, for two years, he became tutor at Harvard in 1829, university professor of Greek in 1832, and Eliot professor of Greek literature in 1834. In 1860 he succeeded James Walker as president of Harvard, which position he held until his death, at Chester, Pennsylvania, on the 26th of February 1862. Dr Felton edited many classical texts. His annotations on Wolf's text of the *Iliad* (1833) are especially valuable. *Greece, Ancient and Modern* (2 vols., 1867), forty-nine lectures before the Lowell Institute, is scholarly, able and suggestive of the author's personality. Among his miscellaneous publications are the American edition of Sir William Smith's *History of Greece* (1855); translations of Menzel's *German Literature* (1840), of Munk's *Metres of the Greeks and Romans* (1844), and of Guyot's *Earth and Man* (1849); and *Familial Letters from Europe* (1865).

FELTON, **JOHN** (c. 1595–1628), assassin of the 1st duke of Buckingham, was a member of an old Suffolk family established at Playford. The date of his birth and the name of his father are unknown, but his mother was Eleanor, daughter of William Wright, mayor of Durham. He entered the army, and served as lieutenant in the expedition to Caciz commanded by Sir Edward Cecil in 1625. His career seems to have been ill-starred and unfortunate from the beginning. His left hand was early disabled by a wound, and a morose temper rendered him unpopular and prevented his advancement. Every application made to Buckingham for his promotion was refused, on account of an enmity, according to Sir Simonds D'Ewes, which existed between Felton and Sir Henry Hungate, a favourite of Buckingham. To his personal application that he could not live without a captaincy Buckingham replied harshly "that he might hang." Whether he

took part in the expedition to Rhé in 1627 is uncertain, but there is no doubt that he continued to be refused promotion, and that even his scanty pay earned during the Cadiz adventure was not received. Exasperated by his ill-treatment, his discontent sharpened by poverty, and his hatred of Buckingham intensified by a study of the Commons "Remonstrances" of the previous June, and by a work published by Eglesham, the physician of James I., in which Buckingham was accused of poisoning the king, Felton determined to effect his assassination. He bought a tenpenny knife on Tower Hill, and on his way through Fleet Street he left his name in a church to be prayed for as "a man much discontented in mind." He arrived at Portsmouth at 9 o'clock in the morning of the 23rd of August 1628, and immediately proceeded to No. 10 High Street, where Buckingham was lodged. Here mingling with the crowd of applicants and unnoticed he stabbed the duke, who immediately fell dead. Though escape would have been easy he confessed the deed and was seized and conveyed to the Tower, his journey thither, such was the unpopularity of the duke, being accompanied by cries of "God bless thee" from the people. Charles and Laud desired he should be racked, but the illegal torture was prevented by the judges. He was tried before the king's bench on the 27th of November, pleaded guilty, and was hanged the next day, his body being exposed in chains subsequently at Portsmouth.

FELTRE, MORTO DA, Italian painter of the Venetian school, who worked at the close of the 15th century and beginning of the 16th. His real name appears to have been Pietro Luzzo; he is also known by the name Zarato or Zarotto, either from the place of his death or because his father, a surgeon, was in Zara during the son's childhood: whether he was termed Morto (dead) from his joyless temperament is a disputed point. He may probably have studied painting first in Venice, but under what master is uncertain. At an early age he went to Rome, and investigated the ancient, especially the subterranean remains, and thence to Pozzuoli, where he painted from the decorations of antique crypts or "grotte." The style of fanciful arabesque which he formed for himself from these studies gained the name of "grotesche," whence comes the term "grotesque"; not, indeed, that Morto was the first painter of arabesque in the Italian Renaissance, for art of this kind had, apart from his influence, been fully developed, both in painting and in sculpture, towards 1480, but he may have powerfully aided its diffusion southwards. His works were received with much favour in Rome. He afterwards went to Florence, and painted some fine grotesques in the Palazzo Pubblico. Returning to Venice towards 1505, he assisted Giorgione in painting the Fondaco dei Tedeschi, and seems to have remained with him till 1511. If we may trust Ridolfi, Morto eloped with the mistress of Giorgione, whose grief at this transaction brought him to the grave; the allegation, however, is hardly reconcilable with other accounts. It may have been in 1515 that Morto returned to his native Feltre, then in a very ruinous condition from the ravages of war in 1509. There he executed various works, including some frescoes, still partly extant, and considered to be almost worthy of the hand of Raphael, in the loggia beside San Stefano. Towards the age of forty-five, Morto, unquiet and dissatisfied, abandoned painting and took to soldiering in the service of the Venetian republic. He was made captain of a troop of two hundred men; and fighting valorously, he is said to have died at Zara in Dalmatia, in 1519. This story, and especially the date of it, are questionable: there is some reason to think that Morto was painting as late as 1522. One of his pictures is in the Berlin museum, an allegorical subject of "Peace and War." Andrea Feltrini was his pupil and assistant as a decorative painter.

FELTRE (anc. *Feltria*), a town and episcopal see of Venetia, Italy, in the province of Belluno, 20 m. W.S.W. of it by rail, situated on an isolated hill, 885 ft. above sea-level. Pop. (1901) 5468 (town), 15,243 (commune). The cathedral has a fine polygonal apse of the 16th century. The Palazzo del Consiglio, now a theatre, is attributed to Palladio. At one end of the chief square of the town, the Piazza Maggiore, is the cistern by which the town is supplied with water, and a large fountain. There

are some remains of the medieval castle. The ancient Feltria, which lay on the road (Via Claudia) from Opitergium to Tridentum, does not seem to have been a place of any importance under the Romans. Vittorino dei Rambaldoni da Feltre (1378-1446) was a famous educator and philosopher of his time.

FELUCCA (an Italian word; in forms like the Span. *saluca*, Fr. *felouque*, it appears in other languages; it is probably of Arabic origin, cf. *fulk*, a ship, and *falaka*, to be round; the modern Arabic form is *falukah*), a type of vessel used in the Mediterranean for coasters or fishing-boats. It is a long, low and narrow undecked vessel, built for speed, and propelled by oars or sails. The sails are lateen-shaped and carried on one or two masts placed far forward (see **BOAT**).

FEMALE, the correlative of "male," the sex which performs the function of conceiving and bearing as opposed to the begetting of young. The word in Middle English is *femelle*, adopted from the French from the Lat. *femella*, which is a diminutive, and in classical Latin used strictly as such, of *femina*, a woman. The present termination in English is due to a connexion in ideas with "male." In various mechanical devices, where two corresponding parts work within the other, the receiving part is often known as the "female," as for example in the "male" and "female screw." The O. Fr. *feme*, modern *femme*, occurs in legal phraseology in *feme covert*, a married woman, i.e. one protected or covered by a husband, and in *feme sole*, one not so protected, a widow or spinster (see **WOMEN** and **HUSBAND AND WIFE**).

FEMERELL, properly **FUMERELL** (from O. Fr. *fumeraille*, Lat. *fumus*, smoke), the old English term given to the lantern in the ridge of a hall roof for the purpose of letting out the smoke of the fire kindled on a central hearth.

FENCING. If by "fencing"—the art of fence, i.e. of defence or offence—were meant generally the dexterous use of the sword, the subject would be wide indeed; as wide, in fact, as the history of the sword (*q.v.*) itself. But, in its modern acceptation, the meaning of the word has become considerably restricted. The scope of investigation must therefore be confined to one kind of swordsmanship only: to that which depends on the regulated, artificial conditions of "single combat." It is indeed this play, hemmed in by many restrictions, which we have come to mean more specially by "fencing." It differs, of course, in many respects, from what may be called the art of fighting in the light of nature. But as its restrictions are among the very elements which work to the perfection of the play, it is undoubtedly in the history of swordsmanship as applied to duelling (see **DUEL**) that we shall trace the higher development of the art.

It may be said that the history of fencing, therefore, would be tantamount to the history of private duelling. Now, this is an ethical subject; one, again, which would carry the investigation too far; and it need not be taken up farther back than the middle of the 16th century, when, on the disuse of the medieval wager of battle, the practice of *private duelling* began to take an assured footing in a warlike society. It is curious to mark that the first cultivation of refined cunning in fence dates from that period, which corresponds chronologically with the general disuse of armour, both in battle and in more private encounters. It is still more curious to note that, in order to fit himself to meet what was an illegal but aristocratic obligation, the gallant of those days had to appeal to a class of men hitherto little considered: to those plebeian adepts, in fact, who for generations had cultivated skill in the use of hand weapons, on foot and without armour. Thus it came to pass that the earliest masters of fence in all countries, namely, the masters of the art of conducting skilfully what was essentially considered as an honourable encounter, were almost invariably to be found among a somewhat dishonoured gentry—gladiators, free companions, professional champions, more or less openly recognized, or bravoes of the most uncompromising character.

In Germany, which may be considered the cradle of systematic swordsmanship, these teachers of the sword had, as early as the 15th century, formed themselves into guilds; among which the best known were the *Marxbrüder*, or the Associates of St Marcus

of Löwenberg, who had their headquarters at Frankfort, and branches in all the more important towns. Similarly, in Spain and in northern Italy, professional swordsmen were at various times allowed to form themselves into recognized or at least tolerated associations.

In England "swordmen" had been looked upon with especial disfavour by the powers that were, until Henry VIII., who was a great lover of all manly exercises, found it likewise advisable to turn their obnoxious existence to a disciplined and profitable channel by regularizing their position. The most redoubtable masters were allowed to form themselves into a company, with powers to increase their numbers with suitable and duly tried men, in imitation of the world-famed German *Marxbrüder* or *Marcusbrüder*. Under these conditions they were granted the lucrative monopoly of teaching the art of fight in England. The enormous privileges that the king, in course of time, conferred on his Corporation of Masters of Defence very soon enabled it to put down or absorb all the more ferocious of independent swashbucklers, and thereby to impart to the profession a moderate degree of respectability under the coat of arms granted by the royal heralds: gules a sword pendant argent.

It was in the midst of such corporations and in the fighting dens of independent swordsmen, therefore, that sprouted the first buds of systematic swordsmanship. Among the professional fencers, curiously and happily for the historian, there seem to have been a few with a literary turn of mind.

The oldest manuscripts of fence belong to Italy and Germany. They deal with the methods of carrying out single combats on foot, with any of the most generally accepted weapons—long sword and short sword, dagger and every kind of knives, mace, long and short staff, axes, &c.,—and with the tricks of wrestling recommendable therefor. Among the most comprehensive in their scope may be mentioned *Il Fior di battaglia di Maestro Fiore dei Liberi da Premariaco*; a work which, although illustrated with truly Italian taste and grace, shows, as far as its fighting style is concerned, unmistakable marks of German influence. The text of the MS. bears the date 1410, but the writer was known to be flourishing as a master of fence as early as 1383. A reprint of this invaluable codex has been published, under the care of Francesco Donati, by the *Istituto Italiano d'Arti Grafiche*. Another is the better known *Thalhofer's Fecht Buch, gerichtliche und andere Zweykämpfe darstellend* (1467), a reprint of which, with its 268 plates in facsimile, was brought out by Gustave Hergsell in Prague. The oldest printed book is likewise German: *Ergündung der ritterlicher Kunst der Fechterei, von Andreas Paurnfeindt, Freisfechter zu Wien* (1516). This work, which is exceedingly rare, is a very complete exponent of the ways of wielding long and short blades to the utmost of their lethal capacity. It was reproduced (under various titles, very confusing to the bibliographer) in Frankfort, Augsburg, Strassburg, and finally done into French under the name of *La Noble science des joueurs d'épée*, published in Paris and Antwerp, 1535.

Following the Germans, the oldest printed books of fence are Italian. The first French book on the sword is known to be a translation from the German. Curiously enough, the second, and one of the most notable, *Le Traité de l'épée seule, mère de toutes armes*, of the Sieur de St Didier, published in Paris in 1573, can be shown to be a transparent adaptation of two Italian treatises, the *Trattato di scienza d'arme* of Camillo Agrippa, and Grassi's *Ragione di adoperar sicuramente l'arme*, &c.

It is about this time, namely, the latter half of the 16th century, that swordsmanship pure and simple may be said to find its origin; for then a great change is perceptible in the nature and tendency of fence books: they dissociate themselves from indecorous wrestling tricks, and approximate more and more to the consideration of what we understand by swordsmanship. The older works expounded the art of fighting generally; taught the reader a number of valuable, if not "gentlemanlike," dodges for overcoming an adversary *at all manner of weapons*: now the lucubrations of fence-masters deal almost exclusively with the walking sword, that is, the duelling weapon—with the

rapier in fact, both with and without its lieutenant, the dagger.

It must be remembered that at this period private duelling and cavalier quarrelsomeness amounted to a perfect mania. The fencing master was no longer merely a teacher of efficacious, if rascally, tricks; he was becoming a model of gallant deportment; in many cases he was even a recognized arbiter on matters of honour. He was often a gentleman himself: at all events he posed as such.

Although the Germans were always redoubtable adepts at the rougher games of swordsmanship, it is in Italy that is to be found development of that nimbler, more regulated, more cunning, better controlled, kind of play which we have learned to associate with the term "fencing." It was from Italy that the art of fence first spread over Europe: not from Spain, as it has been asserted by many writers. The Italians—if we take their early books as evidence, and the fact that their phraseology was adopted by all Europe—were the first to perceive (as soon as the problem of armour-breaking ceased to be the most important one in fight) the superior efficiency of the point. They accordingly reduced the breadth of their sword, modified the hilt portion thereof to admit of readier thrust action, and relegated the cut to quite a secondary position in their system. With this lighter weapon they devised in course of time that brilliant cunning play known as rapier fence.

The rapier was ultimately adopted everywhere by men of courtly habit; but, in England at least, it was not accepted without murmur and vituperation from the older fighting class of swordsmen, especially from the members and admirers of the English Corporation of Defence Masters. As a body Englishmen were as conservative then as they are now. They knew the value of what they had as their own, and distrusted innovations, especially from foreign quarters. The old sword and the buckler were reckoned as your true English weapons: they always went together—in fact sword and buckler play in the 16th century was evidently held to be as national a game as boxing came to be in a later age. Many are the allusions in contemporary dramatic literature to this characteristic national distrust of continental innovations. There is the well-known passage in Porter's play, *The Two Angry Women of Abingdon*, for instance: "Sword and buckler fight," says a sturdy Briton (in much the same tone of disgust as a British lover of fisticuffs might now assume when talking of a French "Mounseer's" foil play), "begins to grow out of use. I am sorry for it. I shall never see good manhood again. If it be once gone, this poking fight with rapier and dagger will come up. Then the tall man (that is, a courageous man and a good sword-and-buckler man) will be spitted like a cat or a rabbit!" The long-sword, that is, the two-hander, was also an essentially national weapon. It was a right-down pleasing and sturdy implement, recalling in good steel the vernacular quarter-staff of old. It required thews and sinews, and, incidentally, much beef and ale. The long-sword man looked perhaps with even greater disfavour than the smaller swashbuckler upon the new-fangled "bird-spit." "Tut, man," says Justice Shallow, typical *laudator* of the good bygone days, on hearing of the ridiculous Frenchman's skill with his rapier, "I could have told you more. In these times you stand on distance, your passes, stoccadoes, and I know not what; 'tis the heart, Master Page; 'tis here, 'tis here. I have seen the time, with my long-sword, I would have made you four tall fellows skip like rats."

Now, sword-and-buckler and long-sword play was no doubt a manly pursuit and a useful. But, as an every-day companion, the long-sword was incongruous to a fastidious cavalier; and, again, the buckler, indispensable adjunct to the broad swashing blade of home production, was hardly more suitable. In Elizabethan days it soon became obvious that the buckler was inadmissible as an item of gentlemanly attire. It was accordingly left to the body attendant; and the gallant took kindly to the fine rapier of Milanese or Toledan make. On the other hand, it is not difficult to understand the rapid popularity gained among the gentry by this nimble rapier, so much reviled by the older fighting men. The rapier, in fact, came in with the taste for "cavaliero"

style, and may be looked upon as its fit outward symbol already in the days of Queen Mary. In Elizabeth's reign it was firmly established as your only gentlemanlike weapon.

The rapier was decidedly a foreigner; yet it suited the Elizabethan age, for it was decorative as well as practical. Its play was picturesque, fantastic—almost euphuistic, one might say—in comparison with the matter-of-fact hanger of older days. Its phraseology had a quaint, rich, southern smack, which connoted outlandish experience and gave those conversant with its intricate distinctions that marvellous character, at once precious and ruffling, which was so highly appreciated by the cavalier youth of the time. The rapier in its heyday was an admirable weapon to look at, a delicious one to wield. And, besides, in proper hands, it was undoubtedly one that was most conclusive. It was, in short, as elegant and deadly as its predecessors were sturdy and brutal.

By the time that the most perfect, namely, the Italian, rapier fence came to be generally taught in England—that is, during the last third of Elizabeth's reign—the theory of swordsmanship, as applied to a single combat, after having passed through many phases of imperfection, was already tolerably simple and practical. (The exact story of its evolution may be found in a work now included in Bohn's Libraries, *Schools and Masters of Fence*.) What may be considered as one of the cardinal actions of regulated sword-play on foot, namely, the lunge, had already been discovered. Although a great many movements which, according to modern notions, would be considered not only unnecessary but actually pernicious, still formed part of the system, it may be doubted whether, considering the character of the weapon, anything very much better could be devised, even in our present state of knowledge.

For it must be remembered that the evolution of the forms of the sword and of the theories concerning its most efficient use are closely connected. It is, in fact, sometimes difficult to decide whether the change in the shape of the weapon was the result of a development of a theory; or whether new theories were elaborated to fit alterations in these shapes due to fashion or any other reason.

When systematic fence came over to England it was already much simplified (it should be noted that improvement in the art, from its earliest days down to the present time, seems always to have been in the direction of simplification); yet, for more than a century from the appearance of the first real treatise, simplification never reached that point which would render impossible a belief in the undoubted efficacy of those "secret thrusts," of that "universal parry," of those ineluctable passes, which every master professed to teach. These precious secrets remain long, among a certain shady class of swordsmen, an object of untiring study, carried on with much the same faith and zest as the quest of the alchemist for his powder of projection, or of the Merchant Adventurer for El Dorado. There can, of course, be no such thing as an insuperable pass, a secret thrust or parry; every attack *can* be parried, every parry can be deceived by suitable movements. Yet there was some justification for the belief in the existence of secrets of swordsmanship in days when, as a rule, lessons of fence were given in jealous privacy; constant practice at one particular pass, especially with the long rapier, which required a great deal of muscular strength, might render any peculiarly fierce, sudden and audacious stroke excessively dangerous to one who did not happen to have opposed that stroke before. Undoubtedly there was little in Elizabethan fencing-schools of what we understand in modern days by loose-play between the pupils; practice was almost invariably conducted between scholar and teacher in private; and thus the opportunities for watching or testing any particular fencer's play were few. Such an opportunity would, as a rule, only occur on occasions of an earnest fight; and the possessor of a specially handy thrust (if it came off at all) would of course take good care that his opponent should not live to ponder over the secret. The secret, such as it was, remained. In this guise it was inevitable that an almost superstitious belief in "secret foynes," in the *botte secrète* of certain practised duellists, should arise.

Be that as it may, there is no doubt that towards the end of the 16th century there were many free-lances in the field of arms who professed to teach, in exchange for much gold, strokes that were not to be parried. From one truculent personage, whom Brantôme mentions, Tappa the Milanese, you could learn how to cut (if it so took your fancy) both eyes out of your adversary's face with a *rinverso tondo*, or circular "reverse of the point." From Caizo, another Italian teacher, at one time much favoured by the French court, lessons were to be had in the special art of ham-stringing. Caizo's *botte secrète* seems to have been nothing more nor less than a *falso manco*, that is, a left-handed drawing cut, at the inside of the knee. But, as practised and taught by him, it was infallible. This stroke has come down to us as *le coup de Jarnac*—a stroke, he it said, which, notwithstanding its bad name, was quite as fair as any in rapier fence. One Le Flamand, a French master in Paris, was reputed the inventor of a jerky time-thrust at the adversary's brows, which was a certainty. This special foyné, which was merely an *imbrocata* at the head, has become legendary in the fencing world as *la botte de Nevers*. English fencers have their own legends about "the very butcher of a silk button," and this brings us to the first writer on the rapier in England, Vincenzo Saviolo, the great expounder of that Italianated fence which was so obnoxious to the old masters, withal so much admired of Elizabethan courtiers; the man, in short, who—there seems to be much internal evidence to show it—was Shakespeare's fencing master.

Vincenzo was not the only foreign master of note established in London during the latter part of Elizabeth's reign. One, Signor Rocco, had, we hear, a very gorgeously appointed academy in Warwick Lane, near St Paul's, where he coined money rapidly at the expense of gulls and gallants alike. But this man came to grief ultimately in an encounter with the longsword with an old-fashioned English master of defence. Another popular teacher was a certain "Geronimo"; but he also met with a melancholy and premature end by the hands of one Cheefe, "a tall man in his fight and natural English," says George Silver, the champion of the Corporation of Masters of Defence. Saviolo, however, seems to have remained unconquered. In his work (*Vincenzo Saviolo, his practise, in two bookes, the first intreating of the use of the Rapier and Dagger, the second of Honor and honorable quarrels*. London. Printed by John Wolfe, 1595) are expounded in a most typical manner the principles of rapier play.

The fencing phraseology of Elizabethan times is highly picturesque, but with difficulty intelligible in the absence of practical demonstration. Without going into technical details it may be pointed out that the long Elizabethan rapier, however admirably balanced it might otherwise be, was still too heavy to admit of quick parries with the blade itself. Thrusts, as a rule, had to be avoided by body movements, by ducking, or by a vault aside (*incartata*), or beaten away with the left hand, the hand being protected with a gauntlet or armed with a dagger. In fact, one may say that the chief characteristic of Elizabethan sword-play was the concerted action of the left hand parrying while the right delivered the attack. Benvolio's description of Tybalt's fight is graphic:—

"With piercing steel he tilts at bold Mercutio's breast,
Who, all as hot, turns deadly point to point,
And with a martial scorn, with one hand beats
Cold death aside, and with the other
Sends it back to Tybalt, whose dexterity
Retorts it . . ."

Of these body movements, in Saviolo's days, the most approved were: the *incartata*, just mentioned; the pass (the "passado," in the ruffling Anglo-Italian jargon), that is, passing of one foot in front of the other whilst delivering the attack; the *bolla lunga*, or lunge; and the *caricado*, which was a far-reaching combination of the two. Of systematic sword movements there were six: *slocata*, a thrust delivered with nails upwards; *imbrocata*, with nails down; *punta-reversa*, any thrust delivered from the left side of the body; *mandritto*, a cut from the right; *rinverso*, one from the left; *stramazone*, a right-down blow with the point of the sword.

The new art of fence, as systematized by the principles of rapier play, was on the whole already accepted in England during the last decade of the 16th century, and was, as we know, destined to endure. Nevertheless, there were still many partisans of the older school: lovers of the national short-sword and the buckler. Their tenets are to be found embodied, in very strenuous language, by the George Silver mentioned above, a member, it would seem, of the now dwindling company of Masters of Defence, in his small work: *Paradoxe of Defence, wherein is proved the true ground of fight to be in the short ancient weapons, etc.* Printed in London, 1599. (The work has been reprinted by Messrs George Bell & Sons.)

The Italians were undoubtedly the leaders in sword-play; but, towards the beginning of the 17th century, the Spaniards developed a peculiar school of their own, which for a short while was all the mode in England as well as in France. The last trace, be it stated, of that school is now extinct. Yet the Spaniard of cavalier days was undoubtedly a formidable duellist; that was no doubt owing to the quality of the man, not of his art. The Italian's fence was artistic; the Spaniard's dexterity was essentially scientific. In Spain were to be found typically those "Captains of Complements," who not only understood in their most intricate mazes the proper "dependencies" for the cartel, but also the mathematical certainties for the "reason demonstrative." These Spanish books are marvellously pedantic; one may as well say it, frankly ridiculous. Spanish masters instructed their scholars on mathematical lines, with the help of diagrams drawn on the floor within a circle, the radius of which bore certain cryptic proportions to length of human arms and Spanish swords. The circle was inscribed in squares and intersected by sundry chords bearing occult but, it was held, incontrovertible relations to probabilities of strokes and parries. The scholar was to step from certain intersections to certain others. If this stepping was correctly done the result was a foregone victory. "A villain," exclaims Mercutio, indignantly, "who fights by the book of arithmetic." Elizabethan comedies bring us many an echo of its great expounder of mathematical swordsmanship, the magnificent Carranza, the *primer inventor de la Ciencia de las Armas*, the writer of treatises so abstruse on "the first and second cause," in questions of honour and swording, that they have never been quite understood to this day.

Perhaps the most curious matter in connexion with the Spanish fence is that the most splendid treatise of the sword published in the French language is in reality purely Spanish (we have seen that the first was German, and the second an adaptation of Italian treatises). This third work, *Académie de l'épée de Girard Thibault, d'Anvers, etc.*, is indeed a monument; one of the biggest books ever printed, and beyond compare the biggest book of fence. It was issued in 1628 by the Leiden Elzevirs, and took fifteen years to complete. Nine reigning princes and a vast number of private gentlemen subscribed to meet its stupendous expenses.

This work was spoken of as a "monument." It may, in some respects, be looked upon as the funeral monument of the old rapier fence; for soon after that period rose an entirely new school, one adapted to the use of a less portentous weapon, the small-sword of French pattern; a school destined to endure, and to lead to the perfection of our modern *escrime*.

The evolution of this new school is an instance of the influence of fashion upon the shape of the sword, and hence upon theories concerning its use. The French school of fencing may be said to owe its origin to the adoption, under Louis XIV., of the short court-sword in place of the over-long wide-hilted rapier of the older style. With a weapon of such reduced dimensions, of such reduced weight, the advantage of the dagger as a fencing adjunct at once ceased to be felt. The dagger, last Gothic remnant, disappeared accordingly; and there arose rapidly a new system of play, in which most of the defensive actions were performed by the blade alone; in which, at the same time (the reduction in the size and weight of the weapon rendering the efficiency of the edge almost nugatory in comparison with that of the point), all cutting action was ultimately discarded.

It is from that date, namely, from the last third of the 17th century, that the sword, as a fighting implement, becomes differentiated into two very different directions. The military weapon becomes the back-sword or sabre; the walking companion and duelling weapon becomes what we now understand by the small-sword. Two utterly different kinds of fence are practised: one, that of the back-sword; the other, what we would now call foil-play.

The magnificent old cut and thrust rapier still flourished, it is true, in parts of Italy and Spain; but by the end of the 17th century it had already become an object of ridicule in the eyes of all persons addicted to *bon ton*—and it must be remembered that *bon ton*, on the Continent everywhere and even in England, at that time, was French *ton*. The walking sword, fit for a gentleman's side, was therefore the small-sword of Versailles pattern. Its use had to be learnt from French masters of deportment; the old magniloquent Italo-Spanish rapier jargon was forgotten; French terms, barbarized into *carte, tierce, sagoon, flanquonade*, and so forth, were alone understood. In fact, French fencing became as indispensable an accomplishment to the Georgian gentlemen as the fine Italianated foyning had been to the Elizabethan.

The new French sword-play was, it must be owned, very neat, quiet, precise, and, if anything, even more deadly than the old fence. It was perfect as a decorous mode of fight, and as well suited to the lace ruffles, to the high perruque and the red heels of the "beau" as the long cup-hilted rapier had been to the booted and spurred "cavalier." The essence of its play was nimbleness of wrist; it required quickness of spirit rather than muscular vigour. It is to be noted, however, that the same sort of popular opposition met the invasion of French fencing, in post-Restoration days, that had been offered to the new-fangled Italian rapier a century earlier. During the Parliamentary period the rapier and its attendant dagger had practically disappeared; they were not true warlike weapons, their chief virtue was for duelling or sudden encounters. But the stout English back-sword survived; and with it a very definite school of back-sword play. Under Charles II., the amusement of stage or prize-fighting with swords had become *à la mode*. Courteous assaults at many weapons, of course rebated, had been frequent functions under the auspices of the Corporation of Masters of Defence during the second half of the 16th century; it is (be it remarked) in such sword-matches on the scaffold that we find the origin of our modern prize-fights at fisticuffs. The first instance known of a challenge at sharps on the fighting stage is seen in a cartel sent by George Silver and Toby his son, as champions of the Corporation of Masters of Defence, to the obnoxious "Signors" Saviolo and Geronimo. As a matter of fact, the latter, having apparently no wish to improve their excellent social position or to risk forfeiting it, declined this invitation to a public trial of skill. But the idea was right martial and pleasing to the English mind, and the fashion of prize-fighting took the firm hold it retained on English minds till stringent legislation, not so very long ago, was brought to bear upon it. Be it as it may, this prize-fighting with swords endured until middle Georgian days; when, under the impetus given to fistic displays then by the renowned Figg (who was at one and the same time the most formidable of English fencers and the first on the long list of English pugilistic champions), back-swording became relegated to the provinces, and ultimately dwindled into our bastard "single-stick."

Fencing, in its restricted sense of purely thrusting play, was always an "academic" art in England. The first great advocate and exponent of the new small-sword fence, as taught by the new French school, was Sir William Hope of Balcomy, at one time deputy governor of Edinburgh Castle, who wrote a great number of quaint treatises of great interest to the "operative" as well as to the "speculative" fencer. Yet, oddly enough, Sir William Hope was instrumental in endeavouring to push through parliament a bill for the establishment of a court of honour, the office of which was to have been the deciding of honourable quarrels, whenever possible, without appeal to fencing skill. The House,

however, being at the time excited and busy on the question of the union of Scotland and England, the bill never became act.

To resume: since it began to be practised as a regulated art one may say broadly that sword play has already passed through four main phases. The first belongs to the early Tudor days of sword and buckler encounters, whereof, if the best theoretical treatises appeared in Italy, the sturdiest practical exponents were most probably found in the British Isles. Then came the age of the rapier, coeval with the general disuse of the buckler. There may be discerned the dawn of fencing proper, which will fully arise when, in Caroline times, the outrageous length of the tucke will at last be sufficiently reduced no longer to require the dagger as a helpmate. The third was the age of the small-sword. With its light, elegant and deadly practice we enter a new atmosphere, so to speak, on fencing ground. Suppleness of wrist and precision of fingering replace the ramping and traversing, the heavy forcing play, of the Elizabethan. If the rapier age was well exemplified by Vincent Saviolo, this one was typified, albeit perhaps at a time when it was already somewhat on the wane, by the admirable Angelo Tremamondo Malevolti.

In the early days of the small-sword age men still fenced in play as they fought in earnest. But presently there appeared on the scene (during the last years of the 18th century) an implement destined to revolutionize the art and hopelessly to divide the practice of the school from that of the field: that was the fencing mask. Before this invention, small-sword play in the master's room was perforce comparatively cautious, correct, sure and above all deliberate. The long, excited, argumentative phrases of modern assaults were unknown; and so was the almost inevitably consequent scrimmage. But under the protection of the fencing mask a new school of foil-play was evolved, one in which swiftness and inveteracy of attack and parry, of *riposte*, *remise*, *counter-riposte* and *reprise*, assumed an all-important character. With the new style began to assert itself that utter recklessness of "chance hits" which in our days so markedly differentiates foil-practice from actual duelling. And this brings us to the fourth phase, the fencing art, to what may be called the age of the foil.

If anything were required to demonstrate that foil-play has nowadays passed into the state of what may be called fine art in athleticism, it would be found in the rise of the method which French masters particularize as *le jeu du terrain*, as duelling play in fact; a play which differs as completely from academic foil-fencing as cross-country riding in an unknown district from the *haute école* of horsemanship in the *manège*. By fencing, nowadays, that is by foil-play, we have come to mean not simply fighting for hits, but a strictly regulated game which, being quite conventional, does not take accidental hits into consideration at all. This game requires for its perfect display a combination of artificial circumstances, such as even floors, featherweight weapons, and an unconditional acceptance of a number of traditional conventions. Now, for the more utilitarian purposes of duelling, the major part of the foil fencer's special achievement and brilliancy has to be uncompromisingly sacrificed in the presence of the brutal fact that thrusts in the face, or below the waist, do count, inasmuch as they may kill; that *accidental* hits in the arm or the leg cannot be disregarded, for they may, and generally do, put a premature stop to the bout. The "rub on the green" must be accepted, perforce, and indeed often plays as important a part in the issue of the game as the player's skill. The fact, however, that in earnest encounters all conventionalities which determine the value of a hit vanish, does not in any way justify the notion, prevalent among many, that a successful hit justifies any method of planting the same; and that the mere discarding of all convention in practical sword-play is sufficient to convert a bad fencer into a dangerous duellist.

It is the recognition of this fact (which, oddly enough, only came to be generally admitted, and not without reluctance, by the masters of the art during the last quarter of the 19th century) which has led to the elaboration of the modified system of small-sword fence now known as *épée* play. The new system, after passing through various rather extravagant phases of its

own, gradually returned to the main principle of sound foil-play, but shorn of all futile conventions as to the relative values of hits. In *épée* play a hit is a hit, whether correctly delivered or reckless, whether intentional or the result of mere chance, and must, at the cost of much caution and patience, be guarded against.

Per contra the elaboration by the devotees of the *épée* of a really practical system of fence, that is, one applicable to trials in earnest, has reacted upon the teaching of foil-play by the best masters of the present day—a teaching which, without ceasing to be academical up to a certain point, takes now cognisance of the necessity of defending every part of the body as sedulously as the target of the breast, and, moreover, of warding the many possibilities of chance hits in *contretemps*.

In both plays—in the highly refined, complicated and brilliant fence of the first-class "foil," as well as in the simpler and more cautious operations of the practised duellist—the one golden rule remains, that one so quaintly expressed by M. Jourdain's *matre d'armes* in Molière's comedy: "Tout le secret des armes ne consiste qu'en deux choses, à donner et à ne point recevoir."

The point most usually lost sight of by sanguine and self-reliant scornors of conventionalities is that, although with the sword it may be comparatively easy at any time "to give," it is by no means easy to make sure of "giving without receiving." The mutual simultaneous hit—the *coup-double*—is, in fact, the dread pitfall of all sword-play. For this reason, in courteous bouts, a hit has no real value, not only when it is actually cancelled by a counter, but when it is delivered in such a way as to admit of a counter. In short, the experience of ages and the careful consideration of probabilities have given birth to the various make-believes and restrictions that go to make sound foil-play. These restrictions are destined to act in the same direction as the warning presence of a sharp point instead of a button; and thus, as far as possible, to prevent those mutual hits—the *contretemps* of the old masters—which mar the greater number of assaults. The proper observance of those conventions, other things being equal, distinguishes the good from the indifferent swordsman, the man who uses his head from him who rushes blindly where angels fear to tread. So much for foil-play.

In modern sword-play, on the other hand, is seen the usual tendency of arts which have reached their climax of complication to return to comparative simplicity. With reference to actual duelling, it is a recognized thing that it would be the height of folly to attempt, sword in hand, the complex attacks, the full-length lunges, the neat but somewhat weak parries of the foil; so much so, that many have been led to assert that, for its ultimate practical purpose (which logically is that of duelling), the refined art of the foil, requiring so many years of assiduous and methodical work, is next to useless. It is alleged, as a proof, that many successful duellists have happened to be indifferent performers on the fencing floor. Some even maintain that a few weeks' special work in that restricted—very restricted—play, which alone can be considered safe on the field of honour, will produce as good a practical swordsman as any who have walked the schools for years. Nothing can be further from the truth: were it but on the ground that the greater includes the less; that the foil-fencer of standing who can perform with ease and accuracy all the intricate movements of the assault, who has trained his hand and eye to the lightning speed of the well-handled foil, must logically prove more than a match for the more purely practical but less trained devotees of the *épée de combat*. The only difference for him in the two plays is that the latter is incomparably slower in action, simpler; that it demands above all things patience and caution; and especially that, instead of protecting his breast only, the *épée* fencer must beware of the wily attack, or the chance hit, at every part of his body, especially at his sword-hand.

The difference which still exists between the French and Italian schools of small-sword fence—by no means so wide, in point of theory, as popularly supposed—is mainly due to the dissimilarity of the weapons favoured by the two countries. The quillons, which are retained to this day in the Italian

fioletto and *spada*, conduce to a freer use of wrist-play and a straight arm. The French, on the other hand, having long ago adopted the plain grip both for *fleuret* and *épée*, have come to rely more upon finger-play and a semi-bent arm. Both schools have long laid claims to an overwhelming superiority, on theoretical ground, over their rivals—claims which were unwarrantable. Indeed, of later days, especially since the evolution of a special "duelling play," the two schools show a decided tendency, notwithstanding the difference in the grip of the weapons, towards a mutual assimilation of principles.

As a duelling weapon—as one, that is to say, the practice of which under the restrictive influence of conventions could become elaborated into an art—the sabre (see SABRE-FENCING) returned to favour in some countries at the close of the Napoleonic wars. Considered from the historical point of view, the modern sabre, albeit now a very distant cousin of the small-sword, is as direct a descendant as the latter itself of the old cut-and-thrust rapier. It is curious, therefore, to note that, just as the practice of the "small" or thrusting sword gave rise to two rival schools, the French and the Italian, that of the sabre or cutting sword (it can hardly be called the broadsword, the blade, for the purposes of duelling play, having been reduced to slenderest proportions) became split up into two main systems, Italian and German. And further it is remarkable that the leading characteristics of the latter should still be, in a manner, "severity" and steadfastness; and that the former, the Italian, should rely, as of yore, specially upon agility and insidious cunning.

Concerning the latter-day evolution of that special and still more conventional system of fence, the *Schläger* or *Hau-riepier* play favoured by the German student, from that of the ancestral rapier, the curious will find a critical account in an article entitled "*Schlägerei*" which appeared in the *Saturday Review*, 5th of December 1885.

See also the separate articles on CANE-FENCING (*canne*); ÉPÉE-DE-COMBAT; FOIL-FENCING; SABRE-FENCING; and SINGLE-STICK.

AUTHORITIES.—The bibliography of fencing is a copious subject; but it has been very completely dealt with in the following works: *Bibliotheca dimicatoria*, in the "Fencing, Boxing and Wrestling" volume of the Badminton library (Longmans); *A Bibliography of Fencing and Duelling*, by Carl A. Thimm (John Lane). For French works more especially: *La Bibliographie de l'escrime*, by Vigeant (Paris, Motteroz); and *Ma Collection d'escrime*, by the same (Paris, Quantin). For Italian books: *Bibliografia generale della scherma*, by Gelli (Firenze, Niccolai). For Spain and Portugal: *Libros de esgrima españoles y portugueses*, by Leguina (Madrid, Los Huérfanos). Both M. Vigeant's and Cav. Gelli's works deal with the subject generally; but their entries are only critical, or even tolerably accurate, in the case of books belonging to their own countries. Concerning the history of the art, Egerton Castle's *Schools and Masters of Fence* (George Bell); Hutton's *The Sword and the Centuries* (Grant Richards); and Letainturier-Fradin's *Les Joueurs d'épée à travers les âges* (Paris, Flammarion) cover the ground, technically and ethically. As typical exponents of the French and Italian schools respectively may be mentioned here: *La Théorie de l'escrime*, by Prévost (Paris, de Brunhof) (this is the work which was adopted in the Badminton volume on Fencing), and *Trattato teorico-pratico della scherma*, by Parise (Rome, Voghera). (E. CA.)

FENDER, a metal guard or defence (whence the name) for a fire-place. When the open hearth with its logs burning upon dogs or andirons was replaced by the closed grate, the fender was devised as a finish to the smaller fire-places, and as a safeguard against the dropping of cinders upon the wooden floor, which was now much nearer to the fire. Fenders are usually of steel, brass or iron, solid or pierced. Those made of brass in the latter part of the 18th and the earlier part of the 19th centuries are by far the most elegant and artistic. They usually had three claw feet, and the pierced varieties were often cut into arabesques or conventional patterns. The lyre and other motives of the Empire style were much used during the prevalence of that fashion. The modern fender is much lower and is often little more than a kerb; it is now not infrequently of stone or marble, fixed to the floor.

FÉNELON, BERTRAND DE SALIGNAC, seigneur de la Mothe (1523-1589), French diplomatist, came of an old family of Périgord. After serving in the army he was sent ambassador to

England in 1568. At the request of Charles IX. he endeavoured to excuse to Elizabeth the massacre of St. Bartholomew as a necessity caused by a plot which had been laid against the life of the king of France. For some time after the death of Charles IX. Fénelon was continued in his office, but he was recalled in 1575 when Catherine de' Medici wished to bring about a marriage between Elizabeth and the duke of Alençon, and thought that another ambassador would have a better chance of success in the negotiation. In 1582 Fénelon was charged with a new mission to England, then to Scotland, and returned to France in 1583. He opposed the Protestants until the end of the reign of Henry III., but espoused the cause of Henry IV. He died in 1589. His nephew in the sixth degree was the celebrated archbishop of Cambrai.

Fénelon is the author of a number of writings, among which those of general importance are *Mémoires touchant l'Angleterre et la Suisse, ou Sommaire de la négociation faite en Angleterre, l'an 1571* (containing a number of the letters of Charles and his mother, relating to Queen Elizabeth, Queen Mary and the Bartholomew massacre), published in the *Mémoires* of Castelnau (Paris, 1659); *Négociations de la Mothe Fénelon et de Michel, sieur de Mauvissière, en Angleterre*; and *Dépêches de M. de la Mothe Fénelon, Instructions au sieur de la Mauvissière*, both contained in the edition of Castelnau's *Mémoires*, published at Brussels in 1731. The correspondence of Fénelon was published at Paris in 1838-1841, in 7 vols. 8vo.

See "Lettres de Catherine de' Médicis," edited by Hector de la Ferrière (1880 seq.) in the *Collection de documents inédits sur l'histoire de France*.

FÉNELON, FRANÇOIS DE SALIGNAC DE LA MOTHE (1651-1715), French writer and archbishop of Cambrai, was born at the château of Fénelon in Périgord on the 6th of August 1651. His father, Pons, comte de Fénelon, was a country gentleman of ancient lineage, large family and small estate. Owing to his delicate health the boy's early education was carried on at home; though he was able to spend some time at the neighbouring university of Cahors. In 1666 he came to Paris, under charge of his father's brother, Antoine, marquis de Fénelon, a retired soldier of distinction, well known for his religious zeal. Three years later he entered the famous theological college of Saint Sulpice. Here, while imbibing the somewhat mystical piety of the house, he had an excellent chance of carrying on his beloved classical studies; indeed, at one time he proposed to couple sacred and profane together, and go on a missionary journey to the Levant. "There I shall once more make the Apostle's voice heard in the Church of Corinth. I shall stand on that Areopagus where St. Paul preached to the sages of this world an unknown God. But I do not scorn to descend thence to the Piræus, where Socrates sketched the plan of his republic. I shall mount to the double summit of Parnassus; I shall revel in the joys of Tempe." Family opposition, however, put an end to this attractive prospect. Fénelon remained at Saint Sulpice till 1679, when he was made "superior" of a "New Catholic" sisterhood in Paris—an institution devoted to the conversion of Huguenot ladies. Of his work here nothing is known for certain. Presumably it was successful; since in the winter of 1685, just after the revocation of the edict of Nantes, Fénelon was put at the head of a number of priests, and sent on a mission to the famous Huguenot citadel of La Rochelle. To Fénelon such employment was clearly uncongenial; and if he was rather too ready to employ unsavoury methods—such as bribery and espionage—among his proselytes, his general conduct was kindly and statesmanlike in no slight degree. But neither in his actions nor in his writings is there the least trace of that belief in liberty of conscience ascribed to him by 18th-century philosophers. Tender-hearted he might be in practice; but toleration he declares synonymous with "cowardly indulgence and false compassion."

Meanwhile the marquis de Fénelon had introduced his nephew into the devout section of the court, dominated by Mme de Maintenon. He became a favourite disciple of Bossuet, and at the bishop's instance undertook to refute certain metaphysical errors of Father Malebranche. Followed thereon an independent philosophical *Treatise on the Existence of God*, wherein Fénelon rewrote Descartes in the spirit of St Augustine. More important

were his *Dialogues on Eloquence*, wherein he entered an eloquent plea for greater simplicity and naturalness in the pulpit, and urged preachers to take the scriptural, natural style of Bossuet as their model, rather than the coldly analytic eloquence of his great rival, Bourdaloue. Still more important was his *Treatise on the Education of Girls*, being the first systematic attempt ever made to deal with that subject as a whole. Hence it was probably the most influential of all Fénelon's books, and guided French ideas on the question all through the 18th century. It holds a most judicious balance between the two opposing parties of the time. On the one side were the *précieuses*, enthusiasts for the "higher" education of their sex; on the other were the heavy Philistines, so often portrayed by Molière, who thought that the less girls knew the better they were likely to be. Fénelon sums up in favour of the cultivated house-wife; his first object was to persuade the mothers to take charge of their girls themselves, and fit them to become wives and mothers in their turn.

The book brought its author more than literary glory. In 1689 Fénelon was gazetted tutor to the duke of Burgundy, eldest son of the dauphin, and eventual heir to the crown. The character of this strange prince has been drawn once for all by Saint-Simon. Shortly it may be said that he was essentially a mass of contradictions—brilliant, passionate to the point of mania, but utterly weak and unstable, capable of developing into a saint or a monster, but quite incapable of becoming an ordinary human being. Fénelon assailed him on the religious side, and managed to transform him into a devotee, exceedingly affectionate, earnest and religious, but woefully lacking in tact and common sense. In justice, however, it should be added that his health was being steadily undermined by a mysterious internal complaint, and that Fénelon's tutorship came to an end on his disgrace in 1697, before the pupil was fifteen. The abiding result of his tutorship is a code of carefully graduated moral lessons—the *Fables*, the *Dialogues of the Dead* (a series of imaginary conversations between departed heroes), and finally *Télémaque*, where the adventures of the son of Ulysses in search of a father are made into a political novel with a purpose. Not, indeed, that Fénelon meant his book to be the literal paper Constitution some of his contemporaries thought it. Like other Utopias, it is an easy-going compromise between dreams and possibilities. Its one object was to broaden Burgundy's mind, and ever keep before his eyes the "great and holy maxim that kings exist for the sake of their subjects, not subjects for the sake of kings." Here and there Fénelon carries his philanthropy to lengths curiously prophetic of the age of Rousseau—fervid denunciation of war, belief in nature and fraternity of nations. And he has a truly 18th-century belief in the all-efficiency of institutions. Mentor proposes to "change the tastes and habits of the whole people, and build up again from the very foundations." Fénelon is on firmer ground when he leads a reaction against the "mercantile system" of Colbert, with its crushing restrictions on trade; or when he sings the praises of agriculture, in the hope of bringing back labour to the land, and thereby ensuring the physical efficiency of the race. Valuable and far-sighted as were these ideas, they fitted but ill into the scheme of a romance. Seldom was Voltaire wider of the mark than when he called *Télémaque* a Greek poem in French prose. It is too *motivé*, too full of ingenious contrivances, to be really Greek. As, in Fénelon's own opinion, the great merit of Homer was his "amiable simplicity," so the great merit of *Télémaque* is the art that gives to each adventure its hidden moral, to each scene some sly reflection on Versailles. Under stress of these pre-occupations, however, organic unity of structure went very much to the wall, and *Télémaque* is a grievous offender against its author's own canons of literary taste. Not that it altogether lost thereby. There is a curious richness in this prose, so full of rhythm and harmony, that breaks at every moment into verse, as it drags itself along its slow and weary way, half-fainting under an overload of epithets. And although no single feature of the book is Greek, there hangs round it a moral fragrance only to be called forth by one who had fulfilled the

vow of his youth, and learnt to breathe, as purely as on "the double summit of Parnassus," the very essence of the antique.

Télémaque was published in 1699. Four years before, Fénelon had been appointed archbishop of Cambrai, one of the richest benefices in France. Very soon afterwards, however, came the great calamity of his life. In the early days of his tutorship he had met the Quietist apostle, Mme Guyon (*q.v.*), and had been much struck by some of her ideas. These he developed along lines of his own, where Christian Neoplatonism curiously mingles with theories of chivalry and disinterestedness, borrowed from the *précieuses* of his own time. His mystical principles are set out at length in his *Maxims of the Saints*, published in 1697 (see QUIETISM). Here he argues that the more love we have for ourselves, the less we can spare for our Maker. Perfection lies in getting rid of self-hood altogether—in never thinking of ourselves, or even of the relation in which God stands to us. The saint does not love Christ as *his* Redeemer, but only as *the* Redeemer of the human race. Bossuet (*q.v.*) attacked this position as inconsistent with Christianity. Fénelon promptly appealed to Rome, and after two years of bitter controversy his book was condemned by Innocent XII. in 1699. As to the merits of the controversy opinion will always be divided. On the point of doctrine all good judges agree that Fénelon was wrong; though many still welcome the *obiter dictum* of Pope Innocent, that Fénelon erred by loving God too much, and Bossuet by loving his neighbour too little. Of late years, however, Bossuet has found powerful defenders; and if they have not cleared his character from reproach, they have certainly managed to prove that Fénelon's methods of controversy were not much better than his. One of the results of the quarrel was Fénelon's banishment from court; for Louis XIV. had ardently taken Bossuet's side, and brought all the batteries of French influence to bear on the pope. Immediately on the outbreak of the controversy, Fénelon was exiled to his diocese, and during the last eighteen years of his life he was only once allowed to leave it.

To Cambrai, accordingly, all his energies were now directed. Even Saint-Simon allows that his episcopal duties were perfectly performed. Tours of inspection, repeated several times a year, brought him into touch with every corner of his diocese. It was administered with great strictness, and yet on broad and liberal lines. There was no bureaucratic fussiness, no seeking after popularity; but every man, whether great or small, was treated exactly as became his station in the world. And Saint-Simon bears the same witness to his government of his palace. There he lived with all the piety of a true pastor, yet with all the dignity of a great nobleman, who was still on excellent terms with the world. But his magnificence made no one angry, for it was kept up chiefly for the sake of others, and was exactly proportionate to his place. With all its luxuries and courtly ease, his house remained a true bishop's palace, breathing the strictest discipline and restraint. And of all this chastened dignity the archbishop was himself the ever-present, ever-inimitable model—in all that he did the perfect churchman, in all the high-bred noble, in all things, also, the author of *Télémaque*.

The one great blot on this ideal existence was his persecution of the Jansenists (see JANSENISM). His theories of life were very different from theirs; and they had taken a strong line against his *Maxims of the Saints*, holding that visionary theories of perfection were ill-fitted for a world where even the holiest could scarce be saved. To suppress them, and to gain a better market for his own ideas, he was even ready to strike up an alliance with the Jesuits, and force on a reluctant France the doctrine of papal infallibility. His time was much better employed in fitting his old pupil, Burgundy, for a kingship that never came. Louis XIV. seldom allowed them to meet, but for years they corresponded; and nothing is more admirable than the mingled tact and firmness with which Fénelon spoke his mind about the prince's faults. This exchange of letters became still more frequent in 1711, when the wretched dauphin died and left Burgundy heir-apparent to the throne. Fénelon now wrote a series of memorable criticisms on the government of Louis XIV., accompanied by projects of reform, not always quite so wise. For his practical

political service was to act as an alarm-bell. Much more clearly than most men, he saw that the Bourbons were tottering to their fall, but how to prevent that fall he did not know.

Not that any amount of knowledge would have availed. In 1712 Burgundy died, and with him died all his tutor's hopes of reform. From this moment his health began to fail, though he mustered strength enough to write a remarkable *Letter to the French Academy* in the autumn of 1714. This is really a series of general reflections on the literary movement of his time. As in his political theories, the critical element is much stronger than the constructive. Fénelon was feeling his way away from the rigid standards of Boileau to "a Sublime so simple and familiar that all may understand it." But some of his methods were remarkably erratic; he was anxious, for instance, to abolish verse, as unsuited to the genius of the French. In other respects, however, he was far before his age. The 17th century has treated literature as it treated politics and religion; each of the three was cooped up in a water-tight compartment by itself. Fénelon was one of the first to break down these partition-walls, and insist on viewing all three as products of a single spirit, seen at different angles.

A few weeks after the *Letter* was written, Fénelon met with a carriage-accident, and the shock proved too much for his enfeebled frame. On the 7th of January 1715 he died at the age of 63. Ever since, his character has been a much-discussed enigma. Bossuet can only be thought of as the high-priest of authority and common-sense; but Fénelon has been made by turns into a sentimentalist, a mystical saint, an 18th-century *philosophe*, an ultramontane churchman and a hysterical hypocrite. And each of these views, except the last, contains an element of truth. More than most men, Fénelon "wanders between two worlds—one dead, the other powerless to be born." He came just at a time when the characteristic ideas of the 17th century—the ideas of Louis XIV., of Bossuet and Boileau—had lost their savour, and before another creed could arise to take their place. Hence, like most of those who break away from an established order, he seems by turns a revolutionist and a reactionary. Such a man expresses his ideas much better by word of mouth than in the cold formality of print; and Fénelon's contemporaries thought far more highly of his conversation than his books. That downright, gossiping German princess, the duchess of Orleans, cared little for the *Maxims*; but she was enraptured by their author, and his "ugly face, all skin and bone, though he laughed and talked quite unaffectedly and easily." An observer of very different mettle, the great lawyer d'Aguesseau, dwells on the "noble singularity, that gave him an almost prophetic air. Yet he was neither passionate nor masterful. Though in reality he governed others, it was always by seeming to give way; and he reigned in society as much by the attraction of his manners as by the superior virtue of his parts. Under his hand the most trifling subjects gained a new importance; yet he treated the gravest with a touch so light that he seemed to have invented the sciences rather than learnt them, for he was always a creator, always original, and himself was imitable of none." Still better is Saint-Simon's portrait of Fénelon as he appeared about the time of his appointment to Cambrai—tall, thin, well-built, exceedingly pale, with a great nose, eyes from which fire and genius poured in torrents, a face curious and unlike any other, yet so striking and attractive that, once seen, it could not be forgotten. There were to be found the most contradictory qualities in perfect agreement with each other—gravity and courtliness, earnestness and gaiety, the man of learning, the noble and the bishop. But all centred in an air of high-bred dignity, of graceful, polished seemliness and wit—it cost an effort to turn away one's eyes.

AUTHORITIES.—The best complete edition of Fénelon was brought out by the abbé Gosselin of Saint Sulpice (10 vols., Paris, 1851). Gosselin also edited the *Histoire de Fénelon*, by Cardinal Bausset (4 vols., Paris, 1850). Modern authorities are *Fénelon à Cambrai* (Paris, 1885), by Emmanuel de Broglie; *Fénelon*, by Paul Janet (Paris, 1892); *Bossuet et Fénelon*, by L. Crouslé (2 vols., Paris, 1894); J. Lemaître, *Fénelon* (1910). In English there are: *Fénelon, his Friends and Enemies*, by E. K. Sanders (1901); and *François de Fénelon*, by Lord St Cyres (1906); see also the *Quarterly Review* for January 1902, and M. Masson, *Fénelon et Madame Guyon* (1907). (St. C.)

FENESTELLA, Roman historian and encyclopaedic writer, flourished in the reign of Tiberius. If the notice in Jerome be correct, he lived from 52 B.C. to A.D. 19 (according to others 35 B.C.—A.D. 36). Taking Varro for his model, Fenestella was one of the chief representatives of the new style of historical writing which, in the place of the brilliant descriptive pictures of Livy, discussed curious and out-of-the-way incidents and customs of political and social life, including literary history. He was the author of an *Annales*, probably from the earliest times down to his own days. The fragments indicate the great variety of subjects discussed: the origin of the appeal to the people (*provocatio*); the use of elephants in the circus games; the wearing of gold rings; the introduction of the olive tree; the material for making the toga; the cultivation of the soil; certain details as to the lives of Cicero and Terence. The work was very much used (mention is made of an abridged edition) by Pliny the elder, Asconius Pedianus (the commentator on Cicero), Nonius, and the philologists.

Fragments in H. Peter, *Historicorum Romanorum fragmenta* (1883); see also monographs by L. Mercklin (1844) and J. Poeth (1849); M. Schanz, *Geschichte der röm. Litt.* ed. 2 (1901); Teuffel, *Hist. of Roman Literature*, p. 259. A work published under the name of L. Fenestella (*De magistratibus et sacerdotiis Romanorum*, 1510) is really by A. D. Fiocchi, canon and papal secretary, and was subsequently published as by him (under the latinized form of his name, Floccus), edited by Aegidius Witsius (1561).

FENESTRATION (from O. Fr. *fenestre*, modern *fenêtre*, Lat. *fenestra*, a window, connected with Gr. *φαίεω*, to show), an architectural term applied to the arrangement of windows on the front of a building, more especially when, in the absence of columns or pilasters separating them, they constitute its chief architectural embellishment. The term "fenestral" is given to a frame or "chassis" on which oiled paper or thin cloth was strained to keep out wind and rain when the windows were not glazed.

FENIANS, or FENIAN BROTHERHOOD, the name of a modern Irish-American revolutionary secret society, founded in America by John O'Mahony (1816–1877) in 1858. The name was derived from an anglicized version of *fiann*, *féinne*, the legendary band of warriors in Ireland led by the hero Find Mac Cumail (see FINN MAC COOL; and CELT: *Celtic Literature: Irish*); and it was given to his organization of conspirators by O'Mahony, who was a Celtic scholar and had translated Keating's *History of Ireland* in 1857. After the collapse of William Smith O'Brien's attempted rising in 1848, O'Mahony, who was concerned in it, escaped abroad, and since 1852 had been living in New York. James Stephens, another of the "men of 1848," had established himself in Paris, and was in correspondence with O'Mahony and other disaffected Irishmen at home and abroad. A club called the Phoenix National and Literary Society, with Jeremiah Donovan (afterwards known as O'Donovan Rossa) among its more prominent members, had recently been formed at Skibbereen; and under the influence of Stephens, who visited it in May 1858, it became the centre of preparations for armed rebellion. About the same time O'Mahony in the United States established the "Fenian Brotherhood," whose members bound themselves by an oath of "allegiance to the Irish Republic, now virtually established," and swore to take up arms when called upon and to yield implicit obedience to the commands of their superior officers. The object of Stephens, O'Mahony and other leaders of the movement was to form a great league of Irishmen in all parts of the world against British rule in Ireland. The organization was modelled on that of the French Jacobins at the Revolution; there was a "Committee of Public Safety" in Paris, with a number of subsidiary committees, and affiliated clubs; its operations were conducted secretly by unknown and irresponsible leaders; and it had ramifications in every part of the world, the "Fenians," as they soon came to be generally called, being found in Australia, South America, Canada, and above all in the United States, as well as in the large centres of population in Great Britain such as London, Manchester and Glasgow. It is, however, noteworthy that Fenianism never gained much hold on the tenant-farmers or agricultural labourers in Ireland, although the scurrilous press by which it

was supported preached a savage vendetta against the landowners, who were to be shot down "as we shoot robbers and rats."¹ The movement was denounced by the priests of the Catholic Church.

It was, however, some few years after the foundation of the Fenian Brotherhood before it made much headway, or at all events before much was heard of it outside the organization itself, though it is probable that large numbers of recruits had enrolled themselves in its "circles." The Phoenix Club conspiracy in Kerry was easily crushed by the government, who had accurate knowledge from an informer of what was going on. Some twenty ringleaders were put on trial, including Donovan, and when they pleaded guilty were, with a single exception, treated with conspicuous leniency. But after a convention held at Chicago under O'Mahony's presidency in November 1863 the movement began to show signs of life. About the same time the *Irish People*, a revolutionary journal of extreme violence, was started in Dublin by Stephens, and for two years was allowed without molestation by the government to advocate armed rebellion, and to appeal for aid to Irishmen who had had military training in the American Civil War. At the close of that war in 1865 numbers of Irish who had borne arms flocked to Ireland, and the plans for a rising matured. The government, well served as usual by informers, now took action. In September 1865 the *Irish People* was suppressed, and several of the more prominent Fenians were sentenced to terms of penal servitude; Stephens, through the connivance of a prison warder, escaped to France. The Habeas Corpus Act was suspended in the beginning of 1866, and a considerable number of persons were arrested. Stephens issued a bombastic proclamation in America announcing an imminent general rising in Ireland; but he was himself soon afterwards deposed by his confederates, among whom dissension had broken out. A few Irish-American officers, who landed at Cork in the expectation of commanding an army against England, were locked up in gaol; some petty disturbances in Limerick and Kerry were easily suppressed by the police.

In the United States, however, the Fenian Brotherhood, now under the presidency of W. R. Roberts, continued plotting. They raised money by the issue of bonds in the name of the "Irish Republic," which were bought by the credulous in the expectation of their being honoured when Ireland should be "a nation once again." A large quantity of arms was purchased, and preparations were openly made for a raid into Canada, which the United States government took no steps to prevent. It was indeed believed that President Andrew Johnson was not indisposed to turn the movement to account in the settlement of the Alabama claims. The Fenian "secretary for war" was General T. W. Sweeny (1820-1892), who temporarily (Jan. 1865-Nov. 1866) was struck off the American army list. The command of the expedition was entrusted to John O'Neill, who crossed the Niagara river at the head of some 800 men on the 1st of June 1866, and captured Fort Erie. But large numbers of his men deserted, and at Ridgeway the Fenians were routed by a battalion of Canadian volunteers. On the 3rd of June the remnant surrendered to the American warship "Michigan"; and the tardy issue of President Johnson's proclamation enforcing the laws of neutrality brought the raid to an ignominious end; the prisoners were released, and the arms taken from the raiders were, according to Henri Le Caron, "returned to the Fenian organization, only to be used for the same purpose some four years later." In December 1867, John O'Neill became president of the Brotherhood in America, which in the following year held a great convention in Philadelphia attended by over 400 properly accredited delegates, while 6000 Fenian soldiers, armed and in uniform, paraded the streets. At this convention a second invasion of Canada was determined upon; while the news of the Clerkenwell explosion in London (see below) was a strong incentive to a vigorous policy. Le Caron (*q.v.*), who, while acting as a secret agent of the English government, held the position of "inspector-general of the Irish Republican Army," asserts that he "distributed fifteen thousand stands of arms and almost

three million rounds of ammunition in the care of the many trusted men stationed between Ogdensburg and St Albans," in preparation for the intended raid. It took place in April 1870, and proved a failure not less rapid or complete than the attempt of 1866. The Fenians under O'Neill's command crossed the Canadian frontier near Franklin, Vt., but were dispersed by a single volley from Canadian volunteers; while O'Neill himself was promptly arrested by the United States authorities acting under the orders of President Grant.

Meantime in Ireland, after the suppression of the *Irish People*, disaffection had continued to smoulder, and during the latter part of 1866 Stephens endeavoured to raise funds in America for a fresh rising planned for the following year. A bold move on the part of the Fenian "circles" in Lancashire had been concerted in co-operation with the movement in Ireland. An attack was to be made on Chester, the arms stored in the castle were to be seized, the telegraph wires cut, the rolling stock on the railway to be appropriated for transport to Holyhead, where shipping was to be seized and a descent made on Dublin before the authorities should have time to interfere. This scheme was frustrated by information given to the government by the informer John Joseph Corydon, one of Stephens's most trusted agents. Some insignificant outbreaks in the south and west of Ireland brought "the rebellion of 1867" to an ignominious close. Most of the ringleaders were arrested, but although some of them were sentenced to death none was executed. On the 11th of September 1867, Colonel Thomas J. Kelly, "deputy central organizer of the Irish Republic," one of the most dangerous of the Fenian conspirators, was arrested in Manchester, whither he had gone from Dublin to attend a council of the English "centres," together with a companion, Captain Deasy. A plot to effect the rescue of these prisoners was hatched by Edward O'Meaher Condon with other Manchester Fenians; and on the 18th of September, while Kelly and Deasy were being conveyed through the city from the court-house, the prison van was attacked by Fenians armed with revolvers, and in the scuffle police-sergeant Brett, who was seated inside the van, was shot dead. Condon, Allen, Larkin, Maguire and O'Brien, who had taken a prominent part in the rescue, were arrested. All five were sentenced to death; but Condon, who was an American citizen, was respited at the request of the United States government, his sentence being commuted to penal servitude for life, and Maguire was granted a pardon. Allen, Larkin, and O'Brien were hanged on the 23rd of November for the murder of Brett. Attempts were made at the time, and have since been repeated, to show that these men were unjustly sentenced, the contention of their sympathizers being, first, that as "political offenders" they should not have been treated as ordinary murderers; and, secondly, that as they had no deliberate intention to kill the police-sergeant, the shot that caused his death having been fired for the purpose of breaking open the lock of the van, the crime was at worst that of manslaughter. But even if these pleas rest on a correct statement of the facts they have no legal validity, and they afford no warrant for the title of the "Manchester martyrs" by which these criminals are remembered among the more extreme nationalists in Ireland and America. Kelly and Deasy escaped to the United States, where the former obtained employment in the New York custom-house.

In the same month, November 1867, one Richard Burke, who had been employed by the Fenians to purchase arms in Birmingham, was arrested and lodged in Clerkenwell prison in London. While he was awaiting trial a wall of the prison was blown down by gunpowder, the explosion causing the death of twelve persons, and the maiming of some hundred and twenty others. This outrage, for which Michael Barrett suffered the death penalty, powerfully influenced W. E. Gladstone in deciding that the Protestant Church of Ireland should be disestablished as a concession to Irish disaffection. In 1870, Michael Davitt (*q.v.*) was sentenced to fifteen years' penal servitude for participation in the Fenian conspiracy; and before he was released on ticket of leave the name Fenian had become practically obsolete, though the "Irish Republican Brotherhood" and other organizations

¹ William O'Connor Morris, *Ireland 1798-1898*, p. 195.

In Ireland and abroad carried on the same tradition and pursued the same policy in later years. In 1879, John Devoy, a member of the Fenian Brotherhood, promoted a "new departure" in America, by which the "physical force party" allied itself with the "constitutional movement" under the leadership of C. S. Parnell (*q.v.*); and the political conspiracy of the Fenians was combined with the agrarian revolution inaugurated by the Land League.

See William O'Connor Morris, *Ireland from 1798 to 1898* (London, 1898); *Two Centuries of Irish History, 1691-1870*, edited by R. Barry O'Brien (London, 1907); Henri Le Caron, *Twenty-five Years in the Secret Service* (London, 1892); Patrick J. P. Tynan, *The Irish National Invincibles and their Times* (London, 1896); Justin M'Carthy, *A History of our own Times* (4 vols., London, 1880). (R. J. M.)

FENNEL, *Foeniculum vulgare* (also known as *F. capillaceum*), a perennial plant of the natural order Umbelliferae, from 2 to 3 or (when cultivated) 4 ft. in height, having leaves three or four times pinnate, with numerous linear or awl-shaped segments, and glaucous compound umbels of about 15 or 20 rays, with no involucre, and small yellow flowers, the petals incurved at the tip. The fruit is laterally compressed, five-ridged, and has a large single resin-canal or "vitta" under each furrow. The plant appears to be of south European origin, but is now met with in various parts of Britain and the rest of temperate Europe, and in the west of Asia. The dried fruits of cultivated plants from Malta have an aromatic taste and odour, and are used for the preparation of fennel water, valued for its carminative properties. It is given in doses of 1 to 2 oz., the active principle being a volatile oil which is probably the same as oil of anise. The shoots of fennel are eaten blanched, and the seeds are used for flavouring. The fennel seeds of commerce are of several sorts. Sweet or Roman fennel seeds are the produce of a tall perennial plant, with umbels of 25-30 rays, which is cultivated near Nismes in the south of France; they are elliptical and arched in form, about $\frac{3}{8}$ in. long and a quarter as broad, and are smooth externally, and of a colour approaching a pale green. Shorter and straighter fruits are obtained from the annual variety of *F. vulgare* known as *F. Panmorium* (*Panmuhuri*) or Indian fennel, and are employed in India in curries, and for medicinal purposes. Other kinds are the German or Saxon fruits, brownish-green in colour, and between $\frac{1}{2}$ and $\frac{1}{4}$ in. in length, and the broader but smaller fruits of the wild or bitter fennel of the south of France. A variety of fennel, *F. dulce*, having the stem compressed at the base, and the umbel 6-8 rayed, is grown in kitchen-gardens for the sake of its leaves.

Giant fennel is the name applied to the plant *Ferula communis*, a member of the same natural order, and a fine berbaceous plant, native in the Mediterranean region, where the pith of the stem is used as tinder. Hog's or sow fennel is the species *Peucedanum officinale*, another member of the Umbelliferae.

FENNER, DUDLEY (c. 1558-1587), English puritan divine, was born in Kent and educated at Cambridge University. There he became an adherent of Thomas Cartwright (1535-1603), and publicly expounded his presbyterian views, with the result that he was obliged to leave Cambridge without taking his degree. For some months he seems to have assisted the vicar of Cranbrook, Kent, but it is doubtful whether he received ordination. He next followed Cartwright to Antwerp, and, having received ordination according to rite of the Reformed church, assisted Cartwright for several years in preaching to the English congregation there. The leniency shown by Archbishop Grindal to puritans encouraged him to return to England, and he became curate of Cranbrook in 1583. In the same year, however, he was one of seventeen Kentish ministers suspended for refusing to sign an acknowledgment of the queen's supremacy and of the authority of the Prayer Book and articles. He was imprisoned for a time, but eventually regained his liberty and spent the remainder of his life as chaplain in the Reformed church at Middleburgh.

A list of his authentic works is given in Cooper's *Athenae Cantabrigienses* (Cambridge, 1858-1861). They rank among the best expositions of the principles of puritanism.

FENNY STRATFORD, a market town in the Buckingham parliamentary division of Buckinghamshire, England, 48 m.

N.W. by N. of London on a branch of the London & North-Western railway. Pop. of urban district (1901), 4799. It lies in an open valley on the west (left) bank of the Ouzel, where the great north-western road from London, the Roman Watling Street, crosses the stream, and is 1 m. E. of Bletchley, an important junction on the main line of the North-Western railway. The church of St Martin was built (c. 1730) on the site of an older church at the instance of Dr Browne Willis, an eminent antiquary (d. 1760), buried here; but the building has been greatly enlarged. A custom instituted by Willis on St Martin's Day (November 11th) includes a service in the church, the firing of some small cannon called the "Fenny Poppers," and other celebrations. The trade of the town is mainly agricultural.

FENRIR, or **FENRIS**, in Scandinavian mythology, a water-demon in the shape of a huge wolf. He was the offspring of Loki and the giantess Angurboda, who bore two other children, Midgard the serpent, and Hel the goddess of death. Fenrir grew so large that the gods were afraid of him and had him chained up. But he broke the first two chains. The third, however, was made of the sound of a cat's footsteps, a man's beard, the roots of a mountain, a fish's breath and a bird's spittle. This magic bond was too strong for him until Ragnarok (Judgment Day), when he escaped and swallowed Odin and was in turn slain by Vidar, the latter's son.

FENS,¹ a district in the east of England, possessing a distinctive history and peculiar characteristics. It lies west and south of the Wash, in Lincolnshire, Huntingdonshire, Cambridgeshire and Norfolk, and extends over more than 70 m. in length (Lincoln to Cambridge) and some 35 m. in maximum breadth (Stamford to Brandon in Suffolk), its area being considerably over half a million acres. Although low and flat, and seamed by innumerable water-courses, the entire region is not, as the Roman name of *Metaris Aestuarium* would imply, a river estuary, but a bay of the North Sea, silted up, of which the Wash is the last remaining portion. Hydrographically, the Fens embrace the lower parts of the drainage-basins of the rivers Witham, Welland, Nene and Great Ouse; and against these streams, as against the ocean, they are protected by earthen embankments, 10 to 15 ft. high. As a rule the drainage water is lifted off the Fens into the rivers by means of steam-pumps, formerly by windmills.

General History.—According to fairly credible tradition, the first systematic attempt to drain the Fens was made by the Romans. They dug a catchwater drain (as the artificial fenland water-courses are called), the Caer or Car Dyke, from Lincoln to Ramsey (or, according to Stukeley, as far as Cambridge), along the western edge of the Fens, to carry off the precipitation of the higher districts which border the fenland, and constructed alongside the Welland and on the seashore earthen embankments, of which some 150 m. survive. Mr S. H. Miller is disposed to credit the native British inhabitants of the Fens with having executed certain of these works. The Romans also carried causeways over the country. After their departure from Britain in the first half of the 5th century the Fens fell into neglect; and despite the preservation of the woodlands for the purposes of the chase by the Norman and early Plantagenet kings, and the unsuccessful attempt which Richard de Rulos, chamberlain of William the Conqueror, made to drain Deeping Fen, the fenland region became almost everywhere waterlogged, and relapsed to a great extent into a state of nature. In addition to this it was ravaged by serious inundations of the sea, for example, in the years 1178, 1248 (or 1250), 1288, 1322, 1335, 1467, 1571. Yet the fenland was not altogether a wilderness of reed-grown marsh and watery swamp. At various spots, more particularly in the north and in the south, there existed islands of firmer and higher ground, resting generally on the boulder clays of the Glacial epochs and on the inter-Glacial gravels of the Palaeolithic age. In these isolated localities members of the monastic

¹ The word "fen," a general term for low marshy land or bog, is common to Teutonic languages, cf. Dutch *ven* or *veen*, Ger. *Fenne*, *Fehn*, Goth. *fani*, mud; the Indo-European root is seen in Gr. *πηλος*, mud, Lat. *palus*, marsh. The word "bog" is from the Irish or Gaelic *bogach*, formed from Celtic *bog*, soft, and meaning therefore soft, swampy ground.

orders (especially at a later date the Cistercians) began to settle after about the middle of the 7th century. At Medeshampstead (*i.e.* Peterborough), Ely, Crowland, Ramsey, Thorney, Spalding, Peakirk, Swineshead, Tattershall, Kirkstead, Bardney, Sempringham, Bourne and numerous other places, they made settlements and built churches, monasteries and abbeys. In spite of the incursions of the predatory Northmen and Danes in the 9th and 10th centuries, and of the disturbances consequent upon the establishment of the Camp of Refuge by Hereward the Wake in the fens of the Isle of Ely in the 11th century, these scattered outposts continued to shed rays of civilization across the lonely Fenland down to the dissolution of the monasteries in the reign of Henry VIII. Then they, too, were partly overtaken by the fate which befell the rest of the Fens; and it was only in the end of the 18th and the beginning of the 19th century that the complete drainage and reclamation of the Fen region was finally effected. Attempts on a considerable scale were indeed made to reclaim them in the 17th century, and the work as a whole forms one of the most remarkable chapters of the industrial history of England. Thus, the reclamation of the Witham Fens was taken up by Sir Anthony Thomas, the earl of Lindsey, Sir William Killigrew, King Charles I., and others in 1631 and succeeding years; and that of the Deeping or Welland Fens in 1638 by Sir W. Ayloff, Sir Anthony Thomas and other "adventurers," after one Thomas Lovell had ruined himself in a similar attempt in the reign of Queen Elizabeth. The earl of Lindsey received 24,000 acres for his work. Charles I., declaring himself the "undertaker" of the Holland Fen, claimed 8000 out of its 22,000 acres as his share.

A larger work than these, however, was the drainage of the fens of the Nene and the Great Ouse, comprehending the wide tract known as the Bedford level. This district took name from the agreement of Francis, earl of Bedford, the principal landholder, and thirteen other adventurers, with Charles I. in 1634, to drain the level, on condition of receiving 95,000 acres of the reclaimed land. A partial attempt at drainage had been made (1478-1490) by John Morton, when bishop of Ely, who constructed Morton's Leam, from Peterborough to the sea, to carry the waters of the Nene, but this also proved a failure. An act was passed, moreover, in 1602 for effecting its reclamation; and Lord Chief-Justice Popham (whose name is preserved in Popham's Eau, S.E. of Wisbech) and a company of Londoners began the work in 1605; but the first effectual attempt was that of 1634. The work was largely directed by the Dutch engineer Cornelius Vermuyden, who had begun work in the Fens in 1621, and was knighted in 1628.

Three years after the agreement of the earl of Bedford and his partners with the king, after an outlay of £100,000 on the part of the company, the contract was annulled, on the fraudulent plea that the works were insufficient; and an offer was made by King Charles to undertake its completion on condition of receiving 57,000 acres in addition to the amount originally agreed on. This unjust attempt was frustrated by the breaking out of the civil war; and no further attempt at drainage was made until 1649, when the parliament reinstated the earl of Bedford's successor in his father's rights. After an additional outlay of £300,000, the adventurers received 95,000 acres of reclaimed land, according to the contract, which, however, fell far short of repaying the expense of the undertaking. In 1664 a royal charter was obtained to incorporate the company, which still exists, and carries on the concern under a governor, 6 bailiffs, 20 conservators, and a commonalty, each of whom must possess 100 acres of land in the level, and has a voice in the election of officers. The conservators must each possess not less than 280 acres, the governor and bailiffs each 400 acres. The original adventurers had allotments of land according to their interest of the original 95,000 acres; but Charles II., on granting the charter, took care to secure to the crown a lot of 12,000 acres out of the 95,000, which, however, is held under the directors, whereas the allotments are not held in common, though subject to the laws of the corporation. The level was divided in 1697 into three parts, called the North, Middle, and South Levels—the

second being separated from the others by the Nene and Old Bedford rivers.

These attempts failed owing to the determined opposition of the native fenmen ("stilt-walkers"), whom the drainage and appropriation of the unenclosed fenlands would deprive of valuable and long-enjoyed rights of commonage, turbarry (turf-cutting), fishing, fowling, &c. Oliver Cromwell is said to have put himself at their head and succeeded in stopping all the operations. When he became Protector, however, he sanctioned Vermuyden's plans, and Scottish prisoners taken at Dunbar, and Dutch prisoners taken by Blake in his victory over Van Tromp, were employed as the workers. Vermuyden's system, however, was exclusively Dutch; and while perfectly suited to Holland it did not meet all the necessities of East Anglia. He confined his attention almost exclusively to the inland draining and embankments, and did not provide sufficient outlet for the waters themselves into the sea.

Holland and other Fens on the west side of the Witham were finally drained in 1767, although not without much rioting and lawlessness; and a striking account of the wonderful improvements effected by a generation later is recorded in Arthur Young's *General View of the Agriculture of the County of Lincoln* (London, 1799). The East, West and Wildmore Fens on the east side of the Witham were drained in 1801-1807 by John Rennie, who carried off the precipitation which fell on the higher grounds by catch-water drains, on the principle of the Roman Car Dyke, and improved the outfall of the river, so that it might the more easily discharge the Fen water which flowed or was pumped into it. The Welland or Deeping Fens were drained in 1794, 1801, 1824, 1837 and other years. Almost the only portion of the original wild Fens now remaining is Wicken Fen, which lies east of the river Cam and south-east of the Isle of Ely.

The Fen Rivers.—The preservation of the Fens depends in an intimate and essential manner upon the preservation of the rivers, and especially of their banks. The Witham, known originally as the Grant Avon, also called the Lindis by Leyland (*Itinerary*, vol. vii. p. 41), and in Jean Ingelow's *High Tide on the Lincolnshire Coast*, is some 80 m. long, and drains an area of 1079 sq. m. It owes its present condition to engineering works carried out in the years 1762-1764, 1865, 1881, and especially in 1880-1884. In 1500 the river was dammed immediately above Boston by a large sluice, the effect of which was not only to hinder free navigation up to Lincoln (to which city sea-going vessels used to penetrate in the 14th and 15th centuries), but also to choke the channel below Boston with sedimentary matter. The sluice, or rather a new structure made in 1764-1766, remains; but the river below Boston has been materially improved (1880-1884), first by the construction of a new outfall, 3 m. in length, whereby the channel was not only straightened, but its current carried directly into deep water, without having to battle against the often shifting sandbanks of the Wash; and secondly, by the deepening and regulation of the river-bed up to Boston. The Welland, which is about 70 m. long, and drains an area of 760 sq. m., was made to assume its present shape and direction in 1620, 1638, 1650, 1794, and 1835 and following years. The most radical alteration took place in 1794, when a new outfall was made from the confluence of the Glen (30 m. long) to the Wash, a distance of nearly 3 m. The Nene, 90 m. long, and draining an area of some 1077 sq. m., was first regulated by Bishop Morton, and it was further improved in 1631, 1721, and especially, under plans by Rennie and Telford, in 1827-1830 and 1832. The work done from 1721 onward consisted in straightening the lower reaches of the stream and in directing and deepening the outfall. The Ouse (*q.v.*) or Great Ouse, the largest of the fenland rivers, seems to have been deflected, at some unknown period, from a former channel connecting via the Old Croft river with the Nene, into the Little Ouse below Littleport; and the courses of the two streams are now linked together by an elaborate network of artificial drains, the results of the great engineering works carried out in the Bedford Level in the 17th century. The old channel, starting from Earith, and known as the Old West river, carries only a small stream until, at a point above Ely, it joins the

Cam. The salient features of the plan executed by Vermuyden¹ for the earl of Bedford in the years 1632-1653 were as follows: taking the division of the area made in 1697-1698 into (i.) the North Level, between the river Welland and the river Nene; (ii.) the Middle Level, between the Nene and the Old Bedford river (which was made at this time, *i.e.* 1630); and (iii.) the South Level, from the Old Bedford river to the south-eastern border of the fenland. In the North Level the Welland was embanked, the New South Eau, Peakirk Drain, and Shire Drain made, and the existing main drains deepened and regulated. In the Middle Level the Nene was embanked from Peterborough to Guyhirn,

meres of Ramsey, Whittlesey (1851-1852), &c., drained and brought under cultivation. A considerable barge traffic is maintained on the Ouse below St Ives, on the Cam up to Cambridge, the Lark and Little Ouse, and the network of navigable cuts between the New Bedford river and Peterborough. The Nene, though locked up to Northampton, and connected from that point with the Grand Junction canal, is practically unused above Wansford, and traffic is small except below Wisbech.

The effect of the drainage schemes has been to lower the level of the fenlands generally by some 18 in., owing to the shrinkage of the peat consequent upon the extraction of so much of its contained water; and this again has tended, on the one hand, to diminish the speed and erosive power of the fenland rivers, and, on the other, to choke up their respective outfalls with the sedimentary matters which they themselves sluggishly roll seawards.

The Wash.—From this it will be plain that the Wash (*q.v.*) is being silted up by riverine detritus. The formation of new dry land, known at first as "marsh," goes on, however, but slowly. During the centuries since the Romans are believed to have constructed the sea-banks which shut out the ocean, it is computed that an area of not more than 60,000 to 70,000 acres has been won from the Wash, embanked, drained and brought more or less under cultivation. The greatest gain has been at the direct head of the bay, between the Welland and the Great Ouse, where the average annual accretion is estimated at 10 to 11 lineal feet. On the Lincolnshire coast, farther north, the average annual gain has been not quite 2 ft.; whilst on the opposite Norfolk coast it has been little more than 6 in. annually. On the whole, some 35,000 acres were enclosed in the 17th century, about 19,000 acres during the 18th, and about 10,000 acres during the 19th century.

The first comprehensive scheme for regulating the outfall channels and controlling the currents of the Fen rivers seems to be that proposed by Nathaniel Kinderley in 1751. His idea² was to link the Nene with the Ouse by means of a new cut to be made through the marshland, and guide the united stream through a further new cut "under Wotten and Wolverton through the Marshes till over against Inglethorpe or Snetsham, and there discharge itself immediately into the Deeps of Lyn Channel." In a similar way the Witham, "when it has received the Welland from Spalding," was to be carried "to some convenient place over against Wrangle or Friskney, where it may be discharged into Boston Deeps." This scheme was still further improved upon by Sir John Rennie, who, in a report which he drew up in 1839, recommended that the outfalls of all four rivers should be directed by means of fascined channels into one common outfall, and that the land lying between them should be enclosed as rapidly as it consolidated. By this means he estimated that 150,000 acres would be won to cultivation.

But beyond one or two abortive or half-hearted attempts, *e.g.* by the Lincolnshire Estuary Company in 1851, and in 1876 and subsequent years by the Norfolk Estuary Company, no serious effort has ever been made to execute either of these schemes.

Climate.—The annual mean temperature, as observed at Boston, in the period 1864-1885, is 48.7° F.; January, 36.5°; July, 62.8°; and as observed at Wisbech, for the period 1861-1875, 49.1°. The average mean rainfall for the seventy-one years 1830-1900, at Boston, was 22.9 in.; at Wisbech for the fifteen years 1860-1875, 24.2 in., and for the fifteen years 1866-1880, 26.7 in.; and at Maxey near Peterborough, 21.7 for the nineteen years 1882-1900. Previous to the drainage of the Fens, ague, rheumatism, and other ailments incidental to a damp

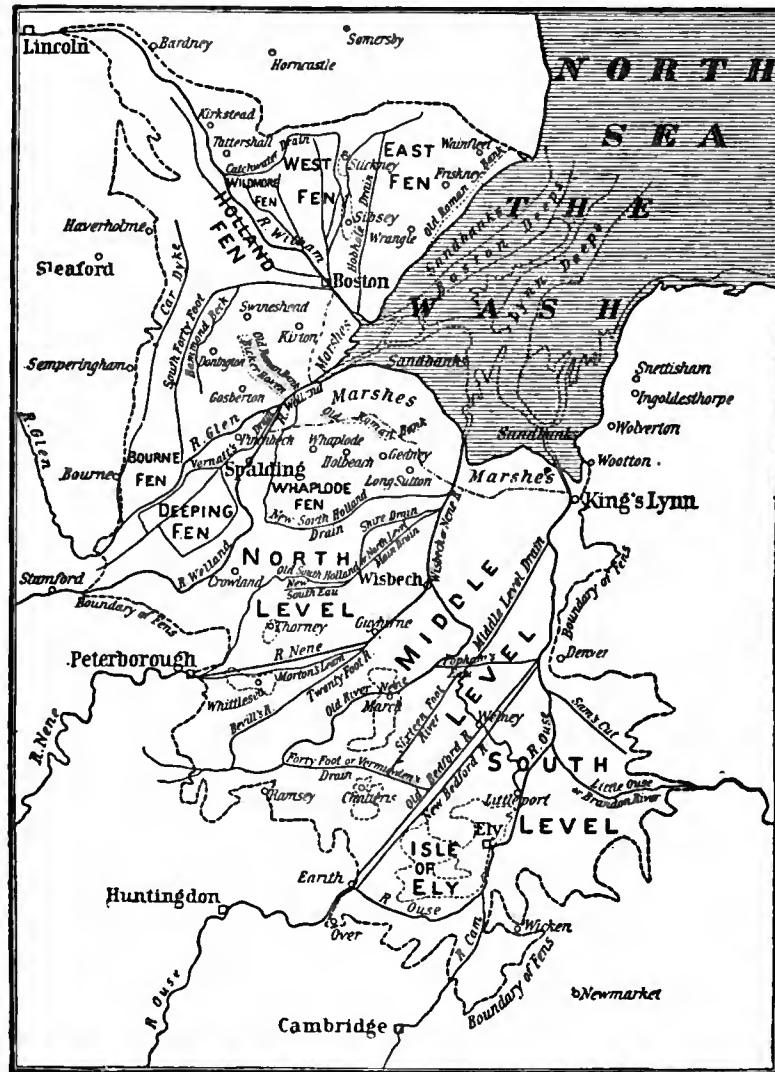

Map of the Fens.

also the Ouse from Earith to Over, both places at the south-west edge of the fenland; the New Bedford river was made from Earith to Denver, and the north side of the Old Bedford river and the south side of the New Bedford river were embanked, a long narrow "wash," or overflow basin, being left between them; several large feeding-drains were dug, including the Forty Foot or Vermuyden's Drain, the Sixteen Foot river, Bevill's river, and the Twenty Foot river; and a new outfall was made for the Nene, and Denver sluice (to dam the old circuitous Ouse) constructed. In the South Level Sam's Cut was dug and the rivers were embanked. Since that period the mouth of the Ouse has been straightened above and below King's Lynn (1795-1821), a new straight cut made between Ely and Littleport, the North Level Main Drain and the Middle Level Drain constructed, and the

¹ The principles upon which he proceeded are set forth in his *Discourse touching the Draining of the Great Fennes* (1642), reprinted in *Fenland Notes and Queries* (1898), pp. 26-38 and 81-87.

² Set forth in *The Present State of the Navigation of the Towns of Lyn, Wisbeach, Spalding and Boston* (2nd ed., London, 1851), pp. 82 seq.

climate were widely prevalent, but at the present day the Fen country is as healthy as the rest of England; indeed, there is reason to believe that it is conducive to longevity.

Historical Notes.—The earliest inhabitants of this region of whom we have record were the British tribes of the Iceni confederation; the Romans, who subdued them, called them Coriceni or Coritani. In Saxon times the inhabitants of the Fens were known (e.g. to Bede) as Gyrvii, and are described as traversing the country on stilts. Macaulay, writing of the year 1689, gives to them the name of Breedlings, and describes them as "a half-savage population . . . who led an amphibious life, sometimes wading, sometimes rowing, from one islet of firm ground to another." In the end of the 18th century those who dwelt in the remoter parts were scarcely more civilized, being known to their neighbours by the expressive term of "Slodgers." These rude fen-dwellers have in all ages been animated by a tenacious love of liberty. Boadicea, queen of the Iceni, the worthy foe of the Romans; Hereward the Saxon, who defied William the Conqueror; Cromwell and his Ironsides, are representative of the fenman's spirit at its best. The fen peasantry showed a stubborn defence of their rights, not only when they resisted the encroachments and selfish appropriations of the "adventurers" in the 17th century, in the Bedford Level, in Deeping Fen, and in the Witham Fens, and again in the 18th century, when Holland Fen was finally enclosed, but also in the Peasants' Rising of 1381, and in the Pilgrimage of Grace in the reign of Henry VIII. So long as the Fens were unenclosed and thickly studded with immense "forests" of reeds, and innumerable marshy pools and "rows" (channels connecting the pools), they abounded in wild fowl, being regularly frequented by various species of wild duck and geese, garganies, polchards, shovelers, teal, widgeons, peewits, terns, grebes, coots, water-hens, water-rails, red-shanks, lapwings, god-wits, whimbrels, cranes, bitterns, herons, swans, ruffs and reeves. Vast numbers of these were taken in decoys¹ and sent to the London markets. At the same time equally vast quantities of tame geese were reared in the Fens, and driven by road² to London to be killed at Michaelmas. Their down, feathers and quills (for pens) were also a considerable source of profit. The Fen waters, too, abounded in fresh-water fish, especially pike, perch, bream, tench, rud, dace, roach, eels and sticklebacks. The Witham, on whose banks so many monasteries stood, was particularly famous for its pike; as were certain of the monastic waters in the southern part of the Fens for their eels. The soil of the reclaimed Fens is of exceptional fertility, being almost everywhere rich in humus, which is capable not only of producing very heavy crops of wheat and other corn, but also of fattening live-stock with peculiar ease. Lincolnshire oxen were famous in Elizabeth's time, and are specially singled out by Arthur Young,³ the breed being the shorthorn. Of the crops peculiar to the region it must suffice to mention the old British dye-plant woad, which is still grown on a small scale in two or three parishes immediately south of Boston; hemp, which was extensively grown in the 18th century, but is not now planted; and peppermint, which is occasionally grown, e.g. at Deeping and Wisbech. In the second half of the 19th century the Fen country acquired a certain celebrity in the world of sport from the encouragement it gave to speed skating. Whenever practicable, championship and other racing meetings are held, chiefly at Littleport and Spalding. The little village of Welney, between Ely and Wisbech, has produced some of the most notable of the typical Fen skaters, e.g. "Turkey" Smart and "Fish" Smart.

Apart from fragmentary ruins of the former monastic buildings of Crowland, Kirkstead and other places, the Fen country of Lincolnshire (division of Holland) is especially remarkable for the size and beauty of its parish churches, mostly built of Barnack rag from Northamptonshire. Moreover, in the posses-

¹ For descriptions of these see Oldfield, Appendix, pp. 2-4, of *A Topographical and Historical Account of Wainfleet* (London, 1829); and Miller and Skertchly, *The Fenland*, pp. 369-375.

² See De Foe's account in *A Tour through the Eastern Counties*, 1722 (1724-1725).

³ *General View*, pp. 174-194 and 288-304.

sion of such buildings as Ely cathedral and the parish church of King's Lynn, other parts of the Fens must be considered only less rich in ecclesiastical architecture. Using these fine opportunities, the Fen folk have long cultivated the science of campanology.

Dialect.—Owing to the comparative remoteness of their geographical situation, and the relatively late period at which the Fens were definitely enclosed, the Fenmen have preserved several dialectal features of a distinctive character, not the least interesting being their close kinship with the classical English of the present day. Professor E. E. Freeman (*Longman's Magazine*, 1875) reminded modern Englishmen that it was a native of the Fens, "a Bourne man, who gave the English language its present shape." This was Robert Manning, or Robert of Brunne, who in or about 1303 wrote *The Handlyng Synne*. Tennyson's dialect poems, *The Northern Farmer*, &c., do not reproduce the pure Fen dialect, but rather the dialect of the Wold district of mid Lincolnshire.

Authorities.—Sir William Dugdale, *History of Imbanking and Draining* (2nd ed., London, 1772); W. Elstobb, *A Historical Account of the Great Level* (Lynn, 1793); W. Chapman, *Facts and Remarks relative to the Witham and the Welland* (Boston, 1800); S. Wells, *History and Drainage of the Great Level of the Fens* (2 vols., London, 1828 and 1830); P. Thompson, *History of Boston* (Boston, 1856); Baldwin Latham, *Papers on the Drainage of the Fens*, read before the Society of Engineers, 3rd November 1862; N. and A. Goodman, *Handbook of Fen Skating* (London, 1882); Moore, *Associated Architectural Societies' Reports and Papers* (1893); *Fenland Notes and Queries*, and *Lincolnshire Notes and Queries*, passim; W. H. Wheeler, *A History of the Fens of South Lincolnshire*, pp. 223 et seq. (2nd ed., Boston, 1897). Various phases of Fen life, mostly of the past, are described in Charles Kingsley's *Hereward the Wake* (Cambridge, 1866); Baring Gould's *Cheap-Jack Zita* (London, 1893); Manville Fenn's *Dick o' the Fens* (London, 1887); and J. T. Bealby's *A Daughter of the Fen* (London, 1896).

FENTON, EDWARD (d. 1603), English navigator, son of Henry Fenton and brother of Sir Geoffrey Fenton (q.v.), was a native of Nottinghamshire. In 1577 he sailed, in command of the "Gabriel," with Sir Martin Frobisher's second expedition for the discovery of the north-west passage, and in the following year he took part as second in command in Frobisher's third expedition, his ship being the "Judith." He was then employed in Ireland for a time, but in 1582 he was put in charge of an expedition which was to sail round the Cape of Good Hope to the Moluccas and China, his instructions being to obtain any knowledge of the north-west passage that was possible without hindrance to his trade. On this unsuccessful voyage he got no farther than Brazil, and throughout he was engaged in quarrelling with his officers, and especially with his lieutenant, William Hawkins, the nephew of Sir John Hawkins, whom he had in irons when he arrived back in the Thames. In 1588 he had command of the "Mary Rose," one of the ships of the fleet that was formed to oppose the Armada. He died fifteen years afterwards.

FENTON, ELIJAH (1683-1730), English poet, was born at Shelton near Newcastle-under-Lyme, of an old Staffordshire family, on the 25th of May 1683. He graduated from Jesus College, Cambridge, in 1704, but was prevented by religious scruples from taking orders. He accompanied the earl of Orrery to Flanders as private secretary, and on returning to England became assistant in a school at Headley, Surrey, being soon afterwards appointed master of the free grammar school at Sevenoaks in Kent. In 1710 he resigned his appointment in the expectation of a place from Lord Bolingbroke, but was disappointed. He then became tutor to Lord Broghill, son of his patron Orrery. Fenton is remembered as the coadjutor of Alexander Pope in his translation of the *Odyssey*. He was responsible for the first, fourth, nineteenth and twentieth books, for which he received £300. He died at East Hampstead, Berkshire, on the 16th of July 1730. He was buried in the parish church, and his epitaph was written by Pope.

Fenton also published *Oxford and Cambridge Miscellany Poems* (1707); *Miscellaneous Poems* (1717); *Mariamne*, a tragedy (1723); an edition (1725) of Milton's poems, and one of Waller (1729) with elaborate notes. See W. W. Lloyd, *Elijah Fenton, his Poetry and Friends* (1894).

FENTON, SIR GEOFFREY (c. 1539–1608), English writer and politician, was the son of Henry Fenton, of Nottinghamshire. He was brother of Edward Fenton the navigator. He is said to have visited Spain and Italy in his youth; possibly he went to Paris in Sir Thomas Hoby's train in 1566, for he was living there in 1567, when he wrote *Certaine tragicall discourses written oute of Frenche and Latin*. This book is a free translation of François de Belleforest's French rendering of Matteo Bandello's *Novelle*. Till 1579 Fenton continued his literary labours, publishing *Monophylo* in 1572, *Golden epistles gathered out of Guevarae's workes as other auhors* . . . 1575, and various religious tracts of strong protestant tendencies. In 1579 appeared the *Historie of Guicciardini, translated out of French by G. F.* and dedicated to Elizabeth. Through Lord Burghley he obtained, in 1580, the post of secretary to the new lord deputy of Ireland, Lord Grey de Wilton, and thus became a fellow worker with the poet, Edmund Spenser. From this time Fenton abandoned literature and became a faithful if somewhat unscrupulous servant of the crown. He was a bigoted protestant, longing to use the rack against "the diabolicall secte of Rome," and even advocating the assassination of the queen's most dangerous subjects. He won Elizabeth's confidence, and the hatred of all his fellow-workers, by keeping her informed of every one's doings in Ireland. In 1587 Sir John Perrot arrested Fenton, but the queen instantly ordered his release. Fenton was knighted in 1589, and in 1590–1591 he was in London as commissioner on the impeachment of Perrot. Full of dislike of the Scots and of James VI. (which he did not scruple to utter), on the latter's accession Fenton's post of secretary was in danger, but Burghley exerted himself in his favour, and in 1604 it was confirmed to him for life, though he had to share it with Sir Richard Coke. Fenton died in Dublin on the 19th of October 1608, and was buried in St Patrick's cathedral. He married in June 1585, Alice, daughter of Dr Robert Weston, formerly lord chancellor of Ireland, and widow of Dr Hugh Brady, bishop of Meath, by whom he had two children, a son, Sir William Fenton, and a daughter, Catherine, who in 1603 married Richard Boyle, 1st earl of Cork.

BIBLIOGRAPHY.—Harl. Soc. publications, vol. iv., Visitation of Nottinghamshire, 1871; Roy. Hist. MSS. Comm. (particularly Hatfield collection); Calendar of State papers, Ireland (very full), domestic, Carew papers; Lismore papers, ed. A. B. Grosart (1886–1888); *Certaine tragicall Discourses*, ed. R. L. Douglas (2 vols., 1898), Tudor Translation series, vols. xix., xx. (introd.).

FENTON, LAVINIA (1708–1760), English actress, was probably the daughter of a naval lieutenant named Beswick, but she bore the name of her mother's husband. Her first appearance was as Monimia in Otway's *Orphans*, in 1726 at the Haymarket. She then joined the company of players at the theatre in Lincoln's Inn Fields, where her success and beauty made her the toast of the beaux. It was in Gay's *Beggar's Opera*, as Polly Peachum, that Miss Fenton made her greatest success. Her pictures were in great demand, verses were written to her and books published about her, and she was the most talked-of person in London. Hogarth's picture shows her in one of the scenes, with the duke of Bolton in a box. After appearing in several comedies, and then in numerous repetitions of the *Beggar's Opera*, she ran away with her lover Charles Paulet, 3rd duke of Bolton, a man much older than herself, who, after the death of his wife in 1751, married her. Their three children all died young. The duchess survived her husband and died on the 24th of January 1760.

FENTON, a town of Staffordshire, England, on the North Staffordshire railway, adjoining the east side of Stoke-on-Trent, in which parliamentary and municipal borough it is included. Pop. (1891) 16,998; (1901) 22,742. The manufacture of earthenware common to the district (the Potteries) employs the bulk of the large industrial population.

FENUGREEK, in botany, *Trigonella Foenum-graecum* (so called from the name given to it by the ancients, who used it as fodder for cattle), a member of a genus of leguminous herbs very similar in habit and in most of their characters to the species of the genus *Medicago*. The leaves are formed of three obovate

leaflets, the middle one of which is stalked; the flowers are solitary, or in clusters of two or three, and have a campanulate, 5-cleft calyx; and the pods are many-seeded, cylindrical or flattened, and straight or only slightly curved. The genus is widely diffused over the south of Europe, West and Central Asia, and the north of Africa, and is represented by several species in Australia. Fenugreek is indigenous to south-eastern Europe and western Asia, and is cultivated in the Mediterranean region, parts of central Europe, and in Morocco, and largely in Egypt and in India. It bears a sickle-shaped pod, containing from 10 to 20 seeds, from which 6% of a fetid, fatty and bitter oil can be extracted by ether. In India the fresh plant is employed as an esculent. The seed is an ingredient in curry powders, and is used for flavouring cattle foods. It was formerly much esteemed as a medicine, and is still in repute in veterinary practice.

FENWICK, SIR JOHN (c. 1645–1697), English conspirator, was the eldest son of Sir William Fenwick, or Fenwicke, a member of an old Northumberland family. He entered the army, becoming major-general in 1688, but before this date he had been returned in succession to his father as one of the members of parliament for Northumberland, which county he represented from 1677 to 1687. He was a strong partisan of King James II., and in 1685 was one of the principal supporters of the act of attainder against the duke of Monmouth; but he remained in England when William III. ascended the throne three years later. He began at once to plot against the new king, for which he underwent a short imprisonment in 1689. Renewing his plots on his release, he publicly insulted Queen Mary in 1691, and it is practically certain that he was implicated in the schemes for assassinating William which came to light in 1695 and 1696. After the seizure of his fellow-conspirators, Robert Charnock and others, he remained in hiding until the imprudent conduct of his friends in attempting to induce one of the witnesses against him to leave the country led to his arrest in June in 1696. To save himself he offered to reveal all he knew about the Jacobite conspiracies; but his confession was a farce, being confined to charges against some of the leading Whig noblemen, which were damaging, but not conclusive. By this time his friends had succeeded in removing one of the two witnesses, and in these circumstances it was thought that the charge of treason must fail. The government, however, overcame this difficulty by introducing a bill of attainder, which after a long and acrimonious discussion passed through both Houses of Parliament. His wife persevered in her attempts to save his life, but her efforts were fruitless, and Fenwick was beheaded in London on the 28th of January 1697, with the same formalities as were usually observed at the execution of a peer. By his wife, Mary (d. 1708), daughter of Charles Howard, 1st earl of Carlisle, he had three sons and one daughter. Macaulay says that "of all the Jacobites, the most desperate characters not excepted, he (Fenwick) was the only one for whom William felt an intense personal aversion"; and it is interesting to note that Fenwick's hatred of the king is said to date from the time when he was serving in Holland, and was reprimanded by William, then prince of Orange.

FEOFFMENT, in English law, during the feudal period, the usual method of granting or conveying a freehold or fee. For the derivation of the word see FIFE and FEE. The essential elements were *livery of seisin* (delivery of possession), which consisted in formally giving to the feoffee on the land a clod or turf, or a growing twig, as a symbol of the transfer of the land, and words by the feoffor declaratory of his intent to deliver possession to the feoffee with a "limitation" of the estate intended to be transferred. This was called *livery in deed*. *Livery in law* was made not on but in sight of this land, the feoffor saying to the feoffee, "I give you that land; enter and take possession." *Livery in law*, in order to pass the estate, had to be perfected by entry by the feoffee during the joint lives of himself and the feoffor. It was usual to evidence the feoffment by writing in a charter or deed of feoffment; but writing was not essential until the Statute of Frauds; now, by the Real Property Act 1845, a conveyance of real property is void unless evidenced by deed, and

thus feoffments have been rendered unnecessary and superfluous. All corporeal hereditaments were by that act declared to be *in grant* as well as *livery*, *i.e.* they could be granted by deed without livery. A feoffment might be a tortious conveyance, *i.e.* if a person attempted to give to the feoffee a greater estate than he himself had in the land, he forfeited the estate of which he was seised. (See CONVEYANCING; REAL PROPERTY.)

FERDINAND (Span. *Fernando* or *Hernando*; Ital. *Ferdinando* or *Ferrante*; in O. H. Ger. *Herinand*, *i.e.* "brave in the host," from O. H. G. *Heri*, "army," A.S. *here*, Mod. Ger. *Heer*, and the Goth. *nanþjan*, "to dare"), a name borne at various times by many European sovereigns and princes, the more important of whom are noticed below in the following order: emperors, kings of Naples, Portugal, Spain (Castile, Leon and Aragon) and the two Sicilies; then the grand duke of Tuscany, the prince of Bulgaria, the duke of Brunswick and the elector of Cologne.

FERDINAND I. (1503-1564), Roman emperor, was born at Alcalá de Henares on the 10th of March 1503, his father being Philip the Handsome, son of the emperor Maximilian I., and his mother Joanna, daughter of Ferdinand and Isabella, king and queen of Castile and Aragon. Philip died in 1506 and Ferdinand, educated in Spain, was regarded with especial favour by his maternal grandfather who wished to form a Spanish-Italian kingdom for his namesake. This plan came to nothing, and the same fate attended a suggestion made after the death of Maximilian in 1519 that Ferdinand, and not his elder brother Charles, afterwards the emperor Charles V., should succeed to the imperial throne. Charles, however, secured the Empire and the whole of the lands of Maximilian and Ferdinand, while the younger brother was perforce content with a subordinate position. Yet some provision must be made for Ferdinand. In April 1521 the emperor granted to him the archduchies and duchies of upper and lower Austria, Carinthia, Styria and Carniola, adding soon afterwards the county of Tirol and the hereditary possessions of the Habsburgs in south-western Germany. About the same time the archduke was appointed to govern the duchy of Württemberg, which had come into the possession of Charles V.; and in May 1521 he was married at Linz to Anna (d. 1547), a daughter of Ladislaus, king of Hungary and Bohemia, a union which had been arranged some years before by the emperor Maximilian. In 1521 also he was made president of the council of regency (*Reichsregiment*), appointed to govern Germany during the emperor's absence, and the next five years were occupied with imperial business, in which he acted as his brother's representative, and in the government of the Austrian lands.

In Austria and the neighbouring duchies Ferdinand sought at first to suppress the reformers and their teaching, and this was possibly one reason why he had some difficulty in quelling risings in the districts under his rule after the Peasants' War broke out in 1524. But a new field was soon opened for his ambition. In August 1526 his childless brother-in-law, Louis II., king of Hungary and Bohemia, was killed at the battle of Mohacs, and the archduke at once claimed both kingdoms, both by treaty and by right of his wife. Taking advantage of the divisions among his opponents, he was chosen king of Bohemia in October 1526, and crowned at Prague in the following February, but in Hungary he was less successful. John Zapolya, supported by the national party and soon afterwards by the Turks, offered a sturdy resistance, and although Ferdinand was chosen king at Pressburg in December 1526, and after defeating Zapolya at Tokay was crowned at Stuhlweissenburg in November 1527, he was unable to take possession of the kingdom. The Bavarian Wittelsbachs, incensed at not securing the Bohemian throne, were secretly intriguing with his foes; the French, after assisting spasmodically, made a formal alliance with Turkey in 1535; and Zapolya was a very useful centre round which the enemies of the Habsburgs were not slow to gather. A truce made in 1533 was soon broken, and the war dragged on until 1538, when by the treaty of Grosswardein, Hungary was divided between the claimants. The kingly title was given to Zapolya, but Ferdinand was to follow him on the throne. Before this, in January 1531, he had been chosen king of the Romans, or German king, at Cologne,

and his coronation took place a few days later at Aix-la-Chapelle. He had thoroughly earned this honour by his loyalty to his brother, whom he had represented at several diets. In religious matters the king was now inclined, probably owing to the Turkish danger, to steer a middle course between the contending parties, and in 1532 he agreed to the religious peace of Nuremberg, receiving in return from the Protestants some assistance for the war against the Turks. In 1534, however, his prestige suffered a severe rebuff. Philip, landgrave of Hesse, and his associates had succeeded in conquering Württemberg on behalf of its exiled duke, Ulrich (*q.v.*), and, otherwise engaged, neither Charles nor Ferdinand could send much help to their lieutenants. They were consequently obliged to consent to the treaty of Cadan, made in June 1534, by which the German king recognized Ulrich as duke of Württemberg, on condition that he held his duchy under Austrian suzerainty.

In Hungary the peace of 1538 was not permanent. When Zapolya died in July 1540 a powerful faction refused to admit the right of Ferdinand to succeed him, and put forward his young son John Sigismund as a candidate for the throne. The cause of John Sigismund was espoused by the Turks and by Ferdinand's other enemies, and, unable to get any serious assistance from the imperial diet, the king repeatedly sought to make peace with the sultan, but his envoys were haughtily repulsed. In 1544, however, a short truce was made. This was followed by others, and in 1547 one was concluded for five years, but only on condition that Ferdinand paid tribute for the small part of Hungary which remained in his hands. The struggle was renewed in 1551 and was continued in the same desultory fashion until 1562, when a truce was made which lasted during the remainder of Ferdinand's lifetime. During the war of the league of Schmalkalden in 1546 and 1547 the king had taken the field primarily to protect Bohemia, and after the conclusion of the war he put down a rising in this country with some rigour. He appears during these years to have governed his lands with vigour and success, but in imperial politics he was merely the representative and spokesman of the emperor. About 1546, however, he began to take up a more independent position. Although Charles had crushed the league of Schmalkalden he had refused to restore Württemberg to Ferdinand; and he gave further offence by seeking to secure the succession of his son Philip, afterwards king of Spain, to the imperial throne. Ferdinand naturally objected, but in 1551 his reluctant consent was obtained to the plan that, on the proposed abdication of Charles, Philip should be chosen king of the Romans, and should succeed Ferdinand himself as emperor. Subsequent events caused the scheme to be dropped, but it had a somewhat unfortunate sequel for Charles, as during the short war between the emperor and Maurice, elector of Saxony, in 1552 Ferdinand's attitude was rather that of a spectator and mediator than of a partisan. There seems, however, to be no truth in the suggestion that he acted treacherously towards his brother, and was in alliance with his foes. On behalf of Charles he negotiated the treaty of Passau with Maurice in 1552, and in 1555 after the conduct of imperial business had virtually been made over to him, and harmony had been restored between the brothers, he was responsible for the religious peace of Augsburg. Early in 1558 Charles carried out his intention to abdicate the imperial throne, and on the 24th of March Ferdinand was crowned as his successor at Frankfort. Pope Paul IV. would not recognize the new emperor, but his successor Pius IV. did so in 1559 through the mediation of Philip of Spain. The emperor's short reign was mainly spent in seeking to settle the religious differences of Germany, and in efforts to prosecute the Turkish war more vigorously. His hopes at one time centred round the council of Trent which resumed its sittings in 1562, but he was unable to induce the Protestants to be represented. Although he held firmly to the Roman Catholic Church he sought to obtain tangible concessions to her opponents; but he refused to conciliate the Protestants by abrogating the clause concerning ecclesiastical reservation in the peace of Augsburg, and all his efforts to bring about reunion were futile. He did indeed secure the privilege of communion in both kinds from Pius IV. for the

laity in Bohemia and in various parts of Germany, but the hearty support which he gave the Jesuits shows that he had no sympathy with Protestantism, and was only anxious to restore union in the Church. In November 1562 he obtained the election of his son Maximilian as king of the Romans, and having arranged a partition of his lands among his three surviving sons, died in Vienna on the 25th of July 1564. His family had consisted of six sons and nine daughters.

In spite of constant and harassing engagements Ferdinand was fairly successful both as king and emperor. He sought to consolidate his Austrian lands, reformed the monetary system in Germany, and reorganized the Aulic council (*Reichshofrat*). Less masterful but more popular than his brother, whose character overshadows his own, he was just and tolerant, a good Catholic and a conscientious ruler.

See the article on CHARLES V. and the bibliography appended thereto. Also, A. Ulloa, *Vita del potentissimo e christianissimo imperatore Ferdinando primo* (Venice, 1565); S. Schard, *Epitome rerum in variis orbis partibus a confirmatione Ferdinandi I.* (Basel, 1574); F. B. von Bucholtz, *Geschichte der Regierung Ferdinands des Ersten* (Vienna, 1831-1838); K. Oberleitner, *Österreichs Finanzen und Kriegswesen unter Ferdinand I.* (Vienna, 1859); A. Rezek, *Geschichte der Regierung Ferdinands I. in Böhmen* (Prague, 1878); E. Rosenthal, *Die Behördenorganisation Kaiser Ferdinands I.* (Vienna, 1887); and W. Bauer, *Die Anfänge Ferdinands I.* (Vienna, 1907).

FERDINAND II. (1578-1637), Roman emperor, was the eldest son of Charles, archduke of Styria (d. 1590), and his wife Maria, daughter of Albert IV., duke of Bavaria and a grandson of the emperor Ferdinand I. Born at Gratz on the 9th of July 1578, he was trained by the Jesuits, finishing his education at the university of Ingolstadt, and became the pattern prince of the counter-reformation. In 1596 he undertook the government of Styria, Carinthia and Carniola, and after a visit to Italy began an organized attack on Protestantism which under his father's rule had made great progress in these archduchies; and although hampered by the inroads of the Turks, he showed his indifference to the material welfare of his dominions by compelling many of his Protestant subjects to choose between exile and conversion, and by entirely suppressing Protestant worship. He was not, however, unmindful of the larger interest of his family, or of the Empire which the Habsburgs regarded as belonging to them by hereditary right. In 1606 he joined his kinsmen in recognizing his cousin Matthias as the head of the family in place of the lethargic Rudolph II.; but he shrank from any proceedings which might lead to the deposition of the emperor, whom he represented at the diet of Regensburg in 1608; and his conduct was somewhat ambiguous during the subsequent quarrel between Rudolph and Matthias.

In the first decade of the 17th century the house of Habsburg seemed overtaken by senile decay, and the great inheritance of Charles V. and Ferdinand I. to be threatened with disintegration and collapse. The reigning emperor, Rudolph II., was inert and childless; his surviving brothers, the archduke Matthias (afterwards emperor), Maximilian (1558-1618) and Albert (1559-1621), all men of mature age, were also without direct heirs; the racial differences among its subjects were increased by their religious animosities; and it appeared probable that the numerous enemies of the Habsburgs had only to wait a few years and then to divide the spoil. In spite of the recent murder of Henry IV. of France, this issue seemed still more likely when Matthias succeeded Rudolph as emperor in 1612. The Habsburgs, however, were not indifferent to the danger, and about 1615 it was agreed that Ferdinand, who already had two sons by his marriage with his cousin Maria Anna (d. 1616), daughter of William V., duke of Bavaria, should be the next emperor, and should succeed Matthias in the elective kingdoms of Hungary and Bohemia. The obstacles which impeded the progress of the scheme were gradually overcome by the energy of the archduke Maximilian. The elder archdukes renounced their rights in the succession; the claims of Philip III. and the Spanish Habsburgs were bought off by a promise of Alsace; and the emperor consented to his supercession in Hungary and Bohemia. In 1617 Ferdinand, who was just concluding a war with Venice, was chosen king of Bohemia,

and in 1618 king of Hungary; but his election as German king, or king of the Romans, delayed owing to the anxiety of Melchior Klesl (*q.v.*) to conciliate the protestant princes, had not been accomplished when Matthias died in March 1619. Before this event, however, an important movement had begun in Bohemia. Having been surprised into choosing a devoted Roman Catholic as their king, the Bohemian Protestants suddenly realized that their religious, and possibly their civil liberties, were seriously menaced, and deeds of aggression on the part of Ferdinand's representatives showed that this was no idle fear. Gaining the upper hand they declared Ferdinand deposed, and elected the elector palatine of the Rhine, Frederick V., in his stead; and the struggle between the rivals was the beginning of the Thirty Years' War. At the same time other difficulties confronted Ferdinand, who had not yet secured the imperial throne. Bethlen Gabor, prince of Transylvania, invaded Hungary, while the Austrians rose and joined the Bohemians; but having seen his foes retreat from Vienna, Ferdinand hurried to Frankfort, where he was chosen emperor on the 28th of August 1619.

To deal with the elector palatine and his allies the new emperor allied himself with Maximilian I., duke of Bavaria, and the Catholic League, who drove Frederick from Bohemia in 1620, while Ferdinand's Spanish allies devastated the Palatinate. Peace having been made with Bethlen Gabor in December 1621, the first period of the war ended in a satisfactory fashion for the emperor, and he could turn his attention to completing the work of crushing the Protestants, which had already begun in his archduchies and in Bohemia. In 1623 the Protestant clergy were expelled from Bohemia; in 1624 all worship save that of the Roman Catholic church was forbidden; and in 1627 an order of banishment against all Protestants was issued. A new constitution made the kingdom hereditary in the house of Habsburg, gave larger powers to the sovereign, and aimed at destroying the nationality of the Bohemians. Similar measures in Austria led to a fresh rising which was put down by the aid of the Bavarians in 1627, and Ferdinand could fairly claim that in his hereditary lands at least he had rendered Protestantism innocuous.

The renewal of the Thirty Years' War in 1625 was caused mainly by the emperor's vigorous championship of the cause of the counter-reformation in northern and north-eastern Germany. Again the imperial forces were victorious, chiefly owing to the genius of Wallenstein, who raised and led an army in this service, although the great scheme of securing the southern coast of the Baltic for the Habsburgs was foiled partly by the resistance of Stralsund. In March 1629 Ferdinand and his advisers felt themselves strong enough to take the important step towards which their policy in the Empire had been steadily tending. Issuing the famous edict of restitution, the emperor ordered that all lands which had been secularized since 1552, the date of the peace of Passau, should be restored to the church, and prompt measures were taken to enforce this decree. Many and powerful interests were vitally affected by this proceeding, and the result was the outbreak of the third period of the war, which was less favourable to the imperial arms than the preceding ones. This comparative failure was due, in the initial stages of the campaign, to Ferdinand's weakness in assenting in 1630 to the demand of Maximilian of Bavaria that Wallenstein should be deprived of his command, and also to the genius of Gustavus Adolphus; and in its later stages to his insistence on the second removal of Wallenstein, and to his complicity in the assassination of the general. This deed was followed by the peace of Prague, concluded in 1635, primarily with John George I., elector of Saxony, but soon assented to by other princes; and this treaty, which made extensive concessions to the Protestants, marks the definite failure of Ferdinand to crush Protestantism in the Empire, as he had already done in Austria and Bohemia. It is noteworthy, however, that the emperor refused to allow the inhabitants of his hereditary dominions to share in the benefits of the peace. During these years Ferdinand had also been menaced by the secret or open hostility of France. A dispute over the duchies of Mantua and Monferrato was

ended by the treaty of Cherasco in 1631, but the influence of France was employed at the imperial diets and elsewhere in thwarting the plans of Ferdinand and in weakening the power of the Habsburgs. The last important act of the emperor was to secure the election of his son Ferdinand as king of the Romans. An attempt in 1630 to attain this end had failed, but in December 1636 the princes, meeting at Regensburg, bestowed the coveted dignity upon the younger Ferdinand. A few weeks afterwards, on the 15th of February 1637, the emperor died at Vienna, leaving, in addition to the king of the Romans, a son Leopold William (1614-1662), bishop of Passau and Strassburg. Ferdinand's reign was so occupied with the Thirty Years' War and the struggle with the Protestants that he had little time or inclination for other business. It is interesting to note, however, that this orthodox and Catholic emperor was constantly at variance with Pope Urban VIII. The quarrel was due principally, but not entirely, to events in Italy, where the pope sided with France in the dispute over the succession to Mantua and Monferrato. The succession question was settled, but the enmity remained; Urban showing his hostility by preventing the election of the younger Ferdinand as king of the Romans in 1630, and by turning a deaf ear to the emperor's repeated requests for assistance to prosecute the war against the heretics. Ferdinand's character has neither individuality nor interest, but he ruled the Empire during a critical and important period. Kind and generous to his dependents, his private life was simple and blameless, but he was to a great extent under the influence of his confessors.

BIBLIOGRAPHY.—The chief authorities for Ferdinand's life and reign are F. C. Khevenhiller, *Annales Ferdinandeæ* (Regensburg, 1640-1646); F. van Hurter, *Geschichte Kaiser Ferdinands II.* (Schaffhausen, 1850-1855); *Korrespondenz Kaiser Ferdinands II. mit P. Becanus und P. W. Lamormaini*, edited by B. Dudik (Vienna, 1848 fol.); and F. Stieve, in the *Allgemeine deutsche Biographie*, Band vi. (Leipzig, 1877). See also the elaborate bibliography in the *Cambridge Modern History*, vol. iv. (Cambridge, 1906).

FERDINAND III. (1608-1657), Roman emperor, was the elder son of the emperor Ferdinand II., and was born at Gratz on the 13th of July 1608. Educated by the Jesuits, he was crowned king of Hungary in December 1625, and king of Bohemia two years later, and soon began to take part in imperial business. Wallenstein, however, refused to allow him to hold a command in the imperial army; and henceforward reckoned among his enemies, the young king was appointed the successor of the famous general when he was deposed in 1634; and as commander-in-chief of the imperial troops he was nominally responsible for the capture of Regensburg and Donauwörth, and the defeat of the Swedes at Nördlingen. Having been elected king of the Romans, or German king, at Regensburg in December 1636, Ferdinand became emperor on his father's death in the following February, and showed himself anxious to put an end to the Thirty Years' War. He persuaded one or two princes to assent to the terms of the treaty of Prague; but a general peace was delayed by his reluctance to grant religious liberty to the Protestants, and by his anxiety to act in unison with Spain. In 1640 he had refused to entertain the idea of a general amnesty suggested by the diet at Regensburg; but negotiations for peace were soon begun, and in 1648 the emperor assented to the treaty of Westphalia. This event belongs rather to the general history of Europe, but it is interesting to note that owing to Ferdinand's insistence the Protestants in his hereditary dominions did not obtain religious liberty at this settlement. After 1648 the emperor was engaged in carrying out the terms of the treaty and ridding Germany of the foreign soldiery. In 1656 he sent an army into Italy to assist Spain in her struggle with France, and he had just concluded an alliance with Poland to check the aggressions of Charles X. of Sweden when he died on the 2nd of April 1657. Ferdinand was a scholarly and cultured man, an excellent linguist and a composer of music. Industrious and popular in public life, his private life was blameless; and although a strong Roman Catholic he was less fanatical than his father. His first wife was Maria Anna (d. 1646), daughter of Philip III. of Spain, by whom he had three

sons: Ferdinand, who was chosen king of the Romans in 1653, and who died in the following year; Leopold, who succeeded his father on the imperial throne; and Charles Joseph (d. 1664), bishop of Passau and Breslau, and grand-master of the Teutonic order. The emperor's second wife was his cousin Maria (d. 1649), daughter of the archduke Leopold; and his third wife was Eleanora of Mantua (d. 1686). His musical works, together with those of the emperors Leopold I. and Joseph I., have been published by G. Adler (Vienna, 1892-1893).

See M. Koch, *Geschichte des deutschen Reiches unter der Regierung Ferdinands III.* (Vienna, 1865-1866).

FERDINAND I. (1793-1875), emperor of Austria, eldest son of Francis I. and of Maria Theresa of Naples, was born at Vienna on the 19th of April 1793. In his boyhood he suffered from epileptic fits, and could therefore not receive a regular education. As his health improved with his growth and with travel, he was not set aside from the succession. In 1830 his father caused him to be crowned king of Hungary, a pure formality, which gave him no power, and was designed to avoid possible trouble in the future. In 1831 he was married to Anna, daughter of Victor Emmanuel I. of Sardinia. The marriage was barren. When Francis I. died on the 2nd of March 1835, Ferdinand was recognized as his successor. But his incapacity was so notorious that the conduct of affairs was entrusted to a council of state, consisting of Prince Metternich (*q.v.*) with other ministers, and two archdukes, Louis and Francis Charles. They composed the *Staatsconferenz*, the ill-constructed and informal regency which led the Austrian dominions to the revolutionary outbreaks of 1846-1849. (See AUSTRIA-HUNGARY.) The emperor, who was subject to fits of actual insanity, and in his lucid intervals was weak and confused in mind, was a political nullity. His personal amiability earned him the affectionate pity of his subjects, and he became the hero of popular stories which did not tend to maintain the dignity of the crown. It was commonly said that 'having taken refuge on a rainy day in a farmhouse he was so tempted by the smell of the dumplings which the farmer and his family were eating for dinner, that he insisted on having one. His doctor, who knew them to be indigestible, objected, and thereupon Ferdinand, in an imperial rage, made the answer:—"Kaiser bin i', und Knüdel müss i' haben" (I am emperor, and will have the dumpling)—which has become a Viennese proverb. His popular name of *Der Gütige* (the good sort of man) expressed as much derision as affection. Ferdinand had good taste for art and music. Some modification of the tight-handed rule of his father was made by the *Staatsconferenz* during his reign. In the presence of the revolutionary troubles, which began with agrarian riots in Galicia in 1846, and then spread over the whole empire, he was personally helpless. He was compelled to escape from the disorders of Vienna to Innsbruck on the 17th of May 1848. He came back on the invitation of the diet on the 12th of August, but soon had to escape once more from the mob of students and workmen who were in possession of the city. On the 2nd of December he abdicated at Olmütz in favour of his nephew, Francis Joseph. He lived under supervision by doctors and guardians at Prague till his death on the 29th of June 1875.

See Krones von Marchland, *Grundriss der österreichischen Geschichte* (Vienna, 1882), which gives an ample bibliography; Count F. Hartig, *Genesis der Revolution in Oesterreich* (Leipzig, 1850),—an enlarged English translation will be found in the 4th volume of W. Cox's *House of Austria* (London, 1862).

FERDINAND I. (1423-1494), also called Don Ferrante, king of Naples, the natural son of Alphonso V. of Aragon and I. of Sicily and Naples, was born in 1423. In accordance with his father's will, he succeeded him on the throne of Naples in 1458, but Pope Calixtus III. declared the line of Aragon extinct and the kingdom a fief of the church. But although he died before he could make good his claim (August 1458), and the new Pope Pius II. recognized Ferdinand, John of Anjou, profiting by the discontent of the Neapolitan barons, decided to try to regain the throne conquered by his ancestors, and invaded Naples. Ferdinand was severely defeated by the Angevins and the rebels at Sarno in July 1460, but with the help of Alessandro Sforza

and of the Albanian chief, Skanderbeg, who chivalrously came to the aid of the prince whose father had aided him, he triumphed over his enemies, and by 1464 had re-established his authority in the kingdom. In 1478 he allied himself with Pope Sixtus IV. against Lorenzo de' Medici, but the latter journeyed alone to Naples when he succeeded in negotiating an honourable peace with Ferdinand. In 1480 the Turks captured Otranto, and massacred the majority of the inhabitants, but in the following year it was retaken by his son Alphonso, duke of Calabria. His oppressive government led in 1485 to an attempt at revolt on the part of the nobles, led by Francesca Coppola and Antonello Sanseverino and supported by Pope Innocent VIII.; the rising having been crushed, many of the nobles, notwithstanding Ferdinand's promise of a general amnesty, were afterwards treacherously murdered at his express command. In 1493 Charles VIII. of France was preparing to invade Italy for the conquest of Naples, and Ferdinand realized that this was a greater danger than any he had yet faced. With almost prophetic instinct he warned the Italian princes of the calamities in store for them, but his negotiations with Pope Alexander VI. and Ludovico il Moro, lord of Milan, having failed, he died in January 1494, worn out with anxiety. Ferdinand was gifted with great courage and real political ability, but his method of government was vicious and disastrous. His financial administration was based on oppressive and dishonest monopolies, and he was mercilessly severe and utterly treacherous towards his enemies.

AUTHORITIES.—*Codice Aragonese*, edited by F. Trinchera (Naples, 1866-1874); P. Giannone, *Istoria Civile del Regno di Napoli*; J. Alvini, *De gestis regum Neapol. ab Aragonia* (Naples, 1588); S. de Sismondi, *Histoire des républiques italiennes*, vols. v. and vi. (Brussels, 1838); P. Villari, *Machiavelli*, pp. 60-64 (Engl. transl. London, 1892); for the revolt of the nobles in 1485 see Camillo Porzio, *La Congiura dei Baroni* (first published Rome, 1565; many subsequent editions), written in the Royalist interest. (L. V.*)

FERDINAND II. (1469-1496), king of Naples, was the grandson of the preceding, and son of Alphonso II. Alphonso finding his tenure of the throne uncertain on account of the approaching invasion of Charles VIII. of France and the general dissatisfaction of his subjects, abdicated in his son's favour in 1495, but notwithstanding this the treason of a party in Naples rendered it impossible to defend the city against the approach of Charles VIII. Ferdinand fled to Ischia; but when the French king left Naples with most of his army, in consequence of the formation of an Italian league against him, he returned, defeated the French garrisons, and the Neapolitans, irritated by the conduct of their conquerors during the occupation of the city, received him back with enthusiasm; with the aid of the great Spanish general Gonzalo de Cordova he was able completely to rid his state of its invaders shortly before his death, which occurred on the 7th of September 1496.

For authorities see under FERDINAND I. of Naples; for the exploits of Gonzalo de Cordova see H. P. del Pulgar, *Crónica del gran capitano don Gonzalo de Cordoba* (new ed., Madrid, 1834).

FERDINAND IV. (1751-1825), king of Naples (III. of Sicily, and I. of the Two Sicilies), third son of Don Carlos of Bourbon, king of Naples and Sicily (afterwards Charles III. of Spain), was born in Naples on the 12th of January 1751. When his father ascended the Spanish throne in 1759 Ferdinand, in accordance with the treaties forbidding the union of the two crowns, succeeded him as king of Naples, under a regency presided over by the Tuscan Bernardo Tanucci. The latter, an able, ambitious man, wishing to keep the government as much as possible in his own hands, purposely neglected the young king's education, and encouraged him in his love of pleasure, his idleness and his excessive devotion to outdoor sports. Ferdinand grew up athletic, but ignorant, ill-bred, addicted to the lowest amusements; he delighted in the company of the *lazzaroni* (the most degraded class of the Neapolitan people), whose dialect and habits he affected, and he even sold fish in the market, haggling over the price.

His minority ended in 1767, and his first act was the expulsion of the Jesuits. The following year he married Maria Carolina, daughter of the empress Maria Theresa. By the marriage con-

tract the queen was to have a voice in the council of state after the birth of her first son, and she was not slow to avail herself of this means of political influence. Beautiful, clever and proud, like her mother, but cruel and treacherous, her ambition was to raise the kingdom of Naples to the position of a great power; she soon came to exercise complete sway over her stupid and idle husband, and was the real ruler of the kingdom. Tanucci, who attempted to thwart her, was dismissed in 1777, and the Englishman Sir John Acton (1736), who in 1779 was appointed director of marine, succeeded in so completely winning the favour of Maria Carolina, by supporting her in her scheme to free Naples from Spanish influence and securing a *rapprochement* with Austria and England, that he became practically and afterwards' actually prime minister. Although not a mere grasping adventurer, he was largely responsible for reducing the internal administration of the country to an abominable system of espionage, corruption and cruelty. On the outbreak of the French Revolution the Neapolitan court was not hostile to the movement, and the queen even sympathized with the revolutionary ideas of the day. But when the French monarchy was abolished and the royal pair beheaded, Ferdinand and Carolina were seized with a feeling of fear and horror and joined the first coalition against France in 1793. Although peace was made with France in 1796, the demands of the French Directory, whose troops occupied Rome, alarmed the king once more, and at his wife's instigation he took advantage of Napoleon's absence in Egypt and of Nelson's victories to go to war. He marched with his army against the French and entered Rome (29th of November), but on the defeat of some of his columns he hurried back to Naples, and on the approach of the French, fled on board Nelson's ship the "Vanguard" to Sicily, leaving his capital in a state of anarchy. The French entered the city in spite of the fierce resistance of the *lazzaroni*, who were devoted to the king, and with the aid of the nobles and bourgeois established the Parthenopæan Republic (January 1799). When a few weeks later the French troops were recalled to the north of Italy, Ferdinand sent an expedition composed of Calabrians, brigands and gaol-birds, under Cardinal Ruffo, a man of real ability, great devotion to the king, and by no means so bad as he has been painted, to reconquer the mainland kingdom. Ruffo was completely successful, and reached Naples in May. His army and the *lazzaroni* committed nameless atrocities, which he honestly tried to prevent, and the Parthenopæan Republic collapsed.

The savage punishment of the Neapolitan Republicans is dealt with in more detail under NAPLES, NELSON and CARACCILO, but it is necessary to say here that the king, and above all the queen, were particularly anxious that no mercy should be shown to the rebels, and Maria Carolina made use of Lady Hamilton, Nelson's mistress, to induce him to execute her own spiteful vengeance. Her only excuse is that as a sister of Marie Antoinette the very name of Republican or Jacobin filled her with loathing. The king returned to Naples soon afterwards, and ordered wholesale arrests and executions of supposed Liberals, which continued until the French successes forced him to agree to a treaty in which amnesty for members of the French party was included. When war broke out between France and Austria in 1805, Ferdinand signed a treaty of neutrality with the former, but a few days later he allied himself with Austria and allowed an Anglo-Russian force to land at Naples. The French victory at Austerlitz enabled Napoleon to despatch an army to southern Italy. Ferdinand with his usual precipitation fled to Palermo (23rd of January 1806), followed soon after by his wife and son, and on the 14th of February the French again entered Naples. Napoleon declared that the Bourbon dynasty had forfeited the crown, and proclaimed his brother Joseph king of Naples and Sicily. But Ferdinand continued to reign over the latter kingdom under British protection. Parliamentary institutions of a feudal type had long existed in the island, and Lord William Bentinck (*q.v.*), the British minister, insisted on a reform of the constitution on English and French lines. The king indeed practically abdicated his power, appointing his son Francis

regent, and the queen, at Bentinck's instance, was exiled to Austria, where she died in 1814.

After the fall of Napoleon, Joachim Murat, who had succeeded Joseph Bonaparte as king of Naples in 1808, was dethroned, and Ferdinand returned to Naples. By a secret treaty he had bound himself not to advance further in a constitutional direction than Austria should at any time approve; but, though on the whole he acted in accordance with Metternich's policy of preserving the *status quo*, and maintained with but slight change Murat's laws and administrative system, he took advantage of the situation to abolish the Sicilian constitution, in violation of his oath, and to proclaim the union of the two states into the kingdom of the Two Sicilies (December 12th, 1816). He was now completely subservient to Austria, an Austrian, Count Nugent, being even made commander-in-chief of the army; and for four years he reigned as a despot, every tentative effort at the expression of liberal opinion being ruthlessly suppressed. The result was an alarming spread of the influence and activity of the secret society of the Carbonari (*q.v.*), which in time affected a large part of the army. In July 1820 a military revolt broke out under General Pepe, and Ferdinand was terrorized into subscribing a constitution on the model of the impracticable Spanish constitution of 1812. On the other hand, a revolt in Sicily, in favour of the recovery of its independence, was suppressed by Neapolitan troops.

The success of the military revolution at Naples seriously alarmed the powers of the Holy Alliance, who feared that it might spread to other Italian states and so lead to that general European conflagration which it was their main preoccupation to avoid (see EUROPE: *History*). After long diplomatic negotiations, it was decided to hold a congress *ad hoc* at Troppau (October 1820). The main results of this congress were the issue of the famous Troppau Protocol, signed by Austria, Prussia and Russia only, and an invitation to King Ferdinand to attend the adjourned congress at Laibach (1821), an invitation of which Great Britain approved "as implying negotiation" (see TROPPAU, LAIBACH, *Congresses of*). At Laibach Ferdinand played so sorry a part as to provoke the contempt of those whose policy it was to re-establish him in absolute power. He had twice sworn, with gratuitous solemnity, to maintain the new constitution; but he was hardly out of Naples before he repudiated his oaths and, in letters addressed to all the sovereigns of Europe, declared his acts to have been null and void. An attitude so indecent threatened to defeat the very objects of the reactionary powers, and Gentz congratulated the congress that these sorry protests would be buried in the archives, offering at the same time to write for the king a dignified letter in which he should express his reluctance at having to violate his oaths in the face of irresistible force! But, under these circumstances, Metternich had no difficulty in persuading the king to allow an Austrian army to march into Naples "to restore order."

The campaign that followed did little credit either to the Austrians or the Neapolitans. The latter, commanded by General Pepe (*q.v.*), who made no attempt to defend the difficult defiles of the Abruzzi, were defeated, after a half-hearted struggle at Rieti (March 7th, 1821), and the Austrians entered Naples. The parliament was now dismissed, and Ferdinand inaugurated an era of savage persecution, supported by spies and informers, against the Liberals and Carbonari, the Austrian commandant in vain protesting against the savagery which his presence alone rendered possible.

Ferdinand died on the 4th of January 1825. Few sovereigns have left behind so odious a memory. His whole career is one long record of perjury, vengeance and meanness, unredeemed by a single generous act, and his wife was a worthy helpmeet and actively co-operated in his tyranny.

BIBLIOGRAPHY.—The standard authority on Ferdinand's reign is Pietro Colletta's *Storia del Reame di Napoli* (2nd ed., Florence, 1848), which, although heavily written and not free from party passion, is reliable and accurate; L. Conforti, *Napoli nel 1799* (Naples, 1886); G. Pepe, *Memorie* (Paris, 1847), a most valuable book; C. Auriol, *La France, l'Angleterre, et Naples* (Paris, 1906); for the Sicilian period and the British occupation, G. Bianco, *La Sicilia durante*

l'occupazione Inglese (Palermo, 1902), which contains many new documents of importance; Freiherr A. von Helfert has attempted the impossible task of whitewashing Queen Carolina in his *Königin Karolina von Neapel und Sicilien* (Vienna, 1878), and *Maria Karolina von Oesterreich* (Vienna, 1884); he has also written a useful life of *Fabrizio Ruffo* (Italian edit., Florence, 1885); for the Sicilian revolution of 1820 see G. Bianco's *La Rivoluzione in Sicilia del 1820* (Florence, 1905), and M. Amari's *Caricaggio* (Turin, 1896). (L. V.*)

FERDINAND I., king of Portugal (1345–1383), sometimes referred to as *el Gentil* (the Gentleman), son of Pedro I. of Portugal (who is not to be confounded with his Spanish contemporary Pedro the Cruel), succeeded his father in 1367. On the death of Pedro of Castile in 1369, Ferdinand, as great-grandson of Sancho IV. by the female line, laid claim to the vacant throne, for which the kings of Aragon and Navarre, and afterwards the duke of Lancaster (married in 1370 to Constance, the eldest daughter of Pedro), also became competitors. Meanwhile Henry of Trastamara, the brother (illegitimate) and conqueror of Pedro, had assumed the crown and taken the field. After one or two indecisive campaigns, all parties were ready to accept the mediation of Pope Gregory XI. The conditions of the treaty, ratified in 1371, included a marriage between Ferdinand and Leonora of Castile. But before the union could take place the former had become passionately attached to Leonora Tellez, the wife of one of his own courtiers, and having procured a dissolution of her previous marriage, he lost no time in making her his queen. This strange conduct, although it raised a serious insurrection in Portugal, did not at once result in a war with Henry; but the outward concord was soon disturbed by the intrigues of the duke of Lancaster, who prevailed on Ferdinand to enter into a secret treaty for the expulsion of Henry from his throne. The war which followed was unsuccessful; and peace was again made in 1373. On the death of Henry in 1379, the duke of Lancaster once more put forward his claims, and again found an ally in Portugal; but, according to the Continental annalists, the English proved as offensive to their companions in arms as to their enemies in the field; and Ferdinand made a peace for himself at Badajoz in 1382, it being stipulated that Beatrice, the heiress of Ferdinand, should marry King John of Castile, and thus secure the ultimate union of the crowns. Ferdinand left no male issue when he died on the 22nd of October 1383, and the direct Burgundian line, which had been in possession of the throne since the days of Count Henry (about 1112), became extinct. The stipulations of the treaty of Badajoz were set aside, and John, grand-master of the order of Avis, Ferdinand's illegitimate brother, was proclaimed. This led to a war which lasted for several years.

FERDINAND I., *El Magno* or "the Great," king of Castile (*d.* 1065), son of Sancho of Navarre, was put in possession of Castile in 1028, on the murder of the last count, as the heir of his mother Elvira, daughter of a previous count of Castile. He reigned with the title of king. He married Sancha, sister and heiress of Bermudo, king of Leon. In 1038 Bermudo was killed in battle with Ferdinand at Tamaron, and Ferdinand then took possession of Leon by right of his wife, and was recognized in Spain as emperor. The use of the title was resented by the emperor Henry IV. and by Pope Victor II. in 1055, as implying a claim to the headship of Christendom, and as a usurpation on the Holy Roman Empire. It did not, however, mean more than that Spain was independent of the Empire, and that the sovereign of Leon was the chief of the princes of the peninsula. Although Ferdinand had grown in power by a fratricidal strife with Bermudo of Leon, and though at a later date he defeated and killed his brother Garcia of Navarre, he ranks high among the kings of Spain who have been counted religious. To a large extent he may have owed his reputation to the victories over the Mahomedans, with which he began the period of the great reconquest. But there can be no doubt that Ferdinand was profoundly pious. Towards the close of his reign he sent a special embassy to Seville to bring back the body of Santa Justa. The then king of Seville, Motahid, one of the small princes who had divided the caliphate of Cordova, was himself a sceptic and poisoner, but he stood in wholesome awe of the power of the

Christian king. He favoured the embassy in every way, and when the body of Santa Justa could not be found, helped the envoys who were also aided by a vision seen by one of them in a dream, to discover the body of Saint Isidore, which was reverently carried away to Leon. Ferdinand died on the feast of Saint John the Evangelist, the 24th of June 1065, in Leon, with many manifestations of ardent piety—having laid aside his crown and royal mantle, dressed in the frock of a monk and lying on a bier, covered with ashes, which was placed before the altar of the church of Saint Isidore.

FERDINAND II., king of Leon only (*d.* 1188), was the son of Alphonso VII. and of Berenguela, of the house of the counts of Barcelona. On the division of the kingdoms which had obeyed his father, he received Leon. His reign of thirty years was one of strife marked by no signal success or reverse. He had to contend with his unruly nobles, several of whom he put to death. During the minority of his nephew Alphonso VIII. of Castile he endeavoured to impose himself on the kingdom as regent. On the west he was in more or less constant strife with Portugal, which was in process of becoming an independent kingdom. His relations to the Portuguese house must have suffered by his repudiation of his wife Urraca, daughter of Alphonso I. of Portugal. Though he took the king of Portugal prisoner in 1180, he made no political use of his success. He extended his dominions southward in Estremadura at the expense of the Moors. Ferdinand, who died in 1188, left the reputation of a good knight and hard fighter, but did not display political or organizing faculty.

FERDINAND III., *El Santo* or "the Saint," king of Castile (1199–1252), son of Alphonso IX. of Leon, and of Berengaria, daughter of Alphonso VIII. of Castile, ranks among the greatest of the Spanish kings. The marriage of his parents, who were second cousins, was dissolved as unlawful by the pope, but the legitimacy of the children was recognized. Till 1217 he lived with his father in Leon. In that year the young king of Castile, Henry, was killed by accident. Berengaria sent for her son with such speed that her messenger reached Leon before the news of the death of the king of Castile, and when he came to her she renounced the crown in his favour. Alphonso of Leon considered himself tricked, and the young king had to begin his reign by a war against his father and a faction of the Castilian nobles. His own ability and the remarkable capacity of his mother proved too much for the king of Leon and his Castilian allies. Ferdinand, who showed himself docile to the influence of Berengaria, so long as she lived, married the wife she found for him, Beatrice, daughter of the emperor Philip (of Hohenstaufen), and followed her advice both in prosecuting the war against the Moors and in the steps which she took to secure his peaceful succession to Leon on the death of his father in 1231. After the union of Castile and Leon in that year he began the series of campaigns which ended by reducing the Mahomedan dominions in Spain to Granada. Cordova fell in 1236, and Seville in 1248. The king of Granada did homage to Ferdinand, and undertook to attend the cortes when summoned. The king was a severe persecutor of the Albigenses, and his formal canonization was due as much to his orthodoxy as to his crusading by Pope Clement X. in 1671. He revived the university first founded by his grandfather Alphonso VIII., and placed it at Salamanca. By his second marriage with Joan (*d.* 1279), daughter of Simon, of Dammartin, count of Ponthieu, by right of his wife Marie, Ferdinand was the father of Eleanor, the wife of Edward I. of England.

FERDINAND IV., *El Emplazado* or "the Summoned," king of Castile (*d.* 1312), son of Sancho El Bravo, and his wife Maria de Molina, is a figure of small note in Spanish history. His strange title is given him in the chronicles on the strength of a story that he put two brothers of the name of Carvajal to death tyrannically, and was given a time, a *plazo*, by them in which to answer for his crime in the next world. But the tale is not contemporary, and is an obvious copy of the story told of Jacques de Molay, grand-master of the Temple, and Philippe Le Bel. Ferdinand IV. succeeded to the throne when a boy of

six. His minority was a time of anarchy. He owed his escape from the violence of competitors and nobles, partly to the tact and undaunted bravery of his mother Maria de Molina, and partly to the loyalty of the citizens of Avila, who gave him refuge within their walls. As a king he proved ungrateful to his mother, and weak as a ruler. He died suddenly in his tent at Jaen when preparing for a raid into the Moorish territory of Granada, on the 7th of September 1312.

FERDINAND I., king of Aragon (1373–1416), called "of Antequera," was the son of John I. of Castile by his wife Eleanor, daughter of the third marriage of Peter IV. of Aragon. His surname "of Antequera" was given him because he was besieging that town, then in the hands of the Moors, when he was told that the cortes of Aragon had elected him king in succession to his uncle Martin, the last male of the old line of Wilfred the Hairy. As infante of Castile Ferdinand had played an honourable part. When his brother Henry III. died at Toledo, in 1406, the cortes was sitting, and the nobles offered to make him king in preference to his nephew John. Ferdinand refused to despoil his brother's infant son, and even if he did not act on the moral ground he alleged, his sagacity must have shown him that he would be at the mercy of the men who had chosen him in such circumstances. As co-regent of the kingdom with Catherine, widow of Henry III. and daughter of John of Gaunt by his marriage with Constance, daughter of Peter the Cruel and Maria de Padilla, Ferdinand proved a good ruler. He restrained the follies of his sister-in-law, and kept the realm quiet, by firm government, and by prosecuting the war with the Moors. As king of Aragon his short reign of two years left him little time to make his mark. Having been bred in Castile, where the royal authority was, at least in theory, absolute, he showed himself impatient under the checks imposed on him by the *fueros*, the chartered rights of Aragon and Catalonia. He particularly resented the obstinacy of the Barcelonense, who compelled the members of his household to pay municipal taxes. His most signal act as king was to aid in closing the Great Schism in the Church by agreeing to the deposition of the antipope Benedict XIV., an Aragonese. He died at Ygualada in Catalonia on the 2nd of April 1416.

FERDINAND V. of Castile and Leon, and II. of Aragon (1452–1516), was the son of John I. of Aragon by his second marriage with Joanna Henriquez, of the family of the hereditary grand admirals of Castile, and was born at Sos in Aragon on the 16th of March 1452. Under the name of "the Catholic" and as the husband of Isabella, queen of Castile, he played a great part in Europe. His share in establishing the royal authority in all parts of Spain, in expelling the Moors from Granada, in the conquest of Navarre, in forwarding the voyages of Columbus, and in contending with France for the supremacy in Italy, is dealt with elsewhere (see SPAIN: *History*). In personal character he had none of the attractive qualities of his wife. It may fairly be said of him that he was purely a politician. His marriage in 1469 to his cousin Isabella of Castile was dictated by the desire to unite his own claims to the crown, as the head of the younger branch of the same family, with hers, in case Henry IV. should die childless. When the king died in 1474 he made an ungenerous attempt to procure his own proclamation as king without recognition of the rights of his wife. Isabella asserted her claims firmly, and at all times insisted on a voice in the government of Castile. But though Ferdinand had sought a selfish political advantage at his wife's expense, he was well aware of her ability and high character. Their married life was dignified and harmonious; for Ferdinand had no common vices, and their views in government were identical. The king cared for nothing but dominion and political power. His character explains the most ungracious acts of his life, such as his breach of his promises to Columbus, his distrust of Ximenez and of the Great Captain. He had given wide privileges to Columbus on the supposition that the discoverer would reach powerful kingdoms. When islands inhabited by feeble savages were discovered, Ferdinand appreciated the risk that they might become the seat of a power too strong to be controlled, and took measures to avert the danger. He feared that Ximenez and the

Great Captain would become too independent, and watched them in the interest of the royal authority. Whether he ever boasted, as he is said to have boasted, that he had deceived Louis XII. of France twelve times, is very doubtful; but it is certain that when Ferdinand made a treaty, or came to an understanding with any one, the contract was generally found to contain implied meanings favourable to himself which the other contracting party had not expected. The worst of his character was prominently shown after the death of Isabella in 1504. He endeavoured to lay hands on the regency of Castile in the name of his insane daughter Joanna, and without regard to the claims of her husband Philip of Habsburg. The hostility of the Castilian nobles, by whom he was disliked, baffled him for a time, but on Philip's early death he reasserted his authority. His second marriage with Germaine of Foix in 1505 was apparently contracted in the hope that by securing an heir male he might punish his Habsburg son-in-law. Aragon did not recognize the right of women to reign, and would have been detached together with Catalonia, Valencia and the Italian states if he had had a son. This was the only occasion on which Ferdinand allowed passion to obscure his political sense, and lead him into acts which tended to undo his work of national unification. As king of Aragon he abstained from inroads on the liberties of his subjects which might have provoked rebellion. A few acts of illegal violence are recorded of him—as when he invited a notorious demagogue of Saragossa to visit him in the palace, and caused the man to be executed without form of trial. Once when presiding over the Aragonese cortes he found himself sitting in a thorough draught and ordered the window to be shut, adding in a lower voice, "If it is not against the *fueros*." But his ill-will did not go beyond such sneers. He was too intent on building up a great state to complicate his difficulties by internal troubles. His arrangement of the convention of Guadalupe, which ended the fierce Agrarian conflicts of Catalonia, was wise and profitable to the country, though it was probably dictated mainly by a wish to weaken the landowners by taking away their feudal rights. Ferdinand died at Madrigalejo in Estremadura on the 23rd of February 1516.

The lives of the kings of this name before Ferdinand V. are contained in the chronicles, and in the *Anales de Aragon* of Zurita, and the *History of Spain* by Mariana. Both deal at length with the life of Ferdinand V. Prescott's *History of the Reign of Ferdinand and Isabella*, in any of its numerous editions, gives a full life of him with copious references to authorities.

FERDINAND VI., king of Spain (1713–1759), second son of Philip V., founder of the Bourbon dynasty, by his first marriage with Maria Louisa of Savoy, was born at Madrid on the 23rd of September 1713. His youth was depressed. His father's second wife, Elizabeth Farnese, was a managing woman, who had no affection except for her own children, and who looked upon her stepson as an obstacle to their fortunes. The hypochondria of his father left Elizabeth mistress of the palace. Ferdinand was married in 1729 to Maria Magdalena Barbara, daughter of John V. of Portugal. The very homely looks of his wife were thought by observers to cause the prince a visible shock when he was first presented to her. Yet he became deeply attached to his wife, and proved in fact nearly as uxorious as his father. Ferdinand was by temperament melancholy, shy and distrustful of his own abilities. When complimented on his shooting, he replied, "It would be hard if there were not something I could do." As king he followed a steady policy of neutrality between France and England, and refused to be tempted by the offers of either into declaring war on the other. In his life he was orderly and retiring, averse from taking decisions, though not incapable of acting firmly, as when he cut short the dangerous intrigues of his able minister Ensenada by dismissing and imprisoning him. Shooting and music were his only pleasures, and he was the generous patron of the famous singer Farinelli (*q.v.*), whose voice soothed his melancholy. The death of his wife Barbara, who had been devoted to him, and who carefully abstained from political intrigue, broke his heart. Between the date of her death in 1758 and his own on the 10th of August 1759 he fell into a state of prostration in which he would not

even dress, but wandered unshaven, unwashed and in a night-gown about his park. The memoirs of the count of Fernan Nuñez give a shocking picture of his death-bed.

A good account of the reign and character of Ferdinand VI. will be found in vol. iv. of Coxe's *Memoirs of the Kings of Spain of the House of Bourbon* (London, 1815). See also *Vida de Carlos III.*, by the count of Fernan Nuñez, ed. M. Morel Fatio and Don A. Paz y Melia (1898).

FERDINAND VII., king of Spain (1784–1833), the eldest son of Charles IV., king of Spain, and of his wife Maria Louisa of Parma, was born at the palace of San Ildefonso near Balsain in the Somosierra hills, on the 14th of October 1784. The events with which he was connected were many, tragic and of the widest European interest. In his youth he occupied the painful position of an heir apparent who was carefully excluded from all share in government by the jealousy of his parents, and the prevalence of a royal favourite. National discontent with a feeble government produced a revolution in 1808 by which he passed to the throne by the forced abdication of his father. Then he spent years as the prisoner of Napoleon, and returned in 1814 to find that while Spain was fighting for independence in his name a new world had been born of foreign invasion and domestic revolution. He came back to assert the ancient doctrine that the sovereign authority resided in his person only. Acting on this principle he ruled frivolously, and with a wanton indulgence of whims. In 1820 his misrule provoked a revolt, and he remained in the hands of insurgents till he was released by foreign intervention in 1823. When free, he revenged himself with a ferocity which disgusted his allies. In his last years he prepared a change in the order of succession established by his dynasty in Spain, which angered a large part of the nation, and made a civil war inevitable. We have to distinguish the part of Ferdinand VII. in all these transactions, in which other and better men were concerned. It can confidently be said to have been uniformly base. He had perhaps no right to complain that he was kept aloof from all share in government while only heir apparent, for this was the traditional practice of his family. But as heir to the throne he had a right to resent the degradation of the crown he was to inherit, and the power of a favourite who was his mother's lover. If he had put himself at the head of a popular rising he would have been followed, and would have had a good excuse. His course was to enter on dim intrigues at the instigation of his first wife, Maria Antonietta of Naples. After her death in 1806 he was drawn into other intrigues by flatterers, and, in October 1807, was arrested for the conspiracy of the Escorial. The conspiracy aimed at securing the help of the emperor Napoleon. When detected, Ferdinand betrayed his associates, and grovelled to his parents. When his father's abdication was extorted by a popular riot at Aranjuez in March 1808, he ascended the throne—not to lead his people manfully, but to throw himself into the hands of Napoleon, in the fatuous hope that the emperor would support him. He was in his turn forced to make an abdication and imprisoned in France, while Spain, with the help of England, fought for its life. At Valençay, where he was sent as a prisoner of state, he sank contentedly into vulgar vice, and did not scruple to applaud the French victories over the people who were suffering unutterable misery in his cause. When restored in March 1814, on the fall of Napoleon, he had just cause to repudiate the impracticable constitution made by the cortes without his consent. He did so, and then governed like an evil-disposed boy—indulging the merest animal passions, listening to a small *camarilla* of low-born favourites, changing his ministers every three months, and acting on the impulse of whims which were sometimes mere buffoonery, but were at times lubricious, or ferocious. The autocratic powers of the Grand Alliance, though forced to support him as the representative of legitimacy in Spain, watched his proceedings with disgust and alarm. "The king," wrote Gentz to the hospodar Caradja on the 1st of December 1814, "himself enters the houses of his first ministers, arrests them, and hands them over to their cruel enemies"; and again, on the 14th of January 1815, "The king has so debased himself that he has become no more than the leading police agent and gaoler of his country." When at last the inevitable revolt came

in 1820 he grovelled to the insurgents as he had done to his parents, descending to the meanest submissions while fear was on him, then intriguing and, when detected, grovelling again. When at the beginning of 1823, as a result of the congress of Verona, the French invaded Spain,¹ "invoking the God of St Louis, for the sake of preserving the throne of Spain to a descendant of Henry IV., and of reconciling that fine kingdom with Europe," and in May the revolutionary party carried Ferdinand to Cadiz, he continued to make promises of amendment till he was free. Then, in violation of his oath to grant an amnesty, he revenged himself for three years of coercion by killing on a scale which revolted his "rescuers," and against which the duke of Angoulême, powerless to interfere, protested by refusing the Spanish decorations offered him for his services. During his last years Ferdinand's energy was abated. He no longer changed ministers every few months as a sport, and he allowed some of them to conduct the current business of government. His habits of life were telling on him. He became torpid, bloated and horrible to look at. After his fourth marriage in 1829 with Maria Christina of Naples, he was persuaded by his wife to set aside the law of succession of Philip V., which gave a preference to all the males of the family in Spain over the females. His marriage had brought him only two daughters. When well, he consented to the change under the influence of his wife. When ill, he was terrified by priestly advisers, who were partisans of his brother Don Carlos. What his final decision was is perhaps doubtful. His wife was mistress by his death-bed, and she could put the words she chose into the mouth of a dead man—and could move the dead hand at her will. Ferdinand died on the 29th of September 1833. It had been a frequent saying with the more zealous royalists of Spain that a king must be wiser than his ministers, for he was placed on the throne and directed by God. Since the reign of Ferdinand VII. no one has maintained this unqualified version of the great doctrine of divine right.

King Ferdinand VII. kept a diary during the troubled years 1820-1823, which has been published by the count de Casa Valencia.

FERDINAND II. (1810-1859), king of the Two Sicilies, son of Francis I., was born at Palermo on the 12th of January 1810. In his early years he was credited with Liberal ideas and he was fairly popular, his free and easy manners having endeared him to the *lazzaroni*. On succeeding his father in 1830, he published an edict in which he promised to "give his most anxious attention to the impartial administration of justice," to reform the finances, and to "use every effort to heal the wounds which had afflicted the kingdom for so many years"; but these promises seem to have been meant only to lull discontent to sleep, for although he did something for the economic development of the kingdom, the existing burden of taxation was only slightly lightened, corruption continued to flourish in all departments of the administration, and an absolutism was finally established harsher than that of all his predecessors, and supported by even more extensive and arbitrary arrests. Ferdinand was naturally shrewd, but badly educated, grossly superstitious and possessed of inordinate self-esteem. Though he kept the machinery of his kingdom fairly efficient, and was a patriot to the extent of brooking no foreign interference, he made little account of the wishes or welfare of his subjects. In 1832 he married Cristina, daughter of Victor Emmanuel I., king of Sardinia, and shortly after her death in 1836 he took for a second wife Maria Theresa, daughter of archduke Charles of Austria. After his Austrian alliance the bonds of despotism were more closely tightened, and the increasing discontent of his subjects was manifested by various abortive attempts at insurrection; in 1837 there was a rising in Sicily in consequence of the outbreak of cholera, and in 1843 the Young Italy Society tried to organize a general rising, which, however, only manifested itself in a series of isolated outbreaks. The expedition of the Bandiera brothers (*q.v.*) in 1844, although it had no practical result, aroused great ill-feeling owing to the cruel sentences passed on the rebels. In January 1848 a rising in Sicily was the signal for revolutions all over Italy and Europe; it was followed by a movement in Naples, and the king

¹ Louis XVIII.'s speech from the throne, Jan. 28, 1823.

granted a constitution which he swore to observe. A dispute, however, arose as to the nature of the oath which should be taken by the members of the chamber of deputies, and as neither the king nor the deputies would yield, serious disturbances broke out in the streets of Naples on the 15th of May; so the king, making these an excuse for withdrawing his promise, dissolved the national parliament on the 13th of March 1849. He retired to Gaeta to confer with various deposed despots, and when the news of the Austrian victory at Novara (March 1849) reached him, he determined to return to a reactionary policy. Sicily, whence the Royalists had been expelled, was subjugated by General Filangieri (*q.v.*), and the chief cities were bombarded, an expedient which won for Ferdinand the epithet of "King Bomba." During the last years of his reign espionage and arbitrary arrests prevented all serious manifestations of discontent among his subjects. In 1851 the political prisoners of Naples were calculated by Mr Gladstone in his letters to Lord Aberdeen (1851) to number 15,000 (probably the real figure was nearer 40,000), and so great was the scandal created by the prevailing reign of terror, and the abominable treatment to which the prisoners were subjected, that in 1856 France and England made diplomatic representations to induce the king to mitigate his rigour and proclaim a general amnesty, but without success. An attempt was made by a soldier to assassinate Ferdinand in 1856. He died on the 22nd of May 1856, just after the declaration of war by France and Piedmont against Austria, which was to result in the collapse of his kingdom and his dynasty. He was bigoted, cruel, mean, treacherous, though not without a certain *bonhomie*; the only excuse that can be made for him is that with his heredity and education a different result could scarcely be expected.

See *Correspondence respecting the Affairs of Naples and Sicily, 1848-1849*, presented to both Houses of Parliament by Command of Her Majesty, 4th May 1849; *Two Letters to the Earl of Aberdeen*, by the Right Hon. W. E. Gladstone, 1st ed., 1851 (an edition published in 1852 and the subsequent editions contain an *Examination of the Official Reply of the Neapolitan Government*); N. Nisco, *Ferdinando II. il suo regno* (Naples, 1884); H. Remsen Whitehouse, *The Collapse of the Kingdom of Naples* (New York, 1899); R. de Cesare, *La Caduta d'un Regno*, vol. i. (Città di Castello, 1900), which contains a great deal of fresh information, but is badly arranged and not always reliable. (L. V.*)

FERDINAND III. (1769-1824), grand duke of Tuscany, and archduke of Austria, second son of the emperor Leopold II., was born on the 6th of May 1769. On his father becoming emperor in 1790, he succeeded him as grand duke of Tuscany. Ferdinand was one of the first sovereigns to enter into diplomatic relations with the French republic (1793); and although, a few months later, he was compelled by England and Russia to join the coalition against France, he concluded peace with that power in 1795, and by observing a strict neutrality saved his dominions from invasion by the French, except for a temporary occupation of Livorno, till 1799, when he was compelled to vacate his throne, and a provisional Republican government was established at Florence. Shortly afterwards the French arms suffered severe reverses in Italy, and Ferdinand was restored to his territories; but in 1801, by the peace of Lunéville, Tuscany was converted into the kingdom of Etruria, and he was again compelled to return to Vienna. In lieu of the sovereignty of Tuscany, he obtained in 1802 the electorship of Salzburg, which he exchanged by the peace of Pressburg in 1805 for that of Würzburg. In 1806 he was admitted as grand duke of Würzburg to the confederation of the Rhine. He was restored to the throne of Tuscany after the abdication of Napoleon in 1814 and was received with enthusiasm by the people, but had again to vacate his capital for a short time in 1815, when Murat proclaimed war against Austria. The final overthrow of the French supremacy at the battle of Waterloo secured him, however, in the undisturbed possession of his grand duchy during the remainder of his life. The restoration in Tuscany was not accompanied by the reactionary excesses which characterized it elsewhere, and a large part of the French legislation was retained. His prime minister was Count V. Fossombroni (*q.v.*). The mild rule of Ferdinand, his solicitude for the welfare of his subjects,

his enlightened patronage of art and science, his encouragement of commerce, and his toleration render him an honourable exception to the generality of Italian princes. At the same time his paternal despotism tended to emasculate the Tuscan character. He died in June 1824, and was succeeded by his son Leopold II. (*q.v.*).

BIBLIOGRAPHY.—A. von Reumont, *Geschichte Toscanas* (Gotha, 1877); and "Federico Manfredini e la politica Toscana nei primi anni di Ferdinando III." (in the *Archivio Storico Italiano*, 1877); Emmer, *Erzherzog Ferdinand III., Grossherzog von Toskana* (Salzburg, 1871); C. Tivaroni, *L'Italia durante il dominio francese*, ii. 1-44 (Turin, 1889), and *L'Italia durante il dominio austriaco*, ii. 1-18 (Turin, 1893). See also under FOSSOMBRONI; VITTORIO; and CAPPONI, GINO.

FERDINAND, MAXIMILIAN KARL LEOPOLD MARIA, king of Bulgaria (1861–), fifth and youngest son of Prince Augustus of Saxe-Coburg and Gotha, was born on the 26th of February 1861. Great care was exercised in his education, and every encouragement given to the taste for natural history which he exhibited at an early age. In 1879 he travelled with his brother Augustus to Brazil, and the results of their botanical observations were published at Vienna, 1883-1888, under the title of *Itinera Principum S. Coburgi*. Having been appointed to a lieutenancy in the 2nd regiment of Austrian hussars, he was holding this rank when, by unanimous vote of the National Assembly, he was elected prince of Bulgaria, on the 7th of July 1887, in succession to Prince Alexander, who had abdicated on the 7th of September preceding. He assumed the government on the 14th of August 1887, for Russia for a long time refused to acknowledge the election, and he was accordingly exposed to frequent military conspiracies, due to the influence or attitude of that power. The firmness and vigour with which he met all attempts at revolution were at length rewarded, and his election was confirmed in March 1896 by the Porte and the great powers. On the 20th of April 1893 he married Marie Louise de Bourbon (d. 1899), eldest daughter of Duke Robert of Parma, and in May following the Grand Sobrane confirmed the title of Royal Highness to the prince and his heir. The prince adhered to the Roman Catholic faith, but his son and heir, the young Prince Boris, was received into the Orthodox Greek Church on the 14th of February 1896. Prince Boris, to whom the tsar Nicholas III. became godfather, accompanied his father to Russia in 1898, when Prince Ferdinand visited St Petersburg and Moscow, and still further strengthened the bond already existing between Russia and Bulgaria. In 1908 Ferdinand married Eleanor (b. 1860), a princess of the house of Reuss. Later in the year, in connexion with the Austrian annexation of Bosnia-Herzegovina and the crisis with Turkey, he proclaimed the independence of Bulgaria, and took the title of king or tsar. (See BULGARIA, and EUROPE: *History*.)

FERDINAND, duke of Brunswick (1721-1792), Prussian general field marshal, was the fourth son of Ferdinand Albert, duke of Brunswick, and was born at Wolfenbüttel on the 12th of January 1721. He was carefully educated with a view to a military career, and in his twentieth year he was made chief of a newly-raised Brunswick regiment in the Prussian service. He was present in the battles of Mollwitz and Chotusitz. In succession to Margrave Wilhelm of Brandenburg, killed at Prague (1744), Ferdinand received the command of Frederick the Great's *Leibgarde* battalion, and at Sohr (1745) he distinguished himself so greatly at the head of his brigade that Frederick wrote of him, "le Prince Ferdinand s'est surpassé." The height which he captured was defended by his brother Ludwig as an officer of the Austrian service, and another brother of Duke Ferdinand was killed by his side in the charge. During the ten years' peace he was in the closest touch with the military work of Frederick the Great, who supervised the instruction of the guard battalion, and sought to make it a model of the whole Prussian army. Ferdinand was, moreover, one of the most intimate friends of the king, and thus he was peculiarly fitted for the tasks which afterwards fell to his lot. In this time he became successively major-general and lieutenant-general. In the first campaign of the Seven Years' War Ferdinand com-

manded one of the Prussian columns which converged upon Dresden, and in the operations which led up to the surrender of the Saxon army at Pirna (1756), and at the battle of Lobositz, he led the right wing of the Prussian infantry. In 1757 he was present, and distinguished himself, at Prague, and he served also in the campaign of Rossbach. Shortly after this he was appointed to command the allied forces which were being organized for the war in western Germany. He found this army dejected by a reverse and a capitulation, yet within a week of his taking up the command he assumed the offensive, and thus began the career of victory which made his European reputation as a soldier. His conduct of the five campaigns which followed (see SEVEN YEARS' WAR) was naturally influenced by the teachings of Frederick, whose pupil the duke had been for so many years. Ferdinand, indeed, approximated more closely to Frederick in his method of making war than any other general of the time. Yet his task was in many respects far more difficult than that of the king. Frederick was the absolute master of his own homogeneous army, Ferdinand merely the commander of a group of contingents, and answerable to several princes for the troops placed under his control. The French were by no means despicable opponents in the field, and their leaders, if not of the first grade, were cool and experienced veterans. In 1758 he fought and won the battle of Crefeld, several marches beyond the Rhine, but so advanced a position he could not well maintain, and he fell back to the Lippe. He resumed a bold offensive in 1759, only to be repulsed at Bergen (near Frankfort-on-Main). On the 1st of August of this year Ferdinand won the brilliant victory of Minden (*q.v.*). Vellinghausen, Wilhelmsthal, Warburg and other victories attested the increasing power of Ferdinand in the following campaigns, and Frederick, hard pressed in the eastern theatre of war, owed much of his success in an almost hopeless task to the continued pressure exerted by Ferdinand in the west. In promoting him to be a field marshal (November 1758) Frederick acknowledged his debt in the words, "Je n'ai fait que ce que je dois, mon cher Ferdinand." After Minden, King George II. gave the duke the order of the Garter, and the thanks of the British parliament were voted on the same occasion to the "Victor of Minden." After the war he was honoured by other sovereigns, and he received the rank of field marshal and a regiment from the Austrians. During the War of American Independence there was a suggestion, which came to nothing, of offering him the command of the British forces. He exerted himself to compensate those who had suffered by the Seven Years' War, devoting to this purpose most of the small income he received from his various offices and the rewards given to him by the allied princes. The estrangement of Frederick and Ferdinand in 1766 led to the duke's retirement from Prussian service, but there was no open breach between the old friends, and Ferdinand visited the king in 1772, 1777, 1779 and 1782. After 1766 he passed the remainder of his life at his castle of Veschede, where he occupied himself in building and other improvements, and became a patron of learning and art, and a great benefactor of the poor. He died on the 3rd of July 1792. The merits, civil and military, of the prince were recognized by memorials not only in Prussia and Hanover, but also in Denmark, the states of western Germany and England. The Prussian memorials include an equestrian statue at Berlin (1863).

See E. v. L. Knesebeck, *Ferdinand, Herzog von Braunschweig und Lüneburg, während des Siebenjährigen Kriegs* (2 vols., Hanover, 1857-1858); Von Westphalen, *Geschichte der Feldzüge des Herzogs Ferdinands von Braunschweig-Lüneburg* (5 vols., Berlin, 1859-1872); v. d. Osten, *Tagebuch des Herzogl. Gen. Adjutanten v. Reden* (Hamburg, 1805); v. Schafer, *Vie militaire du maréchal Prince Ferdinand* (Magdeburg, 1796; Nuremberg, 1798); also the *Œuvres* of Frederick the Great, *passim*, and authorities for the SEVEN YEARS' WAR.

FERDINAND (1577-1650), elector and archbishop of Cologne, son of William V., duke of Bavaria, was born on the 7th of October 1577. Intended for the church, he was educated by the Jesuits at the university of Ingolstadt, and in 1595 became coadjutor archbishop of Cologne. He became elector and archbishop in 1612 on the death of his uncle Ernest, whom he also succeeded as bishop of Liège, Munster and Hildesheim. He

endeavoured resolutely to root out heresy in the lands under his rule, and favoured the teaching of the Jesuits in every possible way. He supported the league founded by his brother Maximilian I., duke of Bavaria, and wished to involve the leaguers in a general attack on the Protestants of north Germany. The cool political sagacity of the duke formed a sharp contrast to the impetuosity of the archbishop, and he refused to accede to his brother's wish; but, in spite of these temporary differences, Ferdinand sent troops and money to the assistance of the league when the Thirty Years' War broke out in 1619. The elector's alliance with the Spaniards secured his territories to a great extent from the depredations of the war until the arrival of the Swedes in Germany in 1630, when the extension of the area of the struggle to the neighbourhood of Cologne induced him to enter into negotiations for peace. Nothing came of these attempts until 1647, when he joined his brother Maximilian in concluding an armistice with France and Sweden at Ulm. The elector's later years were marked by a conflict with the citizens of Liège; and when the peace of Westphalia freed him from his enemies, he was able to crush the citizens and deprive them of many privileges. Ferdinand, who had held the bishopric of Paderborn since 1618, died at Arnsberg on the 13th of September 1650, and was buried in the cathedral at Cologne.

See L. Ennen, *Frankreich und der Niederrhein oder Geschichte von Stadt und Kurstadt Köln seit dem 30jährigen Kriege*, Band i. (Cologne, 1855-1856).

FERENTINO (anc. *Ferentinum*, to be distinguished from Ferentum or Ferentinum in Etruria), a town and episcopal see of Italy, in the province of Rome, from which it is 48 m. E.S.E. by rail. Pop. (1901) 7957 (town), 12,279 (commune). It is picturesquely situated on a hill 1290 ft. above sea-level, and still possesses considerable remains of ancient fortifications. The lower portion of the outer walls, which probably did not stand free, is built of roughly hewn blocks of a limestone which naturally splits into horizontal layers; above this in places is walling of rectangular blocks of tufa. Two gates, the Porta Sanguinaria (with an arch with tufa voussoirs), and the Porta S. Maria, a double gate constructed entirely of rectangular blocks of tufa, are preserved. Outside this gate is the tomb of A. Quintilius Priscus, a citizen of Ferentinum, with a long inscription cut in the rock. See Th. Mommsen in *Corp. Inscript. Lat.* x. (Berlin, 1883), No. 5853.

The highest part of the town, the acropolis, is fortified also; it has massive retaining walls similar to those of the lower town. At the eastern corner, under the present episcopal palace, the construction is somewhat more careful. A projecting rectangular terrace has been erected, supported by walls of quadrilateral blocks of limestone arranged almost horizontally; while upon the level thus formed a building of rectangular blocks of local travertine was raised. The projecting cornice of this building bears two inscriptions of the period of Sulla, recording its construction by two censors (local officials); and in the interior, which contains several chambers, there is an inscription of the same censors over one of the doors, and another over a smaller external side door. The windows lighting these chambers come immediately above the cornice, and the wall continues above them again. The whole of this construction probably belongs to one period (Mommsen, *op. cit.* No. 5837 seq.). The cathedral occupies a part of the level top of the ancient acropolis; it was reconstructed on the site of an older church in 1099-1118; the interior was modernized in 1693, but was restored to its original form in 1902. It contains a fine canopy in the "Cosmatesque" style (see *Relazione dei lavori eseguiti dall' ufficio tecnico per la conservazione dei monumenti di Rome a provincia*, Rome, 1903, 175 seq.). The Gothic church of S. Maria Maggiore, in the lower town (13th-14th century), has a very fine exterior; the interior, the plan of which is a perfect rectangle, has been spoilt by restoration. There are several other Gothic churches in the town.

Ferentinum was the chief town of the Hernici; it was captured from them by the Romans in 364 B.C. and took no part in the rising of 306 B.C. The inhabitants became Roman citizens after

195 B.C., and the place later became a *municipium*. It lay just above the Via Latina and, being a strong place, served for the detention of hostages. Horace praises its quietness, and it does not appear much in later history. (T. As.)

See further Ashby, *Röm. Mitteil.* xxiv. (1909).

FERENTUM, or FERENTINUM, an ancient town of Etruria, about 6 m. N. of Viterbo (the ancient name of which is unknown) and 3½ m. E. of the Via Cassia. It was the birthplace (32 A.D.) of the emperor Otho, was destroyed in the 11th century, and is now entirely deserted, though it retains its ancient name. It occupied a ridge running from east to west, with deep ravines on three sides. There are some remains of the city walls, and of various Roman structures, but the most important ruin is that of the theatre. The stage front is still standing; it is pierced by seven openings with flat arches, and shows traces of reconstruction. The necropolis was on the hill called Talone on the north-east.

See G. Dennis, *Cities and Cemeteries of Etruria* (London, 1883), i. 156; *Notizie degli scavi*, 1900, 401; 1902, 84; 1905, 31.

FERETORY (from Lat. *feretrum*, a bier, from *ferre*, to bear), in architecture, the enclosure or chapel within which the "fereter" shrine, or tomb (as in Henry VII.'s chapel), was placed.

FERGHANA, or FERGANA, a province of Russian Turkestan, formed in 1876 out of the former khanate of Khokand. It is bounded by the provinces of Syr-darya on the N. and N.W., Samarkand on the W., and Semiryechensk on the N.E., by Chinese Turkestan (Kashgaria) on the E., and by Bokhara and Afghanistan on the S. Its southern limits, on the Pamirs, were fixed by an Anglo-Russian commission in 1885, from Zor-kul (Victoria Lake) to the Chinese frontier; and Shignan, Roshan and Wakhan were assigned to Bokhara in exchange for part of Darvaz (on the left bank of the Panj), which was given to Afghanistan. The area amounts to some 53,000 sq. m., of which 17,600 sq. m. are on the Pamirs. The most important part of the province is a rich and fertile valley (1200-1500 ft.), opening towards the S.W. Thence the province stretches northwards across the mountains of the Tian-shan system and southwards across the Alai and Trans-Alai Mts., which reach their highest point in Peak Kaufmann (23,000 ft.), in the latter range. The valley owes its fertility to two rivers, the Naryn and the Karadarya, which unite within its confines, near Namangan, to form the Syr-darya or Jaxartes. These streams, and their numerous mountain affluents, not only supply water for irrigation, but also bring down vast quantities of sand, which is deposited alongside their courses, more especially alongside the Syr-darya where it cuts its way through the Khojent-Ajar ridge, forming there the Karakchikum. This expanse of moving sands, covering an area of 750 sq. m., under the influence of south-west winds, encroaches upon the agricultural districts. The climate of this valley is dry and warm. In March the temperature reaches 68° F., and then rapidly rises to 95° in June, July and August. During the five months following April no rain falls, but it begins again in October. Snow and frost (down to -4° F.) occur in December and January.

Out of some 3,000,000 acres of cultivated land, about two-thirds are under constant irrigation and the remaining third under partial irrigation. The soil is admirably cultivated, the principal crops being wheat, rice, barley, maize, millet, lucerne, tobacco, vegetables and fruit. Gardening is conducted with a high degree of skill and success. Large numbers of horses, cattle and sheep are kept, and a good many camels are bred. Over 17,000 acres are planted with vines, and some 350,000 acres are under cotton. Nearly 1,000,000 acres are covered with forests. The government maintains a forestry farm at Marghelan, from which 120,000 to 200,000 young trees are distributed free every year amongst the inhabitants of the province.

Silkworm breeding, formerly a prosperous industry, has decayed, despite the encouragement of a state farm at New Marghelan. Coal, iron, sulphur, gypsum, rock-salt, lacustrine salt and naphtha are all known to exist, but only the last two are extracted. Some seventy or eighty factories are engaged in cotton cleaning; while leather, saddlery, paper and cutlery

are the principal products of the domestic industries. A considerable trade is carried on with Russia; raw cotton, raw silk, tobacco, hides, sheepskins, fruit and cotton and leather goods are exported, and manufactured wares, textiles, tea and sugar are imported and in part re-exported to Kashgaria and Bokhara. The total trade of Ferghana reaches an annual value of nearly £3,500,000. A new impulse was given to trade by the extension (1899) of the Transcaspian railway into Ferghana and by the opening of the Orenburg-Tashkent railway (1906). The routes to Kashgaria and the Pamirs are mere bridle-paths over the mountains, crossing them by lofty passes. For instance, the passes of Kara-kazyk (14,400 ft.) and Tenzhiz-hai (11,200 ft.), both passable all the year round, lead from Marghelan to Karateghin and the Pamirs, while Kashgar is reached via Osh and Gulcha, and then over the passes of Terek-davan (12,205 ft.; open all the year round), Taldyk (11,500 ft.), Archat (11,600 ft.), and Shart-davan (14,000 ft.). Other passes leading out of the valley are the Jityk (12,460 ft.), S. of Khokand; the Isfairam (12,000 ft.), leading to the glen of the Surkhab, and the Kavuk (13,000 ft.), across the Alai Mts.

The population numbered 1,571,243 in 1897, and of that number 707,132 were women and 286,369 were urban. In 1906 it was estimated at 1,796,500. Two-thirds of the total are Sarts and Uzbegs (of Turkic origin). They live mostly in the valley; while the mountain slopes above it are occupied by Kirghiz, partly nomad and pastoral, partly agricultural and settled. The other races are Tajiks, Kashgarians, Kipchaks, Jews and Gypsies. The governing classes are of course Russians, who constitute also the merchant and artisan classes. But the merchants of West Turkestan are called all over central Asia Andijanians, from the town of Andijan in Ferghana. The great mass of the population are Mussulmans (1,039,115 in 1897). The province is divided into five districts, the chief towns of which are New Marghelan, capital of the province (8977 inhabitants in 1897), Andijan (49,682 in 1900), Khokand (86,704 in 1900), Namangan (61,906 in 1897), and Osh (37,397 in 1900); but Old Marghelan (42,855 in 1900) and Chust (13,686 in 1897) are also towns of importance. For the history, see KHOKAND. (P. A. K.; J. T. BE.)

FERGUS FALLS, a city and the county-seat of Otter Tail county, Minnesota, U.S.A., on the Red river, 170 m. N.W. of Minneapolis. Pop. (1890) 3772; (1900) 6072, of whom 2131 were foreign-born; (1905) 6692; (1910) 6887. A large part of the population is of Scandinavian birth or descent. Fergus Falls is served by the Great Northern and the Northern Pacific railways. Situated in the celebrated "park region" of the state, the city possesses great natural beauty, which has been enhanced by a system of boulevards and well-kept private lawns. Lake Alice, in the residential district, adds to the city's attractions. The city has a public library, a county court house, St Luke's hospital, the G. B. Wright memorial hospital, and a city hall. It is the seat of a state hospital for the insane (1887) with about 1600 patients, of a business college, of the Park Region Luther College (Norwegian Lutheran, 1892), and of the North-western College (Swedish Lutheran; opened in 1901). It has one of the finest water-powers in the state. Flour is the principal product; among others are woollen goods, foundry and machine-shop products, wooden ware, sash, doors and blinds, caskets, shirts, wagons and packed meats. The city owns and operates its water-works and its electric-lighting plant. Fergus Falls was settled about 1859 and was incorporated in 1863.

FERGUSON, ADAM (1723-1816), Scottish philosopher and historian, was born on the 20th of June 1723, at Logierait, Perthshire. He was educated at Perth grammar school and the university of St Andrews. In 1745, owing to his knowledge of Gaelic, he was appointed deputy chaplain of the 43rd (afterwards the 42nd) regiment (the Black Watch), the licence to preach being granted him by special dispensation, although he had not completed the required six years of theological study. At the battle of Fontenoy (1745) Ferguson fought in the ranks throughout the day, and refused to leave the field, though ordered to do so by his colonel. He continued attached to the regiment till

1754, when, disappointed at not obtaining a living, he abandoned the clerical profession and resolved to devote himself to literary pursuits. In January 1757 he succeeded David Hume as librarian to the faculty of advocates, but soon relinquished this office on becoming tutor in the family of Lord Bute.

In 1759 Ferguson was appointed professor of natural philosophy in the university of Edinburgh, and in 1764 was transferred to the chair of "pneumatics" (mental philosophy) "and moral philosophy." In 1767, against Hume's advice, he published his *Essay on the History of Civil Society*, which was well received and translated into several European languages. In 1776 appeared his (anonymous) pamphlet on the American revolution in opposition to Dr Price's *Observations on the Nature of Civil Liberty*, in which he sympathized with the views of the British legislature. In 1778 Ferguson was appointed secretary to the commission which endeavoured, but without success, to negotiate an arrangement with the revolted colonies. In 1783 appeared his *History of the Progress and Termination of the Roman Republic*; it was very popular, and went through several editions. Ferguson was led to undertake this work from a conviction that the history of the Romans during the period of their greatness was a practical illustration of those ethical and political doctrines which were the object of his special study. The history is written in an agreeable style and a spirit of impartiality, and gives evidence of a conscientious use of authorities. The influence of the author's military experience shows itself in certain portions of the narrative. Finding himself unequal to the labour of teaching, he resigned his professorship in 1785, and devoted himself to the revision of his lectures, which he published (1792) under the title of *Principles of Moral and Political Science*.

When in his seventieth year, Ferguson, intending to prepare a new edition of the history, visited Italy and some of the principal cities of Europe, where he was received with honour by learned societies. From 1795 he resided successively at the old castle of Neidpath near Peebles, at Hallyards on Manor Water and at St Andrews, where he died on the 22nd of February 1816.

In his ethical system Ferguson treats man throughout as a social being, and illustrates his doctrines by political examples. As a believer in the progression of the human race, he placed the principle of moral approbation in the attainment of perfection. His speculations were carefully criticized by Cousin (see his *Cours d'histoire de la philosophie morale au dix-huitième siècle*, pt. ii., 1839-1840):—"We find in his method the wisdom and circumspection of the Scottish school, with something more masculine and decisive in the results. The principle of perfection is a new one, at once more rational and comprehensive than benevolence and sympathy, which in our view places Ferguson as a moralist above all his predecessors." By this principle Ferguson endeavours to reconcile all moral systems. With Hobbes and Hume he admits the power of self-interest or utility, and makes it enter into morals as the law of self-preservation. Hutcheson's theory of universal benevolence and Smith's idea of sympathy he combines under the law of society. But, as these laws are the means rather than the end of human destiny, they are subordinate to a supreme end, and this supreme end is perfection. In the political part of his system Ferguson follows Montesquieu, and pleads the cause of well-regulated liberty and free government. His contemporaries, with the exception of Hume, regarded his writings as of great importance; in point of fact they are superficial. The facility of their style and the frequent occurrence of would-be weighty epigrams blinded his critics to the fact that, in spite of his recognition of the importance of observation, he made no real contribution to political theory (see Sir Leslie Stephen, *English Thought in the Eighteenth Century*, x. 89-90).

The chief authority for Ferguson's life is the *Biographical Sketch* by John Small (1864); see also *Public Characters* (1799-1800); *Gentleman's Magazine*, i. (1816 supp.); W. R. Chambers's *Biographical Dictionary of Eminent Scotsmen*; memoir by Principal Lee in early editions of the *Encyclopaedia Britannica*; J. McCosh, *The Scottish Philosophy* (1875); articles in *Dictionary of National Biography* and *Edinburgh Review* (January 1867); Lord Henry Cockburn, *Memorials of his Time* (1856).

FERGUSON, JAMES (1710–1776), Scottish mechanician and astronomer, was born near Rothiemay in Banffshire on the 25th of April 1710, of parents in very humble circumstances. He first learned to read by overhearing his father teach his elder brother, and with the help of an old woman was “able,” he says in his autobiography, “to read tolerably well before his father thought of teaching him.” After receiving further instruction in reading from his father, who also taught him to write, he was sent at the age of seven for three months to the grammar school at Keith. His taste for mechanics was about this time accidentally awakened on seeing his father making use of a lever to raise a part of the roof of his house—an exhibition of seeming strength which at first “excited his terror as well as wonder.” In 1720 he was sent to a neighbouring farm to keep sheep, where in the daytime he amused himself by making models of mills and other machines, and at night in studying the stars. Afterwards, as a servant with a miller, and then with a doctor, he met with hardships which rendered his constitution feeble through life. Being compelled by his weak health to return home, he there amused himself with making a clock having wooden wheels and a whalebone spring. When slightly recovered he showed this and some other inventions to a neighbouring gentleman, who engaged him to clean his clocks, and also desired him to make his house his home. He there began to draw patterns for needlework, and his success in this art led him to think of becoming a painter. In 1734 he went to Edinburgh, where he began to take portraits in miniature, by which means, while engaged in his scientific studies, he supported himself and his family for many years. Subsequently he settled at Inverness, where he drew up his *Astronomical Rotula* for showing the motions of the planets, places of the sun and moon, &c., and in 1743 went to London, which was his home for the rest of his life. He wrote various papers for the Royal Society, of which he became a fellow in 1763, devised astronomical and mechanical models, and in 1748 began to give public lectures on experimental philosophy. These he repeated in most of the principal towns in England. His deep interest in his subject, his clear explanations, his ingeniously constructed diagrams, and his mechanical apparatus rendered him one of the most successful of popular lecturers on scientific subjects. It is, however, as the inventor and improver of astronomical and other scientific apparatus, and as a striking instance of self-education, that he claims a place among the most remarkable men of science of his country. During the latter years of his life he was in receipt of a pension of £50 from the privy purse. He died in London on the 17th of November 1776.

Ferguson's principal publications are *Astronomical Tables* (1763); *Lectures on Select Subjects* (1st ed., 1761, edited by Sir David Brewster in 1805); *Astronomy explained upon Sir Isaac Newton's Principles* (1756, edited by Sir David Brewster in 1811); and *Select Mechanical Exercises, with a Short Account of the Life of the Author, written by himself* (1773). This autobiography is included in a *Life* by E. Henderson, LL.D. (1st ed., 1867; 2nd, 1870), which also contains a full description of Ferguson's principal inventions, accompanied with illustrations. See also *The Story of the Peasant-Boy Philosopher*, by Henry Mayhew (1857).

FERGUSON, ROBERT (c. 1637–1714), British conspirator and pamphleteer, called the “Plotter,” was a son of William Ferguson (d. 1699) of Badifurrow, Aberdeenshire, and after receiving a good education, probably at the university of Aberdeen, became a Presbyterian minister. According to Bishop Burnet he was cast out by the Presbyterians; but whether this be so or not, he soon made his way to England and became vicar of Godmersham, Kent, from which living he was expelled by the Act of Uniformity in 1662. Some years later, having gained meanwhile a reputation as a theological controversialist and become a person of importance among the Nonconformists, he attracted the notice of the earl of Shaftesbury and the party which favoured the exclusion of the duke of York (afterwards King James II.) from the throne, and he began to write political pamphlets just at the time when the feeling against the Roman Catholics was at its height. In 1680 he wrote “A Letter to a Person of Honour concerning the ‘Black Box,’” in which he

supported the claim of the duke of Monmouth to the crown against that of the duke of York; returning to the subject after Charles II. had solemnly denied the existence of a marriage between himself and Lucy Waters. He took an active part in the controversy over the Exclusion Bill, and claimed to be the author of the whole of the pamphlet “No Protestant Plot” (1681), parts of which are usually ascribed to Shaftesbury. Ferguson was deeply implicated in the Rye House Plot, although he asserted that he had frustrated both this and a subsequent attempt to assassinate the king, and he fled to Holland with Shaftesbury in 1682, returning to England early in 1683. For his share in another plot against Charles II. he was declared an outlaw, after which he entered into communication with Argyll, Monmouth and other malcontents. Ferguson then took a leading part in organizing the rising of 1685. Having overcome Monmouth's reluctance to take part in this movement, he accompanied the duke to the west of England and drew up the manifesto against James II., escaping to Holland after the battle of Sedgemoor. He landed in England with William of Orange in 1688, and aided William's cause with his pen; but William and his advisers did not regard him as a person of importance, although his services were rewarded with a sinecure appointment in the Excise. Chagrined at this treatment, Ferguson was soon in correspondence with the exiled Jacobites. He shared in all the plots against the life of William, and after his removal from the Excise in 1692 wrote violent pamphlets against the government. Although he was several times arrested on suspicion, he was never brought to trial. He died in great poverty in 1714, leaving behind him a great and deserved reputation for treachery. It has been thought by Macaulay and others that Ferguson led the English government to believe that he was a spy in their interests, and that his frequent escapes from justice were due to official connivance. In a proclamation issued for his arrest in 1683 he is described as “a tall lean man, dark brown hair, a great Roman nose, thin-jawed, heat in his face, speaks in the Scotch tone, a sharp piercing eye, stoops a little in the shoulders.” Besides numerous pamphlets Ferguson wrote: *History of the Revolution* (1706); *Qualifications requisite in a Minister of State* (1710); and part of the *History of all the Mobs, Tumults and Insurrections in Great Britain* (London, 1715).

See James Ferguson, *Robert Ferguson, the Plotter* (Edinburgh, 1887), which gives a favourable account of Ferguson.

FERGUSON, SIR SAMUEL (1810–1886), Irish poet and antiquary, was born at Belfast, on the 10th of March 1810. He was educated at Trinity College, Dublin, was called to the Irish bar in 1838, and was made Q.C. in 1859, but in 1867 retired from practice upon his appointment as deputy-keeper of the Irish records, then in a much neglected condition. He was an excellent civil servant, and was knighted in 1878 for his services to the department. His spare time was given to general literature, and in particular to poetry. He had long been a leading contributor to the *Dublin University Magazine* and to *Blackwood*, where he had published his two literary masterpieces, “The Forging of the Anchor,” one of the finest of modern ballads, and the humorous prose extravaganza of “Father Tom and the Pope.” He published *Lays of the Western Gael* in 1865, *Poems* in 1880, and in 1872 *Congal*, a metrical narrative of the heroic age of Ireland, and, though far from ideal perfection, perhaps the most successful attempt yet made by a modern Irish poet to revivify the spirit of the past in a poem of epic proportions. Lyrics have succeeded better in other hands; many of Ferguson's pieces on modern themes, notably his “Lament for Thomas Davis” (1845), are, nevertheless, excellent. He was an extensive contributor on antiquarian subjects to the *Transactions of the Royal Irish Academy*, and was elected its president in 1882. His manners were delightful, and his hospitality was boundless. He died at Howth on the 9th of August 1886. His most important antiquarian work, *Ogham Inscriptions in Ireland, Wales, Scotland*, was published in the year after his death.

See *Sir Samuel Ferguson in the Ireland of his Day* (1896), by his wife, Mary C. Ferguson; also an article by A. P. Graves in *A Treasury of Irish Poetry in the English Tongue* (1900), edited by Stopford Brooke and T. W. Rolleston.

FERGUSSON, JAMES (1808–1886), Scottish writer on architecture, was born at Ayr on the 22nd of January 1808. His father was an army surgeon. After being educated first at the Edinburgh high school, and afterwards at a private school at Hounslow, James went to Calcutta as partner in a mercantile house. Here he was attracted by the remains of the ancient architecture of India, little known or understood at that time. The successful conduct of an indigo factory, as he states in his own account, enabled him in about ten years to retire from business and settle in London. The observations made on Indian architecture were first embodied in his book on *The Rock-cut Temples of India*, published in 1845. The task of analysing the historic and aesthetic relations of this type of ancient buildings led him further to undertake a historical and critical comparative survey of the whole subject of architecture in *The Handbook of Architecture*, a work which first appeared in 1855. This did not satisfy him, and the work was reissued ten years later in a much more extended form under the title of *The History of Architecture*. The chapters on Indian architecture, which had been considered at rather disproportionate length in the *Handbook*, were removed from the general *History*, and the whole of this subject treated more fully in a separate volume, *The History of Indian and Eastern Architecture*, which appeared in 1876, and, although complete in itself, formed a kind of appendix to *The History of Architecture*. Previously to this, in 1862, he issued his *History of Modern Architecture*, in which the subject was continued from the Renaissance to the present day, the period of "modern architecture" being distinguished as that of revivals and imitations of ancient styles, which began with the Renaissance. The essential difference between this and the spontaneously evolved architecture of preceding ages Fergusson was the first clearly to point out and characterize. His treatise on *The True Principles of Beauty in Art*, an early publication, is a most thoughtful metaphysical study. Some of his essays on special points in archaeology, such as the treatise on *The Mode in which Light was introduced into Greek Temples*, included theories which have not received general acceptance. His real monument is his *History of Architecture* (later edition revised by R. Phenè Spiers), which, for grasp of the whole subject, comprehensiveness of plan, and thoughtful critical analysis, stands quite alone in architectural literature. He received the gold medal of the Royal Institute of British Architects in 1871. Among his works, besides those already mentioned, are: *A Proposed New System of Fortification* (1849), *Palaces of Nineveh and Persepolis restored* (1851), *Mausoleum at Halicarnassus restored* (1862), *Tree and Serpent Worship* (1868), *Rude Stone Monuments in all Countries* (1872), and *The Temples of the Jews and the other Buildings in the Haram Area at Jerusalem* (1878). The sessional papers of the Institute of British Architects include papers by him on *The History of the Pointed Arch, Architecture of Southern India, Architectural Splendour of the City of Beejapore, On the Erechtheum* and on the *Temple of Diana at Ephesus*.

Although Fergusson never practised architecture he took a keen interest in all the professional work of his time. He was adviser with Austen Layard in the scheme of decoration for the Assyrian court at the Crystal Palace, and indeed assumed in 1856 the duties of general manager to the Palace Company, a post which he held for two years. In 1847 Fergusson had published an "Essay on the Ancient Topography of Jerusalem," in which he had contended that the "Mosque of Omar" was the identical church built by Constantine the Great over the tomb of our Lord at Jerusalem, and that it, and not the present church of the Holy Sepulchre, was the genuine burial-place of Jesus. The burden of this contention was further explained by the publication in 1860 of his *Notes on the Site of the Holy Sepulchre at Jerusalem*; and *The Temples of the Jews and the other Buildings in the Haram Area at Jerusalem*, published in 1878, was a still completer elaboration of these theories, which are said to have been the origin of the establishment of the Palestine Exploration fund. His manifold activities continued till his death, which took place in London on the 9th of January 1886.

FERGUSSON, ROBERT (1750–1774), Scottish poet, son of Sir William Fergusson, a clerk in the British Lincn Company, was born at Edinburgh on the 5th of September 1750. Robert was educated at the grammar school of Dundee, and at the university of St Andrews, where he matriculated in 1765. His father died while he was still at college; but a bursary enabled him to complete his four years of study. He refused to study for the church, and was too nervous to study medicine as his friends wished. He quarrelled with his uncle, John Forbes of Round Lichnot, Aberdeenshire, and went to Edinburgh, where he obtained employment as copying clerk in a lawyer's office. In this humble occupation he passed the remainder of his life. While at college he had written a clever elegy on Dr David Gregory, and in 1771 he began to contribute verses regularly to Ruddiman's *Weekly Magazine*. He was a member of the Cape Club, celebrated by him in his poem of "Auld Reekie." "The Knights of the Cape" assembled at a tavern in Craig's Close, in the vicinity of the Cross; each member had a name and character assigned to him, which he was required to maintain at all gatherings of the order. David Herd (1732–1810), the collector of the classic edition of *Ancient and Modern Scottish Songs* (1776), was sovereign of the Cape (in which he was known as "Sir Scrape") when Fergusson was dubbed a knight of the order, with the title of "Sir Precentor," in allusion to his fine voice. Alexander Runciman, the historical painter, his pupil Jacob More, and Sir Henry Raeburn were all members. The old minute books of the club abound with pencilled sketches by them, one of the most interesting of which, ascribed to Runciman's pencil, is a sketch of Fergusson in his character of "Sir Precentor."

Fergusson's gaiety and wit made him an entertaining companion, and he indulged too freely in the convivial habits of the time. After a meeting with John Brown of Haddington he became, however, very serious, and would read nothing but his Bible. A fall by which his head was severely injured aggravated symptoms of mental aberration which had begun to show themselves; and after about two months' confinement in the old Darien House—then the only public asylum in Edinburgh—the poet died on the 16th of October 1774.

Fergusson's poems were collected in the year before his death. The influence of his writings on Robert Burns is undoubted. His "Leith Races" unquestionably supplied the model for the "Holy Fair." Not only is the stanza the same, but the Mirth who plays the part of conductor to Fergusson, and the Fun who renders a like service to Burns, are manifestly conceived on the same model. "The Mutual Complaint of Plainstones and Causey" probably suggested "The Brigs of Ayr"; "On seeing a Butterfly in the Street" has reflections in it which strikingly correspond with "To a Mouse"; nor will a comparison of "The Farmer's Ingle" of the elder poet with "The Cottar's Saturday Night" admit of a doubt as to the influence of the city-bred poet's muse on that exquisite picturing of homely peasant life. Burns was himself the first to render a generous tribute to the merits of Fergusson; on his visit to Edinburgh in 1787 he sought out the poet's grave, and petitioned the authorities of the Canongate burying-ground for permission to erect the memorial stone which is preserved in the existing monument. The date there assigned for his birth differs from the one given above, which rests on the authority of his younger sister Margaret.

The first edition of Fergusson's poems was published by Ruddiman at Edinburgh in 1773, and a supplement containing additional poems, in 1779. A second edition appeared in 1785. There are later editions, by Robert Chambers (1850) and Dr A. B. Grosart (1851). A life of Fergusson is included in Dr David Irving's *Lives of the Scottish Poets*, and in Robert Chambers's *Lives of Illustrious and Distinguished Scotsmen*.

FERGUSSON, SIR WILLIAM, Bart. (1808–1877), British surgeon, the son of James Fergusson of Lochmaben, Dumfriesshire, was born at Prestonpans, East Lothian, on the 20th of March 1808. After receiving his early education at Lochmaben and the high school of Edinburgh, he entered the university of Edinburgh with the view of studying law, but soon afterwards abandoned his intention and became a pupil of the anatomist Robert Knox (1791–1862), whose demonstrator he was

appointed at the age of twenty. In 1836 he succeeded Robert Liston as surgeon to the Edinburgh Royal Infirmary, and coming to London in 1840 as professor of surgery in King's College, and surgeon to King's College Hospital, he acquired a commanding position among the surgeons of the metropolis. He revived the operation for cleft-palate, which for many years had fallen into disrepute, and invented a special mouth-gag for the same. He also devised many other surgical instruments, chief among which, and still in use to-day, are his bone forceps, lion forceps and vaginal speculum. In 1866 he was created a baronet. He died in London on the 10th of February 1877. As a surgeon Fergusson's greatest merit is that of having introduced the practice of "conservative surgery," by which he meant the excision of a joint rather than the amputation of a limb. He made his diagnosis with almost intuitive certainty; as an operator he was characterized by self-possession in the most critical circumstances, by minute attention to details and by great refinement of touch, and he relied more on his mechanical dexterity than on complicated instruments. He was the author of *The Progress of Anatomy and Surgery in the Nineteenth Century* (1867), and of a *System of Practical Surgery* (1842), which went through several editions.

FERINGHI, or **FERINGHEE**, a Frank (Persian, *Farangi*). This term for a European is very old in Asia, and was originally used in a purely geographical sense, but now generally carries a hostile or contemptuous significance. The combatants on either side during the Indian Mutiny called each other Feringhies and Pandies.

FERISHTA, MAHOMMED KASIM (c. 1570-c. 1611), Persian historian, was born at Astrabad, on the shores of the Caspian Sea. While he was still a child his father was summoned away from his native country into Hindostan, where he held high office in the Deccan; and by his influence the young Ferishta received court promotion. In 1589 Ferishta removed to Bijapur, where he spent the remainder of his life under the immediate protection of the shah Ibrahim Adil II., who engaged him to write a history of India. At the court of this monarch he died about 1611. In the introduction to his work a *résumé* is given of the history of Hindostan prior to the times of the Mahomedan conquest, and also of the victorious progress of the Arabs through the East. The first ten books are each occupied with a history of the kings of one of the provinces; the eleventh book gives an account of the Mussulmans of Malabar; the twelfth a history of the Mussulman saints of India; and the conclusion treats of the geography and climate of India. Ferishta is reputed one of the most trustworthy of the Oriental historians, and his work still maintains a high place as an authority. Several portions of it have been translated into English; but the best as well as the most complete translation is that published by General J. Briggs under the title of *The History of the Rise of the Mahometan Power in India* (London, 1829, 4 vols. 8vo). Several additions were made by Briggs to the original work of Ferishta, but he omitted the whole of the twelfth book, and various other passages which had been omitted in the copy from which he translated.

FERMANAGH, a county of Ireland, in the province of Ulster, bounded N.W. by Donegal, N.E. by Tyrone, E. by Monaghan and S.W. by Cavan and Leitrim. The area is 457,369 acres or about 715 sq. m. The county is situated mostly in the basin of the Erne, which divides the county into two nearly equal sections. Its surface is hilly, and its appearance (in many parts) somewhat sterile, though in the main, and especially in the neighbourhood of Lough Erne, it is picturesque and attractive. The climate, though moist, is healthy, and the people are generally tall and robust. The chief mountains are Cuilcagh (2188 ft.), partly in Leitrim and Cavan, Belmore (1312), Glenkeel (1223), North Shean (1135), Tappahan (1110), Carnmore (1034). Tossett or Toppid and Turaw mountains command extensive prospects, and form striking features in the scenery of the county. But the most distinguishing features of Fermanagh are the Upper and Lower Loughs Erne, which occupy a great extent of its surface, stretching for about 45 m. from S.E. to N.W. These lakes are expansions of the river Erne, which enters the county

from Cavan at Wattle Bridge. It passes Belturbet, the Loughs Erne, Enniskillen and Belleek, on its way to the Atlantic, into which it descends at Ballyshannon. At Belleek it forms a considerable waterfall and is here well known to sportsmen for its good salmon fishing. Trout are taken in most of the loughs, and pike of great size in the Loughs Erne. There are several mineral springs in the county, some of them chalybeate, others sulphurous. At Belcoo, near Enniskillen, there is a famous well called Daragh Phadric, held in repute by the peasantry for its cure of paralytic and other diseases; and 4 m. N.W. of the same town, at a place called "the Daughton," are natural caves of considerable size.

This county includes in the north an area of the gneiss that is discussed under county Donegal, and, west of Omagh, a metamorphic region that stretches in from the central axis of Tyrone. A fault divides the latter from the mass of red-brown Old Red Sandstone that spreads south nearly to Enniskillen. Lower Carboniferous sandstone and limestone occur on the north of Lower Lough Erne. The limestone forms fine scarps on the southern side of the lake, capped by beds regarded as the Yoredale series. The scenery about the two Loughs Macnean is carved out in similarly scarped hills, rising to 2188 ft. in Cuilcagh on the south. The "Marble Arch" cave near Florencecourt, with its emerging river, is a characteristic example of the subterranean waterways in the limestone. Upper Lough Erne is a typical meandering lake of the limestone lowland, with outliers of higher Carboniferous strata forming highlands north-east and south-west of it.

With the exception of the pottery works at Belleek, where iridescent ware of good quality is produced, Fermanagh has no distinguishing manufactures. It is chiefly an agricultural county. The proportion of tillage to pasture is roughly as 1 to 2½. Cattle and poultry are the principal classes of live stock. Oats and potatoes are the crops most extensively cultivated. The north-western division of the Great Northern railway passes through the most populous portion of the county, one branch connecting Enniskillen with Clones, another connecting Enniskillen with Londonderry via Omagh, and a third connecting Bundoran Junction with Bundoran, in county Donegal. The Sligo, Leitrim & Northern Counties railway connects with the Great Northern at Enniskillen, and the Clogher Valley light railway connects southern county Tyrone with the Great Northern at Maguiresbridge.

The population (74,170 in 1891; 65,430 in 1901; almost wholly rural) shows a decrease among the most serious of the county populations of Ireland. It includes 55% of Roman Catholics and about 35% of Protestant Episcopalians. Enniskillen (the county town, pop. 5412) is the only town of importance, the rest being little more than villages. The principal are Lisnaskea, Irvinestown (formerly Lowtherstown), Maguiresbridge, Tempo, Newtownbutler, Belleek, Derrygonnelly and Kesh, at which fairs are held. Garrison, a fishing station on the wild Lough Melvin, and Pettigo, near to the lower Lough Erne, are market villages. Fermanagh returns two members to parliament, one each for the north and south divisions. It comprises eight baronies and nineteen civil parishes. The assizes are held at Enniskillen, quarter sessions at Enniskillen and Newtownbutler. The headquarters of the constabulary are at Enniskillen. Ecclesiastically it belongs to the Protestant and Roman Catholic dioceses of Clogher and Kilmore.

By the ancient Irish the district was called *Feor-magh-Eanagh*, or the "country of the lakes" (lit. "the mountain-valley marsh district"); and also *Magh-uire*, or "the country of the waters." A large portion was occupied by the *Guarii*, the ancestors of the MacGuires or Maguires, a name still common in the district. This family was so influential that for centuries the county was called after it Maguire's Country, and one of the towns still existing bears its name, Maguiresbridge. Fermanagh was formed into a county on the shiring of Ulster in 1585 by Sir John Perrot, and was included in the well-known scheme of colonization of James I., the Plantation of Ulster. In 1689 battles were fought between William III.'s army and the Irish

under Macarthy (for James II.), Lisnaskea (26th July) and Newtownbutler (30th July). The chief place of interest to the antiquary is Devenish Island in Lough Erne, about 2½ m. N.W. from Enniskillen (*q.v.*), with its ruined abbey, round tower and cross. In various places throughout the county may be seen the ruins of several ancient castles, Danish raths or encampments, and tumuli, in the last of which urns and stone coffins have sometimes been found. The round tower on Devenish Island is one of the finest examples in the country.

FERMAT, PIERRE DE (1601–1665), French mathematician, was born on the 17th of August 1601, at Beaumont-de-Lomagne near Montauban. While still young, he, along with Blaise Pascal, made some discoveries in regard to the properties of numbers, on which he afterwards built his method of calculating probabilities. He discovered a simpler method of quadrating parabolas than that of Archimedes, and a method of finding the greatest and the smallest ordinates of curved lines analogous to that of the then unknown differential calculus. His great work *De maximis et minimis* brought him into conflict with René Descartes, but the dispute was chiefly due to a want of explicitness in the statement of Fermat (see INFINITESIMAL CALCULUS). His brilliant researches in the theory of numbers entitle him to rank as the founder of the modern theory. They originally took the form of marginal notes in a copy of Bachet's *Diophantus*, and were published in 1670 by his son Samuel, who incorporated them in a new edition of this Greek writer. Other theorems were published in his *Opera Varia*, and in John Wallis's *Commercium epistolicum* (1658). He died in the belief that he had found a relation which every prime number must satisfy, namely $2^n + 1 = a$ prime. This was afterwards disproved by Leonhard Euler for the case when $n = 5$. *Fermat's Theorem*, if p is prime and a is prime to p then $a^{p-1} - 1$ is divisible by p , was first given in a letter of 1640. *Fermat's Problem* is that $x^n + y^n = z^n$ is impossible for integral values of x, y and z when n is greater than 2.

Fermat was for some time councillor for the parliament of Toulouse, and in the discharge of the duties of that office he was distinguished both for legal knowledge and for strict integrity of conduct. Though the sciences were the principal objects of his private studies, he was also an accomplished general scholar and an excellent linguist. He died at Toulouse on the 12th of January 1665. He left a son, Samuel de Fermat (1630–1690) who published translations of several Greek authors and wrote certain books on law in addition to editing his father's works.

The *Opera mathematica* of Fermat were published at Toulouse, in 2 vols. folio, 1670 and 1679. The first contains the "Arithmetic of Diophantus," with notes and additions. The second includes a "Method for the Quadrature of Parabolas," and a treatise "on Maxima and Minima, on Tangents, and on Centres of Gravity," containing the same solutions of a variety of problems as were afterwards incorporated into the more extensive method of fluxions by Newton and Leibnitz. In the same volume are treatises on "Geometric Loci, or Spherical Tangencies," and on the "Rectification of Curves," besides a restoration of "Apollonius's Plane Loci," together with the author's correspondence addressed to Descartes, Pascal, Roberval, Huygens and others. The *Œuvres* of Fermat have been re-edited by P. Tannery and C. Henry (Paris, 1891–1894).

See Paul Tannery, "Sur la date des principales découvertes de Fermat," in the *Bulletin Darboux* (1883); and "Les Manuscrits de Fermat," in the *Annales de la faculté des lettres de Bordeaux*.

FERMENTATION. The process of fermentation in the preparation of wine, vinegar, beer and bread was known and practised in prehistoric times. The alchemists used the terms fermentation, digestion and putrefaction indiscriminately; any reaction in which chemical energy was displayed in some form or other—such, for instance, as the effervescence occasioned by the addition of an acid to an alkaline solution—was described as a fermentation (*Lat. fervere*, to boil); and the idea of the "Philosopher's Stone" setting up a fermentation in the common metals and developing the essence or germ, which should transmute them into silver or gold, further complicated the conception of fermentation. As an outcome of this alchemical doctrine the process of fermentation was supposed to have a purifying and elevating effect on the bodies which had been submitted to its influence. Basil Valentine wrote that when yeast was added to wort "an internal inflammation is communicated to the liquid,

so that it raises in itself, and thus the segregation and separation of the feculent from the clear takes place." Johann Becher, in 1669, first found that alcohol was formed during the fermentation of solutions of sugar; he distinguished also between fermentation and putrefaction. In 1697 Georg Stahl admitted that fermentation and putrefaction were analogous processes, but that the former was a particular case of the latter.

The beginning of definite knowledge on the phenomenon of fermentation may be dated from the time of Antony Leeuwenhoek, who in 1680 designed a microscope sufficiently powerful to render yeast cells and bacteria visible; and a description of these organisms, accompanied by diagrams, was sent to the Royal Society of London. This investigator just missed a great discovery, for he did not consider the spherical forms to be living organisms but compared them with starch granules. It was not until 1803 that L. J. Thénard stated that yeast was the cause of fermentation, and held it to be of an animal nature, since it contained nitrogen and yielded ammonia on distillation, nor was it conclusively proved that the yeast cell was the originator of fermentation until the researches of C. Cagniard de la Tour, T. Schwann and F. Kützing from 1836 to 1839 settled the point. These investigators regarded yeast as a plant, and Meyer gave to the germs the systematic name of "Saccbaromyces" (sugar fungus). In 1839–1840 J. von Liebig attacked the doctrine that fermentation was caused by micro-organisms, and enunciated his theory of mechanical decomposition. He held that every fermentation consisted of molecular motion which is transmitted from a substance in a state of chemical motion—that is, of decomposition—to other substances, the elements of which are loosely held together. It is clear from Liebig's publications that he first regarded yeast as a lifeless, albuminoid mass; but, although later he considered they were living cells, he would never admit that fermentation was a physiological process, the chemical aspect being paramount in the mind of this distinguished investigator.

In 1857 Pasteur decisively proved that fermentation was a physiological process, for he showed that the yeast which produced fermentation was no dead mass, as assumed by Liebig, but consisted of living organisms capable of growth and multiplication. His own words are: "The chemical action of fermentation is essentially a correlative phenomenon of a vital act, beginning and ending with it. I think that there is never any alcoholic fermentation without there being at the same time organization, development and multiplication of globules, or the continued consecutive life of globules already formed." Fermentation, according to Pasteur, was caused by the growth and multiplication of unicellular organisms out of contact with free oxygen, under which circumstance they acquire the power of taking oxygen from chemical compounds in the medium in which they are growing. In other words "fermentation is life without air, or life without oxygen." This theory of fermentation was materially modified in 1892 and 1894 by A. J. Brown, who described experiments which were in disagreement with Pasteur's dictum. A. J. Brown writes: "If for the theory 'life without air' is substituted the consideration that yeast cells can use oxygen in the manner of ordinary aerobic fungi, and probably do require it for the full completion of their life-history, but that the exhibition of their fermentative functions is independent of their environment with regard to free oxygen, it will be found that there is nothing contradictory in Pasteur's experiments to such a hypothesis."

Liebig and Pasteur were in agreement on the point that fermentation is intimately connected with the presence of yeast in the fermenting liquid, but their explanations concerning the mechanism of fermentation were quite opposed. According to M. Traube (1858), the active cause of fermentation is due to the action of different enzymes contained in yeast and not to the yeast cell itself. As will be seen later this theory was confirmed by subsequent researches of E. Fischer and E. Buchner.

In 1879 C. Nägeli formulated his well-known molecular-physical theory, which supported Liebig's chemical theory on the one hand and Pasteur's physiological hypothesis on the

other: "Fermentation is the transference of the condition of motion of the molecules, atomic groups and atoms of the various compounds constituting the living plasma, to the fermenting material, in consequence of which equilibrium in the molecules of the latter is destroyed, the result being their disintegration." He agreed with Pasteur that the presence of living cells is essential to the transformation of sugar into alcohol, but dissented from the view that the process occurs within the cell. This investigator held that the decomposition of the sugar molecules takes place outside the cell wall. In 1894 and 1895, Fischer, in a remarkable series of papers on the influence of molecular structure upon the action of the enzyme, showed that various species of yeast behave very differently towards solutions of sugars. For example, some species hydrolyse cane sugar and maltose, and then carry on fermentation at the expense of the simple sugars (hexoses) so formed. *Saccharomyces Marxianus* will not hydrolyse maltose, but it does attack cane sugar and ferment the products of hydrolysis. Fischer next suggested that enzymes can only hydrolyse those sugars which possess a molecular structure in harmony with their own, or to use his ingenious analogy, "the one may be said to fit into the other as a key fits into a lock." The preference exhibited by yeast cells for sugar molecules is shared by mould fungi and soluble enzymes in their fermentative actions. Thus, Pasteur showed that *Penicillium glaucum*, when grown in an aqueous solution of ammonium racemate, decomposed the dextro-tartrate, leaving the laevotartarate, and the solution which was originally inactive to polarized light became dextro-rotatory. Fischer found that the enzyme "invertase," which is present in yeast, attacks methyl-*d*-glucoside but not methyl-*l*-glucoside.

In 1897 Buchner submitted yeast to great pressure, and isolated a nitrogenous substance, enzymic in character, which he termed "zymase." This body is being continually formed in the yeast cell, and decomposes the sugar which has diffused into the cell. The freshly-expressed yeast juice causes concentrated solutions of cane sugar, glucose, laevulose and maltose to ferment with the production of alcohol and carbon dioxide, but not milk-sugar and mannose. In this respect the plasma behaves in a similar manner towards the sugars as does the living yeast cell. Pasteur found that, when cane sugar was fermented by yeast, 49.4% of carbonic acid and 51.1% of alcohol were produced; with expressed yeast juice cane sugar yields 47% of carbonic acid and 47.7% of alcohol. According to Buchner the fermentative activity of yeast-cell juice is not due to the presence of living yeast cells, or to the action of living yeast protoplasm, but it is caused by a soluble enzyme. A. Macfadyen, G. H. Morris and S. Rowland, in repeating Buchner's experiments, found that zymase possessed properties differing from all other enzymes, thus: dilution with twice its volume of water practically destroys the fermentative power of the yeast juice. These investigators considered that differences of this nature cannot be explained by the theory that it is a soluble enzyme, which brings about the alcoholic fermentation of sugar. The remarkable discoveries of Fischer and Buchner to a great extent confirm Traube's views, and reconcile Liebig's and Pasteur's theories. Although the action of zymase may be regarded as mechanical, the enzyme cannot be produced by any other than living protoplasm.

Pasteur's important researches mark an epoch in the technical aspect of fermentation. His investigations on vinegar-making revolutionized that industry, and he showed how, instead of waiting two or three months for the elaboration of the process, the vinegar could be made in eight or ten days by exposing the vats containing the mixture of wine and vinegar to a temperature of 20° to 25° C., and sowing with a small quantity of the acetic organism. To the study of the life-history of the butyric and acetic organisms we owe the terms "anaërobic" and "aërobic." His researches from 1860 and onwards on the then vexed question of spontaneous generation proved that, in all cases where spontaneous generation appeared to have taken place, some defect or other was in the experiment. Although the direct object of Pasteur was to prove a negative,

yet it was on these experiments that sterilization as known to us was developed. It is only necessary to bear in mind the great part played by sterilization in the laboratory, and pasteurization on the fermentation industries and in the preservation of food materials. Pasteur first formulated the idea that bacteria are responsible for the diseases of fermented liquids; the corollary of this was a demand for pure yeast. He recommended that yeast should be purified by cultivating it in a solution of sugar containing tartaric acid, or, in wort containing a small quantity of phenol. It was not recognized that many of the diseases of fermented liquids are occasioned by foreign yeasts; moreover, this process, as was shown later by Hansen, favours the development of foreign yeasts at the expense of the good yeast.

About this time Hansen, who had long been engaged in researches on the biology of the fungi of fermentation, demonstrated that yeast free from bacteria could nevertheless occasion diseases in beer. This discovery was of great importance to the zymo-technical industries, for it showed that bacteria are not the only undesirable organisms which may occur in yeast. Hansen set himself the task of studying the properties of the varieties of yeast, and to do this he had to cultivate each variety in a pure state. Having found that some of the commonest diseases of beer, such as yeast turbidity and the objectionable changes in flavour, were caused not by bacteria but by certain species of yeast, and, further, that different species of good brewery yeast would produce beers of different character, Hansen argued that the pitching yeast should consist only of a single species—namely, that best suited to the brewery in question. These views met with considerable opposition, but in 1890 Professor E. Duclaux stated that the yeast question as regards low fermentation has been solved by Hansen's investigations. He emphasized the opinion that yeast derived from one cell was of no good for top fermentation, and advocated Pasteur's method of purification. But in the course of time, notwithstanding many criticisms and objections, the reform spread from bottom fermentation to top fermentation breweries on the continent and in America. In the United Kingdom the employment of brewery yeasts selected from a single cell has not come into general use; it may probably be accounted for in a great measure by conservatism and the wrong application of Hansen's theories.

Pure Cultivation of Yeasts.—The methods which were first adopted by Hansen for obtaining pure cultures of yeast were similar in principle to one devised by J. Lister for isolating a pure culture of lactic acid bacterium. Lister determined the number of bacteria present in a drop of the liquid under examination by counting, and then diluted this with a sufficient quantity of sterilized water so that each drop of the mixture should contain, on an average, less than one bacterium. A number of flasks containing a nutrient medium were each inoculated with one drop of this mixture; it was found that some remained sterile, and Lister assumed that the remaining flasks each contained a pure culture. This method did not give very certain results, for it could not be guaranteed that the growth in the inoculated flask was necessarily derived from a single bacterium. Hansen counted the number of yeast cells suspended in a drop of liquid diluted with sterilized water. A volume of the diluted yeast was introduced into flasks containing sterilized wort, the degree of dilution being such that only a small proportion of the flasks became infected. The flasks were then well shaken, and the yeast cell or cells settled to the bottom, and gave rise to a separate yeast speck. Only those cultures which contained a single yeast speck were assumed to be pure cultivations. By this method several races of *Saccharomyces* and brewery yeasts were isolated and described.

The next important advance was the substitution of solid for liquid media; due originally to Schroter. R. Koch subsequently improved the method. He introduced bacteria into liquid sterile nutrient gelatin. After being well shaken, the liquid was poured into a sterile glass Petrie dish and covered with a moist and sterile bell-jar. It was assumed that each separate speck contained a pure culture. Hansen pointed out that this

was by no means the case, for it is more difficult to separate the cells from each other in the gelatin than in the liquid. To obtain an absolutely pure culture with certainty it is necessary, even when the gelatin method is employed, to start from a single cell. To effect this some of the nutrient gelatin containing yeast cells is placed on the under-surface of the cover-glass of the moist chamber. Those cells are accurately marked, the position of which is such that the colonies, to which they give rise, can grow to their full size without coming into contact with other colonies. The growth of the marked cells is kept under observation for three or four days, by which time the colonies will be large enough to be taken out of the chamber and placed in flasks. The contents of the flasks can then be introduced into larger flasks, and finally into an apparatus suitable for making enough yeast for technical purposes. Such, in brief, are the methods devised by that brilliant investigator Hansen; and these methods have not only been the basis on which our modern knowledge of the *Saccharomyces* is founded, but are the only means of attack which the present-day observer has at his disposal.

From the foregoing it will be seen that the term fermentation has now a much wider significance than when it was applied to such changes as the decomposition of must or wort with the production of carbon dioxide and alcohol. Fermentation now includes all changes in organic compounds brought about by ferments elaborated in the living animal or vegetable cell. There are two distinct types of fermentation: (1) those brought about by living organisms (organized ferments), and (2) those brought about by non-living or unorganized ferments (enzymes). The first class include such changes as the alcoholic fermentation of sugar solutions, the acetic acid fermentation of alcohol, the lactic acid fermentation of milk sugar, and the putrefaction of animal and vegetable nitrogenous matter. The second class include all changes brought about by the agency of enzymes, such as the action of diastase on starch, invertase on cane sugar, glucase on maltose, &c. The actions are essentially hydrolytic.

Biological Aspect of Yeast.—The *Saccharomyces* belong to that division of the Thallophyta called the Hyphomycetes or Fungi (*q.v.*). Two great divisions are recognized in the Fungi: (i) the *Phycomycetes* or Algal Fungi, which retain a definitely sexual method of reproduction as well as asexual (vegetative) methods, and (ii) the *Mycomycetes*, characterized by extremely reduced or very doubtful sexual reproduction. The *Mycomycetes* may be divided as follows: (A) forms bearing both sporangia and conidia (see FUNGI), (B) forms bearing conidia only, e.g. the common mushroom. Division A comprises (a) the true *Ascomycetes*, of which the moulds *Eurotium* and *Penicillium* are examples, and (b) the *Hemiasci*, which includes the yeasts. The gradual disappearance of the sexual method of reproduction, as we pass upwards in the fungi from the points of their departure from the Algae, is an important fact, the last traces of sexuality apparently disappearing in the *ascomycetes*.

With certain rare exceptions the *Saccharomyces* have three methods of asexual reproduction:—

1. The most common.—The formation of *buds* which separate to form new cells. A portion of the nucleus of the parent cell makes its way through the extremely narrow neck into the daughter cell. This method obtains when yeast is vigorously fermenting a saccharine solution.

2. A division by *fission* followed by Endogenous spore formation, characteristic of the *Schizosaccharomyces*. Some species show fermentative power.

3. *Endospore* formation, the conditions for which are as follows: (1) suitable temperature, (2) presence of air, (3) presence of moisture, (4) young and vigorous cells, (5) a food supply in the case of one species at least is necessary, and is in no case prejudicial. In some cases a sexual act would appear to precede spore formation. In most cases four spores are formed within the cell by free formation. These may readily be seen after appropriate staining.

In some of the true *Ascomycetes*, such as *Penicillium glaucum*, the conidia if grown in saccharine solutions, which they have

the power of fermenting, develop single cell yeast-like forms, and do not—at any rate for a time—produce again the characteristic branching mycelium. This is known as the *Torula* condition. It is supposed by some that *Saccharomyces* is a very degraded *Ascomycete*, in which the *Torula* condition has become fixed.

The yeast plant and its allies are saprophytes and form no chlorophyll. Their extreme reduction in form and loss of sexuality may be correlated with the saprophytic habit, the protoids and other organic material required for the growth and reproduction being appropriated ready synthesized, the plant having entirely lost the power of forming them for itself, as evidenced by the absence of chlorophyll. The beer yeast *S. cerevisiae*, is never found wild, but the wine yeasts occur abundantly in the soil of vineyards, and so are always present on the fruit, ready to ferment the expressed juice.

Chemical Aspect of Alcoholic Fermentation.—Lavoisier was the first investigator to study fermentation from a quantitative standpoint. He determined the percentages of carbon, hydrogen and oxygen in the sugar and in the products of fermentation, and concluded that sugar in fermenting breaks up into alcohol, carbonic acid and acetic acid. The elementary composition of sugar and alcohol was fixed in 1815 by analyses made by Gay-Lussac, Thénard and de Saussure. The first-mentioned chemist proposed the following formula to represent the change which takes place when sugar is fermented:—

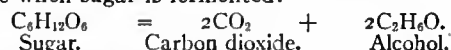

This formula substantially holds good to the present day, although a number of definite bodies other than carbon dioxide and alcohol occur in small and varying quantities, according to the conditions of the fermentation and the medium fermented. Prominent among these are glycerin and succinic acid. In this connexion Pasteur showed that 100 parts of cane sugar on inversion gave 105.4 parts of invert sugar, which, when fermented, yielded 51.1 parts alcohol, 49.4 carbonic acid, 0.7 succinic acid, 3.2 glycerin and 1.0 unestimated. A. Béchamp and E. Duclaux found that acetic acid is formed in small quantities during fermentation; aldehyde has also been detected. The higher alcohols such as propyl, isobutyl, amyl, capryl, oenanthyl and caproyl, have been identified; and the amount of these vary according to the different conditions of the fermentation. A number of esters are also produced. The characteristic flavour and odour of wines and spirits is dependent on the proportion of higher alcohols, aldehydes and esters which may be produced.

Certain yeasts exercise a reducing action, forming sulphuretted hydrogen, when sulphur is present. The “stinking fermentations” occasionally experienced in breweries probably arise from this, the free sulphur being derived from the hops. Other yeasts are stated to form sulphurous acid in must and wort. Another fact of considerable technical importance is, that the various races of yeast show considerable differences in the amount and proportion of fermentation products other than ethyl alcohol and carbonic acid which they produce. From these remarks it will be clear that to employ the most suitable kind of yeast for a given alcoholic fermentation is of fundamental importance in certain industries. It is beyond the scope of the present article to attempt to describe the different forms of budding fungi (*Saccharomyces*), mould fungi and bacteria which are capable of fermenting sugar solutions. Thus, six species isolated by Hansen, *Saccharomyces cerevisiae*, *S. Pasteurianus* I.,¹ II., III., and *S. ellipsoideus*, contained invertase and maltase, and can invert and subsequently ferment cane sugar and maltose. *S. exiguus* and *S. Ludwigi* contain only invertase and not maltase, and therefore ferment cane sugar but not maltose. *S. apiculatus* (a common wine yeast) contains neither of these enzymes, and only ferments solutions of glucose or laevulose.

Previously to Hansen's work the only way of differentiating

¹ Hansen found there were three species of spore-bearing *Saccharomyces* and that these could be subdivided into varieties. Thus, *S. cerevisiae* I., *S. cerevisiae* II., *S. Pasteurianus* I., &c.

yeasts was by studying morphological differences with the aid of the microscope. Max Reess distinguished the species according to the appearance of the cells thus, the ellipsoidal cells were designated *Saccharomyces ellipsoideus*, the sausage-shaped *Saccharomyces Pasteurianus*, and so on. It was found by Hansen that the same species of yeast can assume different shapes; and it therefore became necessary to determine how the different varieties of yeast could be distinguished with certainty. The formation of spores in yeast (first discovered by T. Schwann in 1839) was studied by Hansen, who found that each species only developed spores between certain definite temperatures. The time taken for spore formation varies greatly; thus, at 52° F., *S. cerevisiae* takes 10, *S. Pasteurianus* I. and II. about 4, *S. Pasteurianus* III. about 7, and *S. ellipsoideus* about 4½ days. The formation of spores is used as an analytical method for determining whether a yeast is contaminated with another species,—for example: a sample of yeast is placed on a gypsum or porcelain block saturated with water; if in ten days at a temperature of 52° F. no spores make their appearance, the yeast in question may be regarded as *S. cerevisiae*, and not associated with *S. Pasteurianus* or *S. ellipsoideus*.

The formation of films on fermented liquids is a well-known phenomenon and common to all micro-organisms. A free still surface with a direct access of air are the necessary conditions. Hansen showed that the microscopic appearance of film cells of the same species of *Saccharomycetes* varies according to the temperature of growth; the limiting temperatures of film formation, as well as the time of its appearance for the different species, also vary.

In the zymo-technical industries the various species of yeast exhibit different actions during fermentations. A well-known instance of this is the "top" and "bottom" brewery fermentations (see BREWING). In a top fermentation—typical of English breweries—the yeast rises, in a bottom fermentation, as the phrase implies, it settles in the vessel. Sometimes a bottom yeast may for a time exhibit signs of a top fermentation. It has not, however, been possible to transform a typical top yeast into a permanent typical bottom yeast. There appear to be no true distinctive characteristics for these two types. Their selection for a particular purpose depends upon some special quality which they possess; thus for brewing certain essentials are demanded as regards stability, clarification, taste and smell; whereas, in distilleries, the production of alcohol and a high multiplying power in the yeast are required. Culture yeasts have also been successfully employed in the manufacture of wine and cider. By the judicious selection of a type of yeast it is possible to improve the bouquet, and from an inferior must obtain a better wine or cider than would otherwise be produced.

Certain acid fermentations are of common occurrence. The *Bacterium acidi lacti* described by Pasteur decomposes milk sugar into lactic acid. *Bacillus amylobacter* usually accompanies the lactic acid organism, and decomposes lactic and other higher acids with formation of butyric acid. Moulds have been isolated which occasion the formation of citric acid from glucose. The production of acetic acid from alcohol has received much attention at the hands of investigators, and it has an important technical aspect in the manufacture of vinegar. The phenomenon of nitrification (see BACTERIOLOGY, AGRICULTURE and MANURE), i.e. the formation of nitrites and nitrates from ammonia and its compounds in the soil, was formerly held to be a purely chemical process, until Schloesing and Müntz suggested in 1877 that it was biological. It is now known that the action takes place in two stages; the ammonium salt is first oxidized to the nitrite stage and subsequently to the nitrate. (J. L. B.)

FERMO (anc. *Firmum Picenum*), a town and archiepiscopal see of the Marches, Italy, in the province of Ascoli Piceno, on a hill with a fine view, 1046 ft. above sea-level, on a branch from Porto S. Giorgio on the Adriatic coast railway. Pop. (1901) town, 16,577, commune 20,542. The summit of the hill was occupied by the citadel until 1446. It is crowned by the cathedral, reconstructed in 1227 by Giorgio da Como; the fine facade and campanile of this period still remain, and the side

portal is good; the beautiful rose-window over the main door dates from 1348. In the porch are several good tombs, including one of 1366 by Tura da Imola, and also the modern monument of Giuseppe Colucci, a famous writer on the antiquities of Picenum. The interior has been modernized. The building is now surrounded by a garden, with a splendid view. Against the side of the hill was built the Roman theatre; scanty traces of an amphitheatre also exist. Remains of the city wall, of rectangular blocks of hard limestone, may be seen just outside the Porta S. Francesco; whether the walling under the Casa Porti belongs to them is doubtful. The medieval battlemented walls superposed on it are picturesque. The church of S. Francesco has a good tower and choir in brickwork of 1240, the rest having been restored in the 17th century. Under the Dominican monastery is a very large Roman reservoir in two storeys, belonging to the imperial period, divided into many chambers, at least 24 on each level, each 30 by 20 ft., for filtration (see G. de Minicis in *Annali dell' Istituto*, 1846, p. 46; 1858, p. 125). The piazza contains the Palazzo Comunale, restored in 1446, with a statue of Pope Sixtus V. in front of it. The Biblioteca Comunale contains a collection of inscriptions and antiquities. Porto S. Giorgio has a fine castle of 1269, blocking the valley which leads to Fermo.

The ancient Firmum Picenum was founded as a Latin colony in 264 B.C., after the conquest of the Picentes, as the local headquarters of the Roman power, to which it remained faithful. It was originally governed by five quaestors. It was made a colony with full rights after the battle of Philippi, the 4th legion being settled there. It lay at the junction of roads to Pausulae, Urbs Salvia and Asculum, being connected with the coast road by a short branch road from Castellum Firmanum (Porto S. Giorgio). In the 10th century it became the capital of the *Marchia Firmana*. In 1199 it became a free city, and remained independent until 1550, when it became subject to the papacy. (T. As.)

FERMOY, a market town in the east riding of Co. Cork, Ireland, in the north-east parliamentary division, 21 m. by road N.E. of Cork, and 14 m. E. of Mallow by a branch of the Great Southern & Western railway. Pop. of urban district (1901) 6126. It is situated on the river Blackwater, which divides the town into two parts, the larger of which is on the southern bank, and there the trade of the town, which is chiefly in flour and agricultural produce, is mainly carried on. The town has several good streets and some noteworthy buildings. Of the latter, the most prominent are the military barracks on the north bank of the river, the Protestant church, the Roman Catholic cathedral and St Colman's Roman Catholic college. Fermoy rose to importance only at the beginning of the 19th century, owing entirely to the devotion of John Anderson, a citizen, on becoming landlord. The town is a centre for salmon and trout fishing on the Blackwater and its tributary the Funshion. The neighbouring scenery is attractive, especially in the Glen of Araglin, once famed for its ironworks.

FERN (from O. Eng. *fearn*, a word common to Teutonic languages, cf. Dutch *varen*, and Ger. *Farn*; the Indo-European root, seen in the Sanskrit *parna*, a feather, shows the primary meaning; cf. Gr. *πτερόν*, feather, *πτερίς*, fern), a name often used to denote the whole botanical class of Pteridophytes, including both the true ferns, Filicales, by far the largest group of this class in the existing flora, and the fern-like plants, Equisetales, Sphenophyllales, Lycopodiales (see PTERIDOPHYTES).

FERNANDEZ, ALVARO, one of the leading Portuguese explorers of the earlier 15th century, the age of Henry the Navigator. He was brought up (as a page or esquire) in the household of Prince Henry, and while still "young and audacious" took an important part in the discovery of "Guinea." He was a nephew of João Gonçalves Zarco, who had rediscovered the Madeira group in Henry's service (1418-1420), and had become part-governor of Madeira and commander of Funchal; when the great expedition of 1445 sailed for West Africa he was entrusted by his uncle with a specially fine caravel, under particular injunctions to devote himself to discovery, the most cherished object of his princely master, so constantly thwarted.

Fernandez, as a pioneer, outstripped all other servants of the prince at this time. After visiting the mouth of the Senegal, rounding Cape Verde, and landing in Goree (?), he pushed on to the "Cape of Masts" (Cabo dos Matos, or Mastos, so called from its tall spindle-palms), probably between Cape Verde and the Gambia, the most southerly point till then attained. Next year (1446) he returned, and coasted on much farther, to a bay one hundred and ten leagues "south" (i.e. S.S.E.) of Cape Verde, perhaps in the neighbourhood of Konakry and the Los Islands, and but little short of Sierra Leone. This record was not broken till 1461, when Sierra Leone was sighted and named. A wound, received from a poisoned arrow in an encounter with natives, now compelled Fernandez to return to Portugal, where he was received with distinguished honour and reward by Prince Henry and the regent of the kingdom, Henry's brother Pedro.

See Gomes Eannes de Azurara, *Chronica de . . . Guiné*, chs. lxxv., lxxvii.; João de Barros, *Asia*, Decade I., bk. i. chs. xiii., xiv.

FERNANDEZ, DIEGO, a Spanish adventurer and historian of the 16th century. Born at Palencia, he was educated for the church, but about 1545 he embarked for Peru, where he served in the royal army under Alonzo de Alvarado. Andres Hurtado de Mendoza, marquess of Cañeté, who became viceroy of Peru in 1655, bestowed on Fernandez the office of chronicler of Peru; and in this capacity he wrote a narrative of the insurrection of Francisco Hernandez Giron, of the rebellion of Gonzalo Pizarro, and of the administration of Pedro de la Gasca. The whole work, under the title *Primera y segunda parte de la Historia del Piru*, was published at Seville in 1571 and was dedicated to King Philip II. It is written in a clear and intelligible style, and with more art than is usual in the compositions of the time. It gives copious details, and, as he had access to the correspondence and official documents of the Spanish leaders, it is, although necessarily possessing bias, the fullest and most authentic record existing of the events it relates.

A notice of the work will be found in W. H. Prescott's *History of the Conquest of Peru* (new ed., London, 1902).

FERNANDEZ, JOHN (*João, Joam*), Portuguese traveller of the 15th century. He was perhaps the earliest of modern explorers in the upland of West Africa, and a pioneer of the European slave- and gold-trade of Guinea. We first hear of him (before 1445) as a captive of the Barbary Moors in the western Mediterranean; while among these he acquired a knowledge of Arabic, and probably conceived the design of exploration in the interior of the continent whose coasts the Portuguese were now unveiling. In 1445 he volunteered to stay in Guinea and gather what information he could for Prince Henry the Navigator; with this object he accompanied Antam Gonçalves to the "River of Gold" (Rio d'Ouro, Rio de Oro) in 23° 40' N., where he landed and went inland with some native shepherds. He stayed seven months in the country, which lay just within Moslem Africa, slightly north of Pagan Negroland (W. Sudan); he was taken off again by Antam Gonçalves at a point farther down the coast, near the "Cape of Ransom" (Cape Mirik), in 19° 22' 14"; and his account of his experiences proved of great interest and value, not only as to the natural features, climate, fauna and flora of the south-western Sahara, but also as to the racial affinities, language, script, religion, nomad habits, and trade of its inhabitants. These people—though Mahomedans, maintaining a certain trade in slaves, gold, &c., with the Barbary coast (especially with Tunis), and classed as "Arabs," "Berbers," and "Tawny Moors"—did not then write or speak Arabic. In 1446 and 1447 John Fernandez accompanied other expeditions to the Rio d'Ouro and other parts of West Africa in the service of Prince Henry. He was personally known to Gomes Eannes de Azurara, the historian of this early period of Portuguese expansion; and from Azurara's language it is clear that Fernandez' revelation of unknown lands and races was fully appreciated at home.

See Azurara, *Chronica de . . . Guiné*, chs. xxix., xxxii., xxxiv., xxxv., lxxvii., lxxviii., xc., xci., xciii.

FERNANDEZ, JUAN (fl. c. 1570), Spanish navigator and discoverer. While navigating the coasts of South America it occurred to him that the south winds constantly prevailing

near the shore, and retarding voyages between Peru and Chile, might not exist farther out at sea. His idea proved correct, and by the help of the trade winds and some currents at a distance from the coast he sailed with such rapidity (thirty days) from Callao to Chile that he was apprehended on a charge of sorcery. His inquisitors, however, accepted his natural explanation of the marvel. During one of his voyages in 1563 (from Lima to Valdivia) Fernandez discovered the islands which now bear his name. He was so enchanted with their beauty and fertility that he solicited the concession of them from the Spanish government. It was granted in 1572, but a colony which he endeavoured to establish at the largest of them (Isla Mas-a-Tierra) soon broke up, leaving behind the goats, whose progeny were hunted by Alexander Selkirk. In 1574 Fernandez discovered St Felix and St Ambrose islands (in 27° S., 82° 7' W.); and in 1576, while voyaging in the southern ocean, he is said to have sighted not only Easter Island, but also a continent, which was probably Australia or New Zealand if the story (rejected by most critics, but with reservations as to Easter Island) is to be accepted.

See J. L. Arias, *Memoir recommending to the king the conversion of the new discovered islands* (in Spanish, 1609; Eng. trans., 1773); Ulloa, *Relacion del Viaje*, bk. ii. ch. iv.; Alexander Dalrymple, *An Historical Collection of the several Voyages and Discoveries in the South Pacific Ocean* (London, 1769-1771); Fréville, *Voyages de la Mer du Sud par les Espagnols*.

FERNANDEZ, LUCAS, Spanish dramatist, was born at Salamanca about the middle of the 15th century. Nothing is known of his life, and he is represented by a single volume of plays, *Farsas y églogas al modo y estilo pastoril* (1514). In his secular pieces—a *comedia* and two *farsas*—he introduces few personages, employs the simplest possible action, and burlesques the language of the uneducated class; the secular and devout elements are skilfully intermingled in his two *Farsas del nacimiento de Nuestro Señor Jesucristo*. But the best of his dramatic essays is the *Auto de la Pasión*, a devout play intended to be given on Maundy Thursday. It is written in the manner of Encina, with less spontaneity, but with a sombre force to which Encina scarcely attained.

Fernandez' plays were reprinted by the Spanish Academy in 1867.

FERNANDINA, a city, a port of entry, and the county-seat of Nassau county, Florida, U.S.A., a winter and summer resort, in the N.E. part of the state, 36 m. N.E. of Jacksonville, on Amelia Island (about 22 m. long and from ½ m. to 1½ m. wide), which is separated from the mainland by an arm of the sea, known as Amelia river and bay. Pop. (1900) 3245; (1905, state census), 4959 (2957 negroes); (1910) 3482. Fernandina is served by the Seaboard Air Line railway, and by steamship lines connecting with domestic and foreign ports; its harbour, which has the deepest water on the E. coast of Florida, opens on the N. to Cumberland Sound, which was improved by the Federal government, beginning in 1879, reducing freight rates at Fernandina by 25 to 40%. Under an act of 1907 the channel of Fernandina harbour, 1300 ft. wide at the entrance and about 2 m. long, was dredged to a depth of 20 to 24 ft. at mean low water with a width of 400 to 600 ft. The "inside" water-route between Savannah, Georgia and Fernandina is improved by the Federal government (1892 sqq.) and has a 7-ft. channel. The principal places of interest are "Amelia Beach," more than 20 m. long and 200 ft. wide, connected with the city by a compact shell road nearly 2 m. long and by electric line; the Amelia Island lighthouse, in the N. end of the island, established in 1836 and rebuilt in 1880; Fort Clinch, at the entrance to the harbour; Cumberland Island, in Georgia, N. of Amelia Island, where land was granted to General Nathanael Greene after the War of American Independence by the state of Georgia; and Dungeness, the estate of the Carnegie family. Ocean City, on Amelia Beach, is a popular pleasure resort. The principal industries are the manufacture of lumber, cotton, palmetto fibres, and cigars, the canning of oysters, and the building and repair of railway cars. The foreign exports, chiefly lumber, railway ties, cotton, phosphate rock, and naval stores, were valued at \$9,346,704 in 1907; and the imports in 1907 at \$116,514.

The harbour of Fernandina was known to the early explorers

of Florida, and it was here that Dominic de Gourgues landed when he made his expedition against the Spanish at San Mateo in 1568. An Indian mission was established by Spanish priests later in the same century, but it was not successful. When Georgia was founded, General James Oglethorpe placed a military guard on Amelia Island to prevent sudden attack upon his colony by the Spanish, and the first blood shed in the petty warfare between Georgia and Florida was the murder of two unarmed members of the guard by a troop of Spanish soldiers and Indians in 1739. The first permanent settlement was made by the Spanish in 1808, at what is now the village of Old Fernandina, about 1 m. from the city. The island was a centre for smuggling during the period of the embargo and non-importation acts preceding the war of 1812. This was the pretext for General George Matthews (1738-1812) to gather a band of adventurers at St Mary's, Georgia, invade the island, and capture Fernandina in 1812. In the following year the American forces were withdrawn. In 1817 Gregor MacGregor, a filibuster who had aided the Spanish provinces of South America in their revolt against Spain, fitted out an expedition in Baltimore and seized Fernandina, but departed soon after. Later in the same year Louis Aury, another adventurer, appeared with a small force from Texas, and took possession of the place in the name of the Republic of Mexico. In the following year Aury was expelled by United States troops, who held Fernandina in trust for Spain until Florida was finally ceded to the United States in 1821. Fernandina was first incorporated in 1859. In 1861 Fort Clinch was seized by the Confederates, and Fernandina harbour was a centre of blockade running in the first two years of the Civil War. In 1862 the place was captured by a Federal naval force from Port Royal, South Carolina, commanded by Commodore S. F. Du Pont.

FERNANDO DE NORONHA [*Fernão de N.*], an island in the South Atlantic, 125 m. from the coast of Brazil, to which country it belongs, in 3° 50' S., 32° 25' W. It is about 7 m. long and 1½ wide, and some other islets lie adjacent to it. Its surface is rugged, and it contains a number of rocky hills from 500 to 700 ft. high, and one peak towering to the height of 1080 ft. It is formed of basalt, trachyte and phonolite, and the soil is very fertile. The climate is healthy. It is defended by forts, and serves as a place of banishment for criminals from Brazil. The next largest island of the group is about a mile in circumference, and the others are small barren rocks. The population is about 2000, all males, including some 1400 criminals, and a garrison of 150. Communication is maintained by steamer with Pernambuco. The island takes name from its Portuguese discoverer (1503), the count of Noronha.

FERNANDO PO, or **FERNANDO PÓO**, a Spanish island on the west coast of Africa, in the Bight of Biafra, about 20 m. from the mainland, in 3° 12' N. and 8° 48' E. It is of volcanic origin, related to the Cameroon system of the adjacent mainland, is the largest island in the Gulf of Guinea, is 44 m. long from N.N.E. to S.S.W., about 20 m. broad, and has an area of about 780 sq. m. Fernando Po is noted for its beautiful aspect, seeming from a short distance to be a single mountain rising from the sea, its sides covered with luxuriant vegetation. The shores are steep and rocky and the coast plain narrow. This plain is succeeded by the slopes of the mountains which occupy the rest of the island and culminate in the magnificent cone of Clarence Peak or Pico de Santa Isabel (native name Owassa). Clarence Peak, about 10,000 ft. high,¹ is in the north-central part of the island. In the south Musolo Mt. attains a height of 7400 ft. There are numerous other peaks between 4000 and 6000 ft. high. The mountains contain craters and crater lakes, and are covered, most of them to their summits, with forests. Down the narrow intervening valleys rush torrential streams which have cut deep beds through the coast plains. The trees most characteristic of the forest are oil palms and tree ferns, but there are many varieties, including ebony, mahogany and the African oak. The undergrowth is very dense; it includes the sugar-cane and cotton and indigo plants. The fauna includes antelopes, monkeys,

¹ The heights given by explorers vary from 9200 to 10,800 ft.

lemurs, the civet cat, porcupine, pythons and green tree-snakes, crocodiles and turtles. The climate is very unhealthy in the lower districts, where malarial fever is common. The mean temperature on the coast is 78° Fahr. and varies little, but in the higher altitudes there is considerable daily variation. The rainfall is very heavy except during November-January, which is considered the dry season.

The inhabitants number about 25,000. In addition to about 500 Europeans, mostly Spaniards and Cubans, they are of two classes, the Bubi or Bube (formerly also called Ediya), who occupy the interior, and the coast dwellers, a mixed Negro race, largely descended from slave ancestors with an admixture of Portuguese and Spanish blood, and known to the Bubi as "Portos"—a corruption of Portuguese. The Bubi are of Bantu stock and early immigrants from the mainland. Physically they are a finely developed race, extremely jealous of their independence and unwilling to take service of any kind with Europeans. They go unclothed, smearing their bodies with a kind of pomatum. They stick pieces of wood in the lobes of their ears, wear numerous armlets made of ivory, beads or grass, and always wear hats, generally made of palm leaves. Their weapons are mainly of wood; stone axes and knives were in use as late as 1858. They have no knowledge of working iron. Their villages are built in the densest parts of the forest, and care is taken to conceal the approach to them. The Bubi are sportsmen and fishermen rather than agriculturists. The staple foods of the islanders generally are millet, rice, yams and bananas. Alcohol is distilled from the sugar-cane. The natives possess numbers of sheep, goats and fowls.

The principal settlement is Port Clarence (pop. 1500), called by the Spaniards Santa Isabel, a safe and commodious harbour on the north coast. In its graveyard are buried Richard Lander and several other explorers of West Africa. Port Clarence is unhealthy, and the seat of government has been removed to Basile, a small town 5 m. from Port Clarence and over 1000 ft. above the sea. On the west coast are the bay and port of San Carlos, on the east coast Concepcion Bay and town. The chief industry until the close of the 19th century was the collection of palm-oil, but the Spaniards have since developed plantations of cocoa, coffee, sugar, tobacco, vanilla and other tropical plants. The kola nut is also cultivated. The cocoa plantations are of most importance. The amount of cocoa exported in 1905 was 1800 tons, being 370 tons above the average export for the preceding five years. The total value of the trade of the island (1900-1905) was about £250,000 a year.

History.—The island was discovered towards the close of the 15th century by a Portuguese navigator called Fernão do Po, who, struck by its beauty, named it Formosa, but it soon came to be called by the name of its discoverer.² A Portuguese colony was established in the island, which together with Annobon was ceded to Spain in 1778. The first attempts of Spain to develop the island ended disastrously, and in 1827, with the consent of Spain, the administration of the island was taken over by Great Britain, the British "superintendent" having a Spanish commission as governor. By the British Fernando Po was used as a naval station for the ships engaged in the suppression of the slave trade. The British headquarters were named Port Clarence and the adjacent promontory Cape William, in honour of the duke of Clarence (William IV.). In 1844 the Spaniards reclaimed the island, refusing to sell their rights to Great Britain. They did no more at that time, however, than hoist the Spanish flag, appointing a British resident, John Beecroft, governor. Beecroft, who was made British consul in 1849, died in 1854. During the British occupation a considerable number of Sierra Leonians, West Indians and freed slaves settled in the island, and English became and remains the common speech of the coast peoples. In 1858 a Spanish governor was sent out, and the Baptist missionaries who had laboured in the island since 1843 were compelled to withdraw. They settled in Amba Bay on the

² Some authorities maintain that another Portuguese seaman, Lopes Gonsalves, was the discoverer of the island. The years 1469, 1471 and 1486 are variously given as those of the date of the discovery.

neighbouring mainland (see CAMEROON). The Jesuits who succeeded the Baptists were also expelled, but mission and educational work is now carried on by other Roman Catholic agencies, and (since 1870) by the Primitive Methodists. In 1879 the Spanish government recalled its officials, but a few years later, when the partition of Africa was being effected, they were replaced and a number of Cuban political prisoners were deported thither. Very little was done to develop the resources of the island until after the loss of the Spanish colonies in the West Indies and the Pacific, when Spain turned her attention to her African possessions. Stimulated by the success of the Portuguese cocoa plantations in the neighbouring island of St Thomas, the Spaniards started similar plantations, with some measure of success. The strategical importance and commercial possibilities of the island caused Germany and other powers to approach Spain with a view to its acquisition, and in 1900 the Spaniards gave France, in return for territorial concessions on the mainland, the right of pre-emption over the island and her other West African possessions.

The administration of the island is in the hands of a governor-general, assisted by a council, and responsible to the ministry of foreign affairs at Madrid. The governor-general has under his authority the sub-governors of the other Spanish possessions in the Gulf of Guinea, namely, the Muni River Settlement, Corisco and Annobon (see those articles). None of these possessions is self-supporting.

See E. d'Almonte, "Someras Notas . . . de la isla de Fernando Póo y de la Guinea continental española," in *Bol. Real. Soc. Geog.* of Madrid (1902); and a further article in the *Riv. Geog. Col.* of Madrid (1908); E. L. Vilches, "Fernando Póo y la Guinea española," in the *Bol. Real. Soc. Geog.* (1901); San Javier, *Tres Años en Fernando Póo* (Madrid, 1875); O. Baumann, *Eine africanische Tropeninsel: Fernando Póo und die Bube* (Vienna, 1888); Sir H. H. Johnston, *George Grenfell and the Congo . . . and Notes on Fernando Póo* (London, 1908); Mary H. Kingsley, *Travels in West Africa*, ch. iii. (London, 1897); T. J. Hutchinson, sometime British Consul at Fernando Po, *Impressions of Western Africa*, chs. xii. and xiii. (London, 1858), and *Ten Years' Wanderings among the Ethiopians*, chs. xvii. and xviii. (London, 1861). For the Bubi language see J. Clarke, *The Adeeyah Vocabulary* (1841), and *Introduction to the Fernandian Tongue* (1848). Consult also *Wanderings in West Africa* (1863) and other books written by Sir Richard Burton as the result of his consulship at Fernando Po, 1861-1865, and the works cited under MUNI RIVER SETTLEMENTS.

FERNEL, JEAN FRANÇOIS (1497-1558), French physician, was born at Clermont in 1497, and after receiving his early education at his native town, entered the college of Sainte-Barbe, Paris. At first he devoted himself to mathematical and astronomical studies; his *Cosmotheoria* (1528) records a determination of a degree of the meridian, which he made by counting the revolutions of his carriage wheels on a journey between Paris and Amiens. But from 1534 he gave himself up entirely to medicine, in which he graduated in 1530. His extraordinary general erudition, and the skill and success with which he sought to revive the study of the old Greek physicians, gained him a great reputation, and ultimately the office of physician to the court. He practised with great success, and at his death in 1558 left behind him an immense fortune. He also wrote *Monosphaerium, sive astrolabii genus, generalis horarii structura et usus* (1526); *De proportionibus* (1528); *De evacuandi ratione* (1545); *De abditis rerum causis* (1548); and *Medicina ad Henricum II.* (1554).

FERNIE, an important city in the east Kootenay district of British Columbia. Pop. about 4000. It is situated on the Crow's Nest branch of the Canadian Pacific railway, at the junction of Coal Creek with the Elk river, and owes its importance to the extensive coal mines in its vicinity. There are about 500 coke ovens in operation at Fernie, which supply most of the smelting plants in southern British Columbia with fuel.

FERNOW, KARL LUDWIG (1763-1808), German art-critic and archaeologist, was born in Pomerania on the 19th of November 1763. His father was a servant in the household of the lord of Blumenhagen. At the age of twelve he became clerk to a notary, and was afterwards apprenticed to a druggist. While serving his time he had the misfortune accidentally to

shoot a young man who came to visit him; and although through the intercession of his master he escaped prosecution, the untoward event weighed heavily on his mind, and led him at the close of his apprenticeship to quit his native place. He obtained a situation at Lübeck, where he had leisure to cultivate his natural taste for drawing and poetry. Having formed an acquaintance with the painter Carstens, whose influence was an important stimulus and help to him, he renounced his trade of druggist, and set up as a portrait-painter and drawing-master. At Ludwigslust he fell in love with a young girl, and followed her to Weimar; but failing in his suit, he went next to Jena. There he was introduced to Professor Reinhold, and in his house met the Danish poet Baggesen. The latter invited him to accompany him to Switzerland and Italy, a proposal which he eagerly accepted (1794) for the sake of the opportunity of furthering his studies in the fine arts. On Baggesen's return to Denmark, Fernow, assisted by some of his friends, visited Rome and made some stay there. He now renewed his intercourse with Carstens, who had settled at Rome, and applied himself to the study of the history and theory of the fine arts and of the Italian language and literature. Making rapid progress, he was soon qualified to give a course of lectures on archaeology, which was attended by the principal artists then at Rome. Having married a Roman lady, he returned in 1802 to Germany, and was appointed in the following year professor extraordinary of Italian literature at Jena. In 1804 he accepted the post of librarian to Amelia, duchess-dowager of Weimar, which gave him the leisure he desired for the purpose of turning to account the literary and archaeological researches in which he had engaged at Rome. His most valuable work, the *Römische Studien*, appeared in 3 vols. (1806-1808). Among his other works are—*Das Leben des Künstlers Carstens* (1806), *Ariosto's Lebenslauf* (1809), and *Francesco Petrarca* (1818). Fernow died at Weimar, December 4, 1808.

A memoir of his life by Johanna Schopenhauer, mother of the philosopher, Arthur Schopenhauer, appeared in 1810, and a complete edition of his works in 1829.

FEROZEPUR, or **FIROZPUR**, a town and district of British India, in the Jullundur division of the Punjab. The town is a railway junction connecting the North-Western and Rajputana railways, and is situated about 4 m. from the present south bank of the Sutlej. Pop. (1901) 49,341. The arsenal is the largest in India, and Ferozepur is the headquarters of a brigade in the 3rd division of the northern army corps. British rule was first established at Ferozepur in 1835, when, on the failure of heirs to the Sikh family who possessed it, a small territory 86 m. in extent became an escheat to the British government, and the present district has been gradually formed around this nucleus. The strategic importance of Ferozepur was at this time very great; and when, in 1839, Captain (afterwards Sir Henry) Lawrence took charge of the station as political officer, it was the outpost of British India in the direction of the Sikh power. Ferozepur accordingly became the scene of operations during the first Sikh War. The Sikhs crossed the Sutlej in December 1845, and were defeated successively at Mudki, Ferozepur, Aliwal and Sobraon; after which they withdrew into their own territory, and peace was concluded at Lahore. At the time of the mutiny Ferozepur cantonments contained two regiments of native infantry and a regiment of native cavalry, together with the 61st Foot and two companies of European artillery. One of the native regiments, the 57th, was disarmed; but the other, the 45th, broke into mutiny, and, after an unsuccessful attempt to seize the magazine, which was held by the Europeans, proceeded to join the rebel forces in Delhi. Throughout the mutiny Ferozepur remained in the hands of the English.

Ferozepur has rapidly advanced in material prosperity of late years, and is now a very important seat of commerce, trade being mainly in grain. The main streets of the city are wide and well paved, and the whole is enclosed by a low brick wall. Great improvements have been made in the surroundings of the city. The cantonment lies 2 m. to the south of the city, and is connected with it by a good metalled road.

The DISTRICT OF FEROZEPUR comprises an area of 4302 sq. m. The surface is level, with the exception of a few sand-hills in the south and south-east. The country consists of two distinct tracts, that liable to annual fertilizing inundations from the Sutlej, known as the *bhet*, and the *rohi* or upland tract. The only river is the Sutlej, which runs along the north-western boundary. The principal crops are wheat, barley, millet, gram, pulses, oil-seeds, cotton, tobacco, &c. The manufactures are of the humblest kind, consisting chiefly of cotton and wool-weaving, and are confined entirely to the supply of local wants. The Lahore and Ludhiāna road runs for 51 m. through the district, and forms an important trade route. The North-Western, the Southern Punjab, and a branch of the Rajputana-Malwa railways serve the district. The other important towns and seats of commerce are Fazilka (pop. 8505), Dharmkot (6731), Moga (6725), and Muktsar (6389). Owing principally to the dryness of its climate, Ferozepur has the reputation of being an exceptionally healthy district. In September and October, however, after the annual rains, the people suffer a good deal from remittent fever. In 1901 the population was 958,072. Distributaries of the Sirhind canal water the whole district.

FEROZESHAH, a village in the Punjab, India, notable as the scene of one of the chief battles in the first Sikh War. The battle immediately succeeded that of Mudki, and was fought on the 21st and 22nd of December 1845. During its course Sir Hugh Gough, the British commander, was overruled by the governor-general, Lord Hardinge, who was acting as his second in command (see SIKH WARS). At the end of the first day's fighting the British had occupied the Sikh position, but had not gained an undisputed victory. On the following morning the battle was resumed, and the Sikhs were reinforced by a second army under Tej Singh; but through cowardice or treachery Tej Singh withdrew at the critical moment, leaving the field to the British. In the course of the fight the British lost 694 killed and 1721 wounded, the vast majority being British troops, while the Sikhs lost 100 guns and about 5000 killed and wounded.

FERRAND, ANTOINE FRANÇOIS CLAUDE, COMTE (1751–1825), French statesman and political writer, was born in Paris on the 4th of July 1751, and became a member of the parlement of Paris at eighteen. He left France with the first party of emigrants, and attached himself to the prince of Condé; later he was a member of the council of regency formed by the comte de Provence after the death of Louis XVI. He lived at Regensburg until 1801, when he returned to France, though he still sought to serve the royalist cause. In 1814 Ferrand was made minister of state and postmaster-general. He countersigned the act of sequestration of Napoleon's property, and introduced a bill for the restoration of the property of the emigrants, establishing a distinction, since become famous, between royalists of *la ligne droite* and those of *la ligne courbe*. At the second restoration Ferrand was again for a short time postmaster-general. He was also made a peer of France, member of the privy council, grand-officer and secretary of the orders of Saint Michel and the Saint Esprit, and in 1816 member of the Academy. He continued his active support of ultra-royalist views until his death, which took place in Paris on the 17th of January 1825.

Besides a large number of political pamphlets, Ferrand is the author of *L'Esprit de l'histoire, ou Lettres d'un père à son fils sur la manière d'étudier l'histoire* (4 vols., 1802), which reached seven editions, the last number in 1826 having prefixed to it a biographical sketch of the author by his nephew Héricart de Thury; *Éloge historique de Madame Élisabeth de France* (1814); *Cœuvres dramatiques* (1817); *Théorie des révolutions rapprochée des événements qui en ont été l'origine, le développement, ou la suite* (4 vols., 1817); and *Histoire des trois démembrements de la Pologne, pour faire suite à l'Histoire de l'anarchie de Pologne par Rulhière* (3 vols., 1820).

FERRAR, NICHOLAS (1592–1637), English theologian, was born in London in 1592 and educated at Clare Hall, Cambridge, graduating in 1610. He was obliged for some years to travel for his health, but on returning to England in 1618 became actively connected with the Virginia Company. When this company was deprived of its patent in 1623 Ferrar turned his attention to politics, and was elected to parliament. But he soon decided

to devote himself to a religious life; he purchased the manor of Little Gidding in Huntingdonshire, where he organized a small religious community. Here, in 1626, he was ordained a deacon by Laud, and declining preferment, he lived an austere, almost monastic life of study and good works. He died on the 4th of December 1637, and the house was despoiled and the community broken up ten years later. There are extant a number of "harmonies" of the Gospel, printed and bound by the community, two of them by Ferrar himself. One of the latter was made for Charles I. on his request, after a visit in 1633 to see the "Arminian Nunnery at Little Gidding," which had been the subject of some scandalous—and undeserved—criticism.

FERRAR, ROBERT (d. 1555), bishop of St David's and martyr, born about the end of the 15th century of a Yorkshire family, is said to have been educated at Cambridge, whence he proceeded to Oxford and became a canon regular of St Augustine. He came under the influence of Thomas Gerrard and Lutheran theology, and was compelled to bear a faggot with Anthony Dalaber and others in 1528. He graduated B.D. in 1533, accompanied Bishop Barlow on his embassy to Scotland in 1535, and was made prior of St Oswald's at Nostell near Pontefract. At the dissolution he surrendered his priory without compunction to the crown, and received a liberal pension. For the rest of Henry's reign his career is obscure; perhaps he fled abroad on the enactment of the Six Articles. He certainly married, and is said to have been made Cranmer's chaplain, and bishop of Sodor and Man; but he was never consecrated to that see.

After the accession of Edward VI., Ferrar was, probably through the influence of Bishop Barlow, appointed chaplain to Protector Somerset, a royal visitor, and bishop of St David's on Barlow's translation to Bath and Wells in 1548. He was the first bishop appointed by letters patent under the act passed in 1547 without the form of capitular election; and the service performed at his consecration was also novel, being in English; he also preached at St Paul's on the 11th of November clad only as a priest and not as a bishop, and inveighed against vestments and altars. At St David's he had trouble at once with his singularly turbulent chapter, who, finding that he was out of favour at court since Somerset's fall in 1549, brought a long list of fantastic charges against him. He had taught his child to whistle, dined with his servants, talked of "worldly things such as baking, brewing, enclosing, ploughing and mining," preferred walking to riding, and denounced the debasement of the coinage. He seems to have been a kindly, homely, somewhat feckless person like many an excellent parish priest, who did not conceal his indignation at some of Northumberland's deeds. He had voted against the act of November 1549 for a reform of the canon law, and on a later occasion his nonconformity brought him into conflict with the Council; he was also the only bishop who satisfied Hooper's test of sacramental orthodoxy. The Council accordingly listened to the accusations of Ferrar's chapter, and in 1552 he was summoned to London and imprisoned on a charge of *praemunire* incurred by omitting the king's authority in a commission which he issued for the visitation of his diocese.

Imprisonment on such a charge under Northumberland might have been expected to lead to liberation under Mary. But Ferrar had been a monk and was married. Even so, it is difficult to see on what legal ground he was kept in the queen's bench prison after July 1553; for Mary herself was repudiating the royal authority in religion. Ferrar's marriage accounts for the loss of his bishopric in March 1554, and his opinions for his further punishment. As soon as the heresy laws and ecclesiastical jurisdiction had been re-established, Ferrar was examined by Gardiner, and then with signal indecency sent down to be tried by Morgan, his successor in the bishopric of St David's. He appealed from Morgan's sentence to Pole as papal legate, but in vain, and was burnt at Caermarthen on the 30th of March 1555. It was perhaps the most wanton of all Mary's acts of persecution; Ferrar had been no such protagonist of the Reformation as Cranmer, Ridley, Hooper and Latimer; he had had nothing to do with Northumberland's or Wyatt's conspiracy. He had

taken no part in politics, and, so far as is known, had not said a word or raised a hand against Mary. He was burnt simply because he could not change his religion with the law and would not pretend that he could; and his execution is a complete refutation of the idea that Mary only persecuted heretics because and when they were traitors.

See *Dictionary of National Biography*, xviii. 380-382, and authorities there cited. Also Acts of the Privy Council (1550-1554); H. A. L. Fisher, *Political History of England*, vol. vi. (A. F. P.)

FERRARA, a city and archiepiscopal see of Emilia, Italy, capital of the province of Ferrara, 30 m. N.N.E. of Bologna, situated 30 ft. above sea-level on the Po di Vomano, a branch channel of the main stream of the Po, which is $3\frac{1}{2}$ m. N. Pop. (1901) 32,968 (town), 86,392 (commune). The town has broad streets and numerous palaces, which date from the 16th century, when it was the seat of the court of the house of Este, and had, it is said, 100,000 inhabitants.

The most prominent building is the square castle of the house of Este, in the centre of the town, a brick building surrounded by a moat, with four towers. It was built after 1385 and partly restored in 1554; the pavilions on the top of the towers date from the latter year. Near it is the hospital of S. Anna, where Tasso was confined during his attack of insanity (1579-1586). The Palazzo del Municipio, rebuilt in the 18th century, was the earlier residence of the Este family. Close by is the cathedral of S. Giorgio, consecrated in 1135, when the Romanesque lower part of the main façade and the side façades were completed. It was built by Guglielmo degli Adelardi (d. 1146), who is buried in it. The upper part of the main façade, with arcades of pointed arches, dates from the 13th century, and the portal has recumbent lions and elaborate sculptures above. The interior was restored in the baroque style in 1712. The campanile, in the Renaissance style, dates from 1451-1493, but the last storey was added at the end of the 16th century. Opposite the cathedral is the Gothic Palazzo della Ragione, in brick (1315-1326), now the law-courts. A little way off is the university, which has faculties of law, medicine and natural science (hardly 100 students in all); the library has valuable MSS., including part of that of the *Orlando Furioso* and letters by Tasso. The other churches are of less interest than the cathedral, though S. Francesco, S. Benedetto, S. Maria in Vado and S. Cristoforo are all good early Renaissance buildings. The numerous early Renaissance palaces, often with good terra-cotta decorations, form quite a feature of Ferrara; few towns of Italy have so many of them proportionately, though they are mostly comparatively small in size. Among them may be noted those in the N. quarter (especially the four at the intersection of its two main streets), which was added by Ercole (Hercules) I. in 1492-1505, from the plans of Biagio Rossetti, and hence called the "Addizione Erculea." The finest of these is the Palazzo de' Diamanti, so called from the diamond points into which the blocks of stone with which it is faced are cut. It contains the municipal picture gallery, with a large number of pictures of artists of the school of Ferrara. This did not require prominence until the latter half of the 15th century, when its best masters were Cosimo Tura (1432-1495), Francesco Cossa (d. 1480) and Ercole dei Roberti (d. 1496). To this period are due famous frescoes in the Palazzo Schifanoia, which was built by the Este family; those of the lower row depict the life of Borso of Este, in the central row are the signs of the zodiac, and in the upper are allegorical representations of the months. The vestibule was decorated with stucco mouldings by Domenico di Paris of Padua. The building also contains fine choir-books with miniatures, and a collection of coins and Renaissance medals. The simple house of Ariosto, erected by himself after 1526, in which he died in 1532, lies farther west. The best Ferrarese masters of the 16th century of the Ferrara school were Lorenzo Costa (1460-1535), and Dosso Dossi (1479-1542), the most eminent of all, while Benvenuto Tisi (Garofalo, 1481-1559) is somewhat monotonous and insipid.

The origin of Ferrara is uncertain, and probabilities are against the supposition that it occupies the site of the ancient Forum

Alieni. It was probably a settlement formed by the inhabitants of the lagoons at the mouth of the Po. It appears first in a document of Aistulf of 753 or 754 as a city forming part of the exarchate of Ravenna. After 984 we find it a fief of Tedaldo, count of Modena and Canossa, nephew of the emperor Otho I. It afterwards made itself independent, and in 1101 was taken by siege by the countess Matilda. At this time it was mainly dominated by several great families, among them the Adelardi.

In 1146 Guglielmo, the last of the Adelardi, died, and his property passed, as the dowry of his niece Marchesella, to Azzolino d' Este. There was considerable hostility between the newly entered family and the Salinguerra, but after considerable struggles Azzo Novello was nominated perpetual podestà in 1242; in 1259 he took Ezzelino of Verona prisoner in battle. His grandson, Obizzo II. (1264-1293), succeeded him, and the pope nominated him captain-general and defender of the states of the Church; and the house of Este was from henceforth settled in Ferrara. Niccolò III. (1393-1441) received several popes with great magnificence, especially Eugene IV., who held a council here in 1438. His son Borso received the fiefs of Modena and Reggio from the emperor Frederick III. as first duke in 1452 (in which year Girolamo Savonarola was born here), and in 1470 was made duke of Ferrara by Pope Paul II. Ercole I. (1471-1505) carried on a war with Venice and increased the magnificence of the city. His son Alphonso I. married Lucrezia Borgia, and continued the war with Venice with success. In 1509 he was excommunicated by Julius II., and attacked the pontifical army in 1512 outside Ravenna, which he took. Gaston de Foix fell in the battle, in which he was supporting Alphonso. With the succeeding popes he was able to make peace. He was the patron of Ariosto from 1518 onwards. His son Ercole II. married Renata, daughter of Louis XII. of France; he too embellished Ferrara during his reign (1534-1559). His son Alphonso II. married Barbara, sister of the emperor Maximilian II. He raised the glory of Ferrara to its highest point, and was the patron of Tasso and Guarini, favouring, as the princes of his house had always done, the arts and sciences. He had no legitimate male heir, and in 1597 Ferrara was claimed as a vacant fief by Pope Clement VIII., as was also Comacchio. A fortress was constructed by him on the site of the castle of Tedaldo, at the W. angle of the town. The town remained a part of the states of the Church, the fortress being occupied by an Austrian garrison from 1832 until 1859, when it became part of the kingdom of Italy.

A considerable area within the walls of Ferrara is unoccupied by buildings, especially on the north, where the handsome Renaissance church of S. Cristoforo, with the cemetery, stands; but modern times have brought a renewal of industrial activity. Ferrara is on the main line from Bologna to Padua and Venice, and has branches to Ravenna and Poggio Rusco (for Suzzara).

See G. Agnelli, *Ferrara e Pomposa* (Bergamo, 1902); E. G. Gardner, *Dukes and Poets of Ferrara* (London, 1904).

FERRARA-FLORENCE, COUNCIL OF (1438 ff.). The council of Ferrara and Florence was the culmination of a series of futile medieval attempts to reunite the Greek and Roman churches. The emperor, John VI. Palaeologus, had been advised by his experienced father to avoid all serious negotiations, as they had invariably resulted in increased bitterness; but John, in view of the rapid dismemberment of his empire by the Turks, felt constrained to seek a union. The situation was, however, complicated by the strife which broke out between the pope (Eugenius IV.) and the oecumenical council of Basel. Both sides sent embassies to the emperor at Constantinople, as both saw the importance of gaining the recognition and support of the East, for on this practically depended the victory in the struggle between papacy and council for the supreme jurisdiction over the church (see COUNCILS). The Greeks, fearing the domination of the papacy, were at first more favourably inclined toward the conciliar party; but the astute diplomacy of the Roman representatives, who have been charged by certain Greek writers with the skilful use of money and of lies, won over the emperor.

With a retinue of about 700 persons, entertained in Italy at the pope's expense, he reached Ferrara early in March 1438. Here a council had been formally opened in January by the papal party, a bull of the previous year having promptly taken advantage of the death of the Emperor Sigismund by ordering the removal of the council of Ferrara; and one of the first acts of the assemblage at Ferrara had been to excommunicate the remnant at Basel. A month after the coming of the Greeks, the Union Synod was solemnly inaugurated on the 9th of April 1438. After six months of negotiation, the first formal session was held on the 8th of October, and on the 14th the real issues were reached. The time-honoured question of the *filioque* was still in the foreground when it seemed for several reasons advisable to transfer the council to Florence: Ferrara was threatened by condottieri, the pest was raging; Florence promised a welcome subvention, and a situation further inland would make it more difficult for uneasy Greek bishops to flee the synod.

The first session at Florence and the seventeenth of the union council took place on the 26th of February 1439; there ensued long debates and negotiations on the *filioque*, in which Markos Eugenikos, archbishop of Ephesus, spoke for the irreconcilables; but the Greeks under the leadership of Bessarion, archbishop of Nicaea, and Isidor, metropolitan of Kiev, at length made a declaration on the *filioque* (4th of June), to which all save Markos Eugenikos subscribed. On the next topic of importance, the primacy of the pope, the project of union nearly suffered shipwreck; but here a vague formula was finally constructed which, while acknowledging the pope's right to govern the church, attempted to safeguard as well the rights of the patriarchs. On the basis of the above-mentioned agreements, as well as of minor discussions as to purgatory and the Eucharist, the decree of union was drawn up in Latin and in Greek, and signed on the 5th of July by the pope and the Greek emperor, and all the members of the synod save Eugenikos and one Greek bishop who had fled; and on the following day it was solemnly published in the cathedral of Florence. The decree explains the *filioque* in a manner acceptable to the Greeks, but does not require them to insert the term in their symbol; it demands that celebrants follow the custom of their own church as to the employment of leavened or unleavened bread in the Eucharist. It states essentially the Roman doctrine of purgatory, and asserts the world-wide primacy of the pope as the "true vicar of Christ and the head of the whole Church, the Father and teacher of all Christians"; but, to satisfy the Greeks, inconsistently adds that all the rights and privileges of the Oriental patriarchs are to be maintained unimpaired. After the consummation of the union the Greeks remained in Florence for several weeks, discussing matters such as the liturgy, the administration of the sacraments, and divorce; and they sailed from Venice to Constantinople in October.

The council, however, desirous of negotiating unions with the minor churches of the East, remained in session for several years, and seems never to have reached a formal adjournment. The decree for the Armenians was published on the 22nd of November 1439; they accepted the *filioque* and the Athanasian creed, rejected Monophysitism and Monothelism, agreed to the developed scholastic doctrine concerning the seven sacraments, and conformed their calendar to the Western in certain points. On the 26th of April 1441 the pope announced that the synod would be transferred to the Lateran; but before leaving Florence a union was negotiated with the Oriental Christians known as Jacobites, through a monk named Andreas, who, at least as regards Abyssinia, acted in excess of his powers. The *Decretum pro Jacobitis*, published on the 4th of February 1442, is, like that for the Armenians, of high dogmatic interest, as it summarizes the doctrine of the great medieval scholastics on the points in controversy. The decree for the Syrians, published at the Lateran on the 30th of September 1444, and those for the Chaldeans (Nestorians) and the Maronites (Monothelites), published at the last known session of the council on the 7th of August 1445, added nothing of doctrinal importance. Though

the direct results of these unions were the restoration of prestige to the absolutist papacy and the bringing of Byzantine men of letters, like Bessarion, to the West, the outcome was on the whole disappointing. Of the complicated history of the "United" churches of the East it suffices to say that Rome succeeded in securing but fragments, though important fragments, of the greater organizations. As for the Greeks, the union met with much opposition, particularly from the monks, and was rejected by three Oriental patriarchs at a synod of Jerusalem in 1443; and after various ineffective attempts to enforce it, the fall of Constantinople in 1453 put an end to the endeavour. As Turkish interests demanded the isolation of the Oriental Christians from their western brethren, and as the orthodox Greek nationalists feared Latinization more than Mahomedan rule, a patriarch hostile to the union was chosen, and a synod of Constantinople in 1472 formally rejected the decisions of Florence.

AUTHORITIES.—Hardouin, vol. 9; Mansi, vols. 31 A, 31 B, 35; Sylvester Sguropulus (properly Syropulus), *Vera historia Unionis*, transl. R. Creyghton (Hague, 1660); Ceconi, *Studi storici sul concilio di Firenze* (Florence, 1869), (appendix); J. Zhisman, *Die Unionverhandlungen . . . bis zum Concil von Ferrara* (Vienna, 1858); Gorski, of Moscow, 1847, *The History of the Council of Florence*, trans. from the Russian by Basil Popoff, ed. by J. M. Neale (London, 1861); C. J. von Hefele, *Concilien-geschichte*, vol. 7 (Freiburg i. B., 1874), 659-761, 793 ff., 814 ff.; H. Vast, *Le Cardinal Bessarion* (Paris, 1878), 53-113; A. Warschauer, *Über die Quellen zur Geschichte des Florentiner Concils* (Breslau, 1881), (Dissertation); M. Creighton, *A History of the Papacy during the Period of the Reformation*, vol. 2 (London, 1882), 173-194 (vivid); Knöpfler, in *Wetzer and Welte's Kirchenlexikon*, vol. 4 (2nd ed., Freiburg i. B., 1885), 1363-1380 (instructive); L. Pastor, *History of the Popes*, vol. 1 (London, 1891), 315 ff.; F. Kattenbusch, *Lehrbuch der vergleichenden Confessionskunde*, vol. 1 (Freiburg i. B., 1892), 128 ff.; N. Kalogeras, archbishop of Patras, "Die Verhandlungen zwischen der orthodox-katholischen Kirche und dem Konzil von Basel über die Wiedervereinigung der Kirchen" (*Internationale Theologische Zeitschrift*), vol. 1 (Bern, 1893, 39-57); P. Tschackert, in Herzog-Hauck, *Realencyclopädie*, vol. 6 (3rd ed., Leipzig, 1899), 45-48 (good bibliography); Walter Norden, *Das Papsttum und Byzanz: Die Trennung der beiden Mächte und das Problem ihrer Wiedervereinigung bis 1453* (Berlin, 1903), 712 ff. (W. W. R.*)

FERRARI, GAUDENZIO (1484-1549), Italian painter and sculptor, of the Milanese, or more strictly the Piedmontese, school, was born at Valduggia, Piedmont, and is said (very dubiously) to have learned the elements of painting at Vercelli from Girolamo Giovenone. He next studied in Milan, in the school of Scotto, and some say of Luini; towards 1504 he proceeded to Florence, and afterwards (it used to be alleged) to Rome. His pictorial style may be considered as derived mainly from the old Milanese school, with a considerable tinge of the influence of Da Vinci, and later on of Raphael; in his personal manner there was something of the demonstrative and fantastic. The gentler qualities diminished, and the stronger intensified, as he progressed. By 1524 he was at Varallo in Piedmont, and here, in the chapel of the Sacro Monte, the sanctuary of the Piedmontese pilgrims, he executed his most memorable work. This is a fresco of the Crucifixion, with a multitude of figures, no less than twenty-six of them being modelled in actual relief, and coloured; on the vaulted ceiling are eighteen lamenting angels, powerful in expression. Other leading examples are the following. In the Royal Gallery, Turin, a "Pietà," an able early work. In the Brera Gallery, Milan, "St Katharine miraculously preserved from the Torture of the Wheel," a very characteristic example, hard and forcible in colour, thronged in composition, turbulent in emotion; also several frescoes, chiefly from the church of Santa Maria della Pace, three of them being from the history of Joachim and Anna. In the cathedral of Vercelli, the choir, the "Virgin with Angels and Saints under an Orange Tree." In the refectory of San Paolo, the "Last Supper." In the church of San Cristoforo, the transept (in 1532-1535), a series of paintings in which Ferrari's scholar Lanini assisted him; by Ferrari himself are the "Birth of the Virgin," the "Annunciation," the "Visitation," the "Adoration of the Shepherds and Kings," the "Crucifixion," the "Assumption of the Virgin," all full of life and decided character, though somewhat mannered.

In the Louvre, "St Paul Meditating." In Varallo, convent of the Minorites (1507), a "Presentation in the Temple," and "Christ among the Doctors," and (after 1510) the "History of Christ," in twenty-one subjects; also an *ancena* in six compartments, named the "Ancona di San Gaudenzio." In Santa Maria di Loreto, near Varallo (after 1527), an "Adoration." In the church of Saronno, near Milan, the cupola (1535), a "Glory of Angels," in which the beauty of the school of Da Vinci alternates with bravura of foreshortenings in the mode of Correggio. In Milan, Santa Maria delle Grazie (1542), the "Scourging of Christ," an "Ecce Homo" and a "Crucifixion." The "Scourging," or else a "Last Supper," in the *Passione* of Milan (unfinished), is regarded as Ferrari's latest work. He was a very prolific painter, distinguished by strong expression, animation and fulness of composition, and abundant invention; he was skilful in painting horses, and his decisive rather hard colour is marked by a partiality for shot tints in drapery. In general character, his work appertains more to the 15th than the 16th century. His subjects were always of the sacred order. Ferrari's death took place in Milan. Besides Lanini, already mentioned, Andrea Solario, Giambattista della Cerva and Fermo Stella were three of his principal scholars. He is represented to us as a good man, attached to his country and his art, jovial and sometimes facetious, but an enemy of scandal. The reputation which he enjoyed soon after his death was very great, but it has not fully stood the test of time. Lomazzo went so far as to place him seventh among the seven prime painters of Italy.

See G. Bordiga, two works concerning *Gaudenzio Ferrari* (1821 and 1835); G. Colombo, *Vita ed opere di Gaudenzio Ferrari* (1881); Ethel Halsey, *Gaudenzio Ferrari* (in the series *Great Masters*, 1904).

There was another painter nearly contemporary with Gaudenzio, Difendente Ferrari, also of the Lombard school. His celebrity is by no means equal to that of Gaudenzio; but *Kugler* (1887, as edited by Layard) pronounced him to be "a good and original colourist, and the best artist that Piedmont has produced." (W. M. R.)

FERRARI, GIUSEPPE (1812-1876), Italian philosopher, historian and politician, was born at Milan on the 7th of March 1812, and died in Rome on the 2nd of July 1876. He studied law at Pavia, and took the degree of doctor in 1831. A follower of Romagnosi (d. 1835) and Giovan Battista Vico (*q.v.*), his first works were an article in the *Biblioteca Italiana* entitled "Mente di Gian Domenico Romagnosi" (1835), and a complete edition of the works of Vico, prefaced by an appreciation (1835). Finding Italy uncongenial to his ideas, he went to France and, in 1839, produced in Paris his *Vico et l'Italie*, followed by *La Nouvelle Religion de Campanella* and *La Théorie de l'erreur*. On account of these works he was made *Docteur-ès-lettres* of the Sorbonne and professor of philosophy at Rochefort (1840). His views, however, provoked antagonism, and in 1842 he was appointed to the chair of philosophy at Strassburg. After fresh trouble with the clergy, he returned to Paris and published a defence of his theories in a work entitled *Idées sur la politique de Platon et d'Aristote*. After a short connexion with the college at Bourges, he devoted himself from 1849 to 1858 exclusively to writing. The works of this period are *Les Philosophes Salariés*, *Machiavel juge des révolutions de notre temps* (1849), *La Federazione repubblicana* (1851), *La Filosofia della rivoluzione* (1851), *L'Italia dopo il colpo di Stato* (1852), *Histoire des révolutions, ou Guelfes et Gibelins* (1858; Italian trans., 1871-1873). In 1859 he returned to Italy, where he opposed Cavour, and upheld federalism against the policy of a single Italian monarchy. In spite of this opposition, he held chairs of philosophy at Turin, Milan and Rome in succession, and during several administrations represented the college of Gavirate in the chamber. He was a member of the council of education and was made senator on the 15th of May 1876. Amongst other works may be mentioned *Histoire de la raison d'état*, *La China et l'Europa*, *Corso d'istoria degli scrittori politici italiani*. A sceptic in philosophy and a revolutionist in politics, rejoicing in controversy of all kinds, he was admired as a man, as an orator, and as a writer.

See Marro Macchi, *Annuario storico italiano* (Milan, 1877); Mazzoleni, *Giuseppe Ferrari*; Werner, *Die ital. Philosophie des 19. Jahrh.* vol. 3 (Vienna, 1885); Überweg, *History of Philosophy* (Eng. trans. ii. 461 foll.).

FERRARI, PAOLO (1822-1880), Italian dramatist, was born at Modena. After producing some minor pieces, in 1852 he made his reputation as a playwright with *Goldoni e le sue sedici commedie*. Among numerous later plays his comedy *Parini e la satira* (1857) had considerable success. Ferrari may be regarded as a follower of Goldoni, modelling himself on the French theatrical methods. His collected plays were published in 1877-1880.

FERREIRA, ANTONIO (1528-1569), Portuguese poet, was a native of Lisbon; his father held the post of *escrivão de fazenda* in the house of the duke of Coimbra at Setubal, so that he must there have met the great adventurer Mendes Pinto. In 1547-1548 he went to the university of Coimbra, and on the 16th of July 1551 took his bachelor's degree. The Sonnets forming the First Book in his collected works date from 1552 and contain the history of his early love for an unknown lady. They seem to have been written in Coimbra or during vacations in Lisbon; and if some are dry and stilted, others, like the admirable No. 45, are full of feeling and tears. The Sonnets in the Second Book were inspired by D. Maria Pimentel, whom he afterwards married, and they are marked by that chastity of sentiment, seriousness and ardent patriotism which characterized the man and the writer. Ferreira's ideal, as a poet, was to win "the applause of the good," and, in the preface to his poems, he says, "I am content with this glory, that I have loved my land and my people." He was intimate with princes, nobles and the most distinguished literary men of the time, such as the scholarly Diogo de Teive and the poets Bernardes, Caminha and Corte-Real, as well as with the aged Sá de Miranda, the founder of the classical school of which Ferreira became the foremost representative.

The death in 1554 of Prince John, the heir to the throne, drew from him, as from Camoens, Bernardes and Caminha, a poetical lament, which consisted of an elegy and two eclogues, imitative of Virgil and Horace, and devoid of interest. On the 14th of July 1555 he took his doctor's degree, an event which was celebrated, according to custom, by a sort of Roman triumph, and he stayed on as a professor, finding Coimbra with its picturesque environs congenial to his poetical tastes and love of a country life. The year 1557 produced his sixth elegy, addressed to the son of the great Albuquerque, a poem of noble patriotism expressed in eloquent and sonorous verse, and in the next year he married. After a short and happy married life, his wife died, and the ninth sonnet of Book 2 describes her end in moving words. This loss lent Ferreira's verse an added austerity, and the independence of his muse is remarkable when he addresses King Sebastian and reminds him of his duties as well as his rights. On the 14th of October 1567 he became *Disembargador da Casa do Cível*, and had to leave the quiet of Coimbra for Lisbon. His verses tell how he disliked the change, and how the bustle of the capital, then a great commercial emporium, made him sad and almost tongue-tied for poetry. The intrigues and moral twists of the courtiers and traders, among whom he was forced to live, hurt his fine sense of honour, and he felt his mental isolation the more, because his friends were few and scattered in that great city which the discoveries and conquests of the Portuguese had made the centre of a world empire. In 1569 a terrible epidemic of carbunculous fever broke out and carried off 50,000 inhabitants of Lisbon, and, on the 29th of November, Ferreira, who had stayed there doing his duty when others fled, fell a victim.

Horace was his favourite poet, erudition his muse, and his admiration of the classics made him disdain the popular poetry of the Old School (*Escola Velha*) represented by Gil Vicente. His national feeling would not allow him to write in Latin or Spanish, like most of his contemporaries, but his Portuguese is as Latinized as he could make it, and he even calls his poetical works *Poemas Lusitanos*. Sá de Miranda had philosophized in the familiar *redondilha*, introduced the epistle and founded the comedy of learning. It was the beginning of a revolution, which Ferreira completed by abandoning the hendecasyllable for the Italian decasyllable, and by composing the noble and austere

Roman poetry of his letters, odes and elegies. It was all done of set purpose, for he was a reformer conscious of his mission and resolved to carry it out. The gross realism of the popular poetry, its lack of culture and its carelessness of form, offended his educated taste, and its picturesqueness and ingenuity made no appeal to him. It is not surprising, however, that though he earned the applause of men of letters he failed to touch the hearts of his countrymen. Ferreira wrote the Terentian prose comedy *Bristo*, at the age of twenty-five (1553), and dedicated it to Prince John in the name of the university. It is neither a comedy of character nor manners, but its *vis comica* lies in its plot and situations. The *Cioso*, a later product, may almost be called a comedy of character. *Castro* is Ferreira's most considerable work, and, in date, is the first tragedy in Portuguese, and the second in modern European literature. Though fashioned on the great models of the ancients, it has little plot or action, and the characters, except that of the prince, are ill-designed. It is really a splendid poem, with a chorus which sings the sad fate of Ignez in musical odes, rich in feeling and grandeur of expression. Her love is the chaste, timid affection of a wife and a vassal rather than the strong passion of a mistress, but Pedro is really the man history describes, the love-fettered prince whom the tragedy of Ignez's death converted into the cruel tyrant. King Alfonso is little more than a shadow, and only meets Ignez once, his son never; while, stranger still, Pedro and Ignez never come on the stage together, and their love is merely narrated. Nevertheless, Ferreira merits all praise for choosing one of the most dramatic episodes in Portuguese history for his subject, and though it has since been handled by poets of renown in many different languages, none has been able to surpass the old master.

The *Castro* was first printed in Lisbon in 1587, and it is included in Ferreira's *Poemas*, published in 1598 by his son. It has been translated by Musgrave (London, 1825), and the chorus of Act I. appeared again in English in the *Savoy* for July 1896. It has also been done into French and German. The *Bristo* and *Cioso* first appeared with the comedies of Sá de Miranda in Lisbon in 1622. There is a good modern edition of the Complete Works of Ferreira (2 vols., Paris, 1865). See Castilho's *Antonio Ferreira* (3 vols., Rio, 1865), which contains a full biographical and critical study with extracts. (E. PR.)

FERREL'S LAW, in physical geography. "If a body moves in any direction on the earth's surface, there is a deflecting force arising from the earth's rotation, which deflects it to the right in the northern hemisphere and to the left in the southern hemisphere." This law applies to every body that is set in motion upon the surface of the rotating earth, but usually the duration of the motion of any body due to a single impulse is so brief, and there are so many frictional disturbances, that it is not easy to observe the results of this deflecting force. The movements of the atmosphere, however, are upon a scale large enough to make this observation easy, and the simplest evidence is obtained from a study of the direction of the air movements in the great wind systems of the globe. (See METEOROLOGY.)

FERRERS, the name of a great Norman-English feudal house, derived from Ferrières-St-Hilaire, to the south of Bernay, in Normandy. Its ancestor Walkelin was slain in a feud during the Conqueror's minority, leaving a son Henry, who took part in the Conquest. At the time of the Domesday survey his fief extended into fourteen counties, but the great bulk of it was in Derbyshire and Leicestershire, especially the former. He himself occurs in Worcestershire as one of the royal commissioners for the survey. He established his chief seat at Tutbury Castle, Staffordshire, on the Derbyshire border, and founded there a Cluniac priory. As was the usual practice with the great Norman houses, his eldest son succeeded to Ferrières, and, according to Stapleton, he was ancestor of the Oakham house of Ferrers, whose memory is preserved by the horseshoes hanging in the hall of their castle. Robert, a younger son of Henry, inherited his vast English fief, and, for his services at the battle of the Standard (1138), was created earl of Derby by Stephen. He appears to have died a year after.

Both the title and the arms of the earls have been the subject

of much discussion, and they seem to have been styled indifferently earls of Derby or Nottingham (both counties then forming one shrievalty) or of Tutbury, or simply (de) Ferrers. Robert, the 2nd earl, who founded Merevale Abbey, was father of William, the 3rd earl, who began the opposition of his house to the crown by joining in the great revolt of 1173, when he fortified his castles of Tutbury and Duffield and plundered Nottingham, which was held for the king. On his subsequent submission his castles were razed. Dying at the siege of Acre, 1190, he was succeeded by his son William, who attacked Nottingham on Richard's behalf in 1194, but whom King John favoured and confirmed in the earldom of Derby, 1199. A claim that he was heir to the honour of Peveral of Nottingham, which has puzzled genealogists, was compromised with the king, whom the earl thenceforth stoutly supported, being with him at his death and witnessing his will, with his brother-in-law the earl of Chester, and with William Marshal, earl of Pembroke, whose daughter married his son. With them also he acted in securing the succession of the young Henry, joining in the siege of Mountsorrel and the battle of Lincoln. But he was one of those great nobles who looked with jealousy on the rising power of the king's favourites. In 1227 he was one of the earls who rose against him on behalf of his brother Richard and made him restore the forest charters, and in 1237 he was one of the three counsellors forced on the king by the barons. His influence had by this time been further increased by the death, in 1232, of the earl of Chester, whose sister, his wife, inherited a vast estate between the Ribble and the Mersey. On his death in 1247, his son William succeeded as 5th earl, and inherited through his wife her share of the great possessions of the Marshals, earls of Pembroke. By his second wife, a daughter of the earl of Winchester, he was father of Robert, 6th and last earl. Succeeding as a minor in 1254, Robert had been secured by the king, as early as 1249, as a husband for his wife's niece, Marie, daughter of Hugh, count of Angoulême, but, in spite of this, he joined the opposition in 1263 and distinguished himself by his violence. He was one of the five earls summoned to Simon de Montfort's parliament, though, on taking the earl of Gloucester's part, he was arrested by Simon. In spite of this he was compelled on the king's triumph to forfeit his castles and seven years' revenues. In 1266 he broke out again in revolt on his own estates in Derbyshire, but was utterly defeated at Chesterfield by Henry "of Almain," deprived of his earldom and lands and imprisoned. Eventually, in 1269, he agreed to pay £50,000 for restoration, and to pledge all his lands save Chartley and Holbrook for its payment. As he was not able to find the money, the lands passed to the king's son, Edmund, to whom they had been granted on his forfeiture.

The earl's son John succeeded to Chartley, a Staffordshire estate long famous for the wild cattle in its chase, and was summoned as a baron in 1299, though he had joined the baronial opposition in 1297. On the death, in 1450, of the last Ferrers lord of Chartley, the barony passed with his daughter to the Devereux family and then to the Shirleys, one of whom was created Earl Ferrers in 1711. The barony has been in abeyance since 1855.

The line of Ferrers of Groby was founded by William, younger brother of the last earl, who inherited from his mother Margaret de Quinci her estate of Groby in Leicestershire, and some Ferrers manors from his father. His son was summoned as a baron in 1300, but on the death of his descendant, William, Lord Ferrers of Groby, in 1445, the barony passed with his granddaughter to the Grey family and was forfeited with the dukedom of Suffolk in 1554. A younger son of William, the last lord, married the heiress of Tamworth Castle, and his line was seated at Tamworth till 1680, when an heiress carried it to a son of the first Earl Ferrers. From Sir Henry, a younger son of the first Ferrers of Tamworth, descended Ferrers of Badesley Clinton, seated there in the male line till towards the end of the 19th century. The line of Ferrers of Wemme was founded by a younger son of Lord Ferrers of Chartley, who married the heiress of Wemme, Co. Salop, and was summoned as a baron in her right; but it

ended with their son. There are doubtless male descendants of this great Norman house still in existence.

Higham Ferrers, Northants, and Woodham Ferrers, Essex, take their names from this family. It has been alleged that they bore horseshoes for their arms in allusion to Ferrières (*i.e.* iron-works); but when and why they were added to their coat is a moot point.

See Dugdale's *Baronage*; J. R. Planché's *The Conqueror and his Companions*; G. E. C(okayne)'s *Complete Peerage*; *Chronicles and Memorials* (Rolls Series); T. Stapleton's *Rotuli Scaccarii Normannie.* (J. H. R.)

FERRERS, LAURENCE SHIRLEY, 4TH EARL (1720-1760), the last nobleman in England to suffer a felon's death, was born on the 18th of August 1720. There was insanity in his family, and from an early age his behaviour seems to have been eccentric, and his temper violent, though he was quite capable of managing his business affairs. In 1758 his wife obtained a separation from him for cruelty. The Ferrers estates were then vested in trustees, the Earl Ferrers secured the appointment of an old family steward, Johnson, as receiver of rents. This man faithfully performed his duty as a servant to the trustees, and did not prove amenable to Ferrer's personal wishes. On the 18th of January 1760, Johnson called at the earl's mansion at Staunton Harold, Leicestershire, by appointment, and was directed to his lordship's study. Here, after some business conversation, Lord Ferrers shot him. In the following April Ferrers was tried for murder by his peers in Westminster Hall. His defence, which he conducted in person with great ability, was a plea of insanity, and it was supported by considerable evidence, but he was found guilty. He subsequently said that he had only pleaded insanity to oblige his family, and that he had himself always been ashamed of such a defence. On the 5th of May 1760, dressed in a light-coloured suit, embroidered with silver, he was taken in his own carriage from the Tower of London to Tyburn and there hanged. It has been said that as a concession to his order the rope used was of silk.

See Peter Burke, *Celebrated Trials connected with the Aristocracy in the Relations of Private Life* (London, 1849); Edward Walford, *Tales of our Great Families* (London, 1877); *Howell's State Trials* (1816), xix. 885-980.

FERRET, a domesticated, and frequently albino breed of quadruped, derived from the wild polecat (*Putorius foetidus*, or *P. putorius*), which it closely resembles in size, form, and habits, and with which it interbreeds. It differs in the colour of its fur, which is usually yellowish-white, and of its eyes, which are pinky-red. The "polecat-ferret" is a brown breed, apparently the product of the above-mentioned cross. The ferret attains a length of about 14 in., exclusive of the tail, which measures 5 in. Although exhibiting considerable tameness, it seems incapable of attachment, and when not properly fed, or when irritated, is apt to give painful evidence of its ferocity. It is chiefly employed in destroying rats and other vermin, and in driving rabbits from their burrows. The ferret is remarkably prolific, the female bringing forth two broods annually, each numbering from six to nine young. It is said to occasionally devour its young immediately after birth, and in this case produces another brood soon after. The ferret was well known to the Romans, Strabo stating that it was brought from Africa into Spain, and Pliny that it was employed in his time in rabbit-hunting, under the name *Viverra*; the English name is not derived from this, but from Fr. *ferret*, Late Lat. *furo*, robber. The date of its introduction into Great Britain is uncertain, but it has been known in England for at least 600 years.

The ferret should be kept in dry, clean, well-ventilated hutches, and fed twice daily on bread, milk, and meat, such as rabbits' and fowls' livers. When used to hunt rabbits it is provided with a muzzle, or, better and more usual, a cope, made by looping and knotting twine about the head and snout, in order to prevent it killing its quarry, in which case it would gorge itself and go to sleep in the hole. As the ferret enters the hole the rabbits flee before it, and are shot or caught by dogs as they break ground. A ferret's hold on its quarry is as obstinate as that of a bulldog, but can easily be broken by a strong pressure of

the thumb just above the eyes. Only full-grown ferrets are "worked to" rats. Several are generally used at a time and without copes, as rats are fierce fighters.

See *Ferrets*, by Nicholas Everitt (London, 1897).

FERRI, CIRO (1634-1689), Roman painter, the chief disciple and successor of Pietro da Cortona. He was born in the Roman territory, studied under Pietro, to whom he became warmly attached, and, at an age a little past thirty, completed the painting of the ceilings and other internal decorations begun by his instructor in the Pitti palace, Florence. He also co-operated in or finished several other works by Pietro, both in Florence and in Rome, approaching near to his style and his particular merits, but with less grace of design and native vigour, and in especial falling short of him in colour. Of his own independent productions, the chief is an extensive series of scriptural frescoes in the church of S. Maria Maggiore in Bergamo; also a painting (rated as Ferri's best work) of St Ambrose healing a sick person, the principal altarpiece in the church of S. Ambrogio della Massima in Rome. The paintings of the cupola of S. Agnese in the same capital might rank even higher than these; but this labour remained uncompleted at the death of Ferri, and was marred by the performances of his successor Corbellini. He executed also a large amount of miscellaneous designs, such as etchings and frontispieces for books; and he was an architect besides. Ferri was appointed to direct the Florentine students in Rome, and Gabbiani was one of his leading pupils. As regards style, Ferri ranks as chief of the so-called Machinists, as opposed to the school founded by Sacchi, and continued by Carlo Maratta. He died in Rome—his end being hastened, as it is said, by mortification at his recognized inferiority to Bacciccia in colour.

FERRI, LUIGI (1826-1895), Italian philosopher, was born at Bologna on the 15th of June 1826. His education was obtained mainly at the École Normale in Paris, where his father, a painter and architect, was engaged in the construction of the Théâtre Italien. From his twenty-fifth year he began to lecture in the colleges of Evreux, Dieppe, Blois and Toulouse. Later, he was lecturer at Annecy and Casal-Montferrat, and became head of the education department under Mamiani in 1860. Three years later he was appointed to the chair of philosophy at the Istituto di Perfezionamento at Florence, and, in 1871, was made professor of philosophy in the university of Rome. On the death of Mamiani in 1885 he became editor of the *Filosofia delle scuole italiane*, the title of which he changed to *Rivista italiana di filosofia*. He wrote both on psychology and on metaphysics, but is known especially as a historian of philosophy. His original work is eclectic, combining the psychology of his teachers, Jules Simon, Saisset and Mamiani, with the idealism of Rosmini and Gioberti. Among his works may be mentioned *Studi sulla coscienza*; *Il Fenomeno nelle sue relazioni con la sensazione*; *Della idea del vero*; *Della filosofia del diritto presso Aristotile* (1885); *Il Genio di Aristotile*; *La Psicologia di Pietro Pomponazzi* (1877), and, most important, *Essai sur l'histoire de la philosophie en Italie au XIX^e siècle* (Paris, 1869), and *La Psychologie de l'association depuis Hobbes jusqu'à nos jours*.

FERRIER, ARNAUD DU (c. 1508-1585), French juriconsult and diplomatist, was born at Toulouse about 1508, and practised as a lawyer first at Bourges, afterwards at Toulouse. Councillor to the *parlement* of the latter town, and then to that of Rennes, he later became president of the *parlement* of Paris. He represented Charles IX., king of France, at the council of Trent in 1562, but had to retire in consequence of the attitude he had adopted, and was sent as ambassador to Venice, where he remained till 1567, returning again in 1570. On his return to France he came into touch with the Calvinists whose tenets he probably embraced, and consequently lost his place in the privy council and part of his fortune. As compensation, Henry, king of Navarre, appointed him his chancellor. He died in the end of October 1585.

See also E. Frémy, *Un Ambassadeur libéral sous Charles IX et Henri III, Arnaud du Ferrier* (Paris, 1880).

FERRIER, JAMES FREDERICK (1808-1864), Scottish metaphysical writer, was born in Edinburgh on the 16th of

June 1808, the son of John Ferrier, writer to the signet. His mother was a sister of John Wilson (Christopher North). He was educated at the university of Edinburgh and Magdalen College, Oxford, and subsequently, his metaphysical tastes having been fostered by his intimate friend, Sir William Hamilton, spent some time at Heidelberg studying German philosophy. In 1842 he was appointed professor of civil history in Edinburgh University, and in 1845 professor of moral philosophy and political economy at St Andrews. He was twice an unsuccessful candidate for chairs in Edinburgh, for that of moral philosophy on Wilson's resignation in 1852, and for that of logic and metaphysics in 1856, after Hamilton's death. He remained at St Andrews till his death on the 11th of June 1864. He married his cousin, Margaret Anne, daughter of John Wilson. He had five children, one of whom became the wife of Sir Alexander Grant.

Ferrier's first contribution to metaphysics was a series of articles in *Blackwood's Magazine* (1838-1839), entitled *An Introduction to the Philosophy of Consciousness*. In these he condemns previous philosophers for ignoring in their psychological investigations the fact of consciousness, which is the distinctive feature of man, and confining their observation to the so-called "states of the mind." Consciousness comes into manifestation only when the man has used the word "I" with full knowledge of what it means. This notion he must originate within himself. Consciousness cannot spring from the states which are its object, for it is in antagonism to them. It originates in the will, which in the act of consciousness puts the "I" in the place of our sensations. Morality, conscience, and responsibility are necessary results of consciousness. These articles were succeeded by a number of others, of which the most important were *The Crisis of Modern Speculation* (1841), *Berkeley and Idealism* (1842), and an important examination of Hamilton's edition of Reid (1847), which contains a vigorous attack on the philosophy of common sense. The perception of matter is pronounced to be the *ne plus ultra* of thought, and Reid, for presuming to analyse it, is declared to be a representationist in fact, although he professed to be an intuitionist. A distinction is made between the "perception of matter" and "our apprehension of the perception of matter." Psychology vainly tries to analyse the former. Metaphysics shows the latter alone to be analysable, and separates the subjective element, "our apprehension," from the objective element, "the perception of matter,"—not matter *per se*, but the perception of matter is the existence independent of the individual's thought. It cannot, however, be independent of thought. It must belong to some mind, and is therefore the property of the Divine Mind. There, he thinks, is an indestructible foundation for the *a priori* argument for the existence of God.

Ferrier's matured philosophical doctrines find expression in the *Institutes of Metaphysics* (1854), in which he claims to have met the twofold obligation resting on every system of philosophy, that it should be reasoned and true. His method is that of Spinoza, strict demonstration, or at least an attempt at it. All the errors of natural thinking and psychology must fall under one or other of three topics:—Knowing and the Known, Ignorance, and Being. These are all-comprehensive, and are therefore the departments into which philosophy is divided, for the sole end of philosophy is to correct the inadvertencies of ordinary thinking.

The problems of knowing and the known are treated in the "Epistemology or Theory of Knowing." The truth that "along with whatever any intelligence knows it must, as the ground or condition of its knowledge, have some cognizance of itself," is the basis of the whole philosophical system. Object+subject, thing+me, is the only possible knowable. This leads to the conclusion that the only independent universe which any mind can think of is the universe in synthesis with some *other* mind or *ego*.

The leading contradiction which is corrected in the "Agnology or Theory of Ignorance" is this: that there can be an ignorance of that of which there can be no knowledge. Ignorance is a defect. But there is no defect in not knowing what cannot

be known by any intelligence (e.g. that two and two make five), and therefore there can be an ignorance only of that of which there can be a knowledge, *i.e.* of some-object-plus-some-subject. The knowable alone is the ignorable. Ferrier lays special claim to originality for this division of the *Institutes*.

The "Ontology or Theory of Being" forms the third and final division. It contains a discussion of the origin of knowledge, in which Ferrier traces all the perplexities and errors of philosophers to the assumption of the absolute existence of matter. The conclusion arrived at is that the only true real and independent existences are minds-together-with-that-which-they-apprehend, and that the one strictly necessary absolute existence is a supreme and infinite and everlasting mind in synthesis with all things.

Ferrier's works are remarkable for an unusual charm and simplicity of style. These qualities are especially noticeable in the *Lectures on Greek Philosophy*, one of the best introductions on the subject in the English language. A complete edition of his philosophical writings was published in 1875, with a memoir by E. L. Lushington; see also monograph by E. S. Haldane in the Famous Scots Series.

FERRIER, PAUL (1843-), French dramatist, was born at Montpellier on the 29th of March 1843. He had already produced several comedies when in 1873 he secured real success with two short pieces, *Chez l'avocat* and *Les Incendies de Massouillard*. Others of his numerous plays are *Les Compensations* (1876); *L'Art de tromper les femmes* (1890), with M. Najac. One of Ferrier's greatest triumphs was the production with Fabrice Carré of *Joséphine vendue par ses sœurs* (1886), an *opéra bouffe* with music by Victor Roger. His opera libretti include *La Marocaine* (1879), music of J. Offenbach; *Le Chevalier d'Harmental* (1896) after the play of Dumas père, for the music of A. Messager; *La Fille de Tabarin* (1901), with Victorien Sardou, music of Gabriel Pierné.

FERRIER, SUSAN EDMONSTONE (1782-1854), Scottish novelist, born in Edinburgh on the 7th of September 1782, was the daughter of James Ferrier, for some years factor to the duke of Argyll, and at one time one of the clerks of the court of session with Sir Walter Scott. Her mother was a Miss Coutts, the beautiful daughter of a Forfarshire farmer. James Frederick Ferrier, noticed above, was Susan Ferrier's nephew.

Miss Ferrier's first novel, *Marriage*, was begun in concert with a friend, Miss Clavering, a niece of the duke of Argyll; but this lady only wrote a few pages, and *Marriage*, completed by Miss Ferrier as early as 1810, appeared in 1818. It was followed in 1824 by *The Inheritance*, a better constructed and more mature work; and the last and perhaps best of her novels, *Destiny*, dedicated to Sir Walter Scott (who himself undertook to strike the bargain with the publisher Cadell), appeared in 1831. All these novels were published anonymously; but, with their clever portraiture of contemporary Scottish life and manners, and even recognizable caricatures of some social celebrities of the day, they could not fail to become popular north of the Tweed. "Lady MacLaughlan" represents Mrs Seymour Damer in dress and Lady Frederick Campbell, whose husband, Lord Ferrier, was executed in 1760, in manners. Mary, Lady Clark, well known in Edinburgh, figured as "Mrs Fox" and the three maiden aunts were the Misses Edmonstone. Many were the conjectures as to the authorship of the novels. In the *Noctes Ambrosianae* (November 1826), James Hogg is made to mention *The Inheritance*, and adds, "which I aye thought was written by Sir Walter, as weel's *Marriage*, till it spunked out that it was written by a ledly." Scott himself gave Miss Ferrier a very high place indeed among the novelists of the day. In his diary (March 27, 1826), criticizing a new work which he had been reading, he says, "The women do this better. Edgeworth, Ferrier, Austen, have all given portraits of real society far superior to anything man, vain man, has produced of the like nature." Another friendly recognition of Miss Ferrier is to be found at the conclusion of his *Tales of my Landlord*, where Scott calls her his "sister shadow," the still anonymous author of "the very lively work entitled *Marriage*." Lively, indeed, all Miss Ferrier's works are,—written in clear, brisk English, and

with an inexhaustible fund of humour. It is true her books portray the eccentricities, the follies, and foibles of the society in which she lived, caricaturing with terrible exactness its hypocrisy, boastfulness, greed, affectation, and undue subservience to public opinion. Yet Miss Ferrier wrote less to reform than to amuse. In this she is less like Miss Edgeworth than Miss Austen. Miss Edgeworth was more of a moralist; her wit is not so involuntary, her caricatures not always so good-natured. But Miss Austen and Miss Ferrier were genuine humorists, and with Miss Ferrier especially a keen sense of the ludicrous was always dominant. Her humorous characters are always her best. It was no doubt because she felt this that in the last year of her life she regretted not having devoted her talents more exclusively to the service of religion. But if she was not a moralist, neither was she a cynic; and her wit, even where it is most caustic, is never uncharitable.

Miss Ferrier's mother died in 1797, and from that date she kept house for her father until his death in 1829. She lived quietly at Morningside House and in Edinburgh for more than twenty years after the publication of her last work. The pleasantest picture that we have of her is in Lockhart's description of her visit to Scott in May 1831. She was asked there to help to amuse the dying master of Abbotsford, who, when he was not writing *Count Robert of Paris*, would talk as brilliantly as ever. Only sometimes, before he had reached the point in a narrative, "it would seem as if some internal spring had given way." He would pause, and gaze blankly and anxiously round him. "I noticed," says Lockhart, "the delicacy of Miss Ferrier on such occasions. Her sight was bad, and she took care not to use her glasses when he was speaking; and she affected to be also troubled with deafness, and would say, 'Well, I am getting as dull as a post; I have not heard a word since you said so-and-so,'—being sure to mention a circumstance behind that at which he had really halted. He then took up the thread with his habitual smile of courtesy—as if forgetting his case entirely in the consideration of the lady's infirmity."

Miss Ferrier died on the 5th of November 1854, at her brother's house in Edinburgh. She left among her papers a short unpublished article, entitled "Recollections of Visits to Ashestiel and Abbotsford." This is her own very interesting account of her long friendship with Sir Walter Scott, from the date of her first visit to him and Lady Scott at Ashestiel, where she went with her father in the autumn of 1811, to her last sad visit to Abbotsford in 1831. It contains some impromptu verses written by Scott in her album at Ashestiel.

Miss Ferrier's letters to her sister, which contained much interesting biographical matter, were destroyed at her particular request, but a volume of her correspondence with a memoir by her grand-nephew, John Ferrier, was published in 1898.

FERROL [*El Ferrol*], a seaport of north-western Spain, in the province of Corunna; situated 12 m. N.E. of the city of Corunna, and on the Bay of Ferrol, an inlet of the Atlantic Ocean. Pop. (1900) 25,281. Together with San Fernando, near Cadiz, and Cartagena, Ferrol is governed by an admiral, with the special title of captain-general; and it ranks beside these two ports as one of the principal naval stations of Spain. The town is beautifully situated on a headland overlooking the bay, and is surrounded by rocky hills which render it invisible from the sea. Its harbour, naturally one of the best in Europe, and the largest in Spain except those of Vigo and Corunna, is deep, capacious and secure; but the entrance is a narrow strait about 2 m. long, which admits only one vessel at a time, and is commanded by modern and powerfully armed forts, while the neighbouring heights are also crowned by defensive works. Ferrol is provided with extensive dockyards, quays, warehouses and an arsenal; most of these, with the palace of the captain-general, the bull-ring, theatres, and other principal buildings, were built or modernized between 1875 and 1905. The local industries are mainly connected with the shipping trade, or the refitting of warships. Owing to the lack of railway communication, and the competition of Corunna at so short a distance, Ferrol is not a first-class commercial port; and in the early years of the 20th century its trade, already injured by the loss to Spain of Cuba.

and Porto Rico in 1898, showed little prospect of improvement. The exports are insignificant, and consist chiefly of wooden staves and beams for use as pit-props; the chief imports are coal, cement, timber, iron and machinery. In 1904, 282 vessels of 155,881 tons entered the harbour. In the same year the construction of a railway to the neighbouring town of Betanzos was undertaken, and in 1909 important shipbuilding operations were begun.

Ferrol was a mere fishing village until 1752, when Ferdinand VI. began to fit it for becoming an arsenal. In 1799 the British made a fruitless attempt to capture it, but on the 4th of November 1805 they defeated the French fleet in front of the town, which they compelled to surrender. On the 27th of January 1809 it was through treachery delivered over to the French, but it was vacated by them on the 22nd of July. On the 15th of July 1823 another blockade was begun by the French, and Ferrol surrendered to them on the 27th of August.

FERRUCCIO, or **FERRUCCI**, **FRANCESCO** (1489-1530), Florentine captain. After spending a few years as a merchant's clerk he took to soldiering at an early age, and served in the *Bande Nere* in various parts of Italy, earning a reputation as a daring fighter and somewhat of a swashbuckler. When Pope Clement VII. and the emperor Charles V. decided to reinstate the Medici in Florence, they made war on the Florentine republic, and Ferruccio was appointed Florentine military commissioner at Empoli, where he showed great daring and resource by his rapid marches and sudden attacks on the Imperialists. Early in 1530 Volterra had thrown off Florentine allegiance and had been occupied by an Imperialist garrison, but Ferruccio surprised and recaptured the city. During his absence, however, the Imperialists captured Empoli by treachery, thus cutting off one of the chief avenues of approach to Florence. Ferruccio proposed to the government of the republic that he should march on Rome and terrorize the pope by the threat of a sack into making peace with Florence on favourable terms, but although the war committee appointed him commissioner-general for the operations outside the city, they rejected his scheme as too audacious. Ferruccio then decided to attempt a diversion by attacking the Imperialists in the rear and started from Volterra for the Apennines. But at Pisa he was laid up for a month with a fever—a misfortune which enabled the enemy to get wind of his plan and to prepare for his attack. At the end of July Ferruccio left Pisa at the head of about 4000 men, and although the besieged in Florence, knowing that a large part of the Imperialists under the prince of Orange had gone to meet Ferruccio, wished to co-operate with the latter by means of a sortie, they were prevented from doing so by their own traitorous commander-in-chief, Malatesta Baglioni. Ferruccio encountered a much larger force of the enemy on the 3rd of August at Gavinana; a desperate battle ensued, and at first the Imperialists were driven back by Ferruccio's fierce onslaught and the prince of Orange himself was killed, but reinforcements under Fabrizio Maramaldo having arrived, the Florentines were almost annihilated and Ferruccio was wounded and captured. Maramaldo out of personal spite despatched the wounded man with his own hand. This defeat sealed the fate of the republic, and nine days later Florence surrendered. Ferruccio was one of the great soldiers of the age, and his enterprise is the finest episode of the last days of the Florentine republic. See also under FLORENCE and MEDICI.

BIBLIOGRAPHY.—F. Sasseti, *Vita di Francesco Ferrucci*, written in the 16th century and published in the *Archivio storico*, vol. iv. pt. ii. (Florence, 1853), with an introduction by C. Monzani; E. Aloisi, *La Battaglia di Gavinana* (Bologna, 1881); cf. P. Villari's criticism of the latter work, "Ferruccio e Maramaldo," in his *Arte, storia, e filosofia* (Florence, 1884); Gino Capponi, *Storia della repubblica di Firenze*, vol. ii. (Florence, 1875).

FERRULE, a small metal cap or ring used for holding parts of a rod, &c., together, and for giving strength to weakened materials, or especially, when attached to the end of a stick, umbrella, &c., for preventing wearing or splitting. The word is properly *verrel* or *verril*, in which form it was used till the 18th century, and is derived through the O. Fr. *virelle*, modern

virole, from a Latin diminutive *viriola* of *viriae*, bracelets. The form in which the word is now known is due to the influence of Latin *ferrum*, iron. "Ferrule" must be distinguished from "ferule" or "ferula," properly the Latin name of the "giant fennel." From the use of the stalk of this plant as a cane or rod for punishment, comes the application of the word to many instruments used in chastisement, more particularly a short flat piece of wood or leather shaped somewhat like the sole of a boot, and applied to the palms of the hand. It is the common form of disciplinary instrument in Roman Catholic schools; the pain inflicted is exceedingly sharp and immediate, but the effects are momentary and leave no chance for any dangerous results. The word is sometimes applied to the ordinary cane as used by schoolmasters.

FERRY, JULES FRANÇOIS CAMILLE (1832-1893), French statesman, was born at Saint Dié (Vosges) on the 5th of April 1832. He studied law, and was called to the bar at Paris, but soon went into politics, contributing to various newspapers, particularly to the *Temps*. He attacked the Empire with great violence, directing his opposition especially against Baron Haussmann, prefect of the Seine. Elected republican deputy for Paris in 1869, he protested against the declaration of war with Germany, and on the 6th of September 1870 was appointed prefect of the Seine by the government of national defence. In this position he had the difficult task of administering Paris during the siege, and after the Commune was obliged to resign (5th of June 1871). From 1872-1873 he was sent by Thiers as minister to Athens, but returned to the chamber as deputy for the Vosges, and became one of the leaders of the republican party. When the first republican ministry was formed under W. H. Waddington on the 4th of February 1879, he was one of its members, and continued in the ministry until the 30th of March 1885, except for two short interruptions (from the 10th of November 1881 to the 30th of January 1882, and from the 29th of July 1882 to the 21st of February 1883), first as minister of education and then as minister of foreign affairs. He was twice premier (1880-1881 and 1883-1885). Two important works are associated with his administration, the non-clerical organization of public education, and the beginning of the colonial expansion of France. Following the republican programme he proposed to destroy the influence of the clergy in the university. He reorganized the committee of public education (law of the 27th of February 1880), and proposed a regulation for the conferring of university degrees, which, though rejected, aroused violent polemics because the 7th article took away from the unauthorized religious orders the right to teach. He finally succeeded in passing the great law of the 28th of March 1882, which made primary education in France free, non-clerical and obligatory. In higher education the number of professors doubled under his ministry. After the military defeat of France by Germany in 1870, he formed the idea of acquiring a great colonial empire, not to colonize it, but for the sake of economic exploitation. He directed the negotiations which led to the establishment of a French protectorate in Tunis (1881), prepared the treaty of the 17th of December 1885 for the occupation of Madagascar; directed the exploration of the Congo and of the Niger region; and above all he organized the conquest of Indo-China. The excitement caused at Paris by an unimportant reverse of the French troops at Lang-son caused his downfall (30th of March 1885), but the treaty of peace with China (9th of June 1885) was his work. He still remained an influential member of the moderate republican party, and directed the opposition to General Boulanger. After the resignation of President Grévy (2nd of December 1887), he was a candidate for the presidency of the republic, but the radicals refused to support him, and he withdrew in favour of Sadi Carnot. The violent polemics aroused against him at this time caused a madman to attack him with a revolver, and he died from the wound, on the 17th of March 1893. The chamber of deputies voted him a state funeral.

See Edg. Zévort, *Histoire de la troisième République*; A. Rambaud, *Jules Ferry* (Paris, 1903).

FERRY (from the same root as that of the verb "to fare," to journey or travel, common to Teutonic languages, cf. Ger. *fahren*; it is connected with the root of Gr. *πόρος*, way, and Lat. *portare*, to carry), a place where boats ply regularly across a river or arm of the sea for the conveyance of goods and persons. The word is also applied to the boats employed (ferry boats). In a car-ferry or train-ferry railway cars or complete trains are conveyed across a piece of water in vessels which have railway lines laid on their decks, so that the vehicles run on and off them on their own wheels. In law the right of ferrying persons or goods across a particular river or strait, and of exacting a reasonable toll for the service, belongs, like the right of fair and market, to the class of rights known as franchises. Its origin must be by statute, royal grant, or prescription. It is wholly unconnected with the ownership or occupation of land, so that the owner of the ferry need not be proprietor of the soil on either side of the water over which the right is exercised. He is bound to maintain safe and suitable boats ready for the use of the public, and to employ fit persons as ferrymen. As a correlative of this duty he has a right of action, not only against those who evade or refuse payment of toll when it is due, but also against those who disturb his franchise by setting up a new ferry, so as to diminish his custom, unless a change of circumstances, such as an increase of population near the ferry, justify other means of passage, whether of the same kind or not. See also **WATER RIGHTS**.

FERSEN, FREDRIK AXEL, COUNT VON (1719-1794), Swedish politician, was a son of Lieutenant-General Hans Reinhold Fersen and entered the Swedish Life Guards in 1740, and from 1743 to 1748 was in the French service (*Royal-Suédois*), where he rose to the rank of brigadier. In the Seven Years' War Fersen distinguished himself during the operations round Usedom and Wollin (1759), when he inflicted serious loss on the Prussians. But it is as a politician that he is best known. At the diet of 1755-1756 he was elected *landtmarskalk*, or marshal of the diet, and from henceforth, till the revolution of 1772, led the Hat party (see **SWEDEN: History**). In 1756 he defeated the projects of the court for increasing the royal power; but, after the disasters of the Seven Years' War, gravitated towards the court again and contributed, by his energy and eloquence, to uphold the tottering Hats for several years. On the accession of the Caps to power in 1766, Fersen assisted the court in its struggle with them by refusing to employ the Guards to keep order in the capital when King Adolphus Frederick, driven to desperation by the demands of the Caps, publicly abdicated, and a seven days' interregnum ensued. At the ensuing diet of 1769, when the Hats returned to power, Fersen was again elected marshal of the diet; but he made no attempt to redeem his pledges to the crown prince Gustavus, as to a very necessary reform of the constitution, which he had made before the elections, and thus involuntarily contributed to the subsequent establishment of absolutism. When Gustavus III. ascended the throne in 1772, and attempted to reconcile the two factions by a composition which aimed at dividing all political power between them, Fersen said he despaired of bringing back, in a moment, to the path of virtue and patriotism a people who had been running riot for more than half a century in the wilderness of political licence and corruption. Nevertheless he consented to open negotiations with the Caps, and was the principal Hat representative on the abortive composition committee. During the revolution of August 1772, Fersen remained a passive spectator of the overthrow of the constitution, and was one of the first whom Gustavus summoned to his side after his triumph. Yet his relations with the king were never cordial. The old party-leader could never forget that he had once been a power in the state, and it is evident, from his *Historiska Skrifter*, how jealous he was of Gustavus's personal qualities. There was a slight collision between them as early as the diet of 1778; but at the diet of 1786 Fersen boldly led the opposition against the king's financial measures (see **GUSTAVUS III.**) which were consequently rejected; while in private interviews, if his own account of them is to be trusted, he addressed his sovereign with

outrageous insolence. At the diet of 1789 Fersen marshalled the nobility around him for a combat *à outrance* against the throne and that, too, at a time when Sweden was involved in two dangerous foreign wars, and national unity was absolutely indispensable. This tactical blunder cost him his popularity and materially assisted the secret operations of the king. Obstruction was Fersen's chief weapon, and he continued to postpone the granting of subsidies by the house of nobles for some weeks. But after frequent stormy scenes in the diet, which were only prevented from becoming *mêlées* by Fersen's moderation, or hesitation, at the critical moment, he and twenty of his friends of the nobility were arrested (17th February 1789) and the opposition collapsed. Fersen was speedily released, but henceforth kept aloof from politics, surviving the king two years. He was a man of great natural talent, with an imposing presence, and he always bore himself like the aristocrat he was. But his haughtiness and love of power are undeniable, and he was perhaps too great a party-leader to be a great statesman. Yet for seventeen years, with very brief intervals, he controlled the destinies of Sweden, and his influence in France was for some time pretty considerable. His *Historiska Skrifter*, which are a record of Swedish history, mainly autobiographical, during the greater part of the 18th century, is excellent as literature, but somewhat unreliable as an historical document, especially in the later parts.

See C. G. Malmström, *Sveriges politiska Historia* (Stockholm, 1855-1865); R. N. Bain, *Gustavus III.* (London, 1895); C. T. Odhner, *Sveriges politiska Historia under Gustaf III.'s Regering* (Stockholm, 1885, &c.); F. A. Fersen, *Historiska Skrifter* (Stockholm, 1867-1872). (R. N. B.)

FERSEN, HANS AXEL, COUNT VON (1755-1810), Swedish statesman, was carefully educated at home, at the Carolinum at Brunswick and at Turin. In 1779 he entered the French military service (*Royal-Bavière*), accompanied General Rochambeau to America as his adjutant, distinguished himself during the war with England, notably at the siege of Yorktown, 1781, and in 1785 was promoted to be *colonel propriétaire* of the regiment *Royal-Suédois*. The young nobleman was, from the first, a prime favourite at the French court, owing, partly to the recollection of his father's devotion to France, but principally because of his own amiable and brilliant qualities. The queen, Marie Antoinette, was especially attracted by the grace and wit of *le beau Fersen*, who had inherited his full share of the striking handsomeness which was hereditary in the family.

It is possible that Fersen would have spent most of his life at Versailles, but for a hint from his own sovereign, then at Pisa, that he desired him to join his suite. He accompanied Gustavus III. in his Italian tour and returned home with him in 1784. When the war with Russia broke out, in 1788, Fersen accompanied his regiment to Finland, but in the autumn of the same year was sent to France, where the political horizon was already darkening. It was necessary for Gustavus to have an agent thoroughly in the confidence of the French royal family, and, at the same time, sufficiently able and audacious to help them in their desperate straits, especially as he had lost all confidence in his accredited minister, the baron de Stael. With his usual acumen, he fixed upon Fersen, who was at his post early in 1790. Before the end of the year he was forced to admit that the cause of the French monarchy was hopeless so long as the king and queen of France were nothing but captives in their own capital, at the mercy of an irresponsible mob. He took a leading part in the flight to Varennes. He found most of the requisite funds at the last moment. He ordered the construction of the famous carriage for six, in the name of the baroness von Korff, and kept it in his hotel grounds, rue Matignon, that all Paris might get accustomed to the sight of it. He was the coachman of the *fiacre* which drove the royal family from the Carrousel to the Porte Saint-Martin. He accompanied them to Bondy, the first stage of their journey.

In August 1791, Fersen was sent to Vienna to induce the emperor Leopold to accede to a new coalition against revolutionary

France, but he soon came to the conclusion that the Austrian court meant to do nothing at all. At his own request, therefore, he was transferred to Brussels, where he could be of more service to the queen of France. In February 1792, at his own mortal peril, he once more succeeded in reaching Paris with counterfeit credentials as minister plenipotentiary to Portugal. On the 13th he arrived, and the same evening contrived to steal an interview with the queen unobserved. On the following day he was with the royal family from six o'clock in the evening till six o'clock the next morning, and convinced himself that a second flight was physically impossible. On the afternoon of the 21st he succeeded in paying a third visit to the Tuileries, stayed there till midnight and succeeded, with great difficulty, in regaining Brussels on the 27th. This perilous expedition, a monumental instance of courage and loyalty, had no substantial result. In 1797 Fersen was sent to the congress of Rastatt as the Swedish delegate, but in consequence of a protest from the French government, was not permitted to take part in it.

During the regency of the duke of Sudermania (1792-1796) Fersen, like all the other Gustavians, was in disgrace; but, on Gustavus IV. attaining his majority in 1796, he was welcomed back to court with open arms, and reinstated in all his offices and dignities. In 1801 he was appointed *Riksmarskalk* (= earl-marshal). On the outbreak of the war with Napoleon, Fersen accompanied Gustavus IV. to Germany to assist him in gaining fresh allies. He prevented Gustavus from invading Prussia in revenge for the refusal of the king of Prussia to declare war against France, and during the rest of the reign was in semi-disgrace, though generally a member of the government when the king was abroad.

Fersen stood quite aloof from the revolution of 1809. (See SWEDEN: *History*.) His sympathies were entirely with Prince Gustavus, son of the unfortunate Gustavus IV., and he was generally credited with the desire to see him king. When the newly elected successor to the throne, the highly popular prince Christian Augustus of Augustenburg, died suddenly in Skåne in May 1810, the report spread that he had been poisoned, and that Fersen and his sister, the countess Piper, were accessories. The source of this equally absurd and infamous libel has never been discovered. But it was eagerly taken up by the anti-Gustavian press, and popular suspicion was especially aroused by a fable called "The Foxes" directed against the Fersens, which appeared in *Nya Posten*. When, then, on the 20th of June 1810, the prince's body was conveyed to Stockholm, and Fersen, in his official capacity as *Riksmarskalk*, received it at the barrier and led the funeral cortège into the city, his fine carriage and his splendid robes seemed to the people an open derision of the general grief. The crowd began to murmur and presently to fling stones and cry "murderer!" He sought refuge in a house in the Riddarhus Square, but the mob rushed after him, brutally maltreated him and tore his robes to pieces. To quiet the people and save the unhappy victim, two officers volunteered to conduct him to the senate house and there place him in arrest. But he had no sooner mounted the steps leading to the entrance than the crowd, which had followed him all the way beating him with sticks and umbrellas, made a rush at him, knocked him down, and kicked and trampled him to death. This horrible outrage, which lasted more than an hour, happened, too, in the presence of numerous troops, drawn up in the Riddarhus Square, who made not the slightest effort to rescue the *Riksmarskalk* from his tormentors. In the circumstances, one must needs adopt the opinion of Fersen's contemporary, Baron Gustavus Armfelt, "One is almost tempted to say that the government wanted to give the people a victim to play with, just as when one throws something to an irritated wild beast to distract its attention. The more I consider it all, the more I am certain that the mob had the least to do with it. . . . But in God's name what were the troops about? How could such a thing happen in broad daylight during a procession, when troops and a military escort were actually present?" The responsibility certainly rests with the government of Charles XIII., which apparently intended to intimidate the Gustavians by the removal of one of

their principal leaders. Armfelt escaped in time, so Fersen fell the victim.

See R. M. Klinckowström, *Le Comte de Fersen et la cour de France* (Paris, 1877; Eng. ed., London, 1902); *Historia om Axel von Fersens mord* (Stockholm, 1844); R. N. Bain, *Gustavus III.*, vol. ii. (London, 1895); P. Gaulot, *Un Ami de la reine* (Paris, 1892); F. F. Flach, *Grefve Hans Axel von Fersen* (Stockholm, 1896); E. Tegner, *Gustaf Mauritz Armfelt*, vol. iii. (Stockholm, 1883-1887). (R. N. B.)

FESCA, FREDERIC ERNEST (1789-1826), German violinist and composer of instrumental music, was born on the 15th of February 1789 at Magdeburg, where he received his early musical education. He completed his studies at Leipzig under Eberhard Müller, and at the early age of fifteen appeared before the public with several concerti for the violin, which were received with general applause, and resulted in his being appointed leading violinist of the Leipzig orchestra. This position he occupied till 1806, when he became concert-master to the duke of Oldenburg. In 1808 he was appointed solo-violinist by King Jerome of Westphalia at Cassel, and there he remained till the end of the French occupation (1814), when he went to Vienna, and soon afterwards to Carlsruhe, having been appointed concert-master to the grand-duke of Baden. His failing health prevented him from enjoying the numerous and well-deserved triumphs he owed to his art, and in 1826 he died of consumption at the early age of thirty-seven. As a virtuoso Fesca ranks amongst the best masters of the German school of violinists, the school subsequently of Spohr and of Joachim. Especially as leader of a quartet he is said to have been unrivalled with regard to classic dignity and simplicity of style. Amongst his compositions, his quartets for stringed instruments and other pieces of chamber music are the most remarkable. His two operas, *Cantemira* and *Omar and Leila*, were less successful, lacking dramatic power and originality. He also wrote some sacred compositions, and numerous songs and vocal quartets.

FESCENNIA, an ancient city of Etruria, which is probably to be placed immediately to the N. of the modern Corchiano, 6 m. N.W. of Civita Castellana (see **FALERII**). The Via Amerina traverses it. G. Dennis (*Cities and Cemeteries of Etruria*, London, 1883, i. 115) proposed to place it at the Riserva S. Silvestro, 3 m. E. of Corchiano, nearer the Tiber, where remains of Etruscan walls exist. At Corchiano itself, however, similar walls may be traced, and the site is a strong and characteristic one—a triangle between two deep ravines, with the third (west) side cut off by a ditch. Here, too, remains of two bridges may be seen, and several rich tombs have been excavated.

See A. Buglione, "Conte di Monale," in *Römische Mittheilungen* (1887), p. 21 seq.

FESCENNINE VERSES (*Fescennina carmina*), one of the earliest kinds of Italian poetry, subsequently developed into the Satura and the Roman comic drama. Originally sung at village harvest-home rejoicings, they made their way into the towns, and became the fashion at religious festivals and private gatherings—especially weddings, to which in later times they were practically restricted. They were usually in the Saturnian metre and took the form of a dialogue, consisting of an interchange of extemporaneous raillery. Those who took part in them wore masks made of the bark of trees. At first harmless and good-humoured, if somewhat coarse, these songs gradually outstripped the bounds of decency; malicious attacks were made upon both gods and men, and the matter became so serious that the law intervened and scurrilous personalities were forbidden by the Twelve Tables (Cicero, *De re publica*, iv. 10). Specimens of the Fescennines used at weddings are the Epithalamium of Manlius (Catullus, lxi. 122) and the four poems of Claudian in honour of the marriage of Honorius and Maria; the first, however, is distinguished by a licentiousness which is absent in the latter. Ausonius in his *Cento nuptialis* mentions the Fescennines of Annianus Faliscus, who lived in the time of Hadrian. Various derivations have been proposed for *Fescennine*. According to Festus, they were introduced from Fescennia in Etruria, but there is no reason to assume that any particular town was specially devoted to the use of such songs. As an alternative Festus suggests a connexion with *fascinum*, either because the

Fescennina were regarded as a protection against evil influences (see Munro, *Criticisms and Elucidations of Catullus*, p. 76) or because *fascinum* (= *phallus*), as the symbol of fertility, would from early times have been naturally associated with harvest festivals. H. Nettleship, in an article on "The Earliest Italian Literature" (*Journal of Philology*, xi. 1882), in support of Munro's view, translates the expression "verses used by charmers," assuming a noun *fescennus*, connected with *fas fari*.

The *locus classicus* in ancient literature is Horace, *Epistles*, ii. 1. 139; see also Virgil, *Georgics*, ii. 385; Tibullus ii. 1. 55; E. Hoffmann, "Die Fescenninen," in *Rheinisches Museum*, li. p. 320 (1896); art. **LATIN LITERATURE**.

FESCH, JOSEPH (1763-1839), cardinal, was born at Ajaccio on the 3rd of January 1763. His father, a Swiss officer in the service of the Genoese Republic, had married the mother of Laetitia Bonaparte, after the decease of her first husband. Fesch therefore stood almost in the relation of an uncle to the young Bonapartes, and after the death of Lucien Bonaparte, archdeacon of Ajaccio, he became for a time the protector and patron of the family. In the year 1789, when the French Revolution broke out, he was archdeacon of Ajaccio, and, like the majority of the Corsicans, he felt repugnance for many of the acts of the French government during that period; in particular he protested against the application to Corsica of the act known as the "Civil Constitution of the Clergy" (July 1790). As provost of the "chapter" in that city he directly felt the pressure of events; for on the suppression of religious orders and corporations, he was constrained to retire into private life.

Thereafter he shared the fortunes of the Bonaparte family in the intrigues and strifes which ensued. Drawn gradually by that family into espousing the French cause against Paoli and the Anglophiles, he was forced to leave Corsica and to proceed with Laetitia and her son to Toulon, in the early part of the autumn of 1793. Failing to find clerical duties at that time (the period of the Terror), he entered civil life, and served in various capacities, until on the appointment of Napoleon Bonaparte to the command of the French "Army of Italy" he became a commissary attached to that army. This part of his career is obscure and without importance. His fortunes rose rapidly on the attainment of the dignity of First Consul by his former charge, Napoleon, after the *coup d'état* of Brumaire (November 1799). Thereafter, when the restoration of the Roman Catholic religion was in the mind of the First Consul, Fesch resumed his clerical vocation and took an active part in the complex negotiations which led to the signing of the Concordat with the Holy See on the 15th of July 1801. His reward came in the prize of the archbishopric of Lyons, on the duties of which he entered in August 1802. Six months later he received a still more signal reward for his past services, being raised to the dignity of cardinal.

In 1804 on the retirement of Cacault from the position of French ambassador at Rome, Fesch received that important appointment. He was assisted by Châteaubriand, but soon sharply differed with him on many questions. Towards the close of the year 1804 Napoleon entrusted to Fesch the difficult task of securing the presence of Pope Pius VII. at the forthcoming coronation of the emperor at Notre Dame, Paris (Dec. 2nd, 1804). His tact in overcoming the reluctance of the pope to be present at the coronation (it was only eight months after the execution of the duc d'Enghien) received further recognition. He received the grand cordon of the Legion of Honour, became grand-almoner of the empire and had a seat in the French senate. He was to receive further honours. In 1806 one of the most influential of the German clerics, Karl von Dalberg, then prince bishop of Regensburg, chose him to be his coadjutor and designated him as his successor.

Events, however, now occurred which overclouded his prospects. In the course of the years 1806-1807 Napoleon came into sharp collision with the pope on various matters both political and religious. Fesch sought in vain to reconcile the two potentates. Napoleon was inexorable in his demands, and Pius VII. refused to give way where the discipline and

vital interests of the church seemed to be threatened. The emperor on several occasions sharply rebuked Fesch for what he thought to be weakness and ingratitude. It is clear, however, that the cardinal went as far as possible in counselling the submission of the spiritual to the civil power. For a time he was not on speaking terms with the pope; and Napoleon recalled him from Rome.

Affairs came to a crisis in the year 1809, when Napoleon issued at Vienna the decree of the 17th of May, ordering the annexation of the papal states to the French empire. In that year Napoleon conferred on Fesch the archbishopric of Paris, but he refused the honour. He, however, consented to take part in an ecclesiastical commission formed by the emperor from among the dignitaries of the Gallican Church, but in 1810 the commission was dissolved. The hopes of Fesch with respect to Regensburg were also damped by an arrangement of the year 1810 whereby Regensburg was absorbed in Bavaria.

In the year 1811 the emperor convoked a national council of Gallican clerics for the discussion of church affairs, and Fesch was appointed to preside over their deliberations. Here again, however, he failed to satisfy the inflexible emperor and was dismissed to his diocese. The friction between uncle and nephew became more acute in the following year. In June 1812, Pius VII. was brought from his first place of detention, Savona, to Fontainebleau, where he was kept under surveillance in the hope that he would give way in certain matters relating to the Concordat and in other clerical affairs. Fesch ventured to write to the aged pontiff a letter which came into the hands of the emperor. His anger against Fesch was such that he stopped the sum of 150,000 florins which had been accorded to him. The disasters of the years 1812-1813 brought Napoleon to treat Pius VII. with more lenity and the position of Fesch thus became for a time less difficult. On the first abdication of Napoleon (April 11th, 1814) and the restoration of the Bourbons, he, however, retired to Rome where he received a welcome. The events of the Hundred Days (March-June, 1815) brought him back to France; he resumed his archiepiscopal duties at Lyons and was further named a member of the senate. On the second abdication of the emperor (June 22nd, 1815) Fesch retired to Rome, where he spent the rest of his days in dignified ease, surrounded by numerous masterpieces of art, many of which he bequeathed to the city of Lyons. He died at Rome on the 13th of May 1839.

See J. B. Monseigneur Lyonnet, *Le Cardinal Fesch* (2 vols., Lyons, 1841); Ricard, *Le Cardinal Fesch* (Paris, 1893); H. Welschinger, *Le Pape et l'empereur* (Paris, 1905); F. Masson, *Napoléon et sa famille* (4 vols., Paris, 1897-1900).

FESSA, a town and district of Persia in the province of Fars. The town is situated in a fertile plain in 29° N. and 90 m. from Shiraz, and has a population of about 5000. The district has forty villages and extends about 40 m. north-south from Runiz to Nassirabad and 16 m. east-west from Vasilabad to Deh Dasteh (Dastajah); it produces much grain, dates, tobacco, opium and good fruit.

FESSENDEN, WILLIAM PITT (1806-1869), American statesman and financier, was born in Boscawen, New Hampshire, on the 16th of October 1806. After graduating at Bowdoin College in 1823, he studied law, and in 1827 was admitted to the bar, eventually settling in Portland, Maine, where for two years he was associated in practice with his father, Samuel Fessenden (1784-1869), a prominent lawyer and anti-slavery leader. In 1832 and in 1840 Fessenden was a representative in the Maine legislature, and in 1841-1843 was a Whig member of the national House of Representatives. When his term in this capacity was over, he devoted himself unremittingly and with great success to the law. He became well known, also, as an eloquent advocate of slavery restriction. In 1845-1846 and 1853-1854 he again served in the state House of Representatives, and in 1854 was chosen by the combined votes of Whigs and Anti-Slavery Democrats to the United States Senate. Within a fortnight after taking his seat he delivered a speech in opposition to the Kansas-Nebraska Bill, which at once

made him a force in the congressional anti-slavery contest. From then on he was one of the most eloquent and frequent debaters among his colleagues, and in 1859, almost without opposition, he was re-elected to the Senate as a member of the Republican party, in the organization of which he had taken an influential part. He was a delegate in 1861 to the Peace Congress, but after the actual outbreak of hostilities he insisted that the war should be prosecuted vigorously. As chairman of the Senate Committee on Finance, his services were second in value only to those of President Lincoln and Secretary Salmon P. Chase in efforts to provide funds for the defence of the Union; and in July 1864 Fessenden succeeded Chase as secretary of the treasury. The finances of the country in the early summer of 1864 were in a critical condition; a few days before leaving office Secretary Chase had been compelled to withdraw from the market \$32,000,000 of 6% bonds, on account of the lack of acceptable bids; gold had reached 285 and was fluctuating between 225 and 250, while the value of the paper dollar had sunk as low as 34 cents. It was Secretary Fessenden's policy to avoid a further increase of the circulating medium, and to redeem or consolidate the temporary obligations outstanding. In spite of powerful pressure the paper currency was not increased a dollar during his tenure of the office. As the sales of bonds and treasury notes were not sufficient for the needs of the Treasury, interest-bearing certificates of indebtedness were issued to cover the deficits; but when these began to depreciate the secretary, following the example of his predecessors, engaged the services of the Philadelphia banker Jay Cooke (*q.v.*) and secured the consent of Congress to raise the balance of the \$400,000,000 loan authorized on the 30th of June 1864 by the sale of the so-called "seven-thirty" treasury notes (*i.e.* notes bearing interest at 7.3% payable in currency in three years or convertible at the option of the holder into 6% 5-20 year gold bonds). Through Cooke's activities the sales became enormous; the notes, issued in denominations as low as \$50, appealed to the patriotic impulses of the people who could not subscribe for bonds of a higher denomination. In the spring of 1865 Congress authorized an additional loan of \$600,000,000 to be raised in the same manner, and for the first time in four years the Treasury was able to meet all its obligations. After thus securing ample funds for the enormous expenditures of the war, Fessenden resigned the treasury portfolio in March 1865, and again took his seat in the Senate, serving till his death. In the Senate he again became chairman of the finance committee, and also of the joint committee on reconstruction. He was the author of the report of this last committee (1866), in which the Congressional plan of reconstruction was set forth and which has been considered a state paper of remarkable power and cogency. He was not, however, entirely in accord with the more radical members of his own party, and this difference was exemplified in his opposition to the impeachment of President Johnson and subsequently in his voting for Johnson's acquittal. He bore with calmness the storm of reproach from his party associates which followed, and lived to regain the esteem of those who had attacked him. He died at Portland, Maine, on the 6th of September 1869.

See Francis Fessenden, *Life and Public Services of William Pitt Fessenden* (2 vols., Boston, 1907).

FESSLER, IGNAZ AURELIUS (1756-1839), Hungarian ecclesiastic, historian and freemason, was born on the 18th of May 1756 at the village of Zurány in the county of Moson. In 1773 he joined the order of Capuchins, and in 1779 was ordained priest. He had meanwhile continued his classical and philological studies, and his liberal views brought him into frequent conflict with his superiors. In 1784, while at the monastery of Mödling, near Vienna, he wrote to the emperor Joseph II., making suggestions for the better education of the clergy and drawing his attention to the irregularities of the monasteries. The searching investigation which followed raised up against him many implacable enemies. In 1784 he was appointed professor of Oriental languages and hermeneutics in the university of Lemberg, when he took the degree of doctor

of divinity; and shortly afterwards he was released from his monastic vows on the intervention of the emperor. In 1788 he brought out his tragedy of *Sidney*, an *exposé* of the tyranny of James II. and of the fanaticism of the papists in England. This was attacked so violently as profane and revolutionary that he was compelled to resign his office and seek refuge in Silesia. In Breslau he met with a cordial reception from G. W. Korn the publisher, and was, moreover, subsequently employed by the prince of Carolath-Schönaich as tutor to his sons. In 1791 Fessler was converted to Lutheranism and next year contracted an unhappy marriage, which was dissolved in 1802, when he married again. In 1796 he went to Berlin, where he founded a humanitarian society, and was commissioned by the free-masons of that city to assist Fichte in reforming the statutes and ritual of their lodge. He soon after this obtained a government appointment in connexion with the newly-acquired Polish provinces, but in consequence of the battle of Jena (1806) he lost this office, and remained in very needy circumstances until 1809, when he was summoned to St Petersburg by Alexander I., to fill the post of court councillor, and the professorship of oriental languages and philosophy at the Alexander-Nevski Academy. This office, however, he was soon obliged to resign, owing to his alleged atheistic tendencies, but he was subsequently nominated a member of the legislative commission. In 1815 he went with his family to Sarepta, where he joined the Moravian community and again became strongly orthodox. This cost him the loss of his salary, but it was restored to him in 1817. In November 1820 he was appointed consistorial president of the evangelical communities at Saratov and subsequently became chief superintendent of the Lutheran communities in St Petersburg. Fessler's numerous works are all written in German. In recognition of his important services to Hungary as a historian, he was in 1831 elected a corresponding member of the Hungarian Academy of Sciences. He died at St Petersburg on the 15th of December 1839.

Fessler was a voluminous writer, and during his life exercised great influence; but, with the possible exception of the history of Hungary, none of his books has any value now. He did not pretend to any critical treatment of his materials, and most of his historical works are practically historical novels. He did much, however, to make the study of history popular. His most important works are—*Die Geschichten der Ungarn und ihrer Landsassen* (10 vols. Leipzig, 1815–1825); *Marcus Aurelius* (3 vols., Breslau, 1790–1792; 3rd edition, 4 vols., 1799); *Aristides und Themistokles* (2 vols., Berlin, 1792; 3rd edition, 1818); *Attila, König der Hunnen* (Breslau, 1794); *Mathias Corvinus* (2 vols., Breslau, 1793–1794); and *Die drei grossen Könige der Ungarn aus dem Arpadischen Stamme* (Breslau, 1808).

See Fessler's *Rückblicke auf seine siebenzigjährige Pilgerschaft* (Breslau, 1824; 2nd edition, Leipzig, 1851).

FESTA, CONSTANZO (c. 1495–1545), Italian singer and musical composer, became a member of the Pontifical choir in Rome in 1517, and soon afterwards *maestro* at the Vatican. His motets and madrigals (the first book of which appeared in 1537) excited Dr Burney's warm praise in his *History of Music*; and, among other church music, his *Te Deum* (published in 1596) is still sung at important services in Rome. His madrigal, called in English "Down in a flow'ry vale," is well known.

FESTINIÖG (or FFESTINIÖG), a town of Merionethshire, North Wales, at the head of the Festiniog valley, 600 ft. above the sea, in the midst of rugged scenery, near the stream Dwyryd, 31 m. from Conway. Pop. of urban district (1901), 11,435. There are many large slate quarries in this parish, especially at Blaenau Festiniog, the junction of three railways, London & North Western, Great Western and Festiniog, a narrow-gauge line between Portmadoc and Duffws. This light railway runs at a considerable elevation (some 700 ft.), commanding a view across the valley and lake of Tan y Bwlch. Lord Lyttelton's letter to Mr Bower is a well-known panegyric on Festiniog. Thousands of workmen are employed in the slate quarries. The Cynfael falls are famous. Near are *Beddau gwyr Ardudwy*

(the graves of the men of Ardudwy), memorials of a fight to recover women of the Clwyd valley from the men of Ardudwy. Near, too, is a rock named "Hugh Lloyd's pulpit" (Lloyd lived in the time of Charles I., Cromwell and Charles II.).

FESTOON (from Fr. *feston*, Ital. *festone*, from a Late Lat. *festo*, originally a "festal garland," Lat. *festum*, feast), a wreath or garland, and so in architecture a conventional arrangement of flowers, foliage or fruit bound together and suspended by ribbons, either from a decorated knot, or held in the mouths of lions, or suspended across the bank of bulls' heads as in the Temple of Vesta at Tivoli. The "motif" is sometimes known as a "swag." It was largely employed both by the Greeks and Romans and formed the principal decoration of altars, friezes and panels. The ends of the ribbons are sometimes formed into bows or twisted curves; when in addition a group of foliage or flowers is suspended it is called a "drop." Its origin is probably due to the representation in stone of the garlands of natural flowers, &c., which were hung up over an entrance doorway on fête days, or suspended round the altar.

FESTUS (? RUFUS or RUFIVS), one of the Roman writers of *breviaria* (epitomes of Roman history). The reference to the defeat of the Goths at Noviodunum (A.D. 369) by the emperor Valens, and the fact that the author is unaware of the constitution of Valentia as a province (which took place in the same year) are sufficient indication to fix the date of composition. Mommsen identifies the author with Rufius Festus, proconsul of Achaëa (366), and both with Rufius Festus Avienus (*q.v.*), the translator of Aratus. But the absence of the name Rufius in the best MSS. is against this. Others take him to be Festus of Tridentum, *magister memoriae* (secretary) to Valens and proconsul of Asia, where he was sent to punish those implicated in the conspiracy of Theodorus, a commission which he executed with such merciless severity that his name became a byword. The work itself (*Breviarium rerum gestarum populi Romani*) is divided into two parts—one geographical, the other historical. The chief authorities used are Livy, Eutropius and Florus. It is extremely meagre, but the fact that the last part is based on the writer's personal recollections makes it of some value for the history of the 4th century.

Editions by W. Förster (Vienna, 1873) and C. Wagener (Prague, 1886); see also R. Jacobi, *De Festi breviarii fontibus* (Bonn, 1874), and H. Peter, *Die geschichtliche Litt. über die römische Kaiserzeit*, ii. p. 133 (1897), where the epitomes of Festus, Aurelius Victor and Eutropius are compared.

FESTUS, SEXTUS POMPEIUS, Roman grammarian, probably flourished in the 2nd century A.D. He made an epitome of the celebrated work *De verborum significatu*, a valuable treatise alphabetically arranged, written by M. Verrius Flaccus, a freedman and celebrated grammarian who flourished in the reign of Augustus. Festus gives the etymology as well as the meaning of every word; and his work throws considerable light on the language, mythology and antiquities of ancient Rome. He made a few alterations, and inserted some critical remarks of his own. He also omitted such ancient Latin words as had long been obsolete; these he discussed in a separate work now lost, entitled *Priscorum verborum cum exemplis*. Of Flaccus's work only a few fragments remain, and of Festus's epitome only one original copy is in existence. This MS., the Codex Festi Farnesianus at Naples, only contains the second half of the work (M-V) and that not in a perfect condition. It has been published in facsimile by Thewrewk de Ponor (1890). At the close of the 8th century Paulus Diaconus abridged the abridgment. From his work and the solitary copy of the original attempts have been made with the aid of conjecture to reconstruct the treatise of Festus.

Of the early editions the best are those of J. Scaliger (1565) and Fulvius Ursinus (1581); in modern times, those of C. O. Müller (1839, reprinted 1880) and de Ponor (1889); see J. E. Sandys, *History of Classical Scholarship*, vol. i. (1906).

FÉTIS, FRANÇOIS JOSEPH (1784–1871), Belgian composer and writer on music, was born at Mons in Belgium on the 25th of March 1784, and was trained as a musician by his father, who followed the same calling. His talent for composition manifested

itself at the age of seven, and at nine years old he was an organist at Sainte-Waudru. In 1800 he went to Paris and completed his studies at the conservatoire under such masters as Boieldieu, Rey and Pradher. In 1806 he undertook the revision of the Roman liturgical chants in the hope of discovering and establishing their original form. In this year he married the granddaughter of the Chevalier de Kéralio, and also began his *Biographie universelle des musiciens*, the most important of his works, which did not appear until 1834. In 1821 he was appointed professor at the conservatoire. In 1827 he founded the *Revue musicale*, the first serious paper in France devoted exclusively to musical matters. Fétis remained in the French capital till in 1833, at the request of Leopold I., he became director of the conservatoire of Brussels and the king's chapelmaster. He also was the founder, and, till his death, the conductor of the celebrated concerts attached to the conservatoire of Brussels, and he inaugurated a free series of lectures on musical history and philosophy. He produced a large quantity of original compositions, from the opera and the oratorio down to the simple *chanson*. But all these are doomed to oblivion. Although not without traces of scholarship and technical ability, they show total absence of genius. More important are his writings on music. They are partly historical, such as the *Curiosités historiques de la musique* (Paris, 1850), and the *Histoire universelle de musique* (Paris, 1869-1876); partly theoretical, such as the *Méthode des méthodes de piano* (Paris, 1837), written in conjunction with Moscheles. Fétis died at Brussels on the 26th of March 1871. His valuable library was purchased by the Belgian government and presented to the Brussels conservatoire. His work as a musical historian was prodigious in quantity, and, in spite of many inaccuracies and some prejudice revealed in it, there can be no question as to its value for the student.

FETISHISM, an ill-defined term, used in many different senses: (a) the worship of inanimate objects, often regarded as peculiarly African; (b) negro religion in general; (c) the worship of inanimate objects conceived as the residence of spirits not inseparably bound up with, nor originally connected with, such objects; (d) the doctrine of spirits embodied in, or attached to, or conveying influence through, certain material objects (Tylor); (e) the use of charms, which are not worshipped, but derive their magical power from a god or spirit; (f) the use as charms of objects regarded as magically potent in themselves. A further extension is given by some writers, who use the term as synonymous with the religions of primitive peoples, including under it not only the worship of inanimate objects, such as the sun, moon or stars, but even such phases of primitive philosophy as totemism. Comte applied the term to denominate the view of nature more commonly termed animism.

Derivation.—The word fetish (or fetich) was first used in connexion with Africa by the Portuguese discoverers of the last half of the 15th century; relics of saints, rosaries and images were then abundant all over Europe and were regarded as possessing magical virtue; they were termed by the Portuguese *feiticos* (i.e. charms). Early voyagers to West Africa applied this term to the wooden figures, stones, &c., regarded as the temporary residence of gods or spirits, and to charms. There is no reason to suppose that the word *feitico* was applied either to an animal or to the local spirit of a river, hill or forest. *Feitico* is sometimes interpreted to mean artificial, made by man, but the original sense is more probably "magically active or artful." The word was probably brought into general use by C. de Brosses, author of *Du culte des dieux fétiches* (1760), but it is frequently used by W. Bosman in his *Description of Guinea* (1705), in the sense of "the false god, Bossum" or "Bohsum," properly a tutelary deity of an individual.

Definition.—The term fetish is commonly understood to mean the worship of or respect for material, inanimate objects, conceived as magically active from a virtue inherent in them, temporarily or permanently, which does not arise from the fact that a god or spirit is believed to reside in them or communicate virtue to them. Taken in this sense fetishism is probably a

mark of decadence. There is no evidence of any such belief in Africa or elsewhere among primitive peoples. It is only after a certain grade of culture has been attained that the belief in luck appears; the fetish is essentially a mascot or object carried for luck.

Ordinary Usage.—In the sense in which Dr Tylor uses the term the fetish is (1) a "god-house" or (2) a charm derived from a tutelary deity or spirit, and magically active in virtue of its association with such deity or spirit. In the first of these senses the word is applied to objects ranging from the unworked stone to the pot or the wooden figure, and is thus hardly distinguishable from idolatry. (a) The *bohsum* or tutelary deity of a particular section of the community is derived from the local gods through the priests by the performance of a certain series of rites. The priest indicates into what object the *bohsum* will enter and proceeds to the abode of the local god to procure the object in question. After making an offering the object is carried to an appropriate spot and a "fetish" tree set up as a shade for it, which is sacred so long as the *bohsum* remains beneath it. The fall of the tree is believed to mark the departure of the spirit. A *bohsum* may also be procured through a dream; but in this case, too, it is necessary to apply to the priest to decide whether the dream was veridical. (b) The *suhman* or tutelary deity of an individual is not an object selected at random to be the residence of the spirit. It is only procurable at the residence of a Sasabonsum, a malicious non-human being. Various ceremonies are performed, and a spirit connected with the Sasabonsum is finally asked to enter an object. This is then kept for three days; if no good fortune results it is concluded either that the spirit did not enter the object selected, or that it is disinclined to extend its protection. In either case the ceremonies must be commenced afresh. Otherwise offerings and even human sacrifices in exceptional cases are made to the *suhman*. It is commonly believed that the negro claims the power of coercing his tutelary deity. This is denied by Colonel Ellis. It is certain that coercion of deities is not unknown, but further evidence is required that the negro uses it when his deity is refractory.

The *suhman* can, it is believed, communicate a part of his powers to various objects in which he does not dwell; these are also termed *suhman* by the natives and may have given rise to the belief that the practices commonly termed fetishism are not animistic. These charms are many in number; offerings of food and drink are made, i.e. to the portion of the power of the *suhman* which resides in them. These charms can only be made by the possessor of the *suhman*.

On the Guinea Coast the spirit implanted in the object is usually, if not invariably, non-human. Farther south on the Congo the "fetish" is inhabited by human souls also. The priest goes into the forest and cuts an image; when a party enters a wood for this purpose they may not mention the name of any living being unless they wish him to die and his soul to enter the fetish. The right person having been selected, his name is mentioned; and he is believed to die within ten days, his soul passing into the *nkissi*. It is into these figures that the nails are driven, in order to procure the vengeance of the indwelling spirit on some enemy.

In many cases the fetish spirit is believed to leave the "god-house" and pass for the time being into the body of the priest, who manifests the phenomena of possession (q.v.). It is a common error to suppose that the whole of African religion is embraced in the practices connected with these tutelary deities; so far from this being the case, belief in higher gods, not necessarily accompanied with worship or propitiation, is common in many parts of Africa, and there is no reason to suppose that it had been derived in every case, perhaps not in any case, from Christian or Mahomedan missionaries.

See A. B. Ellis, *Tshi-speaking Peoples*, chs. vii., viii. and xii.; Waitz, *Anthropologie der Naturvölker*, ii. 174; R. E. Dennett in *Folklore*, vol. xvi.; R. H. Nassau, *Fetichism in West Africa* (1904); also Tylor, *Primitive Culture*, ii. 143, and M. H. Kingsley, *West African Studies* (2nd ed., 1901), where the term is used in a more extended sense. (N. W. T.)

FETTERCAIRN, a burgh of barony of Kincardineshire, Scotland, $4\frac{1}{2}$ m. N.W. of Laurencekirk. Pop. of parish (1901) 1390. The chief structures include a public hall, library and reading-room, and the arch built to commemorate the visit of Queen Victoria in 1861. The most interesting relic, however, is the market cross, which originally belonged to the extinct town of Kincardine. To the S.W. is Balbegno Castle, dating from 1509, and planned on a scale that threatened to ruin its projector. It contains a lofty hall of fine proportions. Two miles N. is Fasque, the estate of the Gladstones, which was acquired in 1831 by Sir John Gladstone (1764-1851), the father of W. E. Gladstone. The castle, which stands in beautiful grounds, was built in 1809. Sir John Gladstone's tomb is in the Episcopal church of St Andrew, which he erected and endowed. In the immediate vicinity are the ruins of the royal castle of Kincardine, where, according to tradition, Kenneth III. was assassinated in 1005, although he is more generally said to have been slain in battle at Monzievaird, near Crieff in Perthshire.

FETTERS AND HANDCUFFS, instruments for securing the feet and hands of prisoners under arrest, or as a means of punishment. The old names were manacles, shackbolts or shackles, gyves and swivels. Until within recent times handcuffs were of two kinds, the figure-8 ones which confined the hands close together either in front or behind the prisoner, or the rings from the wrists were connected by a short chain much on the model of the handcuffs in use by the police forces of to-day. Much improvement has been made in handcuffs of late. They are much lighter and they are adjustable, fitting any wrist, and thus the one pair will serve a police officer for any prisoner. For the removal of gangs of convicts an arrangement of handcuffs connected by a light chain is used, the chain running through a ring on each fetter and made fast at both ends by what are known as *end-locks*. Several recently invented appliances are used as handcuffs, e.g. snaps, nippers, twisters. They differ from handcuffs in being intended for one wrist only, the other portion being held by the captor. In the snap the smaller circlet is snapped to on the prisoner's wrist. The nippers can be instantly fastened on the wrist. The twister, not now used in England as being liable to injure prisoners seriously, is a chain attached to two handles; the chain is put round the wrist and the two handles twisted till the chain is tight enough.

Leg-irons are anklets of steel connected by light chains long enough to permit of the wearer walking with short steps. An obsolete form was an anklet and chain to the end of which was attached a heavy weight, usually a round shot. The Spanish used to secure prisoners in bilboes, shackles round the ankles secured by a long bar of iron. This form of leg-iron was adopted in England, and was much employed in the services during the 17th and 18th centuries. An ancient example is preserved in the Tower of London. The French marine still use a kind of leg-iron of the bilbo type.

FEU, in Scotland, the commonest mode of land tenure. The word is the Scots variant of "fee" (*q.v.*). The relics of the feudal system still dominate Scots conveyancing. That system has recognized as many as seven forms of tenure—ward, socage, mortification, feu, blench, burgage, booking. Ward, the original military holding, was abolished in 1747 (20 G. II. c. 20), as an effect of the rising of 1745. Socage and mortification have long since disappeared. Booking is a conveyance peculiar to the borough of Paisley, but does not differ essentially from feu. Burgage is the system by which land is held in royal boroughs. Blench holding is by a nominal payment, as of a penny Scots, or a red rose, often only to be rendered upon demand. In feu holding there is a substantial annual payment in money or in kind in return for the enjoyment of the land. The crown is the first overlord or superior, and land is held of it by crown vassals, but they in their turn may "feu" their land, as it is called, to others who become *their* vassals, whilst they themselves are mediate overlords or superiors; and this process of sub-infeudation may be repeated to an indefinite extent. The Conveyancing Act of 1874 renders any clause in a disposition against sub-infeudation null and void. In England on the other hand, since

1290, when the statute *Quia Emptores* was passed, sub-infeudation is impossible, as the new holder simply effaces the grantor, holding by the same title as the grantor himself. Casualties, which are a feature of land held in feu, are certain payments made to the superior, contingent on the happening of certain events. The most important was the payment of an amount equal to one year's feu-duty by a new holder, whether heir or purchaser of the feu. The Conveyancing Act of 1874 abolished casualties in all feus after that date, and power was given to redeem this burden on feus already existing. If the vassal does not pay the feu-duty for two years, the superior, among other remedies, may obtain by legal process a decree of irritancy, whereupon *insel* or forfeiture of the feu follows. Previously to 1832 only the vassals of the crown had votes in parliamentary elections for the Scots counties, and this made in favour of sub-infeudation as against sale outright. In Orkney and Shetland land is still largely possessed as udal property, a holding derived or handed down from the time when these islands belonged to Norway. Such lands may be converted into feus at the will of the proprietor and held from the crown or Lord Dundas. At one time the system of conveyancing by which the transfer of feus was effected was curious and complicated, requiring the presence of parties on the land itself and the symbolical handing over of the property, together with the registration of various documents. But legislation since the middle of the 19th century has changed all that. The system of feuing in Scotland, as contrasted with that of long leaseholds in England, has tended to secure greater solidity and firmness in the average buildings of the northern country.

See Erskine's *Principles*; Bell's *Principles*; Rankine, *Law of Landownership in Scotland*.

FEUCHÈRES, SOPHIE, BARONNE DE (1795-1840), Anglo-French adventuress, was born at St Helens, Isle of Wight, in 1795, the daughter of a drunken fisherman named Dawes. She grew up in the workhouse, went up to London as a servant, and became the mistress of the duc de Bourbon, afterwards prince de Condé. She was ambitious, and he had her well educated not only in modern languages but, as her exercise books—still extant—show, in Greek and Latin. He took her to Paris and, to prevent scandal and to qualify her to be received at court, had her married in 1818 to Adrien Victor de Feuchères, a major in the Royal Guards. The prince provided her dowry, made her husband his aide-de-camp and a baron. The baroness, pretty and clever, became a person of consequence at the court of Louis XVIII. De Feuchères, however, finally discovered the relations between his wife and Condé, whom he had been assured was her father, left her—he obtained a legal separation in 1827—and told the king, who thereupon forbade her appearance at court. Thanks to her influence, however, Condé was induced in 1829 to sign a will bequeathing about ten million francs to her, and the rest of his estate—more than sixty-six millions—to the duc d'Aumale, fourth son of Louis Philippe. Again she was in high favour. Charles X. received her at court, Talleyrand visited her, her niece married a marquis and her nephew was made a baron. Condé, wearied by his mistress's importunities, and but half pleased by the advances made him by the government of July, had made up his mind to leave France secretly. When on the 27th of August 1830 he was found hanging dead from his window, the baroness was suspected and an inquiry was held, but the evidence of death being the result of any crime appearing insufficient, she was not prosecuted. Hated as she was alike by legitimatists and republicans, life in Paris was no longer agreeable for her, and she returned to London, where she died in December 1840.

FEUCHTERSLEBEN, ERNST, FREIHERR VON (1806-1849), Austrian physician, poet and philosopher, was born in Vienna on the 29th of April 1806; of an old Saxon noble family. He attended the "Theresian Academy" in his native city, and in 1825 entered its university as a student of medicine. In 1833 he obtained the degree of doctor of medicine, settled in Vienna as a practising surgeon, and in 1834 married. The young doctor kept up his connexion with the university, where he lectured, and

in 1844 was appointed dean of the faculty of medicine. He cultivated the acquaintance of Franz Grillparzer, Heinrich Laube, and other intellectual lights of the Viennese world, interested himself greatly in educational matters, and in 1848, while refusing the presidency of the ministry of education, accepted the appointment of under secretary of state in that department. His health, however, gave way, and he died at Vienna on the 3rd of September 1849. He was not only a clever physician, but a poet of fine aesthetic taste and a philosopher. Among his medical works may be mentioned: *Über das Hippokratische erste Buch von der Diät* (Vienna, 1835), *Ärzte und Publicum* (Vienna, 1848) and *Lehrbuch der ärztlichen Seelenkunde* (1845). His poetical works include *Gedichte* (Stutt. 1836), among which is the well-known beautiful hymn, which Mendelssohn set to music. "Es ist bestimmt in Gottes Rat." As a philosopher he is best known by his *Zur Diätetik der Seele* [Dietetics of the soul] (Vienna, 1838), which attained great popularity, and the tendency of which, in contrast to Hufeland's *Makrobiotik* (On the Art of Prolonging Life), is to show the true way of rendering life harmonious and lovely. This work had by 1906 gone into fifty editions. Noteworthy also is his *Beiträge zur Literatur-, Kunst- und Lebenstheorie* (Vienna, 1837-1841), and an anthology, *Geist der deutschen Klassiker* (Vienna, 1851; 3rd ed. 1865-1866).

His collected works (with the exception of the purely medical ones) were published in 7 vols. by Fr. Hebbel (Vienna, 1851-1853). See M. Necker, "Ernst von Feuchtersleben, der Freund Grillparzers," in the *Jahrbuch der Grillparzer Gesellschaft*, vol. iii. (Vienna, 1893).

FEUD, animosity, hatred, especially a permanent condition of hostilities between persons, and hence applied to a state of private warfare between tribes, clans or families, a "vendetta." The word appears in Mid. Eng. as *fede*, which came through the O. Fr. from the O. High Ger. *fehida*, modern *Fehde*. The O. Teutonic *faiho*, an adjective, the source of *fehida*, gives the O. Eng. *fáh*, foe. "Fiend," originally an enemy (cf. Ger. *Feind*), hence the enemy of mankind, the devil, and so any evil spirit, is probably connected with the same source. The word *fede* was of Scottish usage, but in the 16th century took the form *foode*, *feud* in English. The *New English Dictionary* points out that "feud, fee (Lat. *feudum*) could not have influenced the change, for it appears fifty years later than the first instances of *foode*, &c., and was only used by writers on feudalism." For the etymology of "feud" (*feudum*) see FEE, and for its history see FEUDALISM.

FEUDALISM (from Late Lat. *feodum* or *feudum*, a fee or fief; see FEE). In every case of institutional growth in history two things are to be clearly distinguished from the beginning for a correct understanding of the process and its results. One of these is the change of conditions in the political or social environment which made growth necessary. The other is the already existing institutions which began to be transformed to meet the new needs. In studying the origin and growth of political feudalism, the distinction is easy to make. The all-prevailing need of the later Roman and early medieval society was protection—protection against the sudden attacks of invading tribes or revolted peasants, against oppressive neighbours, against the unwarranted demands of government officers, or even against the legal but too heavy exactions of the government itself. In the days of the decaying empire and of the chaotic German settlement, the weak freeman, the small landowner, was exposed to attack in almost every relation of life and on every side. The protection which normally it is the business of government to furnish he could no longer obtain. He must seek protection elsewhere wherever he could get it, and pay the price demanded for it. This is the great social fact—the failure of government to perform one of its most primary duties, the necessity of finding some substitute in private life—extending in greater or less degree through the whole formative period of feudalism, which explains the transformation of institutions that brought it into existence. Similar conditions have produced an organization which may be called feudal, in various countries, and in widely separated periods of history. While these different feudal systems have shown a general

similarity of organization, there has been also great variation in their details, because they have started from different institutions and developed in different ways. The feudal system with which history most concerns itself is that of medieval western Europe, and it is that which will be here described.

The institutions which the need of protection seized upon when it first began to turn away from the state were twofold. They had both long existed in the private, not public, relations of the Romans, and they had up to this time shown no tendency to grow. One of them related to the person, to the man himself, without reference to property, the other related to land. There are thus distinguished at the beginning those two great sides of feudalism which remained to the end of its history more or less distinct, the personal relation and the land relation. The personal institution needs little description. It was the Roman patron and client relationship which had remained in existence into the days of the empire, in later times less important perhaps legally than socially, and which had been reinforced in Gaul by very similar practices in use among the Celts before their conquest. The description of this institution which has come down to us from Roman sources of the days when feudalism was beginning is not so detailed as we could wish, but we can see plainly enough that it met a frequent need, that it was called by a new name, the *patrocinium*, and that it was firmly enough entrenched in usage to survive the German conquest, and to be taken up and continued by the conquerors. In its new use, alike in the later Roman and the early German state, the landless freeman who could not support himself went to some powerful man, stated his need, and offered his services, those proper to a freeman, in return for shelter and support. This transaction, which was called commendation, gave rise in the German state to a written contract which related the facts and provided a penalty for its violation. It created a relationship of protection and support on one side, and of free service on the other.

The other institution, relating to land, was that known to the Roman law as the *precarium*, a name derived from one of its essential features through all its history, the prayer of the suppliant by which the relationship was begun. The *precarium* was a form of renting land not intended primarily for income, but for use when the lease was made from friendship for example, or as a reward, or to secure a debt. Legally its characteristic feature was that the lessee had no right of any kind against the grantor. The owner could call in his land and terminate the relation at any time, for any reason, or for none at all. Even a definite understanding at the outset that the lease might be enjoyed to a specified date was no protection.¹ It followed of course that the heir had no right in the land which his father held in this way, nor was the heir of the donor bound by his father's act. The legal character of this transaction is summed up in a well-known passage in the *Digest*:—*Interdictum de precariis merito introductum est, quia nulla eo nomine juris civilis actio esset, magis enim ad donationes et beneficii causam, quam ad negotii contracti spectat precarii conditio.*² This may be paraphrased as follows:—The *precarium* tenant may employ the interdict against a third party, because he cannot use the ordinary civil action, his holding being not a matter of business but rather of favour and kindness. It should be noted that from its very beginning the land relationship of feudalism was not created primarily for the grantor's income, but that it emphasized in the most striking way his continued ownership.

As used for protection in later Roman days the *precarium* gave rise to what was called the commendation of lands, *patrocinium fundorum*. The poor landowner, likely to lose all that he had from one kind of oppression or another, went to the great landowner, his neighbour, whose position gave him immunity from attack or the power to prevent official abuses, and begged to be protected. The rich man answered, I can only protect my own. Of necessity the poor man must surrender to his powerful neighbour the ownership of his lands, which he then received back as a *precarium*—gaining protection during his lifetime

¹ *Digest*, xliii. 26. 12.

² *Ibid.* xliii. 26. 14, and cf. 17.

at the cost of his children, who were left without legal claim and compelled to make the best terms they could.¹ Applied to this use the *precarium* found extensive employment in the last age of the empire. The government looked on the practice with great disfavour, because it transferred large areas from the easy access of the state to an ownership beyond its reach. The laws repeatedly forbade it under increasing penalties, but clearly it could not be stopped. The motive was too strong on both sides—the need of protection on one side, the natural desire to increase large possessions and means of self-defence on the other.

These practices the Frankish conquerors of Gaul found in full possession of society when they entered into that province.

Frankish development.

They seem to have understood them at once, and, like much else Roman, to have made them their own without material change. The *patrocinium* they were made ready to understand by the existence of a somewhat similar institution among themselves, the *comitatus*, described by Tacitus. In this institution the chief of the tribe, or of some plainly marked division of the tribe, gathered about himself a band of chosen warriors, who formed a kind of private military force and body-guard. The special features of the institution were the strong tie of faith and service which bound the man, the support and rewards given by the lord, and the pride of both in the relationship. The *patrocinium* might well seem to the German only a form of the *comitatus*, but it was a form which presented certain advantages in his actual situation. The chief of these was perhaps the fact that it was not confined to king or tribal chief, but that every noble was able in the Roman practice to surround himself with his organized private army. Probably this fact, together with the more general fact of the absorption in most things of the German in the Roman, accounts for the substitution of the *patrocinium* for the *comitatus* which took place under the Merovingians.

This change did not occur, however, without some modification of the Roman customs. The *comitatus* made contributions of its own to future feudalism, to some extent to its institutional side, largely to the ideas and spirit which ruled in it. Probably the ceremony which grew into feudal homage, and the oath of fealty, certainly the honourable position of the vassal and his pride in the relationship, the strong tie which bound lord and man together, and the idea that faith and service were due on both sides in equal measure, we may trace to German sources. But we must not forget that the origin of the vassal relationship, as an institution, is to be found on Roman and not on German soil. The *comitatus* developed and modified, it did not originate. Nor was the feudal system established in any sense by the settlement of the *comitatus* group on the conquered land. The uniting of the personal and the land sides of feudalism came long after the conquest, and in a different way.

To the *precarium* German institutions offered no close parallel. The advantages, however, which it afforded were obvious, and this side of feudalism developed as rapidly after the conquest as the personal. The new German noble was as eager to extend the size of his lands and to increase the numbers of his dependants as the Roman had been. The new German government furnished no better protection from local violence, nor was it able any more effectively to check the practices which were creating feudalism; indeed for a long time it made no attempt to do so. *Precarium* and *patrocinium* easily passed from the Roman empire to the Frankish kingdom, and became as firmly rooted in the new society as they had ever been in the old. Up to this point we have seen only the small landowner and the landless man entering into these relations. Feudalism could not be established, however, until the great of the land had adopted them for themselves, and had begun to enter the clientage of others and to hold lands by the *precarium* tenure. The first step towards this result was easily and quickly taken. The same class continued to furnish the king's men, and to form his household and body-guard whether the relation was that of the *patrocinium* or the *comitatus*, and to be made noble by entering into it. It was later that they became clients of one another, and in part at

¹ Salvian, *De gub. Dei*, v. 8, ed. Halm, p. 62.

least as a result of their adoption of the *precarium* tenure. In this latter step the influence of the Church rather than of the king seems to have been effective. The large estates which pious intentions had bestowed on the Church it was not allowed to alienate. It could most easily make them useful to gain the influence and support which it needed, and to provide for the public functions which fell to its share, by employing the *precarium* tenure. On the other side, the great men coveted the wide estates of bishop and abbot, and were ready without persuasion to annex portions of them to their own on the easy terms of this tenure, not always indeed observed by the holder, or able to be enforced by the Church. The employment of the *precarium* by the Church seems to have been one of the surest means by which this form of landholding was carried over from the Romans to the Frankish period and developed into new forms. It came to be made by degrees the subject of written contract, by which the rights of the holder were more definitely defined and protected than had been the case in Roman law. The length of time for which the holding should last came to be specified, at first for a term of years and then for life, and some payment to the grantor was provided for, not pretending to represent the economic value of the land, but only to serve as a mark of his continued ownership.

These changes characterize the Merovingian age of Frankish history. That period had practically ended, however, before these two institutions showed any tendency to join together as they were joined in later feudalism. Nor had the king up to that time exerted any apparent influence on the processes that were going forward. Grants of land of the Merovingian kings had carried with them ownership and not a limited right, and the king's *patrocinium* had not widened in extent in the direction of the later vassal relation. It was the advent of the Carolingian princes and the difficulties which they had to overcome that carried these institutions a stage further forward. Making their way up from a position among the nobility to be the rulers of the land, and finally to supplant the kings, the Carolingians had especial need of resources from which to purchase and reward faithful support. This need was greatly increased when the Arab attack on southern Gaul forced them to transform a large part of the old Frankish foot army into cavalry.² The fundamental principle of the Frankish military system, that the man served at his own expense, was still unchanged. It had indeed begun to break down under the strain of frequent and distant campaigns, but it was long before it was changed as the recognized rule of medieval service. If now, in addition to his own expenses, the soldier must provide a horse and its keeping, the system was likely to break down altogether. It was this problem which led to the next step. To solve it the early Carolingian princes, especially Charles Martel, who found the royal domains exhausted and their own inadequate, grasped at the land of the Church. Here was enough to endow an army, if some means could be devised to permit its use. This means was found in the *precarium* tenure. Keeping alive, as it did, the fact of the grantor's ownership, it did not in form deprive the Church of the land. Recognizing that ownership by a small payment only, not corresponding to the value of the land, it left the larger part of the income to meet the need which had arisen. At the same time undoubtedly the new holder of the land, if not already the vassal of the prince, was obliged to become so and to assume an obligation of service with a mounted force when called upon.³ This expedient seems to have solved the problem. It gave rise to the numerous *precariae verbo regis*, of the Church records, and to the condemnation of Charles Martel in the visions of the clergy to worse difficulties in the future life than he had overcome in this. The most important consequences of the expedient, however, were not intended or perceived at the time. It brought together the two sides of feudalism, vassalage and benefice, as they were now commonly called, and from this age their union into what is really a single

² H. Brunner, *Zeitschr. der sav. Stift. für Rechtsgeschichte*, Germ. Abth. viii. 1-38 (1887). Also in his *Forschungen*, 39-74 (1894).

³ See F. Dahn, *Könige der Germanen*, viii. 2, 90 ff.

institution was rapid;¹ it emphasized military service as an essential obligation of the vassal; and it spread the vassal relation between individual proprietors and the sovereign widely over the state.

In the period that followed, the reign of Charlemagne and the later Carolingian age, continued necessities, military and civil, forced the kings to recognize these new institutions more fully, even when standing in a position between the government and the subject, intercepting the public duties of the latter. The incipient feudal baron had not been slow to take advantage of the break-down of the old German military system. As in the last days of the Roman empire the poor landowner had found his only refuge from the exactions of the government in the protection of the senator, who could in some way obtain exemptions, so the poor Frank could escape the ruinous demands of military service only by submitting himself and his lands to the count, who did not hesitate on his side to force such submission. Charlemagne legislated with vigour against this tendency, trying to make it easier for the poor freeman to fulfil his military duties directly to the state, and to forbid the misuse of power by the rich, but he was not more successful than the Roman government had been in a like attempt. Finally the king found himself compelled to recognize existing facts, to lay upon the lord the duty of producing his men in the field and to allow him to appear as their commander. This solved the difficulty of military service apparently, but with decisive consequences. It completed the transformation of the army into a vassal army; it completed the recognition of feudalism by the state, as a legitimate relation between different ranks of the people; and it recognized the transformation in a great number of cases of a public duty into a private obligation.

In the meantime another institution had grown up in this Franco-Roman society, which probably began and certainly assisted in another transformation of the same kind. This is the immunity. Suggested probably by Roman practices, possibly developed directly from them, it received a great extension in the Merovingian period, at first and especially in the interest of the Church, but soon of lay land-holders. By the grant of an immunity to a proprietor the royal officers, the count and his representatives, were forbidden to enter his lands to exercise any public function there. The duties which the count should perform passed to the proprietor, who now represented the government for all his tenants free and unfree. Apparently no modification of the royal rights was intended by this arrangement, but the beginning of a great change had really been made. The king might still receive the same revenues and the same services from the district held by the lord as formerly, but for their payment a private person in his capacity as overlord was now responsible. In the course of a long period characterized by a weak central government, it was not difficult to enlarge the rights which the lord thus obtained, to exclude even the king's personal authority from the immunity, and to translate the duties and payments which the tenant had once owed to the state into obligations which he owed to his lord, even finally into incidents of his tenure. The most important public function whose transformation into a private possession was assisted by the growth of the immunity was the judicial. This process had probably already begun in a small way in the growth of institutions which belong to the economic side of feudalism, the organization of agriculture on the great estates. Even in Roman days the proprietor had exercised a jurisdiction over the disputes of his unfree tenants. Whether this could by its own growth have been extended over his free tenants and carried so far as to absorb a local court, like that of the hundred, into private possession, is not certain. It seems probable that it could. But in any case, the immunity easily carried the development of private jurisdiction through these stages. The lord's court took the place of the public court in civil, and even by degrees in criminal cases. The plaintiff, even if he were under another lord, was obliged to sue in the court of the defendant's lord, and the portion of the fine

¹ F. Dahn, *Könige der Germanen*, viii. 2, 197.

for a breach of the peace which should have gone to the state went in the end to the lord.

The transfer of the judicial process, and of the financial and administrative sides of the government as well, into private possession, was not, however, accomplished entirely by the road of the immunity. As government weakened after the strong days of Charlemagne, and disorder, invasion, and the difficulty of intercommunication tended to throw the locality more and more upon its own resources, the officer who had once been the means of centralization, the count, found success in the effort for independence which even Charlemagne had scarcely overcome. He was able to throw off responsibility to any central authority, and to exercise the powers which had been committed to him as an agent of the king, as if they were his own private possession. Nor was the king's aid lacking to this method of dividing up the royal authority, any more than to the immunity, for it became a frequent practice to make the administrative office into a fief, and to grant it to be held in that form of property by the count. In this way the feudal county, or duchy, formed itself, corresponding in most cases only roughly to the old administrative divisions of the state, for within the bounds of the county there had often formed private feudal possessions too powerful to be forced into dependence upon the count, sometimes the vice-comes had followed the count's example, and often, on the other hand, the count had attached to his county like private possessions of his own lying outside its boundaries. In time the private lord, who had never been an officer of the state, assumed the old administrative titles and called himself count or viscount, and perhaps with some sort of right, for his position in his territories, through the development of the immunity, did not differ from that now held by the man who had been originally a count.

In these two ways then the feudal system was formed, and took possession of the state territorially, and of its functions in government. Its earliest stage of growth was that of the private possession only. Under a government too weak to preserve order, the great landowner formed his estate into a little territory which could defend itself. His smaller neighbours who needed protection came to him for it. He forced them to become his dependants in return under a great variety of forms, but especially developing thereby the *precarium* land tenure and the *patrocinium* personal service, and organizing a private jurisdiction over his tenants, and a private army for defence. Finally he secured from the king an immunity which excluded the royal officers from his lands and made him a quasi-representative of the state. In the meantime his neighbour the count had been following a similar process, and in addition he had enjoyed considerable advantages of his own. His right to exact military, financial and judicial duties for the state he had used to force men to become his dependants, and then he had stood between them and the state, freeing them from burdens which he threw with increased weight upon those who still stood outside his personal protection. In ignorance of their danger, and later in despair of getting public services adequately performed in any other way, the kings first adopted for themselves some of the forms and practices which had thus grown up, and by degrees recognized them as legally proper for all classes. It proved to be easier to hold the lord responsible for the public duties of all his dependants because he was the king's vassal and by attaching them as conditions to the benefices which he held, than to enforce them directly upon every subject.

When this stage was reached the formative age of feudalism may be considered at an end. When the government of the state had entered into feudalism, and the king was as much senior as king; when the vassal relationship was recognized as a proper and legal foundation of public duties; when the two separate sides of early feudalism were united as the almost universal rule, so that a man received a fief because he owed a vassal's duties, or looked at in the other and finally prevailing way, that he owed a vassal's duties because he had received a fief; and finally, when the old idea of the temporary character of the *precarium* tenure was lost sight of, and the right of the

vassal's heir to receive his father's holding was recognized as the general rule—then the feudal system may be called full grown. Not that the age of growth was really over. Feudal history was always a becoming, always a gradual passing from one stage to another, so long as feudalism continued to form the main organization of society. But we may say that the formative age was over when these features of the system had combined to be its characteristic marks. What follows is rather a perfection of details in the direction of logical completeness. To assign any specific date to the end of this formative age is of course impossible, but meaning by the end what has just been stated, we shall not be far wrong if we place it somewhere near the beginning of the 10th century.

Before we leave the history of feudal origins another word is necessary. We have traced a definite line of descent for feudal institutions from Roman days through the Merovingian and Carolingian ages to the 10th century. That line of descent can be made out with convincing clearness and with no particular difficulty from epoch to epoch, from the *precarium* and the *patrocinium*, through the benefice and commendation, to the fief and vassalage. But the definiteness of this line should not cause us to overlook the fact that there was during these centuries much confusion of custom and practice. All round and about this line of descent there was a crowd of varying forms branching off more or less widely from the main stem, different kinds of commendation, different forms of *precarium*, some of which varied greatly from that through which the fief descends, and some of which survived in much the old character and under the old name for a long time after later feudalism was definitely established.¹ The variety and seeming confusion which reign in feudal society, under uniform controlling principles, rule also in the ages of beginning. It is easy to lose one's bearings by over-emphasizing the importance of variation and exception. It is indeed true that what was the exception, the temporary offshoot, might have become the main line. It would then have produced a system which would have been feudal, in the wide sense of the term, but it would have been marked by different characteristics, it would have operated in a somewhat different way. The crowd of varying forms should not prevent us from seeing that we can trace through their confusion the line along which the characteristic traits and institutions of European feudalism, as it actually was, were growing constantly more distinct.² That is the line of the origin of the feudal system. (See also FRANCE: *Law and Institutions*.)

The growth which we have traced took place within the Frankish empire. When we turn to Anglo-Saxon England we find a different situation and a different result. There *precarium* and *patrocinium* were lacking. Certain forms of personal commendation did develop, certain forms of dependent land tenure came into use. These do not show, however, the characteristic marks of the actual line of feudal descent. They belong rather in the varying forms around that line. Scholars are not yet agreed as to what would have been their result if their natural development had not been cut off by the violent introduction of Frankish feudalism with the Norman conquest, whether the historical feudal system, or a feudal system in the general sense. To the writer it seems clear that the latter is the most that can be asserted. They were forms which may rightly be called feudal, but only in the wider meaning in which we speak of the feudalism of Japan, or of Central Africa, not in the sense of 12th-century European feudalism; Saxon commendation may rightly be called vassalage, but only as looking back to the early Frankish use of the term for many varying forms of practice, not as looking forward to the later and more definite usage of completed feudalism; and such use of the terms feudal and vassalage is sure to be misleading. It is better to say that European feudalism is not to be found in England before the Conquest, not even in its beginnings. If

¹ G. Waitz, *Deutsche Verfassungsgeschichte*, vi. 112 ff. (1896). Most fully described in G. Seeliger, *Die soziale u. politische Bedeutung d. Grundherrschaft im früheren Mittelalter* (1903).

² F. Dahn, *Könige*, viii. 2, 89-90; 95.

these had really been in existence it would require no argument to show the fact. There is no trace of the distinctive marks of Frankish feudalism in Saxon England, not where military service may be thought to rest upon the land, nor even in the rare cases where the tenant seems to some to be made responsible for it; for between these cases as they are described in the original accounts, legally interpreted, and the feudal conception of the vassal's military service, there is a great gulf.

In turning from the origin of feudalism to a description of the completed system one is inevitably reminded of the words with which de Quincey opens the second part of his essay on style. He says: "It is a natural resource that ^{The completed system.} whatsoever we find it difficult to investigate as a result, we endeavour to follow as a growth. Failing analytically to probe its nature, historically we seek relief to our perplexities by tracing its origin. . . . Thus for instance when any feudal institution (be it Gothic, Norman, or Anglo-Saxon) eludes our deciphering faculty from the imperfect records of its use and operation, then we endeavour conjecturally to amend our knowledge by watching the circumstances in which that institution arose." The temptation to use the larger part of any space allotted to the history of feudalism for a discussion of origins does not arise alone from greater interest in that phase of the subject. It is almost impossible even with the most discriminating care to give a brief account of completed feudalism and convey no wrong impression. We use the term "feudal system" for convenience sake, but with a degree of impropriety if it conveys the meaning "systematic." Feudalism in its most flourishing age was anything but systematic. It was confusion roughly organized. Great diversity prevailed everywhere, and we should not be surprised to find some different fact or custom in every lordship. Anglo-Norman feudalism attained a logical completeness and a uniformity of practice which, in the feudal age proper, can hardly be found elsewhere through so large a territory; but in Anglo-Norman feudalism the exception holds perhaps as large a place as the regular, and the uniformity itself was due to the most serious of exceptions from the feudal point of view—centralization under a powerful monarchy.

But too great emphasis upon variation conveys also a wrong impression. Underlying all the apparent confusion of fact and practice were certain fundamental principles and relationships, which were alike everywhere, and which really gave shape to everything that was feudal, no matter what its form might be. The chief of these are the following: the relation of vassal and lord; the principle that every holder of land is a tenant and not an owner, until the highest rank is reached, sometimes even the conception rules in that rank; that the tenure by which a thing of value is held is one of honourable service, not intended to be economic, but moral and political in character; the principle of mutual obligations of loyalty, protection and service binding together all the ranks of this society from the highest to the lowest; and the principle of contract between lord and tenant, as determining all rights, controlling their modification, and forming the foundation of all law. There was actually in fact and practice a larger uniformity than this short list implies, because these principles tended to express themselves in similar forms, and because historical derivation from a common source in Frankish feudalism tended to preserve some degree of uniformity in the more important usages.

The foundation of the feudal relationship proper was the fief, which was usually land, but might be any desirable thing, as an office, a revenue in money or kind, the right to collect a toll, or operate a mill. In return for the fief, the man became the vassal of his lord; he knelt before him, and, with his hands between his lord's hands, promised him fealty and service; he rose to his feet and took the oath of fealty which bound him to the obligations he had assumed in homage; he received from his lord ceremonial investiture with the fief. The faithful performance of all the duties he had assumed in homage constituted the vassal's right and title to his fief. So long as they were fulfilled, he, and his heir after him, held the fief as his property, practically and in relation to all under tenants as if

he were the owner. In the ceremony of homage and investiture, which is the creative contract of feudalism, the obligations assumed by the two parties were, as a rule, not specified in exact terms. They were determined by local custom. What they were, however, was as well known, as capable of proof, and as adequate a check on innovation by either party, as if committed to writing. In many points of detail the vassal's services differed widely in different parts of the feudal world. We may say, however, that they fall into two classes, general and specific. The general included all that might come under the idea of loyalty, seeking the lord's interests, keeping his secrets, betraying the plans of his enemies, protecting his family, &c. The specific services are capable of more definite statement, and they usually received exact definition in custom and sometimes in written documents. The most characteristic of these was the military service, which included appearance in the field on summons with a certain force, often armed in a specified way, and remaining a specified length of time. It often included also the duty of guarding the lord's castle, and of holding one's own castle subject to the plans of the lord for the defence of his fief. Hardly less characteristic was court service, which included the duty of helping to form the court on summons, of taking one's own cases to that court instead of to some other, and of submitting to its judgments. The duty of giving the lord advice was often demanded and fulfilled in sessions of the court, and in these feudal courts the obligations of lord and vassal were enforced, with an ultimate appeal to war. Under this head may be enumerated also the financial duties of the vassal, though these were not regarded by the feudal law as of the nature of the tenure, *i.e.* failure to pay them did not lead to confiscation, but they were collected by suit and distraint like any debt. They did not have their origin in economic considerations, but were either intended to mark the vassal's tenant relation, like the relief, or to be a part of his service, like the aid, that is, he was held to come to the aid of his lord in a case of financial or military necessity. The relief was a sum paid by the heir for the lord's recognition of his succession. The aids were paid on a few occasions, determined by custom, where the lord was put to unusual expense, as for his ransom when captured by the enemy, or for the knighting of his eldest son. There was great variety regarding the occasion and amount of these payments, and in some parts of the feudal world they did not exist at all. The most lucrative of the lord's rights were wardship and marriage, but the feudal theory of these also was non-economic. The fief fell into the hands of the lord, and he enjoyed its revenues during the minority of the heir, because the minor could not perform the duties by which it was held. The heiress must marry as the lord wished, because he had a right to know that the holder of the fief could meet the obligations resting upon it. Both wardship and marriage were, however, valuable rights which the lord could exercise himself or sell to others. These were by no means the only rights and duties which could be described as existing in feudalism, but they are the most characteristic, and on them, or some of them, as a foundation, the whole structure of feudal obligation was built, however detailed.

Ideally regarded, feudalism covered Europe with a network of these fiefs, rising in graded ranks one above the other from the smallest, the knight's fee, at the bottom, to the king at the top, who was the supreme landowner, or who held the kingdom from God. Actually not even in the most regular of feudal countries, like England or Germany, was there any fixed gradation of rank, titles or size. A knight might hold directly of the king, a count of a viscount, a bishop of an abbot, or the king himself of one of his own vassals, or even of a vassal's vassal, and in return his vassal's vassal might hold another fief directly of him. The case of the count of Champagne, one of the peers of France, is a famous example. His great territory was held only in small part of the king of France. He held a portion of a foreign sovereign, the emperor, and other portions of the duke of Burgundy, of two archbishops, of four bishops, and of the abbot of St Denis. Frequently did great lay lords, as in this case, hold lands by feudal tenure of ecclesiastics.

It is now possible perhaps to get some idea of the way in which the government of a feudal country was operated. The early German governments whose chief functions, military, judicial, financial, legislative, were carried on by the freemen of the nation because they were members of the body politic, and were performed as duties owed to the community for its defence and sustenance, no longer existed. New forms of organization had arisen in which indeed these conceptions had not entirely disappeared, but in which the vast majority of cases a wholly different idea of the ground of service and obligation prevailed. Superficially, for example, the feudal court differed but little from its Teutonic predecessor. It was still an assembly court. Its procedure was almost the same as the earlier. It often included the same classes of men. Saxon Witenagemot and Norman *Curia regis* seem very much alike. But the members of the feudal court met, not to fulfil a duty owed to the community, but a private obligation which they had assumed in return for the fiefs they held, and in the history of institutions it is differences of this sort which are the determining principles. The feudal state was one in which, as it has been said, private law had usurped the place of public law. Public duty had become private obligation. To understand the feudal state it is essential to make clear to one's mind that all sorts of services, which men ordinarily owe to the public or to one another, were translated into a form of rent paid for the use of land, and defined and enforced by a private contract. In every feudal country, however, something of the earlier conception survived. A general military levy was occasionally made. Something like taxation occasionally occurred, though the government was usually sustained by the scanty feudal payments, by the proceeds of justice and by the income of domain manors. About the office of king more of this earlier conception gathered than elsewhere in the state, and gradually grew, aided not merely by traditional ideas, but by the active influence of the Bible, and soon of the Roman law. The kingship formed the nucleus of new governments as the feudal system passed away.

Actual government in the feudal age was primitive and undifferentiated. Its chief and almost only organ, for kingdom and barony alike, was the *curia*—a court formed of the vassals. This acted at once and without any consciousness of difference of function, as judiciary, as legislature, in so far as there was any in the feudal period, and as council, and it exercised final supervision and control over revenue and administration. Almost all the institutions of modern states go back to the *curia regis*, branching off from it at different dates as the growing complexity of business forced differentiation of function and personnel. In action it was an assembly court, deciding all questions by discussion and the weight of opinion, though its decisions obtained their legal validity by the formal pronouncement of the presiding member, *i.e.* of the lord whose court it was. It can readily be seen that in a government of this kind the essential operative element was the baron. So long as the government remained dependent on the baron, it remained feudal in its character. When conditions so changed that government could free itself from its dependence on the baron, feudalism disappeared as the organization of society; when a professional class arose to form the judiciary, when the increased circulation of money made regular taxation possible and enabled the government to buy military and other services, and when better means of intercommunication and the growth of common ideas made a wide centralization possible and likely to be permanent. Feudalism had performed a great service, during an age of disintegration, by maintaining a general framework of government, while allowing the locality to protect and care for itself. When the function of protection and local supervision could be resumed by the general government the feudal age ended. In nearly all the states of Europe this end was reached during, or by the close of, the 13th century.

At the moment, however, when feudalism was disappearing as the organization of society, it gave rise to results which in a sense continued it into after ages and even to our own day. One of these results was the system of law which it created.

As feudalism passed from its age of supremacy into its age of decline, its customs tended to crystallize into fixed forms.

Decline and survivals.

At the same time a class of men arose interested in these forms for their own sake, professional lawyers or judges, who wrote down for their own and others' use the feudal usages with which they were familiar.

The great age of these codes was the 13th century, and especially the second half of it. The codes in their turn tended still further to harden these usages into fixed forms, and we may date from the end of the 13th century an age of feudal law regulating especially the holding and transfer of land, and much more uniform in character than the law of the feudal age proper. This was particularly the case in parts of France and Germany where feudalism continued to regulate the property relations of lords and vassals longer than elsewhere, and where the underlying economic feudalism remained in large part unchanged. In this later pseudo-feudalism, however, the political had given way to the economic, and customs which had once had no economic significance came to have that only.

Feudalism formed the starting-point also of the later social nobilities of Europe. They drew from it their titles and ranks and many of their regulative ideas, though these were formed into more definite and regular systems than ever existed in feudalism proper. It was often the policy of kings to increase the social privileges and legal exemptions of the nobility while taking away all political power, so that it is necessary in the history of institutions to distinguish sharply between these nobilities and the feudal baronage proper. It is only in certain backward parts of Europe that the terms feudal and baronage in any technical sense can be used of the nobility of the 15th century.

(G. B. A.)

BIBLIOGRAPHY.—For more detailed information the reader is referred to the articles ENGLISH LAW; FRANCE: *French Law and Institutions*, VILLENAGE; MANOR; SCUTAGE; KNIGHT SERVICE; HIDE. For a general sketch of Feudalism the chapters in tome ii. of the *Histoire générale* of Lavis and Rambaud should be consulted. Other general works are J. T. Abdy, *Feudalism* (1890); Paul Roth, *Feudalität und Unterthanverband* (Weimar, 1863); and *Geschichte des Beneficialwesens* (1850); M. M. Kovalevsky, *Ökonomische Entwicklung Europas* (1902); E. de Laveleye, *De la propriété et de ses formes primitives* (1891); and *The Origin of Property in Land*, a translation by M. Ashley from the works of N. D. Fustel de Coulanges, with an introductory chapter by Professor W. J. Ashley. Two other works of value are Sir H. S. Maine, *Village Communities in the East and West* (1876); and Léon Gautier, *La Chevalerie* (Paris, 1884; Eng. trans. by Henry Frith, *Chivalry*, London, 1891).

For feudalism in England see the various constitutional histories, especially W. Stubbs, *Constitutional History of England*, vol. i. (ed. 1897). Very valuable also are the writings of Mr J. H. Round, of Professor F. W. Maitland and of Professor P. Vinogradoff. Among Round's works may be mentioned *Feudal England* (1895); *Geoffrey de Mandeville* (1892); and *Studies on the Red Book of the Exchequer* (1898). Maitland's *Domesday Book and Beyond* (Cambridge, 1897) is indispensable; and the same remark applies to his *History of English Law before the time of Edward I.* (Cambridge, 1895), written in conjunction with Sir Frederick Pollock. Vinogradoff has illuminated the subject in his *Villainage in England* (1892) and his *English Society in the 11th century* (1908). See also J. F. Baldwin, *The Scutage and Knight Service in England* (Chicago, 1897); Rudolf Gneist, *Adel und Ritterschaft in England* (1853); and F. Seebohm, *The English Village Community* (1883).

For feudalism in France see N. D. Fustel de Coulanges, *Histoire des institutions politiques de l'ancienne France (Les Origines du système féodal, 1890; Les Transformations de la royauté pendant l'époque carolingienne, 1892)*; A. Luchaire, *Histoire des institutions monarchiques de la France sous les premiers Capétiens, 987-1180* (2nd ed., 1890); and *Manuel des institutions françaises: période des Capétiens directs* (1892); J. Flach, *Les Origines de l'ancienne France* (1886-1893); Paul Viollet, *Droit public: Histoire des institutions politiques et administratives de la France* (1890-1898); and Henri Sée, *Les classes rurales et le régime domanial* (1901).

For Germany see G. Waitz, *Deutsche Verfassungsgeschichte* (Kiel and Berlin, 1844 foll.); H. Brunner, *Grundzüge der deutschen Rechtsgeschichte* (Leipzig, 1901); V. Menzel, *Die Entstehung des Lebenswesens* (Berlin, 1890); and G. L. von Maurer's works on the early institutions of the Germans.

FEUERBACH, ANSELM (1829-1880), German painter, born at Spire, the son of a well-known archaeologist, was the leading classicist painter of the German 19th-century school. He was the first to realize the danger arising from contempt of technique, that mastery of craftsmanship was needed to express even the

loftiest ideas, and that an ill-drawn coloured cartoon can never be the supreme achievement in art. After having passed through the art schools of Düsseldorf and Munich, he went to Antwerp and subsequently to Paris, where he benefited by the teaching of Couture, and produced his first masterpiece, "Hafiz at the Fountain" in 1852. He subsequently worked at Karlsruhe, Venice (where he fell under the spell of the greatest school of colourists), Rome and Vienna. He was steeped in classic knowledge, and his figure compositions have the statuesque dignity and simplicity of Greek art. Disappointed with the reception given in Vienna to his design of "The Fall of the Titans" for the ceiling of the Museum of Modelling, he went to live in Venice, where he died in 1880. His works are to be found at the leading public galleries of Germany; Stuttgart has his "Iphigenia"; Karlsruhe, the "Dante at Ravenna"; Munich, the "Medea"; and Berlin, "The Concert," his last important picture. Among his chief works are also "The Battle of the Amazons," "Pietà," "The Symposium of Plato," "Orpheus and Eurydice" and "Ariosto in the Park of Ferrara."

FEUERBACH, LUDWIG ANDREAS (1804-1872), German philosopher, fourth son of the eminent jurist (see below), was born at Landshut in Bavaria on the 28th of July 1804. He matriculated at Heidelberg with the intention of pursuing an ecclesiastical career. Through the influence of Prof. Daub he was led to an interest in the then predominant philosophy of Hegel and, in spite of his father's opposition, went to Berlin to study under the master himself. After two years' discipleship the Hegelian influence began to slacken. "Theology," he wrote to a friend, "I can bring myself to study no more. I long to take nature to my heart, that nature before whose depth the faint-hearted theologian shrinks back; and with nature man, man in his entire quality." These words are a key to Feuerbach's development. He completed his education at Erlangen with the study of natural science. His first book, published anonymously, *Gedanken über Tod und Unsterblichkeit* (1830, 3rd ed. 1876), contains an attack upon personal immortality and an advocacy of the Spinozistic immortality of reabsorption in nature. These principles, combined with his embarrassed manner of public speaking, debarred him from academic advancement. After some years of struggling, during which he published his *Geschichte der neueren Philosophie* (2 vols., 1833-1837, 2nd ed. 1844), and *Abälard und Heloise* (1834, 3rd ed. 1877), he married in 1837 and lived a rural existence at Bruckberg near Nuremberg, supported by his wife's share in a small porcelain factory. In two works of this period, *Pierre Bayle* (1838) and *Philosophie und Christentum* (1839), which deal largely with theology, he held that he had proved "that Christianity has in fact long vanished not only from the reason but from the life of mankind, that it is nothing more than a fixed idea" in flagrant contradiction to the distinctive features of contemporary civilization. This attack is followed up in his most important work, *Das Wesen des Christentums* (1841), which was translated into English (*The Essence of Religion*, by George Eliot, 1853, 2nd ed. 1881), French and Russian. Its aim may be described shortly as an effort to humanize theology. He lays it down that man, so far as he is rational, is to himself his own object of thought. Religion is consciousness of the infinite. Religion therefore is "nothing else than the consciousness of the infinity of the consciousness; or, in the consciousness of the infinite, the conscious subject has for his object the infinity of his own nature." Thus God is nothing else than man: he is, so to speak, the outward projection of man's inward nature. In part 1 of his book he develops what he calls the "true or anthropological essence of religion." Treating of God in his various aspects "as a being of the understanding," "as a moral being or law," "as love" and so on, Feuerbach shows that in every aspect God corresponds to some feature or need of human nature. "If man is to find contentment in God, he must find himself in God." In part 2 he discusses the "false or theological essence of religion," i.e. the view which regards God as having a separate existence over against man. Hence arise various mistaken beliefs, such as the belief in revelation which not only injures the moral

sence, but also "poisons, nay destroys, the divinest feeling in man, the sense of truth," and the belief in sacraments such as the Lord's Supper, a piece of religious materialism of which "the necessary consequences are superstition and immorality." In spite of many admirable qualities both of style and matter the *Essence of Christianity* has never made much impression upon British thought. To treat the actual forms of religion as expressions of our various human needs is a fruitful idea which deserves fuller development than it has yet received; but Feuerbach's treatment of it is fatally vitiated by his subjectivism. Feuerbach denied that he was rightly called an atheist, but the denial is merely verbal: what he calls "theism" is atheism in the ordinary sense. Feuerbach labours under the same difficulty as Fichte; both thinkers strive in vain to reconcile the religious consciousness with subjectivism.

During the troubles of 1848-1849 Feuerbach's attack upon orthodoxy made him something of a hero with the revolutionary party; but he never threw himself into the political movement, and indeed had not the qualities of a popular leader. During the period of the diet of Frankfort he had given public lectures on religion at Heidelberg. When the diet closed he withdrew to Bruckberg and occupied himself partly with scientific study, partly with the composition of his *Theogonie* (1857). In 1860 he was compelled by the failure of the porcelain factory to leave Bruckberg, and he would have suffered the extremity of want but for the assistance of friends supplemented by a public subscription. His last book, *Gottheit, Freiheit und Unsterblichkeit*, appeared in 1866 (2nd ed., 1890). After a long period of decay he died on the 13th of September 1872.

Feuerbach's influence has been greatest upon the anti-Christian theologians such as D. F. Strauss, the author of the *Leben Jesu*, and Bruno Bauer, who like Feuerbach himself had passed over from Hegelianism to a form of naturalism. But many of his ideas were taken up by those who, like Arnold Ruge, had entered into the struggle between church and state in Germany, and those who, like F. Engels and Karl Marx, were leaders in the revolt of labour against the power of capital. His work was too deliberately unsystematic ("keine Philosophie ist meine Philosophie") ever to make him a power in philosophy. He expressed in an eager, disjointed, but condensed and laboured fashion, certain deep-lying convictions—that philosophy must come back from unsubstantial metaphysics to the solid facts of human nature and natural science, that the human body was no less important than the human spirit ("Der Mensch ist was er isst") and that Christianity was utterly out of harmony with the age. His convictions gained weight from the simplicity, uprightness and diligence of his character; but they need a more effective justification than he was able to give them.

His works appeared in 10 vols. (Leipzig, 1846-1866); his correspondence has been edited with an indifferent biography by Karl Grün (1874). See A. Lévy, *La Philosophie de Feuerbach* (1904); M. Meyer, *L. Feuerbach's Moralphilosophie* (Berlin, 1899); E. v. Hartmann, *Geschichte d. Metaphysik* (Leipzig, 1899-1900), ii. 437-444; F. Engels, *L. Feuerbach und d. Ausgang d. class. deutsch. Philos.* (2nd ed., 1895). (H. St.)

FEUERBACH, PAUL JOHANN ANSELM, RITTER VON (1775-1833), German jurist and writer on criminal law, was born at Hainichen near Jena on the 14th of November 1775. He received his early education at Frankfort on Main, whither his family had removed soon after his birth. At the age of sixteen, however, he ran away from home, and, going to Jena, was helped by relations there to study at the university. In spite of poor health and the most desperate poverty, he made rapid progress. He attended the lectures of Karl Leonhard Reinhold and Gottlieb Hufeland, and soon published some literary essays of more than ordinary merit. In 1795 he took the degree of doctor in philosophy, and in the same year, though he only possessed 150 thalers (£22 : 10s.), he married. It was this step which led him to success and fame, by forcing him to turn from his favourite studies of philosophy and history to that of law, which was repugnant to him, but which offered a prospect of more rapid advancement. His success in this new and uncongenial sphere was soon assured. In 1796 he published *Kritik des natürlichen*

Rechts als Propädeutik zu einer Wissenschaft der natürlichen Rechte, which was followed, in 1798, by *Anti-Hobbes, oder über die Grenzen der bürgerlichen Gewalt*, a dissertation on the limits of the civil power and the right of resistance on the part of subjects against their rulers, and by *Philosophische, juristische Untersuchungen über das Verbrechen des Hochverraths*. In 1799 he obtained the degree of doctor of laws. Feuerbach, as the founder of a new theory of penal law, the so-called "psychological-coercive or intimidation theory," occupied a prominent place in the history of criminal science. His views, which he first made known in his *Revision der Grundsätze und Grundbegriffe des positiven peinlichen Rechts* (1799), were further elucidated and expounded in the *Bibliothek für die peinliche Rechtswissenschaft* (1800-1801), an encyclopaedic work produced in conjunction with Karl L. W. G. Grolmann and Ludwig Harscher von Almendingen, and in his famous *Lehrbuch des gemeinen in Deutschland geltenden peinlichen Rechts* (1801). These works were a powerful protest against vindictive punishment, and did much towards the reformation of the German criminal law. The *Carolina* (the penal code of the emperor Charles V.) had long since ceased to be respected. What in 1532 was an inestimable blessing, as a check upon the arbitrariness and violence of the effete German procedure, had in the course of time outlived its usefulness and become a source of evils similar to those it was enacted to combat. It availed nothing that, at the commencement of the 18th century, a freer and more scientific spirit had been breathed into Roman law; it failed to reach the criminal law. The administration of justice was, before Feuerbach's time, especially distinguished by two characteristics: the superiority of the judge to all law, and the blending of the judicial and executive offices, with the result that the individual was practically at the mercy of his prosecutors. This state of things Feuerbach set himself to reform, and using as his chief weapon the *Revision der Grundbegriffe* above referred to, was successful in his task. His achievement in the struggle may be summed up as: *nullum crimen, nulla poena sine lege* (no wrong and no punishment without a remedy). In 1801 Feuerbach was appointed extraordinary professor of law without salary, at the university of Jena, and in the following year accepted a chair at Kiel, where he remained two years. In 1804 he removed to the university of Landshut; but on being commanded by King Maximilian Joseph to draft a penal code for Bavaria (*Strafgesetzbuch für das Königreich Bayern*), he removed in 1805 to Munich, where he was given a high appointment in the ministry of justice and was ennobled in 1808. Meanwhile the practical reform of penal legislation in Bavaria was begun under his influence in 1806 by the abolition of torture. In 1808 appeared the first volume of his *Merkwürdige Criminalfälle*, completed in 1811—a work of deep interest for its application of psychological considerations to cases of crime, and intended to illustrate the inevitable imperfection of human laws in their application to individuals. In his *Betrachtungen über das Geschworenengericht* (1811) Feuerbach declared against trial by jury, maintaining that the verdict of a jury was not adequate legal proof of a crime. Much controversy was aroused on the subject, and the author's view was subsequently to some extent modified. The result of his labours was promulgated in 1813 as the Bavarian penal code. The influence of this code, the embodiment of Feuerbach's enlightened views, was immense. It was at once made the basis for new codes in Württemberg and Saxe-Weimar; it was adopted in its entirety in the grand-duchy of Oldenburg; and it was translated into Swedish by order of the king. Several of the Swiss cantons reformed their codes in conformity with it. Feuerbach had also undertaken to prepare a civil code for Bavaria, to be founded on the Code Napoléon. This was afterwards set aside, and the Codex Maximilianus adopted as a basis. But the project did not become law. During the war of liberation (1813-1814) Feuerbach showed himself an ardent patriot, and published several political brochures which, from the writer's position, had almost the weight of state manifestoes. One of these is entitled *Über deutsche Freiheit und Vertretung deutsche Völker durch Landstände* (1814). In 1814 Feuerbach was appointed second presi-

dent of the court of appeal at Bamberg, and three years later he became first president of the court of appeal at Anspach. In 1821 he was deputed by the government to visit France, Belgium, and the Rhine provinces for the purpose of investigating their juridical institutions. As the fruit of this visit, he published his treatises *Betrachtungen über Öffentlichkeit und Mündigkeit der Gerechtigkeitspflege* (1821) and *Über die Gerichtsverfassung und das gerichtliche Verfahren Frankreichs* (1825). In these he pleaded unconditionally for publicity in all legal proceedings. In his later years he took a deep interest in the fate of the strange foundling Kaspar Hauser (*q.v.*), which had excited so much attention in Europe; and he was the first to publish a critical summary of the ascertained facts, under the title of *Kaspar Hauser, ein Beispiel eines Verbrechens am Seelenleben* (1832). Shortly before his death appeared a collection of his *Kleine Schriften* (1833). Feuerbach, still in the full enjoyment of his intellectual powers, died suddenly at Frankfort, while on his way to the baths of Schwalbach, on the 29th of May 1833. In 1853 was published the *Leben und Wirken Ans. von Feuerbachs*, 2 vols., consisting of a selection of his letters and journals, with occasional notes by his fourth son Ludwig, the distinguished philosopher.

See also, for an estimate of Feuerbach's life and work, Marquardsen, in *Allgemeine deutsche Biographie*, vol. vi.; and an "in memoriam" notice in *Die allgemeine Zeitung* (Augsburg), 15th Nov. 1875, by Professor Dr Karl Binding of Leipzig University.

FEUILLANTS, CLUB OF THE, a political association which played a prominent part during the French Revolution. It was founded on the 16th of July 1791 by several members of the Jacobin Club, who refused to sign a petition presented by this body, demanding the deposition of Louis XVI. Among the dissident members were B. Barère and E. J. Sieyès, who were later joined by other politicians, among them being Dupont de Nemours. The name of Feuillants was popularly given to this group of men, because they met in the fine buildings which had been occupied by the religious order bearing this name, in the rue Saint-Honoré, near the Place Vendôme, in Paris. The members of the club preserved the title of *Amis de la Constitution*, as being a sufficient indication of the line they intended to pursue. This consisted in opposing everything not contained in the Constitution; in their opinion, the latter was in need of no modification, and they hated alike all those who were opposed to it, whether *émigrés* or Jacobins; they affected to avoid all political discussion, and called themselves merely a "conservative assembly."

This attitude they maintained after the Constituent Assembly had been succeeded by the Legislative, but not many of the new deputies became members of the club. With the rapid growth of extreme democratic ideas the Feuillants soon began to be looked upon as reactionaries, and to be classed with "aristocrats." They did, indeed, represent the aristocracy of wealth, for they had to pay a subscription of four louis, a large sum at that time, besides six livres for attendance. Moreover, the luxury with which they surrounded themselves, and the restaurant which they had annexed to their club, seemed to mock the misery of the half-starved proletariat, and added to the suspicion with which they were viewed, especially after the popular triumphs of the 20th of June and the 10th of August 1792 (see FRENCH REVOLUTION). A few days after the insurrection of the 10th of August, the papers of the Feuillants were seized, and a list was published containing the names of 841 members proclaimed as suspects. This was the death-blow of the club. It had made an attempt, though a weak one, to oppose the forward march of the Revolution, but, unlike the Jacobins, had never sent out branches into the provinces. The name of Feuillants, as a party designation, survived the club. It was applied to those who advocated a policy of "cowardly moderation," and *feuillantisme* was associated with *aristocratie* in the mouths of the sansculottes.

The act of separation of the Feuillants from the Jacobins was published in a pamphlet dated the 16th of July 1791, beginning with the words, *Les Membres de l'Assemblée nationale* . . . (Paris, 1791). The statutes of the club were also published in Paris. See also A. Aulard, *Histoire politique de la Révolution française* (Paris, 1903), 2nd ed., p. 153.

FEUILLET, OCTAVE (1821-1890), French novelist and dramatist, was born at Saint-Lô, Manche, on the 11th of August 1821. He was the son of a Norman gentleman of learning and distinction, who would have played a great part in politics "sans ses diables de nerfs," as Guizot said. This nervous excitability was inherited, though not to the same excess, by Octave, whose mother died in his infancy and left him to the care of the hypersensitive invalid. The boy was sent to the lycée Louis-le Grand, in Paris, where he achieved high distinction, and was destined for the diplomatic service. In 1840 he appeared before his father at Saint-Lô, and announced that he had determined to adopt the profession of literature. There was a stormy scene, and the elder Feuillel cut off his son, who returned to Paris and lived as best he could by a scanty journalism. In company with Paul Bocage he began to write for the stage, and not without success; at all events, he continued to exist until, three years after the quarrel, his father consented to forgive him. Enjoying a liberal allowance, he now lived in Paris in comfort and independence, and he published his early novels, none of which is quite of sufficient value to retain the modern reader. The health and spirits of the elder M. Feuillel, however, having still further declined, he summoned his son to leave Paris and bury himself as his constant attendant in the melancholy château at Saint-Lô. This was to demand a great sacrifice, but Octave Feuillel cheerfully obeyed the summons. In 1851 he married his cousin, Mlle Valérie Feuillel, who helped him to endure the mournful captivity to which his filial duty bound him. Strangely enough, in this exile—rendered still more irksome by his father's mania for solitude and by his tyrannical temper—the genius of Octave Feuillel developed. His first definite success was gained in the year 1852, when he published the novel *Bellah* and produced the comedy *La Crise*. Both were reprinted from the *Revue des deux mondes*, where many of his later novels also appeared. He wrote books which have long held their place, *La Petite Favourite* (1857), *Dalila* (1857), and in particular that universal favourite, *Le Roman d'un jeune homme pauvre* (1858). He himself fell into a nervous state in his "prison," but he was sustained by the devotion and intelligence of his wife and her mother. In 1857, having been persuaded to make a play of the novel of *Dalila*, he brought out this piece at the Vaudeville, and enjoyed a brilliant success; on this occasion he positively broke through the *consigne* and went up to Paris to see his play rehearsed. His father bore the shock of his temporary absence, and the following year Octave ventured to make the same experiment on occasion of the performance of *Un Jeune Homme pauvre*. To his infinite chagrin, during this brief absence his father died. Octave was now, however, free, and the family immediately moved to Paris, where they took part in the splendid social existence of the Second Empire. The elegant and distinguished young novelist became a favourite at court; his pieces were performed at Compiègne before they were given to the public, and on one occasion the empress Eugénie deigned to play the part of Mme de Pons in *Les Portraits de la Marquise*. Feuillel did not abandon the novel, and in 1862 he achieved a great success with *Sibylle*. His health, however, had by this time begun to decline, affected by the sad death of his eldest son. He determined to quit Paris, where the life was far too exciting for his nerves, and to regain the quietude of Normandy. The old château of the family had been sold, but he bought a house called "Les Pailiers" in the suburbs of Saint-Lô, and there he lived, buried in his roses, for fifteen years. He was elected to the French Academy in 1862, and in 1868 he was made librarian of Fontainebleau palace, where he had to reside for a month or two in each year. In 1867 he produced his masterpiece of *Monsieur de Camors*, and in 1872 he wrote *Julia de Trécœur*, which is hardly less admirable. His last years, after the sale of "Les Pailiers," were passed in a ceaseless wandering, the result of the agitation of his nerves. He was broken by sorrow and by ill-health, and when he passed away in Paris on the 29th of December 1890, his death was a release. His last book was *Honneur d'artiste* (1890). Among the too-numerous writings of Feuillel, the novels have lasted longer than the dramas;

of the former three or four seem destined to retain their charm as classics. He holds a place midway between the romanticists and the realists, with a distinguished and lucid portraiture of life which is entirely his own. He drew the women of the world whom he saw around him with dignity, with indulgence, with extraordinary penetration and clairvoyance. There is little description in his novels, which sometimes seem to move on an almost bare and colourless stage, but, on the other hand, the analysis of motives, of emotions, and of "the fine shades" has rarely been carried further. Few have written French with greater purity than Feuillet, and his style, reserved in form and never excessive in ornament, but full of wit and delicate animation, is in admirable uniformity with his subjects and his treatment. It is probably in *Sibylle* and in *Julia de Trécœur* that he can now be studied to most advantage, though *Monsieur de Camors* gives a greater sense of power, and though *Le Roman d'un jeune homme pauvre* still preserves its popularity.

See also Sainte-Beuve, *Nouveaux Lundis*, vol. v.; F. Brunetière, *Nouveaux Essais sur la littérature contemporaine* (1895). (E. G.)

FEUILLETON (a diminutive of the Fr. *feuillet*, the leaf of a book), originally a kind of supplement attached to the political portion of French newspapers. Its inventor was Bertin the elder, editor of the *Débats*. It was not usually printed on a separate sheet, but merely separated from the political part of the newspaper by a line, and printed in smaller type. In French newspapers it consists chiefly of non-political news and gossip, literature and art criticism, a chronicle of the fashions, and epigrams, charades and other literary trifles; and its general characteristics are lightness, grace and sparkle. The *feuilleton* in its French sense has never been adopted by English newspapers, though in various modern journals (in the United States especially) the sort of matter represented by it is now included. But the term itself has come into English use to indicate the installment of a serial story printed in one part of a newspaper.

FEUQUIÈRES, ISAAC MANASSÈS DE PAS, MARQUIS DE (1590-1640), French soldier, came of a distinguished family of which many members held high command in the civil wars of the 16th century. He entered the Royal army at the age of thirty, and soon achieved distinction. In 1626 he served in the Valtelline, and in 1628-1629 at the celebrated siege of La Rochelle, where he was taken prisoner. In 1629 he was made *Maréchal de Camp*, and served in the fighting on the southern frontiers of France. After occupying various military positions in Lorraine, he was sent as an ambassador into Germany, where he rendered important services in negotiations with Wallenstein. In 1636 he commanded the French corps operating with the duke of Weimar's forces (afterwards Turenne's "Army of Weimar"). With these troops he served in the campaigns of 1637 (in which he became lieutenant-general), 1638 and 1639. At the siege of Thionville (Diedenhofen) he received a mortal wound. His *lettres inédites* appeared (ed. Gallois) in Paris in 1845.

His son ANTOINE MANASSÈS DE PAS, Marquis de Feuquières (1648-1711), was born at Paris in 1648, and entered the army at the age of eighteen. His conduct at the siege of Lille in 1667, where he was wounded, won him promotion to the rank of captain. In the campaigns of 1672 and 1673 he served on the staff of Marshal Luxemburg, and at the siege of Oudenarde in the following year the king gave him command of the Royal Marine regiment, which he held until he obtained a regiment of his own in 1676. In 1688 he served as a brigadier at the siege of Philipsburg, and afterwards led a ravaging expedition into south Germany, where he acquired much booty. Promoted *Maréchal de Camp*, he served under Catinat against the Waldenses, and in the course of the war won the nickname of the "Wizard." In 1692 he made a brilliant defence of Speierbach against greatly superior forces, and was rewarded with the rank of lieutenant-general. He bore a distinguished part in Luxemburg's great victory of Neerwinden or Landen in 1693. Marshal Villeroi impressed him less favourably than his old commander Luxemburg, and the resumption of war in 1701 found him in disfavour in consequence. The rest of his life, embittered by

the refusal of the marshal's baton, he spent in compiling his celebrated memoirs, which, coloured as they were by the personal animosities of the writer, were yet considered by Frederick the Great and the soldiers of the 18th century as the standard work on the art of war as a whole. He died in 1711. The *Mémoires sur la guerre* appeared in the same year and new editions were frequently published (Paris 1711, 1725, 1735, &c., London 1736, Amsterdam subsequently). An English version appeared in London 1737, under the title *Memoirs of the Marquis de Feuquières*, and a German translation (*Feuquières geheime Nachrichten*) at Leipzig 1732, 1738, and Berlin 1786. They deal in detail with every branch of the art of war and of military service.

FÉVAL, PAUL HENRI CORENTIN (1817-1887), French novelist and dramatist, was born on the 27th of September 1817, at Rennes in Brittany, and much of his best work deals with the history of his native province. He was educated for the bar, but after his first brief he went to Paris, where he gained a footing by the publication of his "Club des phoques" (1841) in the *Revue de Paris*. The *Mystères de Londres* (1844), in which an Irishman tries to avenge the wrongs of his countrymen by seeking the annihilation of England, was published under the ingenious pseudonym "Sir Francis Trolopp." Others of his novels are: *Le Fils du diable* (1846); *Les Compagnons du silence* (1857); *Le Bossu* (1858); *Le Poisson d'or* (1863); *Les Habits noirs* (1863); *Jean le diable* (1868), and *Les Compagnons du trésor* (1872). Some of his novels were dramatized, *Le Bossu* (1863), in which he had M. Victorien Sardou for a collaborator, being especially successful in dramatic form. His chronicles of crime exercised an evil influence, eventually recognized by the author himself. In his later years he became an ardent Catholic, and occupied himself in revising his earlier works from his new standpoint and in writing religious pamphlets. Reverses of fortune and consequent overwork undermined his mental and bodily health, and he died of paralysis in the monastery of the Brothers of Saint John in Paris on the 8th of March 1887.

His son, PAUL FÉVAL (1860-), became well known as a novelist and dramatist. Among his works are *Nouvelles* (1890), *Maria Laura* (1891), and *Chantepie* (1896).

FEVER (Lat. *febris*, connected with *fervere*, to burn), a term generally used to include all conditions in which the normal temperature of the animal body is markedly exceeded for any length of time. When the temperature reaches as high a point as 106° F. the term hyperpyrexia (excessive fever) is applied, and is regarded as indicating a condition of danger; while, if it exceeds 107° or 108° for any length of time, death almost always results. The diseases which are called specific fevers, because of its being a predominant factor in them, are discussed separately under their ordinary names. Occasionally in certain specific fevers and febrile diseases the temperature may attain the elevation of 110°-112° prior to the fatal issue. For the treatment of fever in general, see THERAPEUTICS.

Pathology.—Every rise of temperature is due to a disturbance in the heat-regulating mechanism, the chief variable in which is the action of the skin in eliminating heat (see ANIMAL HEAT). Although for all practical purposes this mechanism works satisfactorily, it is not by any means perfect, and many physiological conditions cause a transient rise of temperature; e.g. severe muscular exercise, in which the cutaneous eliminating mechanism is unable at once to dispose of the increased amount of heat produced in the muscles. Pathologically, the heat-regulating mechanism may be disturbed in three different ways: 1st, by mechanical interference with the nervous system; 2nd, by interference with heat elimination; 3rd, by the action of various poisons.

1. In the human subject, fever the result of *mechanical interference* with the nervous system rarely occurs, but it can readily be produced in the lower animals by stimulating certain parts of the great brain, e.g. the anterior portion of the corpus striatum. This leads to a rise of temperature with increased heat production. The high temperature seems to cause disintegration of cell protoplasm and increased excretion of nitrogen and of carbonic acid. Possibly some of the cases of high temperature recorded

after injuries to the nervous system may be caused in this way; but some may also be due to stimulation of vaso-constrictor fibres to the cutaneous vessels diminishing heat elimination. So far the pathology of this condition has not been studied with the same care that has been devoted to the investigation of the third type of fever.

2. Fever may readily be produced by *interference with heat elimination*. This has been done by submitting dogs to a temperature slightly below that of the rectum, and it is seen in man in *Sunstroke*. The typical nervous symptoms of fever are thus produced, and the rate of chemical change in the tissues is accelerated, as is shown by the increased excretion of carbonic acid. The protoplasm is also injured and the proteids are broken down, and thus an increased excretion of nitrogen is produced and the cells undergo degenerative changes.

3. The products of various micro-organisms have a toxic action on the protoplasm of a large number of animals, and among the symptoms of this toxic action one of the most frequent is a rise in temperature. While this is by no means a necessary accompaniment, its occurrence is so general that the term *Fever* has been applied to the general reaction of the organism to the microbial poison. Toxins which cause a marked rise of temperature in men may cause a fall in other animals. It is not the alteration of temperature which is the great index of the severity of the struggle between the host and the parasite, but the death and removal to a greater or lesser extent of the protoplasm of the host. In this respect fever resembles poisoning with phosphorus and arsenic and other similar substances. The true measure of the intensity of a fever is the extent of disintegration of protoplasm, and this may be estimated by the amount of nitrogen excreted in the urine. The increased disintegration of protoplasm is also indicated by the rise in the excretion of sulphur and phosphorus and by the appearance in the urine of acetone, aceto-acetic and β -oxybutyric acids (see *NUTRITION*). Since the temperature is generally proportionate to the intensity of the toxic action, its height is usually proportionate to the excretion of nitrogen. But sometimes the rise of temperature is not marked, while the excretion of nitrogen is very decidedly increased. When the temperature is sufficiently elevated, the heat has of itself an injurious action on the protoplasm, and tends to increase disintegration just as when heat elimination is experimentally retarded. But the increase due to rise of temperature is small compared to that produced by the destructive action of the microbial products. In the beginning of a fever the *activity of the metabolism* is not increased to any marked extent, and any increase is necessarily largely due to the greater activity of the muscles of the heart and respiratory mechanism, and to the muscular contractions which produce the initial rigors. Thus the excretion of carbon dioxide—the great measure of the activity of metabolism—is not usually increased, and there is no evidence of an increased combustion. In the later stages the increased temperature may bring about an acceleration in the rate of chemical change; but this is comparatively slight, less in fact than the increase observed on taking muscular exercise after rest. The *rise of temperature* is primarily due to diminished heat elimination. This diminished giving off of heat was demonstrated by means of the calorimeter by I. Rosenthal, while E. Maragliano showed that the cutaneous vessels are contracted. Even in the later stages, until defervescence occurs, heat elimination is inadequate to get rid of the heat produced.

The toxic action is manifested not only by the increased disintegration of protoplasm, but also by disturbances in the functions of the various organs. The activity of the *digestive glands* is diminished and appetite is lost. Food is therefore not taken, although when taken it appears to be absorbed in undiminished quantities. As a result of this the patient suffers from inanition, and lives largely on his own fats and proteids, and for this reason rapidly emaciates. The functions of the *liver* are also diminished in activity. Glycogen is not stored in the cells, and the bile secretion is modified, the essential constituents disappearing almost entirely in some cases. The

production of urea is also interfered with, and the proportion of nitrogen in the urine not in the urea increases. This is in part due to the increased disintegration of proteids setting free sulphur and phosphorus, which, oxidized into sulphuric and phosphoric acids, combine with the ammonia which would otherwise have been changed to urea. Thus the proportion of ammonia in the urine is increased. Concurrently with these alterations in the functions of the liver-cells, a condition of granular degeneration and probably a state of fatty degeneration makes its appearance. That the functional activity of the *kidneys* is modified, is shown by the frequent appearance of proteoses or of albumen and globulin in the urine. Frequently the toxin acts very markedly on the protoplasm of the kidney epithelium, and causes a shedding of the cells and sometimes inflammatory reaction. The *muscles* are weakened, but so far no satisfactory study has been made of the influence of microbial poisons on muscular contraction. A granular and fatty degeneration supervenes, and the fibres waste. The *nervous structures*, especially the nerve-cells, are acted upon, and not only is their functional activity modified, but they also undergo structural changes of a chromatolytic nature. The *blood* shows two important changes—first, a fall in the alkalinity due to the products of disintegration of protoplasm; and, secondly, an increase in the number of leucocytes, and chiefly in the polymorpho-nuclear variety. This is best marked in pneumonia, where the normal number is often increased twofold and sometimes more than tenfold, while it is altogether absent in enteric fever.

An interesting general modification in the metabolism is the enormous fall in the excretion of chlorine, a fall far in excess of what could be accounted for by inanition, and out of all proportion to the fall in the sodium and potassium with which the chlorine is usually combined in the urine. The fevered animal in fact stores chlorine in its tissues, though in what manner and for what reason is not at present known.

AUTHORITIES.—Von Noorden, *Lehrbuch der Pathologie des Stoffwechsels* (Berlin, 1893); *Metabolism and Practical Medicine*, vol. ii., article "Fever" by F. Kraus (1907); Dr A. Rabe, *Die modernen Fiebertheorien* (Berlin, 1894); Dr G. B. Ughetti, *Das Fieber*, trans. by Dr R. Teuscher (Jena, 1895); Dr M. Lövit, "Die Lehre von Fieber," *Vorlesungen über allgemeine Pathologie*, erstes Heft (Jena, 1897); Louis Guinon, "De la fièvre," in Bouchard's *Traité de pathologie générale*, t. iii. 2nd partie (Paris, 1899); Sir J. B. Sander-son, "The Doctrine of Fever," in Allbutt's *System of Medicine*, vol. i. p. 139 (London, 1896). (D. N. P.)

FEYDEAU, ERNEST-AIMÉ (1821–1873), French author, was born in Paris, on the 16th of March 1821. He began his literary career in 1844, by the publication of a volume of poetry, *Les Nationales*. Either the partial failure of this literary effort, or his marriage soon afterwards to a daughter of the economist Blanqui, caused him to devote himself to finance and to archaeology. He gained a great success with his novel *Fanny* (1858), a success due chiefly to the cleverness with which it depicted and excused the corrupt manners of a certain portion of French society. This was followed in rapid succession by a series of fictions, similar in character, but wanting the attraction of novelty; none of them enjoyed the same vogue as *Fanny*. Besides his novels Feydeau wrote several plays, and he is also the author of *Histoire générale des usages funèbres et des sépultures des peuples anciens* (3 vols., 1857–1861); *Le Secret du bonheur* (sketches of Algerian life) (2 vols., 1864); and *L'Allemagne en 1871* (1872), a clever caricature of German life and manners. He died in Paris on the 27th of October 1873.

See Sainte-Beuve, *Causeries du lundi*, vol. xiv., and Barbey d'Aureville, *Les Œuvres et les hommes au XIX^e siècle*.

FEZ (*Fās*), the chief city of Morocco, into which empire it was incorporated in 1548. It lies in 34° 6' 3" N., 4° 38' 15" W., about 230 m. N.E. of Marrākesh, 100 m. E. from the Atlantic and 85 m. S. of the Mediterranean. It is beautifully situated in a deep valley on the Wad Fās, an affluent of the Wad Sebu, which divides the town into two parts—the ancient town, Fās el Bali, on the right bank, and the new, Fās el Jadid, on the left.

Like many other Oriental cities, Fez from a distance appears a very attractive place. It stretches out between low hills, crowned by the ruins of ancient fortresses, and though there

is nothing imposing, there is something particularly impressive in the sight of that white-roofed conglomeration of habitations, broken only by occasional mosque towers or, on the outskirts, by luxuriant foliage. Except on the south side the city is surrounded by hills, interspersed with groves of orange, pomegranate and other fruit trees, and large olive gardens.

From its peculiar situation Fez has a drainage superior to that of most Moorish towns. When the town becomes very dirty, the water is allowed to run down the streets by opening lids for the purpose in the conduits and closing the ordinary exits, so that it overflows and cleanses the pavements. The Fasis as a rule prefer to drink the muddy river water rather than that of the pure springs which abound in certain quarters of the town. But the assertion that the supply and drainage system are one is a libel, since the drainage system lies below the level of the fresh river water, and was organized by a French renegade, under Mohammed XVI., about the close of the 18th century. The general dampness of the town renders it unhealthy, however, as the pallid faces of the inhabitants betoken, but this is considered a mark of distinction and is jealously guarded.

Most of the streets are exceedingly narrow, and as the houses are high and built in many cases over the thoroughfares these are often very dark and gloomy, though, since wooden beams, rough stones and mortar are used in building, there is less of that ruined, half-decayed appearance so common in other Moorish towns where mud concrete is the material employed.

As a commercial town Fez is a great depot for the trade of Barbary and wares brought from the east and south by caravans. The manufactures still carried on are those of yellow slippers of the famous Morocco leather, fine white woollen and silk haiks, of which it is justly proud, women's embroidered sashes, various coarse woollen cloths and blankets, cotton and silk handkerchiefs, silk cords and braids, swords and guns, saddlery, brass trays, Moorish musical instruments, rude painted pottery and coloured tiles. Until recent times the city had a monopoly of the manufacture of Fez caps, for it was supposed that the dye which imparts the dull crimson hue of these caps could not be procured elsewhere; they are now, however, made both in France and Turkey. The dye is obtained from the juice of a berry which grows in large quantities near the town, and is also used in the dyeing of leather. Some gold ornaments are made, the gold being brought from the interior by caravans which trade regularly with Timbuktu.

As in other capitals each trade has a district or street devoted chiefly to its activities. Old Fez is the business portion of the town, new Fez being occupied principally by government quarters and the Jews' mellah. The tradesman usually sits cross-legged in a corner of his shop with his goods so arranged that he can reach most of them without moving.

In the early days of Mahomedan rule in Morocco, Fez was the seat of learning and the empire's pride. Its schools of religion, philosophy and astronomy enjoyed a great reputation in Africa and also in southern Europe, and were even attended by Christians. On the expulsion of the Moors from Spain, refugees of all kinds flocked to Fez, and brought with them some knowledge of arts, sciences and manufactures, and thither flocked students to make use of its extensive libraries. But its glories were brief, and though still "the university town" of Morocco, it retains but a shadow of its greatness. Its library, estimated by Gerhard Rohlfs in 1861 to contain 5000 volumes, is open on Fridays, and any Moor of known respectability may borrow volumes on getting an order and signing a receipt for them. There are about 1500 students who read at the Karucein. They pay no rents, but buy the keys of the rooms from the last occupants, selling them again on leaving.

The Karucein is celebrated as the largest mosque in Africa, but it is by no means the most magnificent. On account of the vast area covered, the roof, supported by three hundred and sixty-six pillars of stone, appears very low. The side chapel for services for the dead contains twenty-four pillars. All these columns support horse-shoe arches, on which the roof is built, long vistas of arches being seen from each of the eighteen

doors of the mosque. The large lamp is stated to weigh 1763 lb and to have 509 lights, but it is very seldom lit. The total number of lights in the Karucein is given as seventeen hundred, and they are said to require $3\frac{1}{2}$ cwt. of oil for one filling. The mosque of Mulai Idris, built by the founder of Fez about the year 810, is considered so sacred that the streets which approach its entrance are forbidden to Jews, Christians or four-footed beasts. The sanctity of the shrine in particular is esteemed very great, and this accounts for the crowds which daily flock to it. The Tumiât door leading to it was once very fine, but is now much faded. Opposite to it is a refuge for friendless sharifas—the female descendants of Mahomet—built by Mohammed XVII.

It is believed that the foundation stone of Fez was laid in 808 by Idris II. Since then its history has been chequered, as it was successfully besieged no fewer than eight times in the first five hundred years of its existence, yet only once knew foreign masters, when in 1554 the Turks took possession of it without a siege and held it for a short time. Fez became the chief residence of the Filali dynasty, who obtained possession of the town in 1649 (see further Morocco: *History*).

The population has been very varyingly estimated; probably the inhabitants number under one hundred thousand, even when the court is in residence.

See H. Gaillard, *Une Ville de l'Islam. Fès* (Paris, 1905); C. René-Leclerc, "Le commerce et l'industrie à Fez" in *Renseignements col. comilé africaine française* (1905).

FEZZAN (the ancient *Phazania*, or country of the Garamantes) a region of the Sahara, forming a "kaimakamlik" of the Ottoman vilayet of Tripoli (*q.v.*). Its frontiers, ill-defined, run from Bonjem, within 50 m. of the Mediterranean on the north, south-westward to the Akakus range of hills, which separates Fezzan from Ghat, thence eastward for over 400 m., and then turn north and west to Bonjem again, embracing an area of about 156,000 sq. m.

Physical Features.—The general form of the country is determined by the ranges of hills, including the Jebel-es-Suda (highest peak about 4000 ft.), the Haruj-el-Aswad and the Haruj-el-Abiad, which between 14° and 19° E. and 27° and 29° N. form the northern edge of a broad desert plateau, and shut off the northern region draining to the Mediterranean from the depressions in which lie the oases of Fezzan proper in the south. The central depression of Hofra ("ditch"), as it is called, lies in about 26° N. It does not form a continuous fertile tract, but consists of a monotonous sandy expanse somewhat more thickly studded with oases than the surrounding wastes. The Hofra at its lowest part is not more than 600 ft. above the sea-level, and in this hollow is situated the capital Murzuk. It has a general east to west direction. North-west of the Hofra is a long narrow valley, the Wadi-el-Gharbi, which trends north-east and is the most fertile district of Fezzan. It contains several perennial springs and lake-like basins. One of these basins, the saline Bahr-el-Dud ("Sea of Worms"), has an extent of 600 sq. m., and is in places 26 ft. deep. Southwards the Hofra rises to a height of 2000 ft., and in this direction lies the oasis of Gatron, followed by Tejerri on the verge of the desert, which marks the southern limit of the date and the northern of the dum palm. Beyond Tejerri the Saharan plateau rises continuously to the Tibesti highlands. (See further TRIPOLI.)

Climate.—The average temperature of Murzuk was found by Rohlfs to be 70° F. Frost is not uncommon in the winter months. The climate is a very regular one, and is in general healthy, the dryness of the air in summer making the heat more bearable than on the sea coast. An almost perpetual blue sky overhangs the desert, and the people of Fezzan are so unaccustomed to and so ill-prepared for wet weather that, as in Tuat and Tidikelt, they pray to be spared from rain. Water is found almost everywhere at small depths.

Flora and Fauna.—The date-palm is the characteristic tree of Fezzan, and constitutes the chief wealth of the land. Many different kinds of date-palms are found in the oases: in that of Murzuk alone more than 30 varieties are counted, the most

esteemed being named the Tillis, Tuati and Auregh. In all Fezzan the date is the staple food, not only for men, but for camels, horses and dogs. Even the stones of the fruit are softened and given to the cattle. The huts of the poorer classes are entirely made of date-palm leaves, and the more substantial habitations consist chiefly of the same material. The produce of the tree is small, 100 full-grown trees yielding only about 40 cwt. of dates. Besides the date there are numerous olive, fig and almond trees. Various grains are cultivated. Wheat and barley are sown in winter, and in spring, summer and autumn several kinds of durra, especially ksob and gafoli. Cotton flourishes, is perennial for six or seven years, and gives large pods of moderate length of staple.

There are no large carnivora in Fezzan. In the uninhabited oases gazelles and antelopes are occasionally found. The most important animal is the camel, of which there are two varieties, the Tebu or Sudan camel and the Arabian, differing very much in size, form and capabilities. Horses and cattle are not numerous. Among birds are ostriches, falcons, vultures, swallows and ravens; in summer wild pigeons and ducks are numerous, but in winter they seek a warmer climate. There are no remarkable insects or snakes. A species of *Artemia* or brine shrimp, about a quarter of an inch in length, of a colour resembling the bright hue of the gold fish, is fished for with cotton nets in the "Sea of Worms," and mixed with dates and kneaded into a paste, which has the taste and smell of salt herring, is considered a luxury by the people of Fezzan.

Inhabitants.—The total population is estimated at between 50,000 and 80,000. The inhabitants are a mixed people, derived from the surrounding Teda and Bornu on the south, Tuareg of the plateaus on the west, Berbers and Arabs from the north. The primitive inhabitants, called by their Arab conquerors Berāuna, are believed to have been of Negro origin. They no longer persist as a distinct people. In colour the present inhabitants vary from black to white, but the prevailing hue of skin is a Malay-like yellow, the features and woolly hair being Negro. The chief languages are the Kanuri or Bornu language and Arabic. Many understand Targish, the Teda and the Hausa tongues. If among such a mixed people there can be said to be any national language, it is that of Bornu, which is most widely understood and spoken. The people of Sokna, north of the Jebel-es-Suda, have a peculiar Berber dialect which Rohlf's found to be very closely allied to that of Ghadames. The men wear a haik or barakan like those of Tripoli, and a fez; short hose, and a large loose shirt called mansaria, with red or yellow slippers, complete their toilet. Yet one often sees the large blue or white *tobe* of Bornu, and the *litham* or shawl-muffler of the Tuareg, wound round the mouth to keep out the blown sand of the desert. The women, who so long as they are young have very plump forms, and who are generally small, are more simply dressed, as a rule, in the barakan, wound round their bodies; they seldom wear shoes, but generally have sandals made of palm leaf. Like the Arab women they load arms and legs with heavy metal rings, which are of silver among the more wealthy. The hair, thickly greased with butter, soon catching the dust which forms a crust over it, is done up in numberless little plaits round the head, in the same fashion as in Bornu and the Hausa countries. Children run about naked until they attain the age of puberty, which comes very early, for mothers of ten or twelve years of age are not uncommon. The Fezzani are of a gay disposition, much given to music and dancing.

Towns and Trade.—Murzuk, the present capital, which is in telegraphic communication with the town of Tripoli, lies in the western corner of the Hofra depression, in 25° 55' N. and 14° 10' E. It was founded about 1310, about which time the *kasbah* or citadel was built. The Turks repaired it, as well as the town-wall, which has, however, again fallen into a ruinous condition. Murzuk, which had in 1906 some 3000 inhabitants, is cut in two by a wide street, the *dendal*. The citadel and most of the houses are built of salt-saturated dried mud. Sokna, about midway between Tripoli and Murzuk, situated on a great gravel plain north of the Suda range, has a population of about 2500.

Garama (Jerma-el-Kedima), the capital under the Garamantes and the Romans, was in the Wadi-el-Gharbi. It was a flourishing town at the time of the Arab conquest but is now deserted. Among the ruins is a well-preserved stone monument marking the southern limit of the Roman dominions in this part of Africa. The modern Jerma is a small place a little north of the site of Garama. Zuila, the capital under the Arabs, lies in a depression called the Sherguia east of Murzuk on the most direct caravan route to Barca and Egypt. Of Traghen, the capital under the Nesur dynasty, which was on the same caravan route and between Zuila and Murzuk, little besides the ruined *kasbah* remains.

Placed roughly midway between the countries of the central Sudan and Tripoli, Fezzan serves as a depot for caravans crossing the Sahara; its commerce is unimportant. Its most important export is that of dates. Slave dealing, formerly the most lucrative occupation of the people, is moribund owing to the stoppage of slave raiding by the European governments in their Sudan territories.

History.—The country formed part of the territory of the Garamantes, described by Herodotus as a very powerful people. Attempts have been made to identify the Garamantes with the Berāuna of the Arabs of the 7th century, and to the period of the Garamantes Duveyrier assigns the remains of remarkable hydraulic works, and certain tombs and rock sculptures—indications, it is held, of a Negro civilization of ancient date which existed in the northern Sahara. The Garamantes, whether of Libyan or Negro origin, had certainly a considerable degree of civilization when in the year 19 B.C. they were conquered by the proconsul L. Cornelius Balbus Minor and their country added to the Roman empire. By the Romans it was called Phazania, whence the present name Fezzan. After the Vandal invasion Phazania appears to have regained independence and to have been ruled by a Berāuna dynasty. At this time the people were Christians, but in 666 the Arabs conquered the country and all traces of Christianity seem speedily to have disappeared. Subject at first to the caliphs, an independent Arab dynasty, that of the Beni Khattab, obtained power early in the 10th century. In the 13th century the country came under the rule of the king of Kanem (Bornu), but soon afterwards the Nesur, said to have been a native or Berāuna dynasty, were in power. More probably the Nesur were hereditary governors originally appointed by the rulers of Kanem. In the 14th century the Nesur were conquered and dethroned by an Arab tribe, that of Khorman, who reduced the people of Fezzan to a state of slavery, a position from which they were rescued about the middle of the 16th century by a shérif of Morocco, Montasir-b.-Mahommed, who founded the dynasty of Beni Mahommed. This dynasty, which came into frequent conflict with the Turks, who had about the same time that Montasir secured Fezzan established themselves in Tripoli, gradually extended its borders as far as Sokna in the north. It was the Beni Mahommed who chose Murzuk as their capital. They became intermittently tributary to the pasha of Tripoli, but within Fezzan the power of the sultans was absolute. They maintained a bodyguard of mamelukes, mostly Europeans—Greeks, Genoese, or their immediate descendants. The annual tribute was paid to the pasha either in money or in gold, senna or slaves. The last of the Beni Mahommed sultans was killed in the vicinity of Traghen in 1811 by El-Mukkeni, one of the lieutenants of Yusef Pasha, the last sovereign but one of the independent Karamanli dynasty of Tripoli. El-Mukkeni now made himself sultan of Fezzan, and became notorious by his slaving expeditions into the central Sudan, in which he advanced as far as Bagirmi. In 1831, Abd-el-Jelil, a chief of the Walid-Sliman Arabs, usurped the sovereign authority. After a troublous reign of ten years he was slain in battle by a Turkish force under Bakir Bey, and Fezzan was added to the Turkish empire. Towards the end of the 19th century the Turks, alarmed at the increase of French influence in the neighbouring countries, reinforced their garrison in Fezzan. The kaimakamlik is said to yield an annual revenue of £6000 only to the Tripolitan treasury.

AUTHORITIES.—The most notable of the European travellers who have visited Fezzan, and to whose works reference should be made for more detailed information regarding it, are, taking them in the order of date, as follows: F. Hornemann, 1798; G. F. Lyon, 1819; D. Denham, H. Clapperton and W. Oudney, 1822; J. Richardson, 1845; H. Barth, 1850–1855; E. Vogel, 1854; H. Duveyrier, 1859–1861; M. von Beurmann, 1862; G. Rohlfs, 1865; G. Nachtigal, 1869; P. L. Monteil, 1892; H. Vischer, 1906. Nachtigal's *Sahara und Sudan*, vol. i. (Berlin, 1879), gathers up much of the information in earlier works, and a list of the Beni Mahommed sovereigns is given in A. M. H. J. Stokvis, *Manuel d'histoire*, vol. i. (Leiden, 1888), p. 471. Miss Tinné (*q.v.*), who travelled with Nachtigal as far as Murzuk, was shortly afterwards murdered at the Sharaba wells on the road to Ghat.

FIACRE, SAINT (Celt. *Fiachra*), an anchorite of the 7th century, of noble Irish descent. We have no information concerning his life in his native country. His *Acta*, which have scarcely any historical value, relate that he left Ireland, and came to France with his companions. He approached St Faro, the bishop of Meaux, to whom he made known his desire to live a life of solitude in the forest. St Faro assigned him a spot called Prodilus (Brodolium), the modern Breuil, in the province of Brie. There St Fiacre built a monastery in honour of the Holy Virgin, and to it added a small house for guests, to which he himself withdrew. Here he received St Chillen (? Killian), who was returning from a pilgrimage to Rome, and here he remained until his death, having acquired a great reputation for miracles. His remains rested for a long time in the place which he had sanctified. In 1568, at the time of the religious troubles, they were transferred to the cathedral of Meaux, where his shrine may still be seen in the sacristy. Various relics of St Fiacre were given to princes and great personages. His festival is celebrated on the 30th of August. He is the patron of Brie, and gardeners invoke him as their protector. French hackney-coaches received the name of *fiacre* from the Hôtel St Fiacre, in the rue St Martin, Paris, where one Sauvage, who was the first to provide cabs for hire, kept his vehicles.

See *Acta Sanctorum*, Augusti vi. 598-620; J. O'Hanlon, *Lives of the Irish Saints*, viii. 421-447 (Dublin, 1875-1904); J. C. O'Meagher, "Saint Fiacre de la Brie," in *Proceedings of the Royal Irish Academy*, 3rd series, ii. 173-176. (H. DE.)

FIARS PRICES, in the law of Scotland, the average prices of each of the different sorts of grain grown in each county, as fixed annually by the sheriff, usually after the verdict of a jury; they serve as a rule for ascertaining the value of the grain due to feudal superiors, to the clergy or to lay proprietors of teinds, to landlords as a part or the whole of their rents and in all cases where the price of grain has not been fixed by the parties. It is not known when or how the practice of "striking the fiars," as it is called, originated. It probably was first used to determine the value of the grain rents and duties payable to the crown. In confirmation of this view it seems that at first the duty of the sheriffs was merely to make a return to the court of exchequer of the prices of grain within their counties, the court itself striking the fiars; and from an old case it appears that the fiars were struck above the true prices, being regarded rather as punishments to force the king's tenants to pay their rents than as the proper equivalent of the grain they had to pay. Co-existent, however, with these fiars, which were termed sheriffs' fiars, there was at an early period another class called commissaries' fiars, by which the values of teinds were regulated. They have been traced back to the Reformation, and were under the management of the commissary or consistorial courts, which then took the place of the bishops and their officials. They have now been long out of use, but they were perhaps of greater antiquity than the sheriffs' fiars, and the model upon which these were instituted. In 1723 the court of session passed an Act of Sederunt for the purpose of regulating the procedure in fiars courts. Down to that date the practice of striking the fiars was by no means universal over Scotland; and even in those counties into which it had been introduced, there was, as the preamble of the act puts it, "a general complaint that the said fiars are struck and given out by the sheriffs without due care and inquiry into the current and just prices." The act in consequence provided that all sheriffs should summon annually, between the 4th and the 20th

of February, a competent number of persons, living in the shire, of experience in the prices of grain within its bounds, and that from these they should choose a jury of fifteen, of whom at least eight were to be heritors; that witnesses and other evidence as to the price of grain grown in the county, especially since the 1st of November preceding until the day of inquiry, were to be brought before the jury, who might also proceed on "their own proper knowledge"; that the verdict was to be returned and the sentence of the sheriff pronounced by the 1st of March; and further, where custom or expediency recommended it, the sheriff was empowered to fix fiars of different values according to the different qualities of the grain. It cannot be said that this act has remedied all the evils of which it complained. The propriety of some of its provisions has been questioned, and the competency of the court to pass it has been doubted, even by the court itself. Its authority has been entirely disregarded in one county—Haddingtonshire—where the fiars are struck by the sheriff alone, without a jury; and when this practice was called in question the court declined to interfere, observing that the fiars were better struck in Haddingtonshire than anywhere else. The other sheriffs have in the main followed the act, but with much variety of detail, and in many instances on principles the least calculated to reach the true average prices. Thus in some counties the averages are taken on the number of transactions, without regard to the quantities sold. In one case, in 1838, the evidence was so carelessly collected that the second or inferior barley fiars were 2s. 4d. higher than the first. Formerly the price was struck by the boll, commonly the Linlithgowshire boll; now the imperial quarter is always used.

The origin of the plural word fiars (*feors*, *feers*, *fiers*) is uncertain. Jamieson, in his *Dictionary*, says that it comes from the Icelandic *fe*, wealth; Paterson derives it from an old French word *feur*, an average; others connect it with the Latin *forum* (*i.e.* market). The *New English Dictionary* accepts the two latter connexions. On the general subject of fiars prices see Paterson's *Historical Account of the Fiars in Scotland* (Edin., 1852); Connell, *On Tithes*; Hunter's *Landlord and Tenant*.

FIBRES (or FIBERS, in American spelling; from Lat. *fibra*, apparently connected either with *filum*, thread, or *findere*, to split), the general term for certain structural components of animal and vegetable tissue utilized in manufactures, and in respect of such uses, divided for the sake of classification into textile, paper-making, brush and miscellaneous fibres.

1. *Textile Fibres* are mostly products of the organic world, elaborated in their elongated form to subserve protective functions in animal life (as wool and epidermal hairs, &c.) or as structural components of vegetable tissues (flax, hemp and wood cells). It may be noted that the inorganic world provides an exception to this general statement in the fibrous mineral asbestos (*q.v.*), which is spun or twisted into coarse textiles. Other silicates are also transformed by artificial processes into fibrous forms, such as "glass," which is fused and drawn or spun to a continuous fibre, and various "slags" which, in the fused state, are transformed into "slag wool." Lastly, we note that a number of metals are drawn down to the finest dimensions, in continuous lengths, and these are woven into cloth or gauze, such metallic cloths finding valuable applications in the arts. Certain metals in the form of fine wire are woven into textile fabrics used as dress materials. Such exceptional applications are of insignificant importance, and will not be further considered in this article.

The common characteristics of the various forms of matter comprised in the widely diversified groups of textile fibres are those of the colloids. Colloidal matter is intrinsically devoid of structure, and in the mass may be regarded as homogeneous; whereas crystalline matter in its proximate forms assumes definite and specific shapes which express a complex of internal stresses. The properties of matter which condition its adaptation to structural functions, first as a constituent of a living individual, and afterwards as a textile fibre, are homogeneous continuity of substance, with a high degree of interior cohesion, and associated with an irreducible minimum of elasticity or extensibility. The colloids show an infinite diversity of variations in these essential properties: certain of them, and notably cellulose (*q.v.*), maintain

these characteristics throughout a cycle of transformations such as permit of their being brought into a soluble plastic form, in which condition they may be drawn into filaments in continuous length. The artificial silks or lustra-celluloses are produced in this way, and have already taken an established position as staple textiles. For a more detailed account of these products see CELLULOSE.

The animal fibres are composed of nitrogenous colloids of which the typical representatives are the albumens, fibrines and gelatines. They are of highly complex constitution and their characteristics have only been generally investigated. The vegetable fibre substances are celluloses and derivatives of celluloses, also typically colloidal bodies. The broad distinction between the two groups is chiefly evident in their relationship to alkalis. The former group are attacked, resolved and finally dissolved, under conditions of action by no means severe. The celluloses, on the other hand, and therefore the vegetable fibres, are extraordinarily resistant to the action of alkalis.

The animal fibres are relatively few in number but of great industrial importance. They occur as detached units and are of varying dimensions; sheep's wool having lengths up to 36 in., the fleeces being shorn for textile uses at lengths of 2 to 16 in.; horse hair is used in lengths of 4 to 24 in., whereas the silks may be considered as being produced in continuous length, "reeled silks" having lengths measured in hundreds of yards, but "spun silks" are composed of silk fibres purposely broken up into short lengths.

The vegetable fibres are extremely numerous and of very diversified characteristics. They are individualized units only in the case of seed hairs, of which cotton is by far the most important; with this exception they are elaborated as more or less complex aggregates. The bast tissues of dicotyledonous annuals furnish such staple materials as flax, hemp, rhea or ramie and jute. The bast occurs in a peripheral zone, external to the wood and beneath the cortex, and is mechanically separated from the stem, usually after steeping, followed by drying.

The commercial forms of these fibres are elongated filaments composed of the elementary bast cells (ultimate fibres) aggregated into bundles. The number of these as any part of the filament may vary from 3 to 20 (see figs.). In the processes of refinement preparatory to the spinning (hackling, scutching) and in the spinning process itself, the fibre-bundles are more or less subdivided, and the divisibility of the bundles is an element in the textile value of the raw material. But the value of the material is rather determined by the length of the ultimate fibres (for, although not the spinning unit, the tensile strength of the yarn is ultimately limited by the cohesion of these fibres), qualified by the important factor of uniformity.

Thus, the ultimate fibre of flax has a length of 25 to 35 mm.; jute, on the other hand, 2 to 3 mm.; and this disparity is an essential condition of the difference of values of these fibres. Rhea or ramie, to cite another typical instance, has an ultimate fibre of extraordinary length, but of equally conspicuous variability, viz. from 50 to 200 mm. The variability is a serious impediment in the preparation of the material for spinning, and this defect, together with low drawing or spinning quality, limits the applications of this fibre to the lower counts or grades of yarn.

The monocotyledons yield still more complex fibre aggregates, which are the fibro-vascular bundles of leaves and stems. These complex structures as a class do not yield to the mechanical treatment by which the bast fibres are subdivided, nor is there any true spinning quality such as is conditioned by bringing the ultimate fibres into play under the drawing process, which immediately precedes the twisting into yarn. Such materials are therefore only used for the coarsest textiles, such as string or rope. An exception to be noted in passing is to be found in the pine apple (*Ananassa Sativa*) the fibres of which are worked into yarns and cloth of the finest quality. The more important fibres of this class are manila, sisal, phormium. A heterogeneous mass of still more complex fibre aggregates, in many cases the entire stem (cereal straws, esparto), in addition to being used in plaited form, e.g. in hats, chairs, mats, constitute the staple raw material

for paper manufacturers, requiring a severe chemical treatment for the separation of the ultimate fibres.

In this class we must include the woods which furnish wood pulps of various classes and grades. Chemical processes of two types, (a) acid and (b) alkaline, are also employed in resolving the wood, and the resolution not only effects a complete isolation of the wood cells, but, by attacking the hydrolysable constituents of the wood substance (lignocellulose), the cells are obtained in the form of cellulose. These cellulose pulps are known in commerce as "sulphite pulps" and "soda pulps" respectively. In addition to these raw materials or "half stuffs" the paper-maker employs the rejecta of the vegetable and textile industries, scutching, spinning and cloth wastes of all kinds, which are treated by chemical (boiling) and mechanical means (beating) to separate the ultimate fibres and reduce them to the suitable dimensions (0.5-2.0 mm.). These papermaking fibres have also to be reckoned with as textile raw materials, in view of a new and growing industry in "pulp yarns" (*Papierstoffgarn*), a coarse textile obtained by treating paper as delivered in narrow strips from the paper machine; the strips are reeled, dried to retain 30-40% moisture, and in this condition subjected to the twisting operation, which confers the cylindrical form and adds considerably to the strength of the fibrous strip. The following are the essential characteristics of the economically important fibres.

Animal.—A. Silk. (a) The true silks are produced by the *Bombyx Mori*, the worm feeding on the leaves of the mulberry. The fibre is extruded as a viscous liquid from the glands of the worm, and solidifies to a cylindrical thread. The cohesion of these threads in pairs gives to raw silk the form of a dual cylinder (Plate I. fig. 2). For textile purposes the thread is reeled from the cocoon, and several units, five and upwards, are brought together and suitably twisted. (b) The "Wild" silks are produced by a large variety of insects, of which the most important are the various species of *Antherea*, which yield the Tussock silks. These silks differ in form and composition from the true silks. While they consist of a "dual" thread, each unit of these is complex, being made up of a number of fibrillae. This unit thread is quadrangular in section, and of larger diameter than the true silk, the mean breadth being 0.052 mm., as compared with 0.018, the mean diameter of the true silks. The variations in structure as well as in dimensions are, however, very considerable.

B. Epidermal hairs. Of these (a) wool, the epidermal protective covering of sheep, is the most important. The varying species of the animal produce wools of characteristic qualities, varying considerably in fineness, in length of staple, in composition and in spinning quality. Hence the classing of the fleeces or raw wool followed by the elaborate processes of selection, i.e. "sorting" and preparation, which precede the actual spinning or twisting of the yarn. These consist in entirely freeing the fibres and sorting them mechanically (combing, &c.), thereafter forming them into continuous lengths of parallelized units. This is followed by the spinning process which consists in a simultaneous drawing and twisting, and a continuous production of the yarn with the structural characteristics of *worsted* yarns. The shorter staple—from 5 to 25% of average fleeces—is prepared by the "carding" process for the spinning operation, in which drawing and twisting are simultaneous, the length spun being then wound up, and the process being consequently intermittent. This section of the industry is known as "woollen spinning" in contrast to the former or "worsted spinning."

(b) An important group of raw material closely allied to the wools are the epidermal hairs of the Angora goat (mohair), the llama, alpaca. Owing to their form and the nature of the substance of which they are composed, they possess more lustre than the wools. They present structural differences from sheep wools which influence the processes by which they are prepared or spun, and the character of the yarns; but the differences are only of subordinate moment.

(c) Various animal hairs, such as those of the cow, camel

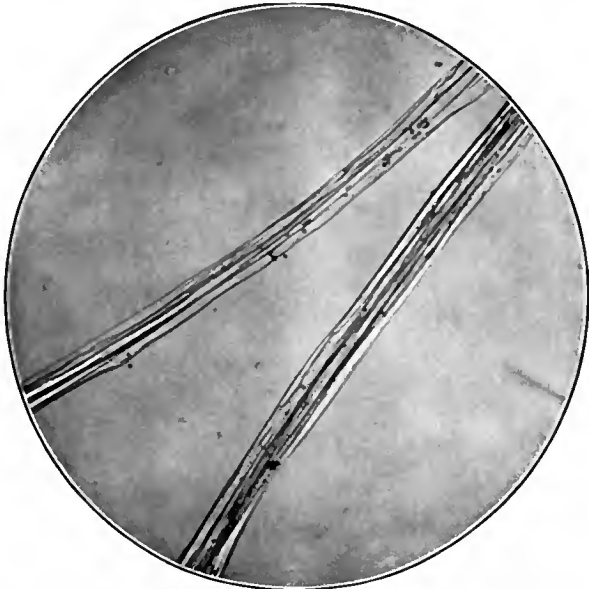

FIG. 1.—RAW SILK. *Bombyx mori*. Filament of bave, viewed in length. $\times 110$.



FIG. 2.—RAW SILK. *Bombyx mori*. Single fibres in transverse section showing each fibre or "bave" as dual cylinder. $\times 235$.

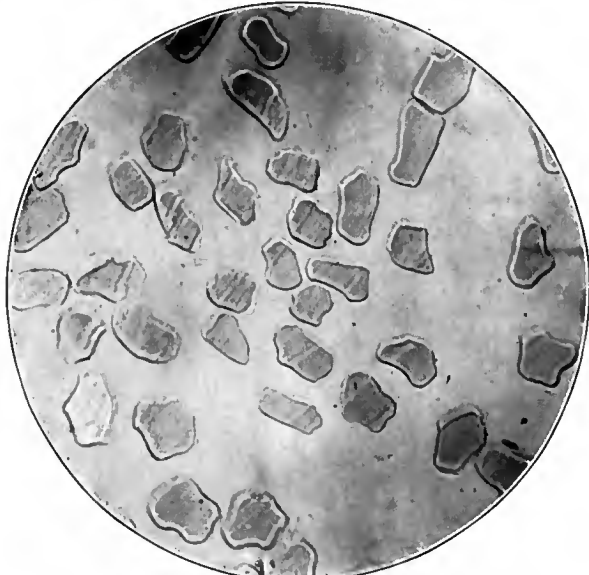

FIG. 3.—ARTIFICIAL "SILK." Lustra-cellulose viscose process, single fibres in transverse section. $\times 235$. Normal type—polygon of 5 sides—with concave sides due to contact of the component units of textile filament.



FIG. 4.—WOOL FIBRES. Australian merino viewed in length, $\times 235$. Surface imbrications—the structural cause of true felting properties.

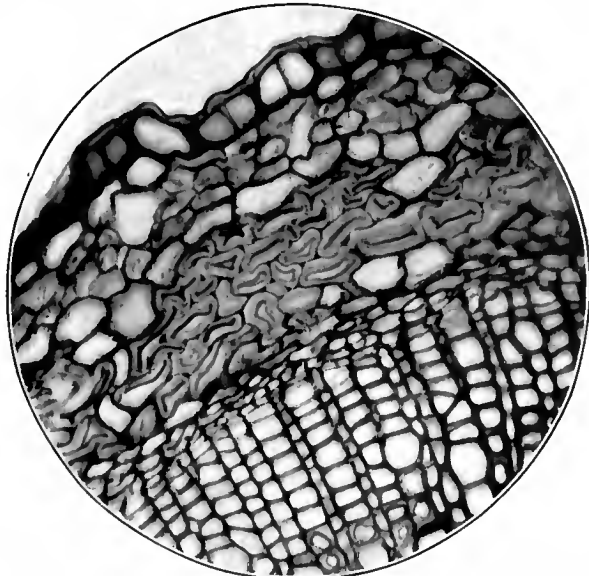

FIG. 5.—FLAX STEM. *Linum usitatissimum*, transverse section of stem, $\times 235$, showing the bast fibres occupying the central zone between wood and exterior cortex.



FIG. 6.—RAMIE. Section of bast region, $\times 235$ Showing bast fibres bundles but only slightly occurring as individuals and as coherent.

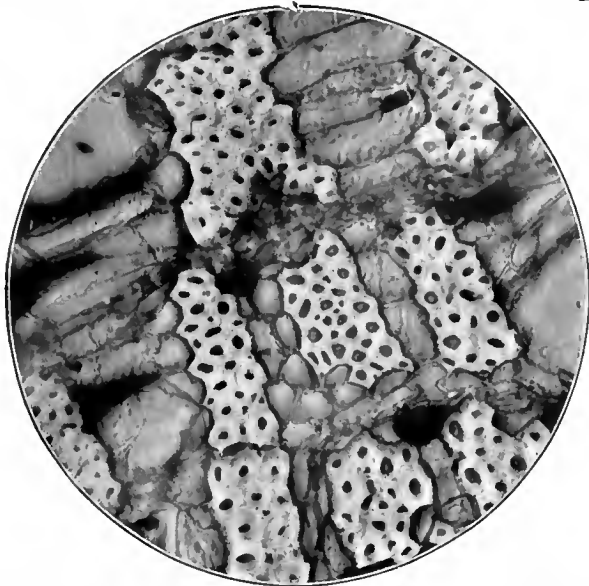

FIG. 7.—JUTE. Bast bundles. Section of bast region, $\times 235$, showing agglomerated bundles of bast fibre, each bundle representing a spinning unit or filament.

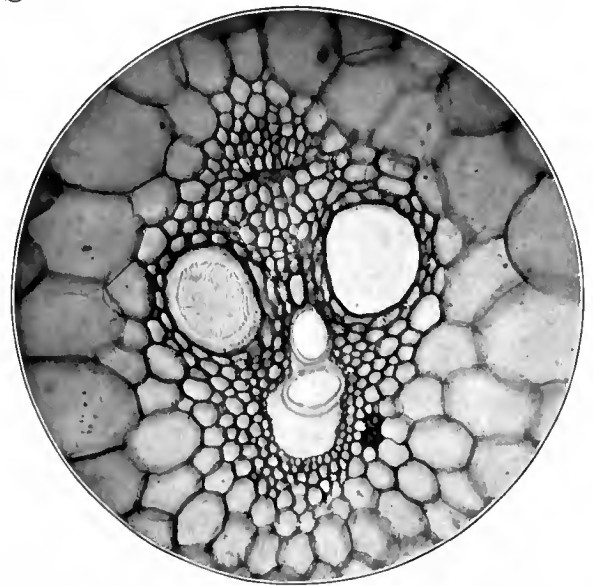

FIG. 8.—MAIZE STEM. *Zea mais*. Fibro-vascular bundle in section, $\times 110$, typical of monocotyledonous structure.

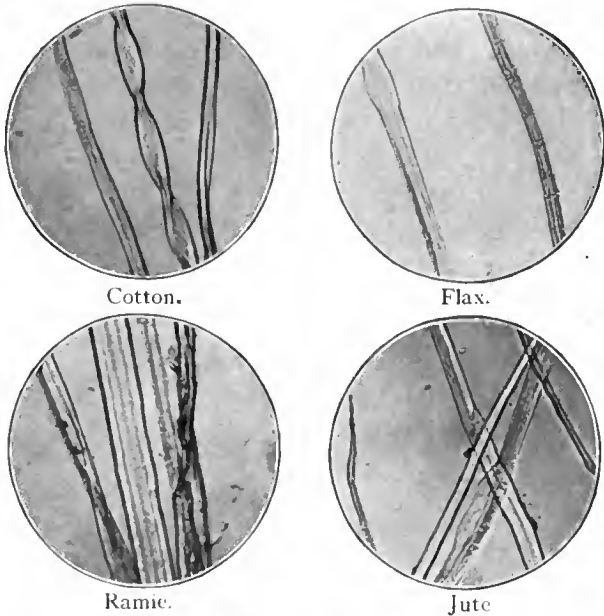

FIG. 9.—COTTON. FLAX. RAMIE. JUTE. Ultimate fibres in the length, $\times 110$. Portions selected to show typical structural characteristics.



FIG. 10.—COTTON. FLAX. RAMIE. JUTE. Ultimate fibres—transverse section, $\times 110$. Note similarity of ramie to cotton and jute to flax. Jute "fibre," a filament formed of compact agglomerate of ultimate fibres, contrasts with flax, in which ultimate fibres only slightly adherent—hence its divisibility and "drawing" quality under hackling and spinning treatments.

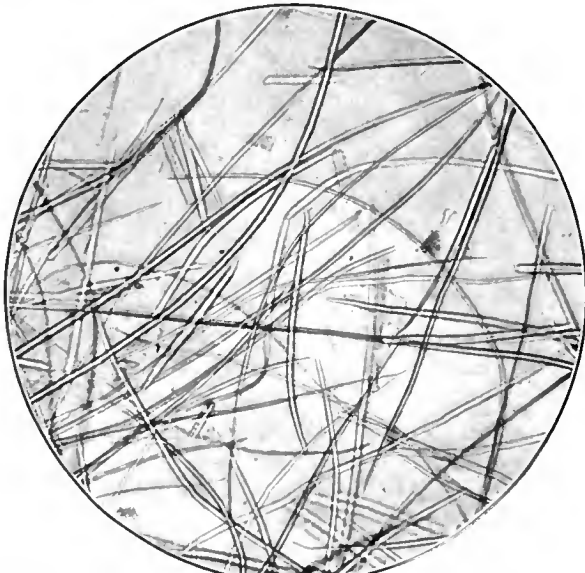

FIG 11.—ESPARTO. Cellulose. Ultimate fibres of paper making pulp. Typical fusiform bast fibres, with scattered serrated cells of cortex and hairs. $\times 65$.

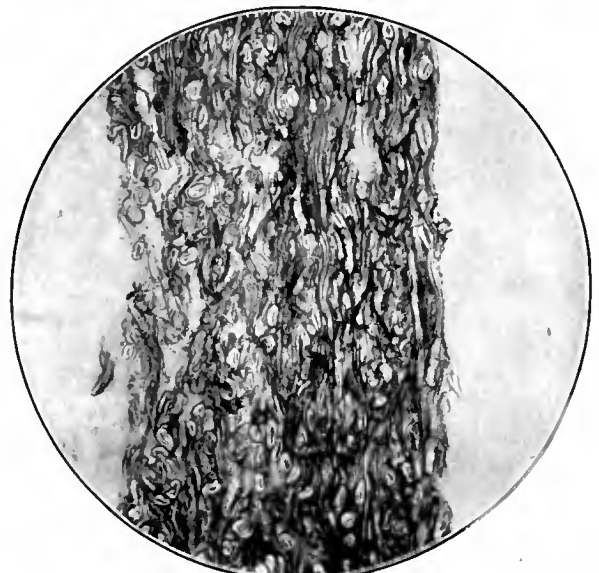

FIG. 12.—SECTION OF HAND-MADE PAPER. $\times 110$. Ultimate component fibres disposed in every plane. Proportion lying at right angles and showing therefore normal transverse section.

and rabbit, are also employed; the latter is largely worked into the class of fabrics known as felts. In these the hairs are compacted together by taking advantage of the peculiarity of structure which causes the imbrications of the surface.

(d) Horse hair is employed in its natural form as an individual filament or monofil.¹

Vegetable Fibres.—The subjoined scheme of classification sets out the morphological structural characteristics of the vegetable fibres:—

	Produced from
<i>Dicotyledons.</i>	<i>Monocotyledons.</i>
A. Seed hairs.	D. Fibro-vascular bundles.
B. Bast fibres.	E. Entire leaves and stems.
C. Bast aggregates.	

In the list of the more important fibrous raw materials subjoined, the capital letter immediately following the name refers the individual to its position in this classification. In reference to the important question of chemical composition and the actual nature of the fibre substance, it may be premised that the vegetable fibres are composed of cellulose, an important representative of the group of carbohydrates, of which the cotton fibre substance is the chemical prototype, mixed and combined with various derivatives belonging to the subgroups. (a) Carbohydrates. (b) Unsaturated compounds of benzenoid and furfuroid constitutions. (c) "Fat and wax" derivatives, *i.e.* groups belonging to the fatty series, and of higher molecular dimensions—of such compound celluloses the following are the prototypes:—

- (a) Cellulose combined and mixed with "pectic" bodies (*i.e.* pecto-celluloses), flax, rhea.
- (b) Cellulose combined with unsaturated groups or ligno-celluloses, jute and the woods.
- (c) Cellulose combined and mixed with higher fatty acids, alcohols, ethers, cuto-celluloses, protective epidermal covering of leaves.

The letters *a, b, c* in the table below and following the capitals, which have reference to the structural basis of classification,

indicate the main characteristics of the fibre substances. (See also CELLULOSE.)

Miscellaneous.—Various species of the family Palmaceae yield fibrous products of value, of which mention must be made of the following. *Raffia*, epidermal strips of the leaves of *Raphia ruffia* (Madagascar), *R. taedigera* (Japan), largely employed as binder twine in horticulture, replacing the "bast" (linden) formerly employed. *Coir*, the fibrous envelope of the fruit of the *Cocos nucifera*, extensively used for matting and other coarse textiles. *Carludovica palmata* (Central America) yields the raw material for Panama hats, the *Corypha australis* (Australia) yields a similar product. The leaves of the date palm, *Phoenix dactylifera*, are employed locally in making baskets and mats, and the fibro-vascular bundles are isolated for working up into coarse twine and rope; similarly, the leaves of the *Elaeis guineensis*, the fruit of which yields the "palm oil" of commerce, yield a fibre which finds employment locally (Africa) for special purposes. *Chamaerops humilis*, the dwarf palm, yields the well-known "Crin d'Afrique." Locally (Algiers) it is twisted into ropes, but its more general use, in Europe, is in upholstery as a stuffing material. The cereal straws are used in the form of plait in the making of hats and mats. Esparto grass is also used in the making of coarse mats.

The processes by which the fibres are transformed into textile fabrics are in the main determined by their structural features. The following are the distinctive types of treatment.

A. The fibre is in virtually continuous lengths. The textile yarn is produced by assembling together the unit threads, which are wound together and suitably twisted (silk; artificial silk).

B. The fibres in the form of units of variable short dimensions are treated by more or less elaborate processes of scutching, hackling, combing, with the aim of producing a mass of free parallelized units of uniform dimensions; these are then laid together and drawn into continuous bands of sliver and roving, which are finally drawn and twisted into yarns. In this group are comprised the larger number of textile products, such as

	Botanical Identity. Genus and Order.	Country of Origin.	Dimensions of Ultimate.	Textile Uses.
Cotton, A.a . . .	Gossypium Malvaceae	Tropical and subtropical countries	12-40 mm. 0.019-0.025. Av. 28 mm.	Universal. Also as a raw material in chemical industries, notably explosives, celluloid.
Flax, B.a . . .	Linum Linaceae	Temperate (and subtropical) countries, chiefly European	6-60 mm. 0.011-0.025. Av. 28 mm.	General. Special effects in lustre damasks. In India and America plants grown for seed (linseed).
Hemp, B.a . . .	Cannabis Cannabineae	Temperate countries, chiefly Europe	5-55 mm. 0.016-0.050. Av. 22. mm. Av. 0.022	Coarser textiles, sail-cloth, rope and twine.
Ramie, B.a . . .	Boehmeria Urticaceae	Tropical countries (some temperate)	60-200 mm. 0.03-0.08. Av. 120 mm. Av. 0.050	Coarse textiles. Cost of preparation for fine textiles prohibitive.
Jute, B.b . . .	Corchorus Tiliaceae	Tropical countries, chiefly India	1.5-5 mm. 0.020-0.025. Av. 2.5 mm. Av. 0.022	Coarse textiles, chiefly "Hessians" and sacking. "Line" spun yarns used in cretonne and furniture textiles.
B.b . . .	Crotalaria Leguminosae	India	4.0-12.0. 0.025-0.050. Av. 7.5. Av. 0.022	Twine and rope. Coarse textiles.
Hibiscus, B.b . . .	Hibiscus	Tropical, chiefly India	2-6 mm. 0.014-0.033. Av. 4 mm. Av. 0.021	Coarse textiles. <i>H. Elams</i> has been extensively used in making mats.
Sida, B.b . . .	Sida Malvaceae	Tropical and subtropical	1.5-4 mm. 0.013-0.02. Av. 2 mm. Av. 0.015	Coarse textiles. Appears capable of substituting jute.
Lime or Linden, C.b	Tilia Tiliaceae	European countries, chiefly Russia	1.5 mm. 0.014-0.020. Av. 2 mm. Av. 0.016	Matting and binder twine.
Mulberry, C . . .	Broussonetia Moraceae	Far East	5-31 mm. 0.02-0.04. Av. 15 mm. Av. 0.03	Paper and paper cloths.
Monocotyledons— Manila, D . . .	Musa Musaceae	Tropical countries, chiefly Philippine Islands	3-12 mm. 0.016-0.032. Av. 6 mm. Av. 0.024	Twine and ropes. Produces papers of special quality.
Sisal, D . . .	Agave Amaryllideae	Tropical countries, chiefly Central America	1.5-4 mm. 0.020-0.032. Av. 2.5. Av. 0.024	Twine and ropes.
	Yucca Liliaceae	do.	0.5-6 mm. 0.01-0.02.	do.
	Sansevieria Liliaceae	East Indies, Ceylon, East Africa	1.5-6 mm. 0.015-0.026. Av. 3 mm. Av. 0.020	do.
Phormium, D . . .	Phormium tenax Liliaceae	New Zealand	5.0-15 mm. 0.010-0.020. Av. 9 mm. Av. 0.016	Twine and ropes. Distinguished by high yield of fibre from green leaf.
Pine-apple, D . . .	Ananassa Bromeliaceae	Tropical East and West Indies	3.0-9.0 mm. 0.004-0.008. Av. 5. Av. 0.006	Textiles of remarkable fineness. Exceptional fineness of ultimate fibre.

¹ See also ALPACA, FELT, MOHAIR, SHODDY and WOOL.

cotton, wool, flax and jute, and it also includes at the other extreme the production of coarse textiles, such as twine and rope.

C. The fibres of still shorter dimensions are treated in various ways for the production of a fabric in continuous length.

The distinction of type of manufacturing processes in which the relatively short fibres are utilized, either as disintegrated units or comminuted long fibres, follows the lines of division into long and short fibres; the long fibres are worked into yarns by various processes, whereas the shorter fibres are agglomerated by both dry and wet processes to felted tissues or felts. It is obvious, however, that these distinctions do not constitute rigid dividing lines. Thus the principles involved in felting are also applied in the manipulation of long fibre fabrics. For instance, woollen goods are closed or shrunk by milling, the web being subjected to a beating or hammering treatment in an apparatus known as "the Stocks," or is continuously run through squeezing rollers, in weak alkaline liquids. Flax goods are "closed" by the process of beetling, a long-continued process of hammering, under which the ultimate fibres are more or less subdivided, and at the same time welded or incorporated together. As already indicated, paper, which is a web composed of units of short dimensions produced by deposition from suspension in water and agglomerated by the interlacing of the component fibres in all planes within the mass, is a species of textile. Further, whereas the silks are mostly worked up in the extreme lengths of the cocoon, there are various systems of spinning silk wastes of variable short lengths, which are similar to those required for spinning the fibres which occur naturally in the shorter lengths.

The fibres thus enumerated as commercially and industrially important have established themselves as the result of a struggle for survival, and each embodies typical features of utility. There are innumerable vegetable fibres, many of which are utilized in the locality or region of their production, but are not available for the highly specialized applications of modern competitive industry to qualify for which a very complex range of requirements has to be met. These include primarily the factors of production and transport summed up in cost of production, together with the question of regularity of supply; structural characteristics, form and dimensions, including uniformity of ultimate unit and adaptability to standard methods of preparing and spinning, together with tenacity and elasticity, lustre. Lastly, composition, which determines the degree of resistance to chemical disintegrating influences as well as subsidiary questions of colour and relationship to colouring matters. The quest for new fibres, as well as modified methods of production of those already known, require critical investigation from the point of view of established practice. The present perspective outline of the group will be found to contain the elements of a grammar of the subject. But those who wish to pursue the matter will require to amplify this outlined picture by a study of the special treatises which deal with general principles, as well as the separate articles on the various fibres.

Analysis and Identification.—For the analysis of textile fabrics and the identification of component fibre, a special treatise must be consulted. The following general facts are to be noted as of importance.

All animal fibres are effectively dissolved by 10% solution of caustic potash or soda. The fabric or material is boiled in this solution for 10 minutes and exhaustively washed. Any residue will be vegetable or cellulose fibre. It must not be forgotten that the chemical properties of the fibre substances are modified more or less by association in combination with colouring matters and mordants. These may, in many cases, be removed by treatments which do not seriously modify the fibre substances.

Wool is distinguished from silk by its relative resistance to the action of sulphuric acid. The cold concentrated acid rapidly dissolves silk as well as the vegetable fibres. The attack on wool is slow, and the epidermal scales of wool make their appearance. The true silks are distinguished from the wild silks by the action of concentrated hydrochloric acid in the cold, which reagent dissolves the former, but has only a slight effect on Tussore

silk. After preliminary resolution by these group reagents, the fabric is subjected to microscopical analysis for the final identification of its component fibres (see H. Schlichter, *Journal Soc. Chem. Ind.*, 1890, p. 241).

A scheme for the commercial analysis or assay of vegetable fibres, originally proposed by the author,¹ and now generally adopted, includes the following operations:—

1. Determination of moisture.
2. Determination of ash left after complete ignition.
3. Hydrolysis:
 - (a) loss of weight after boiling the raw fibre with a 1% caustic soda solution for five minutes;
 - (b) loss after boiling for one hour.
4. Determination of cellulose: the white residue after
 - (a) boiling for five minutes with 1% caustic soda,
 - (b) exposure to chlorine gas for one hour,
 - (c) boiling with basic sodium sulphite solution.
5. Mercerizing: the loss of weight after digestion with a 20% solution of sodium hydrate for one hour in the cold.
6. Nitration: the weight of the product obtained after digestion with a mixture of equal volumes of sulphuric and nitric acids for one hour in the cold.
7. Acid purification: treatment of the raw fibre with 20% acetic acid for one minute, the product being washed with water and alcohol, and then dried.
8. Determination of the total carbon by combustion.

II. *Papermaking.*—The papermaking industry (see PAPER) employs as raw materials a large proportion of the vegetable fibre products already enumerated, and, for the reasons incidentally mentioned, they may be, and are, employed in a large variety of forms: in fact any fibrous material containing over 30% "cellulose" and yielding ultimate fibres of a length exceeding 1 mm. can be used in this industry. Most important staples are cotton and flax; these are known to the paper-maker as "rag" fibres, rags, *i.e.* cuttings of textile fabrics, new and old, being their main source of supply. These are used for writing and drawing papers. In the class of "printings" two of the most important staples are wood pulp, prepared by chemical treatment from both pine and foliage woods, and in England esparto cellulose, the cellulose obtained from esparto grass by alkali treatment; the cereal straws are also used and are resolved into cellulose by alkaline boiling followed by bleaching. In the class of "wrappings" and miscellaneous papers a large number of other materials find use, such as various residues of manufacturing and preparing processes, scutching wastes, ends of rovings and yarns, flax, hemp and manila rope waste, adansonia bast, and jute wastes, raw (cuttings) and manufactured (bagging). Other materials have been experimentally tried, and would no doubt come into use on their papermaking merits, but as a matter of fact the actually suitable raw materials are comprised in the list above enumerated, and are limited in number, through the influence of a number of factors of value or utility.

III. *Brush Fibres, &c.*—In addition to the textile industries there are manufactures which utilize fibres of both animal and vegetable character. The most important of these is brush-making. The familiar brushes of everyday use are extremely diversified in form and texture. The supplies of animal fibres are mainly drawn from the badger, hog, bear, sable, squirrel and horse. These fibres and bristles cover a large range of effects. Brushes required for cleansing purposes are composed of fibres of a more or less hard and resilient character, such as horse hairs, and other tail hairs and bristles. For painting work brushes of soft quality are employed, graduating for fine work into the extreme softness of the "camel hair" pencil. Of vegetable fibres the following are used in this industry. The *Caryola urens* furnishes the Kittul fibre, obtained from the base of the leaf stalks. Piassava is obtained from the *Attalea funifera*, also from the *Leopoldina piassaba* (Brazil). Palmyra fibre is obtained from the *Borassus flabellifer*. These are all members of the natural order of the Palmaceae. Mexican fibre, or Istle, is obtained from the agave. The fibre known as Whisk, largely

¹ Col. Ind. Exhibition, 1886, *Miscellaneous Reports*.

used for dusting brushes, is obtained from various species of the Gramineae; the "Mexican Whisk" from *Epicampeas macrourea*; and "Italian Whisk" from *Andropogon*. The coir fibre mentioned above in connexion with coarse textiles is also extensively used in brush-making. Aloe and Agave fibres in their softer forms are also used for plasterers's brushes. Many of the whitewashes and cleansing solutions used in house decoration are alkaline in character, and for such uses advantage is taken of the specially resistant character of the cellulose group of materials.

Stuffing and Upholstery.—Another important use for fibrous materials is for filling or stuffing in connexion with the seats and cushions in upholstery. In the large range of effects required, a corresponding number and variety of products find employment. One of the most important is the floss or seed-hair of the *Eriodendron anfractuosum*, known as Kapok, the use of which in Europe was created by the Dutch merchants who drew their supplies from Java. The fibre is soft, silky and elastic, and maintains its elasticity in use. Many fibres when used in the mass show, on the other hand, a tendency to become matted and compressed in use, and to restore them to their original state the fibre requires to be removed and subjected to a teasing or carding process. This defect limits the use of other "flosses" or seed hairs in competition with Kapok. Horse hair is extensively used in this industry, as are also wool flocks and other short animal hairs and wastes.

Hats and Matting.—For these manufactures a large range of the fibrous products above described are employed, chiefly in their natural or raw state.

BIBLIOGRAPHY.—The list of works appended comprises only a small fraction of the standard literature of the subject, but they are sufficiently representative to enable the specialist, by referring to them, to cover the subject-matter. F. H. Bowman, *The Structure of the Wood Fibre* (1885); *The Structure of Cotton Fibre* (1882); Cross, Bevan and King, *Indian Fibres and Fibrous Substances* (London, 1887); C. F. Cross, *Report on Miscellaneous Fibres*, Colonial Indian Exhibition, 1886 (London, 1887); Cross and Bevan, *Cellulose, Researches on Cellulose*, i. and ii. (London, 1895-1905); C. R. Dodge, *A Descriptive Catalogue of Useful Fibre Plants of the World* (Report No. 9, U.S. Dept. of Agriculture, Washington, 1897); von Höhnel, *Die Mikroskopie der technisch verwendeten Faserstoffe* (Leipzig, 1905); J. J. Hummel, *The Dyeing of Textile Fabrics* (London, 1885); J. M. Matthews, *The Textile Fibres, their Physical, Microscopical and Chemical Properties* (New York, 1904); H. Müller, *Die Pflanzenfaser* (Braunschweig, 1877); H. Schlichter, "The Examination of Textile Fibres and Fabrics" (*Jour. Soc. Chem. Ind.*, 1890, 241); M. Vétillard, *Études sur les fibres végétales textiles* (Paris, 1876); Sir T. H. Wardle, *Silk and Wild Silks*, original memoirs in connexion with Col. Ind. Ex., 1886, Jubilee Ex. Manchester, 1887; Sir G. Watt, *Dictionary of Economic Products of India* (London, 1891); Wiesner, *Die Rohstoffe des Pflanzenreichs* (Leipzig, 1873); O. N. Witt, *Chemische Technologie der Gespinnstfasern* (Braunschweig, 1888); *Kew Bulletin*; *The Journal of the Imperial Institute*; *The Journal of the Society of Arts*; W. I. Hannam, *The Textile Fibres of Commerce* (London, 1902); J. Jackson, *Commercial Botany*; J. Zipser, *Die Textilien Rohmaterialien* (Wien, 1895); F. Zetzsche, *Die wichtigsten Faserstoffe der europäischen Industrie* (Leipzig, 1895). (C. F. C.)

FIBRIN, or **FIBRINE**, a protein formed by the action of the so-called fibrin-ferment on fibrinogen, a constituent of the blood-plasma of all vertebrates. This change takes place when blood leaves the arteries, and the fibrin thus formed occasions the clotting which ensues (see **BLOOD**). To obtain pure coagulated fibrin it is best to heat blood-plasma (preferably that of the horse) to 56° C. The usual method of beating a blood-clot with twigs and removing the filamentous fibrin which attaches itself to them yields a very impure product containing haemoglobin and much globulin; moreover, it is very difficult to purify. Fibrin is a very voluminous, tough, strongly elastic, jelly-like substance; when denaturalized by heat, alcohol or salts, it behaves as any other coagulated albumin.

FICHTE, IMMANUEL HERMANN (originally **HARTMANN VON** (1797-1879), German philosopher, son of J. G. Fichte, was born at Jena on the 18th of July 1797. Having held educational posts at Saarbrücken and Düsseldorf, in 1836 he became extraordinary professor of philosophy at Bonn, and in 1840 full professor. In 1842 he received a call to Tübingen, retired in 1867, and died at Stuttgart on the 8th of August 1879. The

most important of his comprehensive writings are: *System der Ethik* (1850-1853), *Anthropologie* (1856, 3rd ed. 1876), *Psychologie* (1864-1873), *Die theistische Weltansicht* (1873). In 1837 he had founded the *Zeitschrift für Philosophie* as an organ of his views, more especially on the subject of the philosophy of religion, where he was in alliance with C. H. Weisse; but, whereas Weisse thought that the Hegelian structure was sound in the main, and that its imperfections might be mended, Fichte held it to be incurably defective, and spoke of it as a "masterpiece of erroneous consistency or consistent error." Fichte's general views on philosophy seem to have changed considerably as he advanced in years, and his influence has been impaired by certain inconsistencies and an appearance of eclecticism, which is strengthened by his predominantly historical treatment of problems, his desire to include divergent systems within his own, and his conciliatory tone. His philosophy is an attempt to reconcile monism (Hegel) and individualism (Herbart) by means of theism (Leibnitz). He attacks Hegelianism for its pantheism, its lowering of human personality, and imperfect recognition of the demands of the moral consciousness. God, he says, is to be regarded not as an absolute but as an Infinite Person, whose nature it is that he should realize himself in finite persons. These persons are objects of God's love, and he arranges the world for their good. The direct connecting link between God and man is the "genius," a higher spiritual individuality existing in man by the side of his lower, earthly individuality. Fichte, in short, advocates an ethical theism, and his arguments might easily be turned to account by the apologist of Christianity. In his conception of finite personality he recurs to something like the monadism of Leibnitz. His insistence on moral experience is connected with his insistence on personality. One of the tests by which Fichte discriminates the value of previous systems is the adequateness with which they interpret moral experience. The same reason that made him depreciate Hegel made him praise Krause (pantheism) and Schleiermacher, and speak respectfully of English philosophy. It is characteristic of Fichte's almost excessive receptiveness that in his latest published work, *Der neuere Spiritualismus* (1878), he supports his position by arguments of a somewhat occult or theosophical cast, not unlike those adopted by F. W. H. Myers. He also edited the complete works and literary correspondence of his father, including his life.

See R. Eucken, "Zur Erinnerung I. H. F.," in *Zeitschrift für Philosophie*, cx. (1897); C. C. Scherer, *Die Gotteslehre von I. H. F.* (1902); article by Karl Hartmann in *Allgemeine deutsche Biographie* xviii. (1904). Some of his works were translated by J. D. Morell under the title of *Contributions to Mental Philosophy* (1860).

FICHTE, JOHANN GOTTLIEB (1762-1814), German philosopher, was born at Rammenau in Upper Lusatia on the 19th of May 1762. His father, a ribbon-weaver, was a descendant of a Swedish soldier who (in the service of Gustavus Adolphus) was left wounded at Rammenau and settled there. The family was distinguished for piety, uprightness, and solidity of character. With these qualities Fichte himself combined a certain impetuosity and impatience probably derived from his mother, a woman of a somewhat querulous and jealous disposition.

At a very early age the boy showed remarkable mental vigour and moral independence. A fortunate accident which brought him under the notice of a neighbouring nobleman, Freiherr von Miltitz, was the means of procuring him a more excellent education than his father's circumstances would have allowed. He was placed under the care of Pastor Kriebel at Niederau. After a short stay at Meissen he was entered at the celebrated school at Pforta, near Naumburg. In 1780 he entered the university of Jena as a student of theology. He supported himself mainly by private teaching, and during the years 1784-1787 acted as tutor in various families of Saxony. In 1787, after an unsuccessful application to the consistory for pecuniary assistance, he seems to have been driven to miscellaneous literary work. A tutorship at Zürich was, however, obtained in the spring of 1788, and Fichte spent in Switzerland two of the happiest years of his life. He made several valuable acquaintances,

among others Lavater and his brother-in-law Hartmann Rahn, to whose daughter, Johanna Maria, he became engaged.

Settling at Leipzig, still without any fixed means of livelihood, he was again reduced to literary drudgery. In the midst of this work occurred the most important event of his life, his introduction to the philosophy of Kant. At Schulpforta he had read with delight Lessing's *Anti-Goetze*, and during his Jena days had studied the relation between philosophy and religion. The outcome of his speculations, *Aphorismen über Religion und Deismus* (unpublished, date 1790; *Werke*, i. 1-8), was a species of Spinozistic determinism, regarded, however, as lying altogether outside the boundary of religion. It is remarkable that even for a time fatalism should have been predominant in his reasoning, for in character he was opposed to such a view, and, as he has said, "according to the man, so is the system of philosophy he adopts."

Fichte's *Letters* of this period attest the influence exercised on him by the study of Kant. It effected a revolution in his mode of thinking; so completely did the Kantian doctrine of the inherent moral worth of man harmonize with his own character, that his life becomes one effort to perfect a true philosophy, and to make its principles practical maxims. At first he seems to have thought that the best method for accomplishing his object would be to expound Kantianism in a popular, intelligible form. He rightly felt that the reception of Kant's doctrines was impeded by their phraseology. An abridgment of the *Kritik der Urteilskraft* was begun, but was left unfinished.

Fichte's circumstances had not improved. It had been arranged that he should return to Zürich and be married to Johanna Rahn, but the plan was overthrown by a commercial disaster which affected the fortunes of the Rahn family. Fichte accepted a post as private tutor in Warsaw, and proceeded on foot to that town. The situation proved unsuitable; the lady, as Kuno Fischer says, "required greater submission and better French" than Fichte could yield, and after a fortnight's stay Fichte set out for Königsberg to see Kant. His first interview was disappointing; the coldness and formality of the aged philosopher checked the enthusiasm of the young disciple, though it did not diminish his reverence. He resolved to bring himself before Kant's notice by submitting to him a work in which the principles of the Kantian philosophy should be applied. Such was the origin of the work, written in four weeks, the *Versuch einer Kritik aller Offenbarung* (Essay towards a Critique of all Revelation). The problem which Fichte dealt with in this essay was one not yet handled by Kant himself, the relations of which to the critical philosophy furnished matter for surmise. Indirectly, indeed, Kant had indicated a very definite opinion on theology: from the *Critique of Pure Reason* it was clear that for him speculative theology must be purely negative, while the *Critique of Practical Reason* as clearly indicated the view that the moral law is the absolute content or substance of any religion. A critical investigation of the conditions under which religious belief was possible was still wanting. Fichte sent his essay to Kant, who approved it highly, extended to the author a warm reception, and exerted his influence to procure a publisher. After some delay, consequent on the scruples of the theological censor of Halle, who did not like to see miracles rejected, the book appeared (Easter, 1792). By an oversight Fichte's name did not appear on the title-page, nor was the preface given, in which the author spoke of himself as a beginner in philosophy. Outsiders, not unnaturally, ascribed the work to Kant. The *Allgemeine Literatur-Zeitung* went so far as to say that no one who had read a line of Kant's writings could fail to recognize the eminent author of this new work. Kant himself corrected the mistake, at the same time highly commending the work. Fichte's reputation was thus secured at a stroke.

The *Critique of Revelation* marks the culminating point of Fichte's Kantian period. The exposition of the conditions under which revealed religion is possible turns upon the absolute requirements of the moral law in human nature. Religion itself is the belief in this moral law as divine, and such belief is a practical postulate, necessary in order to add force to the law.

It follows that no revealed religion, so far as matter or substance is concerned, can contain anything beyond this law; nor can any fact in the world of experience be recognized by us as supernatural. The supernatural element in religion can only be the divine character of the moral law. Now, the revelation of this divine character of morality is possible only to a being in whom the lower impulses have been, or are, successful in overcoming reverence for the law. In such a case it is conceivable that a revelation might be given in order to add strength to the moral law. Religion ultimately then rests upon the practical reason, and expresses some demand or want of the pure ego. In this conclusion we can trace the prominence assigned by Fichte to the practical element, and the tendency to make the requirements of the ego the ground for all judgment on reality. It was not possible that having reached this point he should not press forward and leave the Kantian position.

This success was coincident with an improvement in the fortunes of the Rahn family, and the marriage took place at Zürich in October 1793. The remainder of the year he spent at Zürich, slowly perfecting his thoughts on the fundamental problems left for solution in the Kantian philosophy. During this period he published anonymously two remarkable political works, *Zurückforderung der Denkfreiheit von den Fürsten Europas* and *Beiträge zur Berichtigung der Urtheile des Publicums über die französische Revolution*. Of these the latter is much the more important. The French Revolution seemed to many earnest thinkers the one great outcry of modern times for the liberty of thought and action which is the eternal heritage of every human being. Unfortunately the political condition of Germany was unfavourable to the formation of an unbiassed opinion on the great movement. The principles involved in it were lost sight of under the mass of spurious maxims on social order which had slowly grown up and stiffened into system. To direct attention to the true nature of revolution, to demonstrate how inextricably the right of liberty is interwoven with the very existence of man as an intelligent agent, to point out the inherent progressiveness of state arrangements, and the consequent necessity of reform or amendment, such are the main objects of the *Beiträge*; and although, as is often the case with Fichte, the arguments are too formal and the distinctions too withdrawn, yet the general idea is nobly conceived and carried out. As in the *Critique of Revelation* so here the rational nature of man and the conditions necessary for its manifestation or realization become the standard for critical judgment.

Towards the close of 1793 Fichte received an invitation to succeed K. L. Reinhold as extraordinary professor of philosophy at Jena. This chair, not in the ordinary faculty, had become, through Reinhold, the most important in the university, and great deliberation was exercised in selecting his successor. It was desired to secure an exponent of Kantianism, and none seemed so highly qualified as the author of the *Critique of Revelation*. Fichte, while accepting the call, desired to spend a year in preparation; but as this was deemed inexpedient he rapidly drew out for his students an introductory outline of his system, and began his lectures in May 1794. His success was instantaneous and complete. The fame of his predecessor was altogether eclipsed. Much of this success was due to Fichte's rare power as a lecturer. In oral exposition the vigour of thought and moral intensity of the man were most of all apparent, while his practical earnestness completely captivated his hearers. He lectured not only to his own class, but on general moral subjects to all students of the university. These general addresses, published under the title *Bestimmung des Gelehrten* (Vocation of the Scholar), were on a subject dear to Fichte's heart, the supreme importance of the highest intellectual culture and the duties incumbent on those who had received it. Their tone is stimulating and lofty.

The years spent at Jena were unusually productive; indeed, the completed Fichtean philosophy is contained in the writings of this period. A general introduction to the system is given in the tractate *Über den Begriff der Wissenschaftslehre* (On the Notion of the Theory of Science), 1794, and the theoretical

portion is worked out in the *Grundlage der gesamten Wissenschaftslehre* (Foundation of the whole Theory of Science, 1794) and *Grundriss des Eigenthümlichen d. Wissenschaftslehre* (Outline of what is peculiar in the Theory of Science, 1794). To these were added in 1797 a *First* and a *Second Introduction to the Theory of Science*, and an *Essay towards a new Exposition of the Theory of Science*. The *Introductions* are masterly expositions. The practical philosophy was given in the *Grundlage des Naturrechts* (1796) and *System der Sittenlehre* (1798). The last is probably the most important of all Fichte's works; apart from it, his theoretical philosophy is unintelligible.

During this period Fichte's academic career had been troubled by various storms, the last so violent as to put a close to his professorate at Jena. The first of them, a complaint against the delivery of his general addresses on Sundays, was easily settled. The second, arising from Fichte's strong desire to suppress the *Landmannschaften* (students' orders), which were productive of much harm, was more serious. Some misunderstanding caused an outburst of ignorant ill-feeling on the part of the students, who proceeded to such lengths that Fichte was compelled to reside out of Jena. The third storm, however, was the most violent. In 1798 Fichte, who, with F. I. Niethammer (1766-1848), had edited the *Philosophical Journal* since 1795, received from his friend F. K. Forberg (1770-1848) an essay on the "Development of the Idea of Religion." With much of the essay he entirely agreed, but he thought the exposition in so many ways defective and calculated to create an erroneous impression, that he prefaced it with a short paper *On the Grounds of our Belief in a Divine Government of the Universe*, in which God is defined as the moral order of the universe, the eternal law of right which is the foundation of all our being. The cry of atheism was raised, and the electoral government of Saxony, followed by all the German states except Prussia, suppressed the *Journal* and confiscated the copies found in their universities. Pressure was put by the German powers on Charles Augustus, grand-duke of Saxe-Weimar, in whose dominions Jena university was situated, to reprove and dismiss the offenders. Fichte's defences (*Appellation an das Publicum gegen die Anklage des Atheismus*, and *Gerichtliche Verantwortung der Herausgeber der phil. Zeitschrift*, 1799), though masterly, did not make it easier for the liberal-minded grand-duke to pass the matter over, and an unfortunate letter, in which he threatened to resign in case of reprimand, turned the scale against him. The grand-duke accepted his threat as a request to resign, passed censure, and extended to him permission to withdraw from his chair at Jena; nor would he alter his decision, even though Fichte himself endeavoured to explain away the unfortunate letter.

Berlin was the only town in Germany open to him. His residence there from 1799 to 1806 was unbroken save for a course of lectures during the summer of 1805 at Erlangen, where he had been named professor. Surrounded by friends, including Schlegel and Schleiermacher, he continued his literary work, perfecting the *Wissenschaftslehre*. The most remarkable of the works from this period are—(1) the *Bestimmung des Menschen* (Vocation of Man, 1800), a book which, for beauty of style, richness of content, and elevation of thought, may be ranked with the *Meditations of Descartes*; (2) *Der geschlossene Handelsstaat*, 1800 (The Exclusive or Isolated Commercial State), a very remarkable treatise, intensely socialist in tone, and inculcating organized protection; (3) *Sonnenklarer Bericht an das grössere Publicum über die neueste Philosophie*, 1801. In 1801 was also written the *Darstellung der Wissenschaftslehre*, which was not published till after his death. In 1804 a set of lectures on the *Wissenschaftslehre* was given at Berlin, the notes of which were published in the *Nachgelassene Werke*, vol. ii. In 1804 were also delivered the noble lectures entitled *Grundzüge des gegenwärtigen Zeitalters* (Characteristics of the Present Age, 1804), containing a most admirable analysis of the *Aufklärung*, tracing the position of such a movement of thought in the natural evolution of the general human consciousness, pointing out its inherent defects, and indicating as the ultimate goal of progress the life of reason in its highest aspect as a belief in the divine

order of the universe. The philosophy of history sketched in this work has something of value with much that is fantastic. In 1805 and 1806 appeared the *Wesen des Gelehrten* (Nature of the Scholar) and the *Anweisung zum seligen Leben oder Religionslehre* (Way to a Blessed Life), the latter the most important work of this Berlin period. In it the union between the finite self-consciousness and the infinite ego or God is handled in an almost mystical manner. The knowledge and love of God is the end of life; by this means only can we attain blessedness (*Seligkeit*), for in God alone have we a permanent, enduring object of desire. The infinite God is the all; the world of independent objects is the result of reflection or self-consciousness, by which the infinite unity is broken up. God is thus over and above the distinction of subject and object; our knowledge is but a reflex or picture of the infinite essence. Being is not thought.

The disasters of Prussia in 1806 drove Fichte from Berlin. He retired first to Stargard, then to Königsberg (where he lectured for a time), then to Copenhagen, whence he returned to the capital in August 1807. From this time his published writings are practical in character; not till after the appearance of the *Nachgelassene Werke* was it known in what shape his final speculations had been thrown out. We may here note the order of these posthumous writings as being of importance for tracing the development of Fichte's thought. From the year 1806 we have the remarkable *Bericht über die Wissenschaftslehre* (*Werke*, vol. viii.), with its sharp critique of Schelling; from 1810 we have the *Thatsachen des Bewusstseyns*, published in 1817, of which another treatment is given in lectures of 1813 (*Nachgel. Werke*, vol. i.). Of the *Wissenschaftslehre* we have, in 1812-1813, four separate treatments contained in the *Nachgel. Werke*. As these consist mainly of notes for lectures, couched in uncouth phraseology, they cannot be held to throw much light on Fichte's views. Perhaps the most interesting are the lectures of 1812 on *Transcendental Logic* (*Nach. Werke*, i. 106-400).

From 1812 we have notes of two courses on practical philosophy, *Rechtslehre* (*Nach. Werke*, vol. ii.) and *Sittenlehre* (*ib.* vol. iii.). A finished work in the same department is the *Staatslehre*, published in 1820. This gives the Fichtean utopia organized on principles of pure reason; in too many cases the proposals are identical with principles of pure despotism.

During these years, however, Fichte was mainly occupied with public affairs. In 1807 he drew up an elaborate and minute plan for the proposed new university of Berlin. In 1807-1808 he delivered at Berlin, amidst danger and discouragement, his noble addresses to the German people (*Reden an die deutsche Nation*). Even if we think that in these pure reason is sometimes overshadowed by patriotism, we cannot but recognize the immense practical value of what he recommended as the only true foundation for national prosperity.

In 1810 he was elected rector of the new university founded in the previous year. This post he resigned in 1812, mainly on account of the difficulties he experienced in his endeavour to reform the student life of the university.

In 1813 began the great effort of Germany for national independence. Debarred from taking an active part, Fichte made his contribution by way of lectures. The addresses on the idea of a true war (*Über den Begriff eines wahrhaften Kriegs*, forming part of the *Staatslehre*) contain a very subtle contrast between the positions of France and Germany in the war.

In the autumn of 1813 the hospitals of Berlin were filled with sick and wounded from the campaign. Among the most devoted in her exertions was Fichte's wife, who, in January 1814, was attacked with a virulent hospital fever. On the day after she was pronounced out of danger Fichte was struck down. He lingered for some days in an almost unconscious state, and died on the 27th of January 1814.

The philosophy of Fichte, worked out in a series of writings, and falling chronologically into two distinct periods, that of Jena and that of Berlin, seemed in the course of its development to undergo a change so fundamental that many critics have sharply separated and opposed to one another an earlier and a later phase. The ground of the modification, further, has been sought and apparently found in quite external influences, principally that of

Schelling's *Naturphilosophie*, to some extent that of Schleiermacher. But as a rule most of those who have adopted this view have done so without the full and patient examination which the matter demands; they have been misled by the difference in tone and style between the earlier and later writings, and have concluded that underlying this was a fundamental difference of philosophic conception. One only, Erdmann, in his *Entwicklung d. deut. Spek. seit Kant*, § 29, seems to give full references to justify his opinion, and even he, in his later work, *Grundriss der Gesch. der Philos.* (ed. 3), § 311, admits that the difference is much less than he had at the first imagined. He certainly retains his former opinion, but mainly on the ground, in itself intelligible and legitimate, that, so far as Fichte's philosophical reputation and influence are concerned, attention may be limited to the earlier doctrines of the *Wissenschaftslehre*. This may be so, but it can be admitted neither that Fichte's views underwent radical change, nor that the *Wissenschaftslehre* was ever regarded as in itself complete, nor that Fichte was unconscious of the apparent difference between his earlier and later utterances. It is demonstrable by various passages in the works and letters that he never looked upon the *Wissenschaftslehre* as containing the whole system; it is clear from the chronology of his writings that the modifications supposed to be due to other thinkers were from the first implicit in his theory; and if one fairly traces the course of thought in the early writings, one can see how he was inevitably led on to the statement of the later and, at first sight, divergent views. On only one point, the position assigned in the *Wissenschaftslehre* to the absolute ego, is there any obscurity; but the relative passages are far from decisive, and from the early work, *Neue Darstellung der Wissenschaftslehre*, unquestionably to be included in the Jena period, one can see that from the outset the doctrine of the absolute ego was held in a form differing only in statement from the later theory.

Fichte's system cannot be compressed with intelligibility. We shall here note only three points:—(a) the origin in Kant; (b) the fundamental principle and method of the *Wissenschaftslehre*; (c) the connexion with the later writings. The most important works for (a) are the "Review of Aenesidemus," and the *Second Introduction to the Wissenschaftslehre*; for (b) the great treatises of the Jena period; for (c) the *Thatsachen des Bewusstseyns* of 1810.

(a) The Kantian system had for the first time opened up a truly fruitful line of philosophic speculation, the transcendental consideration of knowledge, or the analysis of the conditions under which cognition is possible. To Kant the fundamental condition was given in the synthetical unity of consciousness. The primitive fact under which might be gathered the special conditions of that synthesis which we call cognition was this unity. But by Kant there was no attempt made to show that the said special conditions were necessary from the very nature of consciousness itself. Their necessity was discovered and proved in a manner which might be called empirical. Moreover, while Kant in a quite similar manner pointed out that intuition had special conditions, space and time, he did not show any link of connexion between these and the primitive conditions of pure cognition. Closely connected with this remarkable defect in the Kantian view—lying, indeed, at the foundation of it—was the doctrine that the matter of cognition is altogether *given*, or thrown into the *form* of cognition from without. So strongly was this doctrine emphasized by Kant, that he seemed to refer the *matter* of knowledge to the action upon us of a non-ego or *Ding-an-sich*, absolutely beyond consciousness. While these hints towards a completely intelligible account of cognition were given by Kant, they were not reduced to system, and from the way in which the elements of cognition were related, could not be so reduced. Only in the sphere of practical reason, where the intelligible nature prescribed to itself its own laws, was there the possibility of systematic deduction from a single principle.

The peculiar position in which Kant had left the theory of cognition was assailed from many different sides and by many writers, specially by Schultze (Aenesidemus) and Maimon. To the criticisms of the latter, in particular, Fichte owed much, but his own activity went far beyond what they supplied to him. To complete Kant's work, to demonstrate that all the necessary conditions of knowledge can be deduced from a single principle, and consequently to expound the complete system of reason, that is the business of the *Wissenschaftslehre*. By it the theoretical and practical reason shall be shown to coincide; for while the categories of cognition and the whole system of pure thought can be expounded from one principle, the ground of this principle is scientifically, or to cognition, inexplicable, and is made conceivable only in the practical philosophy. The ultimate basis for the activity of cognition is given by the will. Even in the practical sphere, however, Fichte found that the contradiction, insoluble to cognition, was not completely suppressed, and he was thus driven to the higher view, which is explicitly stated in the later writings though not, it must be confessed, with the precision and scientific clearness of the *Wissenschaftslehre*.

(b) What, then, is this single principle, and how does it work itself out into system? To answer this one must bear in mind what Fichte intended by designating all philosophy *Wissenschaftslehre*, or theory of science. Philosophy is to him the rethinking of actual cognition, the *theory* of knowledge, the complete, systematic exposition of the principles which lie at the basis of all reasoned

cognition. It traces the necessary acts by which the cognitive consciousness comes to be what it is, both in form and in content. Not that it is a natural history, or even a *phenomenology* of consciousness; only in the later writings did Fichte adopt even the genetic method of exposition; it is the complete statement of the pure principles of the understanding in their rational or necessary order. But if complete, this *Wissenschaftslehre* must be able to deduce the whole organism of cognition from certain fundamental axioms, themselves unproved and incapable of proof; only thus can we have a *system* of reason. From these primary axioms the whole body of necessary thoughts must be developed, and, as Socrates would say, the argument itself will indicate the path of the development.

Of such primitive principles, the absolutely necessary conditions of possible cognition, only three are thinkable—one perfectly unconditioned both in form and matter; a second, unconditioned in form but not in matter; a third, unconditioned in matter but not in form. Of these, evidently the first must be the fundamental; to some extent it conditions the other two, though these cannot be deduced from it or proved by it. The statement of these principles forms the introduction to *Wissenschaftslehre*.

The method which Fichte first adopted for stating these axioms is not calculated to throw full light upon them, and tends to exaggerate the apparent airiness and unsubstantiality of his deduction. They may be explained thus. The primitive condition of all intelligence is that the ego shall posit, affirm or be aware of itself. The ego is the ego; such is the first pure act of conscious intelligence, that by which alone consciousness can come to be what it is. It is what Fichte called a Deed-act (*That-handlung*); we cannot be aware of the process,—the ego is not until it has affirmed itself,—but we are aware of the result, and can see the necessity of the act by which it is brought about. The ego then posits itself as real. What the ego posits is real. But in consciousness there is equally given a primitive act of op-positing, or contra-positing, formally distinct from the act of positing, but materially determined, in so far as what is op-positing must be the negative of that which was posited. The non-ego—not, be it noticed, the world as we know it—is op-posed in consciousness to the ego. The ego is not the non-ego. How this act of op-positing is possible and necessary, only becomes clear in the practical philosophy, and even there the inherent difficulty leads to a higher view. But third, we have now an absolute antithesis to our original thesis. Only the ego is real, but the non-ego is posited in the ego. The contradiction is solved in a higher synthesis, which takes up into itself the two opposites. The ego and non-ego *limit* one another, or determine one another; and, as limitation is negation of part of a divisible quantum, in this third act, the divisible ego is op-posed to a divisible non-ego.

From this point onwards the course proceeds by the method already made clear. We progress by making explicit the oppositions contained in the fundamental synthesis, by uniting these opposites, analysing the new synthesis, and so on, until we reach an ultimate pair. Now, in the synthesis of the third act two principles may be distinguished:—(1) the non-ego determines the ego; (2) the ego determines the non-ego. As determined the ego is theoretical, as determining it is practical; ultimately the opposed principles must be united by showing how the ego is both determining and determined.

It is impossible to enter here on the steps by which the theoretical ego is shown to develop into the complete system of cognitive categories, or to trace the deduction of the processes (productive imagination, intuition, sensation, understanding, judgment, reason) by which the quite indefinite non-ego comes to assume the appearance of definite objects in the forms of time and space. All this evolution is the necessary consequence of the determination of the ego by the non-ego. But it is clear that the non-ego cannot really determine the ego. There is no reality beyond the ego itself. The contradiction can only be suppressed if the ego itself opposes to itself the non-ego, places it as an *Anstoss* or plane on which its own activity breaks and from which it is reflected. Now, this op-positing of the *Anstoss* is the necessary condition of the practical ego, of the will. If the ego be a striving power, then of necessity a limit must be set by which its striving is manifest. But how can the infinitely active ego posit a limit to its own activity? Here we come to the *crux* of Fichte's system, which is only partly cleared up in the *Rechtslehre* and *Sittenlehre*. If the ego be pure activity, free activity, it can only become aware of itself by positing some limit. We cannot possibly have any cognition of how such an act is possible. But as it is a free act, the ego cannot be determined to it by anything beyond itself; it cannot be aware of its own freedom otherwise than as determined by other free egos. Thus in the *Rechtslehre* and *Sittenlehre*, the multiplicity of egos is deduced, and with this deduction the first form of the *Wissenschaftslehre* appeared to end.

(c) But in fact deeper questions remained. We have spoken of the ego as becoming aware of its own freedom, and have shown how the existence of other egos and of a world in which these egos may act are the necessary conditions of consciousness of freedom. But all this is the work of the ego. All that has been expounded follows if the ego comes to consciousness. We have therefore to consider that the absolute ego, from which spring all the individual egos, is not subject to these conditions, but freely determines itself to them.

How is this absolute ego to be conceived? As early as 1797 Fichte had begun to see that the ultimate basis of his system was the absolute ego, in which is no difference of subject and object; in 1800 the *Bestimmung des Menschen* defined this absolute ego as the infinite moral will of the universe, God, in whom are all the individual egos, from whom they have sprung. It lay in the nature of the thing that more precise utterances should be given on this subject, and these we find in the *Thatsachen des Bewusstseins* and in all the later lectures. God in them is the absolute Life, the absolute One, who becomes conscious of himself by self-direction into the individual egos. The individual ego is only possible as opposed to a non-ego, to a world of the senses; thus God, the infinite will, manifests himself in the individual, and the individual has over against him the non-ego or thing. "The individuals do not make part of the being of the one life, but are a pure form of its absolute freedom." "The individual is not conscious of himself, but the Life is conscious of itself in individual form and as an individual." In order that the Life may act, though it is not necessary that it should act, individualization is necessary. "Thus," says Fichte, "we reach a final conclusion. Knowledge is not mere knowledge of itself, but of being, and of the one being that truly is, viz. God. . . . This one possible object of knowledge is never known in its purity, but ever broken into the various forms of knowledge which are and can be shown to be necessary. The demonstration of the necessity of these forms is philosophy or *Wissenschaftslehre*" (*Thats. des Bewuss. Werke*, ii. 685). This ultimate view is expressed throughout the lectures (in the *Nachgel. Werke*) in uncouth and mystical language.

It will escape no one (1) how the idea and method of the *Wissenschaftslehre* prepare the way for the later Hegelian dialectic, and (2) how completely the whole philosophy of Schopenhauer is contained in the later writings of Fichte. It is not to the credit of historians that Schopenhauer's debt should have been allowed to pass with so little notice.

BIBLIOGRAPHY.—Fichte's complete works were published by his son J. H. Fichte, *Sämmtliche Werke* (8 vols., Berlin, 1845-1846), with *Nachgelassene Werke* (3 vols., Bonn, 1834-1835); also *Leben und Briefwechsel* (2 vols., 1830, ed. 1862). Among translations are those of William Smith, *Popular Writings of Fichte, with Memoir* (2 vols., London, 1848-1849, 4th ed. 1889); A. E. Kroeger, portions of the *Wissenschaftslehre* (*Science of Knowledge*, Philadelphia, 1868; ed. London, 1889), the *Naturrecht* (*Science of Rights*, 1870; ed. London, 1889); of the *Vorlesungen ü. d. Bestimmung d. Gelehrten* (*The Vocation of the Scholar*, by W. Smith, 1847); *Destination of Man*, by Mrs P. Sinnett; *Discours à la nation allemande*, French by Léon Philippe (1895), with preface by F. Picavet, and a biographical memoir.

The number of critical works is very large. Besides the histories of post-Kantian philosophy by Erdmann, Fortlage (whose account is remarkably good), Michelet, Biedermann and others, see Wm. Busse, *Fichte und seine Beziehung zur Gegenwart des deutschen Volkes* (Halle, 1848-1849); J. H. Löwe, *Die Philosophie Fichtes* (Stuttgart, 1862); Kuno Fischer, *Geschichte d. neueren Philosophie* (1869, 1884, 1890); Ludwig Noack, *Fichte nach seinem Leben, Lehren und Wirken* (Leipzig, 1862); R. Adamson, *Fichte* (1881, in Knight's "Philosophical Classics"); Oscar Benzow, *Zu Fichtes Lehre von Nicht-Ich* (Bern, 1898); E. O. Burmann, *Die Transcendentalphilosophie Fichtes und Schellings* (Upsala, 1890-1892); M. Carrière, *Fichtes Geistesentwicklung in die Reden über d. Bestimmung des Gelehrten* (1894); C. C. Everett, *Fichte's Science of Knowledge* (Chicago, 1884); O. Pfeiderer, *J. G. Fichtes Lebensbild eines deutschen Denkers und Patrioten* (Stuttgart, 1877); T. Wotschke, *Fichte und Erigena* (1896); W. Kabitz, *Studien zur Entwicklungsgeschichte der Fichteschen Wissenschaftslehre aus der Kantischen Philosophie* (1902); E. Lask, *Fichtes Idealismus und die Geschichte* (1902); X. Léon, *La Philos. de Fichte* (1902); M. Wiener, *J. G. Fichtes Lehre vom Wesen und Inhalt der Geschichte* (1906).

On Fichte's social philosophy see, e.g., F. Schmidt-Warneck, *Die Sociologie Fichtes* (Berlin, 1884); W. Windelband, *Fichtes Idee des deutschen Staates* (1890); M. Weber, *Fichtes Sozialismus und sein Verhältnis zur Marx'schen Doctrin* (1900); S. H. Gutman, *J. G. Fichtes Sozialpädagogik* (1907); H. Lindau, *Johann G. Fichte und der neuere Socialismus* (1900). (R. AD.; X.)

FICHELGEBIRGE, a mountain group of Bavaria, forming the centre from which various mountain ranges proceed,—the Elstergebirge, linking it to the Erzgebirge, in a N.E., the Frankenswald in a N.W., and the Böhmerwald in a S.E. direction. The streams to which it gives rise flow towards the four cardinal points,—e.g. the Eger eastward and the Saale northward, both to the Elbe; the Weisser Main westward to the Rhine, and the Naab southward to the Danube. The chief points of the mass are the Schneeberg and the Ochsenkopf, the former having a height of 3448, and the latter of 3356 ft. The whole district is pretty thickly populated, and there is great abundance of wood, as well as of iron, vitriol, sulphur, copper, lead and many kinds of marble. The inhabitants are employed chiefly in the

iron mines, at forges and blast furnaces, and in charcoal burning and the manufacture of blacking from firewood. Although surrounded by railways and crossed by the lines Nuremberg-Eger and Regensburg-Oberkotzau, the Fichtelgebirge, owing principally to its raw climate and bleakness, is not much visited by strangers, the only important points of interest being Alexandersbad (a delightfully situated watering-place) and the granite labyrinth of Luisenburg.

See A. Schmidt, *Führer durch das Fichtelgebirge* (1899); Daniel, *Deutschland*; and Meyer, *Conversations-Lexikon* (1904).

FICINO, MARSILIO (1433-1499), Italian philosopher and writer, was born at Figline, in the upper Arno valley, in the year 1433. His father, a physician of some eminence, settled in Florence, and attached himself to the person of Cosimo de' Medici. Here the young Marsilio received his elementary education in grammar and Latin literature at the high school or studio pubblico. While still a boy, he showed promise of rare literary gifts, and distinguished himself by his facility in the acquisition of knowledge. Not only literature, but the physical sciences, as then taught, had a charm for him; and he is said to have made considerable progress in medicine under the tuition of his father. He was of a tranquil temperament, sensitive to music and poetry, and debarred by weak health from joining in the more active pleasures of his fellow-students. When he had attained the age of eighteen or nineteen years, Cosimo received him into his household, and determined to make use of his rare disposition for scholarship in the development of a long-cherished project. During the session of the council for the union of the Greek and Latin churches at Florence in 1439, Cosimo had made acquaintance with Gemistos Plethon, the Neo-Platonic sage of Mistra, whose discourses upon Plato and the Alexandrian mystics so fascinated the learned society of Florence that they named him the second Plato. It had been the dream of this man's whole life to supersede both forms of Christianity by a semi-pagan theosophy deduced from the writings of the later Pythagoreans and Platonists. When, therefore, he perceived the impression he had made upon the first citizen of Florence, Gemistos suggested that the capital of modern culture would be a fit place for the resuscitation of the once so famous Academy of Athens. Cosimo took this hint. The second half of the 15th century was destined to be the age of academies in Italy, and the regnant passion for antiquity satisfied itself with any imitation, however grotesque, of Greek or Roman institutions. In order to found his new academy upon a firm basis Cosimo resolved not only to assemble men of letters for the purpose of Platonic disputation at certain regular intervals, but also to appoint a hierophant and official expositor of Platonic doctrine. He hoped by these means to give a certain stability to his projected institution, and to avoid the superficiality of mere enthusiasm. The plan was good; and with the rare instinct for character which distinguished him, he made choice of the right man for his purpose in the young Marsilio.

Before he had begun to learn Greek, Marsilio entered upon the task of studying and elucidating Plato. It is known that at this early period of his life, while he was yet a novice, he wrote voluminous treatises on the great philosopher, which he afterwards, however, gave to the flames. In the year 1459 John Argyropoulos was lecturing on the Greek language and literature at Florence, and Marsilio became his pupil. He was then about twenty-three years of age. Seven years later he felt himself a sufficiently ripe Greek scholar to begin the translation of Plato, by which his name is famous in the history of scholarship, and which is still the best translation of that author Italy can boast. The MSS. on which he worked were supplied by his patron Cosimo de' Medici and by Amerigo Benci. While the translation was still in progress Ficino from time to time submitted its pages to the scholars, Angelo Poliziano, Cristoforo Landino, Demetrios Chalchondylas and others; and since these men were all members of the Platonic Academy, there can be no doubt that the discussions raised upon the text and Latin version greatly served to promote the purpose of Cosimo's

foundation. At last the book appeared in 1482, the expenses of the press being defrayed by the noble Florentine, Filippo Valori. About the same time Marsilio completed and published his treatise on the Platonic doctrine of immortality (*Theologia Platonica de immortalitate animae*), the work by which his claims to take rank as a philosopher must be estimated. This was shortly followed by the translation of Plotinus into Latin, and by a voluminous commentary, the former finished in 1486, the latter in 1491, and both published at the cost of Lorenzo de' Medici just one month after his death. As a supplement to these labours in the field of Platonic and Alexandrian philosophy, Marsilio next devoted his energies to the translation of Dionysius the Areopagite, whose work on the celestial hierarchy, though recognized as spurious by the Neapolitan humanist, Lorenzo Valla, had supreme attraction for the mystic and uncritical intellect of Ficino.

It is not easy to value the services of Marsilio Ficino at their proper worth. As a philosopher, he can advance no claim to originality, his laborious treatise on Platonic theology being little better than a mass of ill-digested erudition. As a scholar, he failed to recognize the distinctions between different periods of antiquity and various schools of thought. As an exponent of Plato he suffered from the fatal error of confounding Plato with the later Platonists. It is true that in this respect he did not differ widely from the mass of his contemporaries. Lorenzo Valla and Angelo Poliziano, almost alone among the scholars of that age, showed a true critical perception. For the rest, it was enough that an author should be ancient to secure their admiration. The whole of antiquity seemed precious in the eyes of its discoverers; and even a thinker so acute as Pico di Mirandola dreamed of the possibility of extracting the essence of philosophical truth by indiscriminate collation of the most divergent doctrines. Ficino was, moreover, a firm believer in planetary influences. He could not separate his philosophical from his astrological studies, and caught eagerly at any fragment of antiquity which seemed to support his cherished delusions. It may here be incidentally mentioned that this superstition brought him into trouble with the Roman Church. In 1489 he was accused of magic before Pope Innocent VIII., and had to secure the good offices of Francesco Soderini, Ermolao Barbaro, and the archbishop Rinaldo Orsini, in order to purge himself of a most perilous imputation. What Ficino achieved of really solid, was his translation. The value of that work cannot be denied; the impulse which it gave to Platonic studies in Italy, and through them to the formation of the new philosophy in Europe, is indisputable. Ficino differed from the majority of his contemporaries in this that, while he felt the influence of antiquity no less strongly than they did, he never lost his faith in Christianity, or contaminated his morals by contact with paganism. For him, as for Petrarch, St Augustine was the model of a Christian student. The cardinal point of his doctrine was the identity of religion and philosophy. He held that philosophy consists in the study of truth and wisdom, and that God alone is truth and wisdom,—so that philosophy is but religion, and true religion is genuine philosophy. Religion, indeed, is common to all men, but its pure form is that revealed through Christ; and the teaching of Christ is sufficient to a man in all circumstances of life. Yet it cannot be expected that every man should accept the faith without reasoning; and here Ficino found a place for Platonism. He maintained that the Platonic doctrine was providentially made to harmonize with Christianity, in order that by its means speculative intellects might be led to Christ. The transition from this point of view to an almost superstitious adoration of Plato was natural; and Ficino, we know, joined in the hymns and celebrations with which the Florentine Academy honoured their great master on the day of his birth and death. Those famous festivals in which Lorenzo de' Medici delighted had indeed a pagan tone appropriate to the sentiment of the Renaissance; nor were all the worshippers of the Athenian sage so true to Christianity as his devoted student.

Of Ficino's personal life there is but little to be said. In order that he might have leisure for uninterrupted study, Cosimo de'

Medici gave him a house near S. Maria Nuova in Florence, and a little farm at Montecatini, not far from the villa of Careggi. Ficino, like nearly all the scholars of that age in Italy, delighted in country life. At Montecatini he lived contentedly among his books, in the neighbourhood of his two friends, Pico at Querceto, and Poliziano at Fiesole, cheering his solitude by playing on the lute, and corresponding with the most illustrious men of Italy. His letters, extending over the years 1474–1494, have been published, both separately and in his collected works. From these it may be gathered that nearly every living scholar of note was included in the list of his friends, and that the subjects which interested him were by no means confined to his Platonic studies. As instances of his close intimacy with illustrious Florentine families, it may be mentioned that he held the young Francesco Guicciardini at the font, and that he helped to cast the horoscope of the Casa Strozzi in the Via Tornabuoni.

At the age of forty Ficino took orders, and was honoured with a canonry of S. Lorenzo. He was henceforth assiduous in the performance of his duties, preaching in his cure of Novoli, and also in the cathedral and the church of the Angeli at Florence. He used to say that no man was better than a good priest, and none worse than a bad one. His life corresponded in all points to his principles. It was the life of a sincere Christian and a real sage,—of one who found the best fruits of philosophy in the practice of the Christian virtues. A more amiable and a more harmless man never lived; and this was much in that age of discordant passions and lawless licence. In spite of his weak health, he was indefatigably industrious. His tastes were of the simplest; and while scholars like Filelfo were intent on extracting money from their patrons by flattery and threats, he remained so poor that he owed the publication of all his many works to private munificence. For his old patrons of the house of Medici Ficino always cherished sentiments of the liveliest gratitude. Cosimo he called his second father, saying that Ficino had given him life, but Cosimo new birth,—the one had devoted him to Galen, the other to the divine Plato,—the one was physician of the body, the other of the soul. With Lorenzo he lived on terms of familiar, affectionate, almost parental intimacy. He had seen the young prince grow up in the palace of the Via Larga, and had helped in the development of his rare intellect. In later years he did not shrink from uttering a word of warning and advice, when he thought that the master of the Florentine republic was too much inclined to yield to pleasure. A characteristic proof of his attachment to the house of Medici was furnished by a yearly custom which he practised at his farm at Montecatini. He used to invite the contadini who had served Cosimo to a banquet on the day of Saints Cosimo and Damiano (the patron saints of the Medici), and entertained them with music and singing. This affection was amply returned. Cosimo employed almost the last hours of his life in listening to Ficino's reading of a treatise on the highest good; while Lorenzo, in a poem on true happiness, described him as the mirror of the world, the nursling of sacred muses, the harmonizer of wisdom and beauty in complete accord. Ficino died at Florence in 1499.

Besides the works already noticed, Ficino composed a treatise on the Christian religion, which was first given to the world in 1476, a translation into Italian of Dante's *De monarchia*, a life of Plato, and numerous essays on ethical and semi-philosophical subjects. Vigour of reasoning and originality of view were not his characteristics as a writer; nor will the student who has raked these dust-heaps of miscellaneous learning and old-fashioned mysticism discover more than a few sentences of genuine enthusiasm and simple-hearted aspiration to repay his trouble and reward his patience. Only in familiar letters, prolegomena, and prefaces do we find the man Ficino, and learn to know his thoughts and sentiments unclouded by a mist of citations; these minor compositions have therefore a certain permanent value, and will continually be studied for the light they throw upon the learned circle gathered round Lorenzo in the golden age of humanism.

The student may be referred for further information to the following works:—*Marsilii Ficini opera* (Basileae, 1576); *Marsilii Ficini vita*, auctore Corsio (ed. Bandini, Pisa, 1771); Roscoe's *Life of Lorenzo de' Medici*; Pasquale Villari, *La Storia di Girolamo Savonarola* (Firenze, Le Monnier, 1859); Von Reumont, *Lorenzo de' Medici* (Leipzig, 1874).

FICKSBURG, a town of Orange Free State 110 m. by rail E. by N. of Bloemfontein. Pop. (1904) 1954, of whom 1021 were whites. The town is situated near the north bank of the Caledon river and is the capital of one of the finest agricultural and stock-raising regions of the province. It has direct railway communication with Natal and an extensive trade. In the neighbourhood are petroleum wells and a diamond mine. In the fossilized ooze of the Wonderkop, a table mountain of the adjacent Wittebergen, are quantities of petrified fish.

FICTIONS, or legal fictions, in law, the term used for false averments, the truth of which is not permitted to be called in question. English law as well as Roman law abounds in fictions. Sometimes they are merely the condensed expression of a rule of law,—e.g., the fiction of English law that husband and wife were one person, and the fiction of Roman law that the wife was the daughter of the husband. Sometimes they must be regarded as reasons invented in order to justify a rule of law according to an implied ethical standard. Of this sort seems to be the fiction or presumption that every one knows the law, which reconciles the rule that ignorance is no excuse for crime with the moral commonplace that it is unfair to punish a man for violating a law of whose existence he was unaware. Again, some fictions are deliberate falsehoods, adopted as true for the purpose of establishing a remedy not otherwise attainable. Of this sort are the numerous fictions of English law by which the different courts obtained jurisdiction in private business, removed inconvenient restrictions in the law relating to land, &c.

What to the scientific jurist is a stumbling-block is to the older writers on English law a beautiful device for reconciling the strict letter of the law with common sense and justice. Blackstone, in noticing the well-known fiction by which the court of king's bench established its jurisdiction in common pleas (viz. that the defendant was in custody of the marshal of the court), says, "These fictions of law, though at first they may startle the student, he will find upon further consideration to be highly beneficial and useful; especially as this maxim is ever invariably observed, that no fiction shall extend to work an injury; its proper operation being to prevent a mischief or remedy an inconvenience that might result from the general rule of law. So true it is that *in fictione juris semper subsistit aequitas*." Austin, on the other hand, while correctly assigning as the cause of many fictions the desire to combine the necessary reform with some show of respect for the abrogated law, makes the following harsh criticism as to others:—"Why the plain meanings which I have now stated should be obscured by the fictions to which I have just adverted I cannot conjecture. A wish on the part of the authors of the fictions to render the law as *uncognoscible* as may be is probably the cause which Mr Bentham would assign. I judge not, I confess, so uncharitably; I rather impute such fictions to the sheer imbecility (or, if you will, to the active and sportive fancies) of their grave and venerable authors, than to any deliberate design, good or evil." Bentham, of course, saw in fictions the instrument by which the great object of his abhorrence, *judiciary law*, was produced. It was the means by which judges usurped the functions of legislators. "A fiction of law," he says, "may be defined as a wilful falsehood, having for its object the stealing legislative powers by and for hands which could not or durst not openly claim it, and but for the delusion thus produced could not exercise it." A partnership, he says, was formed between the kings and the judges against the interests of the people. "Monarchs found force, lawyers fraud; thus was the capital found" (*Historical Preface to the second edition of the Fragment on Government*).¹

¹ In the same essay Bentham notices the comparative rarity of fictions in Scots law. As to fiction in particular, compared with the

Sir H. Maine (*Ancient Law*) supplies the historical element which is always lacking in the explanations of Austin and Bentham. Fictions form one of the agencies by which, in progressive societies, positive law is brought into harmony with public opinion. The others are equity and statutes. Fictions in this sense include, not merely the obvious falsities of the English and Roman systems, but any assumption which conceals a change of law by retaining the old formula after the change has been made. It thus includes both the case law of the English and the *Responsa Prudentum* of the Romans. "At a particular stage of social progress they are invaluable expedients for overcoming the rigidity of law; and, indeed, without one of them, the fiction of adoption, which permits the family tie to be artificially created, it is difficult to understand how society would ever have escaped from its swaddling clothes, and taken its first steps towards civilization."

The bolder remedial fictions of English law have been to a large extent removed by legislation, and one great obstacle to any reconstruction of the legal system has thus been partially removed. Where the real remedy stood in glaring contrast to the nominal rule, it has been openly ratified by statute. In ejectment cases the mysterious sham litigants have disappeared. The bond of entail can be broken without having recourse to the collusive proceedings of fine and recovery. Fictions have been almost entirely banished from the procedure of the courts. The action for damages on account of seduction, which is still nominally an action by the father for loss of his daughter's services, is perhaps the only fictitious action now remaining.

Fictions which appear in the form of principles are not so easily dealt with by legislation. To expel them formally from the system would require the re-enactment of vast portions of law. A change in legal modes of speech and thought would be more effective. The legal mind instinctively seizes upon concrete aids to abstract reasoning. Many hard and revolting fictions must have begun their career as metaphors. In some cases the history of the change may still almost be traced. The conception that a man-of-war is a floating island, or that an ambassador's house is beyond the territorial limits of the country in which he resides, was originally a figure of speech designed to set a rule of law in a striking light. It is then gravely accepted as true in fact, and other rules of law are deduced from it. Its beginning is to be compared with such phrases as "an Englishman's house is his castle," which have had no legal offshoots and still remain mere figures of speech.

Constitutional law is of course honeycombed with fictions. Here there is hardly ever anything like direct legislative change, and yet real change is incessant. The rules defining the sovereign power and fixing the authority of its various members are in most points the same as they were at the last revolution,—in many points they have been the same since the beginning of parliamentary government. But they have long ceased to be true in fact; and it would hardly be too much to say that the entire series of formal propositions called the constitution is merely a series of fictions. The legal attributes of the king, and even of the House of Lords, are fictions. If we could suppose that the effects of the Reform Acts had been brought about, not by legislation, but by the decisions of law courts and the practice of House of Commons committees—by such assumptions as that freeholder includes lease-holder and that ten means twenty—we should have in the legal constitution of the House of Commons the same kind of fictions that we find in the legal statement of the attributes of the crown and the House of Lords. Here, too, fictions have been largely resorted to for the purpose of supporting particular

work done by it in English law, the use made of it by the Scottish lawyers is next to nothing. No need have they had of any such clumsy instrument. They have two others "of their own making, by which things of the same sort have been done with much less trouble. *Nobile officium* gives them the creative power of legislation; this and the word *desuetude* together the annihilative." And he notices aptly enough that, while the English lawyers declared that James II. had abdicated the throne (which everybody knew to be false), the Scottish lawyers boldly said he had forfeited it.

theories,—popular or monarchical,—and such have flourished even more vigorously than purely legal fictions.

FIDDES, RICHARD (1671–1725), English divine and historian, was born at Hunmanby and educated at Oxford. He took orders, and obtained the living of Halsham in Holderness in 1696. Owing to ill-health he applied for leave to reside at Wickham, and in 1712 he removed to London on the plea of poverty, intending to pursue a literary career. In London he met Swift, who procured him a chaplaincy at Hull. He also became chaplain to the earl of Oxford. After losing the Hull chaplaincy through a change of ministry in 1714, he devoted himself to writing. His best book is a *Life of Cardinal Wolsey* (London, 1724), containing documents which are still valuable for reference; of his other writings the *Prefatory Epistle containing some remarks to be published on Homer's Iliad* (London, 1714), was occasioned by Pope's proposed translation of the *Iliad*, and his *Theologia speculativa* (London, 1718), earned him the degree of D.D. at Oxford. In his own day he had a considerable reputation as an author and man of learning.

FIDDLE (O. Eng. *fiþele*, *fidcl*, &c., Fr. *vièle*, *viòle*, *violon*; M. H. Ger. *videle*, mod. Ger. *Fiedel*), a popular term for the violin, derived from the names of certain of its ancestors. The word fiddle antedates the appearance of the violin by several centuries, and in England did not always represent an instrument of the same type. The word has first been traced in 1205 in Layamon's *Brut* (7002), "of harpe, of salteriu, of fiþele and of coriu." In Chaucer's time the fiddle was evidently a well-known instrument:

"For him was lever have at his beddes hed
A twenty bokes, clothed in black or red,
Of Aristotle and his Philosophie,
Than robes riche or fidel or sautric."

(*Prologue*, v. 298.)

The origin of the fiddle is of the greatest interest; it will be found inseparable from that of the violin both as regards the instruments and the etymology of the words; the remote common ancestor is the *ketharah* of the Assyrians, the parent of the Greek cithara. The Romans are responsible for the word fiddle, having bestowed upon a kind of cithara—probably then in its first transition—the name of *fidiculae* (more rarely *fidicula*), a diminutive form of *fides*. In Alain de Lille's *De planctu naturae* against the word *lira* stands as equivalent *viòel*, with the definition "Lira est quoddam genue citharae vel fitola alioquin de reot. Hoc instrumentum est multum vulgare." This is a marginal note in writing of the 13th century.¹

Some of the transitions from *fidicula* to fiddle are made evident in the accompanying table:

Latin	fidiculae
Medieval Latin	vitula, fitola.
French	vièle, vielle, viòle.
Provençal	viula.
Spanish	viguela, vihuela, vigolo.
Old High German	fidula.
Middle High German	videle.
German	fedel, violine.
Italian	viola, violino.
Dutch	vedel.
Danish	fiddel.
Anglo-Saxon	fiþele.
Old English	fiþele, fythal, fithel, fythylle, fidel, fidylle, (south) vithele.

For the descent of the guitar-fiddle, the first bowed ancestor of the violin, through many transitions from the cithara, see CITHARA, GUITAR and GUITAR-FIDDLE.

In the minnesinger and troubadour fiddles, of which evidences abound during the 12th, 13th and 14th centuries, are to be observed the structural characteristics of the violin and its ancestors in the course of evolution. The principal of these are first of all the shallow sound-chest, composed of belly and back, almost flat, connected by ribs (also present in the cithara), with incurvations more or less pronounced, an arched bridge, a finger-board and strings (varying in number), vibrated by means

of a bow. The central rose sound-holes of stringed instruments whose strings are plucked by fingers or plectrum have given place to smaller lateral sound-holes placed on each side of the strings. It is in Germany,¹ where contemporary drawings of fiddles of the 13th and 14th centuries furnish an authoritative clue, and in France, that the development may best be followed. The German minnesinger fiddle with sloping shoulders was the prototype of the viols, whereas the guitar-fiddle produced the violin through the intermediary of the Italian bowed *Lyra*.

The fiddle of the Carolingian epoch,—such, for instance, as that mentioned by Otfrid of Weissenburg² in his *Harmony of the Gospels* (c. 868),

"Sih thar ouch al ruarit
This organo fuarit
Lira joh fidula," &c.,—

was in all probability still an instrument whose strings were plucked by the fingers, a cithara in transition. (K. S.)

FIDENAE, an ancient town of Latium, situated about 5 m. N. of Rome on the Via Salaria, which ran between it and the Tiber. It was for some while the frontier of the Roman territory and was often in the hands of Veii. It appears to have fallen under the Roman sway after the capture of this town, and is spoken of by classical authors as a place almost deserted in their time. It seems, however, to have had some importance as a post station. The site of the *arx* of the ancient town is probably to be sought on the hill on which lies the Villa Spada, though no traces of early buildings or defences are to be seen: pre-Roman tombs are to be found in the cliffs to the north. The later village lay at the foot of the hill on the eastern edge of the high-road, and its *curia*, with a dedicatory inscription to M. Aurelius by the *Senatus Fidenatium*, was excavated in 1889. Remains of other buildings may also be seen.

See T. Ashby in *Papers of the British School at Rome*, iii. 17.

FIDUCIARY (Lat. *fiduciarius*, one in whom trust, *fiducia*, is reposed), of or belonging to a position of trust, especially of one who stands in a particular relationship of confidence to another. Such relationships are, in law, those of parent and child, guardian and ward, trustee and *cestui que trust*, legal adviser and client, spiritual adviser, doctor and patient, &c. In many of these the law has attached special obligations in the case of gifts made to the "fiduciary," on whom is laid the onus of proving that no "undue influence" has been exercised. (See CONTRACT; CHILDREN, LAW RELATING TO; INFANT; TRUST.)

FIEF, a feudal estate in land, land held from a superior (see FEUDALISM). The word is the French form, which is represented in Medieval Latin as *feudum* or *feodum*, and in English as "fee" or "feu" (see FEE). The A.Fr. *feoffer*, to invest with a fief or fee, has given the English law terms "feoffee" and "feoffment" (*q.v.*).

FIELD, CYRUS WEST (1819–1892), American capitalist, projector of the first Atlantic cable, was born at Stockbridge, Massachusetts, on the 30th of November 1819. He was a brother of David Dudley Field. At fifteen he became a clerk in the store of A. T. Stewart & Co., of New York, and stayed there three years; then worked for two years with his brother, Matthew Dickinson Field, in a paper-mill at Lee, Massachusetts; and in 1840 went into the paper business for himself at Westfield, Massachusetts, but almost immediately became a partner in E. Root & Co., wholesale paper dealers in New York City, who failed in the following year. Field soon afterwards formed with a

¹ See the Manesse MSS. reproduced in part by F. H. von der Hagen, *Heldenbilder* (Leipzig and Berlin, 1855) and *Bildersaal*. The fiddles are reproduced in J. Rühlmann's *Geschichte der Bogeninstrumente* (Brunswick, 1882), plates.

² See Schiller's *Thesaurus antiq. Teut.* vol. i. p. 379.



From Julius Rühlmann's *Geschichte der Bogeninstrumente*.

Minnesinger Fiddle. Germany, 13th Century, from the Manesse MSS.

brother-in-law the firm of Cyrus W. Field & Co., and in 1853 had accumulated \$250,000, paid off the debts of the Root company and retired from active business, leaving his name and \$100,000 with the concern. In the same year he travelled with Frederick E. Church, the artist, through South America. In 1854 he became interested, through his brother Matthew, a civil engineer, in the project of Frederick Newton Gisborne (1824-1892) for a telegraph across Newfoundland; and he was attracted by the idea of a trans-Atlantic telegraphic cable, as to which he consulted S. F. B. Morse and Matthew F. Maury, head of the National Observatory at Washington. With Peter Cooper, Moses Taylor (1806-1882), Marshall Owen Roberts (1814-1880) and Chandler White, he formed the New York, Newfoundland & London Telegraph Company, which procured a more favourable charter than Gisborne's, and had a capital of \$1,500,000. Having secured all the practicable landing rights on the American side of the ocean, he and John W. Brett, who was now his principal colleague, approached Sir Charles Bright (*q.v.*) in London, and in December 1856 the Atlantic Telegraph Company was organized by them in Great Britain, a government grant being secured of £14,000 annually for government messages, to be reduced to £10,000 annually when the cable should pay a 6% yearly dividend; similar grants were made by the United States government. Unsuccessful attempts to lay the cable were made in August 1857 and in June 1858, but the complete cable was laid between the 7th of July and the 5th of August 1858; for a time messages were transmitted, but in October the cable became useless, owing to the failure of its electrical insulation. Field, however, did not abandon the enterprise, and finally in July 1866, after a futile attempt in the previous year, a cable was laid and brought successfully into use. From the Congress of the United States he received a gold medal and a vote of thanks, and he received many other honours both at home and abroad. In 1877 he bought a controlling interest in the New York Elevated Railroad Company, controlling the Third and Ninth Avenue lines, of which he was president in 1877-1880. He worked with Jay Gould for the completion of the Wabash railway, and at the time of his greatest stock activity bought *The New York Evening Express* and *The Mail* and combined them as *The Mail and Express*, which he controlled for six years. In 1879 Field suffered financially by Samuel J. Tilden's heavy sales (during Field's absence in Europe) of "Elevated" stock, which forced the price down from 200 to 164; but Field lost much more in the great "Manhattan squeeze" of the 24th of June 1887, when Jay Gould and Russell Sage, who had been supposed to be his backers in an attempt to bring the Elevated stock to 200, forsook him, and the price fell from 156½ to 114 in half an hour. Field died in New York on the 12th of July 1892.

See the biography by his daughter, Isabella (Field) Judson, *Cyrus W. Field, His Life and Work* (New York, 1896); H. M. Field, *History of the Atlantic Telegraph* (New York, 1866); and Charles Bright, *The Story of the Atlantic Cable* (New York, 1903).

FIELD, DAVID DUDLEY (1805-1894), American lawyer and law reformer, was born in Haddam, Connecticut, on the 13th of February 1805. He was the oldest of the four sons of the Rev. David Dudley Field (1781-1867), a well-known American clergyman and author. He graduated at Williams College in 1825, and settled in New York City, where he studied law, was admitted to the bar in 1828, and rapidly won a high position in his profession. Becoming convinced that the common law in America, and particularly in New York state, needed radical changes in respect to the unification and simplification of its procedure, he visited Europe in 1836 and thoroughly investigated the courts, procedure and codes of England, France and other countries, and then applied himself to the task of bringing about in the United States a codification of the common law procedure. For more than forty years every moment that he could spare from his extensive practice was devoted to this end. He entered upon his great work by a systematic publication of pamphlets and articles in journals and magazines in behalf of his reform, but for some years he met with a discouraging lack of interest. He appeared personally before successive legislative committees, and

in 1846 published a pamphlet, "The Reorganization of the Judiciary," which had its influence in persuading the New York State Constitutional Convention of that year to report in favour of a codification of the laws. Finally in 1847 he was appointed as the head of a state commission to revise the practice and procedure. The first part of the commission's work, consisting of a code of civil procedure, was reported and enacted in 1848, and by the 1st of January 1850 the complete code of civil and criminal procedure was completed, and was subsequently enacted by the legislature. The basis of the new system; which was almost entirely Field's work, was the abolition of the existing distinction in forms of procedure between suits in law and equity requiring separate actions, and their unification and simplification in a single action. Eventually the civil code with some changes was adopted in twenty-four states, and the criminal code in eighteen, and the whole formed a basis of the reform in procedure in England and several of her colonies. In 1857 Field became chairman of a state commission for the reduction into a written and systematic code of the whole body of law of the state, excepting those portions already reported upon by the Commissioners of Practice and Pleadings. In this work he personally prepared almost the whole of the political and civil codes. The codification, which was completed in February 1865, was adopted only in small part by the state, but it has served as a model after which most of the law codes of the United States have been constructed. In 1866 he proposed to the British National Association for the Promotion of Social Science a revision and codification of the laws of all nations. For an international commission of lawyers he prepared *Draft Outlines of an International Code* (1872), the submission of which resulted in the organization of the international Association for the Reform and Codification of the Laws of Nations, of which he became president. In politics Field was originally an anti-slavery Democrat, and he supported Van Buren in the Free Soil campaign of 1848. He gave his support to the Republican party in 1856 and to the Lincoln administration throughout the Civil War. After 1876, however, he returned to the Democratic party, and from January to March 1877 served out in Congress the unexpired term of Smith Ely, elected mayor of New York City. During his brief Congressional career he delivered six speeches, all of which attracted attention, introduced a bill in regard to the presidential succession, and appeared before the Electoral Commission in Tilden's interest. He died in New York City on the 13th of April 1894.

Part of his numerous pamphlets and addresses were collected in his *Speeches, Arguments and Miscellaneous Papers* (3 vols., 1884-1890). See also the *Life of David Dudley Field* (New York, 1898), by Rev. Henry Martyn Field.

FIELD, EUGENE (1850-1895), American poet, was born at St Louis, Missouri, on the 2nd of September 1850. He spent his boyhood in Vermont and Massachusetts; studied for short periods at Williams and Knox Colleges and the University of Missouri, but without taking a degree; and worked as a journalist on various papers, finally becoming connected with the *Chicago News*. *A Little Book of Profitable Tales* appeared in Chicago in 1889 and in New York the next year; but Field's place in later American literature chiefly depends upon his poems of Christmas-time and childhood (of which "Little Boy Blue" and "A Dutch Lullaby" are most widely known), because of their union of obvious sentiment with fluent lyrical form. His principal collections of poems are: *A Little Book of Western Verse* (1889); *A Second Book of Verse* (1892); *With Trumpet and Drum* (1892); and *Love Songs of Childhood* (1894). Field died at Chicago on the 4th of November 1895.

His works were collected in ten volumes (1896), at New York. His prose *Love-affairs of a Bibliomaniac* (1896) contains a Memoir by his brother Roswell Martin Field (b. 1851). See also Slason Thompson, *Eugene Field: a study in heredity and contradictions* (2 vols., New York, 1901).

FIELD, FREDERICK (1801-1885), English divine and biblical scholar, was born in London and educated at Christ's hospital and Trinity College, Cambridge, where he obtained a fellowship in 1824. He took orders in 1828, and began a close study of patristic theology. Eventually he published an emended and

annotated text of Chrysostom's *Homiliae in Matthaem* (Cambridge, 1839), and some years later he contributed to Pusey's *Bibliotheca Patrum* (Oxford, 1838–1870), a similarly treated text of Chrysostom's homilies on Paul's epistles. The scholarship displayed in both of these critical editions is of a very high order. In 1839 he had accepted the living of Great Saxham, in Suffolk, and in 1842 he was presented by his college to the rectory of Reepham in Norfolk. He resigned in 1863, and settled at Norwich, in order to devote his whole time to study. Twelve years later he completed the *Origenis Hexaplorum quae supersunt* (Oxford, 1867–1875), now well known as *Field's Hexapla*, a text reconstructed from the extant fragments of Origen's work of that name, together with materials drawn from the *Syro-hexaplar* version and the *Septuagini* of Holmes and Parsons (Oxford, 1798–1827). Field was appointed a member of the Old Testament revision company in 1870.

FIELD, HENRY MARTYN (1822–1907), American author and clergyman, brother of Cyrus Field, was born at Stockbridge, Massachusetts, on the 3rd of April 1822; he graduated at Williams College in 1838, and was pastor of a Presbyterian church in St Louis, Missouri, from 1842 to 1847, and of a Congregational church in West Springfield, Massachusetts, from 1850 to 1854. The interval between his two pastorates he spent in Europe. From 1854 to 1898 he was editor and for many years he was also sole proprietor of *The Evangelist*, a New York periodical devoted to the interests of the Presbyterian church. He spent the last years of his life in retirement at Stockbridge, Mass., where he died on the 26th of January 1907. He was the author of a series of books of travel, which achieved unusual popularity. His two volumes descriptive of a trip round the world in 1875–1876, entitled *From the Lakes of Killarney to the Golden Horn* (1876) and *From Egypt to Japan* (1877), are almost classic in their way, and have passed through more than twenty editions. Among his other publications are *The Irish Confederates and the Rebellion of 1798* (1850), *The History of the Atlantic Telegraph* (1866), *Faith or Agnosticism? the Field-Ingersoll Discussion* (1888), *Old Spain and New Spain* (1888), and *Life of David Dudley Field* (1898).

He is not to be confused with another HENRY MARTYN FIELD, the gynaecologist, who was born in 1837 at Brighton, Mass., and graduated at Harvard in 1859 and at the College of Physicians and Surgeons in New York City in 1862; he was professor of *Materia Medica* and therapeutics at Dartmouth from 1871 to 1887 and of therapeutics from 1887 to 1893.

FIELD, JOHN (1782–1837), English musical composer and pianist, was born at Dublin in 1782. He came of a musical family, his father being a violinist, and his grandfather the organist in one of the churches of Dublin. From the latter the boy received his first musical education. When a few years later the family settled in London, Field became the favourite pupil of the celebrated Clementi, whom he accompanied to Paris, and later, in 1802, on his great concert tour through France, Germany and Russia. Under the auspices of his master Field appeared in public in most of the great European capitals, especially in St Petersburg, and in that city he remained when Clementi returned to England. During his stay with the great pianist Field had to suffer many privations owing to Clementi's all but unexampled parsimony; but when the latter left Russia his splendid connexion amongst the highest circles of the capital became Field's inheritance. His marriage with a French lady of the name of Charpentier was anything but happy, and had soon to be dissolved. Field made frequent concert tours to the chief cities of Russia, and in 1820 settled permanently in Moscow. In 1831 he came to England for a short time, and for the next four years led a migratory life in France, Germany and Italy, exciting the admiration of amateurs wherever he appeared in public. In Naples he fell seriously ill, and lay several months in the hospital, till a Russian family discovered him and brought him back to Moscow. There he lingered for several years till his death on the 11th of January 1837. Field's training and the cast of his genius were not of a kind to enable him to excel in the larger forms of instrumental music, and his seven concerti

for the pianoforte are now forgotten. Neither do his quartets for strings and pianoforte hold their own by the side of those of the great masters. But his "nocturnes," a form of music highly developed if not actually created by him, remain all but unrivalled for their tenderness and dreaminess of conception, combined with a continuous flow of beautiful melody. They were indeed Chopin's models. Field's execution on the pianoforte was nearly allied to the nature of his compositions, beauty and poetical charm of touch being one of the chief characteristics of his style. Moscheles, who heard Field in 1831, speaks of his "enchanting legato, his tenderness and elegance and his beautiful touch."

FIELD, MARSHALL (1835–1906), American merchant, was born at Conway, Massachusetts, on the 18th of August 1835. Reared on a farm, he obtained a common school and academy education, and at the age of seventeen became a clerk in a dry goods store at Pittsfield, Mass. In 1856 he removed to Chicago, where he became a clerk in the large mercantile establishment of Cooley, Wadsworth & Company. In 1860 the firm was reorganized as Cooley, Farwell & Company, and he was admitted to a junior partnership. In 1865, with Potter Palmer (1826–1902) and Levi Z. Leiter (1834–1904), he organized the firm of Field, Palmer & Leiter, which subsequently became Field, Leiter & Company, and in 1881 on the retirement of Leiter became Marshall Field & Company. Under Field's management the annual business of the firm increased from \$12,000,000 in 1871 to more than \$40,000,000 in 1895, when it ranked as one of the two or three largest mercantile establishments in the world. He died in New York city on the 16th of January 1906. He had married, for the second time, in the previous year. Field's public benefactions were numerous; notable among them being his gift of land valued at \$300,000 and of \$100,000 in cash to the University of Chicago, an endowment fund of \$1,000,000 to support the Field Columbian Museum at Chicago, and a bequest of \$8,000,000 to this museum.

FIELD, NATHAN (1587–1633), English dramatist and actor, was baptized on the 17th of October 1587. His father, the rector of Cripplegate, was a Puritan divine, author of a *Godly Exhortation* directed against play-acting, and his brother Theophilus became bishop of Hereford. Nat. Field early became one of the children of Queen Elizabeth's chapel, and in that capacity he played leading parts in Ben Jonson's *Cynthia's Revels* (in 1600), in the *Poetaster* (in 1601), and in *Epicœne* (in 1608), and the title rôle in Chapman's *Bussy d'Ambois* (in 1606). Ben Jonson was his dramatic model, and may have helped his career. The two plays of which he was author were probably both written before 1611. They are boisterous, but well-constructed comedies of contemporary London life; the earlier one, *A Woman is a Weathercock* (printed 1612), dealing with the inconstancy of woman, while the second, *Amends for Ladies* (printed 1618), was written with the intention, as the title indicates, of retracting the charge. From Henslowe's papers it appears that Field collaborated with Robert Daborne and with Philip Massinger, one letter from all three authors being a joint appeal for money to free them from prison. In 1614 Field received £10 for playing before the king in *Bartholomew Fair*, a play in which Jonson records his reputation as an actor in the words "which is your Burbadge now? . . . Your best actor, your Field?" He joined the King's Players some time before 1619, and his name comes seventeenth on the list prefixed to the Shakespeare folio of 1623 of the "principal actors in all these plays." He retired from the stage before 1625, and died on the 20th of February 1633. Field was part author with Massinger in the *Fatal Dowry* (printed 1632), and he prefixed commendatory verses to Fletcher's *Faithful Shepherdess*.

His two plays were reprinted in J. P. Collier's *Five Old Plays* (1833), in Hazlitt's edition of *Dodstey's Old Plays*, and in *Nero and other Plays* (Mermaid series, 1888), with an introduction by Mr A. W. Verity.

FIELD, STEPHEN JOHNSON (1816–1899), American jurist, was born at Haddam, Connecticut, on the 4th of November 1816. He was the brother of David Dudley Field, Cyrus W.

Field and Henry M. Field. At the age of thirteen he accompanied his sister Emilia and her husband the Rev. Josiah Brewer (the parents of the distinguished judge of the Supreme Court, David J. Brewer) to Smyrna, Turkey, for the purpose of studying Oriental languages, but after three years he returned to the United States, and in 1837 graduated at Williams College at the head of his class. He then studied law in his elder brother's office, and in 1841 he was admitted to the New York bar. He was associated in practice there with his brother until 1848, and early in 1849 removed to California, settling soon afterward at Marysville, of which place, in 1850, he became the first alcalde or mayor. In the same year he was chosen a member of the first state legislature of California, in which he drew up and secured the enactment of two bodies of law known as the Civil and Criminal Practices Acts, based on the similar codes prepared by his brother David Dudley for New York. In the former act he embodied a provision regulating and giving authority to the peculiar customs, usages, and regulations voluntarily adopted by the miners in various districts of the state for the adjudication of disputed mining claims. This, as Judge Field truly says, "was the foundation of the jurisprudence respecting mines in the country," having greatly influenced legislation upon this subject in other states and in the Congress of the United States. He was elected, in 1857, a justice of the California Supreme Court, of which he became chief justice in 1859, on the resignation of Judge David S. Terry to fight the duel with the United States senator David C. Broderick which ended fatally for the latter. Field held this position until 1863, when he was appointed by President Lincoln a justice of the United States Supreme Court. In this capacity he was conspicuous for fearless independence of thought and action in his opinion in the test oath case, and in his dissenting opinions in the legal tender, conscription and "slaughter house" cases, which displayed unusual legal learning, and gave powerful expression to his strict constructionist theory of the implied powers of the Federal constitution. Originally a Democrat, and always a believer in states' rights, his strong Union sentiments caused him nevertheless to accept Lincoln's doctrine of coercion, and that, together with his anti-slavery sympathies, led him to act with the Republican party during the period of the Civil War. He was a member of the commission which revised the California code in 1873 and of the Electoral Commission in 1877, voting in favour of Tilden. In 1880 he received sixty-five votes on the first ballot for the presidential nomination at the Democratic National Convention at Cincinnati. In August 1889, as a result of a ruling in the course of the Sharon-Hill litigation, a notorious conspiracy case, he was assaulted in a California railway station by Judge David S. Terry, who in turn was shot and killed by a United States deputy marshal appointed to defend Justice Field against the carrying out of Terry's often-expressed threats. He retired from the Supreme Court on the 1st of December 1897 after a service of thirty-four years and six months, the longest in the court's history, and died in Washington on the 9th of April 1899.

His *Personal Reminiscences of Early Days in California*, originally privately printed in 1878, was republished in 1893 with George C. Gorham's *Story of the Attempted Assassination of Justice Field*.

FIELD, WILLIAM VENTRIS FIELD, BARON (1813-1907), English judge, second son of Thomas Flint Field, of Fielden, Bedfordshire, was born on the 21st of August 1813. He was educated at King's school, Bruton, Somersetshire, and entered the legal profession as a solicitor. In 1843, however, he ceased to practise as such, and entered at the Inner Temple, being called to the bar in 1850, after having practised for some time as a special pleader. He joined the Western circuit, but soon exchanged it for the Midland. He obtained a large business as a junior, and became a queen's counsel and bencher of his inn in 1864. As a Q.C. he had a very extensive common law practice, and had for some time been the leader of the Midland circuit, when in February 1875, on the retirement of Mr Justice Keating, he was raised to the bench as a justice of the queen's bench. Mr Justice Field was an excellent puisne judge of the type that attracts but little public attention. He was a first-rate lawyer,

had a good knowledge of commercial matters, great shrewdness and a quick intellect, while he was also painstaking and scrupulously fair. When the rules of the Supreme Court 1883 came into force in the autumn of that year, Mr Justice Field was so well recognized an authority upon all questions of practice that the lord chancellor selected him to sit continuously at Judges' Chambers, in order that a consistent practice under the new rules might as far as possible be established. This he did for nearly a year, and his name will always, to a large extent, be associated with the settling of the details of the new procedure, which finally did away with the former elaborate system of "special pleading." In 1890 he retired from the bench and was raised to the peerage as Baron Field of Bakeham, becoming at the same time a member of the privy council. In the House of Lords he at first took part, not infrequently, in the hearing of appeals, and notably delivered a carefully-reasoned judgment in the case of the *Bank of England v. Vagliano Brothers* (5th of March 1891), in which, with Lord Bramwell, he differed from the majority of his brother peers. Before long, however, deafness and advancing years rendered his attendances less frequent. Lord Field died at Bognor on the 23rd of January 1907, and as he left no issue the peerage became extinct.

FIELD (a word common to many West German languages, cf. Ger. *Feld*, Dutch *veld*, possibly cognate with O.E. *folde*, the earth, and ultimately with root of the Gr. *πλατός*, broad), open country as opposed to woodland or to the town, and particularly land for cultivation divided up into separate portions by hedges, banks, stone walls, &c.; also used in combination with words denoting the crop grown on such a portion of land, such as corn-field, turnip-field, &c. The word is similarly applied to a region with particular reference to its products, as oil-field, gold-field, &c. For the "open" or "common field" system of agriculture in village communities see **COMMONS**. Generally with a reference to their "wild" as opposed to their "domestic" nature "field" is applied to many animals, such as the "field-mouse." There are many applications of the word; thus from the use of the term for the place where a battle is fought, and widely of the whole theatre of war, come such phrases as to "take the field" for the opening of a campaign, "in the field" of troops that are engaged in the operations of a campaign. It is frequently used figuratively in this sense, of the subject matter of a controversy, and also appears in military usage, in field-fortification, field-day and the like. A "field-officer" is one who ranks above a captain and below a general (see **OFFICERS**); a field marshal is the highest rank of general officer in the British and many European armies (see **MARSHAL**). "Field" is used in many games, partly with the idea of an enclosed space, partly with the idea of the ground of military operations, for the ground in which such games as cricket, football, baseball and the like are played. Hence it is applied to those players in cricket and baseball who are not "in," and "to field" is to perform the functions of such a player—to stop or catch the ball played by the "in" side. "The field" is used in hunting, &c., for those taking part in the sport, and in racing for all the horses entered for a race, and, in such expressions as "to back the field," is confined to all the horses with the exception of the "favourite." A common application of the word is to a surface, more or less wide, as of the sky or sea, or of such physical phenomena as ice or snow, and particularly of the ground, of a special "tincture," on which armorial bearings are displayed (see **HERALDRY**); it is thus used also of the "ground" of a flag, thus the white ensign of the British navy has a red St George's cross on a white "field." In scientific usage the word is also used of the sphere of observation or of operations, and has come to be almost equivalent to a department of knowledge. In physics, a particular application is that to the area which is influenced by some agent, as in the magnetic or electric field. The field of observation or view is the area within which objects can be seen through any optical instrument at any one position. A "field-glass" is the name given to a binocular glass used in the field (see **BINOCULAR INSTRUMENT**); the older form of field-glass was a small achromatic telescope with joints. This term is also applied, in an astronomical telescope or compound microscope, to

that one of the two lenses of the "eye-piece" which is next to the object-glass; the other is called the "eye-glass."

FIELDFARE (O.E. *fealo-for* = fallow-farer), a large species of thrush, the *Turdus pilaris* of Linnaeus—well known as a regular and common autumnal visitor throughout the British Islands and a great part of Europe, besides western Asia, and even reaching northern Africa. It is the *Veldjakker* and *Veld-lyster* of the Dutch, the *Wachholderdrossel* and *Kramtsvogel* of Germans, the *Litorne* of the French, and the *Cesena* of Italians. This bird is of all thrushes the most gregarious in habit, not only migrating in large bands and keeping in flocks during the winter, but even commonly breeding in society—200 nests or more having been seen within a very small space. The birch-forests of Norway, Sweden and Russia are its chief resorts in summer, but it is known also to breed sparingly in some districts of Germany. Though its nest has been many times reported to have been found in Scotland, there is perhaps no record of such an incident that is not open to doubt; and unquestionably the missel-thrush (*T. viscivorus*) has been often mistaken for the fieldfare by indifferent observers. The head, neck, upper part of the back and the rump are grey; the wings, wing-coverts and middle of the back are rich hazel-brown; the throat is ochraceous; and the breast reddish-brown—both being streaked or spotted with black, while the belly and lower wing-coverts are white, and the legs and toes very dark-brown. The nest and eggs resemble those of the blackbird (*T. merula*), but the former is usually built high up in a tree. The fieldfare's call-note is harsh and loud, sounding like *l'chat-l'chat*: its song is low, twittering and poor. It usually arrives in Britain about the middle or end of October, but sometimes earlier, and often remains till the middle of May before departing for its northern breeding-places. In hard weather it throngs to the berry-bearing bushes which then afford it sustenance, but in open winters the flocks spread over the fields in search of animal food—worms, slugs and the larvae of insects. In very severe seasons it will altogether leave the country, and then return for a shorter or longer time as spring approaches. From *William of Palerne* (translated from the French c. 1350) to the writers of our own day the fieldfare has occasionally been noticed by British poets with varying propriety. Thus Chaucer's association of its name with frost is as happy as true, while Scott was more than unlucky in his well-known reference to its "lowly nest" in the Highlands.

Structurally very like the fieldfare, but differing greatly in many other respects, is the bird known in North America as the "robin"—its ruddy breast and familiar habits reminding the early British settlers in the New World of the household favourite of their former homes. This bird, the *Turdus migratorius* of Linnaeus, has a wide geographical range, extending from the Atlantic to the Pacific, and from Greenland to Guatemala, and, except at its extreme limits, is almost everywhere a very abundant species. As its scientific name imports, it is essentially a migrant, and gathers in flocks to pass the winter in the south, though a few remain in New England throughout the year. Yet its social instincts point rather in the direction of man than of its own kind, and it is not known to breed in companies, while it affects the homesteads, villages and even the parks and gardens of the large cities, where its fine song, its attractive plumage, and its great services as a destroyer of noxious insects, combine to make it justly popular. (A. N.)

FIELDING, ANTHONY VANDYKE COPLEY (1787–1855), commonly called Copley Fielding, English landscape painter (son of a portrait painter), became at an early age a pupil of John Varley. He took to water-colour painting, and to this he confined himself almost exclusively. In 1810 he became an associate exhibitor in the Water-colour Society, in 1813 a full member, and in 1831 president of that body. He also engaged largely in teaching the art, and made ample profits. His death took place at Worthing in March 1855. Copley Fielding was a painter of much elegance, taste and accomplishment, and has always been highly popular with purchasers, without reaching very high in originality of purpose or of style: he painted in vast number all sorts of views (occasionally in oil-colour) including marine subjects in large proportion. Specimens of his work are to be seen in the

water-colour gallery of the Victoria and Albert Museum, of dates ranging from 1829 to 1850. Among the engraved specimens of his art is the *Annual of British Landscape Scenery*, published in 1839. (W. M. R.)

FIELDING, HENRY (1707–1754), English novelist and playwright, was born at Sharpham Park, near Glastonbury, Somerset, on the 22nd of April 1707. His father was Lieutenant Edmund Fielding, third son of John Fielding, who was canon of Salisbury and fifth son of the earl of Desmond. The earl of Desmond belonged to the younger branch of the Denbigh family, who, until lately, were supposed to be connected with the Habsburgs. To this claim, now discredited by the researches of Mr J. Horace Round (*Studies in Peerage*, 1901, pp. 216–249), is to be attributed the famous passage in Gibbon's *Autobiography* which predicts for *Tom Jones*—"that exquisite picture of human manners"—a diuturnity exceeding that of the house of Austria. Henry Fielding's mother was Sarah Gould, daughter of Sir Henry Gould, a judge of the king's bench. It is probable that the marriage was not approved by her father, since, though she remained at Sharpham Park for some time after that event, his will provided that her husband should have nothing to do with a legacy of £3000 left her in 1710. About this date the Fieldings moved to East Stour in Dorset. Two girls, Catherine and Ursula, had apparently been born at Sharpham Park; and three more, together with a son, Edmund, followed at East Stour. Sarah, the third of the daughters, born November 1710, and afterwards the author of *David Simple* and other works, survived her brother.

Fielding's education up to his mother's death, which took place in April 1718 at East Stour, seems to have been entrusted to a neighbouring clergyman, Mr Oliver of Motcombe, in whom tradition traces the uncouth lineaments of "Parson Trulliber" in *Joseph Andrews*. But he must have contrived, nevertheless, to prepare his pupil for Eton, to which place Fielding went about this date, probably as an oppidan. Little is known of his school-days. There is no record of his name in the college lists; but, if we may believe his first biographer, Arthur Murphy, by no means an unimpeachable authority, he left "uncommonly versed in the Greek authors, and an early master of the Latin classics,"—a statement which should perhaps be qualified by his own words to Sir Robert Walpole in 1730:—

"Tuscan and French are in my head;
Latin I write, and Greek—I read."

But he certainly made friends among his class-fellows—some of whom continued friends for life. Winnington and Hanbury-Williams were among these. The chief, however, and the most faithful, was George, afterwards Sir George, and later Baron Lyttelton of Frankley.

When Fielding left Eton is unknown. But in November 1725 we hear of him definitely in what seems like a characteristic escapade. He was staying at Lyme (in company with a trusty retainer, ready to "beat, maim or kill" in his young master's behalf), and apparently bent on carrying off, if necessary by force, a local heiress, Miss Sarah Andrew, whose fluttered guardians promptly hurried her away, and married her to some one else (*Athenaeum*, 2nd June 1883). Her baffled admirer consoled himself by translating part of Juvenal's sixth satire into verse as "all the Revenge taken by an injured Lover." After this he must have lived the usual life of a young man about town, and probably at this date improved the acquaintance of his second cousin, Lady Mary Wortley Montagu, to whom he inscribed his first comedy, *Love in Several Masques*, produced at Drury Lane in February 1728. The moment was not particularly favourable, since it succeeded Cibber's *Provok'd Husband*, and was contemporary with Gay's popular *Beggar's Opera*. Almost immediately afterwards (March 16th) Fielding entered himself as "Stud. Lit." at Leiden University. He was still there in February 1729. But he had apparently left before the annual registration of February 1730, when his name is absent from the books (*Macmillan's Magazine*, April 1907); and in January 1730 he brought out a second comedy at the newly-opened theatre in Goodman's Fields. Like its predecessor, the *Temple*

Beau was an essay in the vein of Congreve and Wycherley, though, in a measure, an advance on *Love in Several Masques*.

With the *Temple Beau* Fielding's dramatic career definitely begins. His father had married again; and his Leiden career had been interrupted for lack of funds. Nominally, he was entitled to an allowance of £200 a year; but this (he was accustomed to say) "any body might pay that would." Young, handsome, ardent and fond of pleasure, he began that career as a hand-to-mouth playwright around which so much legend has gathered—and gathers. Having—in his own words—no choice but to be a hackney coachman or a hackney writer, he chose the pen; and his inclinations, as well as his opportunities, led him to the stage. From 1730 to 1736 he rapidly brought out a large number of pieces, most of which had merit enough to secure their being acted, but not sufficient to earn a lasting reputation for their author. His chief successes, from a critical point of view, the *Author's Farce* (1730) and *Tom Thumb* (1730, 1731), were burlesques; and he also was fortunate in two translations from Molière, the *Mock Doctor* (1732) and the *Miser* (1733). Of the rest (with one or two exceptions, to be mentioned presently) the names need only be recorded. They are *The Coffee-House Politician*, a comedy (1730); *The Letter Writers*, a farce (1731); *The Grub-Street Opera*, a burlesque (1731); *The Lottery*, a farce (1732); *The Modern Husband*, a comedy (1732); *The Covent Garden Tragedy*, a burlesque (1732); *The Old Debauchees*, a comedy (1732); *Deborah; or, a Wife for you all*, an after-piece (1733); *The Intriguing Chambermaid* (from Regnard), a two-act comedy (1734); and *Don Quixote in England*, a comedy, which had been partly sketched at Leiden.

Don Quixote was produced in 1734, and the list of plays may be here interrupted by an event of which the date has only recently been ascertained, namely, Fielding's first marriage. This took place on the 28th of November 1734 at St Mary, Charlcombe, near Bath (*Macmillan's Magazine*, April 1907), the lady being a Salisbury beauty, Miss Charlotte Cradock, of whom he had been an admirer, if not a suitor, as far back as 1730. This is a fact which should be taken into consideration in estimating the exact Bohemianism of his London life, for there is no doubt that he was devotedly attached to her. After a fresh farce entitled *An Old Man taught Wisdom*, and the comparative failure of a new comedy, *The Universal Gallant*, both produced early in 1735, he seems for a time to have retired with his bride, who came into £1500, to his old home at East Stour. Around this rural seclusion fiction has freely accreted. He is supposed to have lived for three years on the footing of a typical 18th-century country gentleman; to have kept a pack of hounds; to have put his servants into impossible yellow liveries; and generally, by profuse hospitality and reckless expenditure, to have made rapid duck and drake of Mrs Fielding's modest legacy. Something of this is demonstrably false; much, grossly exaggerated. In any case, he was in London as late as February 1735 (the date of the "Preface" to *The Universal Gallant*); and early in March 1736 he was back again managing the Haymarket theatre with a so-called "*Great Mogul's Company of English Comedians*."

Upon this new enterprise fortune, at the outset, seemed to smile. The first piece (produced on the 5th of March) was *Pasquin, a Dramatick Satire on the Times* (a piece akin in its plan to Buckingham's *Rehearsal*), which contained, in addition to much admirable burlesque, a good deal of very direct criticism of the shameless political corruption of the Walpole era. Its success was unmistakable; and when, after bringing out the remarkable *Fatal Curiosity* of George Lillo, its author followed up *Pasquin* by the *Historical Register for the Year 1736*, of which the effrontery was even more daring than that of its predecessor, the ministry began to bethink themselves that matters were going too far. How they actually effected their object is obscure: but grounds were speedily concocted for the Licensing Act of 1737, which restricted the number of theatres, rendered the lord chamberlain's licence an indispensable preliminary to stage representation, and—in a word—effectually put an end to Fielding's career as a dramatist.

Whether, had that career been prolonged to its maturity, the result would have enriched the theatrical repertoire with a new species of burlesque, or reinforced it with fresh variations on the "wit-traps" of Wycherley and Congreve, is one of those inquiries that are more academic than profitable. What may be affirmed is, that Fielding's plays, as we have them, exhibit abundant invention and ingenuity; that they are full of humour and high spirits; that, though they may have been hastily written, they were by no means thoughtlessly constructed; and that, in composing them, their author attentively considered either managerial hints, or the conditions of the market. Against this, one must set the fact that they are often immodest; and that, whatever their intrinsic merit, they have failed to rival in permanent popularity the work of inferior men. Fielding's own conclusion was, "that he left off writing for the stage, when he ought to have begun"—which can only mean that he himself regarded his plays as the outcome of imitation rather than experience. They probably taught him how to construct *Tom Jones*; but whether he could ever have written a comedy at the level of that novel, can only be established by a comparison which it is impossible to make, namely, a comparison with *Tom Jones* of a comedy written at the same age, and in similar circumstances.

Tumble-Down Dick; or, Phaeton in the Suds, Eurydice and Eurydice hissed are the names of three occasional pieces which belong to the last months of Fielding's career as a Haymarket manager. By this date he was thirty, with a wife and daughter. As a means of support, he reverted to the profession of his maternal grandfather; and, in November 1737, he entered the Middle Temple, being described in the books of the society as "of East Stour in Dorset." That he set himself strenuously to master his new profession, is admitted; though it is unlikely that he had entirely discarded the irregular habits which had grown upon him in his irresponsible bachelorhood. He also did a good deal of literary work, the best known of which is contained in the *Champion*, a "News-Journal" of the *Spectator* type undertaken with James Ralph, whose poem of "Night" is made notorious in the *Dunciad*. That the *Champion* was not without merit is undoubted; but the essay-type was for the moment out-worn, and neither Fielding nor his coadjutor could lend it fresh vitality. Fielding contributed papers from the 15th of November 1739 to the 19th of June 1740. On the 20th of June he was called to the bar, and occupied chambers in Pump Court. It is further related that, in the diligent pursuit of his calling, he travelled the Western Circuit, and attended the Wiltshire sessions.

Although, with the *Champion*, he professed, for the time, to have relinquished periodical literature, he still wrote at intervals, a fact which, taken in connexion with his past reputation as an effective satirist, probably led to his being "unjustly censured" for much that he never produced. But he certainly wrote a poem "Of True Greatness" (1741); a first book of a burlesque epic, the *Vernoniad*, prompted by Vernon's expedition of 1739; a vision called the *Opposition*, and, perhaps, a political sermon entitled the *Crisis* (1741). Another piece, now known to have been attributed to him by his contemporaries (*Hist. MSS. Comm., Rept. 12, App. Pt. ix., p. 204*), is the pamphlet entitled *An Apology for the Life of Mrs Shamela Andrews*, a clever but coarse attack upon the prurient side of Richardson's *Pamela*, which had been issued in 1740, and was at the height of its popularity. *Shamela* followed early in 1741. Richardson, who was well acquainted with Fielding's four sisters, at that date his neighbours at Hammersmith, confidently attributed it to Fielding (*Corr.* 1804, iv. 286, and unpublished letter at South Kensington); and there are suggestive points of internal evidence (such as the transformation of *Pamela's* "Mr B." into "Mr Booby") which tend to connect it with the future *Joseph Andrews*. Fielding, however, never acknowledged it, or referred to it; and a great deal has been laid to his charge that he never deserved ("Preface" to *Miscellanies*, 1743).

But whatever may be decided in regard to the authorship of *Shamela*, it is quite possible that it prompted the more memorable

Joseph Andrews, which made its appearance in February 1742, and concerning which there is no question. Professing, on his title-page, to imitate Cervantes, Fielding set out to cover *Pamela* with Homeric ridicule by transferring the heroine's embarrassments to a hero, supposed to be her brother. Allied to this purpose was a collateral attack upon the slipshod *Apology* of the playwright Colley Cibber, with whom, for obscure reasons, Fielding had long been at war. But the avowed object of the book fell speedily into the background as its author warmed to his theme. His secondary speedily became his primary characters, and Lady Booby and Joseph Andrews do not interest us now as much as Mrs Slipslop and Parson Adams—the latter an invention that ranges in literature with Sterne's "Uncle Toby" and Goldsmith's "Vicar." Yet more than these and others equally admirable in their round veracity, is the writer's penetrating outlook upon the frailties and failures of human nature. By the time he had reached his second volume, he had convinced himself that he had inaugurated a new fashion of fiction; and in a "Preface" of exceptional ability, he announced his discovery. Postulating that the epic might be "comic" or "tragic," prose or verse, he claimed to have achieved what he termed the "Comic Epos in Prose," of which the action was "ludicrous" rather than "sublime," and the personages selected from society at large, rather than the restricted ranks of conventional high life. His plan, it will be observed, was happily adapted to his gifts of humour, satire, and above all, irony. That it was matured when it began may perhaps be doubted, but it was certainly matured when it ended. Indeed, except for the plot, which, in his picaresque first idea, had not preceded the conception, *Joseph Andrews* has all the characteristics of *Tom Jones*, even (in part) to the initial chapters.

Joseph Andrews had considerable success, and the exact sum paid for it by Andrew Millar, the publisher, according to the assignment now at South Kensington, was £183:11s., one of the witnesses being the author's friend, William Young, popularly supposed to be the original of Parson Adams. It was with Young that Fielding undertook what, with exception of "a very small share" in the farce of *Miss Lucy in Town* (1742), constituted his next work, a translation of the *Plutus* of Aristophanes, which never seems to have justified any similar experiments. Another of his minor works was a *Vindication of the Dowager Duchess of Marlborough* (1742), then much before the public by reason of the *Account of her Life* which she had recently put forth. Later in the same year, Garrick applied to Fielding for a play; and a very early effort, *The Wedding Day*, was hastily patched together, and produced at Drury Lane in February 1743 with no great success. It was, however, included in Fielding's next important publication, the three volumes of *Miscellanies* issued by subscription in the succeeding April. These also comprised some early poems, some essays, a Lucianic fragment entitled a *Journey from this World to the Next*, and, last but not least, occupying the entire final volume, the remarkable performance entitled the *History of the Life of the late Mr Jonathan Wild the Great*.

It is probable that, in its composition, *Jonathan Wild* preceded *Joseph Andrews*. At all events it seems unlikely that Fielding would have followed up a success in a new line by an effort so entirely different in character. Taking for his ostensible hero a well-known thief-taker, who had been hanged in 1725, he proceeds to illustrate, by a mock-heroic account of his progress to Tyburn, the general proposition that greatness without goodness is no better than badness. He will not go so far as to say that all "Human Nature is Newgate with the Mask on"; but he evidently regards the description as fairly applicable to a good many so-called great people. Irony (and especially Irony neat) is not a popular form of rhetoric; and the remorseless pertinacity with which Fielding pursues his demonstration is to many readers discomfiting and even distasteful. Yet—in spite of Scott—*Jonathan Wild* has its softer pages; and as a purely intellectual conception it is not surpassed by any of the author's works.

His actual biography, both before and after *Jonathan Wild*,

is obscure. There are evidences that he laboured diligently at his profession; there are also evidences of sickness and embarrassment. He had become early a martyr to the malady of his century—gout, and the uncertainties of a precarious livelihood told grievously upon his beautiful wife, who eventually died of fever in his arms, leaving him for the time so stunned and bewildered by grief that his friends feared for his reason. For some years his published productions were unimportant. He wrote "Prefaces" to the *David Simple* of his sister Sarah in 1744 and 1747; and, in 1745–1746 and 1747–1748, produced two newspapers in the ministerial interest, the *True Patriot* and the *Jacobite's Journal*, both of which are connected with, or derive from, the rebellion of 1745, and were doubtless, when they ceased, the pretext of a pension from the public service money (*Journal of a Voyage to Lisbon*, "Introduction"). In November 1747 he married his wife's maid, Mary Daniel, at St Bene't's, Paul's Wharf; and in December 1748, by the interest of his old school-fellow, Lyttelton, he was made a principal justice of peace for Middlesex and Westminster, an office which put him in possession of a house in Bow Street, and £300 per annum "of the dirtiest money upon earth" (*ibid.*), which might have been more had he condescended to become what was known as a "trading" magistrate.

For some time previously, while at Bath, Salisbury, Twickenham and other temporary resting-places, he had intermittently occupied himself in composing his second great novel, *Tom Jones; or, the History of a Foundling*. For this, in June 1748, Millar had paid him £600, to which he added £100 more in 1749. In the February of the latter year it was published with a dedication to Lyttelton, to whose pecuniary assistance to the author during the composition it plainly bears witness. In *Tom Jones* Fielding systematically developed the "new Province of Writing" he had discovered incidentally in *Joseph Andrews*. He paid closer attention to the construction and evolution of the plot; he elaborated the initial essays to each book which he had partly employed before, and he compressed into his work the flower and fruit of his forty years' experience of life. He has, indeed, no character quite up to the level of Parson Adams, but his Westerns and Partridges, his Allworthys and Blifils, have the inestimable gift of life. He makes no pretence to produce "models of perfection," but pictures of ordinary humanity, rather perhaps in the rough than the polished, the natural than the artificial, and his desire is to do this with absolute truthfulness, neither extenuating nor disguising defects and shortcomings. One of the results of this unvarnished naturalism has been to attract more attention to certain of the episodes than their inventor ever intended. But that, in the manners of his time, he had chapter and verse for everything he drew is clear. His sincere purpose was, he declared, "to recommend goodness and innocence," and his obvious aversions are vanity and hypocrisy. The methods of fiction have grown more sophisticated since his day, and other forms of literary egotism have taken the place of his once famous introductory essays, but the traces of *Tom Jones* are still discernible in most of our manlier modern fiction.

Meanwhile, its author was showing considerable activity in his magisterial duties. In May 1749, he was chosen chairman of quarter sessions for Westminster; and in June he delivered himself of a weighty charge to the grand jury. Besides other pamphlets, he produced a careful and still readable *Enquiry into the Causes of the late Increase of Robbers, &c.* (1751), which, among its other merits, was not ineffectual in helping on the famous Gin Act of that year, a practical result to which the "Gin Lane" and "Beer Street" of his friend Hogarth also materially contributed. These duties and preoccupations left their mark on his next fiction, *Amelia* (1752), which is rather more taken up with social problems and popular grievances than its forerunners. But the leading personage, in whom, as in the Sophia Western of *Tom Jones*, he reproduced the traits of his first wife, is certainly, as even Johnson admitted, "the most pleasing heroine of all the romances." The minor characters, too, especially Dr Harrison and Colonel Bath, are equal to any in *Tom Jones*. The book nevertheless shows signs, not of failure but of fatigue, perhaps

of haste—a circumstance heightened by the absence of those “prolegomenous” chapters over which the author had lingered so lovingly in *Tom Jones*. In 1749 he had been dangerously ill, and his health was visibly breaking. The £1000 which Millar is said to have given for *Amelia* must have been painfully earned.

Early in 1752 his still indomitable energy prompted him to start a third newspaper, the *Covent Garden Journal*, which ran from the 4th of January to the 25th of November. It is an interesting contemporary record, and throws a good deal of light on his Bow Street duties. But it has no great literary value, and it unhappily involved him in harassing and undignified hostilities with Smollett, Dr John Hill, Bonnell Thornton and other of his contemporaries. To the following year belong pamphlets on “Provision for the Poor,” and the case of the strange impostor, Elizabeth Canning (1734–1773).¹ By 1754 his own case, as regards health, had grown desperate; and he made matters worse by a gallant and successful attempt to break up a “gang of villains and cut-throats,” who had become the terror of the metropolis. This accomplished, he resigned his office to his half-brother John (afterwards Sir John) Fielding. But it was now too late. After fruitless essay both of Dr Ward’s specifics and the tar-water of Bishop Berkeley, it was felt that his sole chance of prolonging life lay in removal to a warmer climate. On the 26th of June 1754 he accordingly left his little country house at Fordhook, Ealing, for Lisbon, in the “Queen of Portugal,” Richard Veal master. The ship, as often, was tediously wind-bound, and the protracted discomfords of the sick man and his family are narrated at length in the touching posthumous tract entitled the *Journal of a Voyage to Lisbon*, which, with a fragment of a comment on Bolingbroke’s then recently issued essays, was published in February 1755 “for the Benefit of his [Fielding’s] Wife and Children.” Reaching Lisbon at last in August 1754, he died there two months later (8th October), and was buried in the English cemetery, where a monument was erected to him in 1830. *Lugel Britannia gremio non dari fovere natum* is inscribed upon it.

His estate, including the proceeds of a fair library, only covered his just debts (*Athenaeum*, 25th Nov. 1905); but his family, a daughter by his first, and two boys and a girl by his second wife, were faithfully cared for by his brother John, and by his friend Ralph Allen of Prior Park, Bath, the Squire Allworthy of *Tom Jones*. His will (undated) was printed in the *Athenaeum* for the 1st of February 1890. There is but one absolutely authentic portrait of him, a familiar outline by Hogarth, executed from memory for Andrew Millar’s edition of his works in 1762. It is the likeness of a man broken by ill-health, and affords but faint indication of the handsome Harry Fielding who in his salad days “warmed both hands before the fire of life.” Far too much stress, it is now held, has been laid by his first biographers upon the unworshipful side of his early career. That he was always profuse, sanguine and more or less improvident, is as probable as that he was always manly, generous and sympathetic. But it is also plain that, in his later years, he did much, as father, friend and magistrate, to redeem the errors, real and imputed, of a too-youthful youth.

As a playwright and essayist his rank is not elevated. But as a novelist his place is a definite one. If the *Spectator* is to be credited with foreshadowing the characters of the novel, Defoe with its earliest form, and Richardson with its first experiments in sentimental analysis, it is to Henry Fielding that we owe its first accurate delineation of contemporary manners. Neglecting, or practically neglecting, sentiment as unmanly, and relying chiefly on humour and ridicule, he set out to draw life precisely as he saw it around him, without blanks or dashes. He was, it may be, for a judicial moralist, too indulgent to some of its frailties, but he was merciless to its meaner vices. For reasons which have been already given, his high-water mark is *Tom Jones*, which has remained, and remains, a model in its way of the kind he inaugurated.

¹ For a full account of this celebrated case see Howell, *State Trials* (1813), vol. xix.

An essay on Fielding’s life and writings is prefixed to Arthur Murphy’s edition of his works (1762), and short biographies have been written by Walter Scott and William Roscoe. There are also lives by Watson (1807), Lawrence (1855), Austin Dobson (“Men of Letters,” 1883, 1907) and G. M. Godden (1909). An annotated edition of the *Journal of a Voyage to Lisbon* is included in the “World’s Classics” (1907). (A. D.)

FIELDING, WILLIAM STEVENS (1848–), Canadian journalist and statesman, was born in Halifax, Nova Scotia, on the 24th of November 1848. From 1864 to 1884 he was one of the staff of the *Morning Chronicle*, the chief Liberal paper of the province, and worked at all departments of newspaper life. In 1882 he entered the local legislature as Liberal member for Halifax, and from 1884 to 1896 was premier and provincial secretary of the province, but in the latter year became finance minister in the Dominion administration of Sir Wilfrid Laurier, and was elected to the House of Commons for Shelburne and Queen’s county. He opposed Confederation in 1864–1867, and as late as 1886 won a provincial election on the promise to advocate the repeal of the British North America Act. His administration as finance minister of Canada was important, since in 1897 he introduced a new tariff, granting to the manufactures of Great Britain a preference, subsequently increased; and later he imposed a special surtax on German imports owing to unfriendly tariff legislation by that country. In 1902 he represented Canada at the Colonial Conference in London.

FIELD-MOUSE, the popular designation of such mouse-like British rodents as are not true or “house” mice. The term thus includes the long-tailed field mouse, *Mus (Micromys) sylvaticus*, easily recognized by its white belly, and sometimes called the wood-mouse; and the two species of short-tailed field-mice, *Microtus agrestis* and *Evotomys glareolus*, together with their representatives in Skomer island and the Orkneys (see **MOUSE** and **VOLE**).

FIELD OF THE CLOTH OF GOLD, the French *Camp du drap d’or*, the name given to the place between Guines and Ardres where Henry VIII. of England met Francis I. of France in June 1520. The most elaborate arrangements were made for the accommodation of the two monarchs and their large retinues; and on Henry’s part especially no efforts were spared to make a great impression in Europe by this meeting. Before the castle of Guines a temporary palace, covering an area of nearly 12,000 sq. yds., was erected for the reception of the English king. It was decorated in the most sumptuous fashion, and like the chapel, served by thirty-five priests, was furnished with a profusion of golden ornaments. Some idea of the size of Henry’s following may be gathered from the fact that in one month 2200 sheep and other viands in a similar proportion were consumed. In the fields beyond the castle, tents to the number of 2800 were erected for less distinguished visitors, and the whole scene was one of the greatest animation. Ladies gorgeously clad, and knights, showing by their dress and bearing their anxiety to revive the glories and the follies of the age of chivalry, jostled mountebanks, mendicants and vendors of all kinds.

Journeying from Calais Henry reached his headquarters at Guines on the 4th of June 1520, and Francis took up his residence at Ardres. After Cardinal Wolsey, with a splendid train had visited the French king, the two monarchs met at the Val Doré, a spot midway between the two places, on the 7th. The following days were taken up with tournaments, in which both kings took part, banquets and other entertainments, and after Wolsey had said mass the two sovereigns separated on the 24th. This meeting made a great impression on contemporaries, but its political results were very small.

The *Ordonnance* for the *Field* is printed by J. S. Brewer in the *Calendar of State Papers, Henry VIII.* vol. iii. (1867). See also J. S. Brewer, *Reign of Henry VIII.* (1884).

FIELDS, JAMES THOMAS (1817–1881), American publisher and author, was born in Portsmouth, New Hampshire, on the 31st of December 1817. At the age of seventeen he went to Boston as clerk in a bookseller’s shop. Afterwards he wrote for the newspapers, and in 1835 he read an anniversary poem entitled “Commerce” before the Boston Mercantile Library

Association. In 1839 he became junior partner in the publishing and bookselling firm known after 1846 as Ticknor & Fields, and after 1868 as Fields, Osgood & Company. He was the publisher of the foremost contemporary American writers, with whom he was on terms of close personal friendship, and he was the American publisher of some of the best-known British writers of his time, some of whom, also, he knew intimately. The first collected edition of De Quincey's works (20 vols., 1850-1855) was published by his firm. As a publisher he was characterized by a somewhat rare combination of keen business acumen and sound, discriminating literary taste, and as a man he was known for his geniality and charm of manner. In 1862-1870, as the successor of James Russell Lowell, he edited the *Atlantic Monthly*. In 1871 Fields retired from business and from his editorial duties, and devoted himself to lecturing and to writing. Of his books the chief were the collection of sketches and essays entitled *Underbrush* (1877) and the chapters of reminiscence composing *Yesterdays with Authors* (1871), in which he recorded his personal friendship with Wordsworth, Thackeray, Dickens, Hawthorne and others. He died in Boston on the 24th of April 1881.

His second wife, ANNIE ADAMS FIELDS (b. 1834), whom he married in 1854, published *Under the Olive* (1880), a book of verses; *James T. Fields: Biographical Notes and Personal Sketches* (1882); *Authors and Friends* (1896); *The Life and Letters of Harriet Beecher Stowe* (1897); and *Orpheus* (1900).

FIENNES, NATHANIEL (c. 1608-1669) English politician, second son of William, 1st Viscount Saye and Sele, by Elizabeth, daughter of John Temple, of Stow in Buckinghamshire, was born in 1607 or 1608, and educated at Winchester and at New College, Oxford, where as founder's kin he was admitted a perpetual fellow in 1624. After about five years' residence he left without taking a degree, travelled abroad, and in Switzerland imbibed or strengthened those religious principles and that hostility to the Laudian church which were to be the chief motive in his future political career. He returned to Scotland in 1639, and established communications with the Covenanters and the Opposition in England, and as member for Banbury in both the Short and Long Parliaments he took a prominent part in the attacks upon the church. He spoke against the illegal canons on the 14th of December 1640, and again on the 9th of February 1641 on the occasion of the reception of the London petition, when he argued against episcopacy as constituting a political as well as a religious danger and made a great impression on the House, his name being added immediately to the committee appointed to deal with church affairs. He took a leading part in the examination into the army plot; was one of the commissioners appointed to attend the king to Scotland in August 1641; and was nominated one of the committee of safety in July 1642. On the outbreak of hostilities he took arms immediately, commanded a troop of horse in the army of Lord Essex, was present at the relief of Coventry in August, and at the fight at Worcester in September, where he distinguished himself, and subsequently at Edgehill. Of the last two engagements he wrote accounts, viz. *True and Exact Relation of both the Battles fought by . . . Earl of Essex . . . against the Bloody Cavaliers* (1642). (See also *A Narrative of the Late Battle before Worcester taken by a Gentleman of the Inns of Court from the mouth of Master Fiennes*, 1642). In February 1643 Fiennes was sent down to Bristol, arrested Colonel Essex the governor, executed the two leaders of a plot to deliver up the city, and received a commission himself as governor on the 1st of May 1643. On the arrival, however, of Prince Rupert on the 22nd of July the place was in no condition to resist an attack, and Fiennes capitulated. He addressed to Essex a letter in his defence (Thomason Tracts E. 65, 26), drew up for the parliament a *Relation concerning the Surrender* . . . (1643), answered by Prynne and Clement Walker accusing him of treachery and cowardice, to which he opposed *Col. Fiennes his Reply* . . . He was tried at St Albans by the council of war in December, was pronounced guilty of having surrendered the place improperly, and sentenced to death. He was, however, pardoned, and the facility with which Bristol subsequently capitulated to the parliamentary army induced Cromwell and the generals to

exonerate him completely. His military career nevertheless now came to an end. He went abroad, and it was some time before he reappeared on the political scene. In September 1647 he was included in the army committee, and on the 3rd of January 1648 he became a member of the committee of safety. He was, however, in favour of accepting the king's terms at Newport in December, and in consequence was excluded from the House by Pride's Purge. An opponent of church government in any form, he was no friend to the rigid and tyrannical Presbyterianism of the day, and inclined to Independency and Cromwell's party. He was a member of the council of state in 1654, and in June 1655 he received the strange appointment of commissioner for the custody of the great seal, for which he was certainly in no way fitted. In the parliament of 1654 he was returned for Oxford county and in that of 1656 for the university, while in January 1658 he was included in Cromwell's House of Lords. He was in favour of the Protector's assumption of the royal title and urged his acceptance of it on several occasions. His public career closes with addresses delivered in his capacity as chief commissioner of the great seal at the beginning of the sessions of January 20, 1658, and January 2, 1659, in which the religious basis of Cromwell's government is especially insisted upon, the feature to which Fiennes throughout his career had attached most value. On the reassembling of the Long Parliament he was superseded; he took no part in the Restoration, and died at Newton Tony in Wiltshire on the 16th of December 1669. Fiennes married (1), Elizabeth, daughter of the famous parliamentarian Sir John Eliot, by whom he had one son, afterwards 3rd Viscount Saye and Sele; and (2), Frances, daughter of Richard Whitehead of Tuderley, Hants, by whom he had three daughters.

Besides the pamphlets already cited, a number of his speeches and other political tracts were published (see Gen. Catalogue, British Museum). Wood also attributed to him *Monarchy Asserted* (1660) (reprinted in Somers Tracts, vi. 346 [ed. Scott]), but there seems no reason to ascribe to him with Clement Walker the authorship of Sprigge's *Anglia Rediviva*.

FIERI FACIAS, usually abbreviated *fi. fa.* (Lat. "that you cause to be made"), in English law, a writ of execution after judgment obtained in action of debt or damages. It is addressed to the sheriff, and commands him to make good the amount out of the goods of the person against whom judgment has been obtained. (See EXECUTION.)

FIESCHI, GIUSEPPE MARCO (1790-1836), the chief conspirator in the attempt on the life of Louis Philippe in July 1835, was a native of Murato in Corsica. He served under Murat, then returned to Corsica, where he was condemned to ten years' imprisonment and perpetual surveillance by the police for theft and forgery. After a period of vagabondage he eluded the police and obtained a small post in Paris by means of forged papers; but losing it on account of his suspicious manner of living, he resolved to revenge himself on society. He took lodgings on the Boulevard du Temple, and there, with two members of the Société des Droits de l'Homme, Morey and Pépin by name, contrived an "infernal machine," constructed with twenty gun barrels, to be fired simultaneously. On the 28th of July 1835, as Louis Philippe was passing along the boulevard to the Bastille, accompanied by his three sons and a numerous staff, the machine was exploded. A ball grazed the king's forehead, and his horse, with those of the duke of Nemours and of the prince de Joinville, was shot; Marshal Mortier was killed, with seventeen other persons, and many were wounded; but the king and the princes escaped as if by miracle. Fieschi himself was severely wounded by the discharge of his machine, and vainly attempted to escape. The attentions of the most skilful physicians were lavished upon him, and his life was saved for the stroke of justice. On his trial he named his accomplices, displayed much bravado, and expected or pretended to expect ultimate pardon. He was condemned to death, and was guillotined on the 19th of February 1836. Morey and Pépin were also executed, another accomplice was sentenced to twenty years' imprisonment and one was acquitted. No less than seven plots against the life of Louis Philippe had been discovered

by the police within the year, and apologists were not wanting in the revolutionary press for the crime of Fieschi.

See *Procès de Fieschi, précédé de sa vie privée, sa condamnation par la Cour des Pairs et celles de ses complices* (2 vols., 1836); also P. Thureau-Dangin, *Hist. de la monarchie de Juillet* (vol. iv. ch. xii., 1884).

FIESCO (DE' FIESCHI), **GIOVANNI LUIGI** (c. 1523-1547), count of Lavagna, was descended from one of the greatest families of Liguria, first mentioned in the 10th century. Among his ancestors were two popes (Innocent IV. and Adrian V.), many cardinals, a king of Sicily, three saints, and many generals and admirals of Genoa and other states. Sinibaldo Fiesco, his father, had been a close friend of Andrea Doria (*q.v.*), and had rendered many important services to the Genoese republic. On his death in 1532 Giovanni found himself at the age of nine the head of the family and possessor of immense estates. He grew up to be a handsome, intelligent youth, of attractive manners and very ambitious. He married Eleonora Cibò, marchioness of Massa, in 1540, a woman of great beauty and family influence. There were many reasons which inspired his hatred of the Doria family; the almost absolute power wielded by the aged admiral and the insolence of his nephew and heir Giannettino Doria, the commander of the galleys, were galling to him as to many other Genoese, and it is said that Giannettino was the lover of Fiesco's wife. Moreover, the Fiesco belonged to the French or popular party, while the Doria were aristocrats and Imperialists. When Fiesco determined to conspire against Doria he found friends in many quarters. Pope Paul III. was the first to encourage him, while both Pier Luigi Farnese, duke of Parma, and Francis I. of France gave him much assistance and promised him many advantages. Among his associates in Genoa were his brothers Girolamo and Ottobuono, Verrina and R. Sacco. A number of armed men from the Fiesco fiefs were secretly brought to Genoa, and it was agreed that on the 2nd of January 1547, during the interregnum before the election of the new doge, the galleys in the port should be seized and the city gates held. The first part of the programme was easily carried out, and Giannettino Doria, aroused by the tumult, rushed down to the port and was killed, but Andrea escaped from the city in time. The conspirators attempted to gain possession of the government, but unfortunately for them Giovanni Luigi, while crossing a plank from the quay to one of the galleys, fell into the water and was drowned. The news spread consternation among the Fiesco faction, and Girolamo Fiesco found few adherents. They came to terms with the senate and were granted a general amnesty. Doria returned to Genoa on the 4th thirsting for revenge, and in spite of the amnesty he confiscated the Fiesco estates; Girolamo had shut himself up, with Verrina and Sacco and other conspirators, in his castle of Montobbia, which the Genoese at Doria's instigation besieged and captured. Girolamo Fiesco and Verrina were tried, tortured and executed; all their estates were seized, some of which, including Torriglia, Doria obtained for himself. Ottobuono Fiesco, who had escaped, was captured eight years afterwards and put to death by Doria's orders.

There are many accounts of the conspiracy, of which perhaps the best is contained in E. Petit's *André Doria* (Paris, 1887), chs. xi. and xii., where all the chief authorities are quoted; see also Calligari, *La Congiura del Fiesco* (Venice, 1892), and Gavazzo, *Nuovi documenti sulla congiura del conte Fiesco* (Genoa, 1886); E. Bernabò-Brea, in his *Sulla congiura di Giovanni Luigi Fieschi*, publishes many important documents, while L. Capelloni's *Congiura del Fiesco*, edited by Olivieri, and A. Mascardi's *Congiura del conte Giovanni Luigi de' Fieschi* (Antwerp, 1629) may be commended among the earlier works. The Fiesco conspiracy has been the subject of many poems and dramas, of which the most famous is that by Schiller. See also under **DORIA**, **ANDREA**; **FARNESE**. (L. V.)*

FISSOLE (anc. *Faesuslae*, *q.v.*), a town and episcopal see of Tuscany, Italy, in the province of Florence, from which it is 3 m. N.E. by electric tramway. Pop. (1901) town 4951, commune 16,816. It is situated on a hill 970 ft. above sea-level, and commands a fine view. The cathedral of S. Romolo is an early and simple example of the Tuscan Romanesque style; it is a small basilica, begun in 1028 and restored in 1256. The picturesque battlemented campanile belongs to 1213. The

tomb of the bishop Leonardo Salutati (d. 1466), with a beautiful portrait bust by the sculptor Mino da Fiesole (1431-1484), is fine. The 13th-century Palazzo Pretorio contains a small museum of antiquities. The Franciscan monastery commands a fine view. The church of S. Maria Primerana has some works of art, and S. Alessandro, which is attributed to the 6th century, contains fifteen ancient columns of cipollino. The inhabitants of Fiesole are largely engaged in straw-plaiting.

Below Fiesole, between it and Florence, lies San Domenico di Fiesole (485 ft.); in the Dominican monastery the painter, Fra Giovanni Angelico da Fiesole (1387-1455), lived until he went to S. Marco at Florence. Here, too, is the Badia di Fiesole, founded in 1028 and re-erected about 1456-1466 by a follower of Brunelleschi. It is an irregular pile of buildings, in fine and simple early Renaissance style; a small part of the original façade of 1028 in black and white marble is preserved. The interior of the Church is decorated with sculptures by pupils of Desiderio da Settignano. The slopes of the hill on which Fiesole stands are covered with fine villas. To the S.E. of Fiesole lies Monte Ceceri (1453 ft.), with quarries of grey *pietra serena*, largely used in Florence for building. To the E. of this lies the 14th-century castle of Vincigliata restored and fitted up in the medieval style.

FIFE, an eastern county of Scotland, bounded N. by the Firth of Tay, E. by the North Sea, S. by the Firth of Forth, and W. by the shires of Perth, Kinross and Clackmannan. The Isle of May, Inchkeith, Inchcolm, Inchgarvie and the islet of Oxcar belong to the shire. It has an area of 322,844, acres or 504 sq. m. Its coast-line measure 108 m. The Lomond Hills to the S. and S.W. of Falkland, of which West Lomond is 1713 ft. high and East Lomond 1471 ft., Saline Hill (1178 ft.) to the N.W. of Dunfermline, and Benarty (1131 ft.) on the confines of Kinross are the chief heights. Of the rivers the Eden is the longest; formed on the borders of Kinross-shire by the confluence of Beattie Burn and Carmere Burn, it pursues a wandering course for 25 m. N.E., partly through the Howe, or Hollow of Fife, and empties into the North Sea. There is good trout fishing in its upper waters, but weirs prevent salmon from ascending it. The Leven drains the loch of that name and enters the Forth at the town of Leven after flowing eastward for 15 m. There are numerous factories at various points on its banks. The Ore, rising not far from Roscobie Hills to the north of Dunfermline, follows a mainly north-easterly course for 15 m. till it joins the Leven at Windygates. The old loch of Ore which was an expansion of its water was long ago reclaimed. Motray Water finds its source in the parish of Kilmany, a few miles W. by N. of Cupar, makes a bold sweep towards the north-east, and then, taking a southerly turn, enters the head-waters of St Andrews Bay, after a course of 12 m. The principal lochs are Loch Fitty, Loch Gelly, Loch Glow and Loch Lindores; they are small but afford some sport for trout, perch and pike. "Fresh-water mussels" occur in Loch Fitty. There are no glens, and the only large valley is the fertile Stratheden, which supplies part of the title of the combined baronies of Stratheden (created 1836) and Campbell (created 1841).

Geology.—Between Damhead and Tayport on the northern side of the low-lying Howe of Fife the higher ground is formed of Lower Old Red Sandstone volcanic rocks, consisting of red and purple porphyrites and andesites and some coarse agglomerates, which, in the neighbourhood of Auchtermuchty, are rounded and conglomeratic. These rocks have a gentle dip towards the S.S.E. They are overlaid unconformably by the soft red sandstones of the Upper Old Red series which underlie the Howe of Fife from Loch Leven to the coast. The quarries in these rocks in Dura Den are famous for fossil fishes. Following the Old Red rocks conformably are the Carboniferous formations which occupy the remainder of the county, and are well exposed on the coast and in the numerous quarries. The Carboniferous rocks include, at the base, the Calciferous Sandstone series of dark shales with thin limestones, sandstones and coals. They are best developed around Fife Ness, between St Andrews and Elie, and again around Burntisland between Kirkcaldy and Inverkeithing Bay. In the Carboniferous Limestone series, which comes next in upward succession, are the valuable gas-coals and ironstones worked in the coal-fields of Dunfermline, Saline, Oakley, Torryburn, Kirkcaldy and Markinch. The true Coal Measures lie in the district around Dysart and Leven, East Wemyss and Kinglassie, and they

are separated from the coal-bearing Carboniferous Limestone series by the sandstones and conglomerates of the Millstone Grit. Fourteen seams of coal are found in the Dysart Coal Measures, associated with sandstones, shales and clay ironstones. Fife is remarkably rich in evidences of former volcanic activity. Besides the Old Red Sandstone volcanic rocks previously mentioned, there are many beds of contemporaneous basaltic lavas and tuffs in the Carboniferous rocks; Saline Hill and Knock Hill were the sites of vents, which at that time threw out ashes; these interbedded rocks are well exposed on the shore between Burntisland and Seafield Tower. There were also many intrusive sheets of dolerite and basalt forced into the lower Carboniferous rocks, and these now play an important part in the scenery of the county. They form the summits of the Lomond Hills and Benarty, and they may be followed from Cult Hill by the Cleish Hills to Blairadam; and again near Dunfermline, Burntisland, Torryburn, Auchtertool and St Andrews. Later, in Permian times, eastern Fife was the seat of further volcanic action, and great numbers of "necks" or vents pierce the Carboniferous rocks; Largo Law is a striking example. In one of these necks on the shore at Kincaig Point is a fine example of columnar basalt; the "Rock and Spindle" near St Andrews is another. Last of all in Tertiary times, east and west rifts in the Old Red Sandstone were filled by basalt dikes. Glacial deposits, ridges of gravel and sand, boulder clay, &c., brought from the N. W., cover much of the older rocks, and traces of old raised beaches are found round the coast and in the Howe of Fife. In the 25-ft. beach in the East Neuk of Fife is an island sea-cliff with small caves.

Climate and Agriculture.—Since the higher hills all lie in the west, most of the county is exposed to the full force of the east winds from the North Sea, which often, save in the more sheltered areas, check the progress of vegetation. At an elevation of 500 or 600 ft. above the sea harvests are three or four weeks later than in the valleys and low-lying coast-land. The climate, on the whole, is mild, proximity to the sea qualifying the heat in summer and the cold in winter. The average annual rainfall is 31 in., rather less in the East Neuk district and around St Andrews, somewhat more as the hills are approached, late summer and autumn being the wet season. The average temperature for January is 38° F., for July 59° 5°, and for the year 47° 6°. Four-fifths of the total area is under cultivation, and though the acreage under grain is smaller than it was, the yield of each crop is still extraordinarily good, oats, barley, wheat being the order of acreage. Of the green crops most attention is given to turnips. Potatoes also do well. The acreage under permanent pasture and wood is very considerable. Cattle are mainly kept for feeding purposes, and dairy farming, though attracting more notice, has never been followed more than to supply local markets. Sheep-farming, however, is on the increase, and the raising of horses, especially farm horses, is an important pursuit. They are strong, active and hardy, with a large admixture, or purely, of Clydesdale blood. The ponies, hunters and carriage horses so bred are highly esteemed. The strain of pigs has been improved by the introduction of Berkshires. North of the Eden the soil, though generally thin, is fertile, but the sandy waste of Tents Moor is beyond redemption. From St Andrews southwards all along the coast the land is very productive. That adjacent to the East Neuk consists chiefly of clay and rich loam. From Leven to Inverkeithing it varies from a light sand to a rich clayey loam. Excepting Stratheden and Strathleven, which are mostly rich, fertile loam, the interior is principally cold and stiff clay or thin loam with strong clayey subsoil. Part of the Howe of Fife is light and shingly and covered with heather. Some small peat mosses still exist, and near Lochgelly there is a tract of waste, partly moss and partly heath. The character of the farm management may be judged by its results. The best methods are pursued, and houses, steadings and cottages are all in good order, commodious and comfortable. Rabbits, hares, pheasants and partridges are common in certain districts; roe deer are occasionally seen; wild geese, ducks and teal haunt the lochs; pigeon-houses are fairly numerous; and grouse and blackcock are plentiful on the Lomond moors. The shire is well suited for fox-hunting, and there are packs in both the eastern and the western division of Fife.

Mining.—Next to Lanarkshire, Fife is the largest coal-producing county in Scotland. The coal-field may roughly be divided into the Dunfermline basin (including Halbeath, Lochgelly and Kelty), where the principal house coals are found, and

the Wemyss or Dysart basin (including Methil and the hinterland), where gas-coal of the best quality is obtained. Coal is also extensively worked at Culross, Carnock, Falfield, Donibristle, Ladybank, Kilconquhar and elsewhere. Beds of ironstone, limestone, sandstone and shale lie in many places contiguous to the coal. Blackband ironstone is worked at Lochgelly and Oakley, where there are large smelting furnaces. Oil shale is worked at Burntisland and Airdrie near Crail. Among the principal limestone quarries are those at Charlestown, Burntisland and Cults. Freestone of superior quality is quarried at Strathmiglo, Burntisland and Dunfermline. Whinstone of unusual hardness and durability is obtained in nearly every district. Lead has been worked in the Lomond Hills and copper and zinc have been met with, though not in paying quantities. It is of interest to note that in the trap tufa at Elie there have been found pyropes (a variety of dark-red garnet), which are regarded as the most valuable of Scottish precious stones and are sold under the name of Elie rubies.

Other Industries.—The staple manufacture is linen, ranging from the finest damasks to the coarsest ducks and sackings. Its chief seats are at Kirkcaldy and Dunfermline, but it is carried on at many of the inland towns and villages, especially those situated near the Eden and Leven, on the banks of which rivers, as well as at Kirkcaldy, Dunfermline and Ceres, are found the bleaching-greens. Kirkcaldy is famous for its oil-cloth and linoleum. Most of the leading towns possess breweries and tanneries, and the largest distilleries are at Cameron Bridge and Burntisland. Woollen cloth is made to a small extent in several towns, and fishing-net at Kirkcaldy, Largo and West Wemyss. Paper is manufactured at Guardbridge, Markinch and Leslie; earthenware at Kirkcaldy; tobacco at Dunfermline and Kirkcaldy; engineering works and iron foundries are found at Kirkcaldy and Dunfermline; and shipbuilding is carried on at Kinghorn, Dysart, Burntisland, Inverkeithing and Tayport. From Inverkeithing all the way round the coast to Newburgh there are harbours at different points. They are mostly of moderate dimensions, the principal port being Kirkcaldy. The largest salmon fisheries are conducted at Newburgh and the chief seat of the herring fishery is Anstruther, but most of the coast towns take some part in the fishing either off the shore, or at stations farther north, or in the deep sea.

Communications.—The North British railway possesses a monopoly in the shire. From the Forth Bridge the main line follows the coast as far as Dysart and then turns northwards to Ladybank, where it diverges to the north-east for Cupar and the Tay Bridge. From Thornton Junction a branch runs to Dunfermline and another to Methil, and here begins also the coast line for Leven, Crail and St Andrews which touches the main line again at Leuchars Junction; at Markinch a branch runs to Leslie; at Ladybank there are branches to Mawcarse Junction, and to Newburgh and Perth; and at Leuchars Junction a loop line runs to Tayport and Newport, joining the main at Wormit. From the Forth Bridge the system also connects, via Dunfermline, with Alloa and Stirling in the W. and with Kinross and Perth in the N. From Dunfermline there is a branch to Charlestown, which on that account is sometimes called the port of Dunfermline.

Population and Government.—The population was 190,365 in 1891, and 218,840 in 1901, when 844 persons spoke Gaelic and English and 3 Gaelic only. The chief towns are the Anstruthers (pop. in 1901, 4233), Buckhaven (8828), Burntisland (4846), Cowdenbeath (7908), Cupar (4511), Dunfermline (25,250), Dysart (3562), Kelty (3986), Kirkcaldy (34,079), Leslie (3587), Leven (5577), Lochgelly (5472), Lumphinnans (2071), Newport (2869), St Andrews (7621), Tayport (3325) and Wemyss (2522). For parliamentary purposes Fife is divided into an eastern and a western division, each returning one member. It also includes the Kirkcaldy district of parliamentary burghs (comprising Burntisland, Dysart, Kinghorn and Kirkcaldy), and the St Andrews district (the two Anstruthers, Crail, Cupar, Kilrenny, Pittenweem and St Andrews); while Culross, Dunfermline and Inverkeithing are grouped with the Stirling district. As

regards education the county is under school-board jurisdiction, and in respect of higher education its equipment is effective. St Andrews contains several excellent schools; at Cupar there is the Bell-Baxter school; at Dunfermline and Kirkcaldy there are high schools and at Anstruther there is the Waid Academy.

History.—In remote times the term Fife was applied to the peninsula lying between the estuaries of the Tay and Forth and separated from the rest of the mainland by the Ochil Hills. Its earliest inhabitants were Picts of the northern branch and their country was long known as Pictavia. Doubtless it was owing to the fact that the territory was long subject to the rule of an independent king that Fife itself came to be called distinctively The Kingdom, a name of which the natives are still proud. The Romans effected no settlement in the province, though it is probable that they temporarily occupied points here and there. In any case the Romans left no impression on the civilization of the natives. With the arrival of the missionaries—especially St Serf, St Kenneth, St Rule, St Adrian, St Moran and St Fillan—and conversion of the Picts went on apace. Interesting memorials of these devout missionaries exist in the numerous coast caves between Dysart and St Andrews and in the crosses and sculptured stones, some doubtless of pre-Christian origin, to be seen at various places. The word Fife, according to Skene, seems to be identical with the Jutland *Fibh* (pronounced *Fife*) meaning "forest," and was probably first used by the Frisians to describe the country behind the coasts of the Forth and Tay, where Frisian tribes are supposed to have settled at the close of the 4th century. The next immigration was Danish, which left lasting traces in many place-names (such as the frequent use of *law* for hill). An ancient division of the Kingdom into Fife and Fothrif survived for a period for ecclesiastical purposes. The line of demarcation ran from Leven to the east of Cults, thence to the west of Collesie and thence to the east of Auchtermuchty. To the east of this line lay Fife proper. In 1426 the first shire of Kinross was formed, consisting of Kinross and Orwell, and was enlarged to its present dimensions by the transference from Fife of the parishes of Portmoak, Cleish and Tulliebole. Although the county has lain outside of the main stream of Scottish history, its records are far from dull or unimportant. During the reigns of the earlier Stuarts, Dunfermline, Falkland and St Andrews were often the scene of solemn pageantry and romantic episodes. Out of the seventy royal burghs in Scotland no fewer than eighteen are situated in the shire. However, notwithstanding the marked preference of the Stuarts, the Kingdom did not hesitate to play the leading part in the momentous dramas of the Reformation and the Covenant, and by the 18th century the people had ceased to regard the old royal line with any but sentimental interest, and the Jacobite risings of 1715 and 1745 evoked only the most lukewarm support.

See Sir Robert Sibbald, *History of the Sheriffdoms of Fife and Kinross*; Rev. J. W. Taylor, *Historical Antiquities of Fife* (1875); A. H. Millar, *Fife, Pictorial and Historical* (Cupar, 1895); Sheriff Aeneas Mackay, sketch of the *History of Fife* (Edinburgh, 1890); *History of Fife and Kinross* (Scottish County History series) (Edinburgh, 1896); John Geddie, *The Fringe of Fife* (Edinburgh, 1894).

FIFE (Fr. *fifre*; Med. Ger. *Schweizerpfeiff*, *Feldpfeiff*; Ital. *ottavino*), originally the small primitive cylindrical transverse flute, now the small B♭ military flute, usually conoidal in bore, used in a drum and fife band. The pitch of the fife lies between that of the concert flute and piccolo. The fife, like the flute, is an open pipe, for although the upper end is stopped by means of a cork, an outlet is provided by the embouchure which is never entirely closed by the lips. The six finger-holes of the primitive flute, with the open end of the tube for a key-note, gave the diatonic scale of the fundamental octave; the second octave was produced by overblowing the notes of the fundamental scale an octave higher; part of a third octave was obtained by means of the higher harmonics produced by using certain of the finger-holes as vent-holes. The modern fife has, in addition to the six finger-holes, 4, 5 or 6 keys. Mersenne describes and figures the fife, which had in his day the compass of a fifteenth.¹ The fife, which, he states, differed from the

German flute only in having a louder and more brilliant tone and a shorter and narrower bore, was the instrument used by the Swiss with the drum. The sackbut, or serpent, was used as its bass, for, as Mersenne explains, the bass instrument could not be made long enough, nor could the hands reach the holes, although some flutes were actually made with keys and had the tube doubled back as in the bassoon.²

The words *fife* and the Fr. *fifre* were undoubtedly derived from the Ger. *Pfeiff*, the fife being called by Praetorius,³ *Schweizerpfeiff* and *Feldpfeiff*, while Martin Agricola,⁴ writing a century earlier (1529), mentions the transverse flute by the names of *Querchpfeiff* or *Schweizerpfeiff*, which Sebastian Virdung⁵ writes *Zwerchpfeiff*. The Old English spelling was *phife*, *phipe* or *ffyffe*. The fife was in use in England in the middle of the 16th century, for at a muster of the citizens of London in 1540, *droumes* and *ffyffes* are mentioned. At the battle of St Quentin (1557) the list of the English army⁶ employed states that one trumpet was allowed to each cavalry troop of 100 men, and a drum and fife to each hundred of foot. A *drumme* and *phife* were also employed at one shilling per diem for the "Trayne of Artillery."⁷ This was the nucleus of the modern military band, and may be regarded as the first step in its formation. In England the adoption of the fife as a military instrument was due to the initiative of Henry VIII., who sent to Vienna for ten good drums and as many fifers.⁸ Ralph Smith⁹ gives rules for drummers and fifers who, in addition to the duty of giving signals in peace and war to the company, were expected to be brave, secret and ingenious, and masters of several languages, for they were oft sent to parley with the enemy and were entrusted with honourable but dangerous missions. In 1585 the drum and fife formed part of the furniture for war among the companies of the city of London.¹⁰ Queen Elizabeth (according to Michaud, *Biogr. universelle*, tome xiii. p. 60) had a peculiar taste for noisy music, and during meals had a concert of twelve trumpets, two kettledrums, with fifes and drums. The fife became such a favourite military instrument during the 16th and 17th centuries in England that it displaced the bagpipe; it was, however, in turn superseded early in the 18th century by the hautboy (see OBOE), introduced from France. In the middle of the 18th century the fife was reintroduced into the British army band by the duke of Cumberland¹¹ in the Guards in 1745, commemorated by William Hogarth's picture of the "March of the Guards towards Scotland in 1745," in which are seen a drummer and fifer; and by Colonel Bedford into the royal regiment of artillery in 1748, at the end of the war, when a Hanoverian fifer, John Ulrich, was brought over from Flanders as instructor.¹² In 1747 the 19th regiment, known as Green Howards, also had the advantage of a Hanoverian fifer as teacher, a youth presented by his colonel to Lieutenant-Colonel Williams commanding the regiment at Bois-le-Duc. Drum and fife bands in a short time became common in all infantry regiments, while among the cavalry the trumpet prevailed.

For the acoustics, construction and origin of the fife see FLUTE. Illustrations of the fife may be seen in Cowdray's picture of an encampment at Portsmouth in 1548; in Sandford's "Coronation Procession of James II.," and in C. R. Day's *Descriptive Catalogue*, pl. i. (F) (description No. 42, p. 27). (K. S.)

FIFTH MONARCHY MEN, the name of a Puritan sect in England which for a time supported the government of Oliver Cromwell in the belief that it was a preparation for the "fifth monarchy," that is for the monarchy which should succeed the Assyrian, the Persian, the Greek and the Roman, and during which Christ should reign on earth with His saints for a thousand years. These sectaries aimed at bringing about the entire abolition of the existing laws and institutions, and the substitution of a simpler code based upon the law of Moses. Disappointed at the delay in the fulfilment of their hopes, they soon began to agitate against the government and to vilify Cromwell; but the arrest of their leaders and preachers, Christopher Feake, John Rogers and others, cooled their ardour, and they were, perforce, content to cherish their hopes in secret until after the Restoration. Then, on the 6th of January 1661, a band of fifth monarchy men, headed by a cooper named Thomas Venner,

² For an illustration of one of these bass flutes see article FLUTE, fig. 2.

³ *Syntagma musicum* (Wolfenbüttel, 1618), pp. 40-41 of Reprint.

⁴ *Musica instrumentalis* (Wittenberg, 1529).

⁵ *Musica getuscht und ausgezogen* (Basel, 1511).

⁶ See Sir S. D. Scott, *The British Army*, vol. ii. p. 396.

⁷ See H. G. Farmer, *Memoirs of the Royal Artillery Band* (London, 1904).

⁸ *Id.* ⁹ *Id.* ¹⁰ Stowe's *Chronicles*, p. 702.

¹¹ Grose, *Military Antiquities* (London, 1801), vol. ii.

¹² See Colonel P. Forbes Macbean, *Memoirs of the Royal Regiment of Artillery*.

¹ *Harmonie universelle* (Paris, 1636), bk. v. prop. 9, pp. 241-244.

who was one of their preachers, made an attempt to obtain possession of London. Most of them were either killed or taken prisoners, and on the 19th and 21st of January Venner and ten others were executed for high treason. From that time the special doctrines of the sect either died out, or became merged in a milder form of millenarianism, similar to that which exists at the present day.

For the proceedings of the sect see S. R. Gardiner, *History of the Commonwealth and Protectorate, passim* (London, 1894-1901); and for an account of the rising of 1661 see Sir John Reresby, *Memoirs, 1634-1689*, edited by J. J. Cartwright (London, 1875).

FIG, the popular name given to plants of the genus *Ficus*, an extensive group, included in the natural order Moraceae, and characterized by a remarkable development of the pear-shaped receptacle, the edge of which curves inwards, so as to form a nearly closed cavity, bearing the numerous fertile and sterile flowers mingled on its surface. The figs vary greatly in habit,—some being low trailing shrubs, others gigantic trees, among the



FIGURE 1.—Fruiting Branch of Fig, *Ficus Carica*; about $\frac{2}{3}$ nat. size. 1. Unripe fruit cut lengthwise; about $\frac{1}{2}$ nat. size. 2. Female flower taken from 1; enlarged. 3. Ripe fruit cut lengthwise; about $\frac{1}{2}$ nat. size.

most striking forms of those tropical forests to which they are chiefly indigenous. They have alternate leaves, and abound in a milky juice, usually acrid, though in a few instances sufficiently mild to be used for allaying thirst. This juice contains caoutchouc in large quantity.

Ficus Carica (figure 1), which yields the well-known figs of commerce, is a bush or small tree—rarely more than 18 or 20 ft. high,—with broad, rough, deciduous leaves, very deeply lobed in the cultivated varieties, but in the wild plant sometimes nearly entire. The green, rough branches bear the solitary, nearly sessile receptacles in the axils of the leaves. The male flowers are placed chiefly in the upper part of the cavity, and in most varieties are few in number. As it ripens, the receptacle enlarges greatly, and the numerous single-seeded pericarps or true fruits become imbedded in it. The fruit of the wild fig never acquires the succulence of the cultivated kinds. The fig seems to be indigenous to Asia Minor and Syria, but now occurs in a wild state in most of the countries around the Mediterranean. From the ease with which the nutritious fruit can be preserved, it was probably one of the earliest objects of cultivation, as may be inferred from the frequent allusions to it in the Hebrew

Scriptures.¹ From a passage in Herodotus the fig would seem to have been unknown to the Persians in the days of the first Cyrus; but it must have spread in remote ages over all the districts around the Aegean and Levant. The Greeks are said to have received it from Caria (hence the specific name); but the fruit so improved under Hellenic culture that Attic figs became celebrated throughout the East, and special laws were made to regulate their exportation. From the contemptuous name given to informers against the violation of those enactments, *συκοφάνται* (*σῦκον, φάινω*), our word sycophant is usually derived. The fig was one of the principal articles of sustenance among the Greeks; the Spartans especially used it largely at their public tables. From Hellas, at some prehistoric period, it was transplanted to Italy and the adjacent islands. Pliny enumerates many varieties, and alludes to those from Ebusus (the modern Iviza) as most esteemed by Roman epicures; while he describes those of home growth as furnishing a large portion of the food of the slaves, particularly those employed in agriculture, by whom great quantities were eaten in the fresh state at the periods of fig-harvest. In Latin myths the plant plays an important part. Held sacred to Bacchus, it was employed in religious ceremonies; and the fig-tree that overshadowed the twin founders of Rome in the wolf's cave, as an emblem of the future prosperity of the race, testified to the high value set upon the fruit by the nations of antiquity. The tree is now cultivated in all the Mediterranean countries, but the larger portion of our supply of figs comes from Asia Minor, the Spanish Peninsula and the south of France. Those of Asiatic Turkey are considered the best. The varieties are extremely numerous, and the fruit is of various colours, from deep purple to yellow, or nearly white. The trees usually bear two crops,—one in the early summer from the buds of the last year, the other in the autumn from those on the spring growth; the latter forms the chief harvest. Many of the immature receptacles drop off from imperfect fertilization, which circumstance has led, from very ancient times, to the practice of *caprifigation*.² Branches of the wild fig in flower are placed over the cultivated bushes. Certain hymenopterous insects, of the genera *Blastophaga* and *Sycophaga*, which frequent the wild fig, enter the minute orifice of the receptacle, apparently to deposit their eggs; conveying thus the pollen more completely to the stigmas, they ensure the fertilization and consequent ripening of the fruit. By some the nature of the process has been questioned, and the better maturation of the fruit attributed merely to the stimulus given by the puncture of the insect, as in the case of the apple; but the arrangement of the unisexual flowers in the fig renders the first theory the more probable. In some districts a straw or small twig is thrust into the receptacle with a similar object. When ripe the figs are picked, and spread out to dry in the sun,—those of better quality being much pulled and extended by hand during the process. Thus prepared, the fruit is packed closely in barrels, rush baskets, or wooden boxes, for commerce. The best kind, known as *elemi*, are shipped at Smyrna, where the

¹ Of these the case of the Barren Fig-tree (Mark. xi. 12-14, 20-21: compare Matt. xxi. 18-20), which Jesus cursed and which then withered away, has been much discussed among theologians. The difficulty is in Mark xi. 13: "And seeing a fig-tree afar off having leaves, he came, if haply he might find anything thereon; and when he came to it he found nothing but leaves, for the time of figs was not yet." These last words obviously raise the question whether the expectation of Jesus of finding figs, and his cursing of the tree on finding none, were not unreasonable. Many ingenious solutions have been propounded, by suggested emendations of the text and otherwise, for which consult M'Clintock and Strong's *Cyclopaedia of Biblical Literature* (sub "Fig") and the *Encyclopaedia Biblica* ("Fig-tree"); the former demurs to the unreasonableness, and contends that the appearance of the leaves at this season (March) indicated a pretentious precocity in this particular fig-tree, so that Jesus was entitled to expect that it would also have fruit, even though the season had not arrived; the *Ency. Biblica*, on the other hand, supposes that some "early Christian," confounding parable with history, has misunderstood the parable in Luke xiii. 6-9, and, forgetting that the season was not one for figs, has transformed it here into the narrative of an act of Jesus. The probability seems to be that the words "for the time of figs was not yet" are an un-intelligent gloss by an early reader, which has made its way into the text. For authorities see the works mentioned above.

² From Lat. *caprificus*, a wild fig; O. Eng. *caprifig*.

pulling and packing of figs form one of the most important industries of the people.

This fruit still constitutes a large part of the food of the natives of western Asia and southern Europe, both in the fresh and dried state. A sort of cake made by mashing up the inferior kinds serves in parts of the Archipelago as a substitute for bread. Alcohol is obtained from fermented figs in some southern countries; and a kind of wine, still made from the ripe fruit, was known to the ancients, and mentioned by Pliny under the name of *syctes*. Medicinally the fig is employed as a gentle laxative, when eaten abundantly often proving useful in chronic constipation; it forms a part of the well-known "confection of senna." The milky juice of the stems and leaves is very acrid, and has been used in some countries for raising blisters. The wood is porous and of little value; though a piece, saturated with oil and spread with emery, is in France a common substitute for a hone.

The fig is grown for its fresh fruit (eaten as an article of dessert) in all the milder parts of Europe, and in the United States, with protection in winter, succeeds as far north as Pennsylvania. The fig was introduced into England by Cardinal Pole, from Italy, early in the 16th century. It lives to a great age, and along the southern coast of England bears fruit abundantly as a standard; but in Scotland and in many parts of England a south wall is indispensable for its successful cultivation out of doors.

Fig trees are propagated by cuttings, which should be put into pots, and placed in a gentle hotbed. They may be obtained more speedily from layers, which should consist of two or three years old shoots, and these, when rooted, will form plants ready to bear fruit the first or second year after planting. The best soil for a fig border is a friable loam, not too rich, but well drained; a chalky subsoil is congenial to the tree, and, to correct the tendency to over-luxuriance of growth, the roots should be confined within spaces surrounded by a wall enclosing an area of about a square yard. The sandy soil of Argenteuil, near Paris, suits the fig remarkably well; but the best trees are those which grow in old quarries, where their roots are free from stagnant water, and where they are sheltered from cold, while exposed to a very hot sun, which ripens the fruit perfectly. The fig succeeds well planted in a paved court against a building with a south aspect.

The fig tree naturally produces two sets of shoots and two crops of fruit in the season. The first shoots generally show young figs in July and August, but these in the climate of England very seldom ripen, and should therefore be rubbed off. The late or midsummer shoots likewise put forth fruit-buds, which, however, do not develop themselves till the following spring; and these form the only crop of figs on which the British gardener can depend.

The fig tree grown as a standard should get very little pruning, the effect of cutting being to stimulate the buds to push shoots too vigorous for bearing. When grown against a wall, it has been recommended that a single stem should be trained to the height of a foot. Above this a shoot should be trained to the right, and another to the left; from these principals two other subdivisions should be encouraged, and trained 15 in. apart; and along these branches, at distances of about 8 in., shoots for bearing, as nearly as possible of equal vigour, should be encouraged. The bearing shoots produced along the leading branches should be trained in at full length, and in autumn every alternate one should be cut back to one eye. In the following summer the trained shoots should bear and ripen fruit, and then be cut back in autumn to one eye, while shoots from the bases of those cut back the previous autumn should be trained for succession. In this way every leading branch will be furnished alternately with bearing and successional shoots.

When protection is necessary, as it may be in severe winters, though it is too often provided in excess, spruce branches have been found to answer the purpose exceedingly well, owing to the fact that their leaves drop off gradually when the weather becomes milder in spring, and when the trees require less protection and more light and air. The principal part requiring protection is the main stem, which is more tender than the young wood.

In forcing, the fig requires more heat than the vine to bring it into leaf. It may be subjected to a temperature of 50° at night, and from 60° to 65° in the day, and this should afterwards be increased to 60° and 65° by night, and 70° to 75° by day, or even higher by sun heat, giving plenty of air at the same time. In this temperature the evaporation from the leaves is very great, and this must be replaced and the wants of the swelling fruit supplied by daily watering, by syringing the foliage, and by moistening the floor, this atmospheric moisture being also necessary to keep down the red spider. When the crop begins to ripen, a moderately dry atmosphere should be maintained, with abundant ventilation when the weather permits.

The fig tree is easily cultivated in pots, and by introducing the

plants into heat in succession the fruiting season may be considerably extended. The plants should be potted in turfy loam mixed with charcoal and old mortar rubbish, and in summer top-dressings of rotten manure, with manure water two or three times a week, will be beneficial. While the fruit is swelling, the pots should be plunged in a bed of fermenting leaves.

The following are a few of the best figs; those marked F. are good forcing sorts, and those marked W. suitable for walls:—

Agen: brownish-green, turbinate.

Brown Ischia, F.: chestnut-coloured, roundish-turbinate.

Brown Turkey (Lee's Perpetual), F., W.: purplish-brown, turbinate.

Brunswick, W.: brownish-green, pyriform.

Col di Signora Bianca, F.: greenish-yellow, pyriform.

Col di Signora Nero: dark chocolate, pyriform.

Early Violet, F.: brownish-purple, roundish.

Grizzly Bourjassotte: chocolate, round.

Grosse Monstreuse de Lipari: pale chestnut, turbinate.

Negro Largo, F.: black, long pyriform.

White Ischia, F.: greenish-yellow, roundish-obovate.

White Marseilles, F., W.: pale green, roundish-obovate.

The sycamore fig, *Ficus Sycomorus*, is a tree of large size, with heart-shaped leaves, which, from their fancied resemblance to those of the mulberry, gave origin to the name *Συκόμορος*. From the deep shade cast by its spreading branches, it is a favourite tree in Egypt and Syria, being often planted along roads and near houses. It bears a sweet edible fruit, somewhat like that of the common fig, but produced in racemes on the older boughs. The apex of the fruit is sometimes removed, or an incision made



FIGURE 2.—India-rubber Tree, *Ficus elastica*, showing spreading woody roots.

in it, to induce earlier ripening. The ancients, after soaking it in water, preserved it like the common fig. The porous wood is only fit for fuel.

The sacred fig, peepul, or bo, *Ficus religiosa*, a large tree with heart-shaped, long-pointed leaves on slender footstalks, is much grown in southern Asia. The leaves are used for tanning, and afford lac, and a gum resembling caoutchouc is obtained from the juice; but in India it is chiefly planted with a religious object, being regarded as sacred by both Brahmans and Buddhists. The former believe that the last avatar of Vishnu took place beneath its shade. A gigantic bo, described by Sir J. Emerson Tennent as growing near Anarajapoor, in Ceylon, is, if tradition may be trusted, one of the oldest trees in the world. It is said to have been a branch of the tree under which Gautama Buddha became endued with his divine powers, and has always been held in the greatest veneration. The figs, however, hold as important a place in the religious fables of the East as the ash in the myths of Scandinavia.

Ficus elastica, the India-rubber tree (figure 2), the large, oblong, glossy leaves, and pink buds of which are so familiar in our greenhouses, furnishes most of the caoutchouc obtained from the East Indies. It grows to a large size, and is remarkable

for the snake-like roots that extend in contorted masses around the base of the trunk. The small fruit is unfit for food.

Ficus bengalensis, or the Banyan, wild in parts of northern India, but generally planted throughout the country, has a woody stem, branching to a height of 70 to 100 ft. and of vast extent with heart-shaped entire leaves terminating in acute points. Every branch from the main body throws out its own roots, at first in small tender fibres, several yards from the ground; but these continually grow thicker until they reach the surface, when they strike in, increase to large trunks, and become parent trees, shooting out new branches from the top, which again in time suspend their roots, and these, swelling into trunks, produce other branches, the growth continuing as long as the earth contributes her sustenance. On the banks of the Nerbudda stood a celebrated tree of this kind, which is supposed to be that described by Nearchus, the admiral of Alexander the Great. This tree once covered an area so immense, that it was known to shelter no fewer than 7000 men, and though much reduced in size by the destructive power of the floods, the remainder was described by James Forbes (1749-1819), in his *Oriental Memoirs* (1813-1815) as nearly 2000 ft. in circumference, while the trunks large and small exceeded 3000 in number. The tree usually grows from seeds dropped by birds on other trees. The leaf-axil of a palm forms a frequent receptacle for their growth, the palm becoming ultimately strangled by the growth of the fig, which by this time has developed numerous daughter stems which continue to expand and cover ultimately a large area. The famous tree in the Royal Botanic Gardens, Calcutta, began its growth at the end of the 18th century on a sacred date-palm. In 1907 it had nearly 250 aerial roots, the parent trunk was 42 ft. in girth, and its leafy crown had a circumference of 857 ft.; and it was still growing vigorously. Both this tree and *F. religiosa* cause destruction to buildings, especially in Bengal, from seeds dropped by birds germinating on the walls. The tree yields an inferior rubber, and a coarse rope is prepared from the bark and from the aerial roots.

FIGARO, a famous dramatic character first introduced on the stage by Beaumarchais in the *Barbier de Séville*, the *Mariage de Figaro*, and the *Folle Journée*. The name is said to be an old Spanish and Italian word for a wig-maker, connected with the verb *cigarrar*, to roll in paper. Many of the traits of the character are to be found in earlier comic types of the Roman and Italian stage, but as a whole the conception was marked by great originality; and Figaro soon seized the popular imagination, and became the recognized representative of daring, clever and nonchalant roguery and intrigue. Almost immediately after its appearance, Mozart chose the *Marriage of Figaro* as the subject of an opera, and the *Barber of Seville* was treated first by Paisiello, and afterwards in 1816 by Rossini. In 1826 the name of the witty rogue was taken by a journal which continued till 1833 to be one of the principal Parisian periodicals, numbering among its contributors such men as Jules Janin, Paul Lacroix, Léon Gozlan, Alphonse Karr, Dr Veron, Jules Sandeau and George Sand. Various abortive attempts were made to restore the *Figaro* during the next twenty years; and in 1854 the efforts of M. de Villemessant were crowned with success (see *NEWSPAPERS: France*).

See Marc Monnier, *Les Aïeux de Figaro* (1868); H. de Villemessant, *Mémoires d'un journaliste* (1867).

FIGEAC, a town of south-western France, capital of an arrondissement in the department of Lot, 47 m. E. N. E. of Cahors on the Orléans railway. Pop. (1906) 4330. It is enclosed by an amphitheatre of wooded and vine-clad hills, on the right bank of the Célé, which is here crossed by an old bridge. It is ill-built and the streets are narrow and dirty; on the outskirts shady boulevards have taken the place of the ramparts by which it was surrounded. The town is very rich in old houses of the 13th and 14th centuries; among them may be mentioned the Hôtel de Balène, of the 14th century, used as a prison. Another house, dating from the 15th century, was the birthplace of the Egyptologist J. F. Champollion, in memory of whom the town has erected an obelisk. The principal church is that of

St Sauveur, which once belonged to the abbey of Figeac. It was built at the beginning of the 12th century, but restored later; the façade in particular is modern. Notre-Dame du Puy, in the highest part of the town, belongs to the 12th and 13th centuries. It has no transept and its aisles extend completely round the interior. The altar-screen is a fine example of carved woodwork of the end of the 17th century. Of the four obelisks which used to mark the limits of the authority of the abbots of Figeac, those to the south and the west of the town remain. Figeac is the seat of a subprefect and has a tribunal of first instance, and a communal college. Brewing, tanning, printing, cloth-weaving and the manufacture of agricultural implements are among the industries. Trade is in cattle, leather, wool, plums, walnuts and grain, and there are zinc mines in the neighbourhood.

Figeac grew up round an abbey founded by Pippin the Short in the 8th century, and throughout the middle ages it was the property of the monks. At the end of the 16th century the lordship was acquired by King Henry IV.'s minister, the duke of Sully, who sold it to Louis XIII. in 1622.

FIGUEIRA DA FOZ, or FIGUEIRA, a seaport of central Portugal, in the district of Coimbra, formerly included in the province of Beira; on the north bank of the river Mondego, at its mouth, and at the terminus of the Lisbon-Figueira and Guarda-Figueira railways. Pop. (1900) 6221. Figueira da Foz is an important fishing-station, and one of the headquarters of the coasting trade in grain, fruit, wine, olive oil, cork and coal; but owing to the bar at the mouth of the Mondego large ships cannot enter. Glass is manufactured, and the city attracts many visitors by its excellent climate and sea-bathing. A residential suburb, the Bairro Novo, exists chiefly for their accommodation, to the north-west of the old town. Figueira is connected by a tramway running 4 m. N. W. with Buarcos (pop. 5033) and with the coal-mines of Cape Mondego. Lavos (pop. 7939), on the south bank of the Mondego, was the principal landing-place of the British troops which came, in 1808, to take part in the Peninsular War. Figueira da Foz received the title and privileges of city by a decree dated the 20th of September 1882.

FIGUERAS, a town of north-eastern Spain, in the province of Gerona, 14 m. S. of the French frontier, on the Barcelona-Perpignan railway. Pop. (1900) 10,714. Figueras is built at the foot of the Pyrenees, and on the northern edge of El Ampurdan, a fertile and well-irrigated plain, which produces wine, olives and rice, and derives its name from the seaport of Ampurias, the ancient Emporiae. The castle of San Fernando, 1 m. N. W., is an irregular pentagonal structure, built by order of Ferdinand VI. (1746-1759), on the site of a Capuchin convent. Owing to its situation, and the rocky nature of the ground over which a besieger must advance, it is still serviceable as the key to the frontier. It affords accommodation for 16,000 men and is well provided with bomb-proof cover. In 1794 Figueras was surrendered to the French, but it was regained in 1795. During the Peninsular War it was taken by the French in 1808, recaptured by the Spaniards in 1811, and retaken by the French in the same year. In 1823, after a long defence, it was once more captured by the French. An annual pilgrimage from Figueras to the chapel of Nuestra Señora de Requesens, 15 m. N., commemorates the deliverance of the town from a severe epidemic of fever in 1612.

FIGULUS, PUBLIUS NIGIDIUS (c. 98-45 B.C.), Roman savant, next to Varro the most learned Roman of the age. He was a friend of Cicero, to whom he gave his support at the time of the Catilinarian conspiracy (Plutarch, *Cicero*, 20; Cicero, *Pro Sulla*, xiv. 42). In 58 he was praetor, sided with Pompey in the Civil War, and after his defeat was banished by Caesar, and died in exile. According to Cicero (*Timaeus*, 1), Figulus endeavoured with some success to revive the doctrines of Pythagoreanism. With this was included mathematics, astronomy and astrology, and even the magic arts. According to Suetonius (*Augustus*, 94) he foretold the greatness of the future emperor on the day of his birth, and Apuleius (*Apologia*, 42) records that, by the employment of "magic boys" (*magici pueri*), he

helped to find a sum of money that had been lost. Jerome (the authority for the date of his death) calls him *Pythagoricus et magus*. The abstruse nature of his studies, the mystical character of his writings, and the general indifference of the Romans to such subjects, caused his works to be soon forgotten. Amongst his scientific, theological and grammatical works mention may be made of *De diis*, containing an examination of various cults and ceremonies; treatises on divination and the interpretation of dreams; on the sphere, the winds and animals. His *Commentarii grammatici* in at least 29 books was an ill-arranged collection of linguistic, grammatical and antiquarian notes. In these he expressed the opinion that the meaning of words was natural, not fixed by man. He paid especial attention to orthography, and sought to differentiate the meanings of cases of like ending by distinctive marks (the apex to indicate a long vowel is attributed to him). In etymology he endeavoured to find a Roman explanation of words where possible (according to him *frater* was = *fere alter*). Quintilian (*Instit. orat.* xi. 3. 143) speaks of a rhetorical treatise *De gestu* by him.

See Cicero, *Ad Fam.* iv. 13; scholiast on Lucan i. 639; several references in Aulus Gellius; Teuffel, *Hist. of Roman Literature*, 170; M. Hertz, *De N. F. studiis atque operibus* (1845); *Quaestiones Nigidianae* (1890), and edition of the fragments (1889) by A. Swoboda.

FIGURATE NUMBERS, in mathematics. If we take the sum of n terms of the series $1+1+1+\dots$, i.e. n , as the n th term of a new series, we obtain the series $1+2+3+\dots$, the sum of n terms of which is $\frac{1}{2}n(n+1)$. Taking this sum as the n th term, we obtain the series $1+3+6+10+\dots$, which has for the sum of n terms $\frac{n(n+1)(n+2)}{3!}$. This sum is taken as the n th term of the next series, and proceeding in this way we obtain series having the following n th terms:—
 $1, n, \frac{n(n+1)}{2!}, \frac{n(n+1)(n+2)}{3!}, \dots, \frac{n(n+1)\dots(n+r-2)}{(r-1)!}$.
 The numbers obtained by giving n any value in these expressions are of the first, second, third, . . . or r th order of figurate numbers.

Pascal treated these numbers in his *Traité du triangle arithmétique* (1665), using them to develop a theory of combinations and to solve problems in probability.

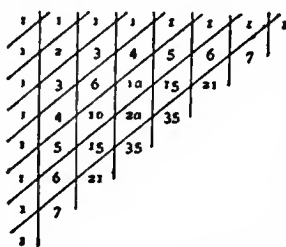

expansion of $(1+x)^r$, where r represents the number of units cut off.

FIJI (*Viti*), a British colony consisting of an archipelago in the Pacific Ocean, the most important in Polynesia, between 15° and 20° S., and on and about the meridian of 180° . The islands number about 250, of which some 80 are inhabited. The total land area is 7435 sq. m. (thus roughly equalling that of Wales), and the population is about 121,000. The principal island is Viti Levu, 98 m. in length (E. to W.) and 67 in extreme breadth, with an area of 4112 sq. m. Forty miles N.E. lies Vanua Levu, measuring 117 m. by 30, with an area of 2432 sq. m. Close off the south-eastern shore of Vanua Levu is Taviuni, 26 m. in length by 10 in breadth; Kandavu or Kadavu, 36 m. long and very narrow, is 41 m. S. of Viti Levu, and the three other main islands, lying east of Viti Levu in the Koro Sea, are Koro, Ngau or Gau, and Ovalau. South-east from Vanua Levu a loop of islets extends nearly to 20° S., enclosing the Koro Sea. North-west of Viti Levu lies another chain, the Yasawa or western group; and, finally, the colony includes the island of Rotumah (*q.v.*), 300 m. N.W. by N. of Vanua Levu.

The formation of the larger islands is volcanic, their surface rugged, their vegetation luxuriant, and their appearance very

¹ The notation $n!$ denotes the product $1 \cdot 2 \cdot 3 \cdot \dots \cdot n$, and is termed "factorial n ."

beautiful; their hills rise often above 3000, and, in the case of a few summits, above 4000 ft., and they contrast strongly with the low coral formation of the smaller members of the group. There is not much level country, except in the coral islets, and certain rich tracts along the coasts of the two large islands, especially near the mouths of the rivers. The large islands have a considerable extent of undulating country, dry and open on their lee sides. Streams and rivers are abundant, the latter very large in proportion to the size of the islands, affording a waterway to the rich districts along their banks. These and the extensive mud flats and deltas at their mouths are often flooded, by which their fertility is increased, though at a heavy cost to the cultivator. The Rewa, debouching through a wide delta at the south-east of Viti Levu, is navigable for small vessels for 40 m. There are also in this island the Navua and Sigatoka (flowing S.), the Nandi (W.), and the Ba (N.W.). The Dreketi, flowing W.,

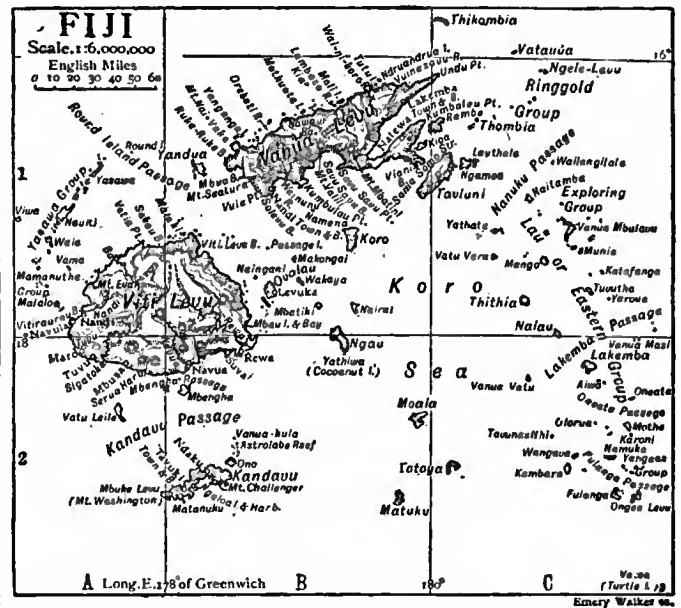

is the chief stream of Vanua Levu. It breaches the mountains in a fine valley; for this island consists practically of one long range, whereas the main valleys and ranges separating them in Viti Levu radiate for the most part from a common centre. With few exceptions the islands are surrounded by barriers of coral, broken by openings opposite the mouths of streams. Viti Levu is the most important island not only from its size, but from its fertility, variety of surface, and population, which is over one-third of that of the whole group. The town of Suva lies on an excellent harbour at the south-east of the island, and has been the capital of the colony since 1882, containing the government buildings and other offices. Vanua Levu is less fertile than Viti Levu; it has good anchorages along its entire southern coast. Of the other islands, Taviuni, remarkable for a lake (presumably a crater-lake) at the top of its lofty central ridge, is fertile, but exceptionally devoid of harbours; whereas the well-timbered island of Kandavu has an excellent one. On the eastern shore of Ovalau, an island which contains in a small area a remarkable series of gorge-like valleys between commanding hills, is the town of Levuka, the capital until 1882. It stands partly upon the narrow shore, and partly climbs the rocky slope behind. The chief islands on the west of the chain enclosing the Koro Sea are Koro, Ngau, Moala and Totoya, all productive, affording good anchorage, elevated and picturesque. The eastern islands of the chain are smaller and more numerous, Vanua Batevu (one of the Exploring Group) being a centre of trade. Among others, Mago is remarkable for a subterranean outlet of the waters of the fertile valley in its midst.

The land is of recent geological formation, the principal ranges being composed of igneous rock, and showing traces of much volcanic disturbance. There are boiling springs in Vanua

Levu and Ngau, and slight shocks of earthquake are occasionally felt. The tops of many of the mountains, from Kandavu in the S.W., through Nairai and Koro, to the Ringgold group in the N.E., have distinct craters, but their activity has long ceased. The various decomposing volcanic rocks—tufas, conglomerates and basalts—mingled with decayed vegetable matter, and abundantly watered, form a very fertile soil. Most of the high peaks on the larger islands are basaltic, and the rocks generally are igneous, with occasional upheaved coral found sometimes over 1000 ft. above the sea; but certain sedimentary rocks observed on Viti Levu seem to imply a nucleus of land of considerable age. Volcanic activity in the neighbourhood is further shown by the quantities of pumice-stone drifted on to the south coasts of Kandavu and Viti Levu; malachite, antimony and graphite, gold in small quantities, and specular iron-sand occur.

Climate.—The colony is beyond the limits of the perpetual S.E. trades, while not within the range of the N.W. monsoons. From April to November the winds are steady between S.E. and E.N.E., and the climate is cool and dry, after which the weather becomes uncertain and the winds often northerly, this being the wet warm season. In February and March heavy gales are frequent, and hurricanes sometimes occur, causing scarcity by destroying the crops. The rainfall is much greater on the windward than on the lee sides of the islands (about 110 in. at Suva), but the mean temperature is much the same, viz., about 80° F. In the hills the temperature sometimes falls below 50°. The climate, especially from November to April, is somewhat enervating to the Englishman, but not unhealthy. Fevers are hardly known. Dysentery, which is common, and the most serious disease in the islands, is said to have been unknown before the advent of Europeans.

Fauna.—Besides the dog and the pig, which (with the domestic fowl) must have been introduced in early times, the only land mammals are certain species of rats and bats. Insects are numerous, but the species few. Bees have been introduced. The avifauna is not remarkable. Birds of prey are few; the parrot and pigeon tribes are better represented. Fishes, of an Indo-Malay type, are numerous and varied; Mollusca, especially marine, and Crustaceae are also very numerous. These three form an important element in the food supply.

Flora.—The vegetation is mostly of a tropical Indo-Malayan character—thick jungle with great trees covered with creepers and epiphytes. The lee sides of the larger islands, however, have grassy plains suitable for grazing, with scattered trees, chiefly *Pandanus*, and ferns. The flora has also some Australian and New Zealand affinities (resembling in this respect the New Caledonia and New Hebrides groups), shown especially in these western districts by the *Pandanus*, by certain acacias and others. At an elevation of about 2000 ft. the vegetation assumes a more mountainous type. Among the many valuable timber trees are the vesii (*Azelia bijuga*); the dilo (*Calophyllum Inophyllum*), the oil from its seeds being much used in the islands, as in India, in the treatment of rheumatism; the dakua (*Dammara Vitiensis*), allied to the New Zealand kauri, and others. The dakua or Fiji pine, however, has become scarce. Most of the fruit trees are also valuable as timber. The native cloth (*masi*) is beaten out from the bark of the paper mulberry cultivated for the purpose. Of the palms the cocoanut is by far the most important. The yasi or sandal-wood was formerly a valuable product, but is now rarely found. There are various useful drugs, spices and perfumes; and many plants are cultivated for their beauty, to which the natives are keenly alive. Among the plants used as pot-herbs are several ferns, and two or three Solanums, one of which, *S. anthropophagorum*, was one of certain plants always cooked with human flesh, which was said to be otherwise difficult of digestion. The use of the kava root, here called yanggona, from which the well-known national beverage is made, is said to have been introduced from Tonga. Of fruit trees, besides the cocoanut, there may be mentioned the many varieties of the bread-fruit, of bananas and plantains, of sugar-cane and of lemon; the wi (*Spondias dulcis*), the kavika (*Eugenia malaccensis*), the ivi or Tahitian chestnut (*Inocarpus edulis*), the pine-apple and others introduced in modern times. Edible roots are especially abundant. The chief staple of life is the yam, the names of several months in the calendar having reference to its cultivation and ripening. The natives use no grain or pulse, but make a kind of bread (*mandrat*) from this, the taro, and other roots, as well as from the banana (which is the best), the bread-fruit, the ivi, the kavika, the arrowroot, and in times of scarcity the mangrove. This bread is made by burying the materials for months, till the mass is thoroughly fermented and homogeneous, when it is dug up and cooked by baking or steaming. This simple process, applicable to such a variety of substances, is a valuable security against famine.

People.—The Fijians are a people of Melanesian (Papuan) stock much crossed with Polynesians (Tongans and Samoans). They occupy the extreme east limits of Papuan territory and are usually classified as Melanesians; but they are physically superior to the pure examples of that race, combining their dark colour, harsh hirsute skin, crisp hair, which is bleached with lime and worn in an elaborately trained mop, and muscular limbs, with the handsome features and well proportioned bodies of the Polynesians. They are tall and well built. The features are strongly marked, but not unpleasant, the eyes deep set, the beard thick and bushy. The chiefs are fairer, much better-looking, and of a less negroid type of face than the people. This negroid type is especially marked on the west coasts, and still more in the interior of Viti Levu. The Fijians have other characteristics of both Pacific races, e.g. the quick intellect of the fairer, and the savagery and suspicion of the dark. They wear a minimum of covering, but, unlike the Melanesians, are strictly decent, while they are more moral than the Polynesians. They are cleanly and particular about their personal appearance, though, unlike other Melanesians, they care little for ornament, and only the women are tattooed. A partial circumcision is practised, which is exceptional with the Melanesians, nor have these usually an elaborate political and social system like that of Fiji. The status of the women is also somewhat better, those of the upper class having considerable freedom and influence. If less readily amenable to civilizing influences than their neighbours to the eastward, the Fijians show greater force of character and ingenuity. Possessing the arts of both races they practise them with greater skill than either. They understand the principle of division of labour and production, and thus of commerce. They are skilful cultivators and good boat-builders, the carpenters being an hereditary caste; there are also tribes of fishermen and sailors; their mats, baskets, nets, cordage and other fabrics are substantial and tasteful; their pottery, made, like many of the above articles, by women, is far superior to any other in the South Seas; but many native manufactures have been supplanted by European goods.

The Fijians were formerly notorious for cannibalism, which may have had its origin in religion, but long before the first contact with Europeans had degenerated into gluttony. The Fijian's chief table luxury was human flesh, euphemistically called by him "long pig," and to satisfy his appetite he would sacrifice even friends and relatives. The Fijians combined with this greediness a savage and merciless nature. Human sacrifices were of daily occurrence. On a chief's death wives and slaves were buried alive with him. When building a chief's house a slave was buried alive in the hole dug for each foundation post. At the launching of a war-canoe living men were tied hand and foot between two plantain stems making a human ladder over which the vessel was pushed down into the water. The people acquiesced in these brutal customs, and willingly met their deaths. Affection and a firm belief in a future state, in which the exact condition of the dying is continued, are the Fijians' own explanations of the custom, once universal, of killing sick or aged relatives. Yet in spite of this savagery the Fijians have always been remarkable for their hospitality, open-handedness and courtesy. They are a sensitive, proud, if vindictive, and boastful people, with good conversational and reasoning powers, much sense of humour, tact and perception of character. Their code of social etiquette is minute and elaborate, and the gradations of rank well marked. These are (1) chiefs, greater and lesser; (2) priests; (3) *Mata ni Vanua* (lit., eyes of the land), employés, messengers or counsellors; (4) distinguished warriors of low birth; (5) common people; (6) slaves.

The family is the unit of political society. The families are grouped in townships or otherwise (*qali*) under the lesser chiefs, who again owe allegiance to the supreme chief of the *matanitu* or tribe. The chiefs are a real aristocracy, excelling the people in physique, skill, intellect and acquirements of all sorts; and the reverence felt for them, now gradually diminishing, was very great, and had something of a religious character. All that a man had belonged to his chief. On the other hand, the chief's property

practically belonged to his people, and they were as ready to give as to take. In a time of famine, a chief would declare the contents of the plantations to be common property. A system of feudal service-tenures (*lala*) is the institution on which their social and political fabric mainly depended. It allowed the chief to call for the labour of any district, and to employ it in planting, house or canoe-building, supplying food on the occasion of another chief's visit, &c. This power was often used with much discernment; thus an unpopular chief would redeem his character by calling for some customary service and rewarding it liberally, or a district would be called on to supply labour or produce as a punishment. The privilege might, of course, be abused by needy or unscrupulous chiefs, though they generally deferred somewhat to public opinion; it has now, with similar customary exactions of cloth, mats, salt, pottery, &c. been reduced within definite limits. An allied custom, *solevu*, enabled a district in want of any particular article to call on its neighbours to supply it, giving labour or something else in exchange. Although, then, the chief is lord of the soil, the inferior chiefs and individual families have equally distinct rights in it, subject to payment of certain dues; and the idea of permanent alienation of land by purchase was never perhaps clearly realized. Another curious custom was that of *vasu* (lit. nephew). The son of a chief by a woman of rank had almost unlimited rights over the property of his mother's family, or of her people. In time of war the chief claimed absolute control over life and property. Warfare was carried on with many courteous formalities, and considerable skill was shown in the fortifications. There were well-defined degrees of dependence among the different tribes or districts: the first of these, *bati*, is an alliance between two nearly equal tribes, but implying a sort of inferiority on one side, acknowledged by military service; the second, *qali*, implies greater subjection, and payment of tribute. Thus A, being *bati* to B, might hold C in *qali*, in which case C was also reckoned subject to B, or might be protected by B for political purposes.

The former religion of the Fijians was a sort of ancestor-worship, had much in common with the creeds of Polynesia, and included a belief in a future existence. There were two classes of gods—the first immortal, of whom Ndengei is the greatest, said to exist eternally in the form of a serpent, but troubling himself little with human or other affairs, and the others had usually only a local recognition. The second rank (who, though far above mortals, are subject to their passions, and even to death) comprised the spirits of chiefs, heroes and other ancestors. The gods entered and spoke through their priests, who thus pronounced on the issue of every enterprise, but they were not represented by idols; certain groves and trees were held sacred, and stones which suggest phallic associations. The priesthood usually was hereditary, and their influence great, and they had generally a good understanding with the chief. The institution of Taboo existed in full force. The *mburê* or temple was also the council chamber and place of assemblage for various purposes.

The weapons of the Fijians are spears, slings, throwing clubs and bows and arrows. Their houses, of which the framework is timber and the rest lattice and thatch, are ingeniously constructed, with great taste in ornamentation, and are well furnished with mats, mosquito-curtains, baskets, fans, nets and cooking and other utensils. Their canoes, sometimes more than 100 ft. long, are well built. Ever excellent agriculturists, their implements were formerly digging sticks and hoes of turtlebone or flat oyster-shells. In irrigation they showed skill, draining their fields with built watercourses and bamboo pipes. Tobacco, maize, sweet potatoes, yams, kava, taro, beans and pumpkins, are the principal crops.

Fijians are fond of amusements. They have various games, and dancing, story-telling and songs are especially popular. Their poetry has well-defined metres, and a sort of rhyme. Their music is rude, and is said to be always in the major key. They are clever cooks, and for their feasts preparations are sometimes made months in advance, and enormous waste results from them. Mourning is expressed by fasting, by shaving the head and face, or by cutting off the little finger. This last is

sometimes done at the death of a rich man in the hope that his family will reward the compliment; sometimes it is done vicariously, as when one chief cuts off the little finger of his dependent in regret or in atonement for the death of another.

A steady, if not a very rapid, decrease in the native population set in after 1875. A terrible epidemic of measles in that year swept away 40,000, or about one-third of the Fijians. Subsequent epidemics have not been attended by anything like this mortality, but there has, however, been a steady decrease, principally among young children, owing to whooping-cough, tuberculosis and croup. Every Fijian child seems to contract yaws at some time in its life, a mistaken notion existing on the part of the parents that it strengthens the child's physique. Elephantiasis, influenza, rheumatism, and a skin disease, *thoko*, also occur. One per cent of the natives are lepers. A commission appointed in 1891 to inquire into the causes of the native decrease collected much interesting anthropological information regarding native customs, and provincial inspectors and medical officers were specially appointed to compel the natives to carry out the sanitary reforms recommended by the commission. A considerable sum was also spent in laying on good water to the native villages. The Fijians show no disposition to intermarry with the Indian coolies. The European half-castes are not prolific *inter se*, and they are subject to a scrofulous taint. The most robust cross in the islands is the offspring of the African negro and the Fijian. Miscegenation with the Micronesians, the only race in the Pacific which is rapidly increasing, is regarded as the most hopeful manner of preserving the native Fijian population. There is a large Indian immigrant population.

Trade, Administration, &c.—The principal industries are the cultivation of sugar and fruits and the manufacture of sugar and copra, and these three are the chief articles of export trade, which is carried on almost entirely with Australia and New Zealand. The fruits chiefly exported are bananas and pineapples. There are also exported maize, vanilla and a variety of fruits in small quantities; pearl and other shells and *bêche-de-mer*. There is a manufacture of soap from coconut oil; a fair quantity of tobacco is grown, and among other industries may be included boat-building and saw-milling. Regular steamship communications are maintained with Sydney, Auckland and Vancouver. Good bridle-tracks exist in all the larger islands, and there are some macadamized roads, principally in Viti Levu. There is an overland mail service by native runners. The export trade is valued at nearly £600,000 annually, and the imports at £500,000. The annual revenue of the colony is about £140,000 and the expenditure about £125,000. The currency and weights and measures are British. Besides the customs and stamp duties, some £18,000 of the annual revenue is raised from native taxation. The seventeen provinces of the colony (at the head of which is either a European or a *roko tui* or native official) are assessed annually by the legislative council for a fixed tax in kind. The tax on each province is distributed among districts under officials called *bulis*, and further among villages within these districts. Any surplus of produce over the assessment is sold to contractors, and the money received is returned to the natives.

Under a reconstruction made in 1904 there is an executive council consisting of the governor and four official members. The legislative council consists of the governor, ten official, six elected and two native members. The native chiefs and provincial representatives meet annually under the presidency of the governor, and their recommendations are submitted for sanction to the legislative council. Suva and Levuka have each a municipal government, and there are native district and village councils. There is an armed native constabulary; and a volunteer and cadet corps in Suva and Levuka.

The majority of the natives are Wesleyan Methodists. The Roman Catholic missionaries have about 3000 adherents; the Church of England is confined to the Europeans and *kanakas* in the towns; the Indian coolies are divided between Mahomedans and Hindus. There are public schools for Europeans and half-castes in the towns, but there is no provision for the education of the children of settlers in the out-districts. By an

ordinance of 1890 provision was made for the constitution of school boards, and the principle was first applied in Suva and Levuka. The missions have established schools in every native village, and most natives are able to read and write their own language. The government has established a native technical school for the teaching of useful handicrafts. The natives show themselves very slow in adopting European habits in food, clothing and house-building.

History.—A few islands in the north-east of the group were first seen by Abel Tasman in 1643. The southernmost of the group, Turtle Island, was discovered by Cook in 1773. Lieutenant Bligh, approaching them in the launch of the "Bounty," 1789, had a hostile encounter with natives. In 1827 Dumont d'Urville in the "Astrolabe" surveyed them much more accurately, but the first thorough survey was that of the United States exploring expedition in 1840. Up to this time, owing to the evil reputation of the islanders, European intercourse was very limited. The labours of the Wesleyan missionaries, however, must always have a prominent place in any history of Fiji. They came from Tonga in 1835 and naturally settled first in the eastern islands, where the Tongan element, already familiar to them, preponderated. They perhaps identified themselves too closely with their Tongan friends, whose dissolute, lawless, tyrannical conduct led to much mischief; but it should not be forgotten that their position was difficult, and it was mainly through their efforts that many terrible heathen practices were stamped out.

About 1804 some escaped convicts from Australia and runaway sailors established themselves around the east part of Viti Levu, and by lending their services to the neighbouring chiefs probably led to their preponderance over the rest of the group. Na Ulivau, chief of the small island of Mbau, established before his death in 1829 a sort of supremacy, which was extended by his brother Tanoa, and by Tanoa's son Thakombau, a ruler of considerable capacity. In his time, however, difficulties thickened. The Tongans, who had long frequented Fiji (especially for canoe-building, their own islands being deficient in timber), now came in larger numbers, led by an able and ambitious chief, Maafu, who, by adroitly taking part in Fijian quarrels, made himself chief in the Windward group, threatening Thakombau's supremacy. He was harassed, too, by an arbitrary demand for £9000 from the American government, for alleged injuries to their consul. Several chiefs who disputed his authority were crushed by the aid of King George of Tonga, who (1855) had opportunely arrived on a visit; but he afterwards, taking some offence, demanded £12,000 for his services. At last Thakombau, disappointed in the hope that his acceptance of Christianity (1854) would improve his position, offered the sovereignty to Great Britain (1859) with the fee simple of 100,000 acres, on condition of her paying the American claims. Colonel Smythe, R.A., was sent out to report on the question, and decided against annexation, but advised that the British consul should be invested with full magisterial powers over his countrymen, a step which would have averted much subsequent difficulty.

Meanwhile Dr B. Seemann's favourable report on the capabilities of the islands, followed by a time of depression in Australia and New Zealand, led to a rapid increase of settlers—from 200 in 1860 to 1800 in 1869. This produced fresh complications, and an increasing desire among the respectable settlers for a competent civil and criminal jurisdiction. Attempts were made at self-government, and the sovereignty was again offered, conditionally, to England, and to the United States. Finally, in 1871, a "constitutional government" was formed by certain Englishmen under King Thakombau; but this, after incurring heavy debt, and promoting the welfare of neither whites nor natives, came after three years to a deadlock, and the British government felt obliged, in the interest of all parties, to accept the unconditional cession now offered (1874). It had besides long been thought desirable to possess a station on the route between Australia and Panama; it was also felt that the Polynesian labour traffic, the abuses in which had caused much indignation, could only be effectually regulated from a point contiguous to the recruiting field, and the locality where that

labour was extensively employed. To this end the governor of Fiji was also created "high commissioner for the western Pacific." Rotumah (*q.v.*) was annexed in 1881.

At the time of the British annexation the islands were suffering from commercial depression, following a fall in the price of cotton after the American Civil War. Coffee, tea, cinchona and sugar were tried in turn, with limited success. The coffee was attacked by the leaf disease; the tea could not compete with that grown by the cheap labour of the East; the sugar machinery was too antiquated to withstand the fall in prices consequent on the European sugar bounties. In 1878 the first coolies were imported from India and the cultivation of sugar began to pass into the hands of large companies working with modern machinery. With the introduction of coolies the Fijians began to fall behind in the development of their country. Many of the coolies chose to remain in the colony after the termination of their indentures, and began to displace the European country traders. With a regular and plentiful supply of Indian coolies, the recruiting of *kanaka* labourers practically ceased. The settlement of European land claims, and the measures taken for the protection of native institutions, caused lively dissatisfaction among the colonists, who laid the blame of the commercial depression at the door of the government; but with returning prosperity this feeling began to disappear. In 1900 the government of New Zealand made overtures to absorb Fiji. The Aborigines Society protested to the colonial office, and the imperial government refused to sanction the proposal.

See Smyth, *Ten Months in the Fiji Islands* (London, 1864); B. Seemann, *Flora Vitiensis* (London, 1865); and *Viti: Account of a Government Mission in the Vitian or Fijian Islands* (1860-1861); W. T. Pritchard, *Polynesian Reminiscences* (London, 1866); H. Forbes, *Two Years in Fiji* (London, 1875); Commodore Goodenough, *Journal* (London, 1876); H. N. Moseley, *Notes of a Naturalist in the "Challenger"* (London, 1879); Sir A. H. Gordon, *Story of a Little War* (Edinburgh, privately printed, 1879); J. W. Anderson, *Fiji and New Caledonia* (London, 1880); C. F. Gordon-Cumming, *At Home in Fiji* (Edinburgh, 1881); John Horne, *A Year in Fiji* (London, 1881); H. S. Cooper, *Our New Colony, Fiji* (London, 1882); S. E. Scholes, *Fiji and the Friendly Islands* (London, 1882); Princes Albert Victor and George of Wales, *Cruise of H. M. S. "Bacchante"* (London, 1886); A. Agassiz, *The Islands and Coral Reefs of Fiji* (Cambridge, Mass., U.S., 1899); H. B. Guppy, *Observations of a Naturalist in the Pacific* (1896-1899), vol. i.; *Vanua Levu, Fiji* (Phys. Geog. and Geology) (London, 1903); Lorimer Fison, *Tales from Old Fiji* (folk-lore, &c.) (London, 1904); B. Thomson, *The Fijians* (London, 1908).

FILANDER, the name by which the Aru Island wallaby (*Macropus brunii*) was first described. It occurs in a translation of C. de Bruyn's *Travels* (ii. 101) published in 1737.

FILANGIERI, CARLO (1784-1867), prince of Satriano, Neapolitan soldier and statesman, was the son of Gaetano Filangieri (1752-1788), a celebrated philosopher and jurist. At the age of fifteen he decided on a military career, and having obtained an introduction to Napoleon Bonaparte, then first consul, was admitted to the Military Academy at Paris. In 1803 he received a commission in an infantry regiment, and took part in the campaign of 1805 under General Davoust, first in the Low Countries, and later at Ulm, Maria Zell and Austerlitz, where he fought with distinction, was wounded several times and promoted. He returned to Naples as captain on Masséna's staff to fight the Bourbons and the Austrians in 1806, and subsequently went to Spain, where he followed Jerome Bonaparte in his retreat from Madrid. In consequence of a fatal duel he was sent back to Naples; there he served under Joachim Murat with the rank of general, and fought against the Anglo-Sicilian forces in Calabria and at Messina. On the fall of Napoleon he took part in Murat's campaign against Eugène Beauharnais, and later in that against Austria, and was severely wounded at the battle of the Panaro (1815). On the restoration of the Bourbon king Ferdinand IV. (I.), Filangieri retained his rank and command, but found the army utterly disorganized and impregnated with Carbonarism. In the disturbances of 1820 he adhered to the Constitutionalist party, and fought under General Pepe (*q.v.*) against the Austrians. On the re-establishment of the autocracy he was dismissed from the

service, and retired to Calabria where he had inherited the princely title and estates of Satriano. In 1831 he was recalled by Ferdinand II. and entrusted with various military reforms. On the outbreak of the troubles of 1848 Filangieri advised the king to grant the constitution, which he did in February 1848, but when the Sicilians formally seceded from the Neapolitan kingdom Filangieri was given the command of an armed force with which to reduce the island to obedience. On the 3rd of September he landed near Messina, and after very severe fighting captured the city. He then advanced southwards, besieged and took Catania, where his troops committed many atrocities, and by May 1849 he had conquered the whole of Sicily, though not without much bloodshed. He remained in Sicily as governor until 1855, when he retired into private life, as he could not carry out the reforms he desired owing to the hostility of Giovanni Cassisi, the minister for Sicily. On the death of Ferdinand II. (22nd of May 1859) the new king Francis II. appointed Filangieri premier and minister of war. He promoted good relations with France, then fighting with Piedmont against the Austrians in Lombardy, and strongly urged on the king the necessity of an alliance with Piedmont and a constitution as the only means whereby the dynasty might be saved. These proposals being rejected, Filangieri resigned office. In May 1860, Francis at last promulgated the constitution, but it was too late, for Garibaldi was in Sicily and Naples was seething with rebellion. On the advice of Liborio Romano, the new prefect of police, Filangieri was ordered to leave Naples. He went to Marseilles with his wife and subsequently to Florence, where at the instance of General La Marmora he undertook to write an account of the Italian army. Although he adhered to the new government he refused to accept any dignity at its hands, and died at his villa of San Giorgio a Cremano near Naples on the 9th of October 1867.

Filangieri was a very distinguished soldier, and a man of great ability; although he changed sides several times he became really attached to the Bourbon dynasty, which he hoped to save by freeing it from its reactionary tendencies and infusing a new spirit into it. His conduct in Sicily was severe and harsh, but he was not without feelings of humanity, and he was an honest man and a good administrator.

His biography has been written by his daughter Teresa Filangieri Fieschi-Ravaschieri, *Il Generale Carlo Filangieri* (Milan, 1902), an interesting, although somewhat too laudatory volume based on the general's own unpublished memoirs; for the Sicilian expedition see V. Finocchiaro, *La Rivoluzione siciliana del 1848-49* (Catania, 1906, with bibliography), in which Filangieri is bitterly attacked; see also under NAPLES; FERDINAND IV.; FRANCIS I.; FERDINAND II.; FRANCIS II. (L. V.)*

FILANGIERI, GAETANO (1752-1788), Italian publicist, was born at Naples on the 18th of August 1752. His father, Caesar, prince of Arianiello, intended him for a military career, which he commenced at the early age of seven, but soon abandoned for the study of the law. At the bar his knowledge and eloquence early secured his success, while his defence of a royal decree reforming abuses in the administration of justice gained him the favour of the king, Charles, afterwards Charles III. of Spain, and led to several honourable appointments at court. The first two books of his great work, *La Scienza della legislazione*, appeared in 1780. The first book contained an exposition of the rules on which legislation in general ought to proceed, while the second was devoted to economic questions. These two books showed him an ardent reformer, and vehement in denouncing the abuses of his time. He insisted on unlimited free trade, and the abolition of the medieval institutions which impeded production and national well-being. Its success was great and immediate not only in Italy, but throughout Europe at large. In 1783 he married, resigned his appointments at court, and retiring to Cava, devoted himself steadily to the completion of his work. In the same year appeared the third book, relating entirely to the principles of criminal jurisprudence. The suggestion which he made in it as to the need for reform in the Roman Catholic church brought upon him the censure of the ecclesiastical authorities, and it was condemned by the Index in 1784. In 1785 he

published three additional volumes, making the fourth book of the projected work, and dealing with education and morals. In 1787 he was appointed a member of the supreme treasury council by Ferdinand IV., but his health, impaired by close study and over-work in his new office, compelled his withdrawal to the country at Vico Equense. He died somewhat suddenly on the 21st of July 1788, having just completed the first part of the fifth book of his *Scienza*. He left an outline of the remainder of the work, which was to have been completed in six books.

La Scienza della legislazione has gone through many editions, and has been translated into most of the languages of Europe. The best Italian edition is in 5 vols. 8vo. (1807). The Milan edition (1822) contains the *Opusculi scelti* and a life by Donato Tommasi. A French translation appeared in Paris in 7 vols. 8vo (1786-1798); it was republished in 1822-1824, with the addition of the *Opuscles* and notes by Benjamin Constant. *The Science of Legislation* was translated into English by Sir R. Clayton (London, 1806).

FILARIASIS, the name of a disease due to the nematode *Filaria sanguinis hominis*. A milky appearance of the urine, due to the presence of a substance like chyle, which forms a clot, had been observed from time to time, especially in tropical and subtropical countries; and it was proved by Dr Wucherer of Bahia, and by Dr Timothy Lewis, that this peculiar condition is uniformly associated with the presence in the blood of minute eel-like worms, visible only under the microscope, being the embryo forms of a *Filaria* (see NEMATODA). Sometimes the discharge of lymph takes place at one or more points of the surface of the body, and there is in other cases a condition of naevoid elephantiasis of the scrotum, or lymph-scrotum. More or less of blood may occur along with the chylous fluid in the urine. Both the chyluria and the presence of filariae in the blood are curiously intermittent; it may happen that not a single filaria is to be seen during the daytime, while they swarm in the blood at night, and it has been ingeniously shown by Dr S. Mackenzie that they may be made to disappear if the patient sits up all night, reappearing while he sleeps through the day.

Sir P. Manson proved that mosquitoes imbibe the embryo filariae from the blood of man; and that many of these reach full development within the mosquito, acquiring their freedom when the latter resorts to water, where it dies after depositing its eggs. Mosquitoes would thus be the intermediate host of the filariae, and their introduction into the human body would be through the medium of water (see PARASITIC DISEASES).

FILDES, SIR LUKE (1844-), English painter, was born at Liverpool, and trained in the South Kensington and Royal Academy schools. At first a highly successful illustrator, he took rank later among the ablest English painters, with "The Casual Ward" (1874), "The Widower" (1876), "The Village Wedding" (1883), "An Al-fresco Toilette" (1889); and "The Doctor" (1891), now in the National Gallery of British Art. He also painted a number of pictures of Venetian life and many notable portraits, among them the coronation portraits of King Edward VII. and Queen Alexandra. He was elected an associate of the Royal Academy in 1879, and academician in 1887; and was knighted in 1906.

See David Croal Thomson, *The Life and Work of Luke Fildes, R.A.* (1895).

FILE. 1. A bar of steel having sharp teeth on its surface, and used for abrading or smoothing hard surfaces. (The O. Eng. word is *ffol*, and cognate forms appear in Dutch *vijl*, Ger. *Feile*, &c.; the ultimate source is usually taken to be an Indo-European root meaning to mark or scratch, and seen in the Lat. *pingere*, to paint.) Some uncivilized tribes polish their weapons with such things as rough stones, pieces of shark skin or fishes' teeth. The operation of filing is recorded in 1 Sam. xiii. 21; and, among other facts, the similarity of the name for the filing instrument among various European peoples points to an early practice of the art. A file differs from a rasp (which is chiefly used for working wood, horn and the like) in having its teeth cut with a chisel whose straight edge extends across its surface, while the teeth of the rasp are formed by solitary indentations of a pointed chisel. According to the form of their teeth, files may be *single-cut* or *double-cut*; the former have only one set of parallel ridges

(either at right angles or at some other angle with the length); the latter (and more common) have a second set cut at an angle with the first. The double-cut file presents sharp angles to the filed surface, and is better suited for hard metals. Files are classed according to the fineness of their teeth (see TOOL), and their shapes present almost endless varieties. Common forms are—the *flat* file, of parallelogram section, with uniform breadth and thickness, or tapering, or “bellied”; the *four-square* file, of square section, sometimes with one side “safe,” or left smooth; and the so-called *three-square* file, having its cross section an equilateral triangle, the *half-round* file, a segment of a circle, the *round* or *rat-tail* file, a circle, which are generally tapered. The *float* file is like the *flat*, but single-cut. There are many others. Files vary in length from three-quarters of an inch (watchmakers’) to 2 or 3 ft. and upwards (engineers’). The length is reckoned exclusively of the spike or tang which enters the handle. Most files are tapered; the *blunt* are nearly parallel, with larger section near the middle; a few are parallel. The *rifflers* of sculptors and a few other files are curvilinear in their central line.

In manufacturing files, steel blanks are forged from bars which have been sheared or rolled as nearly as possible to the sections required, and after being carefully annealed are straightened, if necessary, and then rendered clean and accurate by grinding or filing. The process of cutting them used to be largely performed by hand, but machines are now widely employed. The hand-cutter, holding in his left hand a short chisel (the edge of which is wider than the width of the file), places it on the blank with an inclination from the perpendicular of 12° or 14°, and beginning near the farther end (the blank is placed with the tang or handle end towards him) strikes it sharply with a hammer. An indentation is thus made, and the steel, slightly thrown up on the side next the tang, forms a ridge. The chisel is then transferred to the uncut surface and slid away from the operator till it encounters the ridge just made; the position of the next cut being thus determined, the chisel is again struck, and so on. The workman seeks to strike the blows as uniformly as possible, and he will make 60 or 80 cuts a minute. If the file is to be single-cut, it is now ready to be hardened, but if it is to be double-cut he proceeds to make the second series or course of cuts, which are generally somewhat finer than the first. Thus the surface is covered with teeth inclined towards the point of the file. If the file is flat and is to be cut on the other side, it is turned over, and a thin plate of pewter placed below it to protect the teeth. Triangular and other files are supported in grooves in lead. In cutting round and half-round files, a straight chisel is applied as tangent to the curve. The round face of a half-round file requires eight, ten or more courses to complete it. Numerous attempts were made, even so far back as the 18th century, to invent machinery for cutting files, but little success was attained till the latter part of the 19th century. In most of the machines the idea was to arrange a metal arm and hand to hold the chisel with a hammer to strike the blow, and so to imitate the manual process as closely as possible. The general principle on which the successful forms are constructed is that the blanks, laid on a moving table, are slowly traversed forward under a rapidly reciprocating chisel or knife.

The filing of a flat surface perfectly true is the test of a good filer; and this is no easy matter to the beginner. The piece to be operated upon is generally fixed about the level of the elbow, the operator standing, and, except in the case of small files, grasping the file with both hands, the handle with the right, the farther end with the left. The great point is to be able to move the file forward with pressure in horizontal straight lines; from the tendency of the hands to move in arcs of circles, the heel and point of the file are apt to be alternately raised. This is partially compensated by the bellied form given to many files (which also counteracts the frequent warping effect of the hardening process, by which one side of a flat file may be rendered concave and useless). In bringing back the file for the next thrust it is nearly lifted off the work. Further, much delicacy and skill are required in adapting the pressure and velocity, ascertaining if foreign matters or filings remain interposed

between the file and the work, &c. Files can be cleaned with a piece of the so-called *cotton-card* (used in combing cotton wool) nailed to a piece of wood. In *draw-filing*, which is sometimes resorted to to give a neat finish, the file is drawn sideways to and fro over the work. New files are generally used for a time on brass or cast-iron, and when partially worn they are still available for filing wrought iron and steel.

2. A string or thread (through the Fr. *fil* and *file*, from Lat. *filum*, a thread); hence used of a device, originally a cord, wire or spike on which letters, receipts, papers, &c., may be strung for convenient reference. The term has been extended to embrace various methods for the preservation of papers in a particular order, such as expanding books, cabinets, and ingenious improvements on the simple wire file which enable any single document to be readily found and withdrawn without removing the whole series. From the devices used for filing the word is transferred to the documents filed, and thus is used of a catalogue, list, or collection of papers, &c. File is also employed to denote a row of persons or objects arranged one behind the other. In military usage a “file” is the opposite of a “rank,” that is, it is composed of a (variable) number of men aligned from front to rear one behind the other, while a rank contains a number of men aligned from right to left abreast. Thus a British infantry company, in line two deep, one hundred strong, has two ranks of fifty men each, and fifty “files” of two men each. Up to about 1600 infantry companies or battalions were often sixteen deep, one front rank man and the fifteen “coverers” forming a file. The number of ranks and, therefore, of men in the file diminished first to ten (1600), then to six (1630), then to three (1700), and finally to two (about 1808 in the British army, 1888 in the German). Denser formations when employed have been formed, not by altering the order of men within the unit, but by placing several units, one closely behind the other (“doubling” and “trebling” the line of battle, as it used to be called). In the 17th century a file formed a small command under the “file leader,” the whole of the front rank consisting therefore of old soldiers or non-commissioned officers. This use of the word to express a unit of command gave rise to the old-fashioned term “file firing,” to imply a species of fire (equivalent to the modern “independent”) in which each man in the file fired in succession after the file leader, and to-day a corporal or sergeant is still ordered to take one or more files under his charge for independent work. In the above it is to be understood that the men are facing to the front or rear. If they are turned to the right or left so that the company now stands two men broad and fifty deep, it is spoken of as being “in file.” From this come such phrases as “single file” or “Indian file” (one man leading and the rest following singly behind him).¹ The use of verbs “to file” and “to defile,” implying the passage from fighting to marching formation, is to be derived from this rather than from the resemblance of a marching column to a long flexible thread, for in the days when the word was first used the infantry company whether in battle or on the march was a solid rectangle of men, a file often containing even more men than a rank.

FILE-FISH, or **TRIGGER-FISH**, the names given to fishes of the genus *Balistes* (and *Monacanthus*) inhabiting all tropical and subtropical seas. Their body is compressed and not covered with ordinary scales, but with small juxtaposed scutes. Their other principal characteristics consist in the structure of their first dorsal fin (which consists of three spines) and in their peculiar dentition. The first of the three dorsal spines is very strong, roughened in front like a file, and hollowed out behind to receive the second much smaller spine, which, besides, has a projection in front, at its base, fitting into a notch of the first. Thus these two spines can only be raised or depressed simultaneously, in such a manner that the first cannot be forced down unless the second has been previously depressed. The latter has been compared to a trigger, hence the name of Trigger-fish. Also the

¹ This may also be understood as meaning simply “a single file,” but the explanation given above is more probable, as it is essentially a marching and not a fighting formation that is expressed by the phrase.

generic name *Balistes* and the Italian name of "Pesce balistra" refer to this structure. Both jaws are armed with eight strong incisor-like and sometimes pointed teeth, by which these fishes are enabled, not only to break off pieces of madrepores and other corals on which they feed, but also to chisel a hole into the hard shells of Mollusca, in order to extract the soft parts. In this way they destroy an immense number of molluscs, and become most injurious to the pearl-fisheries. The gradual failure of those

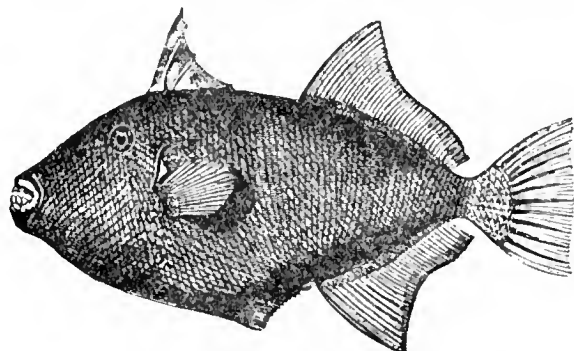

Balistes vidua.

fisheries in Ceylon has been ascribed to this cause, although evidently other agencies must have been at work at the same time. The *Monacanthi* are distinguished from the *Balistes* in having only one dorsal spine and a velvety covering of the skin. Some 30 different species are known of *Balistes* and about 50 of *Monacanthus*. Two species (*B. maculatus* and *capricus*), common in the Atlantic, sometimes wander to the British coasts.

FILELFO, FRANCESCO (1398-1481), Italian humanist, was born in 1398 at Tolentino, in the March of Ancona. When he appeared upon the scene of human life, Petrarch and the students of Florence had already brought the first act in the recovery of classic culture to conclusion. They had created an eager appetite for the antique, had disinterred many important Roman authors, and had freed Latin scholarship to some extent from the barbarism of the middle ages. Filelfo was destined to carry on their work in the field of Latin literature, and to be an important agent in the still unaccomplished recovery of Greek culture. His earliest studies in grammar, rhetoric and the Latin language were conducted at Padua, where he acquired so great a reputation for learning that in 1417 he was invited to teach eloquence and moral philosophy at Venice. According to the custom of that age in Italy, it now became his duty to explain the language, and to illustrate the beauties of the principal Latin authors, Cicero and Virgil being considered the chief masters of moral science and of elegant diction. Filelfo made his mark at once in Venice. He was admitted to the society of the first scholars and the most eminent nobles of that city; and in 1419 he received an appointment from the state, which enabled him to reside as secretary to the consul-general (*baylo*) of the Venetians in Constantinople. This appointment was not only honourable to Filelfo as a man of trust and general ability, but it also gave him the opportunity of acquiring the most coveted of all possessions at that moment for a scholar—a knowledge of the Greek language. Immediately after his arrival in Constantinople, Filelfo placed himself under the tuition of John Chrysoloras, whose name was already well known in Italy as relative of Manuel, the first Greek to profess the literature of his ancestors in Florence. At the recommendation of Chrysoloras he was employed in several diplomatic missions by the emperor John Palaeologus. Before very long the friendship between Filelfo and his tutor was cemented by the marriage of the former to Theodora, the daughter of John Chrysoloras. He had now acquired a thorough knowledge of the Greek language, and had formed a large collection of Greek manuscripts. There was no reason why he should not return to his native country. Accordingly, in 1427 he accepted an invitation from the republic of Venice, and set sail for Italy, intending to resume his professorial career. From this

time forward until the date of his death, Filelfo's history consists of a record of the various towns in which he lectured, the masters whom he served, the books he wrote, the authors he illustrated, the friendships he contracted, and the wars he waged with rival scholars. He was a man of vast physical energy, of inexhaustible mental activity, of quick passions and violent appetites; vain, restless, greedy of gold and pleasure and fame; unable to stay quiet in one place, and perpetually engaged in quarrels with his compeers.

When Filelfo arrived at Venice with his family in 1427, he found that the city had almost been emptied by the plague, and that his scholars would be few. He therefore removed to Bologna; but here also he was met with drawbacks. The city was too much disturbed with political dissensions to attend to him; so Filelfo crossed the Apennines and settled in Florence. At Florence began one of the most brilliant and eventful periods of his life. During the week he lectured to large audiences of young and old on the principal Greek and Latin authors, and on Sundays he explained Dante to the people in the Duomo. In addition to these labours of the chair, he found time to translate portions of Aristotle, Plutarch, Xenophon and Lysias from the Greek. Nor was he dead to the claims of society. At first he seems to have lived with the Florentine scholars on tolerably good terms; but his temper was so arrogant that Cosimo de' Medici's friends were not long able to put up with him. Filelfo hereupon broke out into open and violent animosity; and when Cosimo was exiled by the Albizzi party in 1433, he urged the signoria of Florence to pronounce upon him the sentence of death. On the return of Cosimo to Florence, Filelfo's position in that city was no longer tenable. His life, he asserted, had been already once attempted by a cut-throat in the pay of the Medici; and now he readily accepted an invitation from the state of Siena. In Siena, however, he was not destined to remain more than four years. His fame as a professor had grown great in Italy, and he daily received tempting offers from princes and republics. The most alluring of these, made him by the duke of Milan, Filippo Maria Visconti, he decided on accepting; and in 1440 he was received with honour by his new master in the capital of Lombardy.

Filelfo's life at Milan curiously illustrates the multifarious importance of the scholars of that age in Italy. It was his duty to celebrate his princely patrons in panegyrics and epics, to abuse their enemies in libels and invectives, to salute them with encomiastic odes on their birthdays, and to compose poems on their favourite themes. For their courtiers he wrote epithalamial and funeral orations; ambassadors and visitors from foreign states he greeted with the rhetorical lucubrations then so much in vogue. The students of the university he taught in daily lectures, passing in review the weightiest and lightest authors of antiquity, and pouring forth a flood of miscellaneous erudition. No satisfied with these outlets for his mental energy, Filelfo went on translating from the Greek, and prosecuted a paper warfare with his enemies in Florence. He wrote, moreover, political pamphlets on the great events of Italian history; and when Constantinople was taken by the Turks, he procured the liberation of his wife's mother by a message addressed in his own name to the sultan. In addition to a fixed stipend of some 700 golden florins yearly, he was continually in receipt of special payments for the orations and poems he produced; so that, had he been a man of frugal habits or of moderate economy, he might have amassed a considerable fortune. As it was, he spent his money as fast as he received it, living in a style of splendour ill befitting a simple scholar, and indulging his taste for pleasure in more than questionable amusements. In consequence of this prodigality, he was always poor. His letters and his poems abound in impudent demands for money from patrons, some of them couched in language of the lowest adulation, and others savouring of literary brigandage.

During the second year of his Milanese residence Filelfo lost his first wife, Theodora. He soon married again; and this time he chose for his bride a young lady of good Lombard family, called Orsina Osnaga. When she died he took in wedlock for

the third time a woman of Lombard birth, Laura Magiolini. To all his three wives, in spite of numerous infidelities, he seems to have been warmly attached; and this is perhaps the best trait in a character otherwise more remarkable for arrogance and heat than for any amiable qualities.

On the death of Filippo Maria Visconti, Filelfo, after a short hesitation, transferred his allegiance to Francesco Sforza, the new duke of Milan; and in order to curry favour with this parvenu, he began his ponderous epic, the *Sforziad*, of which 12,800 lines were written, but which was never published. When Francesco Sforza died, Filelfo turned his thoughts towards Rome. He was now an old man of seventy-seven years, honoured with the friendship of princes, recognized as the most distinguished of Italian humanists, courted by pontiffs, and decorated with the laurel wreath and the order of knighthood by kings. Crossing the Apennines and passing through Florence, he reached Rome in the second week of 1475. The terrible Sixtus IV. now ruled in the Vatican; and from this pope Filelfo had received an invitation to occupy the chair of rhetoric with good emoluments. At first he was vastly pleased with the city and court of Rome; but his satisfaction ere long turned to discontent, and he gave vent to his ill-humour in a venomous satire on the pope's treasurer, Milliardo Cicala. Sixtus himself soon fell under the ban of his displeasure; and when a year had passed he left Rome never to return. Filelfo reached Milan to find that his wife had died of the plague in his absence, and was already buried. His own death followed speedily. For some time past he had been desirous of displaying his abilities and adding to his fame in Florence. Years had healed the breach between him and the Medicean family; and on the occasion of the Pazzi conspiracy against the life of Lorenzo de' Medici, he had sent violent letters of abuse to his papal patron Sixtus, denouncing his participation in a plot so dangerous to the security of Italy. Lorenzo now invited him to profess Greek at Florence, and thither Filelfo journeyed in 1481. But two weeks after his arrival he succumbed to dysentery, and was buried at the age of eighty-three in the church of the Annunziata.

Filelfo deserves commemoration among the greatest humanists of the Italian Renaissance, not for the beauty of his style, not for the elevation of his genius, not for the accuracy of his learning, but for his energy, and for his complete adaptation to the times in which he lived. His erudition was large but ill-digested; his knowledge of the ancient authors, if extensive, was superficial; his style was vulgar; he had no brilliancy of imagination, no pungency of epigram, no grandeur of rhetoric. Therefore he has left nothing to posterity which the world would not very willingly let die. But in his own days he did excellent service to learning by his untiring activity, and by the facility with which he used his stores of knowledge. It was an age of accumulation and preparation, when the world was still amassing and cataloguing the fragments rescued from the wrecks of Greece and Rome. Men had to receive the very rudiments of culture before they could appreciate its niceties. And in this work of collection and instruction Filelfo excelled, passing rapidly from place to place, stirring up the zeal for learning by the passion of his own enthusiastic temperament, and acting as a pioneer for men like Poliziano and Erasmus.

All that is worth knowing about Filelfo is contained in Carlo de' Rosmini's admirable *Vita di Filelfo* (Milan, 1808); see also W. Roscoe's *Life of Lorenzo de' Medici*, Vespasiano's *Vite di uomini illustri*, and J. A. Symonds's *Renaissance in Italy* (1877).

(J. A. S.)

A complete edition of Filelfo's Greek letters (based on the Codex Trevulzianus) was published for the first time, with French translation, notes and commentaries, by E. Legrand in 1892 at Paris (C. xii. of *Publications de l'école des lang. orient.*). For further references, especially to monographs, &c., on Filelfo's life and work, see Ulysse Chevalier, *Répertoire des sources hist., bio-bibliographie* (Paris, 1905), s. v. *Philippe, François*.

FILEY, a seaside resort in the Buckrose parliamentary division of the East Riding of Yorkshire, England, 9½ m. S.E. of Scarborough by a branch of the North Eastern railway. Pop. of urban district (1901) 3003. It stands upon the slope and summit of the cliffs above Filey Bay, which is fringed by a fine

sandy beach. The northern horn of the bay is formed by Filey Brigg, a narrow and abrupt promontory, continued seaward by dangerous reefs. The coast-line sweeps hence south-eastward to the finer promontory of Flamborough Head, beyond which is the watering-place of Bridlington. The church of St Oswald at Filey is a fine cruciform building with central tower, Transitional Norman and Early English in date. There are pleasant promenades and good golf links, also a small spa which has fallen into disuse. Filey is in favour with visitors who desire a quiet resort without the accompaniment of entertainment common to the larger watering-places. Roman remains have been discovered on the cliff north of the town; the site was probably important, but nothing is certainly known about it.

FILIBUSTER, a name originally given to the buccaneers (*q.v.*). The term is derived most probably from the Dutch *vry buiter*, Ger. *Freibeuter*, Eng. *freebooter*, the word changing first into *fribustier*, and then into Fr. *fibustier*, Span. *filibustero*. *Flibustier* has passed into the French language, and *filibustero* into the Spanish language, as a general name for a pirate. The term "filibuster" was revived in America to designate those adventurers who, after the termination of the war between Mexico and the United States, organized expeditions within the United States to take part in West Indian and Central American revolutions. From this has sprung the modern use of the word to imply one who engages in private, unauthorized and irregular warfare against any state. In the United States it is colloquially applied to legislators who practise obstruction.

FILICAJA, VINCENZO DA (1642-1707), Italian poet, sprung from an ancient and noble family of Florence, was born in that city on the 30th of December 1642. From an incidental notice in one of his letters, stating the amount of house rent paid during his childhood, his parents must have been in easy circumstances, and the supposition is confirmed by the fact that he enjoyed all the advantages of a liberal education, first under the Jesuits of Florence, and then in the university of Pisa.

At Pisa his mind became stored, not only with the results of patient study in various branches of letters, but with the great historical associations linked with the former glory of the Pisan republic, and with one remarkable institution of which Pisa was the seat. To the tourist who now visits Pisa the banners and emblems of the order of St Stephen are mere matter of curiosity, but they had a serious significance two hundred years ago to the young Tuscan, who knew that these naval crusaders formed the main defence of his country and commerce against the Turkish, Algerine and Tunisian corsairs. After a five years' residence in Pisa he returned to Florence, where he married Anna, daughter of the senator and marquis Scipione Capponi, and withdrew to a small villa at Figline, not far from the city. Abjuring the thought of writing amatory poetry in consequence of the premature death of a young lady to whom he had been attached, he occupied himself chiefly with literary pursuits, above all the composition of Italian and Latin poetry. His own literary eminence, the opportunities enjoyed by him as a member of the celebrated Academy Della Crusca for making known his critical taste and classical knowledge, and the social relations within the reach of a noble Florentine so closely allied with the great house of Capponi, sufficiently explain the intimate terms on which he stood with such eminent men of letters as Magalotti, Menzini, Gori and Redi. The last-named, the author of *Bacchus in Tuscany*, was not only one of the most brilliant poets of his time, and a safe literary adviser; he was the court physician, and his court influence was employed with zeal and effect in his friend's favour. Filicaja's rural seclusion was owing even more to his straitened means than to his rural tastes. If he ceased at length to pine in obscurity, the change was owing not merely to the fact that his poetical genius, fired by the deliverance of Vienna from the Turks in 1683, poured forth the right strains at the right time, but also to the influence of Redi, who not only laid Filicaja's verses before his own sovereign, but had them transmitted with the least possible delay to the foreign princes whose noble deeds they sung. The first recompense came, however, not from those princes, but from Christina, the ex-queen of Sweden, who, from her circle of savants and

courtiers at Rome, spontaneously and generously announced to Filicaja her wish to bear the expense of educating his two sons, enhancing her kindness by the delicate request that it should remain a secret.

The tide of Filicaja's fortunes now turned. The grand-duke of Tuscany, Cosmo III., conferred on him an important office, the commissionership of official balloting. He was named governor of Volterra in 1696, where he strenuously exerted himself to raise the tone of public morality. Both there and at Pisa, where he was subsequently governor in 1700, his popularity was so great that on his removal the inhabitants of both cities petitioned for his recall. He passed the close of his life at Florence; the grand-duke raised him to the rank of senator, and he died in that city on the 24th of September 1707. He was buried in the family vault in the church of St Peter, and a monument was erected to his memory by his sole surviving son Scipione Filicaja. In the six celebrated odes inspired by the great victory of Sobieski, Filicaja took a lyrical flight which has placed him at moments on a level with the greatest Italian poets. They are, however, unequal, like all his poetry, reflecting in some passages the native vigour of his genius and purest inspirations of his tastes, whilst in others they are deformed by the affectations of the *Seicentisti*. When thoroughly natural and spontaneous—as in the two sonnets "Italia, Italia, o tu cui feo la sorte" and "Dov' è, Italia, il tuo braccio? e a che ti serve;" in the verses "Alla beata Vergine," "Al divino amore;" in the sonnet "Sulla fede nelle disgrazie"—the truth and beauty of thought and language recall the verse of Petrarch.

Besides the poems published in the complete Venice edition of 1762, several other pieces appeared for the first time in the small Florence edition brought out by Barbera in 1864.

FILIGREE (formerly written *filigrain* or *filigrane*; the Ital. *filigrana*, Fr. *filigrane*, Span. *filigrana*, Ger. *Drahtgestecht*), jewel work of a delicate kind made with twisted threads usually of gold and silver. The word, which is usually derived from the Lat. *filum*, thread, and *granum*, grain, is not found in Ducange, and is indeed of modern origin. According to Prof. Skeat it is derived from the Span. *filigrana*, from "*filar*, to spin, and *grano*, the grain or principal fibre of the material." Though filigree has become a special branch of jewel work in modern times it was anciently part of the ordinary work of the jeweller. Signor A. Castellani states, in his *Memoir on the Jewellery of the Ancients* (1861), that all the jewellery of the Etruscans and Greeks (other than that intended for the grave, and therefore of an unsubstantial character) was made by soldering together and so building up the gold rather than by chiselling or engraving the material.

The art may be said to consist in curling, twisting and plaiting fine pliable threads of metal, and uniting them at their points of contact with each other, and with the ground, by means of gold or silver solder and borax, by the help of the blowpipe. Small grains or beads of the same metals are often set in the eyes of volutes, on the junctions, or at intervals at which they will set off the wire-work effectively. The more delicate work is generally protected by framework of stouter wire. Brooches, crosses, earrings and other personal ornaments of modern filigree are generally surrounded and subdivided by bands of square or flat metal, giving consistency to the filling up, which would not otherwise keep its proper shape. Some writers of repute have laid equal stress on the *filum* and the *granum*, and have extended the use of the term filigree to include the granulated work of the ancients, even where the twisted wire-work is entirely wanting. Such a wide application of the term is not approved by current usage, according to which the presence of the twisted threads is the predominant fact.

The Egyptian jewellers employed wire, both to lay down on a background and to plait or otherwise arrange *à jour*. But, with the exception of chains, it cannot be said that filigree work was much practised by them. Their strength lay rather in their cloisonné work and their moulded ornaments. Many examples, however, remain of round plaited gold chains of fine wire, such as are still made by the filigree workers of India, and known as Trichinopoly chains. From some of these are hung smaller

chains of finer wire with minute fishes and other pendants fastened to them. In ornaments derived from Phœnician sites, such as Cyprus and Sardinia, patterns of gold wire are laid down with great delicacy on a gold ground, but the art was advanced to its highest perfection in the Greek and Etruscan filigree of the 6th to the 3rd centuries B.C. A number of earrings and other personal ornaments found in central Italy are preserved in the Louvre and in the British Museum. Almost all of them are made of filigree work. Some earrings are in the form of flowers of geometric design, bordered by one or more rims each made up of minute volutes of gold wire, and this kind of ornament is varied by slight differences in the way of disposing the number or arrangement of the volutes. But the feathers and petals of modern Italian filigree are not seen in these ancient designs. Instances occur, but only rarely, in which filigree devices in wire are self-supporting and not applied to metal plates. The museum of the Hermitage at St Petersburg contains an amazingly rich collection of jewelry from the tombs of the Crimea. Many bracelets and necklaces in that collection are made of twisted wire, some in as many as seven rows of plaiting, with clasps in the shape of heads of animals of beaten work. Others are strings of large beads of gold, decorated with volutes, knots and other patterns of wire soldered over the surfaces. (See the *Antiquités du Bosphore Cimmérien*, by Gille, 1854; reissued by S. Reinach, 1892, in which will be found careful engravings of these objects.) In the British Museum a sceptre, probably that of a Greek priestess, is covered with plaited and netted gold wire, finished with a sort of Corinthian capital and a boss of green glass.

It is probable that in India and various parts of central Asia filigree has been worked from the most remote period without any change in the designs. Whether the Asiatic jewellers were influenced by the Greeks settled on that continent, or merely trained under traditions held in common with them, it is certain that the Indian filigree workers retain the same patterns as those of the ancient Greeks, and work them in the same way, down to the present day. Wandering workmen are given so much gold, coined or rough, which is weighed, heated in a pan of charcoal, beaten into wire, and then worked in the courtyard or verandah of the employer's house according to the designs of the artist, who weighs the complete work on restoring it and is paid at a specified rate for his labour. Very fine grains or beads and spines of gold, scarcely thicker than coarse hair, projecting from plates of gold are methods of ornamentation still used.

Passing to later times we may notice in many collections of medieval jewel work (such as that in the South Kensington Museum) reliquaries, covers for the gospels, &c., made either in Constantinople from the 6th to the 12th centuries, or in monasteries in Europe, in which Byzantine goldsmiths' work was studied and imitated. These objects, besides being enriched with precious stones, polished, but not cut into facets, and with enamel, are often decorated with filigree. Large surfaces of gold are sometimes covered with scrolls of filigree soldered on; and corner pieces of the borders of book covers, or the panels of reliquaries, are not unfrequently made up of complicated pieces of plaited work alternating with spaces encrusted with enamel. Byzantine filigree work occasionally has small stones set amongst the curves or knots. Examples of such decoration can be seen in the South Kensington and British Museums.

In the north of Europe the Saxons, Britons and Celts were from an early period skilful in several kinds of goldsmiths' work. Admirable examples of filigree patterns laid down in wire on gold, from Anglo-Saxon tombs, may be seen in the British Museum—notably a brooch from Dover, and a sword-hilt from Cumberland.

The Irish filigree work is more thoughtful in design and more varied in pattern than that of any period or country that could be named. Its highest perfection must be placed in the 10th and 11th centuries. The Royal Irish Academy in Dublin contains a number of reliquaries and personal jewels, of which filigree is the general and most remarkable ornament. The "Tara" brooch has been copied and imitated, and the shape and

decoration of it are well known. Instead of fine curls or volutes of gold thread, the Irish filigree is varied by numerous designs in which one thread can be traced through curious knots and complications, which, disposed over large surfaces, balance one another, but always with special varieties and arrangements difficult to trace with the eye. The long thread appears and disappears without breach of continuity, the two ends generally worked into the head and the tail of a serpent or a monster. The reliquary containing the "Bell of St Patrick" is covered with knotted work in many varieties. A two-handled chalice, called the "Ardagh cup," found near Limerick in 1868, is ornamented with work of this kind of extraordinary fineness. Twelve plaques on a band round the body of the vase, plaques on each handle and round the foot of the vase have a series of different designs of characteristic patterns, in fine filigree wire work wrought on the front of the repoussé ground. (See a paper by the 3rd earl of Dunraven in *Transactions of Royal Irish Academy*, xxiv. pt. iii. 1873.)

Much of the medieval jewel work all over Europe down to the 15th century, on reliquaries, crosses, croziers and other ecclesiastical goldsmiths' work, is set off with bosses and borders of filigree. Filigree work in silver was practised by the Moors of Spain during the middle ages with great skill, and was introduced by them and established all over the Peninsula, whence it was carried to the Spanish colonies in America. The Spanish filigree work of the 17th and 18th centuries is of extraordinary complexity (examples in the Victoria and Albert Museum), and silver filigree jewelry of delicate and artistic design is still made in considerable quantities throughout the country. The manufacture spread over the Balearic Islands, and among the populations that border the Mediterranean. It is still made all over Italy, and in Malta, Albania, the Ionian Islands and many other parts of Greece. That of the Greeks is sometimes on a large scale, with several thicknesses of wires alternating with larger and smaller bosses and beads, sometimes set with turquoises, &c., and mounted on convex plates, making rich ornamental headpieces, belts and breast ornaments. Filigree silver buttons of wire-work and small bosses are worn by the peasants in most of the countries that produce this kind of jewelry. Silver filigree brooches and buttons are also made in Denmark, Norway and Sweden. Little chains and pendants are added to much of this northern work.

Some very curious filigree work was brought from Abyssinia after the capture of Magdala—arm-guards, slippers, cups, &c., some of which are now in the South Kensington Museum. They are made of thin plates of silver, over which the wire-work is soldered. The filigree is subdivided by narrow borders of simple pattern, and the intervening spaces are made up of many patterns, some with grains set at intervals.

A few words must be added as to the granulated work which, as stated above, some writers have classed under the term of filigree, although the twisted wires may be altogether wanting. Such decoration consists of minute globules of gold, soldered to form patterns on a metal surface. Its use is rare in Egypt. (See J. de Morgan, *Fouilles à Dahchour*, 1894-1895, pl. xii.) It occurs in Cyprus at an early period, as for instance on a gold pendant in the British Museum from Enkomi in Cyprus (10th century B.C.). The pendant is in the form of a pomegranate, and has upon it a pattern of triangles, formed by more than 3000 minute globules separately soldered on. It also occurs on ornaments of the 7th century B.C. from Camirus in Rhodes. But these globules are large, compared with those which are found on Etruscan jewelry. Signor Castellani, who had made the antique jewelry of the Etruscans and Greeks his special study, with the intention of reproducing the ancient models, found it for a long time impossible to revive this particular process of delicate soldering. He overcame the difficulty at last, by the discovery of a traditional school of craftsmen at St Angelo in Vado, by whose help his well-known reproductions were executed.

For examples of antique work the student should examine the gold ornament rooms of the British Museum, the Louvre and the

collection in the Victoria and Albert Museum. The last contains a large and very varied assortment of modern Italian, Spanish, Greek and other jewelry made for the peasants of various countries. It also possesses interesting examples of the modern work in granulated gold by Castellani and Giuliano. The Celtic work is well represented in the Royal Irish Academy in Dublin.

FILLAN, SAINT, or **FAELAN**, the name of the two Scottish saints, of Irish origin, whose lives are of a purely legendary character. The St Fillan whose feast is kept on the 20th of June had churches dedicated to his honour at Ballyheyland, Queen's county, Ireland, and at Loch Earn, Perthshire. The other, who is commemorated on the 9th of January, was specially venerated at Cluain Mavscua, Co. Westmeath, Ireland, and so early as the 8th or 9th century at Strathfillan, Perthshire, Scotland, where there was an ancient monastery dedicated to him, which, like most of the religious houses of early times, was afterwards secularized. The lay-abbot, who was its superior in the reign of William the Lion, held high rank in the Scottish kingdom. This monastery was restored in the reign of Robert Bruce, and became a cell of the abbey of canons regular at Inchaffray. The new foundation received a grant from King Robert, in gratitude for the aid which he was supposed to have obtained from a relic of the saint on the eve of the great victory of Bannockburn. Another relic was the saint's staff or crozier, which became known as the coygerach or quigrich, and was long in the possession of a family of the name of Jore or Dewar, who were its hereditary guardians. They certainly had it in their custody in the year 1428, and their right was formally recognized by King James III. in 1487. The head of the crozier, which is of silver-gilt with a smaller crozier of bronze inclosed within it, is now deposited in the National Museum of the Society of Antiquaries of Scotland.

The legend of the second of these saints is given in the *Bollandist Acta SS.* (1643), 9th of January, i. 594-595; A. P. Forbes, *Kalendars of Scottish Saints* (Edinburgh, 1872), pp. 341-346; D. O'Hanlon's *Lives of Irish Saints* (Dublin), n.d. pp. 134-144. See also *Historical Notices of St Fillan's Crozier*, by Dr John Stuart (Aberdeen, 1877).

FILLET (through Fr. *filet*, from the med. Lat. *filettum*, diminutive of *filum*, a thread), a band or ribbon used for tying the hair, the Lat. *vitta*, which was used as a sacrificial emblem, and also worn by vestal virgins, brides and poets. The word is thus applied to anything in the shape of a band or strip, as, in coining, to the metal ribbon from which the blanks are punched. In architecture, a "fillet" is a narrow flat band, sometimes called a "listel," which is used to separate mouldings one from the other, or to terminate a suite of mouldings as at the top of a cornice. In the fluted column of the Ionic and Corinthian Orders the fillet is employed between the flutes. It is a very important feature in Gothic work, being frequently worked on large mouldings; when placed on the front and sides of the moulding of a rib it has been termed the "keel and wings" of the rib.

In cooking, "fillet" is used of the "undercut" of a sirloin of beef, or of a thick slice of fish or meat; more particularly of a boned and rolled piece of veal or other meat, tied by a "fillet" or string.

FILLMORE, MILLARD (1800-1874), thirteenth president of the United States of America, came of a family of English stock, which had early settled in New England. His father, Nathaniel, in 1795, made a clearing within the limits of what is now the town of Summerhill, Cayuga county, New York, and there Millard Fillmore was born, on the 7th of February 1800. Until he was fifteen he could have acquired only the simplest rudiments of education, and those chiefly from his parents. At that age he was apprenticed to a fuller and clothier, to card wool, and to dye and dress the cloth. Two years before the close of his term, with a promissory note for thirty dollars, he bought the remainder of his time from his master, and at the age of nineteen began to study law. In 1820 he made his way to Buffalo, then only a village, and supported himself by teaching school and aiding the postmaster while continuing his studies.

In 1823 he was admitted to the bar, and began practice at Aurora, New York, to which place his father had removed. Hard study, temperance and integrity gave him a good reputation and moderate success, and in 1827 he was made an attorney

and, in 1829, counsellor of the supreme court of the state. Returning to Buffalo in 1830 he formed, in 1832, a partnership with Nathan K. Hall (1810-1874), later a member of Congress and postmaster-general in his cabinet. Solomon G. Haven (1810-1861), member of Congress from 1851 to 1857, joined them in 1836. The firm met with great success. From 1829 to 1832 Fillmore served in the state assembly, and, in the single term of 1833-1835, in the national House of Representatives, coming in as anti-Jackson, or in opposition to the administration. From 1837 to 1843, when he declined further service, he again represented his district in the House, this time as a member of the Whig party. In Congress he opposed the annexation of Texas as slave territory, was an advocate of internal improvements and a protective tariff, supported J. Q. Adams in maintaining the right of offering anti-slavery petitions, advocated the prohibition by Congress of the slave trade between the states, and favoured the exclusion of slavery from the District of Columbia. His speech and tone, however, were moderate on these exciting subjects, and he claimed the right to stand free of pledges, and to adjust his opinions and his course by the development of circumstances. The Whigs having the ascendancy in the Twenty-Seventh Congress, he was made chairman of the House Committee of Ways and Means. Against a strong opposition he carried an appropriation of \$30,000 to Morse's telegraph, and reported from his committee the Tariff Bill of 1842. In 1844 he was the Whig candidate for the governorship of New York, but was defeated. In November 1847 he was elected comptroller of the state of New York, and in 1848 he was elected vice-president of the United States on the ticket with Zachary Taylor as president. Fillmore presided over the senate during the exciting debates on the "Compromise Measures of 1850."

President Taylor died on the 9th of July 1850, and on the next day Fillmore took the oath of office as his successor. The cabinet which he called around him contained Daniel Webster, Thomas Corwin and John J. Crittenden. On the death of Webster in 1852, Edward Everett became secretary of state. Unlike Taylor, Fillmore favoured the "Compromise Measures," and his signing one of them, the Fugitive Slave Law, in spite of the vigorous protests of anti-slavery men, lost him much of his popularity in the North. Few of his opponents, however, questioned his own full persuasion that the Compromise Measures were vitally necessary to pacify the nation. In 1851 he interposed promptly but ineffectively in thwarting the projects of the "filibusters," under Narciso Lopez for the invasion of Cuba. Commodore Matthew Calbraith Perry's expedition, which opened up diplomatic relations with Japan, and the exploration of the valley of the Amazon by Lieutenants William L. Herndon (1813-1857) and Lardner Gibbon also occurred during his term. In the autumn of 1852 he was an unsuccessful candidate for nomination for the presidency by the Whig National Convention, and he went out of office on the 4th of March 1853. In February 1856, while he was travelling abroad, he was nominated for the presidency by the American or Know Nothing party, and later this nomination was also accepted by the Whigs; but in the ensuing presidential election, the last in which the Know Nothings and the Whigs as such took any part, he received the electoral votes of only one state, Maryland. Thereafter he took no public share in political affairs. Fillmore was twice married: in 1826 to Abigail Powers (who died in 1853, leaving him with a son and daughter), and in 1858 to Mrs. Caroline C. McIntosh. He died at Buffalo on the 8th of March 1874.

In 1907 the Buffalo Historical Society, of which Fillmore was one of the founders and the first president, published the *Millard Fillmore Papers* (2 vols., vol. x. and xi. of the Society's publications; edited by F. H. Severance), containing miscellaneous writings and speeches, and official and private correspondence. Most of his correspondence, however, was destroyed in pursuance of a direction in his son's will.

FILMER, SIR ROBERT (d. 1653), English political writer, was the son of Sir Edward Filmer of East Sutton in Kent. He studied at Trinity College, Cambridge, where he matriculated in 1604. Knighted by Charles I. at the beginning of his reign, he

was an ardent supporter of the king's cause, and his house is said to have been plundered by the parliamentarians ten times. He died on the 26th of May 1653.

Filmer was already a middle-aged man when the great controversy between the king and the Commons roused him into literary activity. His writings afford an exceedingly curious example of the doctrines held by the most extreme section of the Divine Right party. Filmer's theory is founded upon the statement that the government of a family by the father is the true original and model of all government. In the beginning of the world God gave authority to Adam, who had complete control over his descendants, even as to life and death. From Adam this authority was inherited by Noah; and Filmer quotes as not unlikely the tradition that Noah sailed up the Mediterranean and allotted the three continents of the Old World to the rule of his three sons. From Shem, Ham and Japheth the patriarchs inherited the absolute power which they exercised over their families and servants; and from the patriarchs all kings and governors (whether a single monarch or a governing assembly) derive their authority, which is therefore absolute, and founded upon divine right. The difficulty that a man "by the secret will of God may unjustly" attain to power which he has not inherited appeared to Filmer in no way to alter the nature of the power so obtained, for "there is, and always shall be continued to the end of the world, a natural right of a supreme father over every multitude." The king is perfectly free from all human control. He cannot be bound by the acts of his predecessors, for which he is not responsible; nor by his own, for "impossible it is in nature that a man should give a law unto himself"—a law must be imposed by another than the person bound by it. With regard to the English constitution, he asserted, in his *Freeholder's Grand Inquest touching our Sovereign Lord the King and his Parliament* (1648), that the Lords only give counsel to the king, the Commons only "perform and consent to the ordinances of parliament," and the king alone is the maker of laws, which proceed purely from his will. It is monstrous that the people should judge or depose their king, for they would then be judges in their own cause.

The most complete expression of Filmer's opinions is given in the *Patriarcha*, which was published in 1680, many years after his death. His position, however, was sufficiently indicated by the works which he published during his lifetime: the *Anarchy of a Limited and Mixed Monarchy* (1648), an attack upon a treatise on monarchy by Philip Hunton (1604?-1682), who maintained that the king's prerogative is not superior to the authority of the houses of parliament; the pamphlet entitled *The Power of Kings, and in particular of the King of England* (1648), first published in 1680; and his *Observations upon Mr Hobbes's Leviathan, Mr Milton against Salmasius, and H. Grotius De jure belli et pacis, concerning the Originall of Government* (1652). Filmer's theory, owing to the circumstances of the time, obtained a recognition which it is now difficult to understand. Nine years after the publication of the *Patriarcha*, at the time of the Revolution which banished the Stuarts from the throne, Locke singled out Filmer as the most remarkable of the advocates of Divine Right, and thought it worth while to attack him expressly in the first part of the *Treatise on Government*, going into all his arguments *serialim*, and especially pointing out that even if the first steps of his argument be granted, the rights of the eldest born have been so often set aside that modern kings can claim no such inheritance of authority as he asserted.

FILMY FERNS, a general name for a group of ferns with delicate much-divided leaves and often moss-like growth, belonging to the genera *Hymenophyllum*, *Todea* and *Trichomanes*. They require to be kept in close cases in a cool fernery, and the stones and moss amongst which they are grown must be kept continually moist so that the evaporated water condenses on the very numerous divisions of the leaves.

FILON, PIERRE MARIE AUGUSTIN (1841-), French man of letters, son of the historian Charles Auguste Désiré Filon (1800-1875), was born in Paris in 1841. His father became professor of history at Douai, and eventually "*inspecteur d'académie*" in Paris; his principal works were *Histoire comparée*

de France et de l'Angleterre (1832), *Histoire de l'Europe au XVI^e siècle* (1838), *La Diplomatie française sous Louis XV* (1843), *Histoire de l'Italie méridionale* (1849), *Histoire du sénat romain* (1850), *Histoire de la démocratie athénienne* (1854). Educated at the École normale, Augustin Filon was appointed tutor to the prince imperial and accompanied him to England, where he remained for some years. He is the author of *Guy Palin, sa vie, sa correspondance* (1862); *Nos grands-pères* (1887); *Prosper Mérimée* (1894); *Sous la tyrannie* (1900). On English subjects he has written chiefly under the pseudonym of Pierre Sandrié, *Les Mariages de Londres* (1875); *Histoire de la littérature anglaise* (1883); *Le Théâtre anglais* (1896), and *La Caricature en Angleterre* (1902).

FILOSA (A. Lang), one of the two divisions of Rhizopoda, characterized by protoplasm granular at the surface, and fine pseudopodia branching and usually acutely pointed at the tips.

FILTER (a word common in various forms to most European languages, adapted from the medieval Lat. *filtrum*, felt, a material used as a filtering agent), an arrangement for separating solid matter from liquids. In some cases the operation of filtration is performed for the sake of removing impurities from the filtrate or liquid filtered, as in the purification of water for drinking purposes; in others the aim is to recover and collect the solid matter, as when the chemist filters off a precipitate from the liquid in which it is suspended.

In regard to the purification of water, filtration was long looked upon as merely a mechanical process of straining out the solid particles, whereby a turbid water could be rendered clear. In the course of time it was noticed that certain materials, such as charcoal, had the power to some extent also of softening hard water and of removing organic matter, and at the beginning of the 19th century charcoal, both animal and vegetable, came into use for filtering purposes. Porous carbon blocks, made by strongly heating a mixture of powdered charcoal with oil, resin, &c., were introduced about a generation later, and subsequently various preparations of iron (spongy iron, magnetic oxide) found favour. Innumerable forms of filters made with these and other materials were put on the market, and were extolled as removing impurities of every kind from water, and as affording complete protection against the communication of disease. But whatever merits they had as clarifiers of turbid water, the advent of bacteriology, and the recognition of the fact that the bacteria of certain diseases may be water-borne, introduced a new criterion of effectiveness, and it was perceived that the removal of solid particles, or even of organic impurities (which were realized to be important not so much because they are dangerous to health *per se* as because their presence affords grounds for suspecting that the water in which they occur has been exposed to circumstances permitting contamination with infective disease), was not sufficient; the filter must also prevent the passage of pathogenic organisms, and so render the water sterile bacteriologically. Examined from this point of view the majority of domestic filters were found to be gravely defective, and even to be worse than useless, since unless they were frequently and thoroughly cleansed, they were liable to become favourable breeding-places for microbes. The first filter which was more or less completely impermeable to bacteria was the Pasteur-Chamberland, which was devised in Pasteur's laboratory, and is made of dense biscuit porcelain. The filtering medium in this, as in other filters of the same kind, takes the form of a hollow cylinder or "candle," through the walls of which the water has to pass from the outside to the inside, the candles often being arranged so that they may be directly attached to a tap, whereby the rate of flow, which is apt to be slow, is accelerated by the pressure of the main. But even filters of this type, if they are to be fully relied upon, must be frequently cleaned and sterilized, and great care must be taken that the joints and connexions are watertight, and that the candles are without cracks or flaws. In cases where the water supply is known to be infected, or even where it is merely doubtful, it is wise to have recourse to sterilization by boiling, rather than trust to any filter. Various machines have been constructed to perform this operation, some of them specially

designed for the use of troops in the field; those in which economy of fuel is studied have an exchange-heater, by means of which the incoming cold water receives heat from the outgoing hot water, which thus arrives at the point of outflow at a temperature nearly as low as that of the supply. Chemical methods of sterilization have also been suggested, depending on the use of iodine, chlorine, bromine, ozone, potassium permanganate, copper sulphate or chloride and other substances. For the sand-filtration of water on a large scale, in which the presence of a surface film containing zooglaea of bacteria is an essential feature, see WATER SUPPLY.

Filtration in the chemical laboratory is commonly effected by the aid of a special kind of unsized paper, which in the more expensive varieties is practically pure cellulose, impurities like ferric oxide, alumina, lime, magnesia and silica having been removed by treatment with hydrochloric and hydrofluoric acids. A circular piece of this paper is folded twice upon itself so as to form a quadrant, one of the folds is pulled out, and the cone thus obtained is supported in a glass or porcelain funnel having an apical angle of 60°. The liquid to be filtered is poured into the cone, preferably down a glass rod upon the sides of the funnel to prevent splashing and to preserve the apex of the filter-paper, and passes through the paper, upon which the solid matter is retained. In the case of liquids containing strong acids or alkalis, which the paper cannot withstand, a plug of carefully purified asbestos or glass-wool (spun glass) is often employed, contained in a bulb blown as an enlargement on a narrow "filter-tube." To accelerate the rate of filtration various devices are resorted to, such as lengthening the tube below the filtering material, increasing the pressure on the liquid being filtered, or decreasing it in the receiver of the filtrate. R. W. Bunsen may be regarded as the originator of the second method, and it was he who devised the small cone of platinum foil, sometimes replaced by a cone of parchment perforated with pinholes, arranged at the apex of the funnel to serve as a support for the paper, which is apt to burst under the pressure differences. In the so-called "Buchner funnel," the filtering vessel is cylindrical, and the paper receives support by being laid upon its flat perforated bottom. In filtering into a vacuum the flask receiving the filtrate should be connected to the exhaust through a second flask. The suction may be derived from any form of air-pump; a form often employed where water at fair pressure is available is the jet-pump, which in consequence is known as a filter-pump. Another method of filtering into a vacuum is to immerse a porous jar ("Pukall cell") in the liquid to be filtered, and attach a suction-pipe to its interior. A filtering arrangement devised by F. C. Gooch, which has come into common use in quantitative analysis where the solid matter has to be submitted to heating or ignition, consists of a crucible having a perforated bottom. By means of a piece of stretched rubber tubing, this crucible is supported in the mouth of an ordinary funnel which is connected with an exhausting apparatus; and water holding in suspension fine scrapings of asbestos, purified by boiling with strong hydrochloric acid and washing with water, is run through it, so that the perforated bottom is covered with a layer of felted asbestos. The crucible is then removed from the rubber support, weighed and replaced; the liquid is filtered through in the ordinary way; and the crucible with its contents is again removed, dried, ignited and weighed. A perforated cone, similarly coated with asbestos and fitted into a conical funnel, is sometimes employed.

In many processes of chemical technology filtration plays an important part. A crude method consists of straining the liquid through cotton or other cloth, either stretched on wooden frames or formed into long narrow bags ("bag-filters"). Occasionally filtration into a vacuum is practised, but more often, as in filter-presses, the liquid is forced under pressure, either hydrostatic or obtained from a force-pump or compressed air, into a series of chambers partitioned off by cloth, which arrests the solids, but permits the passage of the liquid portions. For separating liquids from solids of a fibrous or crystalline character "hydro-extractors" or "centrifugals" are frequently employed. The

material is placed in a perforated cage or "basket," which is enclosed in an outer casing, and when the cage is rapidly rotated by suitable gearing, the liquid portions are forced out into the external casing.

FIMBRIA, GAIVS FLAVIVS (d. 84 B.C.), Roman soldier and a violent partisan of Marius. He was sent to Asia in 86 B.C. as legate to L. Valerius Flaccus, but quarrelled with him and was dismissed. Taking advantage of the absence of Flaccus at Chalcedon and the discontent aroused by his avarice and severity, Fimbria stirred up a revolt and slew Flaccus at Nicomedia. He then assumed the command of the army and obtained several successes against Mithradates, whom he shut up in Pitane on the coast of Aeolis, and would undoubtedly have captured him had Lucullus co-operated with the fleet. Fimbria treated most cruelly all the people of Asia who had revolted from Rome or sided with Sulla. Having gained admission to Ilium by declaring that, as a Roman, he was friendly, he massacred the inhabitants and burnt the place to the ground. But in 84 Sulla crossed over from Greece to Asia, made peace with Mithradates, and turned his arms against Fimbria, who, seeing that there was no chance of escape, committed suicide. His troops were made to serve in Asia till the end of the third Mithradatic War.

See *ROME: History*; and arts. on *SULLA* and *MARIUS*.

FIMBRIATE (from Lat. *fimbriae*, fringe), a zoological and botanical term, meaning fringed. In heraldry, "fimbriate" or "fimbriated" refers to a narrow edge or border running round a bearing.

FINALE (Ital. for "end"), a term in music for the concluding movement in an instrumental composition, whether symphony, concerto or sonata, and, in dramatic music, the concerted piece which ends each act. Of instrumental finales, the great choral finale to Beethoven's 9th symphony, and of operatic finales, that of Mozart's *Nozze di Figaro*, to the second act, and to the last act of Verdi's *Falstaff* may be mentioned. In the Wagnerian opera the finale has no place.

FINANCE. The term "finance," which comes into English through French, in its original meaning denoted a payment (*finatio*). In the later middle ages, especially in Germany, it acquired the sense of usurious or oppressive dealing with money and capital. The specialized use of the word as equivalent to the management of the public expenditure and receipts first became prominent in France during the 16th century and quickly spread to other countries. The plural form (*Les Finances*) was particularly reserved for this application, while the singular came to denote business activity in respect to monetary dealings (as in the expression *la haute finance*). For the Germans the phrase "science of finance" (*Finanzwissenschaft*) refers exclusively to the economy of the state. English and American writers are less definite in their employment of the term, which varies with the convenience of the author.

A work on "finance" may deal with the Money Market or the Stock Exchange; it may treat of banking and credit organization, or it may be devoted to state revenue and expenditure, which is on the whole the prevailing sense. The expressions "science of finance" and "public finance" have been suggested as suitable to delimit the last mentioned application. At all events, the broad sense is quite intelligible. "Financial" means what is concerned with business, and the idea of a balance between effort and return is also prominent. In the present article attention will be directed to "public finance"; for the other aspects of the subject reference may be made (*inter alia*) to the following:—**BANKS AND BANKING; COMPANY; EXCHANGE; MARKET; STOCK EXCHANGE**. See also **ENGLISH FINANCE**, and the sections on finance under headings of countries.

Finance, regarded as state house-keeping, or "political economy" (see **ECONOMICS**) in the older sense of the term, deals with (1) the expenditure of the state; (2) state revenues; (3) the balance between expenditure and receipts; (4) the organization which collects and applies the public funds. Each of these large divisions presents a series of problems of which the practical treatment is illustrated in the financial history of the great nations of the world. Thus the amount and character of public ex-

penditure necessarily depends on the functions that the state undertakes to perform—national defence, the maintenance of internal order, and the efficient equipment of the state organization; such are the tasks that all governments have to discharge, and for their cost due provision has to be made. The widening sphere of state activity, so marked a characteristic of modern civilization, involves outlay for what may be best described as "developmental" services. Education, relief of distress, regulation of labour and trade, are duties now in great part performed by public agencies, and their increasing prominence involves augmented expense. The first problem on this side of expenditure is the due balancing of outlay by income. The financier has to "cover" his outlay. There is, further, the duty of establishing a proper proportion between the several forms of expenditure. Not only has there to be a strict control over the total national expense; supervision has to be carried into each department of the state. No one branch of public activity is entitled to make unlimited calls on the state's revenue. The claims of the "expert" require to be carefully scrutinized. The great financiers have made their reputation quite as much by rigorous control over extravagance in expenditure as by dexterity in devising new forms of revenue. Unfortunately they have not been able to reduce their methods to rule. As yet no more definite principle has been discovered than the somewhat obvious one of measuring the proposed items of outlay (1) against each other, (2) against the sacrifice that additional taxation involves. Of almost equal importance is the rule that the utmost return is to be obtained for the given outlay. The canon of *economy* is as fundamental in regard to public expenditure as it will appear, later, to be in respect to revenue. Just application of the outlay of the state, so that no class receives undue advantage, and the use of public funds for "reproductive," in preference to "unproductive" objects, are evident general principles whose difficulty lies in their application to the circumstances of each particular case.

Far greater progress has been made in the formulation of general canons as to the nature, growth and treatment of the public revenues. Historically, there is, first, the tendency towards increase in state income to balance the advance in outlay. A second general feature is the relative decline of the receipts from state property and industries in contrast to the expansion of taxation. Regarded as an organized system, the body of receipts has to be made conformable to certain general conditions. Thus there should be revenue sufficient to meet the public requirements. Otherwise the financial organization has failed in one of its essential purposes. In order continuously to attain this end, the revenue must be flexible, or, as is often said, elastic enough to vary in response to pressure. Frequently recurring deficits are, in themselves, a condemnation of the methods under which they are found. Again, the rule of "economy" in raising revenue, or, in other words, taking as little as possible from the contributors over and above what the state receives, holds good for the whole and for each part of public revenue. In like manner the principle of formal justice has the same claim in respect to revenue as to expenditure. No class of person should bear more than his or its proper share. In fact the special maxims usually placed under the head of taxation have really a wider scope as governing the whole financial system. The recognition of even the most elementary rules has been a very slow process, as the course of financial history abundantly proves. Until the 18th century no scientific treatment of financial problems was attained, though there had been great advances on the administrative side.

A brief description of the historical evolution of the earlier financial forms will be the most effective illustration of this statement. The theory of well-organized public finance is also discussed under **TAXATION** and **NATIONAL DEBT**.

The earliest forms of public revenue are those obtained from the property of the chief or ruler. Land, cattle and slaves are the principal kinds of wealth, and they are all constituents of the king's revenue; enforced work contributed by members of the community, and the furnishing commodities on requisition,

further aid in the maintenance of the primitive state. Financial organization makes its earliest appearance in the great Eastern monarchies, in which tribute was regularly collected and the oldest and most general form of taxation—that levied on the produce of land—was established. In its normal shape this impost consisted in a given proportion of the yield, or of certain portions of the yield, of the soil; one-fourth as in India, one-fifth as in Egypt, or two separate levies of a tenth as in Palestine, are examples of what may from the last instance be called the "tithe" system. Dues of various kinds were gradually added to the land revenue, until, as in the later Egyptian monarchy, the forms of revenue reached a bewildering complexity. But no Eastern state advanced beyond the condition generally characterized as the "patrimonial," *i.e.* an organization on the model of the household. The part played by money economy was small, and it is noticeable that the revenues were collected by the monarch's servants, the farming out of taxes being completely unknown. Tribute, however, was paid by subject communities as a whole, and was collected by them for transmission to the conquerors.

A much higher stage was reached in the financial methods of the Greek states, or more correctly speaking of Athens, the best-known specimen of the class. Instead of the comparatively simple expedients of the barbarian monarchies, as indicated above, the Athenian city state by degrees developed a rather complex revenue system. Some of the older forms are retained. The city owned public land which was let on lease and the rents were farmed out by auction. A specially valuable property of Athens was the possession of the silver mines at Laurium, which were worked on lease by slave labour. The produce, at first distributed amongst the citizens, was later a part of the state income, and forms the subject of some of the suggestions respecting the revenue in the treatise formerly ascribed to Xenophon. The reverence that attached to the precious metals caused undue exaltation of the services rendered by this property.

One of the characteristics of the ancient state was its extensive control over the persons and property of its citizens. In respect to finance this authority was strikingly manifested in the burdens imposed on wealthy citizens by the requirements of the "liturgies" (*λειτουργίαι*), which consisted in the provision of a chorus for theatrical performances, or defraying the expenses of the public games, or, finally, the equipment of a ship, "the trierarchy," which was economically and politically the most important. Athenian statesmanship in the time of Demosthenes was gravely exercised to make this form of contribution more effective. The grouping into classes and the privilege of exchanging property, granted to the contributor against any one whom he believed entitled to take his place, are marks of the defective economic and financial organization of the age.

Amongst taxes strictly so called were the market dues or tolls, which in some cases approximated to excise duties, though in their actual mode of levy they were closely similar to the *octrois* of modern times. Of greater importance were the customs duties on imports and exports. These at the great period of Athenian history were only 2%. The prohibition of export of corn was an economic rather than a financial provision. In the treatment of her subject allies Athens was more rigorous, general import and export duties of 5% being imposed on their trade. The high cost of carriage, and the need of encouraging commerce in a community relying on external sources for its food supply, help to explain the comparatively low rates adopted. Neither as financial nor as protective expedients were the custom duties of classical societies of much importance.

Direct taxation received much greater expansion. A special levy on the class of resident aliens (*μετοίκων*), probably paralleled by a duty on slaves, was in force. A far more important source of revenue was the general tax on property (*εἰσφορά*), which according to one view existed as early as the time of Solon, who made it a part of his constitutional system. Modern inquiry, however, tends towards the conclusion that it was under the stress of the Peloponnesian War that this impost was intro-

duced (428 B.C.). At first it was only levied at irregular intervals; afterwards, in 378 B.C., it became a permanent tax based on elaborate valuation under which the richer members paid on a larger quota of their capital; in the case of the wealthiest class the taxable quota was taken as one-fifth, smaller fractions being adopted for those belonging to the other divisions. The assessment (*τιμήμα*) included all the property of the contributor, whose accuracy in making full returns was safeguarded by the right given to other citizens to proceed against him for fraudulent under-valuation. A further support was provided in the reform of 378 B.C. by the establishment of the *symmories*, or groups of tax-paying citizens; the wealthier members of each group being responsible for the tax payments of all the members.

The scanty and obscure references to finance, and to economic matters generally, in classical literature do not elucidate all the details of the system; but the analogies of other countries, *e.g.* the mode of levying the *taille* in 18th century France and the "tenth and fifteenth" in medieval England, make it tolerably plain that in the 4th century B.C. the Athenian state had developed a mode of taxation on property which raised those questions of just distribution and effective valuation that present themselves in the latest tax systems of the modern world. Taken together with the liturgies, the "eisphora" placed a very heavy burden on the wealthier citizens, and this financial pressure accounts in great part for the hostility of the rich towards the democratic constitution that facilitated the imposition of graduated taxation and super-taxes—to use modern terms—on the larger incomes. The normal yield of the property tax is reported as 60 talents (£14,400); but on special occasions it reached 200 talents (£48,000), or about one-sixth of the total receipts.

On the administrative side also remarkable advances were made by the entrusting of military expenditure to the "generals," and in the 4th century B.C. by the appointment of an administrator whose duty it was to distribute the revenue of the state under the directions of the assembly. The absence of settled public law and the influence of direct democracy made a complete ministry of finance impossible.

The Athenian "hegemony" in its earlier and later phases had an important financial side. The confederacy of Delos made provision for the collection of a revenue (*φόρος*) from the members of the league, which was employed at first for defence against Persian aggression, but afterwards was at the disposal of Athens as the ruling state. The annual collection of 460 talents (£110,400) shows sufficiently the magnitude of the league.

Too little is known of the financial methods of the other Greek states and of the Macedonian kingdoms to allow of any definite account of their position. In the latter, particularly in Egypt, the methods of the earlier rulers probably survived. Their finance, like their social life generally, exhibited a blending of Hellenic and barbarian elements. The older land-taxes were probably accompanied by import dues and taxes on property.

In the infancy of the Roman republic its revenues were of the kind usual in such communities. The public land yielded receipts which may indifferently be regarded as rents *Roman* or taxes; the citizens contributed their services or commodities, and dues were raised on certain articles coming to market. With the progress of the Roman dominion the financial organization grew in extent. In order to meet the cost of the early wars a special contribution from property (*tributum ex censu*) was levied at times of emergency, though it was in some cases regarded as an advance to be repaid when the occasion of expense was over. Owing to the great military successes, and the consequent increase of the other sources of revenue, it became feasible to suspend the *tributum* in 167 B.C., and it was not again levied till after the death of Julius Caesar. From this date the expenses of the Roman state "were undisguisedly supported by the taxation of the provinces." Neither the state monopolies nor the public land in Italy afforded any appreciable revenue. The other charges that affected Italy were the 5% duty on manumissions, and customs dues on sea-borne imports. But with the acquisition of the important provinces of Sicily, Spain and Africa, the formation of a tax

system based on the tributes of the dependencies became possible. To a great extent the pre-existing forms of revenue were retained, but were gradually systematized. In legal theory the land of conquered communities passed into the ownership of the Roman state; in practice a revenue was obtained through land taxes in the form of either tithes (*decumae*) or money payments (*stipendia*). To the latter were adjoined capitation and trade taxes (the *tributum capitis*). For pasture land a special rent was paid. In some provinces (e.g. Sicily) payment in produce was preferred, as affording the supply needed for the free distribution of corn at Rome.

The great form of indirect taxation consisted in the customs dues (*portoria*), which were collected at the provincial boundaries and varied in amount, though the maximum did not exceed 5%. Under the same head were included the town dues (or *octrois*). Further, the local administration was charged on the district concerned, and requisitions for the public service were frequently made on the provincial communities. Supplies of grain, ships and timber for military use were often demanded.

The methods of levy may be regarded as an additional tax. "Vexation," as Adam Smith remarks, "though not strictly speaking expense, is certainly equivalent to the expense at which every man would be willing to redeem himself from it"; and the Roman system was extraordinarily vexatious. From an early date the collection of the taxes had been farmed out to companies of contractors (*societates vectigales*), who became a by-word for rapacity. Being bound to pay a stated sum to the public authorities these *publicani* naturally aimed at extracting the largest possible amount from the unfortunate provincials, and, as they belonged to the Roman capitalist class, they were able to influence the provincial governors. Undue claims on the part of the tax collectors were aggravated by the extortion of the public officials. The defects of the financial organization were a serious influence in the complex of causes that brought about the fall of the Republic.

One of the reasons that induced the subject populations to accept with pleasure the establishment of the Empire was the improvement in financial treatment that it secured. The corrupt and uneconomical method of farming out the collection of the revenue was, to a great extent, replaced by collection through the officials of the imperial household. The earlier Roman treasury (*aerarium*) was formally retained for the receipt of revenue from the senatorial provinces, but the officials were appointed by the Princeps and became gradually mere municipal officers. The real centre of finance was the *fiscus* or imperial treasury, which was under the exclusive control of the ruler ("res fiscales," says Ulpian, "quasi propriae et privatae principis sunt"), and was administered by officials of his household. Under the Republic the Senate had been the financial authority, with the Censors as finance ministers and the Quaestors as secretaries of the treasury. Never very precise, this system in the 1st century B.C. fell into extreme decay. By means of his freedmen the emperor introduced the more rigorous economy of the Roman household into public finance. The census as a method of valuation was revived; the important and productive land taxes were placed on a more definite footing; while, above all, the substitution of direct collection by state officials for the letting out by auction of the tax-collection to the companies of *publicani* was made general. Thus some of the most valuable lessons as to the normal evolution of a system of finance are to be learned in this connexion. Of equal, or even greater moment is the failure of the administrative reforms of the Empire to secure lasting improvement, a result due to the absence of constitutional guarantees. The close relation between finance and general policy is most impressively illustrated in this failure of benevolent autocracy.

Viewed broadly, the financial resources of the earlier Empire were obtained from (1) the public land alike of the state and the Princeps; (2) the monopolies, principally of minerals; (3) the land tax; (4) the customs; (5) the taxes on inheritances, on sales and on the purchase of slaves (*vectigalia*). One result of the establishment of the Principate was the consolidation of

the public domain. The old "public land" in Italy had nearly disappeared; but the royal possessions in the conquered provinces and the private properties of the emperor became ultimately a part of the property of the *Fiscus*. Such land was let either on five-year leases or in perpetuity to *coloni*. Mines were also taken over for public use and worked by slaves or, in later times, by convict labour. The tendency towards state monopoly became more marked in the closing days of the Empire, the 4th and 5th centuries A.D. Perhaps the most comprehensive of the fiscal reforms of the Empire was the reconstruction of the land tax, based on a census or (to use the French term) *cadastre*, in which the area, the modes of cultivation and the estimated productiveness of each holding were stated, the average of ten preceding years being taken as the standard. After the reconstruction under Diocletian at the end of the 3rd century A.D., fifteen years (the *indictio*)—though probably used as early as the time of Hadrian—was recognized as the period for revaluation. With the growing needs of the state this taxation became more rigorous and was one of the great grievances of the population, especially of the sections that were declining in status and passing into the condition of villenage. The *portoria*, or customs, received a better organization, though the varying rates for different provinces continued. By degrees the older maximum of 5% was exceeded, until in the 4th century 12½% was in some cases levied. Even at this higher rate the facilities for trade were greater than in medieval or (until the revolution in transport) modern times. In spite of certain prejudices against the import of luxuries and the export of gold, there is little indication of the influence of mercantilist or protectionist ideas. The nearest approach to excise was the duty of 1% on all sales, a tax that in Gibbon's words "has ever been the occasion of clamour and discontent." The higher charge of 4% on the purchase of slaves, and the still heavier 5% on successions after death, were likewise established at the beginning of the Empire and specially applied to the full citizens. Escheats and lapsed legacies (*caduca*) were further miscellaneous sources of gain to the state.

Taken as a whole, the financial system of Imperial Rome shows a very high elaboration in form. The *patrimonium*, the *tributa* and the *vectigalia* are divisions parallel to the *domaine*, the *contributions directes* and the *contributions indirectes* of modern French administration; or the English "non-tax" revenue, inland revenue and "customs and excise." The careful regulations given in the Codes and the Digest show the observance of technical conditions as to assessment and accounting. In substance and spirit, however, Roman finance was essentially backward. Without altogether accepting Merivale's judgment that "their principles of finance were to the last rude and unphilosophical," it may be granted that Roman statesmen never seriously faced the questions of just distribution and maximum productiveness in the tax system. Still less did they perceive the connexion between these two aspects of finance. Mechanical uniformity and minute regulation are inadequate substitutes for observance of the canons of equality, certainty and economy in the operation of the tax system. Whether (as has been suggested) an Adam Smith in power could have saved the Empire is doubtful; but he would certainly have remodelled its finance. The most glaring fault was plainly the undue and increasing pressure on the productive classes. Each century saw heavier burdens imposed on the actual workers and on their employers, while expenditure was chiefly devoted to unproductive purposes. The distribution was also unfair as between the different territorial divisions. The capital and certain provincial towns were favoured at the expense of the provinces and the country districts. Again, the cost of collection, though less than under the farming-out system, was far too great. Some alleviation was indeed obtained by the apportionment of contributions amongst the districts liable, leaving to the community to decide as it thought best between its members. The allotment of the land-tax to units (*juga*) of equal value whatever might be the area, was a contrivance similar in character.

The gradual way in which the several provinces were brought under the general tax system, and the equally gradual extension of Roman citizenship, account further for the irregularity and increased weight of the taxes; as the absence of publicity and the growth of autocracy explain the sense of oppression and the hopelessness of resistance so vividly indicated in the literature of the later Empire. Exemptions at first granted to the citizens were removed, while the cost of local government which continually increased was placed on the middle-class of the towns as represented by the *decuriones*, or members of the municipalities.

The fact that no ingenuity of modern research has been able to construct a real budget of expenditure and receipt for any part of the long centuries of the Empire is significant as to the secrecy that surrounded the finances, especially in the later period. For at the beginning of the principate Augustus seems to have aimed at a complete estimate of the financial situation, though this may be regarded as due to the influence of the freer republican traditions which the reverence that soon attached to the emperor's dignity completely extinguished.

In addition to its value as illustrating the difficulties and defects that beset the development of a complex financial organization from the simpler forms of the city and the province, Roman finance is of special importance in consequence of its place as supplying a model or rather a guide for the administration of the states that arose on its ruins. The barbarian invaders, though they were accustomed to contributions to their chiefs and to the payment of commodities as tributes or as penalties, had no acquaintance with the working of a regular system of taxation. The more astute rulers utilized the machinery that they inherited from the Roman government. Under the Franks the land tax and the provincial customs continued as forms of revenue, while beside them the gifts and court fees of Teutonic origin took their place. Similar conditions appear in Theodorich's administration of Italy. The maintenance of Roman forms and terms is prominent in fiscal administration. But institutions that have lost their life and animating spirit can hardly be preserved for any length of time. All over western Europe the elaborate devices of the *census* and the stations for the collection of customs crumbled away; taxation as such disappeared, through the hostility of the clergy and the exemptions accorded to powerful subjects. This process of disintegration spread out over centuries. The efforts made from time to time by vigorous rulers to enforce the charges that remained legally due, proved quite ineffectual to restore the older fiscal system. The final result was a complete transformation of the ingredients of revenue. The character of the change may be best indicated as a substitution of private claims for public rights. Thus, the land-tax disappears in the 7th century and only comes into notice in the 9th century in the shape of private customary dues. The customs duties become the tolls and transit charges levied by local potentates on the diminishing trade of the earlier middle ages. This revolution is in accordance with—indeed it is one side of—the movement towards feudalism which was the great feature of this period. Finance is essentially a part of *public* law and administration. It could, therefore, hold no prominent place in a condition of society which hardly recognized the state, as distinct from the members of the community, united by feudal ties. The same conception may be expressed in another way, viz. by the statement that the kingdoms which succeeded the Roman Empire were organized on the patrimonial basis (*i.e.* the revenues passed into the hands of the king or, rather, his domestic officials), and thus in fact returned to the condition of pre-classical times. Notwithstanding the differing features in the several countries, retrogression is the common characteristic of European history from the 5th to the 10th century, and it was from the ruder state that this decline created that the rebuilding of social and political organization had to be accomplished. On the financial side the work, as already suggested, was aided by the ideas and institutions inherited from the Roman Empire. This influence was common to all the continental states and indirectly was felt even in England. Each of the great realms

has, however, worked out its financial system on lines suitable to its own particular conditions, which are best considered in connexion with the separate national histories.

Running through the different national systems there are some common elements the result not of inheritance merely but still more of necessity, or at the lowest of similarity in environment. Over and above the details of financial development there is a thread of connexion which requires treatment under Finance taken as a whole. As the great aim of this side of public activity is to secure funds for the maintenance of the state's life and working, the administration which operates for this end is the true nucleus of all national finance. The first sign of revival from the catastrophe of the invasions is the reorganization of the Imperial household under Charlemagne with the intention of establishing a more exact collection of revenue. The later German empire of Otto and the Frederics; the French Capetian monarchy and, in a somewhat different sphere, the medieval Italian and German cities show the same movement. The treasury is the centre towards which the special receipts of the ruler or rulers should be brought, and from it the public wants should be supplied. Feudalism, as the antithesis of this orderly treatment, had to be overthrown before national finance could become established. The development can be traced in the financial history of England, France and the German states; but the advance in the French financial organization of the 15th and 16th centuries affords the best illustration. The gradual unification operates on all the branches of finance,—expenditure, revenue, debt and methods of control. In respect to the first head there is a well-marked "integration" of the modes for meeting the cost of the public services. What were semi-private duties become public tasks, which, with the growing importance of "money-economy," have to be defrayed by state payments. Thus, the creation of the standing army in France by Charles VII. marks a financial change of the first order. The English navy, though more gradually developed, is an equally good illustration of the movement. All outlay by the state is brought into due co-ordination, and it becomes possible for constitutional government to supervise and direct it. This improvement, due to English initiative, has been adopted amongst the essential forms of financial administration on the continent. The immense importance of this view of public expenditure as representing the consumption of the state in its unified condition is obvious; it has affected, for the most part unconsciously, the conception of all modern peoples as to the functions of the state and the right of the people to direct them.

On the side of receipts a similar unifying process has been accomplished. The almost universal separation between "ordinary" and "extraordinary" receipts, taxation being put under the latter head, has completely ceased. It was, however, the fundamental division for the early French writers on finance, and it survives for England as late as Blackstone's *Commentaries*. The idea that the ruler possessed a normal income in certain rents and dues of a quasi-private character, which on emergency he might supplement by calls on the revenues of his subjects, was a bequest of feudalism which gave way before the increasing power of the state. In order to meet the unified public wants, an equally unified public fund was requisite. The great economic changes which depreciated the value of the king's domain contributed towards the result. Only by well-adjusted taxation was it possible to meet the public necessities. In respect to taxation also there has been a like course of re-adjustment. Separate charges, assigned for distinct purposes, have been taken into the national exchequer and come to form a part of the general revenue. There has been—taking long periods—a steady absorption of special taxes into more general categories. The replacement of the four direct taxes by the income tax in France, as proposed in 1909, is a very recent example. Equally important is the growth of "direct" taxation. As tax contributions have taken the places of the revenue from land and fees, so, it would seem, are the taxes on commodities likely to be replaced or at least exceeded by the imposts levied on income as such, in the shape either of income taxes

proper or of charges on accumulated wealth. The recent history of the several financial systems of the world is decisive on this point. A clearer perception of the conditions under which the effective attainment of revenue is possible is another outcome of financial development. Security, and in particular the absence of arbitrary impositions, combined with convenient modes of collection, have come to be recognized as indispensable auxiliaries in financial administration which further aims at the selection of really productive forms of charge. Unproductiveness is, according to modern standard, the cardinal fault of any particular tax. How great has been the progress in these aspects is best illustrated in the case of English finance, but both French and German fiscal history can supply many instructive examples.

In a third direction the co-ordination of finance has been just as remarkable. Financial adjustment implies the conception of a balance, and this should be found in the relation of outlay and income. Under the pressure of war and other emergencies it has been found impossible to maintain this desirable equilibrium. But the use of the system of credit, and the general establishment of constitutional government, have enabled the difficulty to be surmounted by the creation on a vast scale of national debts. Apart from the special problems that this system of borrowing raises, there is the general one of its aid in making national finance continuous and orderly. Deficits can be transferred to the capital account, and the country's resources employed most usefully by repaying liabilities contracted in times of extreme need. The growth of this department, parallel with the general progress of finance, is significant of its function.

Finally, in all countries though with diversities due to national peculiarities, the modes of account and control have been brought into a more effective condition. Previous legislative sanction for both expenditure and receipts in all their particular forms is absolutely necessary; so is thorough scrutiny of the actual application of the funds provided. Either by administrative survey or by judicial examination care is taken to see that there has been no improper diversion from the designed purposes. It is only when the varied systems of financial organization are studied in their general bearing, and with regard to what may be called their frame-work, that their essential resemblance is thoroughly realized. Such a real underlying unity is the reason and justification for regarding "public finance" as a distinct subject of study and as an independent division of political science.

Local Finance.—One of the most remarkable features of modern financial development has been the growth of the complementary system of local finance, which in extent and complication bids to rival that of the central authority. Under the constraining power of the Roman Empire the older city states were reduced to the position of municipalities, and their financial administration became dependent on the control of the Emperor—as is abundantly illustrated in the correspondence of Pliny and Trajan. After the fall of the Western Empire, a partial revival of city life, particularly in Italy and Germany, gave some scope for a return to the type of finance presented by the Athenian state. Florence affords an instructive specimen; but the passage from feudalism to the national state under the authority of monarchy made the cities and country districts parts of a larger whole. It is in this condition of subordination that the finance of localities has been framed and effectively organized. Though each great state has adopted its own methods, influenced by historical circumstances and by ideas of policy, there are general resemblances that furnish material for scientific treatment and allow of important generalizations being made.

Amongst these the first to be noticed is the essential *subordination* of local finance. Alike in expenditure, in forms of receipt, and in methods of administration the central government has the right of directing and supervising the work of municipal and provincial agencies. The modes employed are various, but they all rest on the sovereignty of the state, whether exercised by the central officials or by the courts. A second characteristic is the predominance of the *economic* element in the several tasks that local administrations have to perform, and the consequent

tendency to treat the charges of local finance as payments for services rendered, or, in the usual phrase, to apply the "benefits" principle, in contrast to that of "ability," which rightly prevails in national finance. Over a great part of municipal administration—particularly that engaged in supplying the needs of the individual citizens—the finance may be assimilated to that of the joint-stock company, with of course the necessary differences, viz. that the association is compulsory; and that dividends are paid, not in money, but in social advantage. The great expansion in recent years of what is known as *Municipal Trading* has brought this aspect of local finance into prominence. Water supply, transport and lighting have become public services, requiring careful financial management, and still retaining traces of their earlier private character.

Corresponding to the mainly economic nature of local expenditure there is the further limitation imposed on the side of revenue. Unlike the state in this, localities are limited in respect to the amount and form of their taxation. Several distinct influences combine to produce this result. The needs of the central government lead to its retention of the more profitable modes of procuring revenue. No modern country can surrender the chief direct and indirect taxes to the local administrations. Another limiting condition is found in the practical impossibility of levying by local agencies such imposts as the customs and the income-tax in their modern forms. The elaborate machinery that is requisite for covering the national area and securing the revenue against loss can only be provided by an authority that can deal with the whole territory. Hence the very general limitation of local revenues to certain typical forms. Though in some cases municipal taxation is imposed on commodities in the form of *octrois* or entry duties—as is notably the case in France—yet the prevailing tendency is towards the levy of direct charges on immovable property, which cannot escape by removal outside the tax jurisdiction. In addition to these "land" and "house" taxes, the employment of licence duties on trades, particularly those that are in special need of supervision, is a favourite method. Closely akin are the payments demanded for privileges to industrial undertakings given as "franchises," very often in connexion with monopolies, e.g. gas-works and tramways. Over and above the peculiar revenues of local bodies there is the further resource—which emphasizes the subordinate position of local finance—of obtaining supplemental revenue from the central treasury, either by taxes additional to the charges of the state, and collected at the same time; or by donations from its funds, in the shape of grants for special services, or assignments of certain parts of the state's receipts. Great Britain, France and Prussia furnish good examples of these different modes of preserving local administration from financial collapse.

The broad resemblance between the two parts of the entire system of public finance is seen in another direction. To national debts there has been added a great mass of municipal and local indebtedness, which seems likely to equal, or even exceed in magnitude the liabilities of the central governments. But here also the essential limitations of the newer form are easily perceptible. The sovereignty of the state enables it to deal as it thinks best with the public creditor. In its methods of borrowing, in its plans for repayment, or, in extremity, in its power of repudiation it is independent of external control. Local debt on the other hand can only be contracted under the sanction of the appropriate administrative organ of the state. The creditor has the right of claiming the aid of the law against the defaulting municipality; and the amounts, the terms, and the time of duration of local debt are supervised in order to prevent injustice to particular persons or improvidence with regard to the revenue and property of the local units. The chief reason for contracting local debt being the establishment of works that are, directly or indirectly, reproductive, the governing conditions are evidently to be found in the character and probable yield of those businesses. The principles of company investments are fully applicable: the creation of sinking-funds, the fixing the term of each loan to the time at which the return from its employment ceases, and the avoidance of the formation of fictitious capital, become guiding

rules from this part of finance, and indicate the connexion with what the commercial world calls "financial operations."

Finally, there is the same set of problems in respect to accounting and control in local as in central finance. Though the materials are simpler, the need for a well-prepared budget is existent in the case of the city, county or department, if there is to be clear and accurate financial management. Perhaps the greatest weakness of local finance lies in this direction. The public opinion that affects the national budget is unfortunately too often lacking in the most important towns, not excluding those in which political life is highly developed.

BIBLIOGRAPHY.—The English literature on finance is rather unsatisfactory; for public finance the available text-books are: Adams, *Science of Finance* (New York, 1898); Bastable, *Public Finance* (London, 1892; 3rd ed., 1903); Daniels, *Public Finance* (New York, 1899), and Plehn, *Public Finance* (3rd ed., New York, 1909). In French, Leroy-Beaulieu, *Traité de la science des finances* (1877; 3rd ed., 1908), is the standard work. The German literature is abundant. Roscher, 5th ed. (edited by Gerlach), 1901; Wagner (4 vols.), incomplete; Cohn (1889) and Eheberg (9th ed., 1908) have published works entitled *Finanzwissenschaft*, dealing with all the aspects of state finance. For Greek financial history Boekh, *Staatshaushaltung der Athenen* (ed. Fränkel, 1887), is still a standard work. For Rome, Marquardt, *Römische Staatsverwaltung*, vol. ii., and Humbert, *Les Finances et la comptabilité publique chez les Romains*, are valuable. Clamageran, *Histoire de l'impôt en France* (1876), gives the earlier development of French finance. R. H. Patterson, *Science of Finance* (London, 1868), C. S. Meade, *Trust Finance* (1903), and E. Carroll, *Principles and Practice of Finance*, deal with finance in the wider sense of business transactions. (C. F. B.)

FINCH, FINCH-HATTON. This old English family has had many notable members, and has contributed in no small degree to the peerage. Sir Thomas Finch (d. 1563), who was knighted for his share in suppressing Sir T. Wyatt's insurrection against Queen Mary, was a soldier of note, and was the son and heir of Sir William Finch, who was knighted in 1513. He was the father of Sir Moyle Finch (d. 1614), who was created a baronet in 1611, and whose widow Elizabeth (daughter of Sir Thomas Heneage) was created a peeress as countess of Maidstone in 1623 and countess of Winchilsea in 1628; and also of Sir Henry Finch (1558-1625), whose son John, Baron Finch of Fordwich (1584-1660), is separately noticed. Thomas, eldest son of Sir Moyle, succeeded his mother as first earl of Winchilsea; and Sir Heneage, the fourth son (d. 1631), was the speaker of the House of Commons, whose son Heneage (1621-1682), lord chancellor, was created earl of Nottingham in 1675. The latter's second son Heneage (1649-1719) was created earl of Aylesford in 1714. The earldoms of Winchilsea and Nottingham became united in 1729, when the fifth earl of Winchilsea died, leaving no son, and the title passed to his cousin the second earl of Nottingham, the earldom of Nottingham having since then been held by the earl of Winchilsea. In 1826, on the death of the ninth earl of Winchilsea and fifth of Nottingham, his cousin George William Finch-Hatton succeeded to the titles, the additional surname of Hatton (since held in this line) having been assumed in 1764 by his father under the will of an aunt, a daughter of Christopher, Viscount Hatton (1632-1706), whose father was related to the famous Sir Christopher Hatton.

FINCH OF FORDWICH, JOHN FINCH, BARON (1584-1660), generally known as Sir John Finch, English judge, a member of the old family of Finch, was born on the 17th of September 1584, and was called to the bar in 1611. He was returned to parliament for Canterbury in 1614, and became recorder of the same place in 1617. Having attracted the notice of Charles I., who visited Canterbury in 1625, and was received with an address by Finch in his capacity as recorder, he was the following year appointed king's counsel and attorney-general to the queen and was knighted. In 1628 he was elected speaker of the House of Commons, a post which he retained till its dissolution in 1629. He was the speaker who was held down in his chair by Holles and others on the occasion of Sir John Eliot's resolution on tonnage and poundage. In 1634 he was appointed chief justice of the court of common pleas, and distinguished himself by the active zeal with which he upheld the king's prerogative. Notable also was the brutality which characterized his conduct as chief

justice, particularly in the cases of William Prynne and John Langton. He presided over the trial of John Hampden, who resisted the payment of ship-money, and he was chiefly responsible for the decision of the judges that ship-money was constitutional. As a reward for his services he was, in 1640, appointed lord keeper, and was also created Baron Finch of Fordwich. He had, however, become so unpopular that one of the first acts of the Long Parliament, which met in the same year was his impeachment. He took refuge in Holland, but had to suffer the sequestration of his estates. When he was allowed to return to England is uncertain, but in 1660 he was one of the commissioners for the trial of the regicides, though he does not appear to have taken much part in the proceedings. He died on the 27th of November 1660 and was buried in St Martin's church near Canterbury, his peerage becoming extinct.

See Foss, *Lives of the Judges*; Campbell, *Lives of the Chief Justices*.

FINCH (Ger. *Fink*, Lat. *Fringilla*), a name applied (but almost always in composition—as bullfinch, chaffinch, goldfinch, hawfinch, &c.) to a great many small birds of the order *Passeres*, and now pretty generally accepted as that of a group or family—the *Fringillidae* of most ornithologists. Yet it is one the extent of which must be regarded as being uncertain. Many writers have included in it the buntings (*Emberizidae*), though these seem to be quite distinct, as well as the larks (*Alaudidae*), the tanagers (*Tanagridae*), and the weaver-birds (*Ploceidae*). Others have separated from it the crossbills, under the title of *Loxiidae*, but without due cause. The difficulty which at this time presents itself in regard to the limits of the *Fringillidae* arises from our ignorance of the anatomical features, especially those of the head, possessed by many exotic forms.

Taken as a whole, the finches, concerning which no reasonable doubt can exist, are not only little birds with a hard bill, adapted in most cases for shelling and eating the various seeds that form the chief portion of their diet when adult, but they appear to be mainly forms which predominate in and are highly characteristic of the Palaearctic Region; moreover, though some are found elsewhere on the globe, the existence of but very few in the Notogaeian hemisphere can as yet be regarded as certain.

But even with this limitation, the separation of the undoubted *Fringillidae*¹ into groups is a difficult task. Were we merely to consider the superficial character of the form of the bill, the genus *Loxia* (in its modern sense) would be easily divided not only from the other finches, but from all other birds. The birds of this genus—the crossbills—when their other characters are taken into account, prove to be intimately allied on the one hand to the grosbeaks (*Pinicola*) and on the other through the redpolls (*Aegialothus*) to the linnets (*Linota*)—if indeed these two can be properly separated. The linnets, through the genus *Leucosticte*, lead to the mountain-finches (*Montifringilla*), and the redpolls through the siskins (*Chrysomitris*) to the goldfinches (*Carduelis*); and these last again to the hawfinches, one group of which (*Coccothraustes*) is apparently not far distant from the chaffinches (*Fringilla* proper), and the other (*Hesperiphona*) seems to be allied to the greenfinches (*Ligurinus*). Then there is the group of serins (*Serinus*), to which the canary belongs, that one is in doubt whether to refer to the vicinity of the greenfinches or that of the redpolls. The mountain-finches may be regarded as pointing first to the rock-sparrows (*Petronia*) and then to the true sparrows (*Passer*); while the grosbeaks pass into many varied forms and throw out a very well marked form—the bullfinches (*Pyrrhula*). Some of the modifications of the family are very gradual, and therefore conclusions founded on them are likely to be correct; others are further apart, and the links which connect them, if not altogether missing, can but be surmised. To avoid as much as possible prejudicing the case, we shall therefore take the different groups of *Fringillidae* which it is convenient to consider in this article in an alphabetical arrangement.

Of the Bullfinches the best known is the familiar bird (*Pyrrhula*

¹ About 200 species of these have been described, and perhaps 150 may really exist.

europaea). The varied plumage of the cock—his bright red breast and his grey back, set off by his coal-black head and quills—is naturally attractive; while the facility with which he is tamed, with his engaging disposition in confinement, makes him a popular cage-bird,—to say nothing of the fact (which in the opinion of so many adds to his charms) of his readily learning to “pipe” a tune, or some bars of one. By gardeners the bullfinch has long been regarded as a deadly enemy, from its undoubted destruction of the buds of fruit-trees in spring-time, though whether the destruction is really so much of a detriment is by no means so undoubted. Northern and eastern Europe is inhabited by a larger form (*P. major*), which differs in nothing but size and more vivid tints from that which is common in the British Isles and western Europe. A very distinct species (*P. murina*), remarkable for its dull coloration, is peculiar to the Azores, and several others are found in Asia from the Himalayas to Japan. A bullfinch (*P. cassini*) has been discovered in Alaska, being the first recognition of this genus in the New World.

The Canary (*Serinus canarius*) is indigenous to the islands whence it takes its name, as well, apparently, as to the neighbouring groups of the Madeiras and Azores, in all of which it abounds. It seems to have been imported into Europe at least as early as the first half of the 16th century,¹ and has since become the commonest of cage-birds. The wild stock is of an olive-green, mottled with dark brown above, and greenish-yellow beneath. All the bright-hued examples we now see in captivity have been induced by carefully breeding from any chance varieties that have shown themselves; and not only the colour, but the build and stature of the bird have in this manner been greatly modified. The ingenuity of “the fancy,” which might seem to have exhausted itself in the production of topknots, feathered feet, and so forth, has brought about a still further change from the original type. It has been found that by a particular treatment, in which the mixing of large quantities of vegetable colouring agents with the food plays an important part, the ordinary “canary yellow” may be intensified so as to verge upon a more or less brilliant flame colour.²

Very nearly resembling the canary, but smaller in size, is the Serin (*Serinus hortulanus*), a species which not long since was very local in Europe, and chiefly known to inhabit the countries bordering on the Mediterranean. It has pushed its way towards the north, and has even been several times taken in England (Yarrell's *Brit. Birds*, ed. 4, ii. pp. 111-116). A closely allied species (*S. canonicus*) is peculiar to Palestine.

The Chaffinches are regarded as the type-form of *Fringillidae*. The handsome and sprightly *Fringilla coelebs*³ is common throughout the whole of Europe. Conspicuous by his variegated plumage, his peculiar call note⁴ and his glad song, the cock is almost everywhere a favourite. In Algeria the British chaffinch is replaced by a closely-allied species (*F. spodogenia*), while in the Atlantic Islands it is represented by two others (*F. tintillon* and *F. leydeae*)—all of which, while possessing the general appearance of the European bird, are clothed in soberer tints.⁵ Another

¹ The earliest published description seems to be that of Gesner in 1555 (*Orn.* p. 234), but he had not seen the bird, an account of which was communicated to him by Raphael Seiler of Augsburg, under the name of *Suckeruögele*.

² See also *The Canary Book*, by Robert L. Wallace; *Canaries and Cage Birds*, by W. A. Blackston; and Darwin's *Animals and Plants under Domestication*, vol. i. p. 295. An excellent monograph on the wild bird is that by Dr Carl Bolle (*Journ. für Orn.*, 1858, pp. 125-151).

³ This fanciful trivial name was given by Linnaeus on the supposition (which later observations do not entirely confirm) that in Sweden the hens of the species migrated southward in autumn, leaving the cocks to lead a celibate life till spring. It is certain, however, that in some localities the sexes live apart during the winter.

⁴ This call-note, which to many ears sounds like “pink” or “spink,” not only gives the bird a name in many parts of Britain, but is also obviously the origin of the German *Fink* and the English *Finch*. The similar Celtic form *Pinc* is said to have given rise to the Low Latin *Pincio*, and thence come the Italian *Pincione*, the Spanish *Pinzon*, and the French *Pinson*.

⁵ This is especially the case with *F. leydeae* of the Canary Islands, which from its dark colouring and large size forms a kind of parallel to the Azorean *Pyrrhula murina*.

species of true *Fringilla* is the brambling (*F. montifringilla*), which has its home in the birch forests of northern Europe and Asia, whence it yearly proceeds, often in flocks of thousands, to pass the winter in more southern countries. This bird is still more beautifully coloured than the chaffinch—especially in summer, when, the brown edges of the feathers being shed, it presents a rich combination of black, white and orange. Even in winter, however, its diversified plumage is sufficiently striking.

With the exception of the single species of bullfinch already noticed as occurring in Alaska, all the above forms of finches are peculiar to the Palaearctic Region. (A. N.)

FINCHLEY, an urban district in the Hornsey parliamentary division of Middlesex, England, 7 m. N.W. of St Paul's cathedral, London, on a branch of the Great Northern railway. Pop. (1891) 16,647; (1901) 22,126. A part, adjoining Highgate on the north, lies at an elevation between 300 and 400 ft., while a portion in the Church End district lies lower, in the valley of the Dollis Brook. The pleasant, healthy situation has caused Finchley to become a populous residential district. Finchley Common was formerly one of the most notorious resorts of highwaymen near London; the Great North Road crossed it, and it was a haunt of Dick Turpin and Jack Sheppard, and was still dangerous to cross at night at the close of the 18th century. Sheppard was captured in this neighbourhood in 1724. The Common has not been preserved from the builder. In 1660 George Monk, marching on London immediately before the Restoration, made his camp on the Common, and in 1745 a regular and volunteer force encamped here, prepared to resist the Pretender, who was at Derby. The gathering of this force inspired Hogarth's famous picture, the “March of the Guards to Finchley.”

FINCK, FRIEDRICH AUGUST VON (1718-1766), Prussian soldier, was born at Strelitz in 1718. He first saw active service in 1734 on the Rhine, as a member of the suite of Duke Anton Ulrich of Brunswick-Wolfenbüttel. Soon after this he transferred to the Austrian service, and thence went to Russia, where he served until the fall of his patron Marshal Münnich put an end to his prospects of advancement. In 1742 he went to Berlin, and Frederick the Great made him his aide-de-camp, with the rank of major. Good service brought him rapid promotion in the Seven Years' War. After the battle of Kolin (June 18th, 1757) he was made colonel, and at the end of 1757 major-general. At the beginning of 1759 Finck became lieutenant-general, and in this rank commanded a corps at the disastrous battle of Kunersdorf, where he did good service both on the field of battle and (Frederick having in despair handed over to him the command) in the rallying of the beaten Prussians. Later in the year he fought in concert with General Wunsch a widespread combat, called the action of Korbitz (Sept. 21st) in which the Austrians and the contingents of the minor states of the Empire were sharply defeated. For this action Frederick gave Finck the Black Eagle (Seyfarth, *Beilagen*, ii. 621-630). But the subsequent catastrophe of Maxen (see SEVEN YEARS' WAR) abruptly put an end to Finck's active career. Dangerously exposed, and with inadequate forces, Finck received the king's positive order to march upon Maxen (a village in the Pirna region of Saxony). Unfortunately for himself the general dared not disobey his master, and, cut off by greatly superior numbers, was forced to surrender with some 11,000 men (21st Nov. 1759). After the peace, Frederick sent him before a court-martial, which sentenced him to be cashiered and to suffer a term of imprisonment in a fortress. At the expiry of this term Finck entered the Danish service as general of infantry. He died at Copenhagen in 1766.

He left a work called *Gedanken über militärische Gegenstände* (Berlin, 1788). See *Denkwürdigkeiten der militärischen Gesellschaft*, vol. ii. (Berlin, 1802-1805), and the report of the Finck court-martial in *Zeitschrift für Kunst, Wissenschaft und Geschichte des Krieges*, pt. 81 (Berlin, 1851). There is a life of Finck in MS. in the library of the Great General Staff.

FINCK, HEINRICH (d. c. 1519), German musical composer, was probably born at Bamberg, but nothing is certainly known either of the place or date of his birth. Between 1492 and 1506 he was a musician in, and later possibly conductor of the court

orchestra of successive kings of Poland at Warsaw. He held the post of conductor at Stuttgart from 1510 till about 1519, in which year he probably died. His works, mostly part songs and other vocal compositions, show great musical knowledge, and amongst the early masters of the German school he holds a high position. They are found scattered amongst ancient and modern collections of songs and other musical pieces (see R. Eitner, *Bibl. der Musiksammelwerke des 16. und 17. Jahrh.*, Berlin, 1877). The library of Zwickau possesses a work containing a collection of fifty-five songs by Finck, printed about the middle of the 16th century.

FINCK, HERMANN (1527–1558), German composer, the great-nephew of Heinrich Finck, was born on the 21st of March 1527 in Pirna, and died at Wittenberg on the 28th of December 1558. After 1553 he lived at Wittenberg, where he was organist, and there, in 1555, was published his collection of "wedding songs." Few details of his life have been preserved. His theoretical writing was good, particularly his observations on the art of singing and of making ornamentations in song. His most celebrated work is entitled *Practica musica, exempla variorum signorum, proportionum, et canonum, iudicium de tonis ac quedam de arte suaviter et artificiose cantandi continens* (Wittenberg, 1556). It is of great historic value, but very rare.

FINDEN, WILLIAM (1787–1852), English line engraver, was born in 1787. He served his apprenticeship to one James Mitton, but appears to have owed far more to the influence of James Heath, whose works he privately and earnestly studied. His first employment on his own account was engraving illustrations for books, and among the most noteworthy of these early plates were Smirke's illustrations to Don Quixote. His neat style and smooth finish made his pictures very attractive and popular, and although he executed several large plates, his chief work throughout his life was book illustration. His younger brother, Edward Finden, worked in conjunction with him, and so much demand arose for their productions that ultimately a company of assistants was engaged, and plates were produced in increasing numbers, their quality as works of art declining as their quantity rose. The largest plate executed by William Finden was the portrait of King George IV. seated on a sofa, after the painting by Sir Thomas Lawrence. For this work he received two thousand guineas, a sum larger than had ever before been paid for an engraved portrait. Finden's next and happiest works on a large scale were the "Highlander's Return" and the "Village Festival," after Wilkie. Later in life he undertook, in co-operation with his brother, aided by their numerous staff, the publication as well as the production of various galleries of engravings. The first of these, a series of landscape and portrait illustrations to the life and works of Byron, appeared in 1833 and following years, and was very successful. But by his *Gallery of British Art* (in fifteen parts, 1838–1840), the most costly and best of these ventures, he lost the fruits of all his former success. Finden's last undertaking was an engraving on a large scale of Hilton's "Crucifixion." The plate was bought by the Art Union for £1470. He died in London on the 20th of September 1852.

FINDLATER, ANDREW (1810–1885), Scottish editor, was born in 1810 near Aberdour, Aberdeenshire, the son of a small farmer. By hard study in the evening, after his day's work on the farm was finished, he qualified himself for entrance at Aberdeen University, and after graduating as M.A. he attended the Divinity classes with the idea of entering the ministry. In 1853 he began that connexion with the firm of W. & R. Chambers which gave direction to his subsequent activity. His first engagement was the editing of a revised edition of their *Information for the People* (1857). In this capacity he gave evidence of qualities and acquirements that marked him as a suitable editor for Chambers's *Encyclopaedia*, then projected, and his was the directing mind that gave it its character. Many of the more important articles were written by him. This work occupied him till 1868, and he afterwards edited a revised edition (1874). He also had charge of other publications for the same firm, and wrote regularly for the *Scotsman*. In 1864 he was made LL.D. of Aberdeen University. In 1877 he gave up active work for

Chambers, but his services were retained as consulting editor. He died in Edinburgh on the 1st of January 1885.

FINDLAY, SIR GEORGE (1829–1893), English railway manager, was of pure Scottish descent, and was born at Rainhill, in Lancashire, on the 18th of May 1829. For some time he attended Halifax grammar school, but left at the age of fourteen, and began to learn practical masonry on the Halifax railway, upon which his father was then employed. Two years later he obtained a situation on the Trent Valley railway works, and when that line was finished in 1847 went up to London. There he was for a short time among the men employed in building locomotive sheds for the London & North-Western railway at Camden Town, and years afterwards, when he had become general manager of that railway, he was able to point out stones which he had dressed with his own hands. For the next two or three years he was engaged in a higher capacity as supervisor of the mining and brickwork of the Harecastle tunnel on the North Staffordshire line, and of the Walton tunnel on the Birkenhead, Lancashire & Cheshire Junction railway. In 1850 the charge of the construction of a section of the Shrewsbury & Hereford line was entrusted to him, and when the line was opened for traffic T. Brassey, the contractor, having determined to work it himself, installed him as manager. In the course of his duties he was brought for the first time into official relations with the London & North-Western railway, which had undertaken to work the Newport, Abergavenny & Hereford line, and he ultimately passed into the service of that company, when in 1862, jointly with the Great Western, it leased the railway of which he was manager. In 1864 he was moved to Euston as general goods manager, in 1872 he became chief traffic manager, and in 1880 he was appointed full general manager; this last post he retained until his death, which occurred on the 26th of March 1893 at Edgware, Middlesex. He was knighted in 1892. Sir George Findlay was the author of a book on the *Working and Management of an English Railway* (London, 1889), which contains a great deal of information, some of it not easily accessible to the general public, as to English railway practice about the year 1890.

FINDLAY, JOHN RITCHIE (1824–1898), Scottish newspaper owner and philanthropist, was born at Arbroath on the 21st of October 1824, and was educated at Edinburgh University. He entered first the publishing office and then the editorial department of the *Scotsman*, became a partner in the paper in 1868, and in 1870 inherited the greater part of the property from his great uncle, John Ritchie, the founder. The large increase in the influence and circulation of the paper was in a great measure due to his activity and direction, and it brought him a fortune, which he spent during his lifetime in public benefaction. He presented to the nation the Scottish National Portrait Gallery, opened in Edinburgh in 1889, and costing over £70,000; and he contributed largely to the collections of the Scottish National Gallery. He held numerous offices in antiquarian, educational and charitable societies, showing his keen interest in these matters, but he avoided political office and refused the offer of a baronetcy. The freedom of Edinburgh was given him in 1896. He died at Aberlour, Banffshire, on the 16th of October 1898.

FINDLAY, a city and the county-seat of Hancock county, Ohio, U.S.A., on Blanchard's Fork of the Auglaize river, about 42 m. S. by W. of Toledo. Pop. (1890) 18,553; (1900) 17,613 (1051 foreign-born); (1910) 14,858. It is served by the Cleveland, Cincinnati, Chicago & St. Louis, the Cincinnati, Hamilton & Dayton, the Lake Erie & Western, and the Ohio Central railways, and by three interurban electric railways. Findlay lies about 780 ft. above sea-level on gently rolling ground. The city is the seat of Findlay College (co-educational), an institution of the Church of God, chartered in 1882 and opened in 1886; it has collegiate, preparatory, normal, commercial and theological departments, a school of expression, and a conservatory of music, and in 1907 had 588 students, the majority of whom were in the conservatory of music. Findlay is the centre of the Ohio natural gas and oil region, and lime and building stone

abound in the vicinity. Among manufactures are refined petroleum, flour and grist-mill products, glass, boilers, bricks, tile, pottery, bridges, ditching machines, carriages and furniture. The total value of the factory product in 1905 was \$2,925,309, an increase of 73.6% since 1900. The municipality owns and operates the water-works. Findlay was laid out as a town in 1821, was incorporated as a village in 1838, and was chartered as a city in 1890. The city was named in honour of Colonel James Findlay (c. 1775-1835), who built a fort here during the war of 1812; he served in this war under General William Hull, and from 1825 to 1833 was a Democratic representative in Congress.

FINE, a word which in all its senses goes back to the Lat. *finire*, to bring to an end (*finis*). Thus in the common adjectival meanings of elegant, thin, subtle, excellent, reduced in size, &c., it is in origin equivalent to "finished." In the various substantival meanings in law, with which this article deals, the common idea underlying them is an end or final settlement of a matter.

A fine, in the ordinary sense, is a pecuniary penalty inflicted for the less serious offences. Fines are necessarily discretionary as to amount; but a maximum is generally fixed when the penalty is imposed by statute. And it is an old constitutional maxim that fines must not be unreasonable. In Magna Carta, c. 111, it is ordained "*Liber homo non amercietur pro parvo delicto nisi secundum modum ipsius delicti, et pro magno delicto secundum magnitudinem delicti.*"

The term is also applied to payments made to the lord of a manor on the alienation of land held according to the custom of the manor, to payments made by a lessee on a renewal of a lease, and to other similar payments.

Fine also denotes a fictitious suit at law, which played the part of a conveyance of landed property. "A fine," says Blackstone, "may be described to be an amicable composition or agreement of a suit, either actual or fictitious, by leave of the king or his justices, whereby the lands in question become or are acknowledged to be the right of one of the parties. In its original it was founded on an actual suit commenced at law for the recovery of the possession of land or other hereditaments; and the possession thus gained by such composition was found to be so sure and effectual that fictitious actions were and continue to be every day commenced for the sake of obtaining the same security." Freehold estates could thus be transferred from one person to another without the formal delivery of possession which was generally necessary to a feoffment. This is one of the oldest devices of the law. A statute of 18 Edward I. describes it as the most solemn and satisfactory of securities, and gives a reason for its name—"Qui quidem finis sic vocatur, eo quod finis et consummatio omnium placitorum esse debet, et hac de causa providebatur." The action was supposed to be founded on a breach of covenant: the defendant, owning himself in the wrong,¹ makes overtures of compromise, which are authorized by the *licentia concordandi*; then followed the concord, or the compromise itself. These, then were the essential parts of the performance, which became efficient as soon as they were complete; the formal parts were the *notes*, or abstract of the proceedings, and the *foot* of the fine, which recited the final agreement. Fines were said to be of four kinds, according to the purpose they had in view, as, for instance, to convey lands in pursuance of a covenant, to grant revisionary interest only, &c. In addition to the formal record of the proceedings, various statutes required other solemnities to be observed, the great object of which was to give publicity to the transaction. Thus by statutes of Richard III. and Henry VII. the fine had to be openly read and proclaimed in court no less than sixteen times. A statute of Elizabeth required a list of fines to be exposed in the court of common pleas and at assizes. The reason for these formalities was the high and important nature of the conveyance, which, according to the act of Edward I. above mentioned, "precludes not only those which are parties and privies to the

¹ Hence called *cognizor*; the other party, the purchaser, is the *cognizee*.

fine and their heirs, but all other persons in the world who are of full age, out of prison, of sound memory, and within the four seas, the day of the fine levied, unless they put in their claim on the foot of the fine within a year and a day." This barring by *non-claim* was abolished in the reign of Edward III., but restored with an extension of the time to five years in the reign of Henry VII. The effect of this statute, intentional according to Blackstone, unintended and brought about by judicial construction according to others, was that a tenant-in-tail could bar his issue by a fine. A statute of Henry VIII. expressly declares this to be the law. Fines, along with the kindred fiction of recoveries, were abolished by the Fines and Recoveries Act 1833, which substituted a deed enrolled in the court of chancery.

Fines are so generally associated in legal phraseology with recoveries that it may not be inconvenient to describe the latter in the present place. A recovery was employed as a means for evading the strict law of entail. The purchaser or alienee brought an action against the tenant-in-tail, alleging that he had no legal title to the land. The tenant-in-tail brought a third person into court, declaring that he had warranted his title, and praying that he might be ordered to defend the action. This person was called the *vouchee*, and he, after having appeared to defend the action, takes himself out of the way. Judgment for the lands is given in favour of the plaintiff; and judgment to recover lands of equal value from the vouchee was given to the defendant, the tenant-in-tail. In real action, such lands when recovered would have fallen under the settlement of entail; but in the fictitious recovery the vouchee was a man of straw, and nothing was really recovered from him, while the lands of the tenant-in-tail were effectually conveyed to the successful plaintiff. A recovery differed from a fine, as to *form*, in being an action carried through to the end, while a fine was settled by compromise, and as to effect, by barring all reversions and remainders in estates tail, while a fine barred the issue only of the tenant. (See also EJECTMENT; PROCLAMATION.)

FINE ARTS, the name given to a whole group of human activities, which have for their result what is collectively known as Fine Art. The arts which constitute the group are the five greater arts of architecture, sculpture, painting, music and poetry, with a number of minor or subsidiary arts, of which dancing and the drama are among the most ancient and universal. In antiquity the fine arts were not explicitly named, nor even distinctly recognized, as a separate class. In other modern languages besides English they are called by the equivalent name of the beautiful arts (*belle arti, beaux arts, schöne Künste*). The fine or beautiful arts then, it is usually said, are those among the arts of man which minister, not primarily to his material necessities or conveniences, but to his love of beauty; and if any art fulfils both these purposes at once, still as fulfilling the latter only is it called a fine art. Thus architecture, in so far as it provides shelter and accommodation, is one of the useful or mechanical arts, and one of the fine arts only in so far as its structures impress or give pleasure by the aspect of strength, fitness, harmony and proportion of parts, by disposition and contrast of light and shade, by colour and enrichment, by variety and relation of contours, surfaces and intervals. But this, the commonly accepted account of the matter, does not really cover the ground. The idea conveyed by the words "love of beauty," even stretched to its widest, can hardly be made to include the love of caricature and the grotesque; and these are admittedly modes of fine art. Even the terrible, the painful, the squalid, the degraded, in a word every variety of the significant, can be so handled and interpreted as to be brought within the province of fine art. A juster and more inclusive, although clumsier, account of the matter might put it that the fine arts are those among the arts of man which spring from his impulse to do or make certain things in certain ways for the sake, first, of a special kind of pleasure, independent of direct utility, which it gives him so to do or make them, and next for the sake of the kindred pleasure which he derives from witnessing or contemplating them when they are so done or made by others.

The nature of this impulse, and the several grounds of these pleasures, are subjects which have given rise to a formidable body of speculation and discussion, the chief phases of which will be found summarized under the heading *AESTHETICS*. In the present article we have only to attend to the concrete processes and results of the artistic activities of man; in other words, we shall submit (1) a definition of fine art in general, (2) a definition and classification of the principal fine arts severally, (3) some observations on their historical development.

I. *Of Fine Art in General.*

According to the popular and established distinction between art and nature, the idea of Art (*q.v.*) only includes phenomena of which man is deliberately the cause; while the idea of Nature includes all phenomena, both in man and in the world outside him, which take place without forethought or studied initiative of his own. Art, accordingly, means every regulated operation or dexterity whereby we pursue ends which we know beforehand; and it means nothing but such operations and dexterities. What is true of art generally is of course also true of the special group of the fine arts. One of the essential qualities of all art is premeditation; and when Shelley talks of the skylark's profuse strains of "unpremeditated art," he in effect lays emphasis on the fact that it is only by a metaphor that he uses the word art in this case at all; he calls attention to that which (if the songs of birds are as instinctive as we suppose) precisely makes the difference between the skylark's outpourings and his own. We are slow to allow the title of fine art to natural eloquence, to charm or dignity of manner, to delicacy and tact in social intercourse, and other such graces of life and conduct, since, although in any given case they may have been deliberately cultivated in early life, or even through ancestral generations, they do not produce their full effect until they are so ingrained as to have become unreflecting and spontaneous. When the exigencies of a philosophic scheme lead some writers on aesthetics to include such acts or traits of beautiful and expressive behaviour among the deliberate artistic activities of mankind, we feel that an essential distinction is being sacrificed to the exigencies of a system. That distinction common parlance very justly observes, with its opposition of "art" to "nature" and its phrase of "second nature" for those graces which have become so habitual as to seem instinctive, whether originally the result of discipline or not. When we see a person in all whose ordinary movements there are freedom and beauty, we put down the charm of these with good reason to inherited and inbred aptitudes of which the person has never thought or long since ceased to think, and could not still be thinking without spoiling the charm by self-consciousness; and we call the result a gift of nature. But when we go on to notice that the same person is beautifully and appropriately dressed, since we know that it is impossible to dress without thinking of it, we put down the charm of this to judicious forethought and calculation and call the result a work of art.

The processes then of fine art, like those of all arts properly so called, are premeditated, and the property of every fine art is to give to the person exercising it a special kind of active pleasure, and a special kind of passive or receptive pleasure to the person witnessing the results of such exercise. This latter statement seems to imply that there exist in human societies a separate class producing works of fine art and another class enjoying them. Such an implication, in regard to advanced societies, is near enough the truth to be theoretically admitted (like the analogous assumption in political economy that there exist separate classes of producers and consumers). In developed communities the gifts and calling of the artist constitute in fact a separate profession of the creators or purveyors of fine art, while the rest of the community are its enjoyers or recipients. In the most primitive societies, apparently, this cannot have been so, and we can go back to an original or rudimentary stage of almost every fine art at which the separation between a class of producers

or performers and a class of recipients hardly exists. Such an original or rudimentary stage of the dramatic art is presented by children, who will occupy themselves for ever with mimicry and make-believe for their own satisfaction, with small regard or none to the presence or absence of witnesses. The original or rudimentary type of the profession of imitative sculptors or painters is the cave-dweller of prehistoric ages, who, when he rested from his day's hunting, first took up the bone handle of his weapon, and with a flint either carved it into the shape, or on its surface scratched the outlines, of the animals of the chase. The original or rudimentary type of the architect, considered not as a mere builder but as an artist, is the savage who, when his tribe had taken to live in tents or huts instead of caves, first arranged the skins and timbers of his tent or hut in one way because it pleased his eye, rather than in some other way which was as good for shelter. The original type of the artificer or adorer of implements, considered in the same light, was the other savage who first took it into his head to fashion his club or spear in one way rather than another for the pleasure of the eye only and not for any practical reason, and to ornament it with tufts or markings. In none of these cases, it would seem, can the primitive artist have had much reason for pleasing anybody but himself. Again, the original or rudimentary type of lyric song and dancing arose when the first reveller clapped hands and stamped or shouted in time, in honour of his god, in commemoration of a victory, or in mere obedience to the blind stirring of a rhythmic impulse within him. To some very remote and solitary ancestral savage the presence or absence of witnesses at such a display may in like manner have been indifferent; but very early in the history of the race the primitive dancer and singer joined hands and voices with others of his tribe, while others again sat apart and looked on at the performance, and the rite thus became both choral and social. A primitive type of the instrumental musician is the shepherd who first notched a reed and drew sounds from it while his sheep were cropping. The father of all artists in dress and personal adornment was the first wild man who tattooed himself or bedecked himself with shells and plumes. In both of these latter instances, it may be taken as certain, the primitive artist had the motive of pleasing not himself only, but his mate, or the female whom he desired to be his mate, and in the last instance of all the further motive of impressing his fellow-tribesmen and striking awe or envy into his enemies. The tendency of recent speculation and research concerning the origins of art has been to ascribe the primitive artistic activities of man less and less to individual and solitary impulse, and more and more to social impulse and the desire of sharing and communicating pleasure. (The writer who has gone furthest in developing this view, and on grounds of the most careful study of evidence, has been Dr Yrjö Hirn of Helsingfors.) Whatever relative parts the individual and the social impulses may have in fact played at the outset, it is clear that what any one can enjoy or admire by himself, whether in the way of mimicry, of rhythmical movements or utterances, of imitative or ornamental carving and drawing, of the disposition and adornment of dwelling-places and utensils—the same things, it is clear, others are able also to enjoy or admire with him. And so, with the growth of societies, it came about that one class of persons separated themselves and became the ministers or producers of this kind of pleasures, while the rest became the persons ministered to, the participants in or recipients of the pleasures. Artists are those members of a society who are so constituted as to feel more acutely than the rest certain classes of pleasures which all can feel in their degree. By this fact of their constitution they are impelled to devote their active powers to the production of such pleasures, to the making or doing of some of those things which they enjoy so keenly when they are made and done by others. At the same time the artist does not, by assuming these ministering or creative functions, surrender his enjoying or receptive functions. He continues to participate in the pleasures of which he is himself the cause, and remains a conscious member of his own public. The architect, sculptor, painter, are able respectively

to stand off from and appreciate the results of their own labours; the singer enjoys the sound of his own voice, and the musician of his own instrument; the poet, according to his temperament, furnishes the most enthusiastic or the most fastidious reader for his own stanzas. Neither, on the other hand, does the person who is a habitual recipient from others of the pleasures of fine art forfeit the privilege of producing them according to his capabilities, and of becoming, if he has the power, an *amateur* or occasional artist.

Most of the common properties which have been recognized by consent as peculiar to the group of fine arts will be found on examination to be implied in, or deducible from, the one fundamental character generally claimed for them, namely, that they exist independently of direct practical necessity or utility. Let us take, first, a point relating to the frame of mind of the recipient, as distinguished from the producer, of the pleasures of fine art. It is an observation as old as Aristotle that such pleasures differ from most other pleasures of experience in that they are disinterested, in the sense that they are not such as nourish a man's body nor add to his riches; they are not such as can gratify him, when he receives them, by the sense of advantage or superiority over his fellow-creatures; they are not such as one human being can in any sense receive exclusively from the object which bestows them. Thus it is evidently characteristic of a beautiful building that its beauty cannot be monopolized, but can be seen and admired by the inhabitants of a whole city and by all visitors for all generations. The same thing is true of a picture or a statue, except in so far as an individual possessor may choose to keep such a possession to himself, in which case his pride in exclusive ownership is a sentiment wholly independent of his pleasure in artistic contemplation. Similarly, music is composed to be sung or played for the enjoyment of many at a time, and for such enjoyment a hundred years hence as much as to-day. Poetry is written to be read by all readers for ever who care for the ideas and feelings of the poet, and can apprehend the meaning and melody of his language. Hence, though we can speak of a class of the producers of fine art, we cannot speak of a class of its consumers, only of its recipients or enjoyers. If we consider other pleasures which might seem to be analogous to those of fine art, but to which common consent yet declines to allow that character, we shall see that one reason is that such pleasures are not in their nature thus disinterested. Thus the sense of smell and taste have pleasures of their own like the senses of sight and hearing, and pleasures neither less poignant nor very much less capable of fine graduation and discrimination than those. Why, then, is the title of fine art not claimed for any skill in arranging and combining them? Why are there no recognized arts of savours and scents corresponding in rank to the arts of forms, colours and sounds—or at least none among Western nations, for in Japan, it seems, there is a recognized and finely regulated social art of the combination and succession of perfumes? An answer commonly given is that sight and hearing are intellectual and therefore higher senses, that through them we have our avenues to all knowledge and all ideas of things outside us; while taste and smell are unintellectual and therefore lower senses, through which few such impressions find their way to us as help to build up our knowledge and our ideas. Perhaps a more satisfactory reason why there are no fine arts of taste and smell—or let us in deference to Japanese modes leave out smell, and say of taste only—is this, that savours yield only private pleasures, which it is not possible to build up into separate and durable schemes such that every one may have the benefit of them, and such as cannot be monopolized or used up. If against this it is contended that what the programme of a performance is in the musical art, the same is a *menu* in the culinary, and that practically it is no less possible to serve up a thousand times and to a thousand different companies the same dinner than the same symphony, we must fall back upon that still more fundamental form of the distinction between the aesthetic and non-aesthetic bodily senses, upon which the physiological psychologists of the English school lay

stress. We must say that the pleasures of taste cannot be pleasures of fine art, because their enjoyment is too closely associated with the most indispensable and the most strictly personal of utilities, eating and drinking. To pass from these lower pleasures to the highest; consider the nature of the delight derived from the contemplation, by the person who is their object, of the signs and manifestations of love. That at least is a beautiful experience; why is the pleasure which it affords not an artistic pleasure either? Why, in order to receive an artistic pleasure from human signs and manifestations of this kind, are we compelled to go to the theatre and see them exhibited in favour of a third person who is not really their object any more than ourselves? This is so, for one reason, evidently, because of the difference between art and nature. Not to art, but to nature and life, belongs love where it is really felt, with its attendant train of vivid hopes, fears, passions and contingencies. To art belongs love displayed where it is not really felt; and in this sphere, along with reality and spontaneity of the display, and along with its momentous bearings, there disappear all those elements of pleasure in its contemplation which are not disinterested—the elements of personal exultation and self-congratulation, the pride of exclusive possession or acceptance, all these emotions, in short, which are summed up in the lover's triumphant monosyllable, "Mine." Thus, from the lowest point of the scale to the highest, we may observe that the element of personal advantage or monopoly in human gratifications seems to exclude them from the kingdom of fine art. The pleasures of fine art, so far as concerns their passive or receptive part, seem to define themselves as pleasures of gratified contemplation, but of such contemplation only when it is disinterested—which is simply another way of saying, when it is unconcerned with ideas of utility.

Modern speculation has tended in some degree to modify and obscure this old and established view of the pleasures of fine art by urging that the hearer or spectator is not after all so free from self-interest as he seems; that in the act of artistic contemplation he experiences an enhancement or expansion of his being which is in truth a gain of the egoistic kind; that in witnessing a play, for instance, a large part of his enjoyment consists in sympathetically identifying himself with the successful lover or the virtuous hero. All this may be true, but does not really affect the argument, since at the same time he is well aware that every other spectator or auditor present may be similarly engaged with himself. At most the objection only requires us to define a little more closely, and to say that the satisfactions of the ego excluded from among the pleasures of fine art are not these ideal, sympathetic, indirect satisfactions, which every one can share together, but only those which arise from direct, private and incommunicable advantage to the individual.

Next, let us consider another generally accepted observation concerning the nature of the fine arts, and one, this time, relating to the disposition and state of mind of the practising artist himself. While for success in other arts it is only necessary to learn their rules and to apply them until practice gives facility, in the fine arts, it is commonly and justly said, rules and their application will carry but a little way towards success. All that can depend on rules, on knowledge, and on the application of knowledge by practice, the artist must indeed acquire, and the acquisition is often very complicated and laborious. But outside of and beyond such acquisitions he must trust to what is called genius or imagination, that is, to the spontaneous working together of an incalculably complex group of faculties, reminiscences, preferences, emotions, instincts in his constitution. This characteristic of the activities of the artist is a direct consequence or corollary of the fundamental fact that the art he practices is independent of utility. A utilitarian end is necessarily a determinate and prescribed end, and to every end which is determinate and prescribed there must be one road which is the best. Skill in any useful art means knowing practically, by rules and the application of rules, the best road to the particular

Pleasures of fine art disinterested.

An objection and its answer.

Fine arts cannot be practised by rule and precept.

ends of that art. Thus the farmer, the engineer, the carpenter, the builder so far as he is not concerned with the look of his buildings, the weaver so far as he is not concerned with the designing of the patterns which he weaves, possesses each his peculiar skill, but a skill to which fixed problems are set, and which, if it indulges in new inventions and combinations at all, can indulge them only for the sake of an improved solution of those particular problems. The solution once found, the invention once made, its rules can be written down, or at any rate its practice can be imparted to others who will apply it in their turn. Whereas no man can write down, in a way that others can act upon, how Beethoven conquered unknown kingdoms in the world of harmony, or how Rembrandt turned the aspects of gloom, squalor and affliction into pictures as worthy of contemplation as those into which the Italians before him had turned the aspects of spiritual exaltation and shadowless day. The reason why the operations of the artist thus differ from the operations of the ordinary craftsman or artificer is that his ends, being ends other than useful, are not determinate nor fixed as theirs are. He has large liberty to choose his own problems, and may solve each of them in a thousand different ways according to the prompting of his own ordering or creating instincts. The musical composer has the largest liberty of all. Having learned what is learnable in his art, having mastered the complicated and laborious rules of musical form, having next determined the particular class of the work which he is about to compose, he has then before him the whole inexhaustible world of appropriate successions and combinations of emotional sound. He is merely directed and not fettered, in the case of song, cantata, oratorio or opera, by the sense of the words which he has to set. The value of the result depends absolutely on his possessing or failing to possess powers which can neither be trained in nor communicated to any man. And this double freedom, alike from practical service and from the representation of definite objects, is what makes music in a certain sense the typical fine art, or art of arts. Architecture shares one-half of this freedom. It has not to copy or represent natural objects; for this service it calls in sculpture to its aid; but architecture is without the other half of freedom altogether. The architect has a sphere of liberty in the disposition of his masses, lines, colours, alternations of light and shadow, of plain and ornamented surface, and the rest; but upon this sphere he can only enter on condition that he at the same time fulfils the strict practical task of supplying the required accommodation, and obeys the strict mechanical necessities imposed by the laws of weight, thrust, support, resistance and other properties of solid matter. The sculptor again, the painter, the poet, has each in like manner his sphere of necessary facts, rules and conditions corresponding to the nature of his task. The sculptor must be intimately versed both in the surface aspects and the inner mechanism of the human frame alike in rest and motion, and in the rules and conditions for its representation in solid form; the painter in a much more extended range of natural facts and appearances, and the rules and conditions for representing them on a plane surface; the poet's art of words has its own not inconsiderable basis of positive and disciplined acquisition. So far as rules, precepts, formulas and other communicable laws or secrets can carry the artist, so far also the spectator can account for, analyse, and, so to speak, tabulate the effects of his art. But the essential character of the artist's operation, its very bloom and virtue, lies in those parts of it which fall outside this range of regulation on the one hand and analysis on the other. His merit varies according to the felicity with which he is able, in that region, to exercise his free choice and frame his individual ideal, and according to the tenacity with which he strives to grasp and realize his choice, or to attain perfection according to that ideal.

In this connexion the question naturally arises, In what way do the progress and expansion of mechanical art affect the power and province of fine art? The great practical movement of the world in our age is a movement for the development of mechanical inventions and multiplication of mechanical pro-

ducts. So far as these inventions are applied to purposes purely useful, and so far as their products do not profess to offer anything delightful to contemplation, this movement in no way concerns our argument. But there is a vast multitude of products which do profess qualities of pleasantness, and upon which the ornaments intended to make them pleasurable are bestowed by machinery; and in speaking of these we are accustomed to the phrases art-industry, industrial art, art manufactures and the like. In these cases the industry or ingenuity which directs the machine is not fine art at all, since the object of the machine is simply to multiply as easily and as perfectly as possible a definite and prescribed impress or pattern. This is equally true whether the machine is a simple one, like the engraver's press, for producing and multiplying impressions from an engraved plate, or a highly complex one, like the loom, in which elaborate patterns of carpet or curtain are set for weaving. In both cases there exists behind the mechanical industry an industry which is one of fine art in its degree. In the case of the engraver's press, there exists behind the industry of the printer the art of the engraver, which, if the engraver is also the free inventor of the design, is then a fine art, or, if he is but the interpreter of the invention of another, is then in its turn a semi-mechanical skill applied in aid of the fine art of the first inventor. In the case of the weaver's loom there is, behind the mechanical industry which directs the loom at its given task, the fine art, or what ought to be the fine art, of the designer who has contrived the pattern. In the case of the engraving, the mechanical industry of printing only exists for the sake of bringing out and disseminating abroad the fine art employed upon the design. In the case of the carpet or curtain, the fine art is often only called in to make the product of the useful or mechanical industry of the loom acceptable, since the eye of man is so constituted as to receive pleasure or the reverse of pleasure from whatever it rests upon, and it is to the interest of the manufacturer to have his product so made as to give pleasure if it can. Whether the machine is thus a humble servant to the artist, or the artist a kind of humble purveyor to the machine, the fine art in the result is due to the former alone; and in any case it reaches the recipient at second-hand, having been put in circulation by a medium not artistic but mechanical.

Again, with reference not to the application of mechanical contrivances but to their invention; is not, it may be inquired, the title of artist due to the inventor of some of the astonishingly complex and astonishingly efficient machines of modern times? Does he not spend as much thought, labour, genius as any sculptor or musician in perfecting his construction according to his ideal, and is not the construction when it is done—so finished, so responsive in all its parts, so almost human—is not that worthy to be called a work of fine art? The answer is that the inventor has a definite and practical end before him; his ideal is not *free*; he deserves all credit as the perfecter of a particular instrument for a prescribed function, but an artist, a free follower of the fine arts, he is not; although we may perhaps have to concede him a narrow sphere for the play of something like an artistic sense when he contrives the proportion, arrangement, form or finish of the several parts of his machine in one way rather than another, not because they work better so but simply because their look pleases him better.

Returning from this digression, let us consider one common observation more on the nature of the fine arts. They are activities, it is said, which were put forth not because they need but because they like. They have the activity to spare, and to put it forth in this way pleases them. Fine art is to mankind what play is to the individual, a free and arbitrary vent for energy which is not needed to be spent upon tasks concerned with the conservation, perpetuation or protection of life. To insist on the superfluous or optional character of the fine arts, to call them the play or pastime of the human race as distinguished from its inevitable and sterner tasks, is obviously only to reiterate our fundamental

Fine arts and machinery: "art manufactures."

Perfected machines: are they works of fine art?

Fine arts called a kind of play.

distinction between the fine arts and the useful or necessary. But the distinction, as expressed in this particular form, has been interpreted in a great variety of ways and followed out to an infinity of conclusions, conclusions regarding both the nature of the activities themselves and the character and value of their results.

For instance, starting from this saying that the aesthetic activities are a kind of play, the English psychology of association goes back to the spontaneous cries and movements of children, in which their superfluous energies find a vent. It then enumerates pleasures of which the human constitution is capable apart from direct advantage or utility. Such are the primitive or organic pleasures of sight and hearing, and the secondary or derivative pleasures of association or unconscious reminiscence and inference that soon become mixed up with these. Such are also the pleasures derived from following any kind of mimicry, or representation of things real or like reality. The association psychology describes the grouping within the mind of predilections based upon these pleasures; it shows how the growing organism learns to govern its play, or direct its superfluous energies, in obedience to such predilections, till in mature individuals, and still more in mature societies, a highly regulated and accomplished group of leisure activities are habitually employed in supplying to a not less highly cultivated group of disinterested sensibilities their appropriate artistic pleasures. It is by Herbert Spencer that this view has been most fully and systematically worked out.

Again, in the views of an ancient philosopher, Plato, and a modern poet, Schiller, the consideration that the artistic activities are in the nature of play, and the manifestations of which they result independent of realities and utilities, has led to judgments so differing as the following. Plato held that the daily realities of things in experience are not realities, indeed, but only far-off shows or reflections of the true realities, that is, of certain ideal or essential forms which can be apprehended as existing by the mind. Holding this, Plato saw in the works of fine art but the reflections of reflections, the shows of shows, and depreciated them according to their degree of remoteness from the ideal, typical or sense-transcending existences. He sets the arts of medicine, agriculture, shoemaking and the rest above the fine arts, inasmuch as they produce something serious or useful (*σπουδαῖόν τι*). Fine art, he says, produces nothing useful, and makes only semblances (*εἰδωλοποιϊκή*), whereas what mechanical art produces are utilities, and even in the ordinary sense realities (*ἀυτοποιητικῆ*).

In another age, and thinking according to another system, Schiller, so far from holding thus cheap the kingdom of play and show, regarded his sovereignty over that kingdom as the noblest prerogative of man. Schiller wrote his famous *Letters on the Aesthetic Education of Man* in order to throw into popular currency, and at the same time to modify and follow up in a particular direction, certain metaphysical doctrines which had lately been launched upon the schools by Kant. The spirit of man, said Schiller after Kant, is placed between two worlds, the physical world or world of sense, and the moral world or world of will. Both of these are worlds of constraint or necessity. In the sensible world, the spirit of man submits to constraint from without; in the moral world, it imposes constraint from within. So far as man yields to the importunities of sense, in so far he is bound and passive, the subject of outward shocks and victim of irrational forces. So far as he asserts himself by the exercise of will, imposing upon sense and outward things the dominion of the moral law within him, in so far he is free and active, the rational lord of nature and not her slave. Corresponding to these two worlds, he has within him two conflicting impulses or impulsions of his nature, the one driving him towards one way of living, the other towards another. The one, or sense-impulsion (*Stofftrieb*), Schiller thinks of as that which enslaves the spirit of man as the victim of matter, the other or moral impulsion (*Formtrieb*) as that which enthrones it as the dictator of form. Between the two

the conflict at first seems inveterate. The kingdom of brute nature and sense, the sphere of man's subjection and passivity, wages war against the kingdom of will and moral law, the sphere of his activity and control, and every conquest of the one is an encroachment upon the other. Is there, then, no hope of truce between the two kingdoms, no ground where the two contending impulses can be reconciled? Nay, the answer comes, there is such a hope; such a neutral territory there exists. Between the passive kingdom of matter and sense, where man is compelled blindly to feel and be, and the active kingdom of law and reason, where he is compelled sternly to will and act, there is a kingdom where both sense and will may have their way, and where man may give the rein to all his powers. But this middle kingdom does not lie in the sphere of practical life and conduct. It lies in the sphere of those activities which neither subserve any necessity of nature nor fulfil any moral duty. Towards activities of this kind we are driven by a third impulsion of our nature not less essential to it than the other two, the impulsion, as Schiller calls it, of Play (*Spieltrieb*). Relatively to real life and conduct, play is a kind of harmless show; it is that which we are free to do or leave undone as we please, and which lies alike outside the sphere of needs and duties. In play we may do as we like, and no mischief will come of it. In this sphere man may put forth all his powers without risk of conflict, and may invent activities which will give a complete ideal satisfaction to the contending faculties of sense and will at once, to the impulses which bid him feel and enjoy the shocks of physical and outward things, and the impulse which bids him master such things, control and regulate them. In play you may impose upon Matter what Form you choose, and the two will not interfere with one another or clash. The kingdom of Matter and the kingdom of Form thus harmonized, thus reconciled by the activities of play and show, will in other words be the kingdom of the Beautiful. Follow the impulsion of play, and to the beautiful you will find your road; the activities you will find yourself putting forth will be the activities of aesthetic creation—you will have discovered or invented the fine arts. "Midway"—these are Schiller's own words—"midway between the formidable kingdom of natural forces and the hallowed kingdom of moral laws, the impulse of aesthetic creation builds up a third kingdom unperceived, the gladsome kingdom of play and show, wherein it emancipates man from all compulsion alike of physical and of moral forces." Schiller, the poet and enthusiast, thus making his own application of the Kantian metaphysics, goes on to set forth how the fine arts, or activities of play and show, are for him the typical, the ideal activities of the race, since in them alone is it possible for man to put forth his whole, that is his ideal self. "Only when he plays is man really and truly man." "Man ought only to play with the beautiful, and he ought to play with the beautiful only." "Education in taste and beauty has for its object to train up in the utmost attainable harmony the whole sum of the powers, both of sense and spirit." And the rest of Schiller's argument is addressed to show how the activities of artistic creation, once invented, react upon other departments of human life, how the exercise of the play impulse prepares men for an existence in which the inevitable collision of the two other impulses shall be softened or averted more and more. That harmony of the powers which clash so violently in man's primitive nature, having first been found possible in the sphere of the fine arts, reflects itself, in his judgment, upon the whole composition of man, and attunes him, as an aesthetic being, into new capabilities for the conduct of his social existence.

Our reasons for dwelling on this wide and enthusiastic formula of Schiller's are both its importance in the history of reflection—it remained, indeed, for nearly a century a formula almost classical—and the measure of positive value which it still retains. The notion of a sphere of voluntary activity for the human spirit, in which, under no compulsion of necessity or conscience, we order matters as we like them apart from any practical end, seems coextensive with the widest conception of fine art and the fine arts as they exist in civilized and developed communities.

The play idea as worked out by the English associationists.

By Plato.

By Schiller.

The strong points of Schiller's theory.

It insists on and brings into the light the free or optional character of these activities, as distinguished from others to which we are compelled by necessity or duty, as well as the fact that these activities, superfluous as they may be from the points of view of necessity and of duty, spring nevertheless from an imperious and a saving instinct of our nature. It does justice to the part which is, or at any rate may be, filled in the world by pleasures which are apart from profit, and by delights for the enjoyment of which men cannot quarrel. It claims the dignity they deserve for those shows and pastimes in which we have found a way to make permanent all the transitory delights of life and nature, to turn even our griefs and yearnings, by their artistic utterance, into sources of appeasing joy, to make amends to ourselves for the confusion and imperfection of reality by conceiving and imaging forth the semblances of things clearer and more complete, since in contriving them we incorporate with the experiences we have had the better experiences we have dreamed of and longed for.

One manifestly weak point of Schiller's theory is that though it asserts that man ought only to play with the beautiful, and that he is his best or ideal self only when he does so, yet it does not sufficiently indicate what kinds of play are beautiful nor why we are moved to adopt them. It does not show how the delights of the eye and spirit in contemplating forms, colours and movements, of the ear and spirit in apprehending musical and verbal sounds, or of the whole mind at once in following the comprehensive current of images called up by poetry—it does not clearly show how delights like these differ from those yielded by other kinds of play or pastime, which are by common consent excluded from the sphere of fine art.

The chase, for instance, is a play or pastime which gives scope for any amount of premeditated skill; it has pleasures, for those who take part in it, which are in some degree analogous to the pleasures of the artist; we all know the claims made on behalf of the noble art of venery (following true medieval precedent) by the knights and woodmen of Sir Walter Scott's romances. It is an obvious reply to say that though the chase is play to us, who in civilized communities follow it on no plea of necessity, yet to a not remote ancestry it was earnest; in primitive societies hunting does not belong to the class of optional activities at all, but is among the most pressing of utilitarian needs. But this reply loses much of its force since we have learnt how many of the fine arts, however emancipated from direct utility now, have as a matter of history been evolved out of activities primarily utilitarian. It would be more to the point to remark that the pleasures of the sportsman are the only pleasures arising from the chase; his exertions afford pain to the victim, and no satisfaction to any class of recipients but himself; or at least the sympathetic pleasures of the lookers-on at a hunt or at a battle are hardly to be counted as pleasures of artistic contemplation. The issue which they witness is a real issue; the skilled endeavours with which they sympathize are put forth for a definite practical result, and a result disastrous to one of the parties concerned.

What then, it may be asked, about athletic games and sports, which hurt nobody, have no connexion with the chase, and give pleasure to thousands of spectators? Here the difference is, that the event which excites the spectator's interest and pleasure at a race or match or athletic contest is not a wholly unreal or simulated event; it is less real than life, but it is more real than art. The contest has no momentous practical consequences, but it is a contest, an *ἀθλος*, all the same, in which competitors put forth real strength, and one really wins and others are defeated. Such a struggle, in which the exertions are real and the issue uncertain, we follow with an excitement and a suspense different in kind from the feelings with which we contemplate a fictitious representation. For example, let the reader recall the feelings with which he may have watched a real fencing bout, and compare them with those with which he watches the simulated fencing bout in Shakespeare's *Hamlet*.

The instance is a crucial one, because in the fictitious case the excitement is heightened by the introduction of the poisoned foil, and by the tremendous consequences which we are aware will turn, in the representation, on the issue. Yet because the fencing scene in *Hamlet* is a representation, and not real, we find ourselves watching it in a mood quite different from that in which we watch the most ordinary real fencing-match with vizors and blunt foils; a mood more exalted, if the representation is good, but amid the aesthetic emotions of which the fluctuations of strained, if trivial, suspense and the eagerness of sympathetic participation find no place. "The delight of tragedy," says Johnson, "proceeds from our consciousness of fiction; if we thought murders and treasons real, they would please no more." So does the peculiar quality of our pleasure in watching the fencing-match in *Hamlet*, or the wrestling-match in *As You Like It*, depend on our consciousness of fiction: if we thought the matches real they might please us still, but please us in a different way. Again, of athletics in general, they are pursuits to a considerable degree definitely utilitarian, having for their specific end the training and strengthening of individual human bodies. Nevertheless, in some systems the title of fine arts has been consistently claimed, if not for athletics technically so called, and involving the idea of competition and defeat, at any rate for gymnastics, regarded simply as a display of the physical frame of man cultivated by exercise—as, for instance, it was cultivated by the ancient Greeks—to an ideal perfection of beauty and strength.

But apart from criticisms like these on the theory of Schiller, the Kantian doctrine of a metaphysical opposition between the senses and the reason has for most minds of to-day lost its validity, and with it falls away Schiller's derivative theory of a *Stofftrieb* and a *Formtrieb* contending like enemies for dominion over the human spirit, with a neutral or reconciling *Spieltrieb* standing between them. Even taking the existence of the *Spieltrieb*, or play-impulse, by itself as a plain and indubitable fact in human nature, the theory that this impulse is the general or universal source of the artistic activities of the race, which seemed adequate to thinkers so far apart as Schiller and Herbert Spencer, is found no longer to hold water. The tendency of recent thought and study on these subjects has been to abandon the abstract or dialectical method in favour of the methods of historical and anthropological inquiry. In the light of these methods it is claimed that the artistic activities of the race spring in point of fact from no single source but from a number of different sources. It is admitted that the play-impulse is one of these, and the allied and overlapping, but not identical, impulse of mimicry or imitation another. But it is urged at the same time that these twin impulses, rooted as they both are among the primordial faculties both of men and animals, are far from existing merely to provide a vent whereby the superfluous energies of sentient beings may discharge themselves at pleasure, but are indispensable utilitarian instincts, by which the young are led to practise and rehearse in sport those activities the exercise of which in earnest will be necessary to their preservation in the adult state. (The researches of Professor Karl Groos in this field seem to be conclusive.) A third impulse innate in man, though scarcely so primordial as the other two, and one which the animals cannot share with him, is the impulse of record or commemoration. Man instinctively desires, alike for safety, use and pleasure, to perpetuate and hand on the memory of his deeds and experiences whether by words or by works of his hands contrived for permanence. This impulse of record is the most stimulating ally of the impulse of mimicry or imitation, and perhaps a large part of the arts usually put down as springing from the love of imitation ought rather to be put down as springing from the commemorative or recording impulse, using imitation as its necessary means. Granting the existence in primitive man of these three allied impulses of play, of mimicry, and of record, it is urged that they are so many distinct though contiguous sources from which whole groups of the fine arts have sprung, and that all three in their origin

The play theory in the light of anthropological research.

served ends primarily or in great part utilitarian. Examining any of the rudimentary artistic activities of primitive man already mentioned: the decoration of the person with tattooings or strings of shells or teeth or leathers had primarily the object of attracting or impressing the opposite sex, or terrifying an enemy, or indicating the tribal relations of the person so adorned; some of the same purposes were served by the scratches and tufts and markings on weapons or utensils; the *graffiti* or outline drawings of animals incised by cave-dwellers on bones are surmised to have sprung in like manner from the desire of conveying information, combined, probably, sometimes with that of obtaining magic power over the things represented; the erection of memorial shrines and images of all kinds, from the rudest upwards, had among other purposes the highly practical one of propitiating the spirits of the departed; and so on through the whole range of kindred activities. It is contended, next, that such activities only take on the character of rudimentary fine arts at a certain stage of their evolution. Before they can assume that character, they must come under the influence and control of yet another rooted and imperious impulse in mankind. That is the impulse of emotional self-expression, the instinct which compels us to seek relief under the stimulus of pent-up feeling; an instinct, it is added, second only in power to those which drive us to seek food, shelter, protection from enemies, and satisfaction for sexual desires. According to a law of our constitution, the argument goes on, this need for emotional self-expression finds itself fully satisfied only by certain modes of activity; those, namely, which either have in themselves, or impress on their products, the property of rhythm, that is, of regular interval and recurrence, flow, order and proportion. Leaping, shouting, and clapping hands is the human animal's most primitive way of seeking relief under the pressure of emotion; so soon as one such animal found out that he both expressed and relieved his emotions best, and communicated them best to his fellows, when he moved in regular rhythm and shouted in regular time and with regular changes of pitch, he ceased to be a mere excited savage and became a primitive dancer, singer, musician—in a word, artist. So soon as another found himself taking pleasure in certain qualities of regular interval, pattern and arrangement of lines, shapes and colours, apart from all questions of purpose or utility, in his tattooings and self-adornments, his decoration of tools or weapons or structures for shelter or commemoration, he in like manner became a primitive artist in ornamental and imitative design.

The special qualities of pleasure felt and communicated by doing things in one way rather than another, independently of direct utility, which we indicated at the outset as characteristic of the whole range of the fine arts, appear on this showing to be dependent primarily on the response of our organic sensibilities of nerve and muscle, eye, ear and brain to the stimulus of rhythm (using the word in its widest sense) imparted either to our own actions and utterances or to the works of our hands. Such pleasures would seem to have been first experienced by man directly, in the endeavour to find relief with limbs and voice from states of emotional tension, and then incidentally, as a kind of by-product arising and affording similar relief in the development of a wide range of utilitarian activities. Into the nature of those organic sensibilities, and the grounds of the relief they afford us when gratified, it is the province of physiological and psychological aesthetics to inquire: our business here is only with the activities directed towards their satisfaction and the results of those activities in the works of fine art. On the whole the account of the matter yielded by the method of anthropological research, and here very briefly summarized, may be accepted as answering more closely to the complex nature of the facts than any of the accounts hitherto current; and so we may expand our first tentative suggestion of a definition into one more complete, which from the nature of the case cannot be very brief or simple and must run somehow thus: *Fine art is everything which man does or makes in one way rather than another, freely and with premeditation, in order to express*

and arouse emotion, in obedience to laws of rhythmic movement or utterance or regulated design, and with results independent of direct utility and capable of affording to many permanent and disinterested delight.

II. Of the Fine Arts severally.

Architecture, sculpture, painting, music and poetry are by common consent, as has been said at the outset, the five principal or greater fine arts practised among developed communities of men. It is possible in thought to group these five arts in as many different orders as there are among them different kinds of relation or affinity. One thinker fixes his attention upon one kind of relations as the most important, and arranges his group accordingly; another upon another; and each, when he has done so, is very prone to claim for his arrangement the virtue of being the sole essentially and fundamentally true. For example, we may ascertain one kind of relations between the arts by inquiring which is the simplest or most limited in its effects, which next simplest, which another degree less simple, which least simple or most complex of them all. This, the relation of progressive complexity or comprehensiveness between the fine arts, is the relation upon which Auguste Comte fixed his attention, and it yields in his judgment the following order:—Architecture lowest in complexity, because both of the kinds of effects which it produces and of the material conditions and limitations under which it works; sculpture next; painting third; then music; and poetry highest, as the most complex or comprehensive art of all, both in its own special effects and in its resources for ideally calling up the effects of all the other arts as well as all the phenomena of nature and experiences of life. A somewhat similar grouping was adopted, though from the consideration of a wholly different set of relations, by Hegel. Hegel fixed his attention on the varying relations borne by the idea, or spiritual element, to the embodiment of the idea, or material element, in each art. Leaving aside that part of his doctrine which concerns, not the phenomena of the arts themselves, but their place in the dialectical world-plan or scheme of the universe, Hegel said in effect something like this. In certain ages and among certain races, as in Egypt and Assyria, and again in the Gothic age of Europe, mankind has only dim ideas for art to express, ideas insufficiently disengaged and realized, of which the expression cannot be complete or lucid, but only adumbrated and imperfect; the characteristic art of those ages is a symbolic art, with its material element predominating over and keeping down its spiritual; and such a symbolic art is architecture. In other ages, as in the Greek age, the ideas of men have come to be definite, disengaged, and clear; the characteristic art of such an age will be one in which the spiritual and material elements are in equilibrium, and neither predominates over nor keeps down the other, but a thoroughly realized idea is expressed in a thoroughly adequate and lucid form; this is the mode of expression called classic, and the classic art is sculpture. In other ages, again, and such are the modern ages of Europe, the idea grows in power and becomes importunate; the spiritual and material elements are no longer in equilibrium, but the spiritual element predominates; the characteristic arts of such an age will be those in which thought, passion, sentiment, aspiration, emotion, emerge in freedom, dealing with material form as masters or declining its shackles altogether; this is the romantic mode of expression, and the romantic arts are painting, music and poetry. A later systematizer, Lotze, fixed his attention on the relative degrees of freedom or independence which the several arts enjoy—their freedom, that is, from the necessity of either imitating given facts of nature or ministering, as part of their task, to given practical uses. In his grouping, instead of the order architecture, sculpture, painting, music, poetry, music comes first, because it has neither to imitate any natural facts nor to serve any practical end; architecture next, because, though it is tied to useful ends and material conditions, yet it is free from the task of imitation, and pleases the eye in its degree, by pure form, light and shade, and the rest, as music

Modes in which the five greater arts have been classified.

pleases the ear by pure sound; then, as arts all tied to the task of imitation, sculpture, painting and poetry, taken in progressive order according to the progressing comprehensiveness of their several resources.

The thinker on these subjects has, moreover, to consider the enumeration and classification of the lesser or subordinate fine arts. Whole clusters or families of these occur to the mind at once; such as *dancing*, an art subordinate to music, but quite different in kind; *acting*, an art auxiliary to *poetry*, from which in kind it differs no less; *eloquence* in all kinds, so far as it is studied and not merely spontaneous; and among the arts which fashion or dispose material objects, *embroidery* and the weaving of patterns, *pottery*, *glassmaking*, *goldsmith's work* and *jewelry*, *joiner's work*, *gardening* (according to the claim of some), and a score of other dexterities and industries which are more than mere dexterities and industries because they add elements of beauty and pleasure to elements of serviceableness and use. To decide whether any given one of these has a right to the title of fine art, and, if so, to which of the greater fine arts it should be thought of as appended and subordinate, or between which two of them intermediate, is often no easy task.

The weak point of all classifications of the kind of which we have above given examples is that each is intended to be final, and to serve instead of any other. The truth is, that the relations between the several fine arts are much too complex for any single classification to bear this character. Every classification of the fine arts must necessarily be provisional, according to the particular class of relations which it keeps in view. And for practical purposes it is requisite to bear in mind not one classification but several. Fixing our attention, not upon complicated or problematical relations between the various arts, but only upon their simple and undisputed relations, and giving the first place in our consideration to the five greater arts of architecture, sculpture, painting, music and poetry, we shall find at least three principal modes in which every fine art either resembles or differs from the rest.

1. *The Shaping and the Speaking Arts (or Arts of Form and Arts of Utterance, or Arts of Space and Arts of Time).*—Each of the greater

First classification: the shaping and the speaking arts.

arts either makes something or not which can be seen and handled. The arts which make something which can be seen and handled are architecture, sculpture and painting. In the products or results of all these arts external matter is in some way or another manually put together, fashioned or disposed. But music and poetry do not produce any results of this kind. What music produces is something that can be heard, and what poetry produces is something that can be either heard or read—which last is a kind of ideal hearing, having for its avenue the eye instead of the ear, and for its material, written signs for words instead of the spoken words themselves. Now what the eye sees from any one point of view, it sees all at once; in other words, the parts of anything we see fill or occupy not time but space, and reach us from various points in space at a single simultaneous perception. If we are at the proper distance we see at one glance a house from the ground to the chimneys, a statue from head to foot, and in a picture at once the foreground and background, and everything that is within the four corners of the frame. There is, indeed, this distinction to be drawn, that in walking round or through a temple, church, house or any other building, new parts and proportions of the building unfold themselves to view; and the same thing happens in walking round a statue or turning it on a turntable: so that the spectator, by his own motions and the time it takes to effect them, can impart to architecture and sculpture something of the character of time arts. But their products, as contemplated from any one point of view, are in themselves solid, stationary and permanent in space. Whereas the parts of anything we hear, or, reading, can imagine that we hear, fill or occupy not space at all but time, and can only reach us from various points in time through a continuous series of perceptions, or, in the case of reading, of images raised by words in the mind. We have to wait, in music, while one note follows another in a theme, and one theme another in a movement; and in poetry, while one line with its images follows another in a stanza, and one stanza another in a canto, and so on. It is a convenient form of expressing both aspects of this difference between the two groups of arts, to say that architecture, sculpture and painting are arts which give shape to things in space, or, more briefly, *shaping arts*; and music and poetry arts which give utterance to things in time, or, more briefly, *speaking arts*. These simple terms of the *shaping* and the *speaking* arts (the

equivalent of the Ger. *bildende und redende Künste*) are not usual in English; but they seem appropriate and clear; the simplest alternatives for their use is to speak of the *manual* and the *vocal* arts, or the arts of *space* and the arts of *time*. This is practically, if not logically, the most substantial and vital distinction upon which a classification of the fine arts can be based. The arts which surround us in space with stationary effects for the eye, as the house we live in, the pictures on the walls, the marble figure in the vestibule, are stationary, hold a different kind of place in our experience—not a greater or a higher place, but essentially a different place—from the arts which provide us with transitory effects in time, effects capable of being awakened for the ear or mind at any moment, as a symphony is awakened by playing and an ode by reading, but lying in abeyance until we bid that moment come, and passing away when the performance or the reading is over. Such, indeed, is the practical force of the distinction that in modern usage the expression *fine art*, or even *art*, is often used by itself in a sense which tacitly excludes music and poetry, and signifies the group of manual or shaping arts alone.

As between three of the five greater arts and the other two, the distinction on which we are now dwelling is complete. Buildings, statues, pictures, belong strictly to sight and space; to time and to hearing, real through the ear, or ideal through the mind in reading, belong music and poetry. Among the lesser or subordinate arts, however, there are several in which this distinction finds no place, and which produce, in space and time at once, effects midway between the stationary or stable, and the transitory or fleeting. Such is the *dramatic art*, in which the actor makes with his actions and gestures, or several actors make with the combination of their different actions and gestures, a kind of shifting picture, which appeals to the eyes of the witnesses while the sung or spoken words of the drama appeal to their ears; thus making of them spectators and auditors at once, and associating with the pure time art of words the mixed time-and-space art of bodily movements. As all movement whatsoever is necessarily movement through space, and takes time to happen, so every other fine art which is wholly or in part an act of movement partakes in like manner of this double character. Along with acting thus comes *dancing*. Dancing, when it is of the mimic character, may itself be a kind of acting; historically, indeed, the dancer's art was the parent of the actor's; whether apart from or in conjunction with the mimic element, dancing is an art in which bodily movements obey, accompany, and, as it were, express or accentuate in space the time effects of music. *Eloquence* or oratory in like manner, so far as its power depends on studied and premeditated gesture, is also an art which to some extent enforces its primary appeal through the ear in time by a secondary appeal through the eye in space. So much for the first distinction, that between the shaping or space arts and the speaking or time arts, with the intermediate and subordinate class of arts which, like acting, dancing, oratory, add to the pure time element a mixed time-and-space element. These last can hardly be called shaping arts, because it is his own person, and not anything outside himself, which the actor, the dancer, the orator disposes or adjusts; they may perhaps best be called arts of motion, or moving arts.

2. *The Imitative and the Non-Imitative Arts.*—Each art either does or does not represent or imitate something which exists already in nature. Of the five greater fine arts, those which thus represent objects existing in nature are sculpture, painting and poetry. Those which do not represent anything so existing are music and architecture. On this principle we get a new grouping. Two shaping or space arts and one speaking or time art now form the imitative group of sculpture, painting and poetry; while one space art and one time art form the non-imitative group of music and architecture. The mixed space-and-time arts of the actor, and of the dancer, so far as he or she is also a mimic, belong, of course, by their very name and nature, to the imitative class.

It was the imitative character of the fine arts which chiefly occupied the attention of Aristotle. But in order to understand the art theories of Aristotle it is necessary to bear in mind the very different meanings which the idea of imitation bore to his mind and bears to ours. For Aristotle the idea of imitation or representation (*mimesis*) was extended so as to denote the expressing, evoking or making manifest of anything whatever, whether material objects or ideas or feelings. Music and dancing, by which utterance or expression is given to emotions that may be quite detached from all definite ideas or images, are thus for him varieties of imitation. He says, indeed, *most* music and dancing, as if he was aware that there were exceptions, but he does not indicate what the exceptions are; and under the head of imitative music, he distinctly reckons some kinds of instrumental music without words. But in our own more restricted usage, to imitate means to copy, mimic or represent some existing phenomenon, some definite reality of experience; and we can only call those imitative arts which bring before us such things, either directly by showing us their actual likeness, as sculpture does in solid form, and as painting does by means of lines and colours on a plane surface, or else indirectly, by calling up ideas or images of them in the mind, as poetry and literature do by means of words. It is by a stretch of ordinary usage

Intermediate class of arts of motion.

Second classification: the imitative and non-imitative arts.

The imitative functions of art according to Aristotle.

that we apply the word imitation even to this last way of representing things; since words are no true likeness of, but only customary signs for, the thing they represent. And those arts we cannot call imitative at all, which by combinations of abstract sound or form express and arouse emotions unattended by the recognizable likeness, idea or image of any definite thing.

Now the emotions of music when music goes along with words, whether in the shape of actual song or even of the instrumental accompaniment of song, are no doubt in a certain sense attended with definite ideas; those, namely, which are expressed by the words themselves. But the same ideas would be conveyed to the mind equally well by the same words if they were simply spoken. What the music contributes is a special element of its own, an element of pure emotion, aroused through the sense of hearing, which heightens the effect of the words upon the feelings without helping to elucidate them for the understanding. Nay, it is well known that a song well sung produces its intended effect upon the feelings almost as fully though we fail to catch the words or are ignorant of the language to which they belong. Thus the view of Aristotle cannot be defended on the ground that he was familiar with music only in an elementary form, and principally as the direct accompaniment of words, and that in his day the modern development of the art, as an art for building up constructions of independent sound, vast and intricate fabrics of melody and harmony detached from words, was a thing not yet imagined. That is perfectly true; the immense technical and intellectual development of music, both in its resources and its capacities, is an achievement of the modern world; but the essential character of musical sound is the same in its most elementary as in its most complicated stage. Its privilege is to give delight, not by communicating definite ideas, or calling up particular images, but by appealing to certain organic sensibilities in our nerves of hearing, and through such appeal expressing on the one part and arousing on the other a unique kind of emotion. The emotion caused by music may be altogether independent of any ideas conveyable by words. Or it may serve to intensify and enforce other emotions arising at the same time in connexion with the ideas conveyed by words; and it was one of the contentions of Richard Wagner that in the former phase the art is now exhausted, and that only in the latter are new conquests in store for it. But in either case the music is the music, and *is like nothing else*; it is no representation or similitude of anything whatsoever.

But does not instrumental music, it will be said, sometimes really imitate the sounds of nature, as the piping of birds, the whispering of woods, the moaning of storms or explosion of thunder; or does it not, at any rate, suggest these things by resemblances so close that they almost amount in the strict sense to imitation? Occasionally, it is true, music does allow itself these playful excursions into a region of quasi-imitation or mimicry. It modifies the character of its abstract sounds into something, so to speak, more concrete, and, instead of sensations which are like nothing else, affords us sensations which recognizably resemble those we receive from some of the sounds of nature. But such excursions are hazardous, and to make them often is the surest proof of vulgarity in a musician. Neither are the successful effects of the great composers in evoking ideas of particular natural phenomena generally in the nature of real imitations or representations; although passages such as the notes of the dove and nightingale in Haydn's *Creation*, and of the cuckoo in Beethoven's *Pastoral Symphony*, the bleating of the sheep in the *Don Quixote* symphony of Richard Strauss, must be acknowledged to be exceptions. Again, it is a recognized fact concerning the effect of instrumental music on those of its hearers who try to translate such effect into words, that they will all find themselves in tolerable agreement as to the meaning of any passage so long as they only attempt to describe it in terms of vague emotion, and to say such and such a passage expresses, as the case may be, dejection or triumph, effort or the relaxation of effort, eagerness or languor, suspense or fruition, anguish or glee. But their agreement comes to an end the moment they begin to associate, in their interpretation, definite ideas with these vague emotions; then we find that what suggests in idea to one hearer the vicissitudes of war will suggest to another, or to the same at another time, the vicissitudes of love, to another those of spiritual yearning and aspiration, to another, it may be, those of changeful travel by forest, field and ocean, to another those of life's practical struggle and ambition. The infinite variety of ideas which may thus be called up in different minds by the same strain of music is proof enough that the music is not *like* any particular thing. The torrent of varied and entrancing emotion which it pours along the heart, emotion latent and undivided until the spell of sound begins, that is music's achievement and its secret. It is this effect, whether coupled or not with a trained intellectual recognition of the highly abstract and elaborate nature of the laws of the relation, succession and combinations of sounds on which the effect depends, that has caused some thinkers, with Schopenhauer at their head, to find in music the nearest approach we have to a voice from behind the veil, a universal voice expressing the central purpose and deepest essence of things, unconfused by fleeting actualities or by the distracting duty of calling up images of particular and perishable phenomena. "Music," in Schopenhauer's own words, "reveals the

innermost essential being of the world, and expresses the highest wisdom in a language the reason does not understand."

Aristotle endeavoured to frame a classification of the arts, in their several applications and developments, on two grounds—the nature of the objects imitated by each, and the means or instruments employed in the imitation. But in the case of music, as it exists in the modern world, the first part of this endeavour falls to the ground, because the object imitated has, in the sense in which we now use the word imitation, no existence. The means employed by music are successions and combinations of vocal or instrumental sounds regulated according to the three conditions of time and pitch (which together make up melody) and harmony, or the relations of different strains of time and tone co-operant but not parallel. With these means, music either creates her independent constructions, or else accompanies, adorns, enforces the imitative art of speech—but herself imitates not; and may be best defined simply as a *speaking or time art, of which the business is to express and arouse emotion by successions and combinations of regulated sound*.

That which music is thus among the speaking or time-arts, architecture is among the shaping or space-arts. As music appeals to our faculties for taking pleasure in non-imitative combinations of transitory sound, so architecture appeals to our faculties for taking pleasure in non-imitative combinations of stationary mass. Corresponding to the system of ear-effects or combinations of time, tone and harmony with which music works, architecture works with a system of eye-effects or combinations of mass, contour, light and shade, colour, proportion, interval, alternation of plain and decorated parts, regularity and variety in regularity, apparent stability, vastness, appropriateness and the rest. Only the materials of architecture are not volatile and intangible like sound, but solid timber, brick, stone, metal and mortar, and the laws of weight and force according to which these materials have to be combined are much more severe and cramping than the laws of melody and harmony which regulate the combinations of music. The architect is further subject, unlike the musician, to the dictates and precise prescriptions of utility. Even in structures raised for purposes not of everyday use and necessity, but of commemoration or worship, the rules for such commemoration and such worship have prescribed a more or less fixed arrangement and proportion of the parts or members, whether in the Egyptian temple or temple-tomb, the Greek temple or heroon, or in the churches of the middle ages and Renaissance in the West.

Hence the effects of architecture are necessarily less full of various, rapturous and unforeseen enchantment than the effects of music. Yet for those who possess sensibility to the pleasures of the eye and the perfections of shaping art, the architecture of the great ages has yielded combinations which, so far as comparison is permissible between things unlike in their materials, fall little short of the achievements of music in those kinds of excellence which are common to them both. In the virtues of lucidity, of just proportion and organic interdependence of the several parts or members, in the mathematic subtlety of their mutual relations, and of the transitions from one part or member to another, in purity and finish of individual forms, in the character of one thing growing naturally out of another and everything serving to complete the whole—in these qualities, no musical combination can well surpass a typical Doric temple such as the Parthenon at Athens. None, again, can well surpass some of the great cathedrals of the middle ages in the qualities of sublimity, of complexity, in the power both of expressing and suggesting spiritual aspiration, in the invention of intricate developments and ramifications about a central plan, in the union of majesty in the main conception with fertility of adornment in detail. In fancifulness, in the unexpected, in capricious and far-sought opulence, in filling the mind with mingled enchantments of east and west and south and north, music can hardly do more than a building like St Mark's at Venice does with its blending of Byzantine elements, Italian elements, Gothic elements, each carried to the utmost pitch of elaboration and each enriched with a hundred caprices of ornament, but all working together, all in obedience to a law, and "all beginning and ending with the Cross."

In the case of architecture, however, as in the case of music, the non-imitative character must not be stated quite without exception or reserve. There have been styles of architecture in which forms suggesting or imitating natural or other phenomena have held a place among the abstract forms proper to the art. Often the mode of such suggestions is rather symbolical to the mind than really imitative to the eye; as when the number and relations of the heavenly planets were imaged by that race of astronomers, the Babylonians, in the seven concentric walls of their great temple, and in many other architectural constructions; or as when the shape of the cross was adopted, with innumerable slight varieties and modifications, for the ground plan of the churches of Christendom. Passing to examples of imitation more properly so called, it may be true, and was, at any rate, long believed, that the aisles of Gothic churches, when once the use of the pointed arch had been evolved as a principle of construction, were partly designed to evoke the idea of the natural aisles of the forest, and that the upsoaring

Non-imitative character of music.

Definition of music.

Non-imitative character of architecture.

An objection and its answer.

Analogies of architecture and music.

Exceptional and limited admission of imitative forms in architecture.

forest trunks and meeting branches were more or less consciously imaged in their piers and vaultings. In the temple-palaces of Egypt, one of the regular architectural members, the sustaining pier, is often systematically wrought in the actual likeness of a conventionalized cluster of lotus stems, with lotus flowers for the capital. When we come to the fashion, not rare in Greek architecture, of carving this same sustaining member, the column, in complete human likeness, and employing caryatids, canephoroi, atlases or the like, to support the entablature of a building, it then becomes difficult to say whether we have to do with a work of architecture or of sculpture. The case, at any rate, is different from that in which the sculptor is called in to supply surface decoration to the various members of a building, or to fill with the products of his own art spaces in the building specially contrived and left vacant for that purpose. When the imitative feature is in itself an indispensable member of the architectural construction, to architecture rather than sculpture we shall probably do best to assign it.

Defining architecture, then (apart from its utility, which for the present we leave out of consideration), as a *shaping art, of which the function is to express and arouse emotion by combinations of ordered and decorated mass*, we pass from the characteristics of the non-imitative to those of the imitative group of arts, namely sculpture, painting and poetry.

If we keep in mind the source and origin of these arts, we must remember what has already been observed, that they spring by no means from man's love of imitation alone, but from his desire to record and commemorate experience, using the faculty of imitation as his means. Mnemosyne (Memory) was in Greek tradition the mother of the Muses; imitation, in the sense above defined, is but their instrument. Hence we might think "arts of record" a better name for this group than arts of imitation. The answer is—but a large part of pure architecture is also commemorative; from the pyramids and obelisks of Egypt down there are many monuments in which the impulse of men to perpetuate their own or others' memories has worked without any aid of imitation. Hence as the definition of a class of arts contrasted with architecture and music the name "arts of record" would fail; and we have to fall back on the current and established name of the "imitative arts." In considering them we cannot do better than follow that Aristotelian division which describes each art according, first, to the objects which it imitates, and, secondly, to the means it employs.

Taking sculpture first, as imitating a smaller range of objects than the other two, and imitating them more completely: sculpture may have for the objects of its imitation the shapes of whatever things possess length, breadth and magnitude. For its means or instruments it has solid form, which the sculptor either carves out of a hard substance, as in the case of wood and stone, or models in a yielding substance, as in the case of clay and wax, or casts in a dissolved or molten substance, as in the case of plaster and of metal in certain uses, or beats, draws or chases in a malleable and ductile substance, as in the case of metal in other uses, or stamps from dies or moulds, a method sometimes used in all soft or fusible materials. Thus a statue or statuette may either be carved straight out of a block of stone or wood, or first modelled in clay or wax, then moulded in plaster or some equivalent material, and then carved in stone or cast in bronze. A gem is wrought in stone by cutting and grinding. Figures in jeweller's work are wrought by beating and chasing; a medallion by beating and chasing or else by stamping from a die; a coin by stamping from a die; and so forth. The process of modelling (Gr. *πλάττειν*) in a soft substance being regarded as the typical process of the sculptor, the name *plastic art* has been given to his operations in general.

In general terms, the task of sculpture is to imitate solid form with solid form. But sculptured form may be either completely or incompletely solid. Sculpture in completely solid form exactly reproduces, whether on the original or on a different scale, the relations or proportions of the object imitated in the three dimensions of length, breadth and depth or thickness. Sculpture in incompletely solid form reproduces the proportions of the objects with exactness only so far as concerns two of its dimensions, namely, those of length and breadth; while the third dimension, that of depth or thickness, it reproduces in a diminished proportion, leaving it to the eye to infer, from the partial degree of projection given to the work, the full projection of the object imitated. The former, or completely solid kind of sculpture, is called sculpture in the round; its works stand free, and can be walked round and seen from all points. The latter, or incompletely solid kind of sculpture, is called sculpture in relief; its works do not stand free, but are engaged in or attached to a background, and can only be seen from in front. According, in the latter kind of sculpture, to its degree of projection from the background, a work is said to be in high or in low relief. Sculpture in the round and sculpture in relief are alike in this, that the properties of objects which they imitate are their external forms as defined by their outlines—that is, by the boundaries and circumscriptions of their masses—and their light and shade—the lights and shadows, that is, which diversify the curved surfaces of the masses in consequence of their alternations and gradations of projection and recession. But the two kinds of sculpture differ in this. A work

of sculpture in the round imitates the whole of the outlines by which the object imitated is circumscribed in the three dimensions of space, and presents to the eye, as the object itself would do, a new outline succeeding the last every moment as you walk round it. Whereas a work of sculpture in relief imitates only one outline of any object; it takes, so to speak, a section of the object as seen from a particular point, and traces on the background the boundary-line of that particular section; merely suggesting, by modelling the surface within such boundary according to a regular, but a diminished, ratio of projection, the other outlines which the object would present if seen from all sides successively.

As sculpture in the round reproduces the real relations of a solid object in space, it follows that the only kind of object which it can reproduce with pleasurable effect according to the laws of regulated or rhythmical design must be one not too vast or complicated, one that can afford to be detached and isolated from its surroundings, and of which all the parts can easily be perceived and apprehended in their organic relations. Further, it will need to be an object interesting enough to mankind in general to make them take delight in seeing it reproduced with all its parts in complete imitation. And again, it must be such that some considerable part of the interest lies in those particular properties of outline, play of surface, and light and shade which it is the special function of sculpture to reproduce. Thus a sculptured representation in the round, say, of a mountain with cities on it, would hardly be a sculpture at all; it could only be a model, and as a model might have value; but value as a work of fine art it could not have, because the object imitated would lack organic definiteness and completeness; it would lack universality of interest, and of the interest which it did possess, a very inconsiderable part would depend upon its properties of outline, surface, and light and shade. Obviously there is no kind of object in the world that so well unites the required conditions for pleasurable imitation in sculpture as the human body. It is at once the most complete of organisms, and the shape of all others the most subtle as well as the most intelligible in its outlines; the most habitually detached in active or stationary freedom; the most interesting to mankind, because its own; the richest in those particular effects, contours and modulations, contrasts, harmonies and transitions of modelled surface and circumscribing line, which it is the prerogative of sculpture to imitate. Accordingly the object of imitation for this art is pre-eminently the body of man or woman. That it has not been for the sake of representing men and women as such, but for the sake of representing gods in the likeness of men and women, that the human form has been most enthusiastically studied, does not affect this fact in the theory of the art, though it is a consideration of great importance in its history. Besides the human form, sculpture may imitate the forms of those of the lower animals whose physical endowments have something of a kindred perfection, with other natural or artificial objects as may be needed merely by way of accessory or symbol. The body must for the purposes of this art be divested of covering, or covered only with such tissues as reveal, translate or play about without concealing it. Chiefly in lands and ages where climate and social use have given the sculptor the opportunity of studying human forms so draped or undraped has this art attained perfection, and become exemplary and enviable to that of other races.

Relief sculpture is more closely connected with architecture than the other kind, and indeed is commonly used in subordination to it. But if its task is thus somewhat different from that of sculpture in the round, its principal objects of imitation are the same. The human body remains the principal theme of the sculptor in relief; but the nature of his art allows, and sometimes compels, him to include other objects in the range of his imitation. As he has not to represent the real depth or projection of things, but only to suggest them according to a ratio which he may fix himself, so he can introduce into the third or depth dimension, thus arbitrarily reduced, a multitude of objects for which the sculptor in the round, having to observe the real ratio of the three dimensions, has no room. He can place one figure in slightly raised outline emerging from behind the more fully raised outline of another, and by the same system can add to his representation rocks, trees, nay mountains and cities and birds on the wing. But the more he uses this liberty the less will he be truly a sculptor. Solid modelling, and real light and shade, are the special means or instruments of effect which the sculptor alone among imitative artists enjoys. Single outlines and contours, the choice of one particular section and the tracing of its circumscription, are means which the sculptor enjoys in common with the painter or draughtsman. And indeed, when we consider works executed wholly or in part in very low relief, whether Assyrian battle-pieces and hunting-pieces in alabaster or bronze, or the backgrounds carved in bronze, marble or wood by the Italian sculptors who followed the example set by Ghiberti at the Renaissance, we shall see that the principle of such work is not the principle of sculpture at all. Its effect depends little on qualities of surface-light and shadow, and mainly on qualities of contour, as traced by a slight line of shadow on the side away from the light, and a slight line of light on the side next to it. And we may fairly hesitate whether we shall rank the artist who works on this principle, which

Subjects proper for sculpture in the round.

Subjects proper for sculpture in relief.

Sculpture in the round and in relief.

The imitative arts are arts of record using imitation as their means.

Definition of architecture.

is properly a graphic rather than a plastic principle, among sculptors or among draughtsmen. The above are cases in which the relief sculptor exercises his liberty in the introduction of other objects besides human figures into his sculptured compositions. But there is another kind of relief sculpture in which the artist has less choice. That is, the kind in which the sculptor is called in to decorate with carved work parts of an architectural construction which are not adapted for the introduction of figure subjects, or for their introduction only as features in a scheme of ornament that comprises many other elements. To this head belongs most of the carving of capitals, mouldings, friezes (except the friezes of Greek temples), bands, cornices, and, in the Gothic style, of doorway arches, niches, canopies, pinnacles, brackets, spandrels and the thousand members and parts of members which that style so exquisitely adorned with true or conventionalized imitations of natural forms. This is no doubt a subordinate function of the art; and it is impossible, as we have seen already, to find a precise line of demarcation between carving, in this decorative use, which is properly sculpture, and that which belongs properly to architecture.

Leaving such discussions, we may content ourselves with the definition of sculpture as a *shaping art, of which the business is to express and arouse emotion by the imitation of natural objects, and principally the human body, in solid form, reproducing either their true proportions in three dimensions, or their proportions in the two dimensions of length and breadth only, with a diminished proportion in the third dimension of depth or thickness.*

In considering bas-relief as a form of sculpture, we have found ourselves approaching the confines of the second of the shaping imitative arts, the graphic art or art of painting. Painting, as to its means or instruments of imitation, dispenses with the third dimension altogether. It imitates natural objects by representing them as they are represented on the retina of the eye itself, simply as an assemblage of variously shaped and variously shaded patches of colour on a flat surface. Painting does not reproduce the third dimension of reality by any third dimension of its own whatever; but leaves the eye to infer the solidity of objects, their recession and projection, their nearness and remoteness, by the same perspective signs by which it also infers those facts in nature, namely, by the direction of their several boundary lines, the incidence and distribution of their lights and shadows, the strength or faintness of their tones of colour.

Hence this art has an infinitely greater range and freedom than any form of sculpture. Near and far is all the same to it, and whatever comes into the field of vision can come also into the field of a picture; trees as well as persons, and clouds as well as trees, and stars as well as clouds; the remotest mountain snows, as well as the violet of the foreground, and far-off multitudes of people as well as one or two near the eye. Whatever any man has seen, or can imagine himself as seeing, that he can also fix by painting, subject only to one great limitation,—that of the range of brightness which he is able to attain in imitating natural colour illuminated by light. In this particular his art can but correspond according to a greatly diminished ratio with the effects of nature. But excepting this it can do for the eye almost all that nature herself does; or at least all that nature would do if man had only one eye since the three dimensions of space produce upon our binocular machinery of vision a particular stereoscopic effect of which a picture, with its two dimensions only, is incapable. The range of the art being thus almost unbounded, its selections have naturally been dictated by the varying interest felt in this or that subject of representation by the societies among whom the art has at various times been practised. As in sculpture, so in painting, the human form has always held the first place. For the painter, the intervention of costume between man and his environment is not a misfortune in the same degree as it is for the sculptor. For him, clothes of whatever fashion or amplitude have their own charm; they serve to diversify the aspect of the world, and to express the characters and stations, if not the physical frames, of his personages; and he is as happy or happier among the brocades of Venice as among the bare limbs of the Spartan palaestra. Along with man, there come into painting all animals and vegetation, all man's furniture and belongings, his dwelling-places, fields and landscape; and in modern times also landscape and nature for their own sakes, skies, seas, mountains and wildernesses apart from man.

Besides the two questions about any art, what objects does it imitate, and by the use of what means or instruments, Aristotle proposes (in the case of poetry) the further question, which of several possible forms does the imitation in any given case assume? We may transfer very nearly the same inquiry to painting, and may ask, concerning any painter, according to which of three possible systems he works. The three possible systems are (1) that which attends principally to the configuration and relations of natural objects as indicated by the direction of their boundaries, for defining which there is a convention in universal use, the convention, that is, of line; this may be called for short the system of *line*; (2) that which attends chiefly to their configuration and relations as indicated by the incidence and distribution of their lights and shadows—this is the system of *light-and-shade* or

chiaroscuro; and (3) that which attends chiefly, not to their configuration at all, but to the distribution, qualities and relations of local colours upon their surface—this is the system of *colour*. It is not possible for a painter to imitate natural objects to the eye at all without either defining their boundaries by outlines, or suggesting the shape of their masses by juxtapositions of light and dark or of local colours. In the complete art of painting, of course, all three methods are employed at once. But in what is known as outline drawing and outline engraving, one of the three methods only is employed, line; in monochrome pictures, and in shaded drawings and engravings, two only, line with light-and-shade; and in the various shadeless forms of decorative painting and colour-printing, two only, line with colour. Even in the most accomplished examples of the complete art of painting, as was pointed out by Ruskin, we find that there almost always prevails a predilection for some one of these three parts of painting over the other two. Thus among the mature Italians of the Renaissance, Titian is above all things a painter in colour, Michelangelo in line, Leonardo in light-and-shade. Many academic painters in their day tried to combine the three methods in equal balance; to the impetuous spirit of the great Venetian, Tintoretto, it was alone given to make the attempt with a great measure of success. A great part of the effort of modern painting has been to get rid of the linear convention altogether, to banish line and develop the resources of the oil medium in imitating on canvas, more strictly than the early masters attempted, the actual appearance of things on the retina as an assemblage of coloured streaks and patches modified and toned in the play of light-and-shade and atmosphere.

It remains to consider, for the purpose of our classification, what are the technical varieties of the painter's craft. Since we gave the generic name of painting to all imitation of natural objects by the assemblage of lines, colours and lights and darks on a single plane, we must logically include as varieties of painting not only the ordinary crafts of spreading or laying pictures on an opaque surface in fresco, oil, distemper or water-colour, but also the craft of arranging a picture to be seen by the transmission of light through a transparent substance, in glass painting; the craft of fitting together a multitude of solid cubes or cylinders so that their united surface forms a picture to the eye, as in mosaic; the craft of spreading vitreous colours in a state of fusion so that they form a picture when hardened, as in enamel; and even, it would seem, the crafts of weaving, tapestry, and embroidery, since these also yield to the eye a plane surface figured in imitation of nature. As drawing we must also count incised or engraved work of all kinds representing merely the outlines of objects and not their modellings, as for instance the *graffiti* on Greek and Etruscan mirror-backs and dressing-cases; while raised work in low relief, in which outlines are plainly marked and modellings neglected, furnishes, as we have seen, a doubtful class between sculpture and painting. In all figures that are first modelled in the solid and then variously coloured, sculpture and painting bear a common share; and by far the greater part both of ancient and medieval statuary was in fact tinted so as to imitate or at least suggest the colours of life. But as the special characteristic of sculpture, solidity in the third dimension, is in these cases present, it is to that art and not to painting that we shall still ascribe the resulting work.

With these indications we may leave the art of painting defined in general terms as a *shaping or space art, of which the business is to express and arouse emotion by the imitation of all kinds of natural objects, reproducing on a plane surface the relations of their boundary lines, lights and shadows, or colours, or all three of these appearances together.*

The next and last of the imitative arts is the speaking art of poetry. The transition from sculpture and painting to poetry is, from the point of view not of our present but of our first division among the fine arts, abrupt and absolute. It is a transition from space into time, from the sphere of material forms to the sphere of immaterial images. Following Aristotle's method, we may define the objects of poetry's imitation or evocation, as everything of which the idea or image can be called up by words, that is, every force and phenomenon of nature, every operation and result of art, every fact of life and history, or every imagination of such a fact, every thought and feeling of the human spirit, for which mankind in the course of its long evolution has been able to create in speech an explicit and appropriate sign. The means or instruments of poetry's imitation are these verbal signs or words, arranged in lines, strophes or stanzas, so that their sounds have some of the regulated qualities and direct emotional effect of music.

The three chief modes or forms of the imitation may still be defined as they were defined by Aristotle himself. First comes the *epic* or narrative form, in which the poet speaks alternately for himself and his characters, now describing their situations and feelings in his own words, and anon making each of them speak in the first person for himself. Second comes the *lyric* form, in which the poet speaks in his own name exclusively, and gives expression to sentiments which are purely personal. Third comes the *dramatic* form, in which the poet does not speak for himself at all, but only puts into the mouths of each of his personages successively such discourse as he thinks

Definition of sculpture.

Painting as an imitative art.

Range of objects imitable by painting.

The chief forms or modes of painting: line, light-and-shade and colour.

Technical varieties of the painter's craft.

Definition of painting.

Poetry as an imitative art.

The chief forms or modes of poetry.

appropriate to the part. The last of these three forms of poetry, the dramatic, calls, if it is merely read, on the imagination of the reader to fill up those circumstances of situation, action and the rest, which in the first or epic form are supplied by the narrative between the speeches, and for which in the lyric or personal form there is no occasion. To avoid making this call upon the imagination, to bring home its effects with full vividness, dramatic poetry has to call in the aid of several subordinate arts, the shaping or space art of the scene-painter, the mixed time and space arts of the actor and the dancer. Occasionally also, or in the case of opera throughout, dramatic poetry heightens the emotional effect of its words with music. A play or drama is thus, as performed upon the theatre, not a poem merely, but a poem accompanied, interpreted, completed and brought several degrees nearer to reality by a combination of auxiliary effects of the other arts. Besides the narrative, the lyric and dramatic forms of poetry, the *didactic*, that is the teaching or expository form, has usually been recognized as a fourth. Aristotle refused so to recognize it, regarding a didactic poem in the light not so much of a poem as of a useful treatise. But from the *Works and Days* down to the *Loves of the Plants* there has been too much literature produced in this form for us to follow Aristotle here. We shall do better to regard didactic poetry as a variety corresponding, among the speaking arts, to architecture and the other manual arts of which the first purpose is use, but which are capable of accompanying and adorning use by a pleasurable appeal to the emotions.

We shall hardly make our definition of poetry, considered as an imitative art, too extended if we say that it is a *speaking or time art, of which the business is to express and arouse emotion by imitating or evoking all or any of the phenomena of life and nature by means of words arranged with musical regularity.*

Neither the varieties of poetical form, however, nor the modes in which the several forms have been mixed up and interchanged—as such mixture and interchange are implied, for instance, by the very title of a group of Robert Browning's poems, the *Dramatic Lyrics*,—the observation of neither of these things concerns us here so much as the observation of the relations of poetry in general, as an art of representation or imitation, to the other arts of imitation, painting and sculpture. Verbal signs have been invented for innumerable things which cannot be imitated or represented

at all either in solid form or upon a coloured surface. You cannot carve or paint a sigh, or the feeling which finds utterance in a sigh; you can only suggest the idea of the feeling, and that in a somewhat imperfect and uncertain way, by representing the physical aspect of a person in the act of breathing the sigh. Similarly you cannot carve or paint any movement, but only figures or groups in which the movement is represented as arrested in some particular point of time; nor any abstract idea, but only figures or groups in which the abstract idea, as for example release, captivity, mercy, is symbolized in the concrete shape of allegorical or illustrative figures. The whole field of thought, of propositions, arguments, injunctions and exhortations is open to poetry but closed to sculpture and painting. Poetry, by its command over the regions of the understanding, of abstraction, of the movement and succession of things in time, by its power of instantaneously associating one image with another from the remotest regions of the mind, by its names for every shade of feeling and experience, exercises a sovereignty a hundred times more extended than that of either of the two arts of manual imitation. But, on the other hand, words do not as a rule bear any sensible resemblance to the things of which they are the signs. There are few things that words do not stand for or cannot call up; but they stand for things symbolically and at second hand, and call them up only in idea, and not in actual presentment to the senses. In strictness, the business of poetry should not be called imitation at all, but rather evocation. The strength of painting and sculpture lies in this, that though there are countless phenomena which they cannot represent at all, and countless more which they can only represent by symbolism and suggestion more or less ambiguous, yet there are a few which each can represent more fully and directly than poetry can represent any thing at all. These are, for sculpture, the forms or configurations of things, which that art represents directly to the senses both of sight and touch; and for painting the forms and colours of things and their relations to each other in space, air and light, which the art represents to the sense of sight, directly so far as regards surface appearance, and indirectly so far as regards solidity. For many delicate qualities and differences in these visible relations of things there are no words at all—the vocabulary of colours, for instance, is in all languages surprisingly scanty and primitive. And those visible qualities for which words exist, the words still call up indistinctly and at second hand. Poetry is almost as powerless to bring before the mind's eye with precision a particular shade of red or blue, a particular linear arrangement or harmony of colour-tones, as sculpture is to relate a continuous experience, or painting to enforce an exhortation or embellish an abstract proposition. The wise poet, as has been justly remarked, when he wants to produce a vivid impression of a visible thing, does not attempt to catalogue or describe its stationary beauties. Shakespeare, when he wants to make us realize the perfections of Perdita, puts into the mouth of Florizel, not, as a bad poet would have done, a description of her

lilies and carnations, and the other charms which a painter could make us realize better, but the praises of her ways and movements; and with the final touch,

"When you do dance, I wish you
A wave o' the sea, that you might ever do
Nothing but that,"

he evokes a twofold image of beauty in motion, of which one half might be the despair of those painters who designed the dancing maidens of the walls of Herculaneum, and the other half the despair of all artists who in modern times have tried to fix upon their canvas the buoyancy and grace of dancing waves. In representing the perfections of form in a bride's slender foot, the speaking art, poetry, would find itself distanced by either of the shaping arts, painting or sculpture. Suckling calls up the charm of such a foot by describing it not at rest but in motion, and in the feet which

"Beneath the petticoat,
Like little mice, went in and out,"

leaves us an image which baffles the power of the other arts. Keats, when he tells of Madeline unclasping her jewels on St Agnes's Eve, does not attempt to conjure up their lustre to the eye, as a painter would have done, and a less poetical poet might have tried to do, but in the words "her warmed jewels" evoked instead a quality, breathing of the very life of the wearer, which painting could not even have remotely suggested.

The differences between the means and capacities of representation proper to the shaping arts of sculpture and painting and those proper to the speaking art of poetry were for a long while overlooked or misunderstood. The maxim of Simonides, that poetry is a kind of articulate painting, and painting a kind of mute poetry, was vaguely accepted until the days of Lessing, and first overthrown by the famous treatise of that writer on the Laocöon. Following in the main the lines laid down by Lessing, other writers have worked out the conditions of representation or imitation proper not only to sculpture and painting as distinguished from poetry, but to sculpture as distinguished from painting. The chief points established may really all be condensed under one simple law, *that the more direct and complete the imitation effected by any art, the less is the range and number of phenomena which that art can imitate.*

General law of the relative means and capacities of the several imitative arts: sculpture.

Thus sculpture in the round imitates its objects much more completely and directly than any other single art, reproducing one whole set of their relations which no other art attempts to reproduce at all, namely, their solid relations in space. Precisely for this reason, such sculpture is limited to a narrow class of objects. As we have seen, it must represent human or animal figures; nothing else has enough either of universal interest or of organic beauty and perfection. Sculpture in the round must represent such figures standing free in full clearness and detachment, in combinations and with accessories comparatively simple, on pain of teasing the eye with a complexity and entanglement of masses and lights and shadows; and in attitudes comparatively quiet, on pain of violating, or appearing to violate, the conditions of mechanical stability. Being a stationary or space-art, it can only represent a single action, which it fixes and perpetuates for ever; and it must therefore choose for that action one as significant and full of interest as is consistent with due observation of the above laws of simplicity and stability. Such actions, and the facial expressions accompanying them, should not be those of sharp crisis or transition, because sudden movement or flitting expression, thus arrested and perpetuated in full and solid imitation by bronze or marble, would be displeasing and not pleasing to the spectator. They must be actions and expressions in some degree settled, collected and capable of continuance, and in their collectedness must at the same time suggest to the spectator as much as possible of the circumstances which have led up to them and those which will next ensue. These conditions evidently bring within a very narrow range the phenomena with which this art can deal, and explain why, as a matter of fact, the greater number of statues represent simply a single figure in repose, with the addition of one or two symbolic or customary attributes. Paint a statue (as the greater part both of Greek and Gothic statuary was in fact painted), and you bring it to a still further point of imitative completeness to the eye; but you do not thereby lighten the restrictions laid upon the art by its material, so long as it undertakes to reproduce in full the third or solid dimension of bodies. You only begin to lighten its restrictions when you begin to relieve it of that duty. We have traced how sculpture in relief, which is satisfied with only a partial reproduction of the third dimension, is free to introduce a larger range of objects, bringing forward secondary figures and accessories, indicating distant planes, indulging even in considerable violence and complexity of motion, since limbs attached to a background do not alarm the spectator by any idea of danger of fragility. But sculpture in the round has not this licence. It is true that the art has at various periods made efforts to escape from its natural limitations. Several of the later schools of antiquity, especially that of Pergamus in the 3rd and 2nd centuries B.C., strove hard both for violence of expression and complexity of design, not only in relief-sculptures, like the great altar-friezes now at Berlin, but in detached groups, such as (*pace* Lessing) the Laocöon itself. Many modern *virtuosi* of sculpture since Bernini have misspent their

skill in trying to fix in marble both the restlessness of momentary actions and the finisness of fluttering tissues. In latter days Auguste Rodin, an innovating master with a real genius for his art, has attacked many problems of complicated grouping, more or less in the nature of the Greek *symplegmata*, but keeps these interlocked or contorted actions circumscribed within strict limiting lines, so that they do not by jutting or straggling suggest a kind of acrobatic challenge to the laws of gravity. The same artist and others inspired by him have further sought to emancipate sculpture from the necessity of rendering form in clear and complete definition, and to enrich it with a new power of mysterious suggestion, by leaving his figures wrought in part to the highest finish and vitality of surface, while other parts (according to a precedent set in some unfinished works of Michelangelo) remain scarcely emergent from the rough-hewn or unhewn block. But it may be doubted whether such experiments and expedients can permanently do much to enlarge the scope of the art.

Next we arrive at painting, in which the third dimension is dismissed altogether, and nothing is actually reproduced, in full or partially, except the effect made by the appearance of natural objects upon the retina of the eye. The consequence is that this art can range over distance and multitude, can represent complicated relations between its various figures and groups of figures, extensive backgrounds, and all those infinite subtleties of appearance in natural things which depend upon local colours and their modification in the play of light and shade and enveloping atmosphere. These last phenomena of natural things are in our experience subject to change in a sense in which the substantial or solid properties of things are not so subject. Colours, shadows and atmospheric effects are naturally associated with ideas of transition, mystery and evanescence. Hence painting is able to extend its range to another kind of facts over which sculpture has no power. It can suggest and perpetuate in its imitation, without breach of its true laws, many classes of facts which are themselves fugitive and transitory, as a smile, the glance of an eye, a gesture of horror or of passion, the waving of hair in the wind, the rush of horses, the strife of mobs, the whole drama of the clouds, the toss and gathering of ocean waves, even the flashing of lightning across the sky. Still, any long or continuous series of changes, actions or movements is quite beyond the means of this art to represent. Painting remains, in spite of its comparative width of range, tied down to the inevitable conditions of a space-art: that is to say, it has to delight the mind by a harmonious variety in its effects, but by a variety apprehended not through various points of time successively, but from various points in space at the same moment. The old convention which allowed painters to indicate sequence in time by means of distribution in space, dispersing the successive episodes of a story about the different parts of a single picture, has been abandoned since the early Renaissance; and Wordsworth sums up our modern view of the matter when he says that it is the business of painting

"to give

To one blest moment snatched from fleeting time
The appropriate calm of blest eternity."

Lastly, a really unfettered range is only attained by the art which does not give a full and complete reproduction of any natural fact at all, but evokes or brings natural facts before the mind merely by the images which words convey. The whole world of movement, of continuity, of cause and effect, of the successions, alternations and interaction of events, characters and passions of everything that takes time to happen and time to declare, is open to poetry as it is open to no other art. As an imitative or, more properly speaking, an evocative art, then, poetry is subject to no limitations except those which spring from the poverty of human language, and from the fact that its means of imitation are indirect. Poetry's account of the visible properties of things is from these causes much less full, accurate and efficient than the reproduction or delineation of the same properties by sculpture and painting. And this is the sum of the conditions concerning the respective functions of the three arts of imitation which had been overlooked, in theory at least, until the time of Lessing.

To the above law, in the form in which we have expressed it, it may perhaps be objected that the acted drama is at once the most full and complete reproduction of nature which we owe to the fine arts, and that at the same time the number of facts over which its imitation ranges is the greatest. The answer is that our law applies to the several arts only in that which we may call their pure or unmixed state. Dramatic poetry is in that state only when it is read or spoken like any other kind of verse. When it is witnessed on the stage, it is in a mixed or impure state; the art of the actor has been called in to give actual reproduction to the gestures and utterances of the personages, that of the costumier to their appearances and attire, that of the stage-decorator to their furniture and surroundings, that of the scene-painter to imitate to the eye the dwelling-places and landscapes among which they move; and only by the combination of all these subordinate arts does the drama gain its character of imitative completeness or reality.

Means and capacities of painting.

The acted drama no real exception to the general law.

Throughout the above account of the imitative and non-imitative groups of fine arts, we have so far followed Aristotle as to allow the name of imitation to all recognizable representation or evocation of realities,—using the word "realities" in no metaphysical sense, but to signify the myriad phenomena of life and experience, whether as they actually and literally exist to-day, or as they may have existed in the past, or may be conceived to exist in some other world not too unlike our own for us to conceive and realize in thought. When we find among the ruins of a Greek temple the statue of a beautiful young man at rest, or above the altar of a Christian church the painting of one transfixed with arrows, we know that the statue is intended to bring to our minds no mortal youth, but the god Hermes or Apollo, the transfixed victim no simple captive, but Sebastian the holy saint. At the same time we none the less know that the figures in either case have been studied by the artist from living models before his eyes. In like manner, in all the representations alike of sculpture, painting and poetry the things and persons represented may bear symbolic meanings and imaginary names and characters; they may be set in a land of dreams, and grouped in relations and circumstances upon which the sun of this world never shone; in point of fact, through many ages of history they have been chiefly used to embody human ideas of supernatural powers; but it is from real things and persons that their lineaments and characters have been taken in the first instance, in order to be attributed by the imagination to another and more exalted order of existences.

The law which we have last laid down is a law defining the relations of sculpture, painting and poetry, considered simply as arts having their foundations at any rate in reality, and drawing from the imitation of reality their indispensable elements and materials. It is a law defining the range and character of those elements or materials in nature which each art is best fitted, by its special means and resources, to imitate. But we must remember that, even in this fundamental part of its operations, none of these arts proceeds by imitation or evocation pure and simple. None of them contents itself with seeking to represent realities, however literally taken, exactly as those realities are. A portrait in sculpture or painting, a landscape in painting, a passage of local description in poetry, may be representations of known things taken literally or for their own sakes, and not for the sake of carrying out thoughts to the unknown; but none of them ought to be, or indeed can possibly be, a representation of all the observed parts and details of such a reality on equal terms and without omissions. Such a representation, were it possible, would be a mechanical inventory and not a work of fine art.

Hence the value of a pictorial imitation is by no means necessarily in proportion to the number of facts which it records. Many accomplished pictures, in which all the resources of line, colour and light-and-shade have been used to the utmost of the artist's power for the imitation of all that he could see in nature, are dead and worthless in comparison with a few faintly touched outlines or lightly laid shadows or tints of another artist who could see nature more vitally and better. Unless the painter knows how to choose and combine the elements of his finished work so that it shall contain in every part suggestions and delights over and above the mere imitation, it will fall short, in that which is the essential charm of fine art, not only of any scrap of a great master's handiwork, such as an outline sketch of a child by Raphael or a colour sketch of a boat or a mackerel by Turner, but even of any scrap of the merest journeyman's handiwork produced by an artistic race, such as the first Japanese drawing in which a water-flag and kingfisher, or a spray of peach or almond blossom across the sky, is dashed in with a mere hint of colour, but a hint that tells a whole tale to the imagination. That only, we know, is fine art which affords keen and permanent delight to contemplation. Such delight the artist can never communicate by the display of a callous and pedantic impartiality in presence of the facts of life and nature. His representation of realities will only strike or impress others in so far as it concentrates their attention on things by which he has been struck and impressed himself. To arouse emotion, he must have felt emotion; and emotion is impossible without partiality. The artist is one who instinctively tends to modify and work upon every reality before him in conformity with some poignant and sensitive principle of preference or selection in his mind. He instinctively adds something to nature in one direction and takes away something in another, overlooking this kind of fact and insisting on that, suppressing many particulars which he holds irrelevant in order to insist on and bring into prominence others by which he is attracted and arrested.

The instinct by which an artist thus prefers, selects and brings into light one order of facts or aspects in the thing before him rather than the rest, is part of what is called the *idealizing* or *ideal* faculty. Interminable discussion has been spent on the questions,—What is the ideal, and how do we idealize? The answer has been given in one form by those thinkers (e.g. Vischer and Lotze) who have pointed out that the process of aesthetic idealization carried on by the artist is only the

Things unknown shadowed forth by imitation of things known.

Imitation by art necessarily an idealized imitation.

Completeness not the test of value in a pictorial imitation.

Nature of the idealizing process.

higher development of a process carried on in an elementary fashion by all men, from the very nature of their constitution. The physical organs of sense themselves do not retain or put on record all the impressions made upon them. When the nerves of the eye receive a multitude of different stimulations at once from different points in space, the sense of eyesight, instead of being aware of all these stimulations singly, only abstracts and retains a total impression of them together. In like manner we are not made aware by the sense of hearing of all the several waves of sound that strike in a momentary succession upon the nerves of the ear; that sense only abstracts and retains a total impression from the combined effect of a number of such waves. And the office which each sense thus performs singly for its own impressions, the mind performs in a higher degree for the impressions of all the senses equally, and for all the other parts of our experience. We are always dismissing or neglecting a great part of our impressions, and abstracting and combining among those which we retain. The ordinary human consciousness works like an artist up to this point; and when we speak of the ordinary or inartistic man as being impartial in the retention or registry of his daily impressions, we mean, of course, in the retention or registry of his impressions as already thus far abstracted and assorted in consciousness. The artistic man, whose impressions affect him much more strongly, has the faculty of carrying much farther these same processes of abstraction, combination and selection among his impressions.

The possession of this faculty is the artist's most essential gift. To attempt to carry farther the psychological analysis of the gift is outside our present object; but it is worth while to consider somewhat closely its modes of practical operation. One mode is this: the artist grows up with certain innate or acquired predilections which become a part of his constitution whether he will or no,—predilections, say, if he is a dramatic poet, for certain types of plot, character and situation; if he is a sculptor, for certain proportions and a certain habitual carriage and disposition of the limbs; if he is a figure painter, for certain schemes of composition and moulds of figure and airs and expressions of countenance; if a landscape painter, for a certain class of local character, sentiment and pictorial effect in natural scenery. To such predilections he cannot choose but make his representations of reality in large measure conform. This is one part of the transmuting process which the data of life and experience have to undergo at the hands of artists, and may be called the subjective or purely personal mode of idealization. But there is another part of that work which springs from an impulse in the artistic constitution not less imperious than the last named, and in a certain sense contrary to it. As an imitator or evoker of the facts of life and nature, the artist must recognize and accept the character of those facts with which he has in any given case to deal. All facts cannot be of the cast he prefers, and in so far as he undertakes to deal with those of an opposite cast he must submit to them; he must study them as they actually are, must apprehend, enforce and bring into prominence their own dominant tendencies. If he cannot find in them what is most pleasing to himself, he will still be led by the abstracting and discriminating powers of his observation to discern what is most expressive and significant in them, he will emphasize and put on record this, idealizing the facts before him not in his direction but in their own. This is the second or objective half of the artist's task of idealization. It is this half upon which Taine dwelt almost exclusively, and on the whole with a just insight into the principles of the operation, in his well-known treatise *On the Ideal in Art*. Both these modes of idealization are legitimate; that which springs from inborn and overmastering personal preference in the artist for particular aspects of life and nature, and that which springs from his insight into the dominant and significant character of the phenomena actually before him, and his desire to emphasize and disengage them. But there is a third mode of idealizing which is less vital and genuine than either of these, and therefore less legitimate, though unfortunately far more common. This mode consists in making things conform to a borrowed and conventional standard of beauty and taste, which corresponds neither to any strong inward predilection of the artist nor to any vital characteristic in the objects of his representation. Since the rediscovery of Greek and Roman sculpture in the Renaissance, a great part of the efforts of artists have been spent in falsifying their natural instincts and misrepresenting the facts of nature in pursuit of a conventional ideal of abstract and generalized beauty framed on a false conception and a shallow knowledge of the antique. School after school from the 16th century downwards has been confirmed in this practice by academic criticism and theory, with resulting insipidities and insincerities of performance which have commonly been acclaimed in their day, but from which later generations have sooner or later turned away with a wholesome reaction of distaste.

The two genuine modes of idealization, the subjective and the objective, are not always easy to be reconciled. The greatest artist is no doubt he who can combine the strongest personal instincts of preference with the keenest power of observing characteristics as they are, yet in fact we find few in whom both these elements of the ideal faculty have been equally developed. To take an example among Florentine painters, Sandro Botticelli is usually thought of as one who could never escape from the dictation of his own personal

ideals, in obedience to which he is supposed to have invested all the creations of his art with nearly the same conformation of brows, lips, cheeks and chin, nearly the same looks of wistful yearning and dejection. There is some truth in this impression, though it is largely based on the works not of the master himself, but of pupils who exaggerated his mannerisms. Leonardo da Vinci was strong in both directions; haunted in much of his work by a particular human ideal of intellectual sweetness and alluring mystery, he has yet left us a vast number of exercises which show him as an indefatigable student of objective characteristics and psychological expressions of an order the most opposed to this. And in this case again followers have over-emphasized the master's predilections, Luini, Sodoma and the rest borrowing and repeating the mysterious smile of Leonardo till it becomes in their work an affectation cloying however lovely. Among latter-day painters, Burne-Jones will occur to every reader as the type of an artist always haunted and dominated by ideals of an intensely personal cast partly engendered in his imagination by sympathy with the early Florentines. If we seek for examples of the opposite principle, of that idealism which idealizes above all things objectively, and seeks to disengage the very inmost and individual characters of the thing or person before it, we think naturally of certain great masters of the northern schools, as Dürer, Holbein and Rembrandt. Dürer's endeavour to express such characters by the most searching intensity of linear definition was, however, hampered and conditioned by his inherited national and Gothic predilection for the strained in gesture and the knotted and the gnarled in structure, against which his deliberate scholarly ambition to establish a canon of ideal proportion contended for the most part in vain. And Rembrandt's profound spiritual insight into human character and personality did not prevent him from plunging his subjects, ever deeper and deeper as his life advanced, into a mysterious shadow-world of his own imagination, where all local colours were broken up and crumbled, and where amid the struggle of gloom and gleam he could make his intensely individualized men and women breathe more livingly than in plain human daylight.

It is by the second mode of operation chiefly, that is by imaginatively discerning, disengaging and forcing into prominence their inherent significance, that the idealizing faculty brings into the sphere of fine art deformities and degeneracies to which the name beautiful or sublime can by no stretch of usage be applied. Hence arise creations like the *Stryge* of Notre-Dame and a thousand other grotesques of Gothic architectural carving. Hence, although on a lower plane and interpreted with a less transmuting intensity of insight and emphasis, the snarling or jovial grossness of the peasants of Adrian Brauwer and the best of his Dutch compeers. Hence Shakespeare's Caliban and figures like those of Quilp and Quasimodo in the romances of Dickens and Hugo; hence the cynic grimmess of Goya's Caprices and the profound and bitter impressiveness of Daumier's caricatures of Parisian bourgeois life; or again, in an angrier and more insulting and therefore less understanding temper, the brutal energy of the political drawings of Gilray.

Sculpture, painting and poetry, then, are among the greater fine arts those which express and arouse emotion by imitating or evoking real and known things, either for their own sakes literally, or for the sake of shadowing forth things not known but imagined. In either case they represent their originals, not indiscriminately as they are, but sifted, simplified, enforced and enhanced to our apprehensions partly by the artist's power of making things conform to his own instincts and preferences, partly by his other power of interpreting and emphasizing the significant characters of the facts before him. Any imitation that does not do one or other or both of these things in full measure fails in the quality of emotional expression and emotional appeal, and in so failing falls short, taken merely as imitation, of the standard of fine art.

But we must remember that idealized imitation, as such, is not the whole task of these arts nor their only means of appeal. There is another part of their task, logically though not practically independent of the relations borne by their imitations to the original phenomena of nature, and dependent on the appeal made through the eye and ear to our primal organic sensibilities by the properties of rhythm, pattern and regulated design in the arrangement of sounds, lines, masses, colours and light-and-shade. That appeal we noted as lying at the root of the art impulse in its most elementary stage. In its most developed stage every fine art is bound still to play upon the same sensibilities. In a work of sculpture the contours and interchanges of light and shadow are bound to be such as would please the eye, whether the statue or relief represented the figure of anything real in the world or not. The flow and balance of line, and the distribution of colours and light-and-shade, in a picture are bound to be such as would make an agreeable pattern although they bore no resemblance to natural fact (as, indeed, many subordinate applications of this art, in decorative painting and geometrical and other ornaments, do, we know, give pleasure though they represent nothing). The

Examples of the two modes and of their reconciliation.

Caricature and the grotesque as modes of the ideal.

Unidealized imitation not fine art.

The appeal of the imitative arts depends partly on non-imitative elements.

sound of a line or verse in poetry is bound to be such as would thrill the physical ear in hearing, or the mental ear in reading, with a delightful excitement even though the meaning went for nothing. If the imitative arts are to touch and elevate the emotions, if they are to afford permanent delight of the due pitch and volume, it is not a more essential law that their imitation, merely as such, should be of the order which we have defined as ideal, than that they should at the same time exhibit these independent effects which they share with the non-imitative group.

So far we have assumed, without asserting, the necessity that the artist in whatever kind should possess a power of execution, or technique as it is called in modern phrase, adequate to the task of embodying and giving shape to his ideals. In thought it is possible to separate the conception of a work of art from its execution; in practice it is not possible, and half the errors in criticism and speculation about the fine arts spring from failing to realize that an artistic conception can only be brought home to us through and by its appropriate embodiment. Whatever the artist's cast of imagination or degree of sensibility may be in presence of the materials of life, it is essential that he should be able to express himself appropriately in the material of his particular art. To quote the writer (R. A. M. Stevenson) who has enforced this point most

clearly and vividly, perhaps with some pardonable measure of over-statement: "It is a sensitiveness to the special qualities of some visible or audible medium of art which distinguishes the species artist from the genus man." And again: "There are as many separate faculties of imagination as there are separate mediums in which to conceive an image—clay, words, paint, notes of music." . . . "Technique differs as the material of each art differs—differs as marble, pigments, musical notes and words differ." The artist who does not enjoy and has not with delighted labour mastered the effects of his own chosen medium will never be a master; the hearer, reader or spectator who cannot appreciate the qualities of skill, vitality and charm in the handling of the given material, or who fails to feel their absence when they are lacking, or who looks in one material primarily for the qualities appropriate to another, will never make a critic. The technique of the space-arts differs radically from that of the time-arts. So again do those of the imitative and the non-imitative arts differ among themselves. The non-imitative arts of music and architecture are in a certain degree alike in this, that the artist is in neither case his own executant (this at least is true of music so far as concerns its modern concerted and orchestral developments); the musical composer and the architect each imagines and composes a design in the medium of his own art which it is left for others to carry out under his direction. The technique in each case consists not in mastery of an instrument (though the musical composer may be, and often is, a master of some one of the instruments whose effects he in his mind's ear co-ordinates and combines); it lies in the power of knowing and conjuring up all the emotional resources and effects of the various materials at his command, and of conceiving and designing to their last detail vast and ordered structures, to be raised by subordinate executants from those materials, which shall adequately express his temperament and embody his ideals.

In the imitative arts, on the other hand, the sculptor, unless he is a fraud, must be wholly his own executant in the original task of modelling his design in the soft material of clay or wax, though he must accept the aid of assistants whether in the casting of his work in bronze or in first roughing it out from the block in marble. Too many sculptors have been inclined further to trust to trained mechanical help in finishing their work with the chisel; with the result that the surface loses the touch which is the expression of personal temperament and personal feeling for the relations of his material to nature. The artist in love with the vital qualities of form, or those of his own handiwork in expressing such qualities in modelling-clay, will never stop until he learns how to translate them for himself in marble. Proceeding to that imitative art which leaves out the third dimension of nature, and by so doing enormously increases the range of objects and effects which come within its power—proceeding to the art of painting, the painter is in theory exclusively his own executant, and in practice mainly so, though in certain schools and periods the great artists have been accustomed to surround themselves with pupils to whom they have imparted their methods and who have helped them in the subordinate and preparatory parts of their work. But the painter fit to teach and lead can by no means escape the necessity of being himself a master of his material, and his handling of it must needs bear the immediate impress of his temperament. His emotional preferences among the visible facts of nature, his feeling for the relative importance and charm of line, colour, light and shade, used whether for the interpretation and heightening of natural fact or for producing a pattern in itself harmonious and suggestive to the eye, his sense of the special modes of handling most effective for communicating the impression he desires, all these together inevitably appear in, and constitute, his style and technique. If he is careless or inexpert or conventional, or cold or without delight, in technique, though he may be animated by the noblest purposes

and the loftiest ideas, he is a failure as a painter. At certain periods in the history of painting, as in the 13th and 14th centuries in Italy, the technique seems indeed to modern eyes wholly immature; but that was because there were many aspects of visible things which the art had not yet attempted or desired to portray, not because it did not put forth with delight its best traditional or newly acquired skill in portraying the special aspects with which it had so far attempted to grapple. At certain other periods, as in the later 16th and 17th centuries in the same country, the elements of inherited technical facility and academic pride of skill outweigh the sincerity and freshness of interest taken in the aspects of things to be portrayed, and the true balance is lost. At other times, as in much of the work of the 19th century, especially in England, painters have been diverted from their true task, and lost hold of intelligent and living technique altogether, in trying to please a public blind to the special qualities of their art, and prone to seek in it the effects, frivolous or serious, which are appropriate not to paint and canvas but to literature.

Lastly, the poet and literary artist must obviously be the exclusive master of his own technique. No one can help him: all depends on the keenness of his double sensibility to the thrill of life and to that of words, and to his power of maintaining a just balance between the two. If he is truly and organically sensitive to words alone, and has learnt life only through their medium and not through the energies of his own imagination, nor through personal sensibility to the impact of things and thoughts and passions and experience, then his work may be a miracle of accomplished verbal music, and may entrance the ear for the moment, but will never live to illuminate and sustain and console. If, on the other hand, he has imagination and sensibility in full measure, and lacks the inborn love of and gift for words and their magic, he will be but a dumb or stammering poet all his days. There is no better witness on this point than Wordsworth. His own prolonged lapses from verbal felicity, and continual habit of solemn meditation on themes not always inspiring, might make us hesitate to choose him as an example of that particular love and gift. But Wordsworth could never have risen to his best and greatest self had he not truly possessed the sensibilities which he attributes to himself in the Prelude:

*Technique
in poetry:
the magic
of words.*

"Twice five years

Or less I might have seen, when first my mind
With conscious pleasure opened to the charm
Of words in tuneful order, found them sweet
For their own sakes, a passion, and a power;
And phrases pleased me chosen for delight,
For pomp, or love."

And again, expressing better than any one else the relation which words in true poetry hold to things, he writes:

"Visionary power

Attends the motions of the viewless winds,
Embodied in the mystery of words;
There darkness makes abode, and all the host
Of shadowy things work endless changes,—there,
As in a mansion like their proper home,
Even forms and substances are circumfused
By that transparent veil with light divine,
And, through the turnings intricate of verse,
Present themselves as objects recognized,
In flashes, and with glory not their own."

3. *The Serviceable and the Non-Serviceable Arts.*—It has been established from the outset that, though the essential distinction of fine art as such is to minister not to material necessity or practical use, but to delight, yet there are some among the arts of men which do both these things at once and are arts of direct use and of beauty or emotional appeal together. Under this classification a survey of the field of art at different periods of history would yield different results. In ruder times, we have seen, the utilitarian aim was still the predominant aim of art, and most of what we now call fine arts served in the beginning to fulfil the practical needs of individual and social life; and this not only among primitive or savage races. In ancient Egypt and Assyria the primary purpose of the relief-sculptures on palace and temple walls was the practical one of historical record and commemoration. Even as late as the middle ages and early Renaissance the primary business of the painter was to give instruction to the unlearned in Bible history and in the lives of the saints, and to rouse him to moods of religious and ethical exaltation. The pleasures of fine art proper among the manual-imitative group—the pleasures, namely, of producing and contemplating certain arrangements rather than others of design, proportion, pattern, colour and light and shade, and of putting forth and appreciating certain qualities of skill, truth and significance in idealized imitation,—these were, historically speaking, by-products that arose gradually in the course of practice and development. As time went on, the conscious aim of ministering to such pleasures displaced and threw into the background the utilitarian ends for which the arts had originally been practised, and the pleasures became ends in themselves.

*Third
classification:
the
serviceable
and the
non-
serviceable
arts.*

But even in advanced societies the double qualities of use and

beauty still remain inseparable, among the five greater arts, in architecture. We build in the first instance for the sake of necessary shelter and accommodation, or for the commemoration, propitiation or worship of spiritual powers on whom we believe our welfare to depend. By and by we find out that the aspect of our constructions is pleasurable or the reverse. Architecture is the art of building at once as we need and as we like, and a practical treatise on architecture must treat the beauty and the utility of buildings as bound up together. But for our present purpose it has been proper to take into account one half

of the vocation of architecture, the half by which it impresses, gives delight and belongs to that which is the subject of our study, to fine art; and to neglect the other half of its vocation, by which it belongs to what is not the subject of our study, to useful or mechanical art. It is plain, however, that the presence or absence of this foreign element, the element of practical utility, constitutes a fair ground for a new and separate classification of the fine arts. If we took the five greater arts as they exist in modern times by themselves, architecture would on this ground stand alone in one division, as the directly useful or serviceable fine art; with sculpture, painting, music and poetry together in the other division, as fine arts unassociated with such use or service. Not that the divisions would, even thus, be quite sharply and absolutely separated. Didactic poetry, we have already acknowledged, is a branch of the poetic art which aims at practice and utility. Again, the hortatory and patriotic kinds of lyric poetry, from the strains of Tyrtæus to those of Arndt or Rouget de Lisle or Wordsworth's sonnets written in war-time, may fairly be said to belong to a phase of fine art which aims directly at one of the highest utilities, the stimulation of patriotic feeling and self-devotion. So may the strains of music which accompany such poetry. The same practical character, as stimulating and attuning the mind to definite ends and actions, might indeed have been claimed for the greater part of the whole art of music as that art was practised in antiquity, when each of several prescribed and highly elaborated moods, or modes, of melody was supposed to have a known effect upon the courage and moral temper of the hearer. Compare Milton, when he tells of the Dorian mood of flutes and soft recorders which assuaged the sufferings and renewed the courage of Satan and his legions as they marched through hell. In modern music, of which the elements, much more complex in themselves than those of ancient music, have the effect of stirring our fibres to moods of rapturous contemplation rather than of action, military strains in march time are in truth the only purely instrumental variety of the art which may still be said to retain this character.

To reinforce, however, the serviceable or useful division of fine arts in our present classification, it is not among the greater arts that we must look. We must look among the lesser or auxiliary arts of the manual or shaping group. The weaver, the joiner, the potter, the smith, the goldsmith, the glass-maker, these and a hundred artificers who produce wares primarily for use, produce them in a form or with embellishments that have the secondary virtue of giving pleasure both to the producer and the user. Much ingenuity has been spent to little purpose in attempting to group and classify these lesser shaping arts under one or other of the greater shaping arts, according to the nature of the means employed in each. Thus the potter's art has been classed under sculpture, because he moulds in solid form the shapes of his cups, plates and ewers; the art of the joiner under that of the architect, because his tables, seats and cupboards are fitted and framed together, like the houses they furnish, out of solid materials previously prepared and cut; and the weaver and embroiderer, from the point of view of the effects produced by their art, among painters. But the truth is, that each one of these auxiliary handicrafts has its own materials and technical procedure, which cannot, without forcing and confusion, be described by the name proper to the materials and technical procedure of any of the greater arts. The only satisfactory classification of these handicrafts is that now before us, according to which we think of them all together in the same group with architecture, not because any one or more of them may be technically allied to that art, but because, like it, they all yield products capable of being practically useful and beautiful at the same time. Architecture is the art which fits and frames together, of stone, brick, mortar, timber or iron, the abiding and assembling places of man, all his houses, palaces, temples, monuments, museums, workshops, roofed places of meeting and exchange, theatres for spectacle, fortresses of defence, bridges, aqueducts, and ships for seafaring. The wise architect having fashioned any one of these great constructions at once for service and beauty in the highest degree, the lesser or auxiliary manual arts (commonly called "industrial" or "applied" arts) come in to fill, furnish and adorn it with things of service and beauty in a lower degree, each according to its own technical laws and capabilities; some, like pottery, delighting the user at once by beauty of form, delicacy of substance, and pleasantness of imitative or non-imitative ornament; some, like embroidery, by richness of tissue, and by the same twofold pleasantness of ornament; some, like goldsmith's work, by exquisiteness of fancy and workmanship proportionate to the exquisiteness of the

material. To this vast group of workmen, whose work is at the same time useful and fine in its degree, the ancient Greek gave the place which is most just and convenient for thought, when he classed them all together under the name of τέκτονες, or artificers, and called the builder by the name of ἀρχιτέκτων, arch-artificer or artificer-in-chief. Modern usage has adopted the phrase "arts and crafts" as a convenient general name for their pursuits.

III. *Of the History of the Fine Arts.*

Students of human culture have concentrated a great deal of attentive thought upon the history of fine art, and have put forth various comprehensive generalizations intended at once to sum up and to account for the phases and vicissitudes of that history. The most famous formulæ are those of Hegel, who regarded particular arts as being characteristic of and appropriate to particular forms of civilization and particular ages of history. For him, architecture was the symbolic art appropriate to ages of obscure and struggling ideas, and characteristic of the Egyptian and the Asiatic races of old and of the medieval age in Europe. Sculpture was the classical art appropriate to ages of lucid and self-possessed ideas, and characteristic of the Greek and Roman period. Painting, music and poetry were the romantic arts, appropriate to the ages of complicated and overmastering ideas, and characteristic of modern humanity in general. In the working out of these generalizations Hegel brought together a mass of judicious and striking observations; and that they contain on the whole a preponderance of truth may be admitted. It has been objected against them, from the philosophical point of view, that they too much mix up the definition of what the several arts theoretically are with considerations of what in various historical circumstances they have practically been. From the historical point of view there can be taken what seems a more valid objection, that these formulæ of Hegel tend too much to fix the attention of the student upon the one dominant art chosen as characteristic of any period, and to give him false ideas of the proportions and relations of the several arts at the same period—of the proportions and relations which poetry, say, really bore to sculpture among the Greeks and Romans, or sculpture to architecture among the Christian nations of the middle age. The truth is, that the historic survey gained over any field of human activity from the height of generalizations so vast in scope as these are must needs, in the complexity of earthly affairs, be a survey too distant to give much guidance until its omissions are filled up by a great deal of nearer study; and such nearer study is apt to compel the student in the long run to qualify the theories with which he has started until they are in danger of disappearing altogether.

Another systematic exponent of the universe, whose system is very different from that of Hegel, Herbert Spencer, brought the doctrine of evolution to bear, not without interesting results, upon the history of the fine arts and their development. Herbert Spencer set forth how the manual group of fine arts, architecture, sculpture and painting, were in their first rudiments bound up together, and how each of them in the course of history has liberated itself from the rest by a gradual process of separation. These arts did not at first exist in the distinct and developed forms in which we have above described them. There were no statues in the round, and no painted panels or canvases hung upon the wall. Only the rudiments of sculpture and painting existed, and that only as ornaments applied to architecture, in the shape of tiers of tinted reliefs, representing in a kind of picture-writing the exploits of kings upon the walls of their temple-palaces. Gradually sculpture took greater salience and roundness, and tended to disengage itself from the wall, while painting found out how to represent solidity by means of its own, and dispensed with the raised surface upon which it was first applied. But the old mixture and union of the three arts, with an undeveloped art of painting and an undeveloped art of sculpture still engaged in or applied to the works of architecture, continued on the whole to prevail through the long cycles of Egyptian and Assyrian history. In the Egyptian

Current generalizations on the history of fine art: Hegel.

Herbert Spencer and the evolution theory.

palace-temple we find a monument at once political and religious, upon the production of which were concentrated all the energies and faculties of all the artificers of the race. With its incised and pictured walls, its half-detached colossi, its open and its colonnaded chambers, the forms of the columns and their capitals recalling the stems and blossoms of the lotus and papyrus, with its architecture everywhere taking on the characters and covering itself with the adornments of immature sculpture and painting—this structure exhibits within its single fabric the origins of the whole subsequent group of shaping arts. From hence it is a long way to the innumerable artistic surroundings of later Greek and Roman life, the many temples with their detached and their engaged statues, the theatres, the porticoes, the baths, the training-schools, the stadiums, with free and separate statues both of gods and men adorning every building and public place, the frescoes upon the walls, the panel pictures hung in temples and public and private galleries. In the terms of the Spencerian theory of evolution, the advance from the early Egyptian to the later Greek stage is an advance from the one to the manifold, from the simple to the complex, from the homogeneous to the heterogeneous, and affords a striking instance of that vast and ceaseless process of differentiation and integration which it is the law of all things to undergo. In the Christian monuments of the early middle age, again, the arts, owing to the political and social cataclysm in which Roman civilization went down, have gone back to the rudimentary stage, and are once more attached to and combined with each other. The single monument, the one great birth of art, in that age, is the Gothic church. In this we find the art of applied sculpture exercised in fashions infinitely rich and various, but entirely in the service and for the adornment of the architecture; we find painting exercised in fashions more rudimentary still, principally in the forms of translucent imagery in the chancel windows and tinted decorations on the walls and vaultings. From this stage again the process of the differentiation of the arts is repeated. It is by a new evolution or unfolding, and by one carried to much further and more complicated stages than the last had reached, that the arts since the middle age have come to the point where we find them to-day; when architecture is applied to a hundred secular and civil uses with not less magnificence, or at least not less desire of magnificence, than that with which it fulfilled its two only uses in the middle age, the uses of worship and of defence; when detached sculptures adorn, or are intended to adorn, all our streets and commemorate all our likenesses; when the subjects of painting have been extended from religion to all life and nature, until this one art has been divided into the dozen branches of history, landscape, still life, genre, anecdote and the rest. Such being in brief the successive stages, and such the reiterated processes, of evolution among the shaping or space arts, the action of the same law can be traced, it is urged, in the growth of the speaking or time arts also. Originally poetry and music, the two great speaking arts, were not separated from each other and from the art of bodily motion, dancing. The father of song, music and dancing, all three, was that primitive man of whom so much has already been said, he who first clapped hands and leapt and shouted in time at some festival of his tribe. From the clapping, or rudimentary rhythmical noise, has been evolved the whole art of instrumental music, down to the entrancing complexity of the modern symphony. From the shout, or rudimentary emotional utterance, has proceeded by a kindred evolution the whole art of vocal music down to the modern opera or oratorio. From the leap, or rudimentary expression of emotion by rhythmical movements of the body, has descended every variety of dancing, from the stately figures of the tragic chorus of the Greeks to the *kordax* of their comedy or the complexities of the modern ballet.

That the theory of evolution serves usefully to group and to interpret many facts in the history of art we shall not deny, though it would be easy to show that Herbert Spencer's instances and applications are not sufficient to sustain all the conclusions that he seems to draw from them. Thus, it is perfectly true

that the Egyptian or Assyrian palace wall is an instance of rudimentary painting and rudimentary sculpture in subservience to architecture. But it is not less true that races who had no architecture at all, but lived in caverns of the earth, exhibit, as we have already had occasion to notice, excellent rudiments of the other two shaping arts in a different form, in the carved or incised handles of their weapons. And it is almost certain that, among the nations of oriental antiquity themselves, the art of decorating solid walls so as to please the eye with patterns and presentations of natural objects was borrowed from the precedent of an older art which works in easier materials, namely, the art of the weaver. It would be in the perished textile fabrics of the earliest dwellers in the valleys of the Euphrates and the Nile that we should find, if anywhere, the origins of the systems of surface design, whether conventional or imitative, which those races afterwards applied to the decoration of their solid constructions. Not, therefore, in any one exclusive type of primitive artistic activity, but in a score of such types equally, varying according to race, region and circumstances, shall we find so many germs or nuclei from which whole families of fine arts have in the course of the world's history differentiated and unfolded themselves. And more than once during that history, a cataclysm of political and social forces has not only checked the process of the evolution of the fine arts, but from an advanced stage of development has thrown them back again to a primitive stage. Recent research has shown how the Minoan and Mycenaean civilizations in the Mediterranean basin, with their developed fine arts, must have perished and been effaced before the second growth of art from new rudiments took place in Greece. The great instance of the downfall of the Roman civilization need not be requoted. By Spencer's application of the theory of evolution, not less than by Hegel's theory of the historic periods, attention is called to the fact that Christian Europe, during several centuries of the middle age, presents to our study a civilization analogous to the civilization of the old oriental empires in this respect, that its ruling and characteristic manual art is architecture, to which sculpture and painting are, as in the oriental empires, once more subjugated and attached. It does not of course follow that such periods of fusion or mutual dependence among the arts are periods of bad art. On the contrary, each stage of the evolution of any art has its own characteristic excellence. The arts can be employed in combination, and yet be all severally excellent. When music, dancing, acting and singing were combined in the performance of the Greek chorus, the combination no doubt presented a relative perfection of each of the four elements analogous to the combined perfection, in the contemporary Doric temple, of pure architectural form, sculptured enrichment of spaces specially contrived for sculpture in the pediments and frieze, and coloured decoration over all. The extreme differentiation of any art from every other art, and of the several branches of one art among themselves, does not by any means tend to the perfection of that art. The process of evolution among the fine arts may go, and indeed in the course of history has gone, much too far for the health of the arts severally. Thus an artist of our own day is usually either a painter only or a sculptor only; but yet it is acknowledged that the painter who can model a statue, or the sculptor who can paint a picture, is likely to be the more efficient master of both arts; and in the best days of Florentine art the greatest men were generally painters, sculptors, architects and goldsmiths all at once. In like manner a landscape painter who paints landscape only is apt not to paint it so well as one who paints the figure too; and in recent times the craft of engraving had almost ceased to be an art from the habit of allotting one part of the work, as skies, to one hand, another part, as figures, to a second, and another part, as landscape, to a third. This kind of continually progressing subdivision of labour, which seems to be the necessary law of industrial processes, is fatal to any skill which demands, as skill in the fine arts, we have seen, demands, the free exercise and direction of a highly complex cluster both of faculties and sensibilities.

Weak and strong points of Spencer's generalization.

In the second half of the 19th century a reaction set in against such over-differentiation of the several manual arts and crafts.

Reaction against over-evolution amongst the fine arts.

This reaction is chiefly identified in England with the name of William Morris, who insisted by precept and example that one form of artistic activity was as worthy as another, and himself both practised and trained others in the practice of glass-painting, weaving, embroidery, furniture and wall-paper designing, and book decoration alike. His example has been to some extent followed in most European countries, and efforts have been made to reunite the functions of artist and craftsman, and to set a limit to the process of differentiation among the various manual arts. In the vocal or time arts also, a reformer of high genius and force of character, Richard Wagner, rose to contend that in music the process of evolution and differentiation had gone much too far. Music, he urged, as separated from words and actions, independent orchestral and instrumental music, had reached its utmost development, and its further advance could only be an advance into the inane; while operatic music had broken itself up into a number of set and separate forms, as aria, scena, recitative, which corresponded to no real varieties of instinctive emotional utterance, and in the aimless production of which the art was in danger of paralysing and stultifying itself. This process, he declared, must be checked; music and words must be brought back again into close connexion and mutual dependence; the artificial opera forms must be abolished, and a new and homogeneous music-drama be created, of which the author must combine in himself the functions of poet, composer, inventor, and director of scenery and stage appliances, so that the entire creation should bear the impress of a single mind; to the creation of such a music-drama he accordingly devoted all the energies of his being.

It is thus evident that the evolution theory, though it furnishes us with some instructive points of view for the history of the fine arts as for other things, is far from being the whole key to that history. Another key, employed with results perhaps less really luminous than they are certainly showy and attractive, is that supplied by Taine. Taine's philosophy, which might perhaps be better called a natural history, of fine art consists in regarding the fine arts as the necessary result of the general conditions under which they are at any time produced—conditions of race and climate, of religion, civilization and manners. Acquaint yourself with these conditions as they existed in any given people at any given period, and you will be able to account for the characters assumed by the arts of that people at that period, and to reason from one to the other, as a botanist can account for the flora of any given locality, and can reason from its soil, exposure and temperature, to the orders of vegetation which it will produce. This method of treating the history of the fine arts, again, is one which can be pursued with profit in so far as it makes the student realize the connexion of fine arts with human culture in general, and teaches him how the arts of any age and country are not an independent or arbitrary phenomenon, but are essentially an outcome, or efflorescence, to use a phrase of Ruskin's, of deep-seated elements in the civilization which produces them. But it is a method which, rashly used, is very apt to lead to a hasty and one-sided handling both of history and of art. It is easy to fasten on certain obvious relations of fine art to general civilization when you know a few of the facts of both, and to say, the cloudy skies and mongrel industrial population of Protestant Amsterdam at such and such a date had their inevitable reflection in the art of Rembrandt; the wealth and pomp of the full-fleshed burghers and bourgeois of Catholic Antwerp had theirs in the art of Rubens. But to do this in the precise and conclusive manner of Taine's treatises on the philosophy of art always means to ignore a large range of conditions or causes for which no corresponding effect is on the surface apparent, and generally also a large number of effects for which appropriate causes cannot easily be discovered at all.

These considerations have resulted in a reaction against

Taine's philosophy or natural history of the fine arts.

Taine's theories which goes probably too far. It is no complete confutation of his philosophy of art-history to contend, as has been done somewhat contemptuously by Professor Ernst Grosse and others, that the great artist, so far from representing the general tendencies of his time and environment, is commonly a solitary innovator and revolutionist, and has to educate and create his own public, often through years of obloquy or neglect. This is sometimes true when the traditions and ideals of art are undergoing revolution or swift experimental change, but hardly ever true in times of stable tradition and accepted ideals; and when true it only shows that the tendencies the innovating genius represents are tendencies which have till his time been working underground, and which he is born to bring into light and evidence. A new and revolutionary impulse in art, as in thought or politics, is like a yeast or ferment working at first secretly, affecting for a while only a few spirits, as a new epidemic may for a while only affect a few constitutions, and then gradually ripening and strengthening till it communicates itself to thousands. In its inception such a ferment is not, indeed, one of the obvious phenomena of the society in which it takes root, but it is none the less one of the most vital and significant phenomena. The truth is, that this particular efflorescence of human culture depends for its character at any given time upon combinations of causes which are by no means simple, but generally highly complex, obscure and nicely balanced. For instance, the student who should try to reason back from the holy and beatified character which prevails in much of the devotional painting of the Italian schools down to the Renaissance would be much mistaken were he to conclude, "like art, like life, thoughts and manners." He would not understand the relation of the art to the general civilization of those days unless he were to remember that one of the chief functions of the imagination is to make up for the shortcomings of reality, and to supply to contemplation images of that which is most lacking in actual life; so that the visions at once peaceful and ardent embodied by the religious schools of art in the Italian cities are to be explained, not by the peace, but rather in great part by the dispeace, of contemporary existence, and by the longing of the human spirit to escape into happier and more calm conditions.

Any one of the three modes of generalization to which we have referred might no doubt yield, however, supposing in the student the due gifts of patience and of caution, a working clue to guide him through that immense region of research, the history of the fine arts. But it is hardly possible to pursue to any purpose the history of the two great groups, the shaping group and the speaking group, together. At some stages of the world's history the manual and the monumental arts have flourished, as in Egypt and Assyria, when there was no fine art of words at all, and the only literature was that of records cut in hieroglyph or cuneiform on palace walls and temples, and on tablets, seals and cylinders. At other times and in other communities there has existed a great tradition and inheritance of poetry and song when the manual arts were only beginning to emerge again from the wreck of an old civilization, as in the Homeric age of Greece, or where they had never flourished at all except by imitation and importation, as in Palestine. In historic Greece all three divisions of the art of poetry, the epic, lyric and the dramatic, had been perfected, and two of them had again declined, before sculpture had reached maturity or painting had passed beyond the stage of its early severity. The European poetry of the middle ages, abundant and rich as it was alike in France and Provence, in Germany and Scandinavia, can yet not take rank, among the creations of human genius, beside the great masterpieces of Romanesque and Gothic architecture; it was in Italy only that Dante, before the end of that age, carried poetry to a place of equality if not of primacy among the arts. Taking the England of the Elizabethan age, we find the great outburst of our national genius in poetry contemporary with nothing more

Criticisms and counter-criticisms on Taine's methods.

Difficulty of combining the study of the manual with that of the vocal group of fine arts.

interesting in the manual arts than the gradual and only half-intelligent transformation of late Gothic architecture by the adoption of Italian Renaissance forms imported principally by way of Flanders or France, together with a fine native skill shown in the art of miniature portrait-painting, and none at all worth mentioning in other branches of painting or in sculpture. If the course of poetry and that of the manual arts have thus run independently throughout almost the whole field of history, those of music and the manual arts have been more widely separated still. In ancient Greece music and poetry were, we know, most intimately connected, but of the true nature of Greek music we know but little, of that of the earlier middle ages less still, and throughout the later middle ages and the earlier Renaissance the art remained undeveloped, whether in the service of the church or in secular and popular use, and in both cases in strict subservience to words. The growth of independent music is entirely the work of the modern world, and will probably rank in the esteem of posterity as its highest spiritual achievement and claim to gratitude, when the mechanical inventions and applications of applied science, which now occupy so disproportionate a part of the attention of humanity, have become a normal and unregarded part of its existence.

Moments in history there have no doubt been when literature and the manual arts, and even music, have been swept simultaneously along a single stream of ideas and feelings. Such a moment was experienced in France in 1830 and the following years, when (to choose only a few of the greatest names) Hugo in poetry, Delacroix in painting, and Berlioz in music were roused to a high pitch of consentaneous inspiration by the new ideas and feelings of romanticism. But such moments are rare and exceptional. On the other hand, it is very possible to take the whole of the shaping or manual group of fine arts together and to pursue their history connectedly throughout the course of civilization. By the history of art what is usually meant is indeed the history of these three arts with that of some of their subordinate and connected crafts. Leaving aside the arts of the races of the farther East, which, profoundly interesting as they are, have but gradually and late become known to us, and the relations of which with the arts of the nearer East and the Mediterranean are still quite obscure—leaving these aside, the history of the manual arts of architecture, painting and sculpture falls naturally into several great periods or divisions to some extent overlapping each other but in the main consecutive.

These periods are roughly as follows:—

1. The period of the great civilizations of Mesopotamia and the Nile, beginning approximately about 5000 B.C. and ending, roughly speaking (but some of them much earlier), with the spread of Greek power and Greek ideas under Alexander. On the main characteristics of the art of these empires we have already had occasion to touch.

2. The Minoan and Mycenaean period, partly contemporary with the above and dating probably from about 2500 to about 1000 B.C.; our knowledge of this is due entirely to quite recent researches, confined at present to certain points in Greece and Asia Minor, in Crete and other islands in the Mediterranean basin; enough has already been revealed to prove the existence of an original and highly developed palace-architecture and of forms of relief-painting and of all the minor and decorative arts more free and animated than anything known to Egypt or Assyria. (See CRETE and AEGEAN CIVILIZATION.)

3. The Greek and Roman period, from about 700 B.C. to the final triumph of Christianity, say A.D. 400. During the first two or three centuries of this period the Hellenic race, beginning again after the cataclysm which had swallowed up the earlier Mediterranean civilizations, carried to perfection its most characteristic art, that of sculpture, in the endeavour to embody worthily its ideas of the supernatural powers governing the world. Putting aside the monstrous gods of Egypt and the East, it found its ideals in varieties of the human form as presented by the most harmoniously developed specimens of the race under conditions of the greatest health, activity and grace. In the figures

of Greek sculpture, both decorative and independent, and no doubt in Greek painting also (but of that we can only judge from such specimens of the minor handicrafts, chiefly vase-paintings, as have come down to us)—in these were set for the whole Western world the types and standards of human beauty, and in their grouping and arrangement the types and standards of rhythmical composition and design. Gradually human portraiture and themes of everyday life took their place beside representations of the gods and heroes. New schools struck out new tendencies within certain limits. But in the general standards of form and design there was in the imitative arts relatively little change, though towards the end there was much failure of skill, throughout the whole period. The one great change was in architecture. Greece had been content with the constructive system of columns and horizontal entablature, and under that system had invented and perfected her three successive modes or orders of architecture—the Doric, Ionic and Corinthian. The genius of Rome invented the round arch, and by help of that system erected throughout her subject world a thousand vast constructions—temple, palace, bath, amphitheatre, forum, aqueduct, triumphal gate and the rest—on a scale of monumental grandeur such as Greece had never known.

4. The Christian period, from about 400 to about 1400. The decay or petrification of the imitative arts which had set in during the latter days of Rome continued during all the earlier centuries of the Christian period, while the Western world was in process of remaking. Free painting and free sculpture practically ceased to exist. Roman architecture underwent modifications under the influence of the church and of the new conditions of life; the Byzantine form, touched at certain times and places with oriental influences, developed itself wherever the Eastern Empire still stood erect in decay; the Romanesque form, as it is called, in the barbarian-conquered regions of the west and north. Sculpture existed for centuries only in rudimentary and subordinate forms as applied to architecture; painting only in forms of rigid though sometimes impressive hieratic imagery, whether as mosaic in the apses and vaults of churches, as rude illumination in MSS. and service-books, or as still ruder altar-painting carried on according to a frozen mechanical tradition. As time went on and medieval institutions developed themselves, a gradual vitality dawned in all these arts. In architecture the introduction of the pointed or Gothic arch at the beginning of the 13th century led to almost as great a revolution as that brought about by the use of the round or vaulted arch among the Romans. The same vital impulse that informed the new Gothic architecture breathed into the still quite subordinate arts of sculpture and painting (the latter now including the craft of glass-painting for church windows) a new spirit whether of devotional intensity or sweetness, or of human pathos or rugged humour, with a new technical skill for its embodiment. We have not set down, as is usually done, a specifically Gothic period in art, for this reason. The characteristic of the whole Christian period is that its dominant art is architecture, chiefly employed in the service of the church, with painting and sculpture only subordinately introduced for its enrichment. It makes no essential difference that from the 5th to the 12th century the forms of this art were derived with various modifications from the round-arched architecture of the Empire, and that by the 13th century new forms both of construction and decoration, in which the round arch was replaced by the pointed, had been invented in France, and from thence spread abroad to Germany and Scandinavia, Great Britain, Spain, and last and most superficially to Italy. The essential difference only begins when the imitative arts, sculpture and painting, begin to emancipate and detach themselves, to exist and strive after perfection on their own account. This happened first and very partially in Italy with the artificers of the 13th and 14th centuries—with the sculptors Nicola, Giovanni, and Andrea Pisano; the Sienese group of painters, Duccio, Simone Martini, and the Lorenzetti; and the Florentine group, Cimabue (if Cimabue is not a myth), Giotto and the Giotteschi. The

development of the rapid and flowing craft of fresco in place of the laborious and piecemeal craft of mosaic (henceforth for several centuries almost lost) was a great aid to this movement. After a period of something like stagnation, the movement received a vigorous fresh impulse soon after 1400, at about which date in Italy (not till near a century later in northern Europe) the beginning of the Renaissance is usually fixed.

5. The Renaissance period, from about 1400 to about 1600. The passion for classic literature, stimulated by the influence of Greek scholars into Italy after the fall of Constantinople; the enthusiastic revival of classic forms of architecture by architects like Brunelleschi and Alberti; the achievements in sculpture and painting of masters like Donatello and Masaccio, based on a new and impassioned study of nature and the antique together; these are the outstanding and universally known symptoms of the Italian Renaissance in the second and third quarters of the 15th century. Promptly and contemptuously in Italy, much more gradually and incompletely in the north, Gothic principles of construction and decoration were cast aside for classical principles, as reformulated by eager spirits from a combined study of Roman remains and of the text of Vitruvius. To the ideal types of devout and prayer-worn, ascetic and spiritualized humanity (tempered in certain subjects with elements of the homely and the grotesque), which the spirit of the middle ages had dictated to the sculptor and the painter, succeeded ideals of physical power, beauty and grace rivalling the Hellenic. The personages of the Christian faith and story were brought into visible kindred with those of ancient paganism. In the hands of certain artists a fortunate blending of the two ideals yielded results of a poignant and unique charm, which for us, who are the heirs both of antiquity and the middle ages, is far from being yet exhausted. At the same time, the love alike of republics, great princes, churchmen, nobles and merchants for works of art gave employment to sculptors and painters on themes other than ecclesiastical. The taste for civic or personal commemoration, for portraiture, for illustrations of allegory, romance and classic fable, covered with pictures the walls of council halls, of public and private palaces, and of villas. The invention of the oil medium by the painters of Flanders, and its gradual adoption by the Venetians and other schools of Italy for all purposes except the external decorations of buildings, added enormously to the resources of the art in rivalry with nature, and to the splendour of its results as objects of pride and luxury. The glories of matured Italian art reacted, not always favourably, on the north. The great days of Flemish painting had been from about 1430 to 1500, before any appreciable influence of the Renaissance had touched the schools of Brussels, of Bruges or of Antwerp. By about 1520 the artists of those schools had begun, except in portraiture, to lose their native vigour and originality by contact with the alien south. Among the great artists of Germany in the first half of the 16th century the work of one or two, like Burgkmair and Holbein, shows Italian influence reconciled not unsuccessfully with native instinct; but Dürer, the greatest of them, remained in all essentials Gothic and German to the end. During the last half of the century, the Netherlands and Germany alike yielded little but work of mongrel Teutonized Italian or Italianized Teutonic type, until towards its close Rubens accomplished, in the fire of his prodigious temperament, a true fusion of Flemish and Venetian qualities, at the same time closing gloriously the Renaissance period properly so called, and handing on an example which irresistibly affected a great part of modern painting.

6. Modern period, from about 1600 to the present time. During this period architecture remained in all European countries, until the 19th century, more or less completely under the influence of the Italian Renaissance. The principles of the classical revival had during a century or more of transition been gradually absorbed, first by France, then by Germany, the Low Countries, and Spain, and last by England, each country modifying the style according to its degree of knowledge or ignorance, its needs, instincts and traditions. Sculpture, which in the

hands of the great masters of the earlier and later Renaissance in Italy had almost equalled its ancient glories, nay, in those of Michelangelo had actually surpassed them in the qualities at least of superhuman energy and intellectual expression—sculpture lost the sense of its true limitations, and entered, with the work of Bernini and even earlier, into an extravagant or "baroque" period of relaxed and bulging line, of exaggerated and ostentatious virtuosity. In this it followed the lead given by Italian architecture, by Jesuit church architecture especially, at and after the height of the Catholic reaction. From the monumental and memorial purposes which sculpture principally serves, it remained still, except in purely iconic uses, attached to or dependent on architecture. Not so painting, which asserted its independence more and more. In Protestant countries the old ecclesiastical patronage of the art had quite died out; in those that remained Catholic it continued, and even received a new stimulus from the anti-Protestant reaction. The demand for religious art was supplied with abundance of traditional facility, of technical accomplishment and devotional display, but with a loss of the old sincerity and inspiration. Almost all painting, even for the most extensive and monumental phases of decoration in church or palace or civic hall, was on canvas stretched over or fitted into its allotted space in the architecture, and the art of fresco, even in Venice, its last stronghold, was for a time neglected or forgotten. Portable paintings for princely or private galleries and cabinets became the chief and most characteristic products of the art. The subjects of painting multiplied themselves. All manner of new aspects of life and nature were brought within the technical compass of the painter. Besides devotional and classical subjects and portraiture, daily life in all its phases, down to the homeliest and grossest, the life of the parlour and the tavern, of field and shore and sea, with landscape in all its varieties, took their place as material for the painter. The truths of indoor and outdoor atmosphere were translated on canvas for the first time. The Dutchmen from about 1620 to 1670 were the most active innovators and path-breakers of modern art along all these lines. The greatest of them, Rembrandt, dealt, as has been said, like a master and a magician with the problems of human individuality as revealed in a mysterious colour and shadow world of his own invention. At the same time a painter of no less power in Spain, Velazquez, viewing the world in the natural light of every day, showed for the first time how vitally and subtly paint could render the relief and mutual values of figures and objects in space, the essential truth of their visible relations and reactions in the enveloping atmosphere. The achievement of these two victorious innovators has only come to be fully understood in our own day. The simultaneous conquest of Claude le Lorrain, on the other hand, over the atmospheric glow of summer and sunset on the Roman Campagna and the adjacent hills and coasts, found acceptance instantly, less perhaps for its own sake than because of the classical associations of the scenery which he depicted. The vast widening of the field of the painter's art and multiplication of its subjects, which thus took place at the dawn of the modern period, were gains attended by one drawback, the loss, namely, of the sense of high seriousness and universal appeal which belonged to the art while its themes had been those of religion and classic story almost exclusively.

During the three hundred or so years of the modern period, academical schools attempting, more or less unsuccessfully, to carry on the great Italian and classical traditions of the Renaissance have not ceased to exist side by side with those which have striven to express new ways of seeing and feeling. Sometimes, as in France first under Louis XIV., and again for forty years from the beginning of the Revolution to the dawn of romanticism, such schools have succeeded in crushing out and discrediting all efforts in other directions. Between these two epochs, say from 1710 to 1780, French 18th-century ideals of social elegance and brilliant frivolity expressed themselves in forms of great accomplishment and vivacity both in poetry and sculpture, from the days of Watteau to those of Fragonard and Clodion.

*Classical
and
romantic
revivals.*

At the same time England produced one of the finest and at the same time most national and downright masters of the brush in Hogarth; two of the greatest aristocratic portrait-painters of the world in Reynolds and Gainsborough, each of whom modified according to his own instincts the tradition imported in the previous century by Van Dyck, the greatest pupil of Rubens (Reynolds fusing with this influence those of Rembrandt and the Venetians in almost equal shares). Pastoral landscape in the hands of Gainsborough, classical, following Claude, in those of Wilson—these together with the humble but wholesome discipline of topographical illustration led on to the ambitious, wide-ranging and often inspired experiments of Turner, and to the narrower but more secure achievements of Constable in the same field, and made this country the acknowledged pioneer of modern landscape art. In the meantime the wave of classical enthusiasm which passed over Europe in the later years of the 18th century had produced in architecture generally a return to severer principles and purer lines, in reaction from the baroque and the rococo Renaissance styles of the preceding century and a half. In Italian sculpture, the same movement inspired during the Napoleonic period the over-honeyed accomplishment of Canova and his school; in northern sculpture, the more truly antique but almost wholly imitative work of Thorwaldsen, and the pure and rhythmic grace of the English Flaxman, a true master of design though scarcely of sculpture strictly so called. The same movement again was partly responsible in English painting and illustration from about 1770 to 1820 for much pastoral and idyllic work of agreeable but shallow elegance. In French painting the classic movement struck deeper. Along with much would-be Roman attitudinizing there was much real, if rigid, power in the work of David, much accomplished purity and sweetness in that of Prud'hon. The last and truest classic of France, and at the same time in portraiture the greatest realist, Ingres, held high the standard of his cause even through and past the great romantic revival which began with Géricault and culminated in Delacroix and the school of landscape painters who had received their inspiration from Constable. The main instincts embodied in the Romantic movement were the awakening of the human spirit to an eager retrospective love of the past, and especially of the medieval past, and simultaneously to a new passion for the beauties of nature, and especially of wild nature. Germany and England preceded France in this double awakening; in both countries the movement inspired a fine literature, but in neither did it express itself so fully and self-consciously through literature and the other arts together as it did in France when the hour struck. The revival of medieval sentiment in Germany had inspired comparatively early in the century the learned but somewhat aridly ascetic and essentially unpainterlike work of the group of artists who styled themselves *Nazarener*. In England the same revival expressed itself during a great part of the Victorian age in an enthusiastic return to the early Gothic ecclesiastical styles of architecture, a return unsuccessful upon the whole, because in pursuit of archaeological and grammatical detail the root qualities of right proportion and organic design were too often neglected.

Allied with this Gothic revival, and stimulated like it by the persuasive conviction and brilliant resource of Ruskin in criticism was the pre-Raphaelite movement in painting. Among the artists identified with this movement there was little really in common except in impatience of the prevailing modes of empty academic convention or anecdotic frivolity. The name covered for a while the essentially divergent aims of a vigorous unintellectual craftsman like Millais, fired for a few years in youth by contact with more imaginative temperaments, of a strenuous imitator of unharmonized local colours and unsubordinated natural facts like Holman Hunt, and of born poets and impassioned medievalists like Rossetti and after him Burne-Jones. Meantime in France, putting aside the work of the great Delacroix, the impulse of 1830 expressed itself best and most lastingly in the monumental work of Daumier both in caricature and romance, the impressive and significant treatment of peasant life and labour by J. F.

Millet, the vitally truthful pastoral and landscape work of Troyon, Corot, Daubigny and the rest.

Since the exhaustion of the Romantic movement, the other movements that have been taking place in European art have been too numerous and too rapid to be touched on here to any purpose. Both in sculpture and painting France has taken and held the lead. Mention has already been made of the special tendency in recent sculpture identified with the name and influence of Rodin. In painting there has been the fertilizing and transforming influence of Japan on the decorative ideals of the West; there have been successively the Realist movement, the movements of the Impressionists, the Luminists, the Neo-impressionists, the Independents, movements initiated almost always in Paris, and in other countries eagerly adopted and absorbed, or angrily controverted and denounced, or simply neglected and ignored according to the predilection of this or that group of artists and critics; there has been a vast amount of heterogeneous, hurried, confident and clamant innovating activity in this direction and in that, much of it perhaps doomed to futility in the eyes of posterity, but at any rate there has not been stagnation.

BIBLIOGRAPHY.—To attempt in this place anything like a full bibliography covering so vast a field would be idle. Many of the books necessary to a first-hand study of the subject are cited in the article **AESTHETICS**. The following are some of the most important writings actually referred to in the text, English translations being mentioned where they exist: Aristotle, *Poetics*, edited with critical notes and a translation by S. H. Butcher (1898); S. H. Butcher, *Aristotle's Theory of Poetry and Fine Art*, with a critical text and a translation of the *Poetics* (1902); Plato, *Republic*, bk. x. 596 ff., 600 ff. (Grote, iii. 117 ff.; Jowett, iii. 489 ff.); B. Bosanquet, *Introduction to Hegel's Philosophy of Fine Art (Ästhetik)*, translation with notes and prefatory essay (1896); *The Philosophy of Art, an Introduction to the Science of Aesthetics*, by Hegel and C. L. Michelet, trans. Hastie (1886); Schiller, *Briefe über die ästhetische Erziehung des Menschen* (trans. by G. J. Weiss, with preface by J. Chapman, 1845; also in Bohn's Standard Library, 1846); Herbert Spencer, *First Principles*, ch. xxii.; Gottfried Semper, *Der Stil* (1860–1863); Hippolyte Taine, *De l'idéal dans l'art* (1867), *Philosophie de l'art en Grèce* (1869), *Philosophie de l'art en Italie*, *Philosophie de l'art dans les Pays-Bas* (translations in 5 vols. by J. Durand, New York, 1889); Karl Groos, *Die Spiele der Menschen* (1899; trans. by E. L. Baldwin, 1901), and *Die Spiele der Tiere* (2nd ed., 1907; trans. by E. L. Baldwin, 1898); Ernst Grosse, *Die Anfänge der Kunst* (1894; trans. in the Anthropological Series, 1894); Yrjö Hirn, *The Origins of Art* (1900); G. Baldwin Brown, *The Fine Arts* (2nd ed., 1902); Felix Clay, *The Origins of the Sense of Beauty* (1908). For a general history of the manual or shaping group of arts, C. J. F. Schnasse, *Geschichte der bildenden Künste* (2nd ed., 1866–1879), though in parts obsolete, is still unsurpassed. A very summary general view is given in Salomon Reinach, *The Story of Art through the Ages* (trans. by Florence Simmonds, 1904); a general history of the same group was undertaken by Giulio Carotti (English translation by Alice Todd, 1909). (S. C.)

FINGER, one of the five members with which the hand is terminated, a digit; sometimes the word is restricted to the four digits other than the thumb. The word is common to Teutonic languages, cf. Dutch *vinger* and Ger. *Finger*; probably the ultimate origin is to be found in the root of the words appearing in Greek *πέγρε*, Lat. *quincus*, five. (See **SKELTON: Appendicular**.)

FINGER-AND-TOE, CLUB ROOT or ANBURY, a destructive plant-disease known botanically as *Plasmiodiophora Brassicae*, which attacks cabbages, turnips, radishes and other cultivated and wild members of the order Cruciferae. It is one of the so-called Slime-fungi or Myxogastres. The presence of the disease is indicated by nodules or warty outgrowths on the root, which sometimes becomes much swollen and ultimately rots, emitting an unpleasant smell. The disease is contracted from spores present in the soil, which enter the root. The parasite develops within the living cells of the plant, forming a glairy mass of protoplasm known as the *plasmodium*, the form of which alters from time to time. The cells which have been attacked increase enormously in size and the disease spreads from cell to cell. Ultimately the plasmodium becomes resolved into numerous minute round spores which, on the decay of the root, are set free in the soil. A preventive is quicklime, the

The pre-Raphaelites.

Contemporary tendencies.

application of which destroys the spores in the soil. It is important that diseased plants should be burned, also that cruciferous

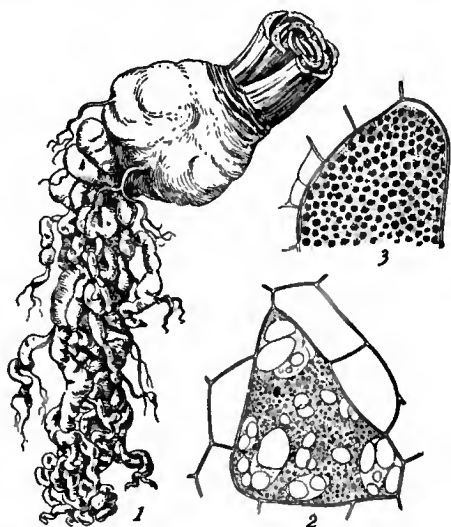

Finger-and-Toe (*Plasmodiophora Brassicae*).

- 1, Turnip attacked by the disease, reduced.
- 2, A cell of the tissue containing the plasmodium; the smaller cells at the sides are unaffected.
- 3, Infected cell, showing spore formation. 2, 3, highly magnified.

weeds, such as shepherd's purse, charlock, &c., should not be allowed to grow in places where plants of the same order are in cultivation.

FINGER-PRINTS. The use of finger-prints as a system of identification (*q.v.*) is of very ancient origin, and was known from the earliest days in the East when the impression of his thumb was the monarch's sign-manual. A relic of this practice is still preserved in the formal confirmation of a legal document by "delivering" it as one's "act and deed." The permanent character of the finger-print was first put forward scientifically in 1823 by J. E. Purkinje, an eminent professor of physiology, who read a paper before the university of Breslau, adducing nine standard types of impressions and advocating a system of classification which attracted no great attention. Bewick, the English draughtsman, struck with the delicate qualities of the lineation, made engravings of the impression of two of his fingertips and used them as signatures for his work. Sir Francis Galton, who laboured to introduce finger-prints, points out that they were proposed for the identification of Chinese immigrants when registering their arrival in the United States. In India, Sir William Herschel desired to use finger-prints in the courts of the Hugli district to prevent false personation and fix the identity upon the executants of documents. The Bengal police under the wise administration of Sir E. R. Henry, afterwards chief commissioner of the London metropolitan police, usefully adopted finger-prints for the detection of crime, an example followed in many public departments in India. A transfer of property is attested by the thumb-mark, so are documents when registered, and advances made to opium-growers or to labourers on account of wages, or to contracts signed under the emigration law, or medical certificates to vouch for the persons examined, all tending to check the frauds and impostures constantly attempted.

The prints depend upon a peculiarity seen in the human hand and to some extent in the human foot. The skin is traversed in all directions by creases and ridges, which are ineradicable and show no change from childhood to extreme old age. The persistence of the markings of the finger-tips has been proved beyond all question, and this universally accepted quality has been the basis of the present system of identification. The impressions, when examined, show that the ridges appear in certain fixed patterns, from which an alphabet of signs or a

system of notation has been arrived at for convenience of record. As the result of much experiment a fourfold scheme of classification has been evolved, and the various types employed are styled "arches," "loops," "whorls" and "composites." There are seven subclasses, and all are perfectly distinguishable by an expert, who can describe each by its particular symbol in the code arranged, so that the whole "print" can be read as a distinct and separate expression. Very few, and the simplest, appliances are required for taking the print—a sheet of white paper, a tin slab, and some printer's ink. Scars or malformations do not interfere with the result.

The unchanging character of the finger-prints has repeatedly helped in the detection of crime. We may quote the case of the thief who broke into a residence and among other things helped himself to a glass of wine, leaving two finger-prints upon the tumbler which were subsequently found to be identical with those of a notorious criminal who was arrested, pleaded guilty and was convicted. Another burglar effected entrance by removing a pane of glass from a basement window, but, unhappily for him, left his imprints, which were referred to the registry and found to agree exactly with those of a convict at large; his address was known, and when visited some of the stolen property was found in his possession. In India a murderer was identified by the brown mark of a blood-stained thumb he had left when rummaging amongst the papers of the deceased. This man was convicted of theft but not of the murder.

The keystone to the whole system is the central office where the register or index of all criminals is kept for ready reference. The operators need no special gifts or lengthy training; method and accuracy suffice, and abundant checks exist to obviate incorrect classification and reduce the liability to error.

AUTHORITIES.—F. Galton, *Finger Prints* (1892), *Fingerprint Directories* (1895); E. R. Henry, *Classification and Uses of Finger Prints*; A. Yvert, *L'Identification par les empreintes digitales palmaires* (1905); K. Windt, R. S. Kodicek, *Daktyloskopie. Verwertung von Fingerabdrücken zu Identifizierungszwecken* (Vienna, 1904); E. Loard, *La Dactyloscopie. Identification des récidivistes par les empreintes digitales* (1904); H. Faulds, *Guide to Finger-Print Identification* (1905); H. Gross, *Criminal Investigation* (trans. J. and J. C. Adam, 1907). (A. G.)

FINGO, or **FENGU** (*Ama-Fengu*, "wanderers"), a Bantu-Negro people, allied to the Zulu family, who have given their name to the district of Fingoland, the S.W. portion of the Transkei division of the Cape province. The Fingo tribes were formed from the nations broken up by Chaka and his Zulu; after some years of oppression by the Xosa they appealed to the Cape government in 1835, and were permitted by Sir Benjamin D'Urban to settle on the banks of the Great Fish river. They have been always loyal to the British, and have steadily advanced in social respects. They have largely adapted themselves to western culture, wearing European clothes, supporting their schools by voluntary contributions, editing newspapers, translating English poetry, and setting their national songs to correct music. The majority call themselves Christians and many of them have intermarried with Europeans. (See **KAFFIRS**.)

FINIAL (a variant of "final"; Lat. *finis*, end), an architectural term for the termination of a pinnacle, gable end, buttress, or canopy, consisting of a bunch of foliage, which bears a close affinity to the crockets (*q.v.*) running up the gables, turrets or spires, and in some cases may be formed by uniting four or more crockets together. Sometimes the term is incorrectly applied to a small pinnacle of which it is only the termination (see **EPI**).

FINIGUERRA, **MASO** [*i.e.* TOMMASO] (1426-1464), Florentine goldsmith, draughtsman, and engraver, whose name is distinguished in the history of art and craftsmanship for reasons which are partly mythical. Vasari represents him as having been the first inventor of the art of engraving (using that word in its popular sense of taking impressions on paper from designs engraved on metal plates), and Vasari's account was universally accepted and repeated until recent research proved it erroneous. What we actually know from contemporary documents of Finiguerra, his origin, his life, and his work, is as follows. He

was the son of Antonio, and grandson of Tommaso Finiguerra or Finiguerrri, both goldsmiths of Florence, and was born in Sta Lucia d'Ognissanti in 1426. He was brought up to the hereditary profession of goldsmith and was early distinguished for his work in niello. In his twenty-third year (1449) we find note of a sulphur cast from a niello of his workmanship being handed over by the painter Alessio Baldovinetti to a customer in payment or exchange for a dagger received. In 1452 Maso delivered and was paid for a niellated silver pax commissioned for the baptistery of St John by the consuls of the gild of merchants or Calimara. By this time he seems to have left his father's workshop: and we know that he was in partnership with Piero di Bartolommeo di Salì and the great Antonio Pollaiuolo in 1457, when the firm had an order for a pair of fine silver candlesticks for the church of San Jacopo at Pistoia. In 1459 we find Finiguerra noted in the house-book of Giovanni Rucellai as one of several distinguished artists with whose works the Casa Rucellai was adorned. In 1462 he is recorded as having supplied another wealthy Florentine, Cino di Filippo Rinuccini, with waist-buckles, and in the years next following with forks and spoons for christening presents. In 1463 he drew cartoons, the heads of which were coloured by Alessio Baldovinetti, for five or more figures for the sacristy of the duomo, which was being decorated in wood inlay by a group of artists with Giuliano da Maiano at their head. On the 14th of December 1464 Maso Finiguerra made his will, and died shortly afterwards.

These documentary facts are supplemented by several writers of the next generation with statements more or less authoritative. Thus Baccio Bandinelli says that Maso was among the young artists who worked under Ghiberti on the famous gates of the baptistery; Benvenuto Cellini that he was the finest master of his day in the art of niello engraving, and that his masterpiece was a pax of the Crucifixion in the baptistery of St John; that being no great draughtsman, he in most cases, including that of the above-mentioned pax, worked from drawings by Antonio Pollaiuolo. Vasari, on the other hand, allowing that Maso was a much inferior draughtsman to Pollaiuolo, mentions nevertheless a number of original drawings by him as existing in his own collection, "with figures both draped and nude, and histories drawn in water-colour." Vasari's account was confirmed and amplified in the next century by Baldinucci, who says that he has seen many drawings by Finiguerra much in the manner of Masaccio; adding that Maso was beaten by Pollaiuolo in competition for the reliefs of the great silver altar-table commission by the merchants' gild for the baptistery of St John (this famous work is now preserved in the Opera del Duomo). But the paragraph of Vasari which has chiefly held the attention of posterity is that in which he gives this craftsman the credit of having been the first to print off impressions from niello plates on sulphur casts and afterwards on sheets of paper, and of having followed up this invention by engraving copper-plates for the express purpose of printing impressions from them, and thus became the inventor and father of the art of engraving in general. Finiguerra, adds Vasari, was succeeded in the practice of engraving at Florence by a goldsmith called Baccio Baldini, who, not having much invention of his own, borrowed his designs from other artists and especially from Botticelli. In the last years of the 18th century Vasari's account of Finiguerra's invention was held to have received a decisive and startling confirmation under the following circumstances. There was in the baptistery at Florence (now in the Bargello) a beautiful 15th-century niello pax of the Coronation of the Virgin. The Abate Gori, a savant and connoisseur of the mid-century, had claimed this conjecturally for the work of Finiguerra; a later and still more enthusiastic virtuoso, the Abate Zani, discovered first, in the collection of Count Seratti at Leghorn, a sulphur cast from the very same niello (this cast is now in the British Museum), and then, in the National library at Paris, a paper impression corresponding to both. Here, then, he proclaimed, was the actual material first-fruit of Finiguerra's invention and proof positive of Vasari's accuracy.

Zani's famous discovery, though still accepted in popular

art histories and museum guides, is now discredited among serious students. For one thing, it has been proved that the art of printing from engraved copper-plates had been known in Germany, and probably in Italy also, for years before the date of Finiguerra's alleged invention. For another, Maso's pax for the baptistery, if Cellini is to be trusted, represented not a Coronation of the Virgin but a Crucifixion. In the next place, its recorded weight does not at all agree with that of the pax claimed by Gori and Zani to be his. Again, and perhaps this is the strongest argument of any, all authentic records agree in representing Finiguerra as a close associate in art and business of Antonio Pollaiuolo. Now nothing is more marked than the special style of Pollaiuolo and his group; and nothing is more unlike it than the style of the Coronation pax, the designer of which must obviously have been trained in quite a different school, namely that of Filippo Lippi. So this seductive identification has to be abandoned, and we have to look elsewhere for traces of the real work of Finiguerra. The only fully authenticated specimens which exist are the above-mentioned tarsia figures, over half life-size, executed from his cartoons for the sacristy of the duomo. But his hand has lately been conjecturally recognized in a number of other things: first in a set of drawings of the school of Pollaiuolo at the Uffizi, some of which are actually inscribed "Maso Finiguerra" in a 17th-century writing, probably that of Baldinucci himself; and secondly in a very curious and important book of nearly a hundred drawings by the same hand, acquired in 1888 for the British Museum. The Florence series depicts for the most part figures of the studio and the street, to all appearance members of the artist's own family and workshop, drawn direct from life. The museum volume, on the other hand, is a picture-chronicle, drawn from imagination, and representing parallel figures of sacred and profane history, in a chronological series from the Creation to Julius Caesar, dressed and accoutred with inordinate richness according to the quaint pictures which Tuscan popular fancy in the mid-15th century conjured up to itself of the ancient world. Except for the differences naturally resulting from the difference of subject, and that the one series are done from life and the other from imagination, the technical style and handling of the two are identical and betray unmistakably a common origin. Both can be dated with certainty, from their style, costumes, &c., within a few years of 1460. Both agree strictly with the accounts of Finiguerra's drawings left us by Vasari and Baldinucci, and disagree in no respect with the character of the inlaid figures of the sacristy. That the draughtsman was a goldsmith is proved on every page of the picture-chronicle by his skill and extravagant delight in the ornamental parts of design—chased and jewelled cups, helmets, shields, breastplates, scabbards and the like,—as well as by the symmetrical metallic forms into which he instinctively conventionalizes plants and flowers. That he was probably also an engraver in niello appears from the fact that figures from the Uffizi series of drawings are repeated among the rare anonymous Florentine niello prints of the time (the chief collection of which, formerly belonging to the marquis of Salamanca, is now in the cabinet of M. Edmond de Rothschild in Paris). That he was furthermore an engraver on copper seems certain from the fact that the general style and many particular figures and features of the British Museum chronicle drawings are exactly repeated in some of those primitive 15th-century Florentine prints which used to be catalogued loosely under the names of Baldini or Botticelli, but have of late years been classed more cautiously as anonymous prints in the "fine manner" (in contradistinction to another contemporary group of prints in the "broad manner"). The fine-manner group of primitive Florentine engravings itself falls into two divisions, one more archaic, more vigorous and original than the other, and consisting for the most part of larger and more important prints. It is this division which the drawings of the Chronicle series most closely resemble; so closely as almost to compel the conclusion that drawings and engravings are by the same hand. The later division of fine-manner prints represent a certain degree of technical advance from the earlier, and are

softer in style, with elements of more classic grace and playfulness; their motives moreover are seldom original, but are borrowed from various sources, some from German engravings, some from Botticelli or a designer closely akin to him, some from the pages of the British Museum Chronicle-book itself, with a certain softening and attenuating of their rugged spirit; as though the book, after the death of the original draughtsman-engraver, had remained in his workshop and continued to be used by his successors. We thus find ourselves in presence of a draughtsman of the school of Pollaiuolo, some of whose drawings bear an ancient attribution to Finiguerra, while all agree with what is otherwise known of him, and one or two are exactly repeated in extant works of niello, the craft which was peculiarly his own; others being intimately related to the earliest or all but the earliest works of Florentine engraving, the kindred craft which tradition avers him to have practised, and which Vasari erroneously believed him to have invented. Surely, it has been confidently argued, this draughtsman must be no other than the true Finiguerra himself. The argument has not yet been universally accepted, but neither has any competent criticism appeared to shake it; so that it may be regarded for the present as holding the field.

BIBLIOGRAPHY.—See Bandinelli in Bottari, *Raccolta di lettere* (1754), i. p. 75; Vasari (ed. Milanese), i. p. 209, iii. p. 206; Benvenuto Cellini, *I Trattati dell' orificeria*, &c. (ed. Lemonnier), pp. 7, 12, 13, 14; Baldinucci, *Notizie dei professori di disegno* (1845), i. pp. 518, 519, 533; Zani, *Materiali per servire*, &c. (1802); Duchesne, *Essai sur les nielles* (1824); Dutuit, *Manuel de l' amateur d'estampes*, vol. i. pref. and vol. ii.; and for a full discussion of the whole question, with quotations from earlier authorities and reproductions of the works discussed, Sidney Colvin, *A Florentine Picture Chronicle* (S. C.) (1898).

FINISHING. The term *finishing*, as specially applied in the textile industries, embraces the process or processes to which bleached, dyed or printed fabrics of any description are subjected, with the object of imparting a characteristic appearance to the surface of the fabric, or of influencing its handle or feel. Strictly speaking, certain operations might be classed under this heading which are conducted previous to bleaching, dyeing, &c.; e.g. mercerizing (*q.v.*), stretching and crabbing, singeing (see BLEACHING); but as these are not undertaken by the finisher, only those will be dealt with here which are not mentioned under other headings. By the various treatments to which the fabric is subjected in finishing, it is often so altered in appearance that it is impossible to recognize in it the same material that came from the loom or from the bleacher or dyer. On the other hand, one and the same fabric, subjected to different processes of finishing, may be made to represent totally different classes of material. In other cases, however, the appearance of the finished article differs but slightly from that of the piece on leaving the loom.

All processes of finishing are purely mechanical in character, and the most important of them depend upon the fact that in their ordinary condition (*i.e.* containing their normal amount of moisture), or better still in a damp state, the textile fibres are plastic, and consequently yield to pressure or tension, ultimately assuming the shape imparted to them. The old-fashioned box press, formerly largely used for household linen, owed its efficacy to this principle. At elevated temperatures the damp fibres become very much more plastic than at the ordinary temperature, the simplest form of finishing appliance based on this fact being the ordinary flat iron. Indeed it may safely be stated that most of the modern finishing processes have been evolved from the household operations of washing (milling), brushing, starching, mangling, ironing and pressing.

Cotton Pieces.—In the ordinary process of bleaching, cotton goods are subjected during the various operations to more or less continual longitudinal tension, and while becoming elongated, shrink more or less considerably in width. In order to bring them back to their original width, they are stretched or "stentered" by means of specially constructed machines. The most effective of these is the so-called stentering frame, which consists essentially of two slightly diverging endless chains carrying clips or pins which hold the piece in position as it

traverses the machine. The length of a frame may vary from 20 to 30 yds. On the upper part of the frame the chains run in slots, and by means of set screws the distance between the two chains can be set within the required limits. The pieces are fed on to one end of the machine in the damp state by hand and are then naturally slack. But before they have travelled many yards they become taut, the stretching increasing as they travel along. Simultaneously with the stretching, the pieces are dried by a current of hot air which is blown through from below, so that on arriving at the end of the machine they are not only stretched to the required degree but are also dry. The machine used for stentering is more fully described under MERCERIZING (*q.v.*). In case the goods come straight from the loom to be finished, stentering is not necessary.

Pieces intended to receive a "pure" finish pass on without further treatment to the ordinary finishing processes such as calendering, hot pressing, raising, &c. But in the majority of cases they are previously impregnated, according to the finish desired, with stiffening or softening agents, weighting materials, &c. Usually, starch constitutes the main stiffening agent, with additions of china clay, barium compounds, &c., for weighting purposes, and Turkey red oil, with or without the addition of some vegetable oil or fat, as the softening agent. Magnesium sulphate is also largely used in order to give "body" to the cloth, which it does by virtue of its property of crystallizing in fine felted needle-shaped crystals throughout the mass of the fabric. When starch is used in filling, it is advisable to add some anti-septic, such as zinc chloride, sodium silicofluoride, phenol or salicylic acid, in order to prevent or retard subsequent development of mildew. The impregnation of the pieces with the filling is effected in two ways, viz. either throughout the thickness of the cloth or on one surface only (back starching). When the whole piece is to be impregnated the operation is conducted in a starching mangle, which is similar in construction to an ordinary household mangle, though naturally larger and more elaborate in construction. The pieces run at full width through a trough situated immediately below the bowls and containing the filling (starch paste, &c.), then between the bowls, the pressure ("nip") of which regulates the amount of filling taken up, and thence over a range of steam-heated drying cylinders (see BLEACHING). In case one side only of the goods is to be stiffened—and this is usually necessary in the case of printed goods,—a so-called back-starching mangle is employed.

The construction of the machine varies, but the simplest form consists essentially of a wooden bowl *a* (fig. 1) which runs in the starch paste contained in trough *t*.

The pieces pass from the batch-roller *B*, through scrim rails *S* and over the bowl under tension, touching the surface from which they gather the starch paste. By means of the fixed "doctor" blade *d*, which extends across the piece, the paste is levelled on the surface of the fabric and excess scraped off, falling back into the trough. The goods are then dried with the face side to the cylinders.

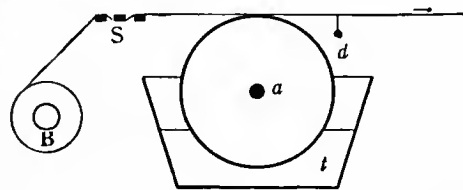

FIG. 1.—Principle of Back-Starching Machine.

Some goods come into the market with no further treatment after starching other than running through a mangle with a little softening and then drying, but in the great majority of cases they are subjected to further operations.

Damping.—When deprived of their natural moisture by drying on the cylinder drying machine, cotton goods are not in a fit condition to undergo the subsequent operations of calendering, beetling, &c., since the fibres in the dry state have lost their plasticity. The pieces are consequently damped to the desired degree, and this is usually effected in a damping machine in passing through which they meet with a fine spray of water.

A simple and effective device for this purpose is shown in section in fig. 2. It consists essentially of a brass roller *r* running in water

contained in a trough or box *t*. Touching the brass roller is a brush roller *b* which revolves at a high speed, thus spraying the water,

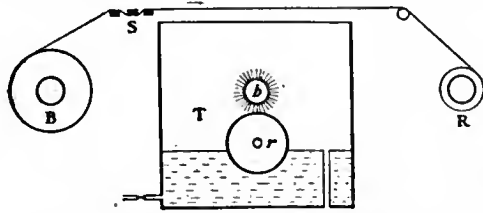

FIG. 2.—Principle of Damping Machine.

over scrimp rails *S*, and batched again on the other side on roller *R*. The level of the water in the trough is kept constant.

Calendering.—The calender may be regarded as an elaboration of the ordinary mangle, from which, however, it differs essentially inasmuch as one or more of the rollers or bowls are made of steel or iron and can be treated either by gas or steam; the other bowls are made of compressed cotton or paper. Three distinct forms of calender are in use, viz. the ordinary calender, the friction calender and the embossing calender.

The number of bowls in an ordinary calender varies between two and six according to the character of the finish for which it is intended. In a modern five-bowl calender the bottom bowl is made of cast iron, the second of compressed cotton or paper, the third of iron being hollow and fitted with steam heating apparatus. The fourth bowl is made of compressed cotton, and the fifth of cast iron. The pieces are simply passed through for "swissing," i.e. for the production of an ordinary plain finish. The same calender may also be used for "chasing," in which two pieces are passed through, face to face, in order to produce an imitation linen finish. Moiré or "watered" effects are produced in a similar way, but these effects are frequently imitated in the embossing calender.

The friction calender, the object of which is to produce a high gloss on the fabric, differs from the ordinary calender inasmuch as one of the bowls is caused to revolve at a greater speed than the others. In an ordinary three-bowl friction calender the bottom bowl is made of cast iron, the middle one of compressed cotton or paper, and the top one (the friction bowl) of highly polished chilled iron. The last-named bowl, which has a greater peripheral speed than the others, is hollow and can be heated either by steam or gas.

The embossing calender is usually constructed of two bowls, one of which is of steel and the other of compressed cotton or paper. The steel roller, which is hollow and can be heated either by steam or gas, is engraved with the pattern which it is desired to impart to the piece. If the pattern is deep, as is the case in the production of book cloths, it is necessary to run the machine empty under pressure until the pattern of the steel bowl has impressed itself into the cotton or paper bowls, but if the effect desired only consists of very fine lines, this is not necessary; for instance, in the production of the Schreiner finish, which is intended to give the pieces (especially after mercerizing) the appearance of silk, the steel roller is engraved with fine diagonal lines which are so close together (about 250 to the in.) as to be undistinguishable by the naked eye.

Beetling is a process by which a peculiar linen-like appearance and a leathery feel or handle are imparted to cotton fabrics, the process being also employed for improving the appearance of linen goods. For the best class of beetle finish, the pieces are first impregnated with sago starch and the other necessary ingredients (softening, &c.) and are dried on cylinders. They are then damped on a water mangle, and beamed on to the heavy iron bowl of the beetling machine.

A beetling machine of the kind, with four sets of "fallers," is shown in fig. 3. The fallers are made of beech wood, are about 8 ft. long, 5½ in. deep and 4 in. wide, and are kept in their vertical position by two pairs of guide rails. Each faller is provided with a tappet or wooden peg driven in at one side, which engages with the teeth or "wipers" of the revolving shaft in the front of the machine. The effect of this mechanism is to lift the faller a distance of about 13 in. and then let it drop on to the cloth wound on the beam. This

lifting and dropping of the fallers on to the beam takes place in rhythmical and rapid succession. To ensure even treatment the beam turns slowly round and also has a to-and-fro movement imparted to it. The treatment may last, according to the finish which it is desired to obtain, from one to sixty hours.

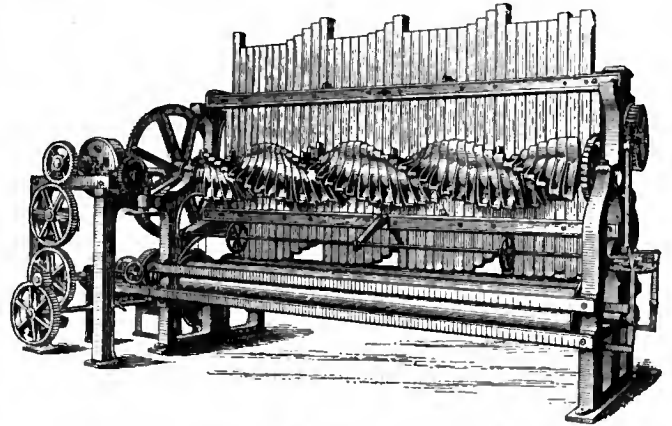

FIG. 3.—Beetling Machine (Edmeston & Sons).

Beetling was originally used for linen goods, but to-day is almost entirely applied to cotton for the production of so-called *linenelles*.

Hot-pressing is used to a limited extent in order to obtain a soft finish on cotton goods, but as this operation is more used for wool, it will be described below.

Raising.—This operation, which was formerly only used for woollen goods (teasing), has come largely into use for cotton pieces, partly in consequence of the introduction of the direct cotton colours by which the cotton is dyed evenly throughout (see DYEING), and partly in consequence of new and improved machinery having been devised for the purpose. Starting with a plain bleached, dyed or printed fabric, the process consists in principle in raising or drawing out the ends of individual fibres from the body of the cloth, so as to produce a nap or soft woolly surface on the face.

This is effected by passing the fabric slowly round a large drum *D*, which is surrounded, as shown in the diagram (fig. 4), by a number of

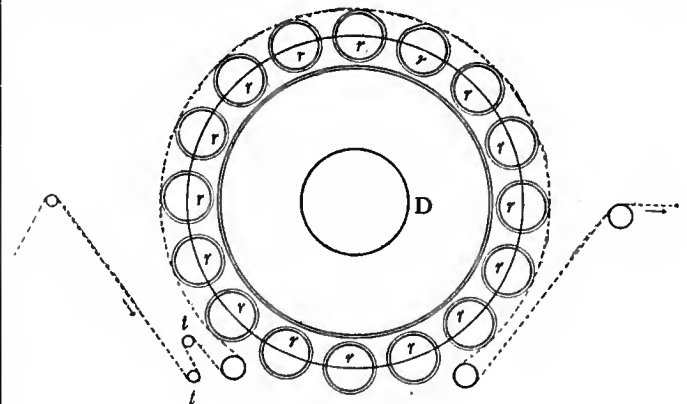

FIG. 4.—Raising.

small cylinders or rollers, *r*, covered with steel wire brushes or "carding," such as is used in carding engines (see COTTON-SPINNING MACHINERY).

The rollers *r*, which are all driven by one and the same belt (not shown in the figure), revolve at a high rate of speed, and can be made to do so either in the same direction as that followed by the piece as it travels through the machine or in the opposite one. In addition to their revolving round their own axes, the raising rollers may be either kept stationary or may be moved round the drum *D* in either direction.

In the more modern machines there are two sets of raising rollers, of which each alternate one is caused to revolve in the direction followed by the piece, while the other is made to revolve in the opposite direction. By passing through an arrangement of this kind several times, or through several such machines in succession, the ends of the fibres are gradually drawn out to the desired extent.

After raising, the pieces are sheared (for better class work) in order to produce greater regularity in the length of the nap. The raised style of finishing is used chiefly for the production of uniformly white or coloured flannelles but is also used for such as are dyed in the yarn, and to a limited extent for printed fabrics.

Woollen and Worsted Pieces.—Although both of these classes of material are made from wool, their treatment in finishing differs so materially that it is necessary to deal with them separately. *Unions* or fabrics consisting of a cotton warp with a worsted weft are in general treated like worsteds.

In the finishing of woollen pieces the most important operation is that of *milling*, which consists in subjecting the pieces to mechanical friction, usually in an alkaline medium (soap or soda) but sometimes in an acid (sulphuric acid) medium, in order to bring about felting and consequent "fulling" of the fabric. This felting of the wool is due to the peculiar structure of the fibre, the scales of which all protrude in one direction, so that the individual fibres can slip past each other in one direction more readily than in the opposite one and thus become more and more interlocked as the milling proceeds. If the pieces contain *burrs* these are usually removed by a process known as "carbonizing," which generally, but not necessarily, precedes the milling. Their removal depends upon the fact that the burrs, which consist in the main of cellulose, are disintegrated at elevated temperatures by dilute mineral acids. The pieces are run through sulphuric acid of from 4° to 6° Tw., squeezed or hydro-extracted, and dried over cylinders and then in stoves. The acid is thus concentrated and attacks the burrs, which fall to dust, while leaving the wool intact. For the removal of the acid the fabric is first washed in water and then in weak soda. Carbonizing is also sometimes used for worsteds.

Milling was formerly all done in milling or fulling stocks (see fig. 5), in which the cloth saturated with a strong solution of soap

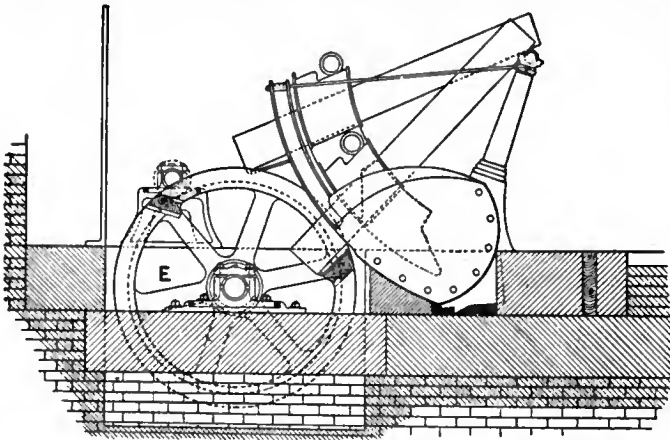

FIG. 5.—Milling Stocks.

(with or without other additions such as stale urine, potash, fuller's earth, &c.) is subjected to the action of heavy wooden hammers, which are raised by the cams attached to the wheel (E) on the revolving shaft, and fall with their own weight on to the bundles of cloth. The shape of the hammer-head causes the cloth to turn slowly in the cavity in which the milling takes place. Occasionally, the cloth is taken out, straightened, washed if necessary, and then returned to the stocks to undergo further treatment, the process being continued until the material is uniformly shrunk or milled to the desired degree.

In the more modern forms of milling machines the principle adopted is to draw the pieces in rope form, saturated with soap solution and sewn together end to end so as to form an endless band, between two or more rollers, on leaving which they are forced down a closed trough ending in an aperture the size of which can be varied, but which in any case is sufficiently small to cause a certain amount of force to be necessary to push the pieces through. A machine of this kind is shown in fig. 6. It is evident that for coloured goods which have to be milled only

such colouring matters must be chosen for dyeing that are absolutely fast to soap.

After the pieces have been milled down to the desired degree, they present an uneven and undesirable appearance on the surface, the ends of many of the fibres which previously projected having been turned and thus become embedded in the body of the cloth. In order to bring these hairs to the surface again, the fabric is subjected to *teasing* or *raising*, an operation identical in principle with one which has already been noticed under the finishing of cotton. In place of the steel wire brushes it is the usual practice to employ teasels for the treatment of woollen goods.

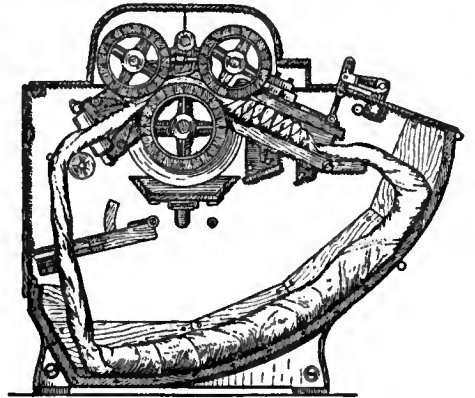

From Ganswindt, *Technologie der Appretur*.

FIG. 6.—Roller Milling Machine.

The teasel (see fig. 7) is the dried head (fruit) of a kind of thistle (*Dipsacus fuliorum*), the horny sharp spikes of which turn downwards at their extremity, and, while possessing the necessary sharpness and strength for raising the fibres, are not sufficiently rigid to cause any material damage to the cloth. For raising, the teasels are fixed in rows on a large revolving drum, and the piece to be treated is drawn lengthways underneath the drum, being guided by rollers or rods so as to just touch the teasels as they sweep past. In the raising of woollen goods it is necessary that the pieces should be damp or moist while undergoing this treatment.

After teasing, the pieces are stretched and dried. At this stage they still have an irregular appearance, for although the raising has brought all the loose ends of the fibres to the surface, these vary considerably in length and thus give rise to an uneven nap.

By the next operation of *shearing* or *cropping*, the long hairs are cut off and a uniform surface is thus obtained. Shearing was in former times done by hand, by means of shears, but is to-day universally effected by means of a cutting device which works on the same principle as an ordinary lawn-mower, in which a number of spiral blades set on the surface of a rapidly revolving roller pass continuously over a straight fixed blade underneath, the roller being set so that the spiral blades just touch the fixed blade. Before the piece comes to the shearing device the nap is raised by means of a rotary brush. Shearing may be effected either transversely, in which case the fixed blade is parallel to the warp, or longitudinally with the fixed blade parallel to the weft. In the first case, the piece being stretched on a table, over which the cutter, carried on rails, travels from selvedge to selvedge. The length of the piece that can be shorn in one operation will naturally depend upon the length of the blade, but in any case the process is necessarily intermittent, many operations being required before the whole piece is shorn. In



From Ganswindt, *Technologie der Appretur*.

FIG. 7.—Teasel used for Raising.

the longitudinal shearing machines the process is continuous, the pieces passing from the beam in the stretched condition over the rotary brush, under the fixed blade, and then being again brushed before being beamed on the other side of the machine. Shearing once is generally insufficient, and for this reason many of the modern machines are constructed with duplicate arrangements so as to effect the shearing twice in the same operation. In the finishing of certain woollen goods the pieces, after having been milled, raised and sheared, go through these operations again in the same sequence.

After these operations the goods are pressed either in the hydraulic press or in the continuous press, and according to the character of the material and the finish desired may or may not be steamed under pressure, all of which operations are described below.

New cloth, as it comes into the hands of the tailor, frequently shows an undesirable gloss or sheen, which is removed before making up by a process known as shrinking, in which the material is simply damped or steamed.

Worsted and Unions.—The pieces are first singed by gas or hot plate (see BLEACHING), and are then usually subjected to a process known as “crabbing,” the object of which is to “set” the wool fibres. If this operation is omitted, especially in the case of unions, the fabric will “cockle,” or assume an uneven surface on being wetted. In crabbing the pieces are drawn at full breadth and under as much tension as they will stand through boiling water, and are wound or beamed on to a roller under the pressure of a superposed heavy iron roller, the operation being conducted two or three times as required. From the crabbing machine the pieces are wound on to a perforated shell or steel cylinder which is closed at one end. The open end is then attached to a steam pipe, and steam, at a pressure of 30 to 45 lb, is allowed to enter until it makes its way through all the layers of cloth to the outside, when the steam is turned off and the whole allowed to cool. Since those layers of the cloth which are nearest the shell are acted upon for a longer period than those at the outside, it is necessary to re-wind and repeat the operation, the outside portions coming this time nearest to the shell. The principle of the process depends upon the fact that at elevated temperatures moist wool becomes plastic, and then easily assumes the shape imparted to it by the great tension under which the pieces are wound. On cooling the shape is retained, and since the temperature at which the pieces were steamed under tension exceeds any to which they are submitted in the subsequent processes, the “setting” of the fibres is permanent. After crabbing, the pieces are washed or “scoured” in soap either on the winch or at full width. In some cases the crabbing precedes the scouring. The goods are then dyed and finished.

The nature of the finishing process will vary considerably according to the special character of the goods under treatment. Thus, for certain classes of goods cold pressing is sufficient, while in other cases the pieces are steamed under pressure in a manner analogous to the treatment after crabbing (“decatizing”). The treatment in most common use for worsteds and unions is hot pressing, which may be effected either in the hydraulic press or in the continuous press, but in most cases in the former.

In pressing in the hydraulic press the pieces are folded down by hand on a table, a piece of press paper (thin hand-made cardboard with a glossed and extremely hard surface) being inserted between each lap. After a certain number of laps, a steel or iron press plate is inserted, and the folding proceeds in this way until the pile is sufficiently high, when it is placed in the press. The press being filled, the hydraulic ram is set in motion until the reading on the gauge shows that the desired amount of pressure has been obtained. The heating of the press plates was formerly done in ovens, previous to their insertion in the piece, but although this practice is still in vogue in rare instances, the heating is now effected either by means of steam which is caused to circulate through the hollow steel plates, or in the more modern forms of presses by means of an electric

current. After the pieces have thus been subjected to the combined effects of heat and pressure for the desired length of time, they are allowed to cool in the press. It is evident that portions of the pieces, viz. the folds, thus escape the finishing process, and for this reason it is necessary to repeat the process, the folds now being made to lie in the middle of the press papers.

The continuous press, which is used for certain classes of worsteds, but more especially for woollen goods, consists in principle of a polished steam-heated steel cylinder against which either one or two steam-heated chilled iron cheeks are set by means of levers and adjusting screws. The pieces to be pressed are drawn slowly between the

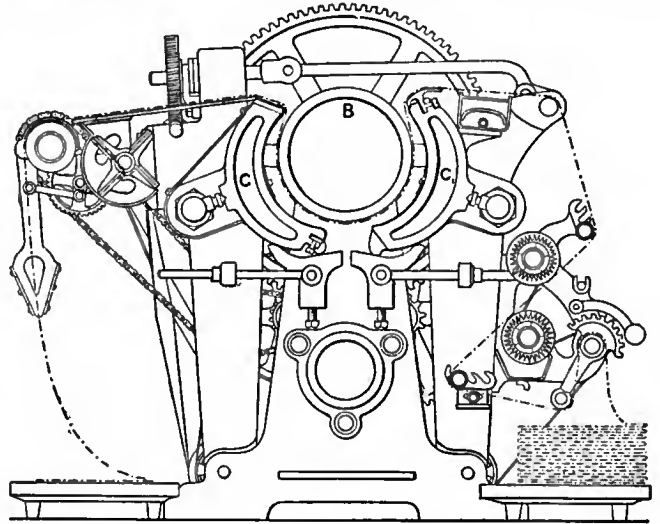

From Ganswindt, *Technologie der Appretur*.

FIG. 8.—Continuous Press.

cheeks and the bowl. A machine of the kind is shown in section in fig. 8. In working, the cheeks C, C, are pressed against the bowl B. The course followed by the cloth to be finished is shown by the dotted line, the finished material being mechanically folded down on the left-hand side of the machine. The pieces thus acquire a certain amount of finish which is, however, not comparable with that produced in the hydraulic press.

Pile Fabrics, such as velvets, velveteens, corduroys, plushes, sealskins, &c., require a special treatment in finishing, and great care must be taken in all operations to prevent the pile being crushed or otherwise damaged. Velveteens and corduroys are singed before boiling or bleaching. Velveteens dyed in black or in dark shades are brushed with an oil colour (e.g. Prussian blue for blacks), and dried over-night in a hot stove in order to give them a characteristic bloom. Regularity in the pile and gloss are obtained by shearing and brushing. Corduroys are stiffened at the back by the application of “bone-size” (practically an impure form of glue) in a machine similar to that used for back-starching. The face of the fabric is waxed with beeswax by passing the piece under a revolving drum, on the surface of which bars of this material are fixed parallel to the axis. The bars just touch the surface of the fabric as it passes through the machine. The gloss is then obtained by brushing with circular brushes which run partly in the direction of the piece and partly diagonally. In the finishing of velvets, shearing and brushing are the most important operations. The same applies to sealskins and other long pile fabrics, but with these an additional operation, viz. that of “batting,” is employed after dyeing and before shearing and brushing, which consists in beating the back of the stretched fabric with sticks in order to shake out the pile and cause it to stand erect.

For the finishing of silk pieces the operations and machinery employed are similar in character to some of those used for cotton and worsteds. Most high-class silks require no further treatment other than simple damping and pressing after they leave the loom. Inferior qualities are frequently filled or back-filled with glue, sugar, gum tragacanth, dextrin, &c., after which they are dried, damped and given a light calender finish. *Moiré*

or watered effects are produced by running two pieces face to face through a calender or by means of an embossing calender. In the latter case the pattern repeats itself. For the production of silk crape the dyed (generally black) piece is impregnated with a solution of shellac in methylated spirit and dried. It is then "goffered," an operation which is practically identical with embossing (see above), and may either be done on an embossing calender or by means of heated brass plates in which the design is engraved to the desired depth and pattern.

The measuring, wrapping, doubling, folding, &c., of piece goods previous to making up are done in the works by specially constructed machinery.

Finishing of Yarn.—The finishing of yarn is not nearly so important as the finishing of textiles in the piece, and it will suffice to draw attention to the main operations. Cotton yarns are frequently "gassed," *i.e.* drawn through a gas flame, in order to burn or singe off the projecting fibres and thus to produce a clean thread which is required for the manufacture of certain classes of fabrics. The most important finishing process for cotton yarn is "mercerizing" (*q.v.*), by means of which a permanent silk-like gloss is obtained. The "polishing" of cotton yarn, by means of which a highly glazed product, similar in appearance to horsehair, is obtained, is effected by impregnating the yarn with a paste consisting essentially of starch, beeswax or paraffin wax and soap, and then subjecting the damp material to the action of revolving brushes until dry. Woollen yarn is not subjected to any treatment, but worsted yarns (especially twofold) have to be "set" before scouring and dyeing in order to prevent curling. This is effected by stretching the yarn tight on a frame, which is immersed in boiling water and then allowing it to cool in this condition.

A peculiar silk-like gloss and feel is sometimes imparted to yarns made from lustre wool by a treatment with a weak solution of chlorine (bleaching powder and hydrochloric acid) followed by a treatment with soap.

Worsted and mohair yarns intended for the manufacture of braids are singed by gas, a process technically known as "Genapping."

Silk yarn is subjected to various mechanical processes before weaving. The most important of these are stretching, shaking, lustreing and glossing. Stretching and shaking are simple operations the nature of which is sufficiently indicated by their names, and by these means the hanks are stretched to their original length and straightened out by hand or on a specially devised machine. In *lustreing*, the yarn is stretched slightly beyond its original length between two polished revolving cylinders (one of which is steam heated) contained in a box or chest into which steam is admitted. In *glossing*, the yarn is twisted tight, first in one direction and then in the other, on a machine, this alternating action being continued until the maximum gloss is obtained.

The so-called "scrooping" process, which gives to silk a peculiar feel and causes it to crackle or crunch when compressed by the hand, is a very simple operation, and consists in treating the yarn after dyeing in a bath of dilute acid (acetic, tartaric or sulphuric) and then drying without washing. Heavily weighted black silks are passed after dyeing through an emulsion of olive oil in soap and dried without washing, in order to give additional lustre to the material or rather to restore some of the lustre which has been lost in weighting. (E. K.)

FINISTÈRE, or FINISTERRE, the most western department of France, formed from part of the old province of Brittany. Pop. (1906) 795,103. Area, 2713 sq. m. It is bounded W. and S. by the Atlantic Ocean, E. by the departments of Côtes-du-Nord and Morbihan, and N. by the English Channel. Two converging chains of hills run from the west towards the east of the department and divide it into three zones conveying the waters in three different directions. North of the Arrée, or more northern of the two chains, the waters of the Douron, Penzé and Flèche flow northward to the sea. The Elorn, however, after a short northerly course, turns westward and empties into the Brest roads. South of the Montagnes Noires, the Odet, Aven, Isole

and Ellé flow southward; while the waters of the Aulne, flowing through a region enclosed by the two chains with a westward declination, discharge into the Brest roads. The rivers are all small, and none of the hills attain a height of 1300 ft. The coast is generally steep and rocky and at some points dangerous, notably off Cape Raz and the Île de Sein; it is indented with numerous bays and inlets, the chief of which—the roadstead of Brest and the Bays of Douarnenez and Audierne—are on the west. The principal harbours are those of Brest, Concarneau, Morlaix, Landerneau, Quimper and Douarnenez. Off the coast lie a number of islands and rocks, the principal of which are Ushant (*q.v.*) N.W. of Cape St Mathieu, and Batz off Roscoff. The climate is temperate and equable, but humid; the prevailing winds are the W., S.W. and N.W. Though more than a third of the department is covered by heath, waste land and forest, it produces oats, wheat, buckwheat, rye and barley in quantities more than sufficient for its population. In the extreme north the neighbourhood of Roscoff, and farther south the borders of the Brest roadstead, are extremely fertile and yield large quantities of asparagus, artichokes and onions, besides melons and other fruits. The cider apple is abundant and furnishes the chief drink of the inhabitants. Hemp and flax are also grown. The farm and dairy produce is plentiful, and great attention is paid to the breeding and feeding of cattle and horses. The production of honey and wax is considerable. The fisheries of the coast, particularly the pilchard fishery, employ a great many hands and render this department an excellent nursery of seamen for the French navy. Coal, though found in Finistère, is not mined; there are quarries of granite, slate, potter's clay, &c. The lead mines of Poullaouen and Huelgoat, which for several centuries yielded a considerable quantity of silver, are no longer worked. The preparation of sardines is carried on on a large scale at several of the coast-towns. The manufactures include linens, woollens, sail-cloth, ropes, agricultural implements, paper, leather, earthenware, soda, soap, candles, and fertilizers and chemicals derived from seaweed. Brest has important foundries and engineering works; and shipbuilding is carried on there and at other seaports. Brest and Morlaix are the most important commercial ports. Trade is in fish, vegetables and fruit. Coal is the chief import. The department is served by the Orléans and Western railways. The canal from Nantes to Brest has 51 m. of its length in the department. The Aulne is navigable for 17 m., and many of the smaller rivers for short distances.

Finistère is divided into the arrondissements of Quimperlé, Brest, Châteaulin, Morlaix and Quimper (43 cantons, 294 communes), the town of Quimper being the capital of the department and the seat of a bishopric. The department belongs to the region of the XI. army corps and to the archiepiscopal province and académic (educational division) of Rennes, where its court of appeal is also situated.

The more important places are Quimper, Brest, Morlaix, Quimperlé, St Pol-de-Léon, Douarnenez, Concarneau, Roscoff, Penmarc'h and Pont-l'Abbé. Finistère abounds in menhirs and other megalithic monuments, of which those of Penmarc'h, Plouarzal and Crozon are noted. The two religious structures characteristic of Brittany—calvaries and charnel-houses—are frequently met with. The calvaries of Plougastel-Daoulas, Pleyben, St Thégonnec, Lampaul-Guimiliau, which date from the 17th century, and that of Guimiliau (16th century), and the charnel-houses of Sizun and St Thégonnec (16th century) and of Guimiliau (17th century) may be instanced as the most remarkable. Daoulas has the remains of a fine church and cloister in the Romanesque style. The chapel of St Herbot (16th century) near Loqueffret, the churches of St Jean-du-Doigt and Locronan, which belong to the 15th and 16th centuries, those of Ploaré, Roscoff, Penmarc'h and Pleyben of the 16th century, that of Le Folgoët (14th and 16th centuries), and the huge château of Kerjean (16th century) are of architectural interest. Religious festivals, and processions known as "pardons," are held in many places, notably at Locronan, St Jean-du-Doigt, St Herbot and Le Faou.

FINLAND (Finnish, *Suomi* or *Suomenmaa*), a grand-duchy governed subject to its own constitution by the emperor of Russia as grand-duke of Finland. It is situated between the gulfs of Bothnia and Finland, and includes, moreover, a large territory in Lapland. It touches at its south-eastern extremity the government of St Petersburg, includes the northern half of Lake Ladoga, and is separated from the Russian governments of Arkhangelsk and Olonets by a sinuous line which follows, roughly speaking, the water-parting between the rivers flowing into the Baltic Sea and the White Sea. In the north of the Gulf of Bothnia it is separated from Sweden and Norway by a broken line which takes the course of the valley of the Torneå river up to its sources, thus falling only 21 m. short of reaching the head of Norwegian Lyngen-fjord; then it runs south-east and north-east down the Tana and Pasis-joki, but does not reach the Arctic Ocean, and 13 m. from the Varanger-fjord it turns southwards. Finland includes in the south-west the Åland archipelago—its frontier approaching within 8 m. from the Swedish coast—as well as the islands of the Gulf of Finland, Hogland, Tytärs, &c. Its utmost limits are: 59° 48'—70° 6' N., and 19° 2'—32° 50' E. The area of Finland, in square miles, is as follows (*Atlas de Finlande*, 1899):—

Government.	Continent.	Islands in Lakes.	Islands in Seas.	Lakes.	Total.
Nyland	4,062	24	210	286	4,582
Åbo-Björneborg	7,594	8	1331	400	9,333
Tavastehus	6,837	97	..	1,400	8,334
Viborg	11,630	362	130	4,502	16,624
St Michel	5,652	1018	..	2,149	8,819
Kuopio	13,160	643	..	2,696	16,499
Vasa	14,527	62	203	1,313	16,105
Uleåborg	60,348	171	94	3,344	63,957
Total	123,810	2385	1968	16,090	144,253

for internal navigation, while the connecting streams supply an enormous amount of motive-power. The chief lakes are: Lake Ladoga, of which the northern half belongs to Finland; Saima (three and a half times larger than Lake Lemán), whose outlet, the Vuoksen, flows into Lake Ladoga, forming the mighty Imatra rapids, while the lake itself is connected by means of a sluiced canal with the Gulf of Finland; the basins of Pyhä-selkä, Ori-vesi and Piellis-järvi; Päjäne, surrounded by hundreds of smaller lakes, and the waters of which are discharged into the lower gulf through the Kymmene river; Näsi-järvi and Pyhä-järvi, whose outflow is the Kumo-elf, flowing into the Gulf of Bothnia; Uleå-tråsk, discharged by the Uleå into the same gulf; and Enare, belonging to the basin of the Arctic Ocean. Two large rivers, Kemi and Torneå, enter the head of the Gulf of Bothnia, while the Uleå is now navigable throughout, owing to improvements in its channel.

Geology.—Cambrian, Silurian, Devonian and Carboniferous deposits are found on the coasts of the Gulf of Finland and Lake Ladoga, and also along the coasts of the Arctic Ocean (probably Devonian), and in the Kjölen. Eruptive rocks of Palaeozoic age are met with in the Kola peninsula (nepheline-syenites) and at Kuusamo (syenite). The remainder of Finland is built up of the oldest known crystalline rocks belonging to the Archaean or Algonkian period. The most ancient of these seem to be the granites of East Finland. The denudation and destruction of the granites gave rise to the *Ladoga schists* and various deposits of the same period, which were subsequently strongly folded. Then the country came once more under the sea, and the debris of the previous formations, mixed with fragments from the volcanoes then situated in West Finland, formed the so-called *Bothnian series*. New masses of granites protruded next from underneath, and the Bothnian deposits underwent foldings in their turn, while denudation was again at work on a grand scale. A new series of *Jatvian deposits* was formed and a new system of foldings followed; but these were the last in this part of the globe. The *Jotnian series*, which were formed next, remain still undisturbed. It is to this series that the well-known Rapakivi granite of Åland, Nystad and Viborg belongs. No marine deposits younger than those just mentioned—all belonging to a pre-Cambrian epoch—are found in the central portion of Finland; and the greater part of the country has probably been dry land since

Palaeozoic times. The whole of Finland is covered with Glacial and post-Glacial deposits. The former of these, representing the bottom-moraine of the ice-sheet, are covered with Glacial and post-Glacial clays (partly of lacustrine and partly of marine origin) only in the peripheral coast-region—or in separate areas in the interior depressions. Some Finnish geologists—Sederholm for one—consider it probable that during the Glacial period an Arctic sea (*Yoldia* sea) covered all southern Finland and also Scania (Skåne) in Sweden, thus connecting the Atlantic Ocean with the Baltic and the White Sea by a broad channel; but no fossils from that sea have been found anywhere in Finland. Conclusive proofs, however, of a later submergence under a post-Glacial Littorina sea (containing shells now living in the Baltic) are found up to 150 ft. along the Gulf of Finland, and up to 260, or perhaps 330 ft., in Osterbotten. Traces of a large inner post-Glacial lake, similar to Lake Agassiz of North America, have been discovered. The country is still continuing to rise, but at an unequal rate; of nearly 3·3 ft. in a century in the Gulf of Bothnia (Kvarken), from 1·4 to 2 ft. in the south, and nearly zero in the Baltic provinces.

Climate.—Owing to the prevalence of moist west and south-west winds the climate of Finland is less severe than it is farther east in corresponding latitudes. The country lies thus between the annual isotherms of 41° and 28° Fahr., which run in a W.N.W.—E.S.E. direction. In January the average monthly temperature varies from 9° Fahr. about Lake Enare to 30° along the south coast; while in July the difference between the monthly averages is only eight degrees, being 53° in the north and 61° in the south-east. Everywhere, and especially in the interior, the winter lasts very long, and early frosts (June 12-14 in 1892) often destroy the crops. The amount of rain and snow is from 25½ in. along the south coast to 13·8 in. in the interior of southern Finland.

Flora, Forests, Fauna.—The flora of Finland has been most minutely explored, especially in the south, and the Finnish botanists were enabled to divide the country into twenty-eight different provinces, giving the numbers of phanerogam species for each province. These numbers vary from 318 to 400 species in Lapland, from 508 to 651 in Karelia, and attain 752 species for Finland proper; while the total for all Finland attains 1132 species. Alpine plants are not met with in Finland proper, but are represented by from 32 to 64 species in the Kola peninsula. The chief forest trees of Finland are the Scotch fir (*Pinus sylvestris*, L.), the fir (*Picea excelsa*, Link.); two species of birch (*B. verrucosa*, Ehrh., and *B. odorata*, Bechst.), as well as the birch-bush (*B. nana*); two species of *Ailnus* (*glutinosa* and *incana*); the oak (*Q. pedunculata*, Ehrh.), which grows only on the south coast; the poplar (*Populus tremula*); and the Siberian larch, introduced in culture in the 18th century. Over 6,000,000 trees are cut every year to be floated to thirty large saw-mills. and

Orography.—A line drawn from the head of the Gulf of Bothnia to the eastern coast of Lake Ladoga divides Finland into two distinct parts, the lake region and the nearly uninhabited hilly tracts belonging to the Kjölen mountains, to the plateau of the Kola peninsula, and to the slopes of the plateau which separates Finland proper from the White Sea. At the head-waters of the Torneå, Finland penetrates as a narrow strip into the heart of the highlands of Kjölen (the Keel), where the Haldefjäll (Lappish, Halditjokko) reaches 4115 ft. above the sea, and is surrounded by other *fjälls*, or flat-topped summits, of from 3300 to 3750 ft. of altitude. Extensive plateaus (1500-1750 ft.), into which Lake Enare, or Inari, and the valleys of its tributaries are deeply sunk, and which take the character of a mountain region in the Saariselkä (highest summit, 2360 ft.), occupy the remainder of Lapland. Along the eastern border the dreary plateaus of Olonets reach on Finnish territory altitudes of from 700 to 1000 ft. Quite different is the character of the pentagonal space comprised between the Gulfs of Bothnia and Finland, Lake Ladoga, and the above-mentioned line traced through the lakes Uleå and Piellis. The meridional ridges which formerly used to be traced here along the main water-partings do not exist in reality, and the country appears on the hypsometrical map in the *Atlas de Finlande* as a plateau of 350 ft. of average altitude, covered with countless lakes, lying at altitudes of from 250 to 300 ft. The three main lake-basins of Näsi-järvi, Päjäne and Saima are separated by low and flat hills only; but one sees distinctly appearing on the map a line of flat elevations running south-west to north-east along the north-west border of the lake regions from Lauhanvuori to Kajana, and reaching from 650 to 825 ft. of altitude. A regular gentle slope leads from these hills to the Gulf of Bothnia (Osterbotten), forming vast prairie tracts in its lower parts.

A notable feature of Finland are the *åsar* or narrow ridges of morainic deposits, more or less reassorted on their surfaces. Some of them are relics of the longitudinal moraines of the ice-sheet, and they run north-west to south-east, parallel to the striation of the rocks and to the countless parallel troughs excavated by the ice in the hard rocks in the same direction; while the *Lojo ås*, which runs from Hangöud to Vesi-järvi, and is continued farther east under the name of Salpauselliä, parallel to the shore of the Gulf of Finland, are remainders of the frontal moraines, formed at a period when the ice-sheet remained for some time stationary during its retreat. As a rule these forest-clothed *åsar* rise from 30 to 60 and occasionally 120 ft. above the level of the surrounding country, largely adding to the already great picturesqueness of the lake region; railways are traced in preference along them.

Lakes and Rivers.—A labyrinth of lakes, covering 11% of the aggregate territory, and connected by short and rapid streams (*fjården*), covers the surface of South Finland, offering great facilities

about 1,000,000 to be transformed into paper pulp. The total export of timber was valued in 1897 at 82,160,000 marks. It is estimated, however, that the domestic use of wood (especially for fuel) represents nearly five times as many cubic feet as the wood used for export in different shapes. The total area under forests is estimated at 63,050,000 acres, of which 34,662,000 acres belong to the state. The fauna has been explored in great detail both as regards the vertebrates and the invertebrates, and specialists will find the necessary bibliographical indications in *Travaux géographiques en Finlande*, published for the London Geographical Congress of 1895.

Population.—The population of Finland, which was 429,912 in 1751, 832,659 in 1800, 1,636,915 in 1850, and 2,520,437 in 1895, was 2,712,562 in 1904, of whom 1,370,480 were women and 1,342,082 men. Of these only 341,602 lived in towns, the remainder in the country districts. The distribution of population in various provinces was as follows:—

1904.	Population.	Density per sq. kilometre.
Åbo-Björneborg	447,098	20.3
Kuopio	313,951	8.9
Nyland	297,813	29.3
St Michel	189,360	11.1
Tavastehus	301,272	17.7
Uleåborg	280,899	1.9
Viborg	421,610	14.6
Vasa	460,460	12.5
Total	2,712,562	8.6

The number of births in 1904 was 90,253 and the deaths 50,227, showing an excess of births over deaths of 40,026. Emigration was estimated at about three thousand every year before 1898, but it largely increased then owing to Russian encroachments on Finnish autonomy. In 1899 the emigrants numbered 12,357; 10,642 in 1900; 12,659 in 1901; and 10,952 in 1904.

The bulk of the population are Finns (2,352,990 in 1904) and Swedes (349,733). Of Russians there were only 5939, chiefly in the provinces of Viborg and Nyland. Both Finns and Swedes belong to the Lutheran faith, there being only 46,466 members of the Greek Orthodox Church and 755 Roman Catholics.

The leading cities of Finland are: Helsingfors, capital of the grand-duchy and of the province (*län*) of Nyland, principal seaport (111,654 inhabitants); Åbo, capital of the Åbo-Björneborg province and ancient capital of Finland (42,639); Tammerfors, the leading manufacturing town of the grand-duchy (40,261); Viborg, chief town of province of same name, important seaport (34,672); Uleåborg, capital of province (17,737); Vasa, or Nikolaistad, capital of Vasa län (18,028); Björneborg (16,053); Kuopio, capital of province (13,519); and Tavastehus, capital of province of the same name (5545).

Industries.—Agriculture gives occupation to the large majority of the population, but of late the increase of manufactures has been marked. Dairy-farming is also on the increase, and the foreign exports of butter rose from 1930 cwt. in 1900 to 3130 cwt. in 1905. Measures have been taken since 1892 for the improvement of agriculture, and the state keeps twenty-six agronomists and instructors for that purpose. There are two high schools, one experimental station, twenty-two middle schools and forty-eight lower schools of agriculture, besides ten horticultural schools. Agricultural societies exist in each province.

Fishing is an important item of income. The value of exports of fish, &c., was £140,000 in 1904, but fish was also imported to the value of £61,300. The manufacturing industries (wood-products, metallurgy, machinery, textiles, paper and leather) are of modern development, but the aggregate production approaches one and a half millions sterling in value.

Some gold is obtained in Lapland on the Ivalajoki, but the output, which amounted in 1871 to 56,692 grammes, had fallen in 1904 to 1951 grammes. There is also a small output of silver, copper and iron. The last is obtained partly from mines, but chiefly from the lakes. In 1904 22,050 tons of cast iron were obtained. The textile industries are making rapid progress, and their produce, notwithstanding the high duties, is exported to Russia. The fabrication of paper out of wood is also rapidly growing. As to the timber trade, there are upwards of 500 saw-mills, employing 21,000 men, and with an output valued at over £3,000,000 annually.

Communications.—The roads, attaining an aggregate length of 27,500 m., are kept as a rule in very good order. The first railway was opened in 1862. and the next, from Helsingfors to St Petersburg, in 1870 (cost only £4520 per mile). Railways of a lighter type began to be built since 1877, and now Finland has about 2100 m. of railway, mostly belonging to the state. The gross income from the state railways is 26,607,622, and the net income 4,684,856 marks. Finland has an extensive and well-kept system of canals, of which the sluiced canal connecting Lake Saima with the Gulf of Finland is the chief one. It permits ships navigating the Baltic to penetrate 270 m. inland, and is passed every year by from 4980 to 5200 vessels. Considerable works have also been made to connect the different

lakes and lake-basins for inland navigation, a sum of £1,000,000 having been spent for that purpose.

The telegraphs chiefly belong to Russia. Telephones have an enormous extension both in the towns and between the different towns of southern Finland; the cost of the yearly subscription varies from 40 to 60 marks,¹ and is only 10 marks in the smaller towns.

Commerce.—The foreign trade of Finland increases steadily, and reached in 1904 the following values:—

	From or to Russia.	From or to other Countries.	Totals.
Imports	£4,036,000	£6,488,000	£10,524,000
Exports	2,332,000	6,292,000	8,624,000

The chief trade of Finland is with Russia, and next with Great Britain, Germany, Denmark, France and Sweden. The main imports are: cereals and flour (to an annual value exceeding £3,000,000), metals, machinery, textile materials and textile products. The chief articles of export are: timber and wood articles (£5,250,000), paper and paper pulp, some tissues, metallic goods, leather, &c. The chief ports are Helsingfors, Åbo, Viborg, Hangö and Vasa.

Education.—Great strides have been made since 1866, when a new education law was passed. Rudimentary teaching in reading, occasionally writing, and the first principles of Lutheran faith are given in the maternal house, or in "maternal schools," or by ambulatory schools under the control of the clergy, who make the necessary examination in the houses of every parish. All education above that level is in the hands of the educational department and school boards elected in each parish, each rural parish being bound (since 1898) to be divided into a proper number of school districts and to have a school in each of them, the state contributing to these expenses 800 marks a year for each male and 600 marks for each female teacher, or 25% of the total cost in urban communes. Secondary education, formerly instituted on two separate lines, classical and scientific, has been reformed so as to give more prominence to scientific education, even in the classical (linguistic) lycées or gymnasia. For higher education there is the university of Helsingfors (formerly the Åbo Academy), which in 1906 had 1921 students (328 women) and 141 professors and docents. Besides the Helsingfors polytechnic there are a number of higher and lower technical, commercial and navigation schools. Finland has several scientific societies enjoying a world-wide reputation, as the Finnish Scientific Society, the Society for the Flora and Fauna of Finland, several medical societies, two societies of literature, the Finno-Ugric Society, the Historical and Archaeological Societies, one juridical, one technical and two geographical societies. All of these, as also the Finnish Geological Survey, the Forestry Administration, &c., issue publications well known to the scientific world. The numerous local branches of the Friends of the Folk-School and the Society for Popular Education display great activity, the former by aiding the smaller communes in establishing schools, and the latter in publishing popular works, starting their own schools as well as free libraries (in nearly every commune), and organizing lectures for the people. The university students take a lively part in this work.

Government and Administration.—From the time of its union with Russia at the Diet of Borgå in 1809 till the events of 1899 (see *History*) Finland was practically a separate state, the emperor of Russia as grand-duke governing by means of a nominated senate and a diet elected on a very narrow franchise, and meeting at distant and irregular intervals. This diet was on the old Swedish model, consisting of representatives of the four estates—nobility, clergy, burghers and peasants—sitting and voting in separate "Houses." The government of the country was practically carried on by the senate, which communicated with St Petersburg through a Finnish secretary attached to the Russian government. War and foreign affairs were entirely in the hands of Russia, and a Russian governor had his residence in Helsingfors. The senate also controlled the administration of the law. The constitutional conflict of 1899–1905 brought about something like a revolution in Finland. For some years the country was subject to a practically arbitrary form of government, but the disasters of the Russo-Japanese War and the growing anarchy in Russia resulted in 1905 in a complete and peaceful victory for the defenders of the Finnish constitution. As a Finnish writer puts it: "just as the calamities which had befallen Finland came from Russia, so was her deliverance to come from Russia." The *status quo ante* was restored, the diet met in extraordinary session, and proceeded to the entire re-casting of the Finnish government. Freedom of the press was voted, and the diet next proceeded to reform its own constitution.

¹ The Finnish mark, *markka*, of 100 *penni*, equals about 9½d.

Far-reaching changes were voted. The new diet, instead of being composed of four estates sitting separately, consists of a single chamber of 200 members elected directly by universal suffrage, women being eligible. By the new constitution the grand-duchy was to be divided into not less than twelve and not more than eighteen constituencies, electing members in proportion to population. A scheme of "proportional representation," the votes being counted in accordance with the system invented by G. M. d'Hondt, a Belgian, was also adopted. The executive was to consist of a minister-secretary of state and of the members of the senate, who were entitled to attend and address the diet and who might be the subject of interpellations. The members of the senate were made responsible to the diet as well as to the emperor-grand-duke for their acts. The diet has power to consider and decide upon measures proposed by the government. After a measure has been approved by the diet it is the duty of the senate to report upon it to the sovereign. But the senate is not obliged to accept the decision of the majority of the diet, nor, apparently, is the sovereign bound to accept the advice of the senate. The first elections, April 1907, resulted in the election to the diet of about 40% representatives of the Social Democratic party, and nineteen women members. The budget of Finland in 1905 was £4,273,970 of "ordinary" revenue. The "ordinary" expenditure was £3,595,300. The public debt amounted at the end of 1905 to £5,611,170.

History.—It was probably at the end of the 7th or the beginning of the 8th century that the Finns took possession of what is now Finland, though it was only when Christianity was introduced, about 1157, that they were brought into contact with civilized Europe. They probably found the Lapps in possession of the country. The early Finlanders do not seem to have had any governmental organization, but to have lived in separate communities and villages independent of each other. Their mythology consisted in the deification of the forces of nature, as "Ukko," the god of the air, "Tapio," god of the forests, "Ahti," the god of water, &c. These early Finlanders seem to have been both brave and troublesome to their neighbours, and their repeated attacks on the coast of Sweden drew the attention of the kings of that country. King Eric IX. (St Eric), accompanied by the bishop of Upsala, Henry (an Englishman, it is said), and at the head of a considerable army, invaded the country in 1157, when the people were conquered and baptized. King Eric left Bishop Henry with his priests and some soldiers behind to confirm the conquest and complete the conversion. After a time he was killed, canonized, and as St Henry became the patron saint of Finland. As Sweden had to attend to her own affairs, Finland was gradually reverting to independence and paganism, when in 1209 another bishop and missionary, Thomas (also an Englishman), arrived and recommenced the work of St Henry. Bishop Thomas nearly succeeded in detaching Finland from Sweden, and forming it into a province subject only to the pope. The famous Birger Jarl undertook a crusade in Finland in 1249, compelling the Tavastians, one of the subdivisions of the Finlanders proper, to accept Christianity, and building a castle at Tavestehus. It was Torkel Knutson who conquered and connected the Karelian Finlanders in 1293, and built the strong castle of Viborg. Almost continuous wars between Russia and Sweden were the result of the conquest of Finland by the latter. In 1323 it was settled that the river Rajajoki should be the boundary between Russia and the Swedish province. After the final conquest of the country by the Swedes, they spread among the Finlanders their civilization, gave them laws, accorded them the same civil rights as belonged to themselves, and introduced agriculture and other beneficial arts. The Reformed religion was introduced into Finland by Gustavus Vasa about 1528, and King John III. raised the country to the dignity of a grand-duchy. It continued to suffer, sometimes deplorably, in most of the wars waged by Sweden, especially with Russia and Denmark. His predecessor having created an order of nobility,—counts, barons and nobles, Gustavus Adolphus in the beginning of the 17th century established the diet of Finland, composed of the four orders of

the nobility, clergy, burghers and peasants. Gustavus and his successor did much for Finland by founding schools and gymnasia, building churches, encouraging learning and introducing printing. During the reign of Charles XI. (1692-1696) the country suffered terribly from famine and pestilence; in the diocese of Åbo alone 60,000 persons died in less than nine months. Finland has been visited at different periods since by these scourges; so late as 1848 whole villages were starved during a dreadful famine. Peter the Great cast an envious eye on Finland and tried to wrest it from Sweden; in 1710 he managed to obtain possession of the towns of Kexholm and Villmanstrand; and by 1716 all the country was in his power. Meantime the sufferings of the people had been great; thousands perished in the wars of Charles XII. By the peace of Nystad in 1721 the province of Viborg, the eastern division of Finland, was finally ceded to Russia. But the country had been laid very low by war, pestilence and famine, though it recovered itself with wonderful rapidity. In 1741 the Swedes made an effort to recover the ceded province, but through wretched management suffered disaster, and were compelled to capitulate in August 1742, ceding by the peace of Åbo, next year, the towns of Villmanstrand and Fredrikshamn. Nothing remarkable seems to have occurred till 1788, under Gustavus III., who began to reign in 1771, and who confirmed to Finland those "fundamental laws" which they have succeeded in maintaining against kings and tsars for over two centuries. The country was divided into six governments, a second superior court of justice was founded at Vasa, many new towns were built, commerce flourished, and science and art were encouraged. Latin disappeared as the academic language, and Swedish was adopted. In 1788 war again broke out between Sweden and Russia, and was carried on for two years without much glory or gain to either party, the main aim of Gustavus being to recover the lost Finnish province. In 1808, under Gustavus IV., peace was again broken between the two countries, and the war ended by the cession in 1809 of the whole of Finland and the Åland Islands to Russia. Finland, however, did not enter Russia as a conquered province, but, thanks to the bravery of her people after they had been abandoned by an incompetent monarch and treacherous generals, and not less to the wisdom and generosity of the emperor Alexander I. of Russia, she maintained her free constitution and fundamental laws, and became a semi-independent grand-duchy with the emperor as grand-duke. The estates were summoned to a free diet at Borgå and accepted Alexander as grand-duke of Finland, he on his part solemnly recognizing the Finnish constitution and undertaking to preserve the religion, laws and liberties of the country. A senate was created and a governor-general named. The province of Viborg was reunited to Finland in 1811, and Åbo remained the capital of the country till 1821, when the civil and military authorities were removed to Helsingfors, and the university in 1827. The diet, which had not met for 56 years, was convoked by Alexander II. at Helsingfors in 1863. Under Alexander II. Finland was on the whole prosperous and progressive, and his statue in the great square in front of the cathedral and the senate house in Helsingfors testifies to the regard in which his memory is cherished by his Finnish subjects. Unfortunately his successor soon fell under the influence of the reactionary party which had begun to assert itself in Russia even before the assassination of Alexander II. One of Alexander III.'s first acts was to confirm "the constitution which was granted to the grand-duchy of Finland by His Majesty the emperor Alexander Pavlovich of most glorious memory, and developed with the consent of the estates of Finland by our dearly beloved father of blessed memory the emperor Alexander Nicolaievich." But the Slavophil movement, with its motto, "one law, one church, one tongue," acquired great influence in official circles, and its aim was, in defiance of the pledges of successive tsars, to subject Finland to Orthodoxy and autocracy. It is unnecessary to follow in detail the seven years' struggle between the Russian bureaucracy and the defenders of the Finnish constitution. Politics in Finland were complicated by the rivalry between the Swedish party, which

had hitherto been dominant in Finland, and the Finnish "nationalist" party which, during the latter half of the 19th century, had been determinedly asserting itself linguistically and politically. With some exceptions, however, the whole country united in defence of its constitution; "Fennoman" and "Svecoman," recognizing that their common liberties were at stake, suspended their feud for a season. With the accession of Nicholas II. (see RUSSIA) the constitutional conflict became acute, and the "February manifesto" (February 15th, 1899) virtually abrogated the legislative power of the Finnish diet. A new military law, practically amalgamating the Finnish with the Russian forces, followed in July 1901; Russian officials and the Russian language were forced on Finland wherever possible, and in April 1903 the Russian governor, General Bobrikov, was invested with practically dictatorial powers. The country was flooded with spies, and a special Russian police force was created, the expenses being charged to the Finnish treasury. The Russian system was now in full swing; domiciliary visits, illegal arrests and banishments, and the suppression of newspapers, were the order of the day. To all this the people of Finland opposed a dogged and determined resistance, which culminated in November 1905 in a "national strike." The strike was universal, all classes joining in the movement, and it spread to all the industrial centres and even to the rural districts. The railway, steamship, telephone and postal services were practically suspended. Helsingfors was without tramcars, cabs, gas and electricity; no shops except provision shops were open; public departments, schools and restaurants were closed. After six days the unconstitutional government—already much shaken by events in Russia and Manchuria—capitulated. In an imperial manifesto dated the 7th of November 1905 the demands of Finland were granted, and the *status quo ante* 1899 was restored.

But the reform did not rest here. The old Finnish constitution, although precious to those whose only protection it was, was antiquated and not very efficient instrument of government. Popular feeling had been excited by the political conflict, advanced tendencies had declared themselves, and when the new diet met it proceeded as explained above to remodel the constitution, on the basis of universal suffrage, with freedom of the press, speech, meeting and association.

In 1908-10 friction with Russia was again renewed. The imperial government insisted that the decision in all Finnish questions affecting the Empire must rest with them; and a renewed attempt was made to curtail the powers of the Finnish Diet.

Ethnology.—The term Finn has a wider application than Finland, being, with its adjective Finnic or Finno-Ugric (*q.v.*) or Ugro-Finnic, the collective name of the westernmost branch of the Ural-Altaic family, dispersed throughout Finland, Lapland, the Baltic provinces (Esthonia, Livonia, Curland), parts of Russia proper (south of Lake Onega), both banks of middle Volga, Perm, Vologda, West Siberia (between the Ural Mountains and the Yenissei) and Hungary.

Originally nomads (hunters and fishers), all the Finnic people except the Lapps and Ostyaks have long yielded to the influence of civilization, and now everywhere lead settled lives as herdsmen, agriculturists, traders, &c. Physically the Finns (here to be distinguished from the Swedish-speaking population, who retain their Scandinavian qualities) are a strong, hardy race, of low stature, with almost round head, low forehead, flat features, prominent cheek bones, eyes mostly grey and oblique (inclining inwards), short and flat nose, protruding mouth, thick lips, neck very full and strong, so that the occiput seems flat and almost in a straight line with the nape; beard weak and sparse, hair no doubt originally black, but, owing to mixture with other races, now brown, red and even fair; complexion also somewhat brown. The Finns are morally upright, hospitable, faithful and submissive, with a keen sense of personal freedom and independence, but also somewhat stolid, revengeful and indolent. Many of these physical and moral characteristics they have in common with the so-called "Mongolian" race, to which they are no doubt ethnically, if not also linguistically, related.

Considerable researches have been accomplished since about 1850 in the ethnology and archaeology of Finland, on a scale which has no parallel in any other country. The study of the prehistoric population of Finland—Neolithic (no Palaeolithic finds have yet been made)—of the Age of Bronze and the Iron Age has been carried on with great zeal. At the same time the folklore, Finnish and partly Swedish, has been worked out with wonderful completeness (see *L'Œuvre demi-séculaire de la Société de Littérature finnoise et le mouvement national finnois*, by Dr E. G. Palmén, Helsingfors, 1882, and K. Krohn's report to the London Folklore Congress of 1891). The work that was begun by Porthan, Z. Topelius, and especially E. Lönnrot (1802-1884), for collecting the popular poetry of the Finns, was continued by Castrén (1813-1852), Europæus (1820-1884), and V. Porkka (1854-1889), who extended their researches to the Finns settled in other parts of the Russian empire, and collected a considerable number of variants of the Kalewala and other popular poetry and songs. In order to study the different eastern kinsfolk of the Finns, Sjögren (1792-1855) extended his journeys to North Russia, and Castrén to West and East Siberia (*Nordische Reisen und Forschungen*), and collected the materials which permitted himself and Schiefner to publish grammatical works relative to the Finnish, Lappish, Zyrian, Tcheremiss, Ostiak, Samoyede, Tungus, Buryat, Karagas, Yenisei-Ostiak and Kott languages. Ahlqvist (1826-1889), and a phalanx of linguists, continued their work among the Vogules, the Mordves and the Obi-Ugrians. And finally, the researches of Aspelin (*Foundations of Finno-Ugrian Archaeology*, in Finnish, and *Atlas of Antiquities*) led the Finnish ethnologists to direct more and more their attention to the basin of the Yenisei and the Upper Selenga. A series of expeditions (of Aspelin, Snellman and Heikel) were consequently directed to those regions, especially since the discovery by Yadrintseff of the remarkable Orkhon inscriptions (see TURKS, p. 473), which finally enabled the Danish linguist, V. Thomsen, to decipher these inscriptions, and to discover that they belonged to the Turkish Iron Age. (See *Inscriptions de l'Yénissei recueillies et publiées par la Société Finl. d'Archéologie*, 1889, and *Inscriptions de l'Orkhon*, 1892.)

AUTHORITIES.—The general history of Finland is fully treated by Yrjö Koskinen (1869-1873) and M. G. Schybergson (1887-1889). Both works have been translated into German. The constitutional conflict gave rise to a host of books and pamphlets in various languages. Mechelin, Danielson and Hermanson were the leading writers on the Finnish side, and M. Ordén on the Russian. Most of the political documents have been published and translated. A finely illustrated book, *Finland in the Nineteenth Century*, by various Finnish writers, gives an excellent account of the country; also Reuter's *Finlandia*, a very complete work with an exhaustive bibliography. The constitutional question was fully discussed in English in *Finland and the Tsars*, by J. R. Fisher (2nd ed., 1900). The *Atlas de Finlande*, published in 1899 by the Geographical Society of Finland, is a remarkably well executed and complete work. The *Statistical Annual for Finland—Statistisk Årsbok för Finland*—published annually by the Central Statistical Bureau in Helsingfors, gives the necessary figures. (P. A. K.; J. S. K.; J. R. F.)*

Finnish Literature.

The earliest writer in the Finnish vernacular was Michael Agricola (1506-1557), who published an *A B C Book* in 1544, and, as bishop of Abo, a number of religious and educational works. A version of the New Testament in Finnish was printed by Agricola in 1548, and some books of the Old Testament in 1552. A complete Finnish Bible was published at Stockholm in 1642. The dominion of the Swedes was very unfavourable to the development of anything like a Finnish literature, the poets of Finland preferring to write in Swedish and so secure a wider audience. It was not until, in 1835, the national epos of Finland, the *Kalewala* (*q.v.*), was introduced to readers by the exertions of Elias Lönnrot (*q.v.*), that the Finnish language was used for literary composition. Lönnrot also collected and edited the works of the peasant-poets P. Korhonen (1775-1840) and Pentti Lyytinen, with an anthology containing the improvisations of eighteen other rustic bards. During the last quarter of the 19th century there was an ever-increasing literary activity in Finland, and it took the form less and less of the publication

of Swedish works, but more and more that of examples of the aboriginal vernacular. At the present time, in spite of the political troubles, books in almost every branch of research are found in the language, mainly translations or adaptations. We meet with, during the present century, a considerable number of names of poets and dramatists, no doubt very minor, as also painters, sculptors and musical composers. At the Paris International Exhibition of 1878 several native Finnish painters and sculptors exhibited works which would do credit to any country; and both in the fine and applied arts Finland occupied a position thoroughly creditable. An important contribution to a history of Finnish literature is Krohn's *Suomenkielinen runollisuus ruotsinvallan aikana* (1862). Finland is wonderfully rich in periodicals of all kinds, the publications of the Finnish Societies of Literature and of Sciences and other learned bodies being specially valuable. A great work in the revival of an interest in the Finnish language was done by the *Suomalaisen Kirjallisuuden Seura* (the Finnish Literary Society), which from the year 1841 has published a valuable annual, *Suomi*. The Finnish Literary Society has also published a new edition of the works of the father of Finnish history, Henry Gabriel Porthan (died 1804). A valuable handbook of Finnish history was published at Helsingfors in 1869-1873, by Yrjö Koskinen, and has been translated into both Swedish and German. The author was a Swede, Georg Forsman, the above form being a Finnish translation. Other works on Finnish history and some important works in Finnish geography have also appeared. In language we have Lönnrot's great Finnish-Swedish dictionary, published by the Finnish Literary Society. Dr Otto Donner's *Comparative Dictionary of the Finno-Ugric Languages* (Helsingfors and Leipzig) is in German. In imaginative literature Finland has produced several important writers of the vernacular. Alexis Stenwall ("Kiwi") (1834-1872), the son of a village tailor, was the best poet of his time; he wrote popular dramas and an historical romance, *The Seven Brothers* (1870). Among recent playwrights Mrs Minna Canth (1844-1897) has been the most successful. Other dramatists are E. F. Johnsson (1844-1895), P. Cajander (b. 1846), who translated Shakespeare into Finnish, and Karl Bergbom (b. 1843). Among lyric poets are J. H. Erkkö (b. 1849), Arwi Jännes (b. 1848) and Yrjö Weijola (b. 1875). The earliest novelist of Finland, Pietari Päivrinta (b. 1827), was the son of a labourer; he is the author of a grimly realistic story, *His Life*. Many of the popular Finnish authors of our day are peasants. Kauppi Heikki was a wagoner; Alkio Filander a farmer; Heikki Maviläinen a smith; Juhana Kokko (Kyösti) a gamekeeper. The most gifted of the writers of Finland, however, is certainly Juhani Aho (b. 1861), the son of a country clergyman. His earliest writings were studies of modern life, very realistically treated. Aho then went to reside in France, where he made a close study of the methods of the leading French novelists of the newer school. About the year 1893 he began to publish short stories, some of which, such as *Ennis*, *The Fortress of Matthias*, *The Old Man of Korpela* and *Finland's Flag*, are delicate works of art, while they reveal to a very interesting degree the temper and ambitions of the contemporary Finnish population. It has been well said that in the writings of Juhani Aho can be traced all the idiosyncrasies which have formed the curious and pathetic history of Finland in recent years. A village priest, Juho Reijonen (b. 1857), in tales of somewhat artless form, has depicted the hardships which poverty too often entails upon the Finn in his country life. Tolstoy has found an imitator in Arwid Järnefelt (b. 1861). Santeri Ingman (b. 1866) somewhat naively, but not without skill, has followed in the steps of Aho. It would be an error to exaggerate either the force or the originality of these early developments of a national Finnish literature, which, moreover, are mostly brief and unambitious in character. But they are eminently sincere, and they have the great merit of illustrating the local aspects of landscape and temperament and manners.

AUTHORITIES.—E. G. Palmén, *L'Œuvre demi-séculaire de la Suomalaisen Kirjallisuuden Seura, 1831-81* (Helsingfors, 1882); J. Krohn, *Suomalaisten Kirjallisuuden vaiheet* (Helsingfors, 1897);

F. W. Pipping, *Färteckning öfver böcker på finska språket* (Helsingfors, 1856-1857); E. Brausewetter, *Finland im Bilde seiner Dichtung und seiner Dichter* (Berlin, 1899); C. J. Billson, *Popular Poetry of the Finns* (London, 1900); V. Vasenius, *Öfversigt af Finlands Litteraturhistoria för skolor* (Helsingfors, 1893). For writers using the Swedish language, see SWEDEN: *Literature*. (E. G.)

FINLAY, GEORGE (1799-1875), British historian, was born of Scottish parents at Faversham, Kent, on the 21st of December 1799. He studied for the law in Glasgow, and about 1821 went to Göttingen. He had already begun to feel a deep interest in the Greek struggle for independence, and in 1823 he resolved to visit the country. In November he arrived in Cephalaria, where he was kindly received by Lord Byron. Shortly afterwards he landed at Pyrgos, and during the next fourteen months he improved his knowledge of the language, history and antiquities of the country. Though he formed an unfavourable opinion of the Greek leaders, both civil and military, he by no means lost his enthusiasm for their cause. A severe attack of fever, however, combined with other circumstances, induced him to spend the winter of 1824-1825 and the spring of 1825 in Rome, Naples and Sicily. He then returned to Scotland, and, after spending a summer at Castle Toward, Argyllshire, went to Edinburgh, where he passed his examination in civil law at the university, with a view to being called to the Scottish bar. His enthusiasm, however, carried him back to Greece, where he resided almost uninterruptedly till his death. He took part in the unsuccessful operations of Lord Cochrane and Sir Richard Church for the relief of Athens in 1827. When independence had been secured in 1829 he bought a landed estate in Attica, but all his efforts for the introduction of a better system of agriculture ended in failure, and he devoted himself to the literary work which occupied the rest of his life. His first publications were *The Hellenic Kingdom and the Greek Nation* (1836); *Essai sur les principes de banque appliqués à l'état actuel de la Grèce* (Athens, 1836); and *Remarks on the Topography of Oropia and Diacria, with a map* (Athens, 1838). The first instalment of his great historical work appeared in 1844 (2nd ed., 1857) under the title *Greece under the Romans; a Historical View of the Condition of the Greek Nation from the time of its Conquest by the Romans until the Extinction of the Roman Empire in the East*. Meanwhile he had been qualifying himself still further by travel as well as by reading; he undertook several tours to various quarters of the Levant; and as the result of one of them he published a volume *On the Site of the Holy Sepulchre; with a plan of Jerusalem* (1847). The *History of the Byzantine and Greek Empires from 716-1453* was completed in 1854. It was speedily followed by the *History of Greece under the Ottoman and Venetian Domination* (1856), and by the *History of the Greek Revolution* (1861). In weak health, and conscious of failing energy, he spent his last years in revising his history. From 1864 to 1870 he was also correspondent of *The Times* newspaper, his letters to which attracted considerable attention, and, appearing in the Greek newspapers, exercised a distinct influence on Greek politics. He was a member of several learned societies; and in 1854 he received from the university of Edinburgh the honorary degree of LL.D. He died at Athens on the 26th of January 1875. A new edition of his *History*, edited by the Rev. H. F. Tozer, was issued by the Oxford Clarendon press in 1877. It includes a brief but extremely interesting fragment of an autobiography of the author, almost the only authority for his life.

As an historian, Finlay had the merit of entering upon a field of research that had been neglected by English writers, Gibbon alone being a partial exception. As a student, he was laborious; as a scholar he was accurate; as a thinker, he was both acute and profound; and in all that he wrote he was unswerving in his loyalty to the principles of constitutional government and to the cause of liberty and justice.

FINN MAC COOL (in Irish **FINN MAC CUMAILL**), the central figure of the later heroic cycle of Ireland, commonly called Ossianic or Fenian. In Scotland Finn usually goes by the name of Fingal. This appears to be due to a misunderstanding of the title assumed by the Lord of the Isles, Rí Fionnghall, i.e. king of the Norse. Finn's father, Cumall mac Trénmóir, was uncle to Conn

Céthachach, High King of Ireland, who died in A.D. 157. Cumall carried off Murna Munchaem, the daughter of a Druid named Tadg mac Nuadat, and this led to the battle of Cnucha, in which Cumall was slain by Goll mac Morna (A.D. 174). Find was born after his father's death and was at first called Demni. He is leader of the *fiann* or *féinne* (English "Fenians"), a kind of militia or standing army which was drawn from all quarters of Ireland. His father had held the same office before him, but after his death it passed to his enemy Goll mac Morna, who retained it until Find came to man's estate. Find usually resided at Almu (Allen) in Co. Kildare, where he was surrounded by some of the contingents of the *fiann*, the rest being scattered throughout Ireland to ward off enemies, particularly those coming from over the sea. In times of invasion Find collected his forces, overcame the foe, and pursued him to Scotland or Lochlann (Scandinavia) as the case might be. When not engaged in war the *fiann* gave themselves up to the chase or love-adventures. We are informed in great detail as to the conditions of admission to this privileged band, which were at once singular and exacting. The foremost heroes in Find's train were his son Ossian, his grandson Oscar, Cailte mac Ronain, and Diarmaid O'Duibne, whose elopement with Find's destined bride Grainne, daughter of the High-King Cormac mac Airt (A.D. 227-266), forms the subject of a celebrated story. These, like Find, were all of the Ua Baisgne branch, with which was allied the Ua Morna, with whom they were generally at variance. The latter hailed from Connaught, chief among them being Goll and Conan. By the annalists Find is represented as having met with death by treachery either in 252 or 283. Under Coirpre Lifeochair, successor to Cormac mac Airt, the power of the *fiann* became intolerable. The monarch accordingly took up arms against them and utterly crushed them at the battle of Gabra (A.D. 283). Very few survived the defeat, but the story makes Ossian and Cailte live on until after the arrival of St Patrick in 432.

It is incredible that such a band as the *fiann* should have existed in the 2nd and 3rd centuries. A number of sagas older in date than the Ossianic stories have been preserved, which deal with events happening in the reigns of Art son of Conn (166-196), Lugaid mac Con (196-227), and Cormac mac Airt (227-266), but none of these in their oldest shape contain any allusion whatsoever to Find and his warriors. In the history of the Boroma, contained in the book of Leinster, Find is merely a Leinster chieftain who assists Bressal the king of Leinster against Coirpre Lifeochair. It can be shown that Find was originally a figure in Leinster-Munster tradition previous to the Viking age, but we have no documentary evidence concerning him at this time. He seems primarily to have been regarded as a poet and magician. Later he appears to have been transformed into a petty chief, and Zimmer even tried to show that his personality was developed in Leinster and Munster local tradition out of stories clustering round the figure of the Viking leader Ketill Hviti (Caithil Find), who was slain in 857. By the year 1000 Find was certainly connected in the minds of the people with the reign of Cormac mac Airt, but the process is obscure. Recently John MacNeill has pointed out that in the oldest genealogies Find is always connected with the Ui Tairrsigh of Failge (Offaley, a district comprising the present county of Kildare and parts of King's and Queen's counties). The Ui Tairrsigh were undoubtedly of Firbolg origin, and MacNeill would account in this manner for the slow acceptance of the stories by the conquering Milesians. Whilst the Ulster epic was fashionable at court, the subject races clung to the Fenian cycle. For the last 800 years Find has been the national hero of the Gaelic-speaking populations of Ireland, the Scottish Highlands and the Isle of Man. See also CELT (subsection *Irish Literature*).

AUTHORITIES.—A. Nutt, *Ossian and the Ossianic Literature* (London, 1899); H. Zimmer, "Keltische Beiträge iii.," *Zeitschrift für deutsches Altertum* (1891), vol. xxxv. pp. 1-172; L. C. Stern, "Die Ossianischen Heldenlieder," *Zeitschrift für vergleichende Literaturgeschichte* (1895); trans. by J. L. Robertson in *Transactions of the Gaelic Society of Inverness*, 1897-1898, vol. xxii. pp. 257-325; J. MacNeill, *Duanaire Finn* (London, 1908). (E. C. Q.)

FINNO-UGRIAN, or **FINNO-UGRIC**, the designation of a division of the Ural-Altaic family of languages and their speakers. The first part is the name given by their neighbours, though not used by themselves, to the inhabitants of the eastern shores of the Baltic. It is probably the same word as the Fenni of Tacitus and Φίννοι of Ptolemy, though it is not certain that those races were Finns in the modern sense. It possibly means people of the fens or marshes, and corresponds to the native word *Suomi*, which appears to be derived from *suo*, a marsh. Finn and Finnish are used not only of the inhabitants of Finland but also in a more extended sense of similar tribes found in Russia and sometimes called Baltic Finns and Volga Finns. In this sense the Esthonian tribes (Baltic), the Laps, the Cheremis and Mordvins (Volga), and the Permian tribes are all Finns. The name is not, however, extended to the Ostiaks, Voguls and Magyars, who, though allied, form a separate subdivision called Ugrian, a name derived from Yura or Ugra, the country on either side of the Ural Mountains, and first used by Castrén in a scientific sense.

The name Finno-Ugric is primarily linguistic and must not be pressed as indicating a community of physical features and customs. But making allowance for the change of language by some tribes, the Finno-Ugrians form, with the striking exception of the Hungarians, a moderately homogeneous whole. They are nomads, but, unlike the Turks, Mongols and Manchus, have hardly ever shown themselves warlike and have no power of political organization. Those of them who have not come under European influence live under the simplest form of patriarchal government, and states, kings or even great chiefs are almost unknown among them.

Their headquarters are in Russia. From the Baltic to south Siberia extends a vast plain broken only by the Urals. Large parts of it are still wooded, and the proportion of forest land and marsh was no doubt much greater formerly. The Finno-Ugric tribes seem to shun the open steppes but are widely spread in the wooded country, especially on the banks of lakes and rivers. Their want of political influence renders them obscure, but they form a considerable element in the population of the northern, middle and eastern provinces of Russia, but are not found much to the south of Moscow (except in the east) or in the west (except in the Baltic provinces). The difference of temperament between the Great Russians and the purer Slavs such as the Little Russians is partly due to an infusion of Finnish blood.

Physically the Finno-Ugric races are as a rule solidly built and, though there is considerable variation in height and the cephalic index, are mostly of small or medium stature, somewhat squat, and brachy- or mesocephalic. As a rule the skin is greyish or olive coloured, the eyes grey or blue, the hair light, the beard scanty. Most of them seem deficient in energy and liveliness, both mental and physical; they are slow, heavy, conservative, somewhat suspicious and vindictive, inclined to be taciturn and melancholy. On the other hand they are patient, persevering, industrious, faithful and honest. When their natural mistrust of strangers is overcome they are kindly and hospitable.

I. Tribes and Nations.—The Ugrian subdivision, which seems to be in many respects the more primitive, consists of three peoples standing on very different levels of civilization, the Ostiaks and Voguls and the Hungarians.

The *Ostiaks* (Ostyaks or Ostjaks) are a tribe of nomadic fishermen and hunters inhabiting at present the government of Tobolsk and the banks of the Obi. They formerly extended into the government of Perm on the European side of the Ural Mountains. The so-called Ostiaks of the Yenisei appear to be a different race and not to belong to the Finno-Ugrian group. The Ostiaks are still partially pagan and worship the River Obi. Allied to them are the *Voguls*, a similar nomadic tribe found on both sides of the Urals, and formerly extending at least as far as the government of Vologda.

The languages of the Ostiaks and Voguls are allied, though not mere dialects of one another, and form a small group separated from the languages of the Finns both Western and Eastern.

For further details of these and other tribes see under the separate headings.

According to the legend, Nimrod had two sons, Hunyor and Magyor. They married daughters of the prince of the Alans and became the ancestors of the two kindred nations, Huns and Magyars or Hungarians. This story corresponds with what can be ascertained scientifically about the origin of these peoples. It is probable that the

**Magyars
or Hun-
garians.**

Huns and Magyars were allied tribes of mixed descent comprising both Turkish and Finno-Ugrian elements. The language is indisputably Finno-Ugrian, but the name Hungarian seems to lead back to the form Un-ugur, and to suggest Turkish connexions which are confirmed by the warlike habits of the Huns and Magyars. The same name possibly occurs in the form Hiung-nu as far east as the frontiers of China, but recent authorities are of opinion that the tribes from whom the present Hungarians are descended were formed originally in the Terek-Kuban country to the north of the Caucasus, where a mixture of Turkish and Ugrian blood took place, a Ugrian language but Turkish mode of life predominating. They were also influenced by Iranians and the various tribes of the Caucasus. Both Huns and Magyars moved westwards, but the Huns invaded Europe in the 5th century and made no permanent settlement in spite of the devastation they caused, whereas the Magyars remained for some centuries near the banks of the Don. According to tradition they were compelled to leave a country called Lebedia under the pressure of nomadic tribes, and moved westward under the leadership of seven dukes. They conquered Hungary in the years 884-895, and the first king of their new dominions was called Árpád. For the chequered and often tragic history of the country see HUNGARY. The Magyars were converted to Christianity in the 11th century and adhered to the Roman not the Eastern Church. They have in all probability entirely lost their ancient physique, but have retained their language, and traces of their older life may be seen in their fondness for horses and flocks.

The following are the principal Finnish peoples. The *Permians* and *Syryenians* may be treated as one tribe. The latter name is very variously spelt as Syryenian, Sirianian, Zyrjenian, Zirian, &c. They both call themselves Komi and speak a mutually intelligible language, allied to *Votiak*. The name Bjarmisch is sometimes applied to this sub-group. Both Permians and Syryenians are found chiefly in the governments of Perm, Vologda and Archangel, but there are a few Syryenians on the Siberian side of the Urals. The Syryenian headquarters are at the town of Ishma on the Pechora, whereas the name Permian is more correctly restricted to the inhabitants of the right bank of the upper Kama. Both probably extended much farther to the west in former times. The Syryenians are said to be more intelligent and active than most Finnish tribes and to make considerable journeys for trading purposes. They are possibly a mixed race.

**Permians
and Syr-
yenians.**

The *Votiaks* are a tribe of about a quarter of a million persons dwelling chiefly in the south-eastern part of the government of Viatka. Their language indicates that they have borrowed a good deal from the Tatars and Chuvashes, and they seem to have little individuality, being described as weak both mentally and physically. They call themselves Ud-murt or Urt-murt. About the 16th century some of them migrated, doubtless under the pressure of Russian advance, into the government of Ufa and, the country being more fertile, are said to have improved in physique.

The *Cheremissians*, or Tcheremissians or Cheremis, who call themselves Mari, inhabit the banks of the Volga, chiefly in the neighbourhood of Kazan. Those inhabiting the right bank of the Volga are physically stronger and are known as Hill Cheremiss. The evidence of place names makes it probable that their present position is the result of their being driven northwards by the Mordvins and then southwards by the Russians. There is some discrepancy between their language and their physical characteristics. The former shows affinities to both Mordvinian and the Permian group, but

**Chere-
missians.**

their crania are said to be mainly dolichocephalic, and it has been suggested that they are connected with the neolithic dolichocephalic population of Lake Ladoga. They are gentle and honest, but neither active nor intelligent.

The *Mordvinians*, also called Mordvá, Mordvins and Mordvs, are scattered over the provinces near the middle Volga, especially Nizhniy Novgorod, Kazan, Penza, Tambov, Simbirsk, Ufa and even Orenburg. Though not continuous, their settlements are considerable both in extent and population. They are the most important of the Eastern Finns, and their traditions speak of a capital and of a king who fought with the Tatars. They are mentioned as Mordens as early as the 6th century, but do not now use the name, calling themselves after one of their two divisions, Moksha or Erza. Their country is still covered with forest to a large extent. Their language is on the one side allied to Cheremissian. On the other it shows a nearer approach to Finnish (Suomi) than the other Eastern languages of the family, but it has also constructions peculiar to itself.

**Mord-
vinians.**

The *Lapps* are found in Norway, Sweden and Finland. They call themselves Sabme, but are called Finns by the Norwegians. They are the shortest and most brachycephalic race in Europe. The majority are nomads who live by pasturing reindeer, and are known as Mountain Lapps, but others have become more or less settled and live by hunting or fishing. From ancient times the Lapps have had a great reputation among the Finns and other neighbouring nations for skill in sorcery.

Lapps.

The *Esthoniens* are the peasantry of the Russian province Esthonia and the neighbouring districts. They were serfs until 1817 when they were liberated, but their condition remained unsatisfactory and led to a serious rebellion in 1859. They are practically a branch of the Finns, and are hardly separable from the other Finnish tribes inhabiting the Baltic provinces. The name Est or Ehst, by which they are known to foreigners, appears to be the same as the Aestii of Tacitus, and to have properly belonged to quite a different tribe. They call themselves Mä mēs, or country people, and their land Rahwama or Wiroma (cf. Finnish, Virolaiset, Esthoniens.) Though not superior to other tribes in general intelligence, they have become more civilized owing to their more intimate connexion with the Russian and German population around them.

**Estho-
niens.**

Livs, *Livolanders* or *Livonians* is the name given to the old Finnish-speaking population of west Livland or Livonia and north Kurland. We hear of them as a warlike and predatory pagan tribe in the middle ages, and it is possible that they were a mixed Letto-Finnish race from the beginning. In modern times they have become almost completely absorbed by Letts, and their language is only spoken in a few places on the coast of Kurland. It has indeed been disputed if it still exists. It is known as Livish or Livonian and is allied to Esthonian.

**Livo-
nians.**

The *Votes* (not to be confounded with the *Votiaks*), also called southern Chudes and Vatjalaiset, apparently represent the original inhabitants of Ingria, the district round St Petersburg, but have decreased before the advance of the Russians and also of Karelians from the north. They are heard of in the 11th century, but now occupy only about thirty parishes in north-west Ingria.

Votes.

The *Vepsas* or *Vepses*, also called Northern Chudes, are another tribe allied to the Esthoniens, but are more numerous than the Votes. They are found in the district of Tikhvinsk and other parts of the government of Old Novgorod, and apparently extended farther east into the government of Vologda in former times. Linguistically both the Votes and Vepsas are closely related to the Esthoniens.

Vepsas.

The *Finns* proper or Suomi, as they call themselves, are the most important and civilized division of the group. They inhabit at present the grand duchy of Finland and the adjacent governments, especially Olonetz, Tver and St Petersburg. Formerly a tribe of them called Kainulaiset was also found in Sweden, whence the Swedes call the Finns

Finns.

Qven. At present there are two principal subdivisions of Finns, the Tavastlanders or *Hämäläiset*, who occupy the southern and western parts of the grand duchy, and the Karelians or *Karjalaiset* found in the east and north, as far as Lake Onega and towards the White Sea.

The former, and generally speaking, all the inhabitants of the grand duchy have undergone a strong Swedish influence. There is a considerable admixture of Swedish blood; the language is full of Swedish words; Christianity is universal; and the upper classes and townspeople are mainly Swedish in their habits and speech, though of late a persistent attempt has been made to Russify the country. The Finns have much the same mental and moral characteristics as the other allied tribes, but have reached a far higher intellectual and literary stage. Several collections of their popular and mythological poetry have been made, the most celebrated of which is the *Kalewala*, compiled by Lönnrot about 1835, and there is a copious modern literature. The study of the national languages and antiquities is prosecuted in Helsingfors and other towns with much energy; several learned societies have been formed and considerable results published, partly in Finnish. It is clear that this scientific activity, though animated by a patriotic Finnish spirit, owes much to Swedish training in the past. Besides the literary language there are several dialects, the most important of which is that of Savolaks.

The *Karelians* are not usually regarded as separate from the Finns, though they are a distinct tribe as much as the *Vepsas* and *Votes*. Living farther east they have come less under Swedish and more under Russian influence than the inhabitants of West Finland; but, since many of the districts which they inhabit are out of the way and neglected, this influence has not been strong, so that they have adopted less of European civilization, and in places preserved their own customs more than the Westerners. They are of a slighter and better proportioned build than the Finns, more enterprising, lively and friendly, but less persevering and tenacious. They number about 260,000, of whom about 63,000 live in Olonetz and 195,000 in Tver and Novgorod, but in the southern districts are less distinguished from the Russian population. They belong to the Russian Church, whereas the Finns of the grand duchy are Protestants. There also appear to be authentic traces of a Karelian population in Kaluga, Yaroslavl, Vladimir, Vologda and Tambov. It was among them that the *Kalewala* was collected, chiefly in East Finland and Olonetz.

There is some difference of opinion as to whether the *Samoyedes* should be included among the Finno-Ugrian tribes or be given the rank of a separate division equivalent to Finno-Ugrian and Turkish. The linguistic question is discussed below. The *Samoyedes* are a nomad tribe who wander with their reindeer over the treeless plains which border on the White and Kara seas on either side of the Urals. In culture and habits they resemble the Finno-Ugrian tribes, and there seems to be no adequate reason for separating them.

Various other peoples have been referred to the Finno-Ugrian group, but some doubt must remain as to the propriety of the classification, either because they are now extinct, or because they are suspected of having changed their language.

The original Bulgarians, who had their home on the Volga before they invaded the country which now bears their name, were probably a tribe similar to the Magyars, though all record of their language is lost. It has been disputed whether the Khazars, who in the middle ages occupied parts of south Russia and the shores of the Caspian, were Finno-Ugrians or Turks, and there is the same doubt about the Avars and Pechenegs, which without linguistic evidence remains insoluble. Nor is the difference ethnographically important. The formation of hordes of warlike bodies, half tribes, half armies, composed of different races, was a characteristic of Central Asia, and it was probably often a matter of chance what language was adopted as the common speech.

At the present day the Bashkirs, Meshchers and Tepters, who

speak Tatar languages, are thought to be Finnish in origin, as are also the Chuvashes, whose language is Tatar strongly modified by Finnish influence. The little known Soyots of the headwaters of the Yenisei are also said to be Finno-Ugrians.

The name Chude appears to be properly applied to the *Vepsas* and *Votes* but is extended by popular usage in Russia to all Finno-Ugrian tribes, and to all extinct tribes of whatever race who have left tombs, monuments or relics of mining operations in European Russia or Siberia. Some Russian archaeologists use it specifically of the Permian group. But its extension is so vague that it is better to discard it as a scientific term.

II. *Languages*.—The Finno-Ugric languages are generally considered as a division of the Ural-Altai group, which consists of four families: Turkish, Mongol, Manchu and Finno-Ugric, including *Samoyede* unless it is reckoned separately as a fifth. The chief character of the group is that agglutination, or the addition of suffixes, is the only method of word-formation, prefixes and significant change of vowels being unknown, as is also gender. This suggests an affinity with many other languages, such as the ancient Accadian or Sumerian, and Japanese. A connexion between the Finno-Ugric and Dravidian languages has also been suggested. On the other hand, the more highly developed agglutinative languages, such as Finnish, approach the inflected Aryan type, so that the Aryan languages may have been developed from an ancestor not unlike the Ural-Altai group.

The Finno-Ugrian languages are distinguished from the other divisions of the Ural-Altai group both in grammar and vocabulary. Compared with Mongol and Manchu they have a much greater wealth of forms, both in declension and conjugation; the suffixes form one word with the root and are not wholly or partially detachable postpositions; the pronominal element is freely represented in the suffixes added to both verbs and nouns. These features are also found in the Turkish languages, but Finno-Ugrian has a much greater variety of cases denoting position or motion, and the union of the case termination with the noun is more complete; in some languages the object can be incorporated in the verb, which does not occur in Turkish, but the negative is rarely (*Cheremissian*) thus incorporated after the Turkish fashion (e.g. *yazmak*, "to write"; *yazmamak*, "not to write"), and in some languages takes pronominal suffixes (Finnish *en tule, et tule, eivät tule*, "I, you, they do not come"). Vowel-harmony is completely observed in Finnish and Magyar, but in the other languages is imperfectly developed, or has been lost under Russian influence. Relative pronouns and particles exist and are fully developed in some languages. The tendency to form compounds, which is not characteristic of Turkish, is very marked in Finnish and Hungarian, and is said also to be found in *Samoyede*, *Cheremissian* and *Syryenian*. The original order in the sentence seems to be that the governing word follows the word governed, but there are many exceptions to this, particularly in Hungarian where the arrangement is very free.

In vocabulary the pronouns agree fairly well with those of Turkish, Mongol and Manchu, but there is little resemblance between the numbers. Many of the languages contain numerous Tatar and Turkish loan-words, but with this exception the resemblance of vocabulary is not striking and indicates an ancient separation. But the similarity in the process of word-building and of the elements used, even if they have not the same sense, as well as analogies in the general construction of sentences and in some details (e.g. the use of the infinitive or verbal substantive), seem to justify the hypothesis of an original relationship with the Turkish languages, which in their turn have connexions with the other groups.

Samoyede is classed by some as a separate group and by some among the Finno-Ugrian languages, but it at any rate displays a far closer resemblance to them in both grammar and vocabulary than do any of the Turkish languages. The numerals are different, but the personal and interrogative pronouns and many common words (e.g. *joha*, "river," Finn. *joki*; *sava*, "good," Finn. *hyvä*; *kole*, "fish," Finn. *kala*)

show a considerable resemblance. The inflection of nouns is very like that found in Finno-Ugrian but that of the verb differs, verb and noun being imperfectly differentiated. In detail, however, the verbal suffixes show analogies to those of Finno-Ugrian. Vowel-harmony and weakening of consonants occur as in Finnish.

Excluding Samoyede, the Finno-Ugrian languages may be divided into two sections: (1) Ugrian, comprising Ostiak, Vogul and Magyar; and (2) Finnish. The Permian languages (Syryenian, Permian and Votiak) form a distinct group within this latter section, and the remainder may be divided into the Volga group (Cheremissian and Mordvinian) and the West Finnish (Lappish, Esthonian and Finnish proper).

The Ugrian languages appear to have separated from the Finnish branch before the systems of declension or conjugation were developed. Their case suffixes seem to be later formations, though we find, *t*, *ll* or *k* for the plural and traces of *l* as a local suffix. Ostiak and Vogul, like Samoyede, have a dual. Moods and tenses are less numerous but the number of verbal forms is increased by those in which the pronominal object is incorporated. Hungarian has naturally advanced enormously beyond the stage reached by Ostiak and Vogul, and shows marks of strong European influence, but also retains primitive features. Vowel-harmony is observed (*várok*, "I await," but *verek*, "I strike"). The verb has two sets of terminations, according as it is transitive or intransitive, and the pronominal object is sometimes incorporated. Alone among Finno-Ugrian languages it has developed an article, and the adjective is inflected when used as a predicate though not as an attribute (*Jó emberek*, "good men," but *Az emberek jók*, "the men are good"). There is great freedom in the order of words and, as in Finnish, a tendency to form long compounds.

The Finnish languages are not divided from the Ugrian by any striking differences, but show greater resemblances to one another in details. None of them have a dual and only Mordvinian an objective conjugation. The case system is elaborate and generally comprises twelve or fifteen forms. The negative conjugation is peculiar; there are negative adjectives ending in *tem* or *tom* and abessive cases (e.g. Finnish *syyttä*, without a cause, *tiedotta*, without knowledge).

Permian, Syryenian and Votiak exhibit this common development less fully than the more western languages. They are less completely inflected than the Finnish languages and more thoroughly agglutinative in the strict sense. In vocabulary, e.g. the numerals, they show resemblances to the Ugrian division. Syryenian has older literary remains than any Finno-Ugrian language except Hungarian. In the latter part of the 14th century Russian missionaries composed in it various manuals and translations, using a special alphabet for the purpose.

Unlike the Finnish and Esthonian branch, the languages of the Volga Finns (Mordvinian and Cheremissian) have been influenced by Russian and Tatar rather than by Scandinavian, and hence show apparent differences. But Mordvinian has points of detailed resemblance to Finnish which seem to point to a comparatively late separation, e.g. the use of *kemen* for ten, *-nza* as the possessive suffix of the third personal pronoun, the regular formation of the imperfect with *i*, the infinitive with *ma*, and the participle with *f* (Finnish *va*). On the other hand it has many peculiarities. It retains an objective conjugation like the Ugrian languages, and has developed two forms of declension, the definite and indefinite.

Cheremissian has affinities to both the Permian languages and Mordvinian. It resembles Syryenian in its case terminations and also in marking the plural by interposing a distinct syllable (Syry. *yas*, Cher. *vlya*) between the singular and the case suffixes. Most of the numerals are like Syryenian but *kändekhsye*, *indekhsye*, for eight and nine, recall Finnish forms (*kahdeksan*, *yhdeksän*), as do also the pronouns.

The connexion between the various West Finnish languages is more obvious than between those already discussed. Lappish (or Lapponic) forms a link between them and Mordvinian. Its pronouns are remarkably like the Mordvinian equivalents, but

the general system of declension and conjugation, both positive and negative, is much as in Finnish. Superficially, however, the resemblance is somewhat obscured by the difference in phonetics, for Lappish has an extraordinary fondness for diphthongs and also an unusually ample provision of consonants.

The affinity of Esthonian (together with Votish, Vepsish and Livish) to Finnish is obvious not only to the philologist but to the casual learner. In a few cases it shows older forms than Finnish, but on the whole is less primitive and has assumed under foreign influence the features of a European language even more thoroughly. The vowel-harmony is found only in the Dorpat dialect and there imperfectly, the pronominal affixes are not used, and the negative has become an unvarying particle, though in Vepsish and Votish it takes suffixes as in Finnish. On the other hand, the laws for the change of consonants, the general system of phonetics, the declension, the pronouns and the positive conjugation of the verb all closely resemble Finnish. Esthonian has two chief dialects, those of Reval and Dorpat, and a certain amount of literary culture, the best-known work being the national epic or *Kalevi-poeg*.

Finnish proper is divided into two chief dialects, the Karelian or Eastern, and the Tavastland or Western. The spoken language of the Karelians is corrupt and mixed with Russian, but the *Kalevala* and their other old songs are written in a pure Finnish dialect, which has come to be accepted as the ordinary language of poetry throughout modern Finland, just as the Homeric dialect was used by the Greeks for epic poetry. It is more archaic than the Tavastland dialect and preserves many old forms which have been lost elsewhere, but its utterance is softer and it sometimes rejects consonants which are retained in ordinary speech, e.g. *saa'a*, *kosen* for *saada*, *kosken*.

The affinity of Finnish to the more eastern languages of the group is clear, but it has been profoundly influenced by Scandinavian and in its present form consists of non-Aryan material recast in an Aryan and European mould. Not only are some of the simplest words borrowed from Scandinavian, but the grammar has been radically modified. Un-Aryan peculiarities have been rejected, though perhaps less than in Esthonian. The various forms of nouns and verbs are not merely roots with a string of obvious suffixes attached, but the termination forms a whole with the root as in Greek and Latin inflections; the adjective is declined and compared and agrees with its substantive; compound tenses are formed with the aid of the auxiliary verb, and there is a full supply of relative pronouns and particles.

Finnish and Hungarian together with Turkish are interesting examples of non-Aryan languages trying to participate, by both translation and imitation, in the literary life of Europe, but it may be doubted if the experiment is successful. The sense of effort is felt less in Hungarian than in the other languages; though they are admirable instruments for terse conversation or popular poetry, there appears to be some deep-seated difference in the force of the verb and the structure of phrases which renders them clumsy and complicated when they attempt to express sentences of the type common in European literature.

III. *Civilization and Religion*.—The Finno-Ugric tribes have not been equally progressive; some, such as the Finns and Magyars, have adopted, at least in towns, the ordinary civilization of Europe; others are agriculturists; others still nomadic. The wilder tribes, such as the Ostiaks, Voguls and Lapps, mostly consist of one section which is nomadic and another which is settling down. The following notes apply to traces of ancient conditions which survive sporadically but are nowhere universal. Few except the Hungarians have shown themselves warlike, though we read of conflicts with the Russians in the middle ages as they advanced among this older population. But most Finno-Ugrians are astute and persevering hunters, and the Ostiaks still shoot game with a bow. The tribes are divided into numerous small clans which are exogamous. Marriage by capture is said to survive among the Cheremiss, who are still polygamous in some districts, but purchase of the bride is the more general form. Women are treated as servants and often

excluded from pagan religious ceremonies. The most primitive form of house consists of poles inclined towards one another and covered with skins or sods, so as to form a circular screen round a fire; winter houses are partly underground. Long snow-shoes are used in winter and boats are largely employed in summer. The Finns in particular are very good seamen. The Ostiaks and Samoyedes still cast tin ornaments in wooden moulds. The variation of the higher numerals in the different languages, which are sometimes obvious loan words, shows that the original system did not extend beyond seven, and the aptitude for calculating and trading is not great. Several thousands of the Ostiaks, Voguls and Cheremiss are still unbaptized, and much paganism lingers among the nominal Christians, and in poetry such as the *Kalewala*. The deities are chiefly nature spirits and the importance of the several gods varies as the tribes are hunters, fishermen, &c. Sun or sky worship is found among the Samoyedes and *Jumala*, the Finnish word for god, seems originally to mean sky. The Ostiaks worship a water-spirit of the river Obi and also a thunder-god. We hear of a forest-god among the Finns, Lapps and Cheremiss. There are also clan gods worshipped by each clan with special ceremonies. Traces of ancestor-worship are also found. The Samoyedes and Ostiaks are said to sacrifice to ghosts, and the Ostiaks to make images of the more important dead, which are tended and honoured, as if alive, for some years. Images are found in the tombs and barrows of most tribes, and the Samoyedes, Ostiaks and Voguls still use idols, generally of wood. Animal sacrifices are offered, and the lips of the idol sometimes smeared with blood. Quaint combinations of Christianity and paganism occur; thus the Cheremiss are said to sacrifice to the Virgin Mary. The idea that disease is due to possession by an evil spirit, and can be both caused and cured by spells, seems to prevail among all tribes, and in general extraordinary power is supposed to reside in incantations and magical formulae. This belief is conspicuous in the *Kalewala*, and almost every tribe has its own collection of prayers, healing charms and spells to be used on the most varied occasions. A knowledge of these formulae is possessed by wizards (Finnish *noite*) corresponding to the Shamans of the Altaic peoples. They are exorcists and also mediums who can ascertain the will of the gods; a magic drum plays a great part in their invocations, and their office is generally hereditary. The non-Buddhist elements of Chinese and Japanese religion present the same features as are found among the Finno-Ugrians—nature-worship, ancestor-worship and exorcism—but in a much more elaborate and developed form.

IV. *History*.—Most of the Finno-Ugrian tribes have no history or written records, and little in the way of traditions of their past. In their later period the Hungarians and Finns enter to some extent the course of ordinary European history. For the earlier period we have no positive information, but the labours of investigators, especially in Finland, have collected a great number of archaeological and philological data from which an account of the ancient wanderings of these tribes may be constructed. Barrows containing skulls and ornaments may mark the advance of a special form of culture, and language may be of assistance; if we find, for instance, a language with loan words of an archaic type, we may conclude that it was in contact with the other language from which it borrowed at the time when such forms were current. But clearly all such deductions contain a large element of theory, and the following sketch is given with all reserve.

The Finno-Ugrian tribes originally lived together east of the Urals and spoke a common language. It is not certain if they were all of the same physical type, for the association of different races speaking one language is common in central Asia. They were hunters and fishermen, not agriculturists. At an unknown period the Finns, still undivided, moved into Europe and perhaps settled on the Volga and Oka. They had perhaps arrived there before 1500 B.C., learned some rudiments of agriculture, and developed their system of numbers up to ten. They were still in the neolithic stage. About 600 B.C. they came in contact with an Iranian people, from whom they learned the use of

metals, and borrowed numerals for a hundred (Finnish *sata*, Ostiak *sāt*, Magyar *szaz*; cf. Zend *sata*) and a thousand (Magyar *ezer*; cf. *hazaŋra* and *hazar*). Magyar and some other languages also borrowed a word for ten (*tíz*, cf. *das*). This Iranian race may perhaps have been the Scythians, who are believed by many authorities to have been Iranians and to be represented by the Osetians of the Caucasus. There was probably a trade route up the Volga in the 4th century B.C. About that time the Western Finns must have broken away from the Mordvins and wandered north-westwards. At a period not much later than the Christian era, they must have come in contact with Letto-Lithuanian peoples in the Baltic provinces, and also with Scandinavians. Whether they came in contact with the latter first in the Baltic provinces or in Finland itself is disputed, as there may have been Scandinavians in the Baltic provinces. But the distribution of tombs and barrows seems to indicate that they entered Finland not from the east through Karelia but from the Baltic provinces by sea to Satakunta and the south-east coast, whence they extended eastwards. From both Lithuanians and Scandinavians they borrowed an enormous quantity of culture-words and probably the ideas and materials they indicate. Thus the Finnish words for gold, king and everything concerned with government are of Scandinavian origin. Their migration to Finland was probably complete about A.D. 800. Meanwhile the Slav tribes known later as Russians were coming up from the south and pressed the Finns northwards, overwhelming but not annihilating them in the country between St Petersburg and Moscow. The same movement tended to drive the Eastern Finns and Ugrians backwards towards the east. The Finns know the Russians by the name of *Venäjä*, or Wends, and as this name is not used by Slavs themselves but by Scandinavians and Teutons, it seems clear that they arrived among the Finns as greater strangers than the Scandinavians and known by a foreign name. Christianity was perhaps first preached to the Finns as early as A.D. 1000, but there was a long political and religious struggle with the Swedes. At the end of the 13th century Finland was definitely converted and annexed to Sweden, remaining a dependency of that country until 1809, when it was ceded to Russia.

The Ugrians and Eastern Finns took no part in the westward movement and did not fall under western influences but came into contact with Tatar tribes and were more or less Tatarized. In some cases this took the form of the adoption of a Tatar language, in others (Mordvin, Cheremis and Votiak) a large number of Tatar words were borrowed. We also know that there were considerable settlements of these tribes, perhaps amounting to states, on the Volga and in south-eastern Russia. Such was Great Bulgaria, which continued until destroyed by the Mongols in 1238. The pressure of tribes farther east acting on these settlements dislodged sections of them from time to time and created the series of invasions which devastated the East Roman empire from the 5th century onwards. But we do not know what were the languages spoken by the Huns, Bulgarians, Pechenegs and Avars, so that we cannot say whether they were Turks, Finns or Ugrians, nor does it follow that a horde speaking a Ugrian language were necessarily Ugrians by race. An inspection of the performances of the various tribes, as far as we can distinguish them, suggests that the Turks or Tatars were the warlike element. The names Hun and Hungarian may possibly be the same as Hiung-nu, but we cannot assume that this tribe passed across Asia unchanged in language and physique. The Hungarians entered on their present phase at the end of the 9th century of this era, when they crossed the Carpathians and conquered the old Pannonia and Dacia. For half a century or so before this invasion they are said to have inhabited Atelkuzu, probably a district between the Dnieper and the Danube. The isolated groups of Hungarians now found in Transylvania and called Szeklers are considered the purest descendants of the invading Magyars. Those who settled in the plains of Hungary probably mingled there with remnants of Huns, Avars and earlier invaders, and also with subsequent invaders, such as Pechenegs and Kumans.

BIBLIOGRAPHY.—Among the older writers may be mentioned Strahlenberg (*Das nord- und östliche Theil von Europa und Asia*, 1730), Johann Gottlieb Georgi (*Description de toutes les nations de l'empire de la Russie*, French tr., St Petersburg, 1777), but especially the various works of Matthias A. Castrén (1852–1853) and W. Schott (1858). Modern scientific knowledge of the Finno-Ugrians and their languages was founded by these two authors. Among newer works some of the most important separate publications are: J. R. Aspelin, *Antiquités du nord finno-ougrien* (1877–1884); J. Abercromby, *Pre- and Proto-historic Finns* (1898); and A. Hackmann, *Die ältere Eisenzeit in Finnland* (1905).

The recent literature on the origin, customs, antiquities and languages of these races is voluminous, but is contained chiefly not in separate books but in special learned periodicals. Of these there are several: *Journal de la Société Finno-ougrienne* (Helsingfors) (*Suomalais-Ugrilainen Seuran Aikakauskirja*); *Finnisch-Ugrische Forschungen* (Helsingfors and Leipzig); *Mitteilungen der archäologischen, historischen und ethnographischen Gesellschaft der Kais. Universität zu Kasan*; *Keleti Szemle* or *Revue orientale pour les études ouralo-altaïques* (Budapest). In all of these will be found numerous valuable articles by such authors as Ahlqvist, Halévy, Heikel, Krohn, Muncácsi, Paasonen, Setälä, Smurnow, Thomsen and Vambéry.

The titles of grammars and dictionaries will be found under the headings of the different languages. For general linguistic questions may be consulted the works of Castrén, Schott and Otto Donner, also such parts of the following as treat of Finno-Ugric languages: Byrne, *Principles of the Structure of Language*, vol. i. (1892); Friedrich Müller, *Grundriss der Sprachwissenschaft* II., Band ii., Abth. 1882; Steinthal and Misleli, *Abriß der Sprachwissenschaft* (1893). (C. E.L.)

FINSBURY, a central metropolitan borough of London, England, bounded N. by Islington, E. by Shoreditch, S. by the city of London and W. by Holborn and St Pancras. Pop. (1901) 101,463. The principal thoroughfares are Pentonville Road, from King's Cross east to the Angel, Islington, continuing E. and S. in City Road and S. again to the City in Moorgate Street; Clerkenwell Road and Old Street, crossing the centre from W. to E.; King's Cross Road running S.E. into Farringdon Road, and so to the City; St John Street and Road and Goswell Road (the residence of Dickens' *Pickwick*) running S. from the Angel towards the City; and Rosebery Avenue running S.W. from St John Street into Holborn. The commercial character of the City extends into the southern part of the borough; the residential houses are mostly those of artisans. Local industries include working in precious metals, watch-making, printing and paper-making.

An early form of the name is Vynesbury, but the derivation is not known. The place was supposed by some to take name from an extensive fen, a part of which, commonly known as Moorfields (cf. Moorgate Street), was drained in the 16th century and subsequently laid out as public grounds. It was a frequent resort of Pepys, who mentions its houses of entertainment and the wrestling and other pastimes carried on, also that it furnished a refuge for many of those whose houses were destroyed in the fire of London in 1666. Bookstalls and other booths were numerous at a somewhat later date. The borough includes the parish of Clerkenwell (*q.v.*), a locality of considerable historic interest, including the former priory of St John, Clerkenwell, of which the gateway and other traces remain. Among several other sites and buildings of historical interest the Charterhouse (*q.v.*) west of Aldersgate Street, stands first, originally a Carthusian monastery, subsequently a hospital and a school out of which grew the famous public school at Godalming. Bunhill Fields, City Road, was used by the Dissenters as a burial-place from the middle of the 17th century until 1832. Among eminent persons interred here are John Bunyan, Daniel Defoe, Susanna, mother of John and Charles Wesley, and George Fox, founder of the Society of Friends. A neighbouring chapel is intimately associated with the Wesleys, and the house of John Wesley is opened as a museum bearing his name. Many victims of the plague were buried in a pit neighbouring to these fields, near the junction of Goswell Road and Old Street. To the south of the fields lies the Artillery Ground, the training ground of the Honourable Artillery Company, so occupied since 1641, with barracks and armoury. Sadler's Wells theatre, Rosebery Avenue, dating as a place of entertainment from 1683, preserves the name of a fashionable medicinal spring, music room and theatre, the last

most notable in its connexion with the names of Joseph Grimaldi the clown and Samuel Phelps. Other institutions are the technical college, Leonard Street, and St Mark's, St Luke's and the Royal chest hospitals. At Mount Pleasant is the parcels department of the general post office, and at Clerkenwell Green the sessions house for the county of London (north side of the Thames). Adjacent to Rosebery Avenue are reservoirs of the New River Head. The municipal borough coincides with the east and central divisions of the parliamentary borough of Finsbury, each returning one member. The borough council consists of a mayor, 9 aldermen and 54 councillors. Area, 589.1 acres.

FINSTERWALDE, a town of Germany, in the kingdom of Prussia, on the Schackebach, a tributary of the Little Elster, 28 m. W.S.W. of Cottbus by rail. Pop. (1905) 10,726. The town has a Gothic church (1581), a château, schools, cloth and cigar factories, iron-foundries, flour and saw mills and factories for machine building. The town, which is first mentioned in 1288, came into the possession of electoral Saxony in 1635 and of Prussia in 1815.

FIORENZO DI LORENZO (c. 1440–1522), Italian painter, of the Umbrian school, lived and worked at Perugia, where most of his authentic works are still preserved in the Pinacoteca. There is probably no other Italian master of importance of whose life and work so little is known. In fact the whole edifice that modern scientific criticism has built around his name is based on a single signed and dated picture (1487) in the Pinacoteca of Perugia—a niche with lunette, two wings and predella—and on the documentary evidence that he was decemvir of that city in 1472, in which year he entered into a contract to paint an altarpiece for Santa Maria Nuova—the pentateuch of the “Madonna and Saints” now in the Pinacoteca. Of his birth and death and pupillage nothing is known, and Vasari does not even mention Fiorenzo's name, though he probably refers to him when he says that Cristofano, Perugino's father, sent his son to be the shop drudge of a painter in Perugia, “who was not particularly distinguished in his calling, but held the art in great veneration and highly honoured the men who excelled therein.” Certain it is that the early works both of Perugino and of Pinturicchio show certain mannerisms which point towards Fiorenzo's influence, if not to his direct teaching. The list of some fifty pictures which modern critics have ascribed to Fiorenzo includes works of such widely varied character that one can hardly be surprised to find great divergence of opinion as regards the masters under whom Fiorenzo is supposed to have studied. Pisanello, Verrocchio, Benozzo Gozzoli, Antonio Pollaiuolo, Benedetto Bonfigli, Mantegna, Squarcione, Filippo Lippi, Signorelli and Ghirlandajo have all been credited with this distinguished pupil, who was the most typical Umbrian painter that stands between the primitives and Perugino; but the probability is that he studied under Bonfigli and was indirectly influenced by Gozzoli. Fiorenzo's authentic works are remarkable for their sense of space and for the expression of that peculiar clear, soft atmosphere which is so marked a feature in the work of Perugino. But Fiorenzo has an intensity of feeling and a power of expressing character which are far removed from the somewhat affected grace of Perugino. Of the forty-five pictures bearing Fiorenzo's name in the Pinacoteca of Perugia, the eight charming St Bernardino panels are so different from his well-authenticated works, so Florentine in conception and movement, that the Perugian's authorship is very questionable. On the other hand the beautiful “Nativity,” the “Adoration of the Magi,” and the “Adoration of the Shepherds” in the same gallery, may be accepted as the work of his hand, as also the fresco of SS. Romano and Rocco at the church of S. Francesco at Deruta. The London National Gallery, the Berlin and the Frankfurt museums contain each a “Madonna and Child” ascribed to the master, but the attribution is in each case open to doubt.

See Jean Carlyle Graham, *The Problem of Fiorenzo di Lorenzo* (Perugia, 1903); Edward Hutton, *The Cities of Umbria* (London). (P. G. K.)

FIORENUOLA D'ARDA, a town of Emilia, Italy, in the province of Piacenza, from which it is 14 m. S.E. by rail, 270 ft. above sea-level. Pop. (1901) 7792. It is traversed by the Via Aemilia, and has a picturesque piazza with an old tower in the centre. The Palazzo Grossi also is a fine building. Alseno lies 4 m. to the S.E., and near it is the Cistercian abbey of Chiaravalle della Colomba, with a fine Gothic church and a large and beautiful cloister (in brick and Verona marble), of the 12th-14th century.

FIORILLO, JOHANN DOMINICUS (1748-1821), German painter and historian of art, was born at Hamburg on the 13th of October 1748. He received his first instructions in art at an academy of painting at Bayreuth; and in 1761, to continue his studies, he went first to Rome, and next to Bologna, where he distinguished himself sufficiently to attain in 1769 admission to the academy. Returning soon after to Germany, he obtained the appointment of historical painter to the court of Brunswick. In 1781 he removed to Göttingen, occupied himself as a drawing-master, and was named in 1784 keeper of the collection of prints at the university library. He was appointed professor extraordinary in the philosophical faculty in 1799, and ordinary professor in 1813. During this period he had made himself known as a writer by the publication of his *Geschichte der zeichnenden Künste*, in 5 vols. (1798-1808). This was followed in 1815 to 1820 by the *Geschichte der zeichnenden Künste in Deutschland und den vereinigten Niederlanden*, in 4 vols. These works, though not attaining to any high mark of literary excellence, are esteemed for the information collected in them, especially on the subject of art in the later middle ages. Fiorillo practised his art almost till his death, but has left no memorable masterpiece. The most noticeable of his painting is perhaps the "Surrender of Briseis." He died at Göttingen on the 10th of September 1821.

FIR, the Scandinavian name originally given to the Scotch pine (*Pinus sylvestris*), but at present not infrequently employed as a general term for the whole of the true conifers (*Abietineae*); in a more exact sense, it has been transferred to the "spruce" and "silver firs," the genera *Picea* and *Abies* of most modern botanists.

The firs are distinguished from the pines and larches by having their needle-like leaves placed singly on the shoots, instead of growing in clusters from a sheath on a dwarf branch. Their cones are composed of thin, rounded, closely imbricated scales, each with a more or less conspicuous bract springing from the base. The trees have usually a straight trunk, and a tendency to a conical or pyramidal growth, throwing out each year a more or less regular whorl of branches from the foot of the leading shoot, while the buds of the lateral boughs extend horizontally.

In the spruce firs (*Picea*), the cones are pendent when mature and their scales persistent; the leaves are arranged all round the shoots, though the lower ones are sometimes directed laterally. In the genus *Abies*, the silver firs, the cones are erect, and their scales drop off when the seed ripens; the leaves spread in distinct rows on each side of the shoot.

The most important of the firs, in an economic sense, is the Norway spruce (*Picea excelsa*), so well known in British plantations, though rarely attaining there the gigantic height and grandeur of form it often displays in its native woods. Under favourable conditions of growth it is a lofty tree, with a nearly straight, tapering trunk, throwing out in somewhat irregular whorls its widespread branches, densely clothed with dark, clear green foliage. The boughs and their side-branches, as they increase in length, have a tendency to droop, the lower tier, even in large trees, often sweeping the ground—a habit that, with the jagged sprays, and broad, shadowy, wave-like foliage-masses, gives a peculiarly graceful and picturesque aspect to the Norway spruce. The slender, sharp, slightly curved leaves are scattered thickly around the shoots; the upper one pressed towards the stem, and the lower directed sideways, so as to give a somewhat flattened appearance to the individual sprays. The elongated cylindrical cones grow chiefly at the ends of the upper branches; they are purplish at first, but become afterwards green, and

eventually light brown; their scales are slightly toothed at the extremity; they ripen in the autumn, but seldom discharge their seeds until the following spring.

The tree is very widely distributed, growing abundantly on most of the mountain ranges of northern and central Europe; while in Asia it occurs at least as far east as the Lena, and in latitude extends from the Altaic ranges to beyond the Arctic circle. On the Swiss Alps it is one of the most prevalent and striking of the forest trees, its dark evergreen foliage often standing out in strong contrast to the snowy ridges and glaciers beyond. In the lower districts of Sweden it is the predominant tree in most of the great forests that spread over so large a portion of that country. In Norway it constitutes a considerable part of the dense woods of the southern dales, flourishing, according to Franz Christian Schübeler, on the mountain slopes up to an altitude of from 2800 to 3100 ft., and clothing the shores of some of the fjords to the water's edge; in the higher regions it is generally mingled with the pine. Less abundant on the western side of the fjelds, it again forms woods in Nordland, extending



FIG. 1.—Norway Spruce (*Picea excelsa*). Male Flowers. A, branch bearing male cones, reduced; B, single male cone, enlarged; C, single stamen, enlarged.

in the neighbourhood of the coast nearly to the 67th parallel; but it is, in that arctic climate, rarely met with at a greater elevation than 800 ft. above the sea, though in Swedish Lapland it is found on the slope of the Sulitelma as high as 1200 ft., its upper limit being everywhere lower than that of the pine. In all the Scandinavian countries it is known as the *Gran* or *Grann*. Great tracts of low country along the southern shores of the Baltic and in northern Russia are covered with forests of spruce. It everywhere shows a preference for a moist but well-drained soil, and never attains its full stature or luxuriance of growth upon arid ground, whether on plain or mountain—a peculiarity that should be remembered by the planter. In a favourable soil and open situation it becomes the tallest and one of the statelyst of European trees, rising sometimes to a height of from 150 to 170 ft., the trunk attaining a diameter of from 5 to 6 ft. at the base. But when it grows in dense woods, where the lower branches decay and drop off early, only a small head of foliage remaining at the tapering summit, its stem, though frequently of great height, is rarely more than 1½ or 2 ft. in thickness. Its growth is rapid, the straight leading shoot, in the vigorous period of the tree, often extending 2½ or even 3 ft. in a single season. In its native habitats it is said to endure for several centuries; but in those countries from which the commercial supply of its timber is chiefly drawn, it attains perfection in from 70 to 90 years, according to soil and situation.

FIR



SILVER FIR (*Abies pectinata*).
A, Cone and foliage.



SPRUCE FIR (*Picea excelsa*)
B, Cone and foliage.



HEMLOCK SPRUCE (*Tsuga canadensis*).
C, Cone, seed and foliage.

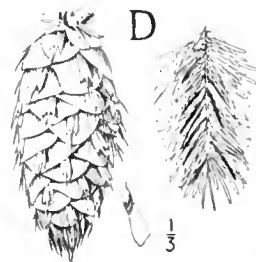
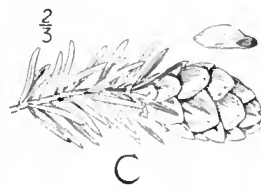

DOUGLAS FIR (*Pseudotsuga Douglasii*).
D, Cone, seed and foliage.

Photos by Henry Irving.

FIR

OTHER
CONIFERS



CYPRESS (*Cupressus sempervirens*).
A, Cone and branchlets.

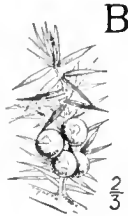
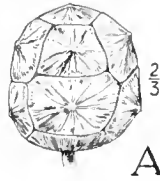

JUNIPER (*Juniperus communis*).
B, Fruit and foliage.



ARAU CARIA (*A. imbricata*, Chile pine or monkey-puzzle).
C, Seed-bearing cone and a single scale with seed.

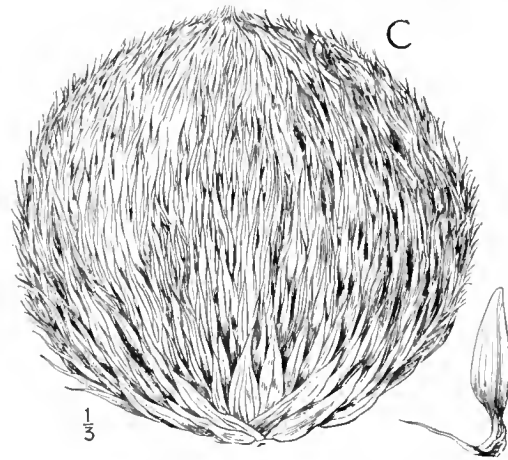

YEW (*Taxus baccata*).
D, Seed and foliage.

In the most prevalent variety of the Norway spruce the wood is white, apt to be very knotty when the tree has grown in an open place, but, as produced in the close northern forests, often of fine and even grain. Immense quantities are imported into Britain from Norway, Sweden and Prussia, under the names of "white Norway," "Christiania" and "Danzig deal." The larger trees are sawn up into planks and battens, much used for the purposes of the builder, especially for flooring, joists and rafters. Where not exposed to the weather the wood is probably as lasting as that of the pine, but, not being so resinous, appears less adapted for out-door uses. Great quantities are sent from Sweden in a manufactured state, in the form of door and window-frames and ready-prepared flooring, and much of the cheap "white deal" furniture is made of this wood. The younger and smaller trees are remarkably durable, especially when the bark is allowed to remain on them; and most of the poles imported into Britain for scaffolding, ladders, mining-timber and similar uses are furnished by this fir. Small masts and spars are often

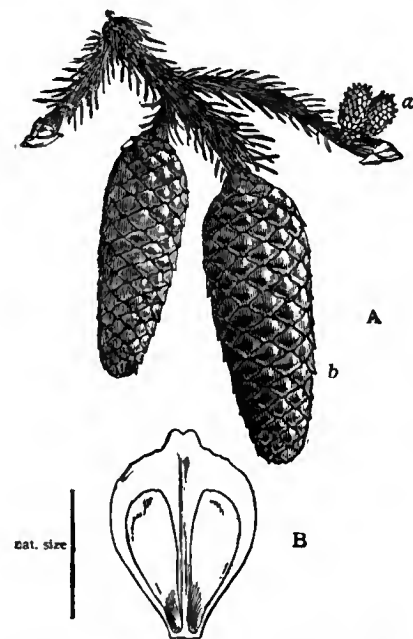

FIG. 2.—Norway Spruce (*Picea excelsa*). Cones; scale with seeds. A, Branch bearing (a) young female cones, (b) ripe cones, reduced. B, Ripe cone scale with seeds, enlarged.

made of it, and are said to be lighter than those of pine. The best poles are obtained in Norway from small, slender, drawn-up trees, growing under the shade of the larger ones in the thick woods, these being freer from knots, and tougher from their slower growth. A variety of the spruce, abounding in some parts of Norway, produces a red heartwood, not easy to distinguish from that of the Norway pine (Scotch fir), and imported with it into England as "red deal" or "pine." This kind is sometimes seen in plantations, where it may be recognized by its shorter, darker leaves and longer

cones. The smaller branches and the waste portion of the trunks, left in cutting up the timber, are exported as fire-wood, or used for splitting into matches. The wood of the spruce is also employed in the manufacture of wood-pulp for paper.

The resinous products of the Norway spruce, though yielded by the tree in less abundance than those furnished by the pine, are of considerable economic value. In Scandinavia a thick turpentine oozes from cracks or fissures in the bark, forming by its congelation a fine yellow resin, known commercially as "spruce rosin," or "frankincense"; it is also procured artificially by cutting off the ends of the lower branches, when it slowly exudes from the extremities. In Switzerland and parts of Germany, where it is collected in some quantity for commerce, a long strip of bark is cut out of the tree near the root; the resin that slowly accumulates during the summer is scraped out in the latter part of the season, and the slit enlarged slightly the following spring to ensure a continuance of the supply. The process is repeated every alternate year, until the tree no longer yields the resin in abundance, which under favourable circumstances it will do for twenty years or more. The quantity obtained from each fir is very variable, depending on the vigour of the tree, and greatly lessens after it has been subjected to the operation for some years. Eventually the tree is destroyed,

and the wood rendered worthless for timber, and of little value even for fuel. From the product so obtained most of the better sort of "Burgundy pitch" of the druggists is prepared. By the peasantry of its native countries the Norway spruce is applied to innumerable purposes of daily life. The bark and young cones afford a tanning material, inferior indeed to oak-bark, and hardly equal to that of the larch, but of value in countries where substances more rich in tannin are not abundant. In Norway the sprays, like those of the juniper, are scattered over the floors of churches and the sitting-rooms of dwelling-houses, as a fragrant and healthful substitute for carpet or matting. The young shoots are also given to oxen in the long winters of those northern latitudes, when other green fodder is hard to obtain. In times of scarcity the Norse peasant-farmer uses the sweetish inner bark, beaten in a mortar and ground in his primitive mill with oats or barley, to eke out a scanty supply of meal, the mixture yielding a tolerably palatable though somewhat resinous substitute for his ordinary *flad-brod*. A decoction of the buds in milk or whey is a common household remedy for scurvy; and the young shoots or green cones form an essential ingredient in the spruce-beer drunk with a similar object, or as an occasional beverage. The well-known "Danzig-spruce" is prepared by adding a decoction of the buds or cones to the wort or saccharine liquor before fermentation. Similar preparations are in use wherever the spruce fir abounds. The wood is burned for fuel, its heat-giving power being reckoned in Germany about one-fourth less than that of beech. From the wide-spreading roots string and ropes are manufactured in Lapland and Bothnia: the longer ones which run near the surface are selected, split through, and then boiled for some hours in a ley of wood-ashes and salt, which, dissolving out the resin, loosens the fibres and renders them easily separable, and ready for twisting into cordage. Light portable boats are sometimes made of very thin boards of fir, sewn together with cord thus manufactured from the roots of the tree.

The Norway spruce seems to have been the "*Picea*" of Pliny, but is evidently often confused by the Latin writers with their "*Abies*," the *Abies pectinata* of modern botanists. From an equally loose application of the word "fir" by our older herbalists, it is difficult to decide upon the date of introduction of this tree into Britain; but it was commonly planted for ornamental purposes in the beginning of the 17th century. In places suited to its growth it seems to flourish nearly as well as in the woods of Norway or Switzerland; but as it needs for its successful cultivation as a timber tree soils that might be turned to agricultural account, it is not so well adapted for economic planting in Britain as the Scotch fir or larch, which come to perfection in more bleak and elevated regions, and on comparatively barren ground, though it may perhaps be grown to advantage on some moist hill-sides and mountain hollows. Its great value to the English forester is as a "nurse" for other trees, for which its dense leafage and tapering form render it admirably fitted, as it protects, without overshadowing, the young saplings, and yields saleable stakes and small poles when cut out. For hop-poles it is not so well adapted as the larch. As a picturesque tree, for park and ornamental plantation, it is among the best of the conifers, its colour and form contrasting yet harmonizing with the olive green and rounded outline of oaks and beeches, or with the red trunk and glaucous foliage of the pine. When young its spreading boughs form good cover for game. The fresh branches, with their thick mat of foliage, are useful to the gardener for sheltering wall-fruit in the spring. In a good soil and position the tree sometimes attains an enormous size: one in Studley Park, Yorkshire, attained nearly 140 ft. in height, and the trunk more than 6 ft. in thickness near the ground. The spruce bears the smoke of great cities better than most of the *Abietineae*; but in suburban localities after a certain age it soon loses its healthy appearance, and is apt to be affected with blight (*Eriosoma*), though not so much as the Scotch fir and most of the pines.

The black spruce (*Picea nigra*) is a tree of more formal growth than the preceding. The branches grow at a more acute angle

and in more regular whorls than those of the Norway spruce; and, though the lower ones become bent to a horizontal position, they do not droop, so that the tree has a much less elegant appearance. The leaves, which grow very thickly all round the stem, are short, nearly quadrangular, and of a dark greyish-green. The cones, produced in great abundance, are short and oval in shape, the scales with rugged indented edges; they are deep purple when young, but become brown as they ripen. The tree also occurs in the New England states and extends over nearly the whole of British North America, its northern limit occurring at about 67° N. lat., often forming a large part of the dense forests, mostly in the swampy districts. A variety with lighter foliage and reddish bark is common in Newfoundland and some districts on the mainland adjacent. The trees usually grow very close together, the slender trunks rising to a great height bare of branches; but they do not attain the size of the Norway spruce, being seldom taller than 60 or 70 ft., with a diameter of 1½ or 2 ft. at the base. This species prefers a peaty soil, and often grows luxuriantly in very moist situations. The wood is strong, light and very elastic, forming an excellent material for small masts and spars, for which purpose the trunks are used in America, and exported largely to England. The sawn timber is inferior to that of *P. excelsa*, besides being of a smaller size. In the countries in which it abounds, the log-houses of the settlers are often built of the long straight trunks. The spruce-beer of America is generally made from the young shoots of this tree. The small twigs, tied in bundles, are boiled for some time in water with broken biscuit or roasted grain; the resulting decoction is then poured into a cask with molasses or maple sugar and a little yeast, and left to ferment. It is often made by the settlers and fishermen of the St Lawrence region, being esteemed as a preventive of scurvy. The American "essence of spruce," occasionally used in England for making spruce-beer, is obtained by boiling the shoots and buds and concentrating the decoction. The resinous products of the tree are of no great value. It was introduced into Britain at the end of the 17th century.

The white spruce (*Picea alba*), sometimes met with in English plantations, is a tree of lighter growth than the black spruce, the branches being more widely apart; the foliage is of a light glaucous green; the small light-brown cones are more slender and tapering than in *P. nigra*, and the scales have even edges. It is of comparatively small size, but is of some importance in the wilds of the Canadian dominion, where it is found to the northern limit of tree-vegetation growing up to at least 69°; the slender trunks yield the only useful timber of some of the more desolate northern regions. In the woods of Canada it occurs frequently mingled with the black spruce and other trees. The fibrous tough roots, softened by soaking in water, and split, are used by the Indians and voyageurs to sew together the birch-bark covering of their canoes; and a resin that exudes from the bark is employed to varnish over the seams. It was introduced to Great Britain at the end of the 17th century and was formerly more extensively planted than at present.

The hemlock spruce (*Tsuga canadensis*) is a large tree, abounding in most of the north-eastern parts of America up to Labrador; in lower Canada, New Brunswick and Nova Scotia it is often the prevailing tree. The short leaves are flat, those above pressed close to the stem, and the others forming two rows; they are of a rather light green tint above, whitish beneath. The cones are very small, ovate and pointed. The large branches droop, like those of the Norway spruce, but the sprays are much lighter and more slender, rendering the tree one of the most elegant of the conifers, especially when young. When old, the branches, broken and bent down by the winter snows, give it a ragged but very picturesque aspect. The trunk is frequently 3 ft. thick near the base. The hemlock prefers rather dry and elevated situations, often forming woods on the declivities of mountains. The timber is very much twisted in grain, and liable to warp and split, but is used for making plasterers' laths and for fencing; "shingles" for roofing are sometimes made of it. The bark, split off in May or June, forms one of the most

valuable tanning substances in Canada. The sprays are sometimes used for making spruce-beer and essence of spruce. It was introduced into Great Britain in about the year 1736.

The Douglas spruce (*Pseudo-tsuga Douglasii*), one of the finest conifers, often rises to a height of 200 ft. and sometimes considerably more, while the gigantic trunk frequently measures 8 or 10 ft. across. The yew-like leaves spread laterally, and are of a deep green tint; the cones are furnished with tridentate bracts that project far beyond the scales. It forms extensive forests in Vancouver Island, British Columbia and Oregon, whence the timber is exported, being highly prized for its strength, durability and even grain, though very heavy; it is of a deep yellow colour, abounding in resin, which oozes from the thick bark. It was introduced into Britain soon after its rediscovery by David Douglas in 1827, and has been widely planted, but does not flourish well where exposed to high winds or in too shallow soil.

Of the *Abies* group, the silver fir (*A. pectinata*), may be taken as the type,—a lofty tree, rivalling the Norway spruce in size, with large spreading horizontal boughs curving upward toward the extremities. The flat leaves are arranged in two regular, distinct rows; they are deep green above, but beneath have two broad white lines, which, as the foliage in large trees has a tendency to curl upwards, give it a silvery appearance from below. The large cones stand erect on the branches, are cylindrical in shape, and have long bracts, the curved points of which project beyond the scales. When the tree is young the bark is of a silvery grey, but gets rough with age. This tree appears to have been the true "Abies" of the Latin writers—the "pulcherrima abies" of Virgil. From early historic times it has been held in high estimation in the south of Europe, being used by the Romans for masts and all purposes for which timber of great length was required. It is abundant in most of the mountain ranges of southern and central Europe, but is not found in the northern parts of that continent. In Asia it occurs on the Caucasus and Ural, and in some parts of the Altaic chain. Extensive woods of this fir exist on the southern Alps, where the tree grows up to nearly 4000 ft.; in the Rhine countries it forms great part of the extensive forest of the Hochwald, and occurs in the Black Forest and in the Vosges; it is plentiful likewise on the Pyrenees and Apennines. The wood is inferior to that of *Picea excelsa*, but, being soft and easily worked, is largely employed in the countries to which it is indigenous for all the purposes of carpentry. Articles of furniture are frequently made of it, and it is in great esteem for carving and for the construction of stringed instruments. Deficient in resin, the wood is more perishable than that of the spruce fir when exposed to the air, though it is said to stand well under water. The bark contains a large amount of a fine, highly-resinous turpentine, which collects in tumours on the trunk during the heat of summer. In the Alps and Vosges this resinous semi-fluid is collected by climbing the trees and pressing out the contents of the natural receptacles of the bark into horn or tin vessels held beneath them. After purification by straining, it is sold as "Strasburg turpentine," much used in the preparation of some of the finer varnishes. Burgundy pitch is also prepared from it by a similar process as that from *Picea excelsa*. A fine oil of turpentine is distilled from the crude material; the residue forms a coarse resin. Introduced into Britain at the beginning of the 17th century, the silver fir has become common there as a planted tree, though, like the Norway spruce, it rarely comes up from seed scattered naturally. There are many fine trees in Scotland; one near Roseneath, figured by Strutt in his *Sylva Britannica*, then measured more than 22 ft. round the trunk. In the more southern parts of the island it often reaches a height of 90 ft., and specimens exist considerably above that size; but the young shoots are apt to be injured in severe winters, and the tree on light soils is also hurt by long droughts, so that it usually presents a ragged appearance; though, in the distance, the lofty top and horizontal boughs sometimes stand out in most picturesque relief above the rounded summits of the neighbouring trees. The silver fir flourishes in a deep loamy soil, and will grow even

upon stiff clay, when well drained—a situation in which few conifers will succeed. On such lands, where otherwise desirable, it may sometimes be planted with profit. The cones do not ripen till the second year.

The silver fir of Canada (*A. balsamea*), a small tree resembling the last species in foliage, furnishes the "Canada balsam"; it abounds in Quebec and the adjacent provinces.

Numerous other firs are common in gardens and shrubberies, and some furnish valuable products in their native countries; but they are not yet of sufficient economic or general interest to demand mention here.

For further information see Veitch's *Manual of Coniferae* (2nd ed., 1900).

FIRDOUSĪ, FIRDAUSĪ or FIRDUSĪ, Persian poet. Abu 'l Kāsim Mansur (or Hasan), who took the *nom de plume* of Firdousī, author of the epic poem the *Shāhnāma*, or "Book of Kings," a complete history of Persia in nearly 60,000 verses, was born at Shadab, a suburb of Tūs, about the year 329 of the Hegira (941 A.D.), or earlier. His father belonged to the class of *Dihkans* (the old native country families and landed proprietors of Persia, who had preserved their influence and status under the Arab rule), and possessed an estate in the neighbourhood of Tūs (in Khorasan). Firdousī's own education eminently qualified him for the gigantic task which he subsequently undertook, for he was profoundly versed in the Arabic language and literature and had also studied deeply the Pahlavi or Old Persian, and was conversant with the ancient historical records which existed in that tongue.

The *Shāhnāma* of Firdousī (see also PERSIA: *Literature*) is perhaps the only example of a poem produced by a single author which at once took its place as the national epic of the people. The nature of the work, the materials from which it was composed, and the circumstances under which it was written are, however, in themselves exceptional, and necessarily tended to this result. The grandeur and antiquity of the empire and the vicissitudes through which it passed, their long series of wars and the magnificent monuments erected by their ancient sovereigns, could not fail to leave numerous traces in the memory of so imaginative a people as the Persians. As early as the 5th century of the Christian era we find mention made of these historical traditions in the work of an Armenian author, Moses of Chorene (according to others, he lived in the 7th or 8th century). During the reign of Chosroes I. (Anushirvan) the contemporary of Mahomet, and by order of that monarch, an attempt had been made to collect, from various parts of the kingdom, all the popular tales and legends relating to the ancient kings, and the results were deposited in the royal library. During the last years of the Sassanid dynasty the work was resumed, the former collection being revised and greatly added to by the Dihkan Danishwer, assisted by several learned mobeds. His work was entitled the *Khoda'ināma*, which in the old dialect also meant the "Book of Kings." On the Arab invasion this work was in great danger of perishing at the hands of the iconoclastic caliph Omar and his generals, but it was fortunately preserved; and we find it in the 2nd century of the Hegira being paraphrased in Arabic by Abdallah ibn el Mokaffā, a learned Persian who had embraced Islam. Other Guebres occupied themselves privately with the collection of these traditions; and, when a prince of Persian origin, Yakūb ibn Laith, founder of the Saffarid dynasty, succeeded in throwing off his allegiance to the caliphate, he at once set about continuing the work of his illustrious predecessors. His "Book of Kings" was completed in the year 260 of the Hegira, and was freely circulated in Khorasan and Irak. Yakūb's family did not continue long in power; but the Samanid princes who succeeded applied themselves zealously to the same work, and Prince Nūh II., who came to the throne in 365 A.H. (A.D. 976), entrusted it to the court poet Dakiki, a Guebre by religion. Dakiki's labours were brought to a sudden stop by his own assassination, and the fall of the Samanid house happened not long after, and their kingdom passed into the hands of the Ghaznevīds. Mahmūd ibn Sabuktāgin, the second of the dynasty (998–1030), continued

to make himself still more independent of the caliphate than his predecessors, and, though a warrior and a fanatical Moslem, extended a generous patronage to Persian literature and learning, and even developed it at the expense of the Arabic institutions. The task of continuing and completing the collection of the ancient historical traditions of the empire especially attracted him. With the assistance of neighbouring princes and of many of the influential Dihkans, Mahmud collected a vast amount of materials for the work, and after having searched in vain for a man of sufficient learning and ability to edit them faithfully, and having entrusted various episodes for versification to the numerous poets whom he had gathered round him, he at length made choice of Firdousī. Firdousī had been always strongly attracted by the ancient Pahlavi records, and had begun at an early age to turn them into Persian epic verse. On hearing of the death of the poet Dakiki, he conceived the ambitious design of himself carrying out the work which the latter had only just commenced; and, although he had not then any introduction to the court, he contrived, thanks to one of his friends, Mahommed Lashkari, to procure a copy of the Dihkan Danishwer's collection, and at the age of thirty-six commenced his great undertaking. Abu Mansur, the governor of Tūs, patronized him and encouraged him by substantial pecuniary support. When Mahmud succeeded to the throne, and evinced such active interest in the work, Firdousī was naturally attracted to the court of Ghazni. At first court jealousies and intrigues prevented Firdousī from being noticed by the sultan; but at length one of his friends, Mahek, undertook to present to Mahmud his poetic version of one of the well-known episodes of the legendary history. Hearing that the poet was born at Tūs, the sultan made him explain the origin of his native town, and was much struck with the intimate knowledge of ancient history which he displayed. Being presented to the seven poets who were then engaged on the projected epic, Abu 'l Kāsim was admitted to their meetings, and on one occasion improvised a verse, at Mahmud's request, in praise of his favourite Ayāz, with such success that the sultan bestowed upon him the name of Firdousī, saying that he had converted his assemblies into paradise (*Firdous*). During the early days of his sojourn at court an incident happened which contributed in no small measure to the realization of his ambition. Three of the seven poets were drinking in a garden when Firdousī approached, and wishing to get rid of him without rudeness, they informed him who they were, and told him that it was their custom to admit none to their society but such as could give proof of poetical talent. To test his acquirements they proposed that each should furnish an extemporary line of verse, his own to be the last, and all four ending in the same rhyme. Firdousī accepted the challenge, and the three poets having previously agreed upon three rhyming words to which a fourth could not be found in the Persian language, 'Ansari began—

"Thy beauty eclipses the light of the sun";

Farrakhi added—

"The rose with thy cheek would comparison shun";

'Asjadi continued—

"Thy glances pierce through the mailed warrior's joshun";¹

and Firdousī, without a moment's hesitation, completed the quatrain—

"Like the lance of fierce Giv in his fight with Poshun."

The poets asked for an explanation of this allusion, and Firdousī recited to them the battle as described in the *Shāhnāma*, and delighted and astonished them with his learning and eloquence.

Mahmud now definitely selected him for the work of compiling and versifying the ancient legends, and bestowed upon him such marks of his favour and munificence as to elicit from the poet an enthusiastic panegyric, which is inserted in the preface of the *Shāhnāma*, and forms a curious contrast to the bitter satire which he subsequently prefixed to the book. The sultan ordered his treasurer, Khojah Hasan Maimandī, to pay to Firdousī a thousand gold pieces for every thousand verses; but the poet preferred allowing the sum to accumulate till the whole was

¹ A sort of cuirass.

finished, with the object of amassing sufficient capital to construct a dike for his native town of Tūs, which suffered greatly from defective irrigation, a project which had been the chief dream of his childhood. Owing to this resolution, and to the jealousy of Hasan Maimandi, who often refused to advance him sufficient for the necessities of life, Firdousī passed the later portion of his life in great privation, though enjoying the royal favour and widely extended fame. Amongst other princes whose liberal presents enabled him to combat his pecuniary difficulties, was one Rustam, son of Fakhr Addaula, the Dailamite, who sent him a thousand gold pieces in acknowledgment of a copy of the episode of Rustam and Isfendiar which Firdousī had sent him, and promised him a gracious reception if he should ever come to his court. As this prince belonged, like Firdousī, to the Shiah sect, while Mahmud and Maimandi were Sunnites, and as he was also politically opposed to the sultan, Hasan Maimandi did not fail to make the most of this incident, and accused the poet of disloyalty to his sovereign and patron, as well as of heresy. Other enemies and rivals also joined in the attack, and for some time Firdousī's position was very precarious, though his pre-eminent talents and obvious fitness for the work prevented him from losing his post. To add to his troubles he had the misfortune to lose his only son at the age of 37.

At length, after thirty-five years' work, the book was completed (1011), and Firdousī entrusted it to Ayāz, the sultan's favourite, for presentation to him. Mahmud ordered Hasan Maimandi to take the poet as much gold as an elephant could carry, but the jealous treasurer persuaded the monarch that it was too generous a reward, and that an elephant's load of silver would be sufficient. 60,000 silver dirhems were accordingly placed in sacks, and taken to Firdousī by Ayāz at the sultan's command, instead of the 60,000 gold pieces, one for each verse, which had been promised. The poet was at that moment in the bath, and seeing the sacks, and believing that they contained the expected gold, received them with great satisfaction, but finding only silver he complained to Ayāz that he had not executed the sultan's order. Ayāz related what had taken place between Mahmud and Hasan Maimandi, and Firdousī in a rage gave 20 thousand pieces to Ayāz himself, the same amount to the bath-keeper, and paid the rest to a beer seller for a glass of beer (*fouka*), sending word back to the sultan that it was not to gain money that he had taken so much trouble. On hearing this message, Mahmud at first reproached Hasan with having caused him to break his word, but the wily treasurer succeeded in turning his master's anger upon Firdousī to such an extent that he threatened that on the morrow he would "cast that Carmathian (heretic) under the feet of his elephants." Being apprised by one of the nobles of the court of what had taken place, Firdousī passed the night in great anxiety; but passing in the morning by the gate that led from his own apartments into the palace, he met the sultan in his private garden, and succeeded by humble apologies in appeasing his wrath. He was, however, far from being appeased himself, and determined at once upon quitting Ghazni. Returning home he tore up the draughts of some thousands of verses which he had composed and threw them in the fire, and repairing to the grand mosque of Ghazni he wrote upon the walls, at the place where the sultan was in the habit of praying, the following lines:—

"The auspicious court of Mahmud, king of Zabulistan, is like a sea. What a sea! One cannot see its shore. If I have dived therein without finding any pearls it is the fault of my star and not of the sea."

He then gave a sealed paper to Ayāz, begging him to hand it to the sultan in a leisure moment after 20 days had elapsed, and set off on his travels with no better equipment than his staff and a dervish's cloak. At the expiration of the 20 days Ayāz gave the paper to the sultan, who on opening it found the celebrated satire which is now always prefixed to copies of the *Shāhnāma*, and which is perhaps one of the bitterest and severest pieces of reproach ever penned. Mahmud, in a violent rage, sent after the poet and promised a large reward for his capture, but he was already in comparative safety. Firdousī directed his

steps to Mazandaran, and took refuge with Kabus, prince of Jorjan, who at first received him with great favour, and promised him his continued protection and patronage; learning, however, the circumstances under which he had left Ghazni, he feared the resentment of so powerful a sovereign as Mahmud, who he knew already coveted his kingdom, and dismissed the poet with a magnificent present. Firdousī next repaired to Bagdad, where he made the acquaintance of a merchant, who introduced him to the vizier of the caliph, al-Qadir, by presenting an Arabic poem which the poet had composed in his honour. The vizier gave Firdousī an apartment near himself, and related to the caliph the manner in which he had been treated at Ghazni. The caliph summoned him into his presence, and was so much pleased with a poem of a thousand couplets, which Firdousī composed in his honour, that he at once received him into favour. The fact of his having devoted his life and talents to chronicling the renown of fire-worshipping Persians was, however, somewhat of a crime in the orthodox caliph's eyes; in order therefore to recover his prestige, Firdousī composed another poem of 9000 couplets on the theme borrowed from the Koran of the loves of Joseph and Potiphar's wife—*Yūsuf and Zuleikha* (edited by H. Ethé, Oxford, 1902; complete metrical translation by Schlechta-Wssehrd, Vienna, 1889). This poem, though rare and little known, is still in existence—the Royal Asiatic Society possessing a copy. But Mahmud had by this time heard of his asylum at the court of the caliph, and wrote a letter menacing his liege lord, and demanding the surrender of the poet. Firdousī, to avoid further troubles, departed for Ahwaz, a province of the Persian Irak, and dedicated his *Yūsuf and Zuleikha* to the governor of that district. Thence he went to Kohistan, where the governor, Nasir Lek, was his intimate and devoted friend, and received him with great ceremony upon the frontier. Firdousī confided to him that he contemplated writing a bitter exposition of his shameful treatment at the hands of the sultan of Ghazni; but Nasir Lek, who was a personal friend of the latter, dissuaded him from his purpose, but himself wrote and remonstrated with Mahmud. Nasir Lek's message and the urgent representations of Firdousī's friends had the desired effect; and Mahmud not only expressed his intention of offering full reparation to the poet, but put his enemy Maimandi to death. The change, however, came too late; Firdousī, now a broken and decrepit old man, had in the meanwhile returned to Tūs, and, while wandering through the streets of his native town, heard a child lisping a verse from his own satire in which he taunts Mahmud with his slavish birth:—

"Had Mahmud's father been what he is now
A crown of gold had decked this aged brow;
Had Mahmud's mother been of gentle blood,
In heaps of silver knee-deep had I stood."

He was so affected by this proof of universal sympathy with his misfortunes that he went home, fell sick and died. He was buried in a garden, but Abu'l Kasim Jurjani, chief sheikh of Tūs, refused to read the usual prayers over his tomb, alleging that he was an infidel, and had devoted his life to the glorification of fire-worshippers and misbelievers. The next night, however, having dreamt that he beheld Firdousī in paradise dressed in the sacred colour, green, and wearing an emerald crown, he reconsidered his determination; and the poet was henceforth held to be perfectly orthodox. He died in the year 411 of the Hegira (1020 A.D.), aged about eighty, eleven years after the completion of his great work. The legend goes that Mahmud had in the meanwhile despatched the promised hundred thousand pieces of gold to Firdousī, with a robe of honour and ample apologies for the past. But as the camels bearing the treasure reached one of the gates of the city, Firdousī's funeral was leaving it by another. His daughter, to whom they brought the sultan's present, refused to receive it; but his aged sister remembering his anxiety for the construction of the stone embankment for the river of Tūs, this work was completed in honour of the poet's memory, and a large caravanserai built with the surplus.

Much of the traditional life, as given above, which is based upon that prefixed to the revised edition of the poem, undertaken by

order of Baisingar Khan, grandson of Timur-i-Leng (Timur), is rejected by modern scholars (see T. Nöldeke, "Das iranische National-epos," in W. Geiger's *Grundriss der iranischen Philologie*, ii. pp. 150-158).

The *Shāhnāma* is based, as we have seen, upon the ancient legends current among the populace of Persia, and collected by the Dihkans, a class of men who had the greatest facilities for this purpose. There is every reason therefore to believe that Firdousi adhered faithfully to these records of antiquity, and that the poem is a perfect storehouse of the genuine traditions of the country.

The entire poem (which only existed in MS. up to the beginning of the 19th century) was published (1831-1868) with a French translation in a magnificent folio edition, at the expense of the French government, by the learned and indefatigable Julius von Mohl. The size and number of the volumes, however, and their great expense, made them difficult of access, and Frau von Mohl published the French translation (1876-1878) with her illustrious husband's critical notes and introduction in a more convenient and cheaper form. Other editions are by Turner Macan (Calcutta, 1829), J. A. Vullers and S. Landauer (unfinished; Leiden, 1877-1883). There is an English abridgment by J. Atkinson (London, 1832; reprinted 1886, 1892); there is a verse-translation, partly rhymed and partly unrhymed, by A. G. and E. Warner (1905 foll.), with an introduction containing an account of Firdousi and the *Shāhnāma*; the version by A. Rogers (1907) contains the greater part of the work. The episode of Sohrab and Rustam is well known to English readers from Matthew Arnold's poem. The only complete translation is *Il Libro dei Re*, by I. Pizzi (8 vols., Turin, 1886-1888), also the author of a history of Persian poetry.

See also E. G. Browne's *Literary History of Persia*, i., ii. (1902-1906); T. Nöldeke (as above) for a full account of the *Shāhnāma*, editions, &c.; and H. Ethé, "Neupersische Litteratur," in the same work. (E. H. P.; X.)

FIRE (in O. Eng. *fȳr*; the word is common to West German languages, cf. Dutch *vuur*, Ger. *Feuer*; the pre-Teutonic form is seen in Sanskrit *pū*, *pāvaka*, and Gr. *πῦρ*; the ultimate origin is usually taken to be a root meaning to purify, cf. Lat. *purus*), the term commonly used for the visible effect of combustion (see FLAME), operating as a heating or lighting agency.

So general is the knowledge of fire and its uses that it is a question whether we have any authentic instance on record of a tribe altogether ignorant of them. A few notices indeed are to be found in the voluminous literature of travel which would decide the question in the affirmative; but when they are carefully investigated, their evidence is found to be far from conclusive. The missionary Krapf was told by a slave of a tribe in the southern part of Shoa who lived like monkeys in the bamboo jungles, and were totally ignorant of fire; but no better authority has been found for the statement, and the story, which seems to be current in eastern Africa, may be nothing else than the propagation of fables about the Pygmies whom the ancients located around the sources of the Nile. Lieut. Charles Wilkes, commander of the United States exploring expedition of 1838-42, says that in Fakaafu or Bowditch Island "there was no sign of places for cooking nor any appearance of fire," and that the natives felt evident alarm at the sparks produced by flint and steel and the smoke emitted by those with cigars in their mouths. The presence of the word *afi*, fire, in the Fakaafu vocabulary supplied by Hale the ethnographer of the expedition, though it might perhaps be explained as equivalent only to solar light and heat, undoubtedly invalidates the supposition of Wilkes; and the Rev. George Turner, in an account of a missionary voyage in 1859, not only repeats the word *afi* in his list for Fakaafu, but relates the native legend about the origin of fire, and describes some peculiar customs connected with its use. Alvaro de Saavedra, an old Spanish traveller, informs us that the inhabitants of Los Jardines, an island of the Pacific, showed great fear when they saw fire—which they did not know before. But that island has not been identified with certainty by modern explorers. It belongs, perhaps, to the Ladrões or Marianas Archipelago, where fire was unknown, says Padre Gobien, "till Magellan, wroth at the pilferings of the inhabitants, burnt one of their villages. When they saw their wooden huts ablaze, their first thought was that fire was a beast which eats up wood. Some of them having approached the fire too near were burnt, and the others kept aloof, fearing to be torn or poisoned by the powerful breath of that terrible animal." To this Freycinet objects that these Ladrone islanders made pottery

before the arrival of Europeans, that they had words expressing the ideas of flame, fire, oven, coals, roasting and cooking. Let us add that in their country numerous graves and ruins have been found, which seem to be remnants of a former culture. Thus the question remains in uncertainty: though there is nothing impossible in the supposition of the existence of a fireless tribe, it cannot be said that such a tribe has been discovered.

It is useless to inquire in what way man first discovered that fire was subject to his control, and could even be called into being by appropriate means. With the natural phenomenon and its various aspects he must soon have become familiar. The volcano lit up the darkness of night and sent its ashes or its lava down into the plains; the lightning or the meteor struck the tree, and the forest was ablaze; or some less obvious cause produced some less extensive ignition. For a time it is possible that the grand manifestations of nature aroused no feelings save awe and terror; but man is quite as much endowed with curiosity as with reverence or caution, and familiarity must ere long have bred confidence if not contempt. It is by no means necessary to suppose that the practical discovery of fire was made only at one given spot and in one given way; it is much more probable indeed that different tribes and races obtained the knowledge in a variety of ways.

It has been asserted of many tribes that they would be unable to rekindle their fires if they were allowed to die out. Travellers in Australia and Tasmania depict the typical native woman bearing always about with her a burning brand, which it is one of her principal duties to protect and foster; and it has been supposed that it was only ignorance which imposed on her the endless task. This is absurd. The Australian methods of producing fire by the friction of two pieces of wood are perfectly well known, and are illustrated in Howitt's *Native Tribes of South-East Australia*, pp. 771-773. To carry a brand saves a little trouble to the men.

The methods employed for producing fire vary considerably in detail, but are for the most part merely modified applications of concussion or friction. Lord Avebury has remarked that the working up of stone into implements must have been followed sooner or later by the discovery of fire; for in the process of chipping sparks were elicited, and in the process of polishing heat was generated. The first or concussion method is still familiar in the flint and steel, which has hardly passed out of use even in the most civilized countries. Its modifications are comparatively few and unimportant. The Alaskans and Aleutians take two pieces of quartz, rub them well with native sulphur, strike them together till the sulphur catches fire, and then transfer the flame to a heap of dry grass over which a few feathers have been scattered. Instead of two pieces of quartz the Eskimos use a piece of quartz and a piece of iron pyrites. Mr Frederick Boyle saw fire produced by striking broken china violently against a bamboo, and Bastian observed the same process in Burma, and Wallace in Ternate. In Cochin China two pieces of bamboo are considered sufficient, the silicious character of the outside layer rendering it as good as native flint. The friction methods are more various. One of the simplest is what E. B. Tylor calls the stick and groove—"a blunt pointed stick being run along a groove of its own making in a piece of wood lying on the ground." Much, of course, depends on the quality of the woods and the expertness of the manipulator. In Tahiti Charles Darwin saw a native produce fire in a few seconds, but only succeeded himself after much labour. The same device was employed in New Zealand, the Sandwich Islands, Tonga, Samoa and the Radak Islands. Instead of rubbing the movable stick backwards and forwards other tribes make it rotate rapidly in a round hole in the stationary piece of wood—thus making what Tylor has happily designated a fire-drill. This device has been observed in Australia, Kamchatka, Sumatra and the Carolines, among the Veddahs of Ceylon, throughout a great part of southern Africa, among the Eskimo and Indian tribes of North America, in the West Indies, in Central America, and as far south as the Straits of Magellan. It was also employed by the ancient Mexicans, and

Tylor gives a quaint picture of the operation from a Mexican MS.—a man half kneeling on the ground is causing the stick to rotate between the palms of his hands. This simple method of rotation seems to be very generally in use; but various devices have been resorted to for the purpose of diminishing the labour and hastening the result. The Gaucho of the Pampas takes "an elastic stick about 18 in. long, presses one end to his breast and the other in a hole in a piece of wood, and then rapidly turns the curved part like a carpenter's centre-bit." In other cases the rotation is effected by means of a cord or thong wound round the drill and pulled alternately by this end and that. In order to steady the drill the Eskimo and others put the upper end in a socket of ivory or bone which they hold firmly in their mouth. A further advance was made by the Eskimo and neighbouring tribes, who applied the principle of the bow-drill; and the still more ingenious pump-drill was used by the Onondaga Indians. For full descriptions of these instruments and a rich variety of details connected with fire-making we must refer the reader to Tylor's valuable chapter in his *Researches*. These methods of producing fire are but rarely used in Europe, and only in connexion with superstitious observances. We read in Wuttke that some time ago the authorities of a Mecklenburg village ordered a "wild fire" to be lit against a murrain amongst the cattle. For two hours the men strove vainly to obtain a spark, but the fault was not to be ascribed to the quality of the wood, or to the dampness of the atmosphere, but to the stubbornness of an old lady, who, objecting to the superstition, would not put out her night lamp; such a fire, to be efficient, must burn alone. At last the strong-minded female was compelled to give in; fire was obtained—but of bad quality, for it did not stop the murrain.

It has long been known that the rays of the sun might be concentrated by a lens or concave mirror. Aristophanes mentions the burning-lens in *The Clouds*, and the story of Archimedes using a mirror to fire the ships at Syracuse is familiar to every schoolboy. If Garcilasso de la Vega can be trusted as an authority the Virgins of the Sun in Peru kindled the sacred fire with a concave cup set in a great bracelet. In China the burning-glass is in common use.

To the inquiry how mankind became possessed of fire, the cosmogonies, those records of pristine speculative thought, do not give any reply which would not be found in the relations of travellers and historians.

They say in the Tonga Islands that the god of the earthquakes is likewise the god of fire. At Mangaia it is told that the great Maui went down to hell, where he surprised the secret of making fire by rubbing two pieces of wood together. The Maoris tell the tale differently. Maui had the fire given to him by his old blind grandmother, Mahuika, who drew it from the nails of her hands. Wishing to have a stronger one, he pretended that it had gone out, and so he obtained fire from her great toe. It was so fierce that every thing melted before the glow; even Maui and the grandmother herself were already burning when a deluge, sent from heaven, saved the hero and the perishing world; but before the waters extinguished all the blaze, Mahuika shut a few sparks into some trees, and thence men draw it now. The Maoris have also the legend that thunder is the noise of Tawhaki's footsteps, and that lightnings flash from his armpits. At Western Point, Victoria, the Australians say the good old man Pundyl opened the door of the sun, whose light poured then on earth, and that Karakorok, the good man's good daughter, seeing the earth to be full of serpents, went everywhere destroying serpents; but before she had killed them all, her staff snapped in two, and while it broke, a flame burst out of it. Here the serpent-killer is a fire-bringer. In the Persian *Shahnama* also fire was discovered by a dragon-fighter. Hushenk, the powerful hero, hurled at the monster a prodigious stone, which, evaded by the snake, struck a rock and was splintered by it. "Light shone from the dark pebble, the heart of the rock flashed out in glory, and fire was seen for the first time in the world." The snake escaped, but the mystery of fire had been revealed.

North American legends narrate how the great buffalo, careering through the plains, makes sparks flit in the night, and sets the prairie ablaze by his hoofs hitting the rocks. We meet the same idea in the Hindu mythology, which conceives thunder to have been, among many other things, the clatter of the solar horses on the Akmon or hard pavement of the sky. The Dakotas claim that their ancestor obtained fire from the sparks which a friendly panther struck with its claws, as it scampered upon a stony hill.

Tohil, who gave the Quiches fire by shaking his sandals, was,

like the Mexican Quetzalcoatl, represented by a flint stone. Guamansuri, the father of the Peruvians, produced the thunder and the lightning by hurling stones with his sling. The thunderbolts are his children. Kudai, the great god of the Altaian Tartars, disclosed "the secret of the stone's edge and the iron's hardness." The Slavonian god of thunder was depicted with a silex in his hand, or even protruding from his head. The Lapp Tiermes struck with his hammer upon his own head; the Scandinavian Thor held a mallet in one hand, a flint in the other. Taranis, the Gaul, had upon his head a huge mace surrounded by six little ones. Finnish poems describe how "fire, the child of the sun, came down from heaven, where it was rocked in a tub of yellow copper, in a large pail of gold." Ukko, the Esthonian god, sends forth lightnings, as he strikes his stone with his steel. According to the Kalewala, the same mighty Ukko struck his sword against his nail, and from the nail issued the "fiery babe." He gave it to the Wind's daughter to rock it, but the unwary maiden let it fall in the sea, where it was swallowed by the great pike, and fire would have been lost for ever if the child of the sun had not come to the rescue. He dragged the great pike from the water, drew out his entrails, and found there the heavenly spark still alive. Prometheus brought to earth the torch he had lighted at the sun's chariot.

Human culture may be said to have begun with fire, of which the uses increased in the same ratio as culture itself. To save the labour expended on the initial process of procuring light, or on carrying it about constantly, primitive men hit on the expedient of a fire, which should burn night and day in a public building. The Egyptians had one in every temple, the Greeks, Latins and Persians in all towns and villages. The Natchez, the Aztecs, the Mayas, the Peruvians had their "national fires" burning upon large pyramids. Of these fires the "eternal lamps" in the synagogues, in the Byzantine and Catholic churches, may be a survival. The "Regia," Rome's sacred centre, supposed to be the abode of Vesta, stood close to a fountain; it was convenient to draw from the same spot the two great requisites, fire and water. All civil and political interests grouped themselves around the prytaneum which was at once a temple, a tribunal, a town-hall, and a gossiping resort: all public business and most private affairs were transacted by the light and in the warmth of the common fire. No wonder that its flagstones should become sacred. Primitive communities consider as holy everything that ensures their existence and promotes their welfare, material things such as fire and water not less than others. Thus the prytaneum grew into a religious institution. And if we hear a little more of fire worship than of water worship, it is because fire, being on the whole more difficult to obtain, was esteemed more precious. The prytaneum and the state were convertible terms. If by chance the fire in the Roman temple of Vesta was extinguished, all tribunals, all authority, all public or private business had to stop immediately. The connexion between heaven and earth had been broken, and it had to be restored in some way or other—either by Jove sending down divine lightning on his altars, or by the priests making a new fire by the old sacred method of rubbing two pieces of wood together, or by catching the rays of the sun in a concave mirror. No Greek or Roman army crossed the frontier without carrying an altar where the fire taken from the prytaneum burned night and day. When the Greeks sent out colonies the emigrants took with them living coals from the altar of Hestia, and had in their new country a fire lit as a representative of that burning in the mother country.¹ Not before the three curiae united their fires into one could Rome become powerful; and

¹ Curiously enough we see the same institution obtaining among the Damaras of South Africa, where the chiefs, who sway their people with a sort of priestly authority, commit to their daughters the care of a so-called eternal fire. From its hearth younger scions separating from the parent stock take away a burning brand to their new home. The use of a common prytaneum, of circular form, like the Roman temple of Vesta, testified to the common origin of the North American Assinai and Maichas. The Mobiles, the Chippewas, the Natchez, had each a corporation of Vestals. If the Natchez let their fire die out, they were bound to renew it from the Mobiles. The Moquis, Pueblos and Comanches had also their perpetual fires. The Redskins discussed important affairs of state at the "council fires," around which each *sachem* marched three times, turning to it all the sides of his person. "It was a saying among our ancestors," said an Iroquois chief in 1753, "that when the fire goes out at Onondaga—the Delphi of the league—we shall no longer be a people."

Athens became a shining light to the world only, we are told, when the twelve tribes of Attica, led by Theseus, brought each its brand to the altar of Athene Polias. All Greece confederated, making Delphi its central hearth; and the islands congregated around Delos, whence the new fire was fetched every year.

Periodic Fires.—Because the sun loses its force after noon, and after midsummer daily shortens the length of its circuit, the ancients inferred, and primitive populations still believe, that, as time goes on, the energies of fire must necessarily decline. Therefore men set about renewing the fires in the temples and on the hearth on the longest day of summer or at the beginning of the agricultural year. The ceremony was attended with much rejoicing, banqueting and many religious rites. Houses were thoroughly cleansed; people bathed, and underwent lustrations and purifications; new clothes were put on; quarrels were made up; debts were paid by the debtor or remitted by the creditor; criminals were released by the civil authorities in imitation of the heavenly judges, who were believed to grant on the same day a general remission of sins. All things were made new; each man turned over a new page in the book of his existence. Some nations, like the Etruscans in the Old World and the Peruvians and Mexicans in the New, carried these ideas to a high degree of development, and celebrated with magnificent ceremonies the renewal of the *saccula*, or astronomic periods, which might be shorter or longer than a century. Some details of the festival among the Aztecs have been preserved. On the last night of every period (52 years) every fire was extinguished, and men proceeded in solemn procession to some sacred spot, where, with awe and trembling, the priests strove to kindle a new fire by friction. It was as if they had a vague idea that the cosmos, with its sun, moon and stars, had been wound up like a clock for a definite period of time. And had they failed to raise the vital spark, they would have believed that it was because the great fire was being extinguished at the central hearth of the world. The Stoics and many other ancient philosophers thought that the world was doomed to final extinction by fire. The Scandinavian bards sung the end of the world, how at last the wolf Fenrir would get loose, how the cruel fire of Loki would destroy itself by destroying everything. The Essenes enlarged upon this doctrine, which is also found in the Sibylline books and appears in the Apocrypha (2 Esdras xvi. 15).

See Dupuis, *Origine de tous les cultes* (1794); Burnouf, *Science des religions*; Grimm, *Deutsche Mythologie*, cap. xx. (1835); Adalbert Kuhn, *Die Herabkunft des Feuers und des Göttertranks* (1859); Steinthal, *Über die ursprüngliche Form der Sage von Prometheus* (1861); Albert Reville, "Le Mythe de Prométhée," in *Revue des deux mondes* (August 1862); Michel Bréal, *Hercule et Cacus* (1863); Tylor, *Researches into the Early History of Mankind*, ch. ix. (1865); Bachofen, *Die Sage von Tanaquil* (1870); Lord Avebury, *Prehistoric Times* (6th ed., 1900); Haug, *Religion of the Parsis* (1878). (E. R.)

FIRE AND FIRE EXTINCTION. Fire is considered in this article, primarily, from the point of view of the protection against fire that can be accorded by preventive measures and by the organization of fire extinguishing establishments.

History is full of accounts of devastation caused by fires in towns and cities of nearly every country in the civilized world. The following is a list of notable fires of early days:—

GREAT BRITAIN AND IRELAND

798. *London*, nearly destroyed.
982. " greater part of the city burned.
1086. " all houses and churches from the east to the west gate burned.
1212. " greater part of the city burned.
1666. " The Great Fire," September 2-6.
It began in a wooden house in Pudding Lane, and burned for three days, consuming the buildings on 436 acres, 400 streets, lanes, &c., 13,200 houses, with St Paul's church, 86 parish churches, 6 chapels, the guild-hall, the royal exchange, the custom-house, many hospitals and libraries, 52 companies' halls, and a vast number of other stately edifices, together with three of the city gates, four stone bridges, and the prisons of Newgate, the Fleet, and the Poultry and Wood Street Compters. The fire swept from the Tower to Temple church, and from the N.E. gate to Holborn bridge. Six persons were killed. The total loss of property was estimated at the time to be £10,730,500.

1794. *London*, 630 houses destroyed at Wapping. Loss above £1,000,000.
1834. " Houses of Parliament burned.
1861. " Tooley Street wharves, &c., burned. Loss estimated at £2,000,000.
1873. " Alexandra palace destroyed.
1137. *York*, totally destroyed.
1184. *Glastonbury*, town and abbey burned.
1292. *Carlisle*, destroyed.
1507. *Norwich*, nearly destroyed; 718 houses burned.
1544. *Leith*, burned.
1598. *Tiverton*, 400 houses and a large number of horses burned; 33 persons killed. Loss, £150,000.
1612. " 600 houses burned. Loss over £200,000.
1731. " 300 houses burned.
1700. *Edinburgh*, "the Great Fire."
1612. *Cork*, greater part burned, and again in 1622.
1613. *Dorchester*, nearly destroyed. Loss, £200,000.
1614. *Stratford-on-Avon*, burned.
1644. *Beaminster*, burned. Again in 1684 and 1781.
1675. *Northampton*, almost totally destroyed.
1683. *Newmarket*, large part of the town burned.
1694. *Warwick*, more than half burned; rebuilt by national contribution.
1707. *Lisburn*, burned.
1727. *Gravesend*, destroyed.
1738. *Wellingborough*, 800 houses burned.
1743. *Crediton*, 450 houses destroyed.
1760. *Portsmouth*, dockyard burned. Loss, £400,000.
1770. " " " Loss, £100,000.
1802. *Liverpool*, destructive fire. Loss, £1,000,000.
1827. *Sheerness*, 50 houses and much property destroyed.
1854. *Gateshead*, 50 persons killed. Loss, £1,000,000.
1875. *Glasgow*. Great fire. Loss, £300,000.

FRANCE

59. *Lyons*, burned to ashes. Nero offers to rebuild it.
1118. *Nantes*, greater part of the city destroyed.
1137. *Dijon*, burned.
1524. *Troyes*, nearly destroyed.
1720. *Rennes*, on fire from December 22 to 29. 850 houses burned.
1784. *Brest*. Fire and explosion in dockyard. Loss, £1,000,000.
1862. *Marseilles*, destructive fire.
1871. *Paris*. Communist devastations. Property destroyed, £32,000,000.

CENTRAL AND SOUTHERN EUROPE

64. *Rome* burned during 8 days. 10 of the 14 wards of the city were destroyed.
1106. *Venice*, greater part of the city was burned.
1577. " fire at the arsenal, greater part of the city ruined by an explosion.
1299. *Weimar*, destructive fire; also in 1424 and 1618.
1379. *Memel* was in large part destroyed, and again in 1457, 1540, 1678, 1854.
1495. *Bern* was destroyed.
1420. *Leipzig* lost 400 houses.
1457. *Dort*, cathedral and large part of the town burned.
1491. *Dresden* was destroyed.
1521. *Oviedo*, large part of the city destroyed.
1543. *Komorn* was burned.
1634. *Fürth* was burned by Austrian Croats.
1680. *Fürth* was again destroyed.
1686. *Landau* was almost destroyed.
1758. *Pirna* was burned by Prussians. 260 houses destroyed.
1762. *Munich* lost 200 houses.
1764. *Königsberg*, public buildings, &c., burned. Loss, £600,000.
1769. " almost destroyed.
1784. *Rokitzan* (Bohemia) was totally destroyed. Loss, £300,000.
1801. *Brody*, 1500 houses destroyed.
1859. " 1000 houses destroyed.
1803. *Posen*, large part of older portion of city burned.
1811. Forest fires in Tyrol destroyed 64 villages and hamlets.
1818. *Salzburg* was partly destroyed.
1842. *Hamburg*. A fire raged for 100 hours, May 5-7.
During the fire the city was in a state of anarchy. 4219 buildings, including 2000 dwellings, were destroyed. One-fifth of the population was made homeless, and 100 persons lost their lives. The total loss amounted to £7,000,000. After the fire, contributions from all Germany came in to help to rebuild the city.
1861. *Glarus* (Switzerland), 500 houses burned.

NORTHERN EUROPE

1530. *Aalborg*, almost entirely destroyed.
1541. *Aarhus*, almost entirely destroyed, and again in 1556.
1624. *Opсло*, nearly destroyed. Christiania was built on the site.
1702. *Bergen*, greater part of the town destroyed.
1728. *Copenhagen*, nearly destroyed. 1650 houses burned, 77 streets.
1794. " royal palace with contents burned.
1795. " 50 streets, 1563 houses burned.

1751. *Stockholm*, 1000 houses destroyed.
 1759. " 250 houses burned. Loss, 2,000,000 crowns.
 1775. *Abo*, 200 houses and 15 mills burned.
 1827. " 780 houses burned, with the university.
 1790. *Carlsrona*, 1087 houses, churches, warehouses, &c., destroyed.
 1802. *Gothenburg*, 178 houses burned.
 1858. *Christiania*. Loss estimated at £250,000.
 1865. *Carlstadt* (Sweden), everything burned except the bishop's residence, hospital and jail. 10 lives lost.

RUSSIA

1736. *St Petersburg*, 2000 houses burned.
 1862. " great fire. Loss, £1,000,000.
 1752. *Moscow*, 18,000 houses burned.
 1812. " The Russians fired the city on September 14 to drive out the army of Napoleon. The fire continued five days. Nine-tenths of the city was destroyed. Number of houses burned, 30,800. Loss, £30,000,000.
 1753. *Archangel*, 900 houses burned.
 1793. " 3000 buildings and the cathedral burned.
 1786. *Tobolsk*, nearly destroyed.
 1788. *Mitau*, nearly destroyed.
 1812. *Riga*, partly destroyed.
 1834. *Tula*, destructive fire.
 1848. *Orel*, large part of the town destroyed.
 1850. *Cracow*, large part of the town burned.
 1864. *Novgorod*, large amount of property destroyed.

TURKEY

- The following fires have occurred at *Constantinople*:—
 1729. A great fire destroyed 12,000 houses and 7000 people.
 1745. A fire lasted five days.
 1750. In January, 10,000 houses burned; in April, property destroyed estimated from £1,000,000 to £3,000,000. Later in the year 10,000 houses were destroyed.
 1751. 4000 houses were burned.
 1756. 15,000 houses and 100 people destroyed. During the years 1761, 1765 and 1767 great havoc was made by fire.
 1769. July 17. A fire raged for twelve hours, extending nearly 1 m. in length. Many of the palaces, some small mosques and nearly 650 houses were destroyed.
 1771. A fire lasting 15 hours consumed 2500 houses and shops.
 1778. 2000 houses were burned.
 1782. August 12. A fire burned three days: 10,000 houses, 50 mosques and 100 corn mills destroyed; 100 lives lost. In February, 600 houses burned; in June, 7000 more.
 1784. August 5. A fire burned for 26 hours and destroyed 10,000 houses, most of which had been rebuilt since the fires of 1782. In the same year, March 13, a fire in the suburb of Pera destroyed two-thirds of that quarter. Loss estimated at 2,000,000 florins.
 1791. Between March and July 32,000 houses are said to have been burned, and as many in 1795.
 1799. In the suburb of Pera 13,000 houses were burned and many magnificent buildings.
 1816. August 16. 12,000 houses and 3000 shops in the finest quarter were destroyed.
 1818. August 13. A fire destroyed several thousand houses.
 1826. A fire destroyed 6000 houses.
 1848. 500 houses and 2000 shops destroyed. Loss estimated at £3,000,000.
 1865. A great fire destroyed 2800 houses, public buildings, &c. Over 22,000 people were left homeless.
 1870. June 5. The suburb of Pera, occupied by the foreign population and native Christians, was swept by a fire which destroyed over 7000 buildings, many of them among the best in the city, including the residence of the foreign legations. Loss estimated at nearly £5,000,000.
 1797. *Sculari*, the town of 3000 houses totally destroyed.
 1763. *Smyrna*, 2600 houses consumed. Loss, £200,000.
 1772. " 3000 dwellings burned. 3000 to 4000 shops, &c. consumed. Loss, £4,000,000.
 1796. " 4000 shops, mosques, magazines, &c., burned.
 1841. " 12,000 houses were burned.

INDIA

1631. *Rajmahal*. Palace and great part of the town burned.
 1799. *Manilla*, vast storehouses were burned.
 1833. " 10,000 huts were burned, March 26. 30,000 people rendered homeless, and 50 lives lost.
 1803. *Madras*, more than 1000 houses burned.
 1803. *Bombay*. Loss by fire of £600,000.

CHINA AND JAPAN

1822. *Canton* was nearly destroyed by fire.
 1866. *Yokohama*, two-thirds of the native town and one-sixth of the foreign settlement destroyed.
 1872. *Yeddo*. A fire occurred in April during a gale of wind, destroying buildings covering a space of 6 sq. m. 20,000 persons were made homeless.
 1873. " A fire destroyed 10,000 houses.

UNITED STATES

1679. *Boston*. All the warehouses, 80 dwellings, and the vessels in the dockyards were consumed. Loss, £200,000.
 1760. " A fire caused a loss estimated at £100,000.
 1787. " A fire consumed 100 buildings, February 20.
 1794. " 96 buildings were burned. Loss, £42,000.
 1872. " Great fire, November 9-10. By this fire the richest quarter of Boston was destroyed.
 The fire commenced at the corner of Summer and Kingston streets. The area burned over was 65 acres. 776 buildings, comprising the largest granite and brick warehouses of the city, filled with merchandise, were burned. The loss was about £15,000,000. Before the end of the year 1876 the burned district had been rebuilt more substantially than ever.
 1778. *Charleston* (S.C.). A fire caused the loss of £100,000.
 1796. " 300 houses were burned.
 1838. " One-half the city was burned on April 27. 1158 buildings destroyed. Loss, £600,000.
 1802. *Portsmouth* (N.H.), 102 buildings destroyed.
 1813. " 397 buildings destroyed.
 1820. *Savannah*, 463 buildings were burned. Loss, £800,000.
 1835. *New York*. The great fire of New York began in Merchant Street, December 16, and burned 530 buildings in the business part of the city. 1000 mercantile firms lost their places of business. The area burned over was 52 acres. The loss was £3,000,000.
 1845. " A fire in the business part of the city, July 20, destroyed 300 buildings. The loss was £1,500,000. 35 persons were killed.
 1845. *Pittsburg*. A large part of the city burned, April 11. 20 squares, 1100 buildings destroyed. Loss, £2,000,000.
 1846. *Nantucket* was almost destroyed.
 1848. *Albany*. 600 houses burned, August 17. Area burned over 37 acres, one-third of the city. Loss, £600,000.
 1849. *St Louis*. 23 steamboats at the wharves, and the whole or part of 15 blocks of the city burned, May 17. Loss, £600,000.
 1851. " More than three-quarters of the city was burned, May 4. 2500 buildings. Loss, £2,200,000.
 1851. " 500 buildings burned. Loss, £600,000.
 1850. *Philadelphia*. 400 buildings burned, July 9. 30 lives lost. Loss, £200,000.
 1865. " 50 buildings burned, February 8. 20 persons killed. Loss, £100,000.
 1851. *Washington*. Part of the Capitol and the whole of the Congressional Library were burned.
 1851. *San Francisco*. On May 4-5 a fire destroyed 2500 buildings. A number of lives lost. More than three-fourths of the city destroyed. Loss, upwards of £2,000,000. In June another fire burned 500 buildings. Loss estimated at £600,000.
 1857. *Chicago*. A fire destroyed over £100,000. 14 lives lost.
 1859. " Property destroyed worth £100,000, Sept. 15.
 1866. " Two fires on August 10 and November 18. Loss, £100,000 each.
 1871. " The greatest fire of modern times.
 It began in a barn on the night of the 8th of October and raged until the 10th. The area burned over was 2124 acres, or 3½ sq. m., of the very heart of the city. 250 lives were lost, 98,500 persons were made homeless, and 17,430 buildings were consumed. The buildings were one-third in number and one-half in value of the buildings of the city. Before the end of 1875 the whole burned district had been rebuilt. The loss was estimated at £39,000,000.
 1862. *Troy* (N.Y.) was nearly destroyed by fire.
 1866. *Portland* (Maine). Great fire on July 4. One-half of the city was burned; 200 acres were ravaged; 50 buildings were blown up to stop the progress of the fire. Loss, £2,000,000 to £2,250,000.
 1871. October. Forest and prairie fires in Wisconsin and Michigan. 15,000 persons were made homeless; 1000 lives lost. Loss estimated at £600,000.

BRITISH NORTH AMERICA

1815. *Quebec* was injured to the extent of £260,000.
 1845. " 1650 houses were burned, May 28. One-third of the population made homeless. Loss from £400,000 to £750,000. Another fire, on June 28, consumed 1300 dwellings. 6000 persons were made homeless. 30 streets destroyed. Insurance losses, £60,770.
 1866. " 2500 houses and 17 churches in French quarter burned.
 1825. *New Brunswick*. A tract of 4,000,000 acres, more than 100 m. in length, was burned over; it included many towns. 160 persons killed, and 875 head of cattle. 590 buildings burned. Loss, about £60,000. Towns of New-castle, Chatham and Douglstown destroyed.
 1837. *St John* (New Brunswick). 115 houses burned, January 13, and nearly all the business part of the city. Loss, £1,000,000.

- 1877. *St. John.* Great fire on June 21. The area burned over was 200 acres. 37 streets and squares totally or in part destroyed; 10 m. of streets; 1650 dwellings. 18 lives lost. Total loss, £2,500,000. Two-fifths of the city burned.
- 1846. *St. John's* (Newfoundland) was nearly destroyed, June 9. Two whole streets burned upwards of 1 m. long. Loss estimated at £1,000,000.
- 1850. *Montreal.* A fire destroyed the finest part of the city on June 7. 200 houses were burned.
- 1852. " A fire on July 9 rendered 10,000 people destitute. The space burned was 1 m. in length by $\frac{1}{2}$ m. in width, including 1200 houses. Loss, £1,000,000.

SOUTH AMERICA

- 1536. *Cuzco* was nearly consumed.
- 1861. *Mendoza.* A great fire followed an earthquake which had destroyed 10,000 people.
- 1862. *Valparaiso* was devastated by fire.
- 1863. *Santiago.* Fire in the Jesuit church; 2000 persons, mostly women and children, perished.

WEST INDIES

- 1752. *Pierre* (Martinique) had 700 houses burned.
- 1782. *Kingston* (Jamaica) had 80 houses burned. Loss, £500,000.
- 1795. *Montego Bay* (Jamaica). Loss by fire of £400,000.
- 1805. *St. Thomas.* 900 warehouses consumed. Loss, £6,000,000.
- 1808. *Spanish Town* (Trinidad) was totally destroyed. Loss estimated at £1,500,000.
- 1828. *Havana* lost 350 houses; 2000 persons reduced to poverty.
- 1843. *Port Republicain* (Haiti). Nearly one-third of the town was burned.

Since this list was compiled, there have been further notable fires, more particularly in North America, the great conflagrations at Chicago, Baltimore and San Francisco being terrible examples. But speaking generally, these conflagrations, extensive as they were, only repeated the earlier lessons as to the necessity of combating the general negligence of the public by attaching far greater importance to the development of fire-preventive measures even than to the better organization of the fire-fighting establishments.

It may be of interest to mention notable fires in the British empire, and London in particular, during the decade 1890 to 1899:—

Port of Spain (Trinidad)	March 4, 1895
New Westminster (British Columbia)	Sept. 10, 1898
Toronto (Ontario)	Jan. 6, 10, and March 3, 1895
Windsor (Nova Scotia)	Oct. 17, 1897
St John's (Newfoundland)	July 8, 1892
London—Charterhouse Square	Dec. 25, 1889
" St Mary Axe	July 18, 1893
" Old Bailey and Fleet Street	Nov. 15, 1893
" Tabernacle Street, Finsbury	June 21, 1894
" Bermondsey Leather Market	Sept. 13, 1894
" " "	May 17, 1895
" Minories	Nov. 10, 1894
" South-West India Docks	Feb. 8, 1895
" Charlotte and Leonard Streets, Finsbury	June 10, 1896
" Cripplegate	Nov. 19, 1897
Nottingham	Nov. 17, 1894
Sheffield	Dec. 21, 1893
Bradford	Nov. 30, 1896
Sunderland	July 18, 1898
Dublin	May 4, 1894
Glasgow—Anderston Quay	Jan. 16, 1897
" Dunlop Street	April 25, 1898

As to fires in any one specific class of building, the extraordinary number of fires that occurred in theatres and similar places of public entertainment up to the close of the 19th century calls for mention. Since that time, however, there has been a considerable abatement in this respect, owing to the adoption of successful measures of fire prevention. A list of some 1100 fires was published by Edwin O. Sachs in 1897 (*Fires at Public Entertainments*), and the results of these fires analysed. They involved a recorded loss of life to the extent of 9350 souls. About half of them (584) occurred in Europe, and the remainder in other parts of the world. Since the publication of that list extraordinary efforts have been made in all countries to reduce the risk of fires in public entertainments. The only notable disaster that has occurred since was that at the Iroquois Theatre at Chicago.

The annual drain in loss of life and in property through fires is far greater than is generally realized, and although the loss of life and property is being materially reduced from year to year, mainly by the fire-preventive measures that are now making themselves felt, the annual fire wastage of the world still averages quite £50,000,000 sterling. It is extremely difficult to obtain precise data as to the fire loss, insured and uninsured, but it may be assumed that in Great Britain the annual average loss by fire, towards the end of the 19th century (say 1897), was about £17,000,000 sterling, and that this had been materially reduced by 1909 to probably somewhere about £12,000,000 sterling. This extraordinary diminution in the fire waste of Great Britain, —in spite of the daily increasing number of houses, and the increasing amount of property in buildings—is in the main owing to the fire-preventive measures, which have led to a better class of new building and a great improvement in existing structures, and further, to a greater display of intelligence and interest in general fire precautionary measures by the public.

Notable improvements in the fire service have been effected, more particularly in London and in the country towns of the south of England since 1903. The International Fire Exhibition held in 1903 at Earl's Court, and the Fire Prevention Congress of the same year, may be said to have revolutionized thought on the subject of fire brigade organization and equipment in the British empire; but, for all that, the advance made by the fire service has not been so rapid as the development of the fire-preventive side of fire protection.

Fire Protection.—The term "Fire Protection" is often misunderstood. Fire-extinguishing—in other words, fire brigade work—is what the majority understand by it, and many towns consider themselves well protected if they can boast of an efficiently manned fire-engine establishment. The fire brigade as such, however, has but a minor rôle in a rational system of protection. Really well-protected towns owe their condition in the first place to properly applied preventive legislation, based on the practical experience and research of architects, engineers, fire experts and insurance and municipal officials. Fire protection is a combination of fire prevention, fire combating and fire research.

Under the heading of "Fire Prevention" should be classed all preventive measures, including the education of the public; and under the heading "Fire Combating" should be classed both self-help and outside help.

Preventive measures may be the result of private initiative, but as a rule they are defined by the local authority, and contained partly in Building Acts, and partly in separate codes of fire-survey regulations—supplemented, if necessary, by special rules as to the treatment of extraordinary risks, such as the storage of petroleum, the manufacture of explosives, and theatrical performances. The education of the public may be simply such as can be begun informally at school and continued by official or semi-official warnings, and a judicious arrangement with the newspapers as to the tendency of their fire reports.

Such forms of training have already been successfully introduced. There are English towns where the authorities have, for instance, had some of the meaningless fables of the old elementary school *Standard Reader* replaced by more instructive ones, which warn children not to play with matches, and teach them to run for help in case of an emergency. Instructive copy-book headings have been arranged in place of the meaningless sentences so often used in elementary schools. There are a number of municipalities where regular warnings are issued every December as to the dangerous Christmas-tree. In such places every inhabitant has at least an opportunity of learning how to throw a bucket of water properly, and how to trip up a burning woman and roll her up without fanning the flames. The householder is officially informed where the nearest fire-call point is, and how long he must expect to wait till the first engine can reach his house. If he is a newspaper reader, he will also have ample opportunity of knowing the resources of his town, and the local reporter's fire report will give him much useful information based on facts or hints supplied by the authorities.

Both self-help and outside help must be classed under the heading of "Fire Combating." Self-help mainly deals with the protection of large risks, such as factories, stores and public places of amusement, which lend themselves to regulation.

The requirements of the fire survey code may allow for hydrants or sprinklers in certain risks, and also for their regular inspection, and the means for self-help may thus be given. These means will, however, probably not be properly employed unless some of the employes engaged on the risk are instructed as to their purpose, and have confidence in the apparatus at their disposal. The possibility of proper self-help in dangerous risks may be encouraged by enforcing regular drills for the employes, and regular inspections to test their efficiency. There are towns where great reliance is placed on the efforts of such amateur firemen. In some cities they even receive extra pay and are formed into units, properly uniformed and equipped, and retained by the fire brigade as a reserve force for emergencies.

Self-help for the shopkeeper, the lodger or the householder can scarcely be regulated. The opportunities already mentioned for the education of the public, if properly utilized, would assure intelligent behaviour on the part of a large percentage of the community. There are places where, without any regulation being attempted, and thanks entirely to the influence referred to, most residences can boast of a hand-pump, a bucket, and a crowbar, the proper use of which is known to most of the household. Self-help in small risks may, however, be distinctly encouraged by the authorities, without any irksome interference with personal liberty, simply by the provision of street pillar-boxes, with the necessaries of first aid, including perhaps a couple of scaling ladders, and, further, by opportunities being given to householders to learn how to handle them. If a street pillar-box of this kind be put in a fire-station, and certain afternoons in the year be reserved on which this elementary instruction will be given, and the students afterwards shown over the fire-station or treated to a "turn-out," a considerable number will be found to take advantage of the opportunity. No matter whether curiosity or real interest brings them, the object in view will be attained.

Under "outside" help should be understood what is organized, and not simply such as is tendered by the casual passer-by or by a neighbour. The link between self-help and outside help is the fire-call.

The Fire-Call.—The efficiency of the fire-call depends not only on the instrument employed and its position, but also on its conspicuous appearance, and the indications by which its situation may be discovered. These indications are quite as important as the instruments themselves. The conspicuousness of the instrument alone does not suffice. Of the official notifications given in the press, those in regard to the position of the call-points are among the most useful. An indication at every street corner as to the direction to take to reach the point—or perhaps better, the conspicuous advertisement of the nearest call-point over every post pillar-box and inside every front door—may enable the veriest stranger to call assistance, and minimize the chances of time being lost in search of the instrument. It is immaterial for the moment whether the helpers are called by bell outside a fire-station, by a messenger from some special messenger service, by a call through a telephone, or by an electric or automatic appliance. Any instrument will do that ensures the call being transmitted with maximum speed and certainty and in full accord with the requirements of the locality.

Outside Help.—Organized outside help may not be limited simply to the attendance of the fire brigade. Special arrangements can be made for the attendance of the local police force, a public or private salvage corps, an ambulance, or, in some cases, a military guard. Then in some instances arrangements are made for the attendance of the water and gas companies' servants, and even officials from the public works office, insurance surveyors, and the Press. There are places where the salvage corps arrives on the scene almost simultaneously with the fire brigade, and others where the police are generally on the spot in good force five minutes after the arrival of the first engines. There are several cities where the ambulance wagon and the steamers arrive together, and another city where the military authorities always send a fire piquet which can be turned out in a few minutes.

If all these helpers come together, no matter how high the rank of the individual commanders, the senior officer of the fire brigade, even if he holds only non-commissioned officer's rank, should have control, and his authority be fully recognized. Unfortunately, there are not many countries where this is the case. The efficiency of outside help depends in the first instance on the clear definition of the duties and powers of all concerned—on the legal foundation, in fact; then on the organization, the theoretically as well as practically correct executive; and, last, but by no means least, on the prestige, the social standing, the education of commanders and their ability to handle men. Among the rank and file of the brigade, clear-headedness, pluck, smartness and agility will be as invaluable as reckless daredevilry; showy acrobaticism, or an unhealthy ambition for public applause, will be dangerous.

Research.—Under the heading "Fire Research" should be included theoretical and experimental investigation as to materials and construction, combined with the chronicling of practical experience in fires, then the careful investigation and chronicling of the causes of fires, assisted where necessary by a power for holding fire inquests in interesting, suspicious or fatal cases. Experimental investigation as to natural and accidental causes as distinct from criminal causes can be included. Research in criminal cases may be assisted not only by a fire inquest, but also by immediate formal inquiries held on the spot, by the senior fire brigade and police officers present, or by immediate government investigations held on the same lines as inquiries into explosions and railway accidents.¹ As to general research work, there are several cities which contribute substantially towards the costs of fire tests at independent testing stations. Some towns also have special commissions of experts who visit all big fires occurring within easy travelling distance, take photographs and sketches, and issue reports as to how the materials were affected. Then there are the usual statistics as to outbreaks, their recurrence and causes, and in some places such tables are supplemented by reports on experiments with oil lamps, their burners and wicks, electric wiring, and the like.

The British Fire Prevention Committee.—The British Fire Prevention Committee is an organization founded a few days after the great Cripplegate (London) fire in 1897, and incorporated in February 1899. It comprises some 500 members and subscribers. The members include civil engineers, public officials holding government appointments, fire chiefs, insurance surveyors and architects, whilst the subscribers in the main include the great public departments, such as the admiralty and war office, and municipalities, such as the important corporations of Glasgow, Liverpool and the like. Colonial government departments and municipalities are also on the roll, together with a certain number of colonial members. New Zealand has formed a special section having its own local honorary secretary. The ordinary work of the committee is carried out by a council and an executive, and the necessary funds are provided by the subscription of members and subscribers. The services of the members of council and executive are given gratuitously, no out-of-pocket expenses of any kind being refunded. Whilst the routine work deals mainly with questions of regulations, rules and publications of general technical interest, the tests are probably what have brought the committee into prominence and given it an international reputation. They are not only the recognized fire tests of Great Britain, but they rank as universal standard tests for the whole of the civilized world, and Americans, just as much as Danes, Germans or Austrians, pride themselves when some product of their country has passed the official procedure of a test by the committee. The reports of the tests, which state facts only without giving criticisms or recommendations, are much appreciated by all who have the control of public works or the specification of appliances. The committee does not limit itself solely to testing proprietary forms of construction or appliances, but has a number of tests—quite equal to the proprietary tests—of articles in general use. The ordinary concrete floor or the ordinary wooden joist floor protected by asbestos boards or slag wool receives as much attention as a patent floor;

¹ In the United States a special officer called a "fire-marshal" has for some time been allocated to this work in many cities, and in 1894 state fire-marshals were authorized in Massachusetts and in Maryland, this example being followed by Ohio (1900), Connecticut (1901), and Washington (1902); and in other states laws have been passed making official inquiry compulsory. In England the question has been mooted whether coroners, even where no death has occurred, should hold similar inquiries, but though this has been done in recent years in the City of London no regular system exists.

and similarly the ordinary everyday hydrant receives equal attention with the patent hydrant, or ordinary bucket of water with the special fire extinguisher. The door tests of the committee, which cover some thirty different types of doors, deal with no less than twenty ordinary wooden doors that can be made by any ordinary builder or cabinet-maker. These so-called non-proprietary tests are made at the expense of the general funds of the committee, whilst for the proprietary tests the owners have to pay about two-thirds of the expenses incurred in the form of a testing fee. The expenses incurred in a test, of course, not only comprise the actual testing operation of testing, but also the expense of producing the report, which is always a very highly finished publication with excellent blocks. The expense incurred also includes the establishment expenses of the testing station at Regent's Park.

The British Fire Prevention Committee organized the great Fire Exhibition and International Fire Congress of London in 1903, in both of which it enjoyed the support and assistance of the National Fire Brigades Union and the Association of Professional Fire Chiefs. It from time to time despatches special commissions to the continent of Europe, and these visits are followed by the issue of official reports, well illustrated, presenting the appliances, rules and methods of the countries visited, and serving as most useful reference publications.

Taken generally, the whole of the work of the committee, both in respect of scientific investigations and propagandism, has been most beneficial. Fire waste has been materially reduced, regardless of the fact of the greater fire hazards and the ever-growing amount of property. In Great Britain alone the sum saved in fire wastage annually is about £5,000,000. This great annual saving has been obtained at an expenditure in research work, as far as the British Fire Prevention Committee is concerned, of about £23,000, of which more than half was provided by the membership in voluntary contributions or subscriptions.

There is no similar institution anywhere in the world, although several government laboratories occasionally undertake fire tests, notably the Gross Lichterfelde laboratory near Berlin, and several insurance corporations have testing plants, notably the American Underwriters at Chicago. The efforts at research work outside Great Britain have, however, been spasmodic and in no way compare with the systematic series of inquiries conducted without any substantial state aid in London.

Distribution of Losses.—Property destroyed by fire is practically an absolute loss. This loss may actually only affect the owner, or it may be distributed among a number of people, who are taxed for it in the form of a contribution to their national or local fire fund, a share in some mutual insurance "ring," or the more usual insurance companies' premium. In the first two cases some expenses have also to be met in connexion with the management of the fund, "tariff" organization, or "ring." In the last case, not only the expenses of management have to be covered, but also the costs incurred in running the insurance enterprise as such, and then a further amount for division amongst those who share the risk of the venture—namely, the insurance company's shareholders.

It is well to distinguish between loss and mere expenditure. The sinking fund of the large property owner should cover a loss with a minimum extra expense; insurance in an extravagantly managed company paying large dividends will cover a loss, but with an unnecessarily large extra outlay. In every case the loss remains; and as property may always be considered part of the community, the province or nation, as the case may be, suffers. It is always in the interest of a nation to minimize its national losses, no matter whether they fall on one individual's shoulders or on many, and whether such losses are good for certain trades or not. With a suitable system of fire protection it is possible to bring these losses to a minimum, but this minimum would probably only be reached by an extra expense, which would fall heavier on the insurers' pockets in the form of municipal rates than the higher premium for the greater risk. A practical minimum is all that can be attempted, and that practical minimum varies according to circumstances.

Practical protection must mean smaller annual insurance dues, and the actual extra cost of this protection should be something less than the saving off these dues. Then not only has the nation a smaller dead loss, but the owner also has a smaller annual expenditure for his combined contributions toward the losses, the management of his insurance, and the protective measures. Where there is mutual insurance or municipal insurance in its best sense, the losses by fire and the costs of the protection are often booked in one account, and the better protection up to a certain point should mean a smaller individual annual share. Where there is company insurance the municipal rates are increased to cover the cost of extra protection, while a proportionate decrease is expected in the insurance premiums. Competition and public opinion generally impose this decrease of the insurance rates as soon as there is a greater immunity from fire. Where the insurance companies are well managed and the shareholders are satisfied with reasonable dividends, practical protection can be said to find favour with all

concerned, but if the protection is arranged for and the companies do not moderate their charges accordingly, the reverse is the case.

The position of insurance companies subscribing towards the maintenance of a fire brigade should here be referred to, as there is considerable misunderstanding on the subject. The argument which municipalities or fire brigade organizations often use is to the effect that the insurance companies derive all the profit from a good fire service, and should contribute towards its cost. Where properly managed companies have the business, a better fire service, however, means a smaller premium to the ratepayer. If the ratepayer has to pay for extra protection in the form of an increased municipal rate, or in the form of an increased premium raised to meet the contribution levied, this is simply juggling with figures.

Cost.—As to the cost of a practical system of fire protection, better and safer building from the fire point of view means better and more valuable structures of longer life from the economic aspect. Such better and safer constructional work pays for itself and cannot be considered in the light of an extra tax on the building owner. The compilation and administration of the fire protective clauses in a Building Act would be attended to by the same executive authorities as would in any case superintend general structural matters, and the additional work would at the most require some increased clerical aid. If the execution of the fire survey regulations were delegated to the same authority there would again simply be some extra clerical aid to pay for, and the salaries of perhaps a few extra surveyors. To make the inspections thoroughly efficient, it has been found advisable in several instances to form parties of three for the rounds. The second man would, in this case, be a fire brigade officer, and the third probably a master chimney-sweep, who would have to receive a special retaining fee.

The cost of the public training referred to would be small, as the elementary part would simply be included in the school-master's work, and the Press matters could be easily managed in the fire brigade office. Payments would have only to be made for advertisements, such as the official warnings, lists for fire-call points, &c., and perhaps for the publication of semi-official hints. Self-help, as far as inspection and drills for amateurs are concerned would be under the control of the fire brigade. There would, however, be an extra expense for the purchase and maintenance of the street first-aid appliances referred to.

The most expensive items in the system of fire protection undoubtedly come under the headings "Fire-Call" and "Fire Brigade." As to the former, there are a number of cities where the cost is modified by having the whole of the electrical service for the police force, the ambulance and fire brigade, managed by a separate department. The same wires call up each of these services, and, as the same staff attend to their maintenance, the fire protection of a city need only be debited with perhaps a third of the outlay it would occasion if managed independently. The combined system has also the great advantage of facilitating the mutual working of the different services in case of an emergency. The indicators which have been referred to involve an outlay; but here again, if the three services work together, the expenses on the count of fire protection can be lessened. The money rewards given in some cities to the individuals who first call the fire-engines may become a heavy item. Their utility is doubtful, and they have formed an inducement for arson.

As to the outlay on fire brigade establishment, a strong active force should be provided, supported by efficient reserves. The latter should be as inexpensive as possible, but should at least constitute a part-paid and disciplined body which could be easily called in for emergencies. Fire brigade budgets cannot allow for an active force being ready for such coincidences as an unusual number of large fires starting simultaneously, but they must allow for an ample strength always being forthcoming for the ordinary emergencies, and this with all due consideration for men's rest and possible sickness. An undermanned fire brigade is an anomaly which is generally fatal, not only to the property owner, but also to the whole efficiency and esprit of the force. The budget must also allow for an attractive rate of pay, as the profession is one which requires men who have a maximum of the sterling qualities which we look for in the pick

of a nation. It must also not be forgotten that the fire service is one of the few where a system of pensions is the only fair way of recognizing the risks of limb and health, and at the same time securing that stability in which practical experience from long service is so essential a factor. The budget must allow for an ample reserve of appliances.

Whether or not a fire brigade should be so strong as to permit of its having a separate section for salvage corps purposes depends on circumstances. Economically a salvage corps is required, and should be part and parcel of the municipal brigade and organized on the same lines with a reserve, no matter whether the insurance of the locality be managed by the authorities or by companies. If a corps is necessary, it matters little whether it be paid for out of premiums or out of rates.

Of further expenses which have to be considered, there are items for fire research and fire inquest. If managed economically, due confidence being placed in the opinions of the fire officers and surveyors, there is no reason why the outlay should be great. The statistical work would only require some clerical aid. Where special coroners are retained for criminal cases some extra money will of course be required; but even here the costs need not be excessive, as there are many retired fire brigade officers and fire surveyors who are well suited for the work, and would be satisfied with a small emolument.

As to the cost of the water supply, there are but few places where special fire high-pressure mains are laid on in the interests of fire protection. As a rule the costs which are debited to the heading "Fire Protection" have simply to cover the maintenance of hydrants and tablets, or at the most the cost of the water actually used for fire-extinguishing purposes. Sometimes the cost of hydrants is shared with the scavenging department or the commission of sewers, which also have the use of them. Where the provision of water and hydrants falls to a private water company, the property owners will be paying their share for them, indirectly, in the form of water rates.

The protective measures referred to will serve both for life-saving and for the protection of property. It should be remembered that a good staircase and a ladder are often as useful for the manœuvring of the firemen as for life-saving purposes, and that they are practically as essential for the saving of property as for saving life. No distinction need be made between the two risks when speaking of fire protection in general; but as the safety of the most valueless life is generally classed higher than that of the most valuable property, it may be well to give life-saving the first place when alluding to the two separately.

Criminal fire-raising only prevails where the fire-protective system is defective. With good construction and a fire survey, the quick arrival of the firemen, and careful inquests, the risks of detection are as a rule far too great to encourage its growth.

Saving of Life.—Under "Fire Prevention" special requirements in the Building Act can greatly influence the safety of life by requiring practical exits and sufficient staircase accommodation. The risks in theatres and assembly halls require separate legislation. In ordinary structures no inmate of a building should be more than sixty feet away from a staircase, and preferably there should be two staircases at his disposal in the event of one being blocked. Generally, attention is only given to the construction of staircases; but it must be pointed out that their ventilation is equally important. Smoke is even a greater danger than fire, and may hamper the helpers terribly. The possibility of opening a window has saved many a life.

Safety of Property.—As far as the protection of property is concerned, the prevention of outbreaks can be influenced by the careful construction of flues, hearths, stoves, and in certain classes of buildings by the construction of floors and ceilings, the arrangement of skylights, shutters and lightning conductors. Then comes the prevention of the fire spreading, first, by the division of risks, and secondly, by the materials used in construction.

The legislator's first ambition must be to prevent a fire in one house from spreading to another, and a stranger's property, so to say, from being endangered. This is quite possible, given

good party walls carried well over the roof to a height regulated by the nature of the risk, the provision of the shutters to windows where necessary, and the use of fire-resisting glass. Again, a thoroughly good roof—or still better, a fire-resisting attic floor—can do much. If the locality has a fire brigade and the force is efficiently handled, "spreads" from one house to another should never occur. Narrow thoroughfares and courts are, however, a source of danger which may baffle all efforts to localize a fire. This should be remembered by those responsible for street improvements.

The division of a building or large "risk" into a number of minor ones is only possible to a certain extent. There is no need to spend enormous sums to make each of the minor "risks" impregnable. The desire should be simply to try to retard the spread for a certain limited time after the flames have really taken hold of the contents. In those minutes most fires will have been discovered, and, where there is an efficient fire-extinguishing establishment, a sufficient number of firemen can be on the spot to localize the outbreak and prevent the conflagration from becoming a big one. In the drawing-room of an ordinary well-built house, for example, if the joists are strong and the boards grooved, if some light pugging be used and the plastering properly done, if the doors are made well-fitting and fairly strong, a very considerable amount of furniture and fittings can remain well alight for half an hour before there is a spread. In a warehouse or factory "risk" the same holds good. With well-built wooden floors, thickly pugged, and the ceilings perhaps run on wire netting or on metal instead of on laths, with ordinary double ledged doors safely hung, at the most perhaps lined with sheet iron or asbestos cloth, a very stiff blaze can be imprisoned for a considerable time. Many of the recent forms of "patent" flooring are exceedingly useful for the division of "risks," and with their aid a fire can be limited to an individual storey of a building, but it should not be forgotten that even the best of flooring is useless if carried by unprotected iron girders supported, say, by some light framing or weak partition. The general mistake made in using expensive iron and concrete construction is the tendency to allow some breach to be made (for lifts, shafting, &c.), through which the fire spreads, or to forget that the protection of the supports and girder-work requires most careful attention.

Of the various systems of "patent" flooring, as a rule the simpler forms are the more satisfactory. It should, however, always be remembered that any specific form of flooring alone does not prevent a fire breaking from one "risk" to another. They should go hand in hand with general good construction, and naked ironwork must be non-existent. Some of the modern fire-resisting floors are too expensive to permit their introduction for fire protection alone. In considering their introduction, the general advantages which they afford as to spans, thickness, general stability, &c., should be taken into account. A practical installation of floors, partitions, doors, &c., should, first, not increase the cost of a building more than 5%, and secondly should add to the general value of the structure by giving it a more substantial character.

The danger of lift wells, skylights and shaft openings should not be forgotten. The last should be as small as possible, well armed with shutters, the skylights should have fire-resisting glass, and the lifts not only vertical doors, but also horizontal flaps, cutting up the well into sections. The question of light partitions must also not be neglected.

Division of "risks," common-sense construction, and proper staircase accommodation are really all that fire protection requires, and where the special Building Act clauses have been kept within the lines indicated, there has been little friction and discontent. It is only as a rule when the authorities are eccentric in their demands that the building owner considers himself harassed by protective measures.

Fire survey regulations should mainly aim at preventing the actual outbreak of fire. In certain classes of risks fire survey can also increase the personal safety of the inmates and lessen the possibility of a fire spreading. The provision of fire-escapes

or ladders, and a regular inspection of their efficiency, will do much. The examination of a rusty door-catch may save a building. The actual preventive work of the surveyor will, however, mostly consist in warning property owners against temporary stoves standing on ordinary floor boards, sooty chimneys, badly hung lamps, dangerous burners and gas brackets fixed in risky positions. Self-help will be greatly facilitated by the judicious arrangement of fire-extinguishing gear, and a like inspection of its efficiency. Hydrants and cocks must not rust, nor must the hose get so stiff that the water cannot pass through it, or sprinklers choked. Hand pumps and pails must always stand ready filled. One of the greatest errors generally made in distributing such apparatus is disregard of the fact that the amateur likes to have an easy retreat if his efforts are unsuccessful, and if this is not the case, he may not, perhaps, use the gear at all.

With regard to regulations governing "special risks," so far as the safety of the public in theatres and public assembly halls is concerned, attention should be chiefly given to the exits. Spread of fire, and even its outbreak, are secondary considerations. A panic caused by the suspicion of a fire can be quite as fatal as that caused by the actual start of a conflagration. In the storage of petroleum in shops, direct communication should be prevented between the shop or cellar and the main staircase or the living rooms. The sale of dangerous lamps and burners should be prohibited.

Fire-resisting Materials.—One of the greatest misnomers in connexion with fire prevention was originally the description of certain materials and systems of construction as being "fire-proof." This has seriously affected the development of the movement towards fire prevention, for, having regard to the fact that nothing described as "fire-proof" could be fire-proof in the true sense, confidence was lost in everything so described, and in fact everything described as "fire-proof" came to be looked on with suspicion. In order to decrease this suspicion and obtain a better understanding on the subject, the International Fire Prevention Congress of London in 1903, at which some 800 representatives of government departments and municipalities were present, discussed this matter at considerable length, and they arrived at conclusions which, in consideration of their importance in affecting the whole development of fire-resisting construction, are published below. It is the classification of fire resistance adopted by this congress in 1903 that has been utilized by all concerned throughout the British empire, and in numerous other countries, since that date.

The resolutions adopted by the congress embodied the recommendations contained in the following statement issued by the British Fire Prevention Committee:—

The executive of the British Fire Prevention Committee having given their careful consideration to the common misuse of the term

"fire-proof," now indiscriminately and often most unsuitably applied to many building materials and systems of building construction in use in Great Britain, have come to the conclusion that the avoidance of this term in general business, technical, and legislative vocabulary is essential.

The executive consider the term "fire-resisting" more applicable for general use, and that it more correctly describes the varying qualities of different materials and systems of construction intended to resist the effect of fire for shorter or longer periods, at high or low temperatures, as the case may be, and they advocate the general adoption of this term in place of "fire-proof."

Further, the executive, fully realizing the great variations in the fire-resisting qualities of materials and systems of construction, consider that the public, the professions concerned, and likewise the authorities controlling building operations, should clearly discriminate between the amount of protection obtainable or, in fact, requisite for different classes of property. For instance, the city warehouse filled with highly inflammable goods of great weight requires very different protection from the tenement house of the suburbs.

The executive are desirous of discriminating between fire-resisting materials and systems of construction affording *temporary* protection, *partial* protection, and *full* protection against fire, and to classify all building materials and systems of construction under these three headings. The exact and definite limit of these three classes is based on the experience obtained from numerous investigations and tests, combined with the experience obtained from actual fires, and after due consideration of the limitations of building practice and the question of cost.

The executive's minimum requirements of fire-resistance for building materials or systems of construction will be seen from the standard tables appended for—

- I. Fire-resisting floors and ceilings,
- II. Fire-resisting partitions,
- III. Fire-resisting doors,

but they could be popularly summarized as follows:—

(a) That temporary protection implies resistance against fire for at least three-quarters of an hour.

(b) That partial protection implies resistance against a fierce fire for at least one hour and a half.

(c) That full protection implies resistance against a fierce fire for at least two hours and a half.

The conditions under this resistance should be obtainable, the actual minimum temperatures, thickness, questions of load, and the application of water can be appreciated from the annexed tables by all technically interested, but for the popular discrimination—which the executive are desirous of encouraging—the time standard alone should suffice.

It is desirable that these standards become the universal standards in this country, on the continent and in the United States, so that the same standardization may in future be common to all countries, and the preliminary arrangements for this universal standardization are already in hand.

Fire Combating.—As to self-help, complication must always be avoided. The amateur fireman must be drilled on the simplest lines. One thing which must be instilled into him is not to waste water—a sure sign of lack of training. Of course the drills must be on the same lines as those of the local brigade, and on no account should other gear be used for self-help than is generally

Standard Table for Fire-resisting Floors and Ceilings.

Classification.	Sub-Class.	Duration of Test. At Least	Minimum Temperature.	Load per Superficial Foot Distributed (per Sq. Metre).	Minimum Superficial Area under Test.	Minimum Time for Application of Water under Press.
Temporary Protection	Class A	45 mins.	1500° F. (815.5° C.)	Optional	100 sq. ft. (9.290 sq. m.)	2 mins.
	Class B	60 mins.	1500° F. (815.5° C.)	Optional	200 sq. ft. (18.580 sq. m.)	2 mins.
Partial Protection	Class A	90 mins.	1800° F. (982.2° C.)	112 lb (546.852 kg.)	100 sq. ft. (9.290 sq. m.)	2 mins.
	Class B	120 mins.	1800° F. (982.2° C.)	168 lb (820.278 kg.)	200 sq. ft. (18.580 sq. m.)	2 mins.
Full Protection	Class A	150 mins.	1800° F. (982.2° C.)	224 lb (1093.706 kg.)	100 sq. ft. (9.290 sq. m.)	2 mins.
	Class B	240 mins.	1800° F. (982.2° C.)	280 lb (1367.130 kg.)	200 sq. ft. (18.580 sq. m.)	5 mins.

kg. = kilogramme.

Standard Table for Fire-resisting Partitions.

Classification.	Sub-class.	Duration of Test. At Least	Minimum Temperature.	Thickness of Material.	Minimum Superficial Area under Test.	Minimum Time for Application of Water under Press.
Temporary Protection	Class A	45 mins.	1500° F. (815.5° C.)	2 in. and under (.051 m.)	80 sq. ft. (7.432 sq. m.)	2 mins.
	Class B	60 mins.	1500° F. (815.5° C.)	Optional	80 sq. ft. (7.432 sq. m.)	2 mins.
Partial Protection	Class A	90 mins.	1800° F. (982.2° C.)	2½ in. and under (.063 m.)	80 sq. ft. (7.432 sq. m.)	2 mins.
	Class B	120 mins.	1800° F. (982.2° C.)	Optional	80 sq. ft. (7.432 sq. m.)	2 mins.
Full Protection	Class A	150 mins.	1800° F. (982.2° C.)	2½ in. and under (.063 m.)	80 sq. ft. (7.432 sq. m.)	2 mins.
	Class B	240 mins.	1800° F. (982.2° C.)	Optional	80 sq. ft. (7.432 sq. m.)	5 mins.

Standard Table for Fire-resisting Single Doors, with or without Frames.

Classification.	Sub-class.	Duration of Test. At Least	Minimum Temperature.	Thickness of Material.	Minimum Superficial Area under Test.	Minimum Time for Application of Water under Press.
Temporary Protection	Class A	45 mins.	1500° F. (815.5° C.)	2 in. and under (.051 m.)	20 sq. ft. (1.858 sq. m.)	2 mins.
	Class B	60 mins.	1500° F. (815.5° C.)	Optional	20 sq. ft. (1.858 sq. m.)	2 mins.
Partial Protection	Class A	90 mins.	1800° F. (982.2° C.)	2½ in. and under (.063 m.)	20 sq. ft. (1.858 sq. m.)	2 mins.
	Class B	120 mins.	1800° F. (982.2° C.)	Optional	20 sq. ft. (1.858 sq. m.)	2 mins.
Full Protection	Class A	150 mins.	1800° F. (982.2° C.)	½ in. and under (.018 m.)	25 sq. ft. (2.322 sq. m.)	2 mins.
	Class B	240 mins.	1800° F. (982.2° C.)	Optional	25 sq. ft. (2.322 sq. m.)	5 mins.

customary in that force. When volunteers and regulars work together, the former should always remember that the paid force are experts, though the regulars must never have that contempt for volunteer work so often noticeable. Volunteers are often men who are probably experts in some other vocation outside fire-fighting, and have not had the opportunities which a professional fire-fighter has had.

Transmission of Fire-Calls.—There are several methods of transmitting the message of a fire-call. The simplest is, of course, to run direct to the nearest fire-station; but this is only possible where the distance is short. In one or two cities, however, the number of fire-stations is so great that they are very close to one another, and hence "direct" calls are generally recorded.

Then comes the system of special messengers. The fire is reported at some public office, police-station or guard-room, where there are always runners ready to start off to the nearest fire-station. The special runner is here practically a makeshift for the more modern telegraph or telephone line, and it is believed that the only city in which this system is employed is one where the unsettled political atmosphere has compelled the authorities to prohibit the construction of any telegraph lines other than those for the use of the general postal service. Similar messenger services have, however, also been introduced in connexion with the telegraphic signalling system. Private enterprises known as "general messenger" or "call-boy" services, which are organized for business purposes, have the advantage of including the fire-call and the police-call. In the same way that a cab can be signalled, a call may come for a fire-engine, and the ever-ready

runner makes off to the fire-station instead of to the cab rank. As a rule, these messenger offices are near the fire-station. The combination is rather a curious one, as it embraces the most advanced notions of giving every "risk" its own fire-call, and the somewhat ancient one of the special runner.

Another system for facilitating the fire-call relies entirely on the public telephone system, the terms of subscription to which may compel holders to forward fire messages if required to do so. This system allows for such development as the payment of retaining fees to porters in public and other buildings which have a night service, on condition that the fire-call shall be promptly despatched. The telephones are, perhaps, even provided free, if they are not forthcoming; but it should be remembered that the service always goes through a general telephone exchange, which is, of course, open day and night.

In the special telephone line system special wires are laid from buildings which are practically open all the year round direct to their nearest fire-stations, and some payment is again made for prompt attention. Sometimes the telegraph takes the place of the telephone, but this requires the porter or attendant to be specially trained to the work. To simplify matters, the buildings are sometimes provided with automatic fire-calls instead of telephones; but the principle of the system remains the same. In districts where there are few public offices, the list of buildings at which messages can be handed in has been frequently augmented by a set of bakeries or apothecaries' shops, where night service is not unusual.

What may be termed semi-public street alarms come next. Automatic fire-calls are put up in the street, but their handles

are under lock and key, and the keys are distributed only among policemen, watchmen or householders, and the messages can, therefore, only be given by persons known to the authorities.

The public automatic street-call is the simplest system next to the direct message. Private automatic fire-calls or telephones can be laid on from dangerous risks, and there has even been an instance where an attempt was made to give every householder a private fire-call. This system is, however, unfortunately too extreme for the municipal purse. If in connexion with some other paying enterprise, as in the case of the messenger services referred to, it would be a different matter, though it should also not be forgotten that too great a number of call points means a probable repetition of signals of the same fire, and a risk of too many sections of the fire brigade being on the road to it.

Besides these forms of "call," there is also the private alarm. Dangerous buildings are frequently provided with telephones, alarm-posts, or even automatic temperature indicators, by which a call can be given direct from the "risk" involved.

Call points should be not only conspicuous, but also in most frequented positions. Possibly, in some towns, a point in front of a church would be the best; in others, the front of a public-house. It should always be remembered that every facility should be given to enable as many people as possible to know the whereabouts of the call points without any distinct effort on their part. Red paint may make a call pillar conspicuous by day, and a coloured lamp by night.

As to the indication of call points, a plate on every letter-box stating the position of the nearest call-point is perhaps one of the best methods. The letter-box is one of the instruments most in use in a modern city, and hence the plate is read by many. In an oriental town the public fountain would, however, take the place of the letter-box. Plates put up inside every front door are somewhat extreme measures. In one city red darts are painted on the glass of every street lamp, indicating the direction to be taken to find a street alarm. This sign, however, has the disadvantage of requiring a previous knowledge of its meaning, and is generally useless to a stranger in the town.

Rewards paid to messengers vary from one shilling to half a sovereign. In some places every call is rewarded—even those to chimney fires—and this often results in an abuse of the privilege. Rogues light fires on the top of a chimney and then run to call the engines. If a reward be given, a limitation should be made. In one town no relation or employé of the owner receives a reward. In other cities no rewards are given for calls to a fire in a dust-bin or a chimney.

No true fireman would be annoyed at a false alarm given by mistake. The possibility of a fire, or the suspicion of one, is a bona fide reason for a call which should not be discouraged. Malicious alarms should, however, be treated with the utmost rigour, as the absence of firemen from their stations always means an extra risk to life and property. Combined "lynch law" and imprisonment has generally been adopted with good effect. The rascal should first be put when caught over the pole of the engine and thrashed with a broad fireman's belt, and after that handed to the police.

The fire-call should, if possible, also be so constructed as to facilitate intercommunication between the scene of a fire and the headquarters of the fire brigade. Where the runner is employed or the telephone is used no special arrangements are required, but where the telegraph or automatic call point has been introduced, the apparatus must be adapted for this contingency. At some automatic fire-call points a few signals can be given, at others a telegraphic or telephonic transmitter can be applied. Much valuable time may be saved in this way when more assistance is required.

Fire Brigades.—The organization of fire brigades varies greatly. There are brigades where officers and men are practically constantly ready to attend a fire, and others where they are ready on alternate days, two days out of every three, or three days out of every four, and the off day is entirely their own, or at the most, only partially used by the authorities for some

light work. The men off duty are only expected to attend a fire if there is a great emergency, the brigade being strong enough without them for ordinary eventualities. Both systems can be worked with or without part-paid or volunteer service, which would be only called out for great calamities. They could be organized as a practically independent reserve force, or the reserve men might be attached to sections of the regulars and mixed with them when the occasion arises. The reserves can consist either of retired firemen who have a few regular drills, or of amateurs who go through a special course of training, and have some series of drills at intervals, with preferably a short spell of service every year with the regulars. For the regulars, forty-eight hours on duty to every twenty-four off has given the most satisfactory results.

The division of the active force may be on a system of a number of small parties of twos and threes backed by one or more strong bodies. Another system allows for subdivision into sections of equal strength, ranging from parties of, say, five men with a non-commissioned officer to thirty non-commissioned officers and men with an officer. The force can, of course, also simply be divided up into parties or sections of different strengths not governed by a system of military units. The sections either can work independently, as units, simply governed by one central authority, or there can be a grouping of the units into minor or major bodies or districts, each duly officered, and as a whole individually responsible to headquarters.

The officers may be all taken from the ranks, or they may be "officers and gentlemen" in the military sense, or have only temporarily done work with the rank and file when in training. There could also be a combination of these two systems. Only the captain and deputy-captain might be officers in the military sense, the sections or divisions being officered by "non-coms." Some cities have an officer to every thirty "non-coms" and men, whilst others put a division of as many as two hundred under a fireman who has risen from the ranks. Where protection is treated as a science, and where those in charge of a brigade have really to act as advisers to their employers, officers in the military sense have been found essential. They have also been found advantageous where their scope is limited to fire extinguishing. The prestige of the fire service has been raised everywhere where the officers, besides being fire experts, are educated men of social standing. There are cities where the officers of the fire brigade are in every way recognized as equal to army or navy men, their social position is the same, and their mess fulfils the same functions as a regimental mess. The fire brigade officer is recognized at court, and there is no ceremonial without him. On the other hand, there are also cities with brigades several hundred strong where the captain's social standing is beneath that of a petty officer or colour-sergeant. As to the primary training of a fire brigade officer, the best men have generally had some experience in another profession, such as the army, the navy, or the architectural and engineering professions, previous to their entering the fire service. Some brigades recruit from army officers only, and preferably from the engineers or artillery regiments; others recruit from among architects and engineers, subject to their having at least had some military experience in the reserve forces or the volunteers. Some cities only take engineers or architects, and make a point of it that they should have no previous military experience. Some previous experience in the handling of men is essential.

As to the men, there are cities where only trained soldiers are taken as firemen; others where the engines are manned by sailors. In some towns the building trades supply the recruits; in others, all trades are either discriminately or indiscriminately represented. A combination from the army or navy on the one side and the building trades on the other is most satisfactory. The knowledge of building construction in the ranks stands the force in good stead, and has often saved both lives and property. Where a brigade can boast of a few men of each important trade, much money has been saved the ratepayers by the men doing their own repairs and refitting, but the number of men from sedentary trades should not be excessive. Where there are only

men of one trade or calling, there is often too great a tendency to one-sidedness, and a great amount of prejudice.

Physical strength and perfect constitution are requisite for both officers and men. As to the height of the men, small, wiry men are very useful. First-class eyes, ears and nose are necessary, also a good memory. Fat men are entirely out of place in a brigade, and should be transferred to some other service if the fatness be developed during their engagement with a brigade. Many brigades take only single men, "non-coms" and officers only being allowed to marry. There are many brigades where twenty-two and forty are the limits of age for the privates, fifty for the "non-coms," and sixty for the officers.

As to the equipment, there are brigades which have all their sections or units provided with practically the same gear; others where each unit has a double or treble set, one of which is used according to circumstances. The section may have a manual engine, a steamer and a ladder truck at its disposal, and may turn out with either. There are towns where the units are differently equipped, and steamer or manual sections called out, as the case may be. In a few extreme cases, where the sections are very strong, they may be equipped with a set of engines and trucks, and the unit, in every case, turns out complete with (say) a chemical engine, a steamer and a horsed escape. The contrast to this will be found in the small parties of twos or threes, whose turn-out would only consist of a small hose trolley or an escape. Of course, there are all kinds of combinations, the most important of which allows a section to have one or more independent subsections. Though practically belonging to the "unit," the subsections work independently in charge of a certain gear. This may be a hose-reel, a long ladder, or a smoke helmet, according to circumstances. The subsections may act as outposts or simply as specialist parties, which are only called out for particular work.

As for the housing of the units or sections, simple street stations are provided for the small parties referred to. In a few cases two small parties are housed under the same roof. The large bodies that back them are generally quartered together in extensive barracks, from which any number of engines and men can be turned out according to the nature of the call. Then there are cities where every section has its own well-built station; others where one or two sections are housed together, according to circumstances, and perhaps as many as half a dozen located at headquarters. If groups are formed, the headquarters of the group or district has, perhaps, two sections, while each of the other stations has only one. The general headquarters may be the central station of a district at the same time. The actual working of the district headquarters would, however, then be kept separate from the working of the headquarters staff. The latter would, perhaps, have some sections ready to send anywhere besides the trucks, &c., necessary for the officers, the general extra gear, &c., that might be required. It is usual to combine workshops, stores, hose-drying towers, &c., with the headquarters station, and, in some cases, also with the district centres.

In the distribution of the stations, the formation of districts, &c., various systems have been adopted. The most satisfactory results have been obtained where a fully-equipped section (not simply a hose-car or escape-party) can reach any building in the city within six minutes from the time of the call reaching the station, the six minutes including both turn-out and run. Where there are exceptionally large or dangerous risks, this time has had to be shortened to four minutes, and the possibility of an attendance from a second station assured within six minutes. In dividing up districts, the most satisfactory results have been obtained where every house can be reached from the district centre within fifteen minutes from the call. Headquarters would naturally have a central position in the city. In one or two instances the headquarters offices are located in a separate building, which in no way serves as a fire-station, but simply as a centre through which all orders and business pass.

The different stations must be in connexion with each other. The special runner or rider is practically disappearing. The

telegraph and telephone have taken his place. Some cities favour Morse telegraphy, which certainly had great advantages over the telephone at one time, as messages could be easily transmitted to several stations with the same effort, but telephone distributors have now been successfully introduced. Errors are less frequent by telegraph than by telephone, and there is always a record of every message. The most modern forms of telephone communication are, however, more suitable for the fire service than the telegraph. Headquarters should be in direct communication with every station, but every station should be able to communicate with its neighbour directly, as well as through the headquarters office, and there should be a direct wire to its district station if it has one. There should be three routes of communication, so that two should be always ready for use in case of one breaking down. Either headquarters or the district centres would be in touch with the various auxiliaries referred to, as well as the general telegraph office and the telephone exchange.

As to the attendance at fires, some cities turn out but one unit to answer the first call if they have no particulars, others always turn out two or three sections, and there are several cities where the district centre would at least send an officer and a few men as well. In one brigade, headquarters is always represented by either the chief or the second officer in the case of a call of this kind. The idea is that it is always better to have too strong a force quickly in attendance than too small a number of men, and that it is most important that the first arrival should be well handled. Further, if two sections answer a call and one breaks down on the road, there is no chance of there being too great a delay in the arrival of organized help. It should, however, not be forgotten that further calls in the same district to other fires are not unusual, and that the absence of too many engines, on account of a first call, is dangerous. In some cities, when a call reaches the firemen one or two of the nearest stations turn out, and if more help is required other sections will be called up individually. In others the reinforcements are not called up separately, but the fires are divided into three classes—small, medium and large; and on the message arriving of a more extensive conflagration at a certain point, the section already know beforehand whether they must attend or not. First calls to certain classes of risks, e.g. to theatres or public offices, may always be considered to be for medium or large fires; and the same message will then simultaneously turn out the stronger body without any further detailed instructions being necessary. In some towns the fire-call automata are so arranged that the messenger can at once call for the different classes of fire. This, however, is not to be recommended, as a messenger will probably consider the smallest fire to be a gigantic blaze, and will bring out too many engines.

Equipment.—The following are characteristic features in the equipment of brigades. First, where there is a high-pressure water supply, some brigades simply attend with hose-cars, life-saving gear and ladders; or, instead of the hose-cars, take their manuals, which they practically never use and which serve only as vehicles to carry men and hose. Others take, and make a point of using, the manuals, and have a barrel with them ready to supply the first gallons of water necessary. No time is thus lost in connecting with the nearest hydrant or plug; and in case of a hydrant being out of order, there is always sufficient water at hand until the second hydrant has been found. Many cities have introduced chemical engines to take the place of this combination of water barrel and manual engine. A supply of water is carried on the chemical engine. Some cities always have an attendance of steamers, which are, however, only used in urgent cases. In other instances the steamer is at once used in the same way as the manual, and this quite independently of the pressure there is in the water service. Where there is no good water service, manuals or steamers have, of course, to be sent out, and are supplied either from the low-pressure service or from the natural waterways or wells. There are still a large number of cities where the suburbs have no proper water service, and the water barrel is then very handy

for water portage. Attempts have also been made at the chemical treatment of water which is to be thrown on to a fire, with the view of increasing its effect, or at the use of chemicals instead of water. In certain localities fire appliances are still run out to fires by hand, especially where there is a high pressure water system and hose carts only are required. Generally the appliances are horsed. Motor traction is, however, now rapidly superseding horse traction for reasons of economy and the wider and more rapid range of efficiency.

As to life saving and manœuvring gear, some brigades rely almost entirely on hook ladders, others almost entirely depend on scaling ladders or telescopic escapes. In some great confidence is placed in the jumping-sheet; in another, chutes are much used; and there are a few where wonderful work is done with life-lines. To indicate the diversity with which any one appliance can be treated, made or handled, in the fire service, it may be mentioned that there are quite ten different ways in which a jumping-sheet can be held. Then there is the material of the jumping-sheet to be considered; the size and the shape—whether round, oblong, square or rectangular; then the means of holding it, the way to fold it, how and where to stow it, and at what distance from the endangered building the sheet is to be held. Last, but not least, come the words of command.

Working of Brigades.—In some forces all possible attention is given to the rapidity of the actual turn out, while in others the speed at which engines run to the fire is considered to be of primary importance. Other brigades, again, give equal attention to both. There are brigades which work entirely on military lines, each man having certain duties marked out for him beforehand for every possible occasion, and there are others where happy-go-lucky working is preferred. Of course there are combinations in the same way as regards command. Some chief officers arrive at a fire with a staff of adjutants and orderlies, and control the working of the brigade from a position of vantage at a distance. Other chiefs delight to be in the thick of a fire, perhaps at the branch itself, or on some gallant life-saving exploit where they no doubt do good work as a fireman, but in no way fulfil the office of commanders. Officers must remember that they are officers, and not rank and file; and this is generally very difficult to those who have advanced from the ranks. Superintendents, however smart, must leave acts of bravery to their men, and chief officers, without going to extremes, must always be in a good position where they can superintend everything pertaining to the outbreak in question. Some brigades seem to make a point of working quietly, and shouting is absolutely forbidden, all commands being given by shrill whistles. In some brigades all commands are given by word of mouth, and there is much bawling. In others commands, besides being bawled, are even repeated on horns, and the noise becomes trying. As a rule, quiet working is a sign of efficiency.

Some brigades work as close as possible to the fire, others are satisfied with putting water on or about the fire from a distance. Some attack the fire direct, others only try to protect what surrounds the seat of the flames. Several brigades are ordered always to try to attack by the natural routes of the front door and the staircases. In others, the men always have to attempt some more unnatural entrance, with the aid of ladders—through windows, for instance. Some brigades carefully extinguish a fire, some simply swamp it. Some brigades boast of never having damaged property unnecessarily. They have, for instance, had the patience to suffocate a cellar fire, instead of putting the whole cellar under water. In certain classes of property the bucket, the mop, and the hand-pump have been far more effective in minimizing actual destruction than the branch and hose. It is one of the easiest signs by which to judge the training and handling of a fire brigade—to see what damage they do. Even an inconsiderate smashing of doors and windows, when there is absolutely no need for it, can be avoided, where every man in the force feels that his first duty is to prevent damage and loss and his second to extinguish the fire.

Where the brigade includes a salvage division, it is generally stationed at headquarters; where this division is split up into

sections, there would also be a distribution among the district centres; the salvage men are simply part of the force, told off on special duty. Where there are private salvage corps, their stations are generally near the headquarters or district centres of the brigade, from which they receive notice of the fire. In some cities the salvage corps work quite independently; in others, they work under the chief of the brigade directly they arrive at the fire.

As to the working of allied civilian forces in conjunction with the fire service, the advantages of firemen having plenty of room to work in is now fully recognized, and the police are at once called out and often brought on to the scene in an incredibly short time. The value of these measures should not be underrated, especially in cities where rowdyism exists. In many cities the ambulance service is also turned out to fires. Where no independent ambulance corps exists, some of the firemen should be trained to work as ambulance men. Turncocks and gasmen are also frequently brought to all fires. Lastly, in many garrison towns the military turn out to assist the fire brigade.

National Fire Brigades' Union.—The National Fire Brigades' Union, which is the representative Fire Service Society for Great Britain, originated in a national demonstration of volunteer fire brigades held at Oxford in celebration of Queen Victoria's jubilee on the 30th of May 1887, when 82 fire brigades with 916 firemen were present. Next day a meeting of the officers was held at the Guildhall, Oxford, and it was then resolved to form the National Fire Brigades Union. Alderman Green, the chief officer of the Oxford fire brigade, was appointed the first chairman. Sir Eyre Massey Shaw was appointed first president in 1888, and on his retirement in 1896 through ill-health he was succeeded by the duke of Marlborough. When the union offered to provide ambulance firemen and stretcher bearers for his regiment the duke accepted the offer, and two fully equipped corps were sent out to the Imperial Yeomanry hospital at Deelfontein, South Africa, under Colonel Sloggett, who specially mentioned the services rendered by the firemen in his despatches.

The union is divided into seventeen districts, each having its own council, and sending one delegate for every ten brigades to the central council. The districts are:—Eastern, Midlands, South Coast, South-Eastern, West Midland, North-Eastern, North-Western, South Western, Surrey, South Midlands, Southern, South Wales, North Wales, Cornish, Yorkshire, Central and South Africa (formed in 1902). There are also seventy-five foreign members and correspondents in America, Australia, Austria, Belgium, Canada, Denmark, France, Germany, Holland, Italy, New Zealand, Russia, South Africa, India and the Federated Malay Straits. The total strength of the union is 667 fire brigades and members with nearly 12,000 firemen. Every member of the union gives his time and services for the benefit of the country; all appointments are honorary, with the exception that a small allowance is made for clerical assistance. A drill book is issued by the union, and the fourth edition was published in 1902. Over 60,000 of these books have been issued to brigades all over the world.

The ambulance department is under the charge of medical officers. All members have to come up for re-examination every three years, else they are not entitled to wear the red cross, and the examination is more stringent than that held by the St John Ambulance Association. This department has proved to be a great benefit to provincial fire brigades, who are often called upon to undertake ambulance work. A very useful and instructive manual has been issued by the union entitled *First Aid in the Fire Service*, by Chief Officer William Ettles, M.D.

The union organized and took part in the International Fire Exhibitions, at the Royal Agricultural Hall, London, in 1893 and 1896, and it was represented at the International Fire Congresses at Antwerp, Brussels, Ghent, Paris, Lyons, Havre and Berlin. It has also held a review before the German emperor at the Crystal Palace, and before Queen Victoria in Windsor Park.

Fire Brigade Organization.

Below are given examples of the organization of different fire brigades. The brigades so described have been selected not so much on account of their intrinsic importance, as because they represent classes or types of brigades and fire brigade organization which it may be useful to refer to. In respect of the London fire brigade, however, historical data are also presented, as it is only with the aid of these that the extraordinary development of that force can be properly realized.

With regard to modern views as to the functions of the fire brigade, the resolutions of the Fire Prevention Congress of 1903 are reprinted below. As they indicate, the general feeling amongst all interested in fire protection from an economic point

of view is that fire brigades should not be merely fire extinguishing organizations but should utilize their influence in a much wider sense.

The Congress considered:—

1. That public authorities should encourage fire brigade officers to take an active interest in the preventive aspect of fire protection, inasmuch as the result of the fire brigade officers' experience in actual fire practice, if suitably applied in conjunction with the work of architects, engineers and public officials, would be most useful for the organization and development of precautionary measures.

2. That fire brigade societies, associations and unions should encourage amongst the brigades affiliated to these bodies the study of questions of fire prevention.

3. That fire brigades should be placed on a sound legal basis, and that it is advisable that their efficiency be supervised by a government department.

4. That an official investigation should be made of all fires. That on the occurrence of every fire an investigation should be immediately made by an official, duly qualified and empowered to ascertain the cause and circumstances connected therewith, reporting the result of such investigation to a public department for tabulation and publication.

5. That the whole or part of the cost of such inquiry should be charged to the occupier of the premises where the fire occurred, as may appear desirable in the circumstances of each case.

6. That the press should from time to time publish technical reports on fires so that the public may benefit from the knowledge and experience gained.

London.—In the early part of the 19th century the methods in vogue for the suppression of outbreaks of fire in the metropolis were of the most crude and disjointed character, in striking contrast with the highly elaborated system now put into practice by the London County Council through its fire brigade; and it was not until the second half of the 19th century was well advanced that anything approaching an adequate and satisfactory organization was brought into existence. Until the passing of the Metropolitan Fire Brigade Act 1865, the only acts relating to the suppression of outbreaks of fire in London were the Lighting and Watching Act (3 & 4 William IV., c. 90), and "an act (14 Geo. III., c. 78) for the further and better Regulation of Buildings and Party Walls, and for the more effectually preventing Mischiefs by Fire within the Cities of London and Westminster, and the Liberties thereof, and other the Parishes, Precincts and Places within the Weekly Bills of Mortality, the Parishes of Marylebone, Paddington, St Pancras, and St Luke's at Chelsea, in the County of Middlesex." The clauses in the latter act relating to protection against fire remained in force till the passing of the act of 1865. They provided that every parish should keep "one large engine and one small, called a hand engine, a leathern pipe, and a certain number of ladders." The Lighting and Watching Act contained a clause which extended to England and Wales and so covered the area "without the bills of mortality," enabling the inspectors appointed under that act to provide and keep up two fire-engines; and certain of the parishes in the metropolitan district, without the bills of mortality, availed themselves of this provision.

The select committee of fires in the metropolis, which sat in 1862, reported that it was difficult to ascertain how far the act of George III. was attended to, or when it ceased to be considered practically of importance, but that, at the time of the report, the arrangements generally made by the parishes under the act were not only entirely useless, but in many cases produced injurious results, as the system under the act frequently conferred a reward for the first useless parochial engine, whereas the efficient engine which might be on the spot a few minutes later derived no pecuniary advantages. There were, however, exceptions to the general rule. At Hackney, for example, a "very efficient" fire brigade was maintained at an expense of about £500 a year, or about one halfpenny in the pound on the rating of the parish. The select committee were unable to ascertain with any accuracy the total amount paid by the metropolitan parishes for the maintenance, "however inefficient," of their fire-engines, but it was estimated to be about £10,000.

For many years previous to 1832, the principal fire insurance offices in London kept fire brigades at their individual expense;

to these brigades were attached a considerable number of men usually occupied as Thames watermen, retained in the service of the different Fire Offices, who received payment only on the occurrence of fires, and who wore the livery and badge of the respective companies. These fire brigades were, to quote the report of the select committee of 1862, considered as giving notoriety to the different insurance companies, and a considerable rivalry was maintained, which was productive naturally of good as well as of some considerable evil on occasions of fires.

The large expenses thus incurred by the companies induced an attempt to be made, which was effectually carried out in the year 1832, by R. Bell Forde, a leading director of the Sun Fire Office, to form one brigade for the purpose of promoting economy as well as greater efficiency. Thus the first organized fire brigade for London began its operations under the united sanction of, and from funds contributed by, most of the leading insurance offices in London. The force thus formed was known as the London Fire Engine Establishment. The annual expense was at first £8000, the number of stations 19, the number of men employed 80. By 1862 the annual cost had grown to £25,000, the number of stations had become 20, and the number of men 127.

It is interesting to note that the chief station of the Fire Engine Establishment was the Watling-Street station, in substitution for which the new Cannon-Street station has been built. The following is a list of the other stations of the establishment:—

School House-lane, Shadwell	Crown Street, Soho
Wellclose Square	Wells Street
Jeffrey's Square	Baker Street
Whitecross Street	King Street, Golden Square
Farringdon Street	Horseferry Road
Holborn	Waterloo Road
Chandos Street	Southwark Bridge Road
Tooley Street	Southwark Bridge (floating)
Lucas Street, Rotherhithe	Rotherhithe (floating)

The work of this force was carried out in an efficient manner as far as its limited equipment and strength would permit, but it was universally admitted that the staff, engines and stations were totally inadequate for the general protection of London from fire. The directors of the insurance offices themselves admitted this, but they considered their brigade sufficient for the protection of that part of London in which the largest amount of insured property was located, and contended that it was not their business to provide fire stations in the more outlying districts where, if a fire occurred, it was not likely to involve their offices in serious loss.

From 1836 the work of the brigade maintained by the fire offices was supplemented by the "Society for the Protection of Life from Fire." This society was managed by a committee of which the lord mayor was president. It was supported entirely by voluntary contributions, and, at a cost of about £7000 a year, maintained fire-escapes at from 80 to 90 stations in different parts of the most central districts in London. Its most outlying station was only 4 m. from the Royal Exchange, and it maintained no stations in such localities as Greenwich, Peckham, Deptford and New Cross. It did much useful work, though its equipment was quite inadequate to cope with the needs of the metropolis.

In 1834, two years after the institution of the London Fire Engine Establishment, the Houses of Parliament were destroyed by fire, and the attention of the government was consequently directed to the inadequacy of the existing conditions for fire extinction. It was suggested, at the time, that the parochial engines should be placed under the inspection of the commissioners of police, but this proposal was not adopted, and the existing state of matters was allowed to continue for another thirty years. The select committee of 1862 recommended that a fire brigade should be created under the superintendence of the commissioners of police, and should form part of the general establishment of the metropolitan police. In 1865, however, the Metropolitan Fire Brigade Act was passed, under which the responsibility for the provision and maintenance of an efficient

fire brigade was laid upon the Metropolitan Board of Works. Under the provisions of the act, the board took over the staff, stations and equipment of the Fire Engine Establishment; the engines maintained by the various parochial authorities, and the men in charge of them were also absorbed by the new organization, as were the fire-escapes and staff of the Society for the Protection of Life from Fire.

The funds provided by the Fire Brigade Act for the maintenance of the brigade were: (1) the produce of a halfpenny rate on all the rateable property in London; (2) contributions by the fire insurance companies at the rate of £35 per million of the gross amount insured by them in respect of property in London; and (3) a contribution of £10,000 a year by the government. Although the revenue allotted increased year by year, its increase was far from keeping pace with the constant calls from all parts of London for protection from fire. Some temporary financial relief was afforded by the Metropolitan Board of Works (Loans) Act 1869, which (1) authorized the interest on borrowed money to be paid, and the principal to be redeemed out of the proceeds of the Metropolitan Consolidated rate, apart from the halfpenny allocated for fire brigade purposes; and (2) provided that the amount to be raised for the annual working expenditure on the brigade should be equal to what would be produced by a halfpenny in the pound on the gross annual value of property, instead of, as before, on the rateable value. One result of the passing of the Local Government Act 1888 (by which the London County Council was constituted), under which a county rate for all purposes is levied, was virtually to repeal the limitation of the amount which might be raised from the ratepayers for fire brigade purposes. Since that time the expenditure on the brigade has therefore, like that of other departments of the council's service, been determined solely by what the council has judged to be the requirements of the case.

When the council came into existence early in 1889 the fire brigade was admittedly not large enough properly to protect the whole of London, the provision in various suburban districts being notoriously inadequate to the requirements. A plan for enlarging and improving old stations, and for carrying out a scheme of additional protection laid down after careful consideration of the needs of London as a whole, was approved on the 8th of February 1898 (and somewhat enlarged in 1901); it provided for the placing of horsed escapes at existing fire stations, for the establishment of some 22 additional stations provided with horsed escapes, and for the discontinuance of nearly all the fire-escape and hose-cart stations in the public thoroughfares.

Since it came into existence the London County Council has established additional fire stations at Dulwich, New Cross, Kingsland, Whitefriars, Lewisham, Shepherd's Bush, West Hampstead, East Greenwich, Perivale, Homerton, Highbury, Vauxhall, Pageant's Wharf (Rotherhithe), Streatham, Kilburn, Bayswater, Eltham, Burdett Road (Mile End), Wapping, Northcote Road (Battersea), Herne Hill, Lee Green and North End (Fulham). Of these, Vauxhall, Kilburn, Bayswater, Eltham, Burdett Road, Herne Hill and North End stations are sub-stations. New stations have been erected, in substitution for small and inconvenient buildings, at Wandsworth, Shoreditch, Fulham, Brompton, Islington, Paddington, Redcross Street (City), Euston Road, Clapham, Mile End, Deptford, Old Kent Road, Millwall, Kensington, Westminster, Brixton and Cannon Street (City), and the existing stations at Kennington, Rotherhithe, Clerkenwell, Hampstead, Battersea, Whitechapel, Greenwich and Stoke Newington have been considerably enlarged. Two small stations without horses have been established in Battersea Park Road and North Woolwich respectively. A building has been erected at Rotherhithe for the accommodation of the staff of the Cherry-garden river station; and another building has been erected at Battersea for the accommodation of the staff of a river station which has been established there.

In 1909 new stations in substitution for existing stations were in course of erection at Knightsbridge and Tooting, and additional sub-stations were being erected at Plumstead and Hornsey Rise. The Bethnal Green station was being considerably altered and enlarged. The council had also determined to erect new stations in substitution for existing inconvenient buildings at Holloway, Waterloo Road, Shooter's Hill and North End, Fulham; and to build additional sub-stations at Charlton, Caledonian Road, Brixton Hill, Camberwell New Road, Roehampton, Balham, Brockley and Earlsfield.

Budapest.—There is a combination of a professional force and a volunteer force at Budapest, and in addition an auxiliary service of factory fire brigades. The professional fire brigade possesses a central station and eight sub-stations, two minor stations, and permanent theatre-watchrooms at the royal theatres. The staff (in 1901) of the professional brigade consisted of a chief officer, an inspector, a senior adjutant and two junior adjutants, a clerk, and further 23 warrant officers, 3 engineers, 15 foremen, 154 firemen and 30 coachmen with 62 horses. There have been some slight increases since. The apparatus at their disposal consists of 6 steam fire-engines, 22 manual engines, 27 small manual engines, 11 water carts, 13 traps, 4 tenders, 26 hose reels and hose carts, 5 long ladders, 9 ordinary extension ladders, 34 hook ladders, 12 smoke helmets and 22,000 metres of hose. The various stations are connected with the central station by private telephone lines. There are 149 telephonic fire alarms distributed throughout the city. They are on radial lines connected up with their respective nearest stations, and on a single radial line there are from three to seventeen call-points.

The volunteer brigade has an independent constitution and comprises some eighty members. Its equipment is housed with that of the professional brigade, and is bought and maintained by the municipality. This volunteer brigade is a comparatively wealthy institution, having a capital of 100,000 crowns, whilst receiving a special subsidy annually from the municipality. Though legally an entirely independent institution, the brigade voluntarily puts itself under the command of the chief officer of the professional brigade. It further puts daily at the disposal of the professional fire chief ten men who do duty every night and "turn out" when called upon to render service. This volunteer brigade stands as a kind of model to the other volunteer brigades, and it is in connexion with this volunteer brigade that the educational classes referred to above are held and facilities accorded to the officers undergoing instruction to gain experience at the Budapest fires.

The Budapest professional fire brigade, even if assisted by the volunteer force, would scarcely be of adequate strength to deal with the great factory risks of that city were it not that the Budapest factories and mills have a splendidly organized service of factory fire brigades. These brigades—forty-four in number—are essentially private institutions, intended to render self-help in the factories to which they belong, but they are well organized, and have a mutual understanding whereby the neighbouring brigades of any one factory immediately turn out and assist in case of need. These factory brigades have a total staff of 1600 men. They are equipped with 1 steam fire-engine, 57 large manuals, 136 small manuals, and have a very considerable amount of small gear, including 15 smoke helmets.

Cologne.—The Cologne professional fire brigade is 153 strong (1906), with a chief officer, a second officer, and two divisional officers, a warrant officer, a telegraph superintendent and 16 foremen. The brigade has 26 horses, of which 2, however, are used for ambulance purposes. The brigade has three large stations and a minor station, and has a permanent fire-watch at the two municipal theatres. Men are told off for duty as coachmen among the firemen. The staff do forty-eight hours of duty to twenty-four hours of rest.

A peculiarity of the Cologne organization is its auxiliary retained fire brigade in two sections, comprising a superintendent, 2 deputy superintendents, 5 foremen, and 51 men, with 2 horses, who are retained men housed in municipal buildings (tenements), and available as an immediate reserve force. The first section of the reserve force are housed centrally.

There is a further system of suburban volunteer fire brigades manned by volunteers but equipped by the municipality, and horsed from the municipal stables or municipal tramways. Three of these volunteer brigades, which have large suburban districts, comprise each a superintendent, 2 senior foremen and 3 junior foremen, with 50 firemen and 3 coachmen. The minor outlying suburbs have several such brigades, each having one senior foreman, 3 junior foremen, 20 firemen and 2 coachmen. The combined force of the suburban volunteer brigades is 295 all ranks.

The Cologne fire service thus comprises a combination of professional brigade with a retained auxiliary brigade and a system of suburban volunteer brigades. Of the three stations, the central one is still an old building, and the other two are in modern buildings; the extra sub-station (near the river stores) is also a modern building. The brigade has about 150 fires to attend per annum. Its printed matter, in the form of an annual detailed report, is exceptionally well prepared. The brigade does permanent "fire-watch" duty at the municipal theatres which are strengthened of an evening. It provides additional watches during performances at all other theatres and public entertainments. Such duties are provided in part by an auxiliary brigade and partly by the professional brigade. A number of the professional brigade are always utilized for doing general work in the workshops of the brigade. The first or central section of the auxiliary brigade drills eleven times per annum, and is additionally turned out eleven times per annum (without drill). Men newly attached to the auxiliary force have to go through a four weeks' recruit drill.

Nuremberg.—The Nuremberg fire service stands as the most economically organized efficient fire service in Central Europe, and its form of organization is peculiar and exceptional. In 1902 the entire fire-service cost the city 126,000 marks (£6300). The total of inhabitants in 1900 was 261,000. For this small amount of money the city gets a highly-trained retained fire brigade of 156 men (1907), and two volunteer fire brigades of 130 and 224 men respectively. Further, it has an auxiliary of eighteen suburban volunteer fire brigades (1080 men) and two private factory fire brigades (71 men). The whole service stands under a professional chief officer and professional second officer. There are 8 telegraph clerks, 6 watchmen and 17 coachmen attached to the retained brigade. The service has been in existence for fifty years. It has gradually developed and has worked remarkably well, and may, in fact, be taken as a model institution for municipal economy, with due regard to up-to-dateness and efficiency. The retained fire brigade comprises entirely municipal employes, regularly engaged in the municipal workshops, scavenging and works department. The municipal workshops are located alongside the fire-brigade stations. There is a headquarters station for the retained brigade and volunteer brigade in the centre of the town, a modern district station in the western district, and a third district station is in course of erection for the eastern district, which is at present only served by a small branch station.

At headquarters station there are on immediate duty by day 14 firemen (chiefly smiths and carpenters) of the retained brigade. Nine men of the retained brigade are on duty at headquarters at night, together with 8 men of the volunteer fire brigade. At the west district station, 14 men of the retained brigade are on duty by day, and the same number at night.

The headquarters can turn out in succession four complete units of the following strength, namely:—

First unit, a large chemical engine, and a mechanical long ladder.
Second unit, a trap with hose reel, a special gear-cart and a long ladder.

Third unit, a trap with hose-cart and manual, and a long ladder.

Fourth unit, a steam fire-engine, and hose-and coal-tender trap.

From the west district station three units can be turned out in rotation, namely:—

First unit, large chemical engine, large trap and a long ladder.

Second unit, a trap with hose-reel and manual engine.

Third unit, a steam fire-engine and a hose-tender and coal-tender trap.

The equipment of the eastern sub-station at present comprises a turn-out of a trap and a long ladder.

The brigade can thus turn out immediately, in rapid succession, these horsed appliances, well organized and fully manned. It further has a reserve of 4 manual engines and 2 long ladders.

The suburban volunteer brigades have besides at their disposal 25 manual engines, 9 fire-escapes and 18 hose-reels. The whole of the hose for all brigades is of uniform pattern and make, with bayonet pattern standard couplings. The brigade posts an evening "fire watch" at the theatres. The men of the retained brigade get modest extra pay for fire brigade duty, but this pay is intended rather to cover disbursements or expenses than to be considered as wages. The brigade uses the municipal horses, all of which are stabled in proximity to the fire stations, and a number of which are kept on duty for fire brigade purposes in the actual stations. For all practical purposes the retained brigade is the professional brigade in which the men do municipal work in the municipal workshops, and elsewhere, *i.e.* in training, drill and general efficiency they are quite up to the best professional standard. The volunteer brigade is well drilled and includes the best of the younger townsmen, who do duty at night by rotation. The brigade's responsibilities are clearly

defined, and the position of the professional chief and second officer clearly laid down by by-laws. There are 129 fire-call points. During the fifty years' existence of the service, 85 firemen received the twenty-five years' long-service medal, of whom 32 belonged to the suburban volunteer brigades.

Venice.—The Venice fire brigade is a section of the force of "Vigili" or municipal watchmen, which body does general duty in preserving order and rendering assistance to the community. In other words, this force performs the duties of the civil police (rather than governmental or criminal police), fire, patrol watch service, and public control in a general sense. The force, which in all its sections made a most excellent impression, has a commandant, under whom the two primary sections work, namely (a) the civil police section and the (b) fire brigade section; each section in turn having its own principal officers. The police section comprises some 108 of all ranks, and the fire brigade section some 73 of all ranks (1908). The commandant of the whole force is a retired military officer, and the chief of the fire service section is a civil engineer, and these two officers, together with the chief of the civil police section, are the three superior officers of the force. The police section serve as auxiliaries to the fire brigade section in case of any great fire, and, of course, generally work very much hand in hand on all occasions. The fire brigade section has 3 superintendents, 6 foremen, 6 sub-foremen, 6 corporals and 40 file. The section is well equipped with appliances, both hand and steam, having a large modern petrol-propelled float, constructed in London, a large old type steam-float, two 35-ft. old steam-floats, and several small petrol motor-floats or first turnout appliances. The manual-engines, ladders, &c., which are in considerable number, are carried in a large fleet of swift gondolas. Fire-escape work is done with Roman ladders, which are usually planted on two gondolas flung together barge-form, or, if the depth of the canal permits, the lower length is buried in the canal bottom. Hook ladders are also used.

Men are distributed in six companies of varying strength, the headquarters company being stationed at the town hall, with a strength of 22, and most of the steam and petrol floats lie opposite the station. The fire brigade does theatre watch duty. As a fire station of considerable interest, should be mentioned the one at the Doge's palace; the large vaults occupying a portion of the ground floor facing St Mark's Square have been adapted for fire station purposes in a very simple yet artistic manner, and the old gear of the brigade has been used to form emblems, &c.

Vienna.—In 1892 the Vienna fire service was reconstituted on modern lines owing to the area of the Vienna municipality having been greatly extended. The professional brigade was somewhat strengthened and entirely re-equipped, and the various existing volunteer brigades of the outlying districts were transformed into suburban volunteer fire brigades, equipped and controlled by the municipality and standing under the general command of the fire brigade headquarters. The principle involved was the utilization of the splendid volunteer force around Vienna for the purpose of strengthening the municipal brigade, a principle of great economic advantage, as the professional brigade would otherwise have had to be materially strengthened, probably trebled. These suburban volunteer fire brigades number no fewer than 34, and have 1200 firemen of all ranks. They are practically independent institutions as far as the election of officers and administration is concerned, but their equipment and uniforms and their fire stations are provided by the municipality, and in certain districts a staff of professional firemen detached from headquarters are attached to their stations as telegraph clerks and drill-instructors.

The suburban volunteer brigades turn out to fires in their own districts, and further, assist in other districts when so ordered by headquarters. They form a strong reserve for great fires in the city proper. Headquarters, of course, renders assistance at large suburban fires. These suburban volunteer fire brigades are very perfectly equipped with appliances, generally of the same type as those used in the central professional brigade. Some of these brigades are equipped with combined chemical engines with 15-metres long ladders attached. They have smoke helmets, and everything that may be termed modern.

The men are volunteers in the truest sense of the word, *i.e.* do not take pay of any description or make any charges for attendance at fires or refreshments at fires.

The Vienna "professional brigade," as it is generally called, has a personnel (1906) consisting of 8 officers, 5 officials and 475 men. Of stations there is the headquarters, a district station, 4 branch stations with steam fire engines, 9 small branch stations, and 2 "watches" in public buildings. The officers of the brigade consist of the commandant, chief inspector and six inspectors. The officers, of whom four are on duty daily, are all quartered at headquarters. There are three telegraph superintendents. The rank and file is composed of 8 drill-sergeants, 40 telegraph clerks (three classes), 53 foremen (two classes), 22 engineers and stokers, 248 men (three classes). Twenty-four telegraph clerks and engineers are detailed for duty with the suburban volunteer brigades. There are 78 coachmen.

The following are the fire-extinguishing and life-saving apparatus and service vehicles of all kinds standing ready to "turn out":— 2 open and 2 officers' service carriages (at headquarters), 6 "traps" for the first "turn-out" (5 at headquarters and 1 at the district fire station), each manned by one officer in charge and nine men, and equipped with 3 hook-ladders, a portable extension ladder and jumping sheet, a life-saving chute, an ambulance chest, 3 tool-boxes, a jack, tools, torches, 2 smoke-helmets, with hand-pump and a hose-reel attached; five special gear-carts (4 at headquarters and 1 at the district station), each manned by seven firemen and equipped like the "traps" with the exception that, instead of the life-saving chute, the carts carry with them a sliding-sheet, two petroleum torches each, an extension ladder (15 metres long) and some spare coal for the steam fire-engines; 4 pneumatic extension ladders each 25 metres long, and 3 extension turn-table ladders each 25 metres long (at headquarters and at two of the substations); each of the pneumatic ladders has three men, and each turn-table ladder five men; 18 chemical engines (3 at headquarters and 1 each in the other stations), each having five men with 3 hook-ladders, a jointed ladder (in four sections), a hose-reel, a hand-engine, a smoke helmet, a jumping sheet, an ambulance chest, a tool box, torches, &c.; 8 steam fire-engines (3 at headquarters and one each in the district fire station and the 4 steam-engine stations), each with an engineer and stoker.

The reserve of appliances includes 12 manual engines, 15 large chemical engines, 17 steel water-carts (with 1000 litre reservoirs). The total number of oxygen smoke helmets in the brigade is 68, and there are 15 ordinary smoke helmets with hand-pumps. The total number of horses is 132. One electrically-driven trap and two electrically-driven chemical engines are being tried. The fire telegraphic and telephonic installation, including the lines in the volunteer brigades' districts kept up by the professional brigade, comprises 47 telegraph stations, 249 telephone stations, with altogether 161 Morse instruments and 536 semi-public fire-call points.

Zürich.—Zürich covers about 12,000 English acres, 1500 of which are built over with some 15,000 houses, the whole of the buildings being subject to the local building regulations and the State Insurance Association's rules, in which they are compulsorily insured. The brigade is a compulsory militia brigade, placed under the control of the head of the department of police under a law of 1898. The same municipal officer is head of a special municipal committee of nine, entrusted with the safety of the town from fire. The executive officer of the committee is known as the inspector, and acts as captain of the fire brigade. His office is at the fire-brigade headquarters, where he has a small permanent staff both for brigade work and correspondence. Every male inhabitant of Zürich is compelled to do some service for the prevention of, or protection against, fire, from the age of twenty to fifty years. The duty may be fulfilled (1) by active service, or (2) in the case of an able-bodied citizen, who for some reason is not found suited to be a member of the brigade, or has been dismissed from the brigade, by the payment of a tax, which tax is fixed on the basis of his income. Certain citizens, however, are *ipso facto* exempt from active service, namely members of parliament, members of council of the Polytechnic school, of the Cantonal government, of the High Court of Justice, and of the Town Council; also clergymen and schoolmasters, the officials of railways, tramway and steamboat companies, of the post-office and telephone department, students of the Polytechnic school and other educational institutions and municipal officials, with whose duties fire brigade service is incompatible. Exemption from active service can also be accorded on a testi-

monial of a medical board. Exemption from active service, however, in no case exempts from the tax, the total of which amounts to between £4000 and £5000. In making the selection of men for active service only, men particularly fitted for the work are taken, namely, men who are personally keen, who have a good physique, and who are preferably of the building or allied trades. The officers of the brigade are appointed by the municipal committee. The men's drills are by the chief officer, and the men are liable to fines and to imprisonment (up to four days) for not attending their drills. The whole of the brigade is insured against accidents and illness with the Swiss Fire Brigade Union at the expense of the city, and the city in addition provides a fund for families in cases of death of firemen on duty. There is also a sick fund provided for the brigade by the municipality, which also accords a scale of compensation.

The fire brigade comprises the very large complement of fifteen companies with 120 men each. Each company has three sections, namely, a fire service section, a life-saving section, and a police section, the last being utilized for keeping the ground and attending to salvage. Each company is supposed to be able, as a rule, to deal with the fire in its own district without calling upon the company of an adjoining district, and it is only in the case of a very serious fire that additional companies are turned out. There is thus a system of decentralization and independence of companies in this brigade not often met with elsewhere. Firemen are paid one franc for each drill of two hours. For fires, two francs for two hours, and fifty centimes per hour afterwards. Refreshments are provided. Any telephone can be used free by law for an alarm. The brigade has at its disposal an extension telephone service, but the men are not all connected up with the telephone of their respective districts, and thus the alarm is given mainly with horns sounded by men who are on the telephone. No section of the brigade has less than ten men on the telephone.

The water-supply is of a most excellent character. The appliances in the main comprise hydrants and hose-reels with ladder trucks, and each section has not less than 3000 ft. of hose. They are mainly housed in small temporary corrugated iron sheds with roller shutter doors, to which all the firemen have keys. There are some sixty of these hydrant houses distributed round the city, the larger appliances being at headquarters and at some depots.

Apart from the fact of there being the inspector or chief officer for the whole district, with a certain permanent staff, each company might be considered as a separate brigade, having its own chief officer and staff, and independent organization, the organization of the companies, however, being identical. A company comprises 1 chief officer, 1 second officer, 1 doctor, 2 ambulance men and 6 orderlies, a staff in charge, and the three sections have respectively 1 lieutenant, 1 deputy-lieutenant and 40 men for the fire service section; 1 lieutenant, 1 deputy-lieutenant and 40 men for the life-saving section, and 1 lieutenant, 1 deputy-lieutenant and 20 men for the police section. Only in the case of sections 1 and 2 is there some slight variation in the organization, namely, 1 and 2 sections have been combined as a joint section, with an additional senior officer. At Zürich, as in all Swiss fire brigades, there is an extraordinary uniformity of drills, rules, regulations and instructions in all its sections. In 1908 the brigade comprised 2268 in all ranks. There were about 70 fires in that year. (E. O. S.)

United States.

Fire service in the United States has developed on so large a scale that in 1902 it was estimated by P. G. Hubert ("Fire Fighting To-Day and To-Morrow," *Scribner's Magazine*, 1902, 32, pp. 448 sqq.) that in proportion to population the fire force of America was nearly four times that of Germany or France and about three times that of England. The many fires consequent on wooden construction even in the large cities; the bad effect of sudden climatic changes—drying, parching heat being followed by weather so cold as to require artificial heating; the less safe character of heating appliances; and, especially in tenements, the more inflammable character of furniture, are some of the reasons assigned for greater fire frequency in America. Fire-fighting service in the United States is in no way connected with the military as it is on the continent of Europe; the association of volunteer with paid firemen is uncommon except in the suburban parts of the large cities, and in the smaller cities and towns, where volunteers serving for a certain term are, during that term and thereafter, exempt from jury duty.

New York.—The fire department of New York City is the result of gradual development. The first record of municipal action in regard to fire prevention dates from 1659, when 250

leather buckets and a supply of fire-ladders and hooks were purchased, and a tax of one guilder for fire apparatus was imposed on every chimney; in 1676 fire-wells were ordered to be dug; in 1686 every dwelling-house with two chimneys was required to provide one bucket (if with more than two hearths, two), and bakers and brewers had to provide three and six buckets respectively; in 1689 "brent-masters" or fire-marshals were appointed; in 1695 every dwelling-house had to provide one fire-bucket at least; in 1730 two Richard Newsham hand-engines were ordered from England, and soon afterwards a superintendent of fire-engines was appointed on a small salary; in 1736 an engine-house was built near the watch-house in Broad Street, and an act of the provincial legislature authorized the appointment of twenty-four firemen exempt from constable or militia duty. Early in the 19th century volunteer fire companies increased rapidly in numbers and in importance, especially political; and success in a fire company was a sure path to success in politics, the best-known case being that of Richard Croker, a member of "Americus 6," commonly called "Big Six," of which William M. Tweed was organizer and foreman. Parades of fire companies, chowder parties and picnics (predecessors of the present "ward leader's outing") under the auspices of the volunteer organizations, annual balls after 1829, water-throwing contests, often over liberty poles, and bitter fights between different companies (sometimes settled by fist duels between selected champions), improved the organization of these companies as political factors if not as fire-fighters. So devoted were the volunteers to their leaders that in 1836, when James Gulick, chief engineer since 1831, was removed from office for political reasons, the news of his removal coming when the volunteers were fighting a fire caused them all to stop their work, and they began again only when Gulick assured them that the news was false; almost all the firemen resigned until Gulick was reinstated. The type of the noisy, rowdy New York volunteer fire hero was made famous in 1848-1849 by Frank S. Chanfrau's playing of the part Mose in Benjamin Baker's play, *A Glance at New York*. The Ellsworth Zouaves of New York were raised entirely from volunteer firemen of the city.

In 1865, when the volunteer service was abolished, it consisted of 163 companies (52 engines, 54 hose; 57 hook and ladder) manned by 3521 men (engines averaging 40 to 60 men, hose-carts about 25, and hook and ladder companies about 40); the chief engineer, elected with assistants for terms of five or three years by ballots of the firemen, received a salary of \$3000 a year; and three bell-ringers in each of eight district watch-towers, who watched for smoke and gave alarms, received \$600 a year. The legislature in March 1865 created a Metropolitan Fire District and established therein a Fire Department, headed by four commissioners, who with the mayor and comptroller constituted a board of estimate.

This organization was practically unchanged until 1898, when the Greater New York was chartered and the present system was introduced. At its head is a commissioner who receives \$7500 a year. The more immediate head of the firemen is a chief (annual salary \$10,000), the only member of the force not appointed on the basis of a civil service examination; the chief has a deputy in Manhattan (for Manhattan, Bronx and Richmond boroughs) and another for Brooklyn and Queens, each receiving an annual salary of \$5000.

In December 1908 there were: 14 deputy chiefs (eight in Manhattan, Bronx and Richmond, and six in Brooklyn and Queens); 59 chiefs of battalion (31 in Manhattan, Bronx and Richmond, and 28 in Brooklyn and Queens); 248 foremen or captains (137 in Manhattan, Bronx and Richmond, and 111 in Brooklyn and Queens); 365 assistant foremen (221 in Manhattan, Bronx and Richmond; and 144 in Brooklyn and Queens); 431 engineers of steamers (247 in Manhattan, Bronx and Richmond, and 184 in Brooklyn and Queens) and 2933 firemen (1772 in Manhattan, Bronx and Richmond, and 1161 in Brooklyn and Queens); and the total uniformed force was 4107. At the close of 1908 there were 88 engine companies in Manhattan and the Bronx, including 6 fire-boat companies—at East 99th St., Battery Park, Grand St. (East River), West 35th St., Gansevoort St. and West 132nd St.; and in Manhattan and the Bronx there were 38 hook and ladder companies; in Brooklyn and Queens there were 70 engine companies, including

two fire-boat companies—at 42nd St. and at North 8th St. The appropriations for the year 1906 were \$4,777,687 for Manhattan, Bronx and Richmond, and \$3,147,033 for Brooklyn and Queens; and the department expenses were \$3,980,535 for Manhattan, Bronx and Richmond, and \$2,565,849 for Brooklyn and Queens.

The first high-pressure main system in the city was installed at Coney Island in 1905, gas-engines working the pumps. Electrically driven centrifugal pumps are used in Brooklyn (protected area, 1360 acres) and in Manhattan, where the system was introduced in 1908, and where the protected district (1454 acres) reaches from the City Hall to 25th St. and from the Hudson east to Second Avenue and East Broadway, being the "Dry Goods District"; water is pumped either from city mains or from the river, and the change may be made instantaneously. The fire-watch-tower system was abolished in 1869; the present system is that of red box electric telegraph alarms, which register at headquarters (East 67th St.), where an operator sends out the alarm to that engine-house nearest to the fire which is ready to respond, and a chart informing him of the absence from the engine-house of apparatus. There are volunteer forces (about 2700 men) in Queens and Richmond boroughs and in other outlying districts.

Boston.—The Boston fire department (reorganized after the great fire of 1872) is officered by a commissioner (annual salary, \$5000), a chief (annual salary, \$4000), a senior deputy (\$2400), and a junior deputy (\$2200), twelve district chiefs (\$2000 each), a superintendent and an assistant superintendent of fire-alarms, and a superintendent and an assistant superintendent of the repair shop. In 1909 the force numbered 877 regulars and 8 call men. There were 53 steam fire-engines, 14 chemical engines, 3 water-towers, 3 combination chemical engines and hose-wagons (one being motor-driven), 3 fire-boats (built in 1889, 1895 and 1909 respectively), 29 ladder-trucks and 49 hose-wagons. The auxiliary salt-water main service was established in 1893. The earliest suggestion of the application of the electric telegraph to a fire-alarm system was made in Boston in 1845 by Dr Wm. F. Channing; in 1847-1848 Moses G. Farmer, then a telegraph operator at Framingham, made a practicable electric telegraph alarm; and in 1851-1855 Farmer became superintendent of the Boston fire-alarm system, a plant being installed in 1852.¹

Chicago.—The Chicago organization practically dates from the fire of 1871, though there was a paid department as early as 1858. Its principal officers are a fire-marshal and chief of brigade (salary \$8000), four assistant fire-marshals, a department inspector, eighteen battalion chiefs, a superintendent of machinery, a veterinary and assistant, and about one hundred each of captains, lieutenants, engineers and assistant engineers; the total regular force in 1908 was 1799 men with an auxiliary volunteer force of 71 in Riverdale, Norwood Park, Hansen Park and Ashburn Park. In the business part of the city there is a patrol of seven companies employed by the Board of Fire Underwriters. Since 1895 all men in the uniformed force (except the chief of brigade) are under civil service rules. In 1908 the equipment included 117 engine companies, 34 hook and ladder companies, including one water-tower, 15 chemical engines and one hose company; and there were 5 fire-boats (4 active and 1 reserve). The first fire-boat was built in 1883. The initial installation of high-pressure mains was completed in 1902, and was greatly enlarged in 1908.

Fire Appliances.

Fire-Alarms.—Most large cities possess a system of electrical fire-alarms, consisting of call boxes placed at frequent intervals along the streets. Any one wishing to give notice of a fire either opens the door of one of these boxes or breaks the glass window with which it is fitted, and then pulls the handle inside, thus causing the particular number allocated to the box, which of course indicates its position, to be electrically telegraphed to the nearest fire station, or elsewhere as thought advisable. Sometimes a telephone is fixed in each call-box. Automatic fire-alarms consist of arrangements whereby an electric circuit is closed when the surrounding air reaches a certain temperature. The electric circuit may be used to start an alarm bell or to give warning to a watchman or central office, and the devices for closing it are of the most varied kinds—the expansion of mercury in a thermometer tube, the sagging of a long wire suspended between horizontal supports, the unequal expansion of the brass in a curved strip of brass and steel welded together, &c.

Fire-Engines.—The earliest method of applying water to the extinction of fires was by means of buckets, and these long remained the chief instruments employed for the purpose, though Hero of Alexandria about 150 B.C. described a fire-

¹ See Thomas C. Martin, *Municipal Electric Fire Alarm and Police Patrol Systems* (Washington, 1904), Bulletin 11 of the Bureau of the Census, Department of Commerce and Labour. The next plant was installed in Philadelphia in 1855; one in St Louis was completed in 1858; and work was begun in New Orleans and Baltimore in 1860.

engine with two cylinders and pistons worked by a reciprocating lever, and Pliny refers to the use of fire-engines in Rome. In the 16th century (as at Augsburg in 1518) we hear of fire squirts or syringes worked by hand, and towards the end of the same century Cyprien Lucar described a very large one operated by a screw handle. The fire squirts used in London about the time of the Great Fire were 3 or 4 ft. long by $2\frac{1}{2}$ or 3 in. in diameter, and three men were required to manipulate them. The next stage of development was to mount a cistern or reservoir on wheels so that it was portable, and to provide it with pumps which forced out the water contained in it through a fixed delivery pipe in the middle of the machine. An important advance was made in 1672 when two Dutchmen, Jan van der Heyde, senior and junior, made flexible hose by sewing together the edges of a strip of leather, and applied it for both suction and delivery, so that the engines could be continuously supplied with water and the stream could be more readily directed on the seat of the fire. For many years manual engines were the only ones employed, and they came to be made of great size, requiring as many as 40 or 50 men to work them; but now they are superseded by power-driven engines, at least for all important services. The first practical steam fire-engine was made by John Braithwaite about 1820, but though it proved useful in various fires in London for several years after that date, it was objected to by the men of the fire brigade and its use was abandoned. A generation later, however, steam fire-engines began to come into vogue. At first they were usually drawn by horses to the scene of the fire, though exceptionally their engines could be geared to the wheels so that they became self-propelled; and it was not till the beginning of the 20th century that motor fire-engines were employed to any extent. Steam, petrol and electricity have all been used. Such engines have the advantage that they can reach a fire much more rapidly than a horse-drawn vehicle, especially in hilly districts, and they can if necessary be made of greater power, since their size need not be limited by considerations of the weight that can be drawn by horses. Petrol-propelled engines can be started off from a station within a few seconds of the receipt of an alarm, and their pumps are ready to work immediately the fire is reached; steam-propelled engines possess the same advantage, if they are kept always standing under steam, though this involves expense that is avoided with petrol engines, which cost nothing for maintenance except while they are actually working. Motor engines are made with a capacity to deliver 1000 gallons of water a minute or even more, but the sizes than can deal with 400 or 500 gallons a minute are probably those most commonly used.

In towns standing on a navigable water-way fire-boats are often provided for extinguishing fires in buildings, in docks and along the waterside. The capacity of these may rise to 6000 gallons a minute. Steam is the power most commonly used in them, both for propulsion and for pumping, but in one built for Spezia by Messrs Merryweather & Sons of London in 1909, an 80 H. P. petrol engine was fitted for propulsion, while a steam engine was employed for pumping. The boiler was fired with oil-fuel, and steam could be raised in a few minutes while the boat was on its way to a fire. The pumps could throw a $1\frac{1}{2}$ -in. jet to a height of nearly 200 ft. In some places, as at Boston, Mass., the fire-boats are utilized for service at some distance from the water. Fire-mains laid through the streets terminate in deep water at points accessible to the boats, the pumps of which can be connected to them and made to fill them with water at high pressure. In cities where a high-pressure hydraulic supply system is available, a relatively small quantity of the pressure water can be used, by means of Greathead hydrants or similar devices, to draw a much larger quantity from the ordinary mains and force it in jets to considerable heights and distances, without the intervention of any engine.

The water is conducted from the engines or hydrants in hose-pipes, which are made either of leather fastened with brass or copper rivets, or of canvas (woven from flax) which has the merit of lightness but is liable to rot, or of rubber jacketed with canvas (or in America with cotton). For directing the water on

the fire, nozzles of various forms are employed, some throwing a plain solid jet, others producing spray, and others again combining jet and spray, the spray being useful to drive away smoke and protect the firemen. Various devices are employed to enable the upper storeys of buildings to be effectively reached. A line of hose may be attached to a telescopic ladder, the extensions of which are pulled out by a wire rope until the top rests on the wall of the building at the required height. Water-towers enable the jet to be delivered at a considerable height independently of any support from the building. A light, stiff, lattice steel frame is mounted on a truck, on which it lies horizontally while being drawn to a fire, but when it has to be used it is turned to an upright position, often by the aid of compressed gas, and then an extensible tube is drawn out to a still greater height. The direction of the stream delivered at the top may be controlled from below by means of gearing which enables the nozzle to be moved both horizontally and vertically. The pipe up the tower may be of large diameter, so that it can carry a huge volume of water, and at the bottom it may terminate in a reservoir into which several fire-engines may pump simultaneously.

Another class of fire-engines, known in the smaller portable sizes as fire-extinguishers or "extincteurs," and in the larger ones as "chemical engines," throw a jet of water charged with gas, commonly carbon dioxide, which does not support combustion. Essentially they consist of a closed metal tank, filled with a solution of some carbonate and also containing a small vessel of sulphuric acid. Under normal conditions the acid is kept separate from the solution, but when the machine has to be used they are mixed together; in some cases there is a plunger projecting externally, which when struck a sharp blow breaks the bottle of acid, while in others the act of inverting the apparatus breaks the bottle or causes it to fall against a sharp pricker which pierces the metallic capsule that closes it. As soon as the acid comes into contact with the carbonate solution carbon dioxide is formed, and a stream of gas and liquid mixed issues under considerable pressure from the attached nozzle or hose-pipe. Hand appliances of this kind, holding a few gallons, are often placed in the corridors of hotels, public buildings, &c., and if they are well-constructed, so that they do not fail to act when they are wanted, they are useful in the early stages of a fire, because they enable a powerful jet to be quickly brought to bear: but it is doubtful whether the stream of mixed gas and liquid they emit is much more efficacious than plain water, and too much importance can easily be attached to spectacular displays of their power to extinguish artificial blazes of wood soused with petrol, which have been burning only a few seconds. Chemical engines, up to 60 or 70 gallons capacity, are used by fire brigades as first-aid appliances, being mounted on a horsed or motor vehicle and often combined with a fire-escape, a reel of hose, and other appliances needed by the firemen, and even with pumps for throwing powerful jets of ordinary water. Large buildings, such as hotels and warehouses, where a competent watchman is assumed to be always on duty, may be protected by a large chemical engine placed in the basement and connected by pipes to hydrants placed at convenient points on the various floors. At each hose-station a handle is provided which when pulled actuates a device that effects the mixing of the acid and carbonate solution in the machine, so that in a minute or so a stream is available at the hydrants.

Automatic Sprinklers.—Factories, warehouses and other buildings in which the fire risks are great, are sometimes fitted with automatic sprinklers which discharge water from the ceiling of a room as soon as the temperature rises to a certain point. Lines of pipes containing water under pressure are carried through the building near the ceilings at distances of 8 or 10 ft. apart, and to these pipes are attached sprinkler heads at intervals such that the water from them is distributed all over the room. The valves of the sprinklers are normally kept closed by a device the essential feature of which is a piece of fusible metal; this as soon as it is softened (at a temperature of about 160° F.) by the heat from an incipient fire, gives way and releases the water,

which striking against a deflecting plate is spread in a shower. In situations where the water is liable to freeze, the ceiling pipes are filled only with air at a pressure of say 10 lb per sq. in. When the sprinkler head opens under the influence of the heat from a fire, the compressed air escapes, and the consequent loss of pressure in the pipes is arranged to operate a system of levers that opens the water-valve of the main-feed pipe. The idea of automatic sprinklers is an old one, and a system was patented by Sir William Congreve in 1812; but in their present development they are specially associated with the name of Frederick Grinnell, of Providence, Rhode Island.

Fire-Escapes.—The best kind of fire-escape, because it is always in place, and always ready for use, is an external iron staircase, reaching from the top of a building to the ground, and connected with balconies accessible from the windows on each floor. In many towns the building by-laws require such staircases to be provided on buildings exceeding a certain height and containing more than a certain number of persons. Of non-fixed escapes, designed to enable the inmates of an upper room to reach the ground through the window, numberless forms have been invented, from simple knotted ropes and folding ladders to slings and baskets suspended by a rope over sheaves fixed permanently outside the windows, and provided with brakes by which the occupant can regulate the speed of his descent, and to "chutes" or canvas tubes down which he slides. Fire brigades are provided with telescopic ladders, mounted on a wheeled carriage, up which the firemen climb; sometimes the persons rescued are sent down a chute attached to the apparatus, but many fire brigades think it preferable to rely on carrying down those who are unable to descend the ladder unaided. Jumping sheets or nets, held by a number of men, are provided to catch those whose only chance of escape is by jumping from an upper window. (X.)

FIREBACK, the name given to the ornamented slab of cast iron protecting the back of a fireplace. The date at which firebacks became common probably synchronizes with the removal of the fire from the centre to the side or end of a room. They never became universal, since the proximity of deposits of iron ore was essential to their use. In England they were confined chiefly to the iron districts of Sussex and Surrey, and appear to have ceased being made when the ore in those counties was exhausted. They are, however, occasionally found in other parts of the country, and it is reasonable to suppose that there was a certain commerce in an appliance which gradually assumed an interesting and even artistic form. The earlier examples were commonly rectangular, but a shaped or gabled top eventually became common. English firebacks may roughly be separated into four chronological divisions—those moulded from more than one movable stamp; armorial backs; allegorical, mythological and biblical slabs with an occasional portrait; and copies of 17th and 18th century continental designs, chiefly Netherlandish. The fleur-de-lys, the rosette, and other motives of detached ornament were much used before attempts were made to elaborate a homogeneous design, but by the middle of the 17th century firebacks of a very elaborate type were being produced. Thus we have representations of the Crucifixion, the death of Jacob, Hercules slaying the hydra, and the plague of serpents. Coats of arms were very frequent, the royal achievement being used extensively—many existing firebacks bear the arms of the Stuarts. About the time of Elizabeth the coats of private families began to be used, the earliest instances remaining bearing those of the Sackvilles, who were lords of a large portion of the forest of Anderida, which furnished the charcoal for the smelting operations in our ancient iron-fields. To the armorial shields the date was often added, together with the initials of the owner. The method of casting firebacks was to cut the design upon a thick slab of oak which was impressed face downwards upon a bed of sand, the molten metal being ladled into the impression. Firebacks were also common in the Netherlands and in parts of France, notably in Alsace. At Strassburg and Metz there are several private collections, and there are also many examples in public museums. The museum of the Porte de

Hal at Brussels contains one of the finest examples in existence with an equestrian portrait of the emperor Charles V., accompanied by his arms and motto. When monarchy was first destroyed in France the possession of a *plaque de cheminée* bearing heraldic insignia was regarded as a mark of disaffection to the republic, and on the 13th of October 1793 the National Convention issued a decree giving the owners and tenants of houses a month in which to turn such firebacks with their face to the wall, pending the manufacture by the iron foundries of a sufficient number of backs less offensive to the instinct of equality. Very few of the old plaques were however removed, and to this day the old châteaux of France contain many with their backs outward. Reproductions of ancient chimney backs are now not infrequently made, and the old examples are much prized and collected.

FIRE BRAT, a small insect (*Thermobia* or *Thermophila furnorum*) related to the silverfish, and found in bakehouses, where it feeds upon bread and flour.

FIREBRICK.—Under this term are included all bricks, blocks and slabs used for lining furnaces, fire-mouths, flues, &c., where the brickwork has to withstand high temperature (see BRICK).

The conditions to which firebricks are subjected in use vary very greatly as regards changes of temperature, crushing strain, corrosive action of gases, scouring action of fuel or furnace charge, chemical action of furnace charge and products of combustion, &c., and in order to meet these different conditions many varieties of firebricks are manufactured.

Ordinary firebricks are made from fireclays, *i.e.* from clays which withstand a high temperature without fusion, excessive shrinkage or warping. Many clays fulfil these conditions although the term "fireclay" is generally restricted in use to certain shales from the Coal Measures, which contain only a small percentage of soda, potash and lime, and are consequently highly refractory. There is no fixed standard of refractoriness for these clays, but no clay should be classed as a fireclay which has a fusion point below 1600° C.

Fireclays vary considerably in chemical composition, but generally the percentage of alumina and silica (taken together) is high, and the percentage of oxide of iron, magnesia, lime, soda and potash (taken together) is low. Other materials, such as lime, bauxite, &c., are also used for the manufacture of firebricks where special chemical or other properties are necessary.

The suitability of a fireclay for the manufacture of the various fireclay goods depends upon its physical character as well as upon its refractoriness, and it is often necessary to mix with the clay a certain proportion of ground firebrick, ganister, sand or some similar refractory material in order to obtain a suitable brick. Speaking generally, fireclay goods used for lining furnaces where the firing is continuous, or where the lining is in contact with molten metal or other flux, are best made from fine-grained plastic clays; whereas firebricks used in fire-mouths and other places which are subjected to rapid changes of temperature must be made from coarser-grained and consequently less plastic clays. In all cases care should be taken to obtain a texture and also, as far as possible, by selection and mixing, to obtain a chemical composition suitable for the purpose to which the goods are to be applied. The Coal Measure clays often contain nodules of siderite in addition to the carbonate of iron disseminated in fine particles throughout the mass, and these nodules are carefully picked out as far as practicable before the clay is used.

A firebrick suitable for ordinary purposes should be even and rather open in texture, fairly coarse in grain, free from cracks or warping, strong enough to withstand the pressure to which it may be subjected when in use, and sufficiently fired to ensure practically the full contraction of the material. Very few fireclays meet all these requirements, and it is usual to mix a certain proportion of ground firebrick, ganister, sand or clay with the fireclay before making up. The fireclay or shale or other materials are ground either between rollers or on perforated pans, and then passed through sieves to ensure a certain size and evenness of grain, after which the clay and other materials are mixed in suitable proportion in the dry state, water being generally added in the mixing mill, and the bricks made up from plastic or semi-plastic clay in the ordinary way.

The proportion of ground firebrick, &c., used depends on the nature of the clay and the purpose for which the material is required, but generally speaking the more plastic clays require a higher percentage of a plastic material than the less plastic clays, the object being to produce a clay mixture which shall dry and fire without cracking, warping or excessive shrinkage, and which shall retain after firing a sufficiently open and even texture to withstand alternate heatings and coolings without cracking or flaking. For special purposes

special mixtures are required and many expedients are used to obtain fireclay goods having certain specific qualities. In preparing clay for the manufacture of ordinary fire-grate backs, &c., where the temperature is very variable but never very high, a certain percentage of sawdust is often mixed with the fireclay, which burns out on firing and ensures a very open or porous texture. Such material is much less liable to splitting or flaking in use than one having a closer texture, but it is useless for furnace lining and similar work, where strength and resistance to wear and tear are essential. For the construction of furnaces, fire-mouths, &c., the firebrick used must be sufficiently strong and rigid to withstand the crushing strain of the superimposed brickwork, &c., at the highest temperature to which they are subjected.

The wearing out of a firebrick used in the construction of furnaces, &c., takes place in various ways according to the character of the brick and the particular conditions to which it is subjected. The firebrick may waste by crumbling—due to excessive porosity or openness of texture; it may waste by shattering, due to the presence of large pebbles, pieces of limestone, &c.; it may gradually wear away by the friction of the descending charge in the furnace, of the solid particles carried by the flue gases and of the flue gases themselves; it may waste by the gradual vitrification of the surface through contact with fluxing materials: in cases where it is subjected to very high temperature it will gradually vitrify and contract and so split and fall away from the setting. It is a well-recognized fact that successive firings to a temperature approaching the fusion point, or long continued heating near that temperature, will gradually produce vitrification, which brings about a very dense mass and close texture, and entirely alters the properties of the brick.

Where firebricks are in contact with the furnace charge it is necessary that the texture shall be fairly close, and that the chemical composition of the brick shall be such as to retard the formation of fusible double silicates as much as possible. Where the furnace charge is basic the firebrick should, generally speaking, be basic or aluminous and not siliceous, *i.e.* it should be made from a fireclay containing little free silica, or from such a fireclay to which a high percentage of alumina, lime, magnesia, or iron oxide has been added. For such purposes firebricks are often made from materials containing little or no clay, as for example mixtures of calcined and uncalcined magnesite; mixtures of lime and magnesia and their carbonates; mixtures of bauxite and clay; mixtures of bauxite, clay and plumbago; bauxite and oxide of iron, &c.

In certain cases it is necessary to use an acid brick, and for the manufacture of these a highly siliceous mineral, such as chert or ganister, is used, mixed if necessary with sufficient clay to bind the material together. Dinas fireclay, so-called, and the ganisters of the south Yorkshire coal-fields are largely used for making these siliceous firebricks, which may be also used where the brickwork does not come in contact with basic material, as in the arches, &c., of many furnaces. It is evident that no particular kind of firebrick can be suitable for all purposes, and the manufacturer should endeavour to make his bricks of a definite composition, texture, &c., to meet certain definite requirements, recognizing that the materials at his disposal may be ill-adapted or entirely unsuitable for making firebricks for other purposes. In setting firebricks in position, a thin paste of fireclay and water or of material similar to that of which the brick is composed, must be used in place of ordinary mortar, and the joints should be as close as possible, only just sufficient of the paste being used to enable the bricks to "bed" on one another.

It has long been the practice on certain works to wash the face of firebrick work with a thin paste of some very refractory material—such as kaolin—in order to protect the firebricks from the direct action of the flue gases, &c., and quite recently a thin paste of carborundum and clay, or carborundum and silicate of soda has been more extensively used for the same purpose. So-called carborundum bricks have been put on the market, which have a coating of carborundum and clay fired on to the firebrick, and which are said to have a greatly extended life for certain purposes. It is probable that the carborundum gradually decomposes in the firing, leaving a thin coating of practically pure silica which forms a smooth, impervious and highly-refractory facing. (J. B.*; W. B.*)

FIREFLY, a term popularly used for certain tropical American click-beetles (*Pyrophorus*), on account of their power of emitting light. The insects belong to the family *Elatерidae*, whose characters are described under Coleoptera (*q.v.*). The genus *Pyrophorus* contains about ninety species, and is entirely confined to America and the West Indies, ranging from the southern United States to Argentina and Chile. Its species are locally known as *cucujos*. Except for a few species in the New Hebrides, New Caledonia and Fiji, the luminous *Elatерidae* are unknown in the eastern hemisphere. The light proceeds from a pair of conspicuous smooth ovoid spots on the pronotum and from an area beneath the base of the abdomen. Beneath the cuticle of these regions are situated the luminous organs, consisting of layers of cells which may be regarded as a specialized portion of the

fat-body. Both the male and female fireflies emit light, as well as their larvae and eggs, the egg being luminous even while still in the ovary. The inhabitants of tropical America sometimes keep fireflies in small cages for purposes of illumination, or make use of the insects for personal adornment.

The name "firefly" is often applied also to luminous beetles of the family *Lampyridae*, to which the well-known glow-worm belongs.

FIRE-IRONS, the implements for tending a fire. Usually they consist of poker, tongs and shovel, and they are most frequently of iron, steel, or brass, or partly of one and partly of another. The more elegant brass examples of the early part of the 19th century are much sought after for use with the brass fenders of that date. They were sometimes hung from an ornamental brass stand. The fire-irons of our own times are smaller in size and lighter in make than those of the best period.

FIRENZUOLA, AGNOLO (1493-c. 1545), Italian poet and littérateur, was born at Florence on the 28th of September 1493. The family name was taken from the town of Firenzuola, situated at the foot of the Apennines, its original home. The grandfather of Agnolo had obtained the citizenship of Florence and transmitted it to his family. Agnolo was destined for the profession of the law, and pursued his studies first at Siena and afterwards at Perugia. There he became the associate of the notorious Pietro Aretino, whose foul life he was not ashamed to make the model of his own. They met again at Rome, where Firenzuola practised for a time the profession of an advocate, but with little success. It is asserted by all his biographers that while still a young man he assumed the monastic dress at Vallombrosa, and that he afterwards held successively two abbacies. Tiraboschi alone ventures to doubt this account, partly on the ground of Firenzuola's licentiousness, and partly on the ground of absence of evidence; but his arguments are not held to be conclusive. Firenzuola left Rome after the death of Pope Clement VII., and after spending some time at Florence, settled at Prato as abbot of San Salvatore. His writings, of which a collected edition was published in 1548, are partly in prose and partly in verse, and belong to the lighter classes of literature. Among the prose works are—*Discorsi degli animali*, imitations of Oriental and Aesopian fables, of which there are two French translations; *Dialogo delle bellezze delle donne*, also translated into French; *Ragionamenti amorosi*, a series of short tales in the manner of Boccaccio, rivalling him in elegance and in licentiousness; *Discacciamento delle nuove lettere*, a controversial piece against Trissino's proposal to introduce new letters into the Italian alphabet; a free version or adaptation of *The Golden Ass* of Apuleius, which became a favourite book and passed through many editions; and two comedies, *I Lucidi*, an imitation of the *Menaechmi* of Plautus, and *La Trinzuzia*, which in some points resembles the *Calandria* of Cardinal Bibbiena. His poems are chiefly satirical and burlesque. All his works are esteemed as models of literary excellence, and are cited as authorities in the vocabulary of the Accademia della Crusca. The date of Firenzuola's death is only approximately ascertained. He had been dead several years when the first edition of his writings appeared (1548).

His works have been very frequently republished, separately and in collected editions. A convenient reprint of the whole was issued at Florence in 2 vols. in 1848.

FIRESHIP, a vessel laden with combustibles, floated down on an enemy to set him on fire. Fireships were used in antiquity, and in the middle ages. The highly successful employment of one by the defenders of Antwerp when besieged by the prince of Parma in 1585 brought them into prominent notice, and they were used to drive the Armada from its anchorage at Gravelines in 1588. They continued to be used, sometimes with great effect, as late as the first quarter of the 19th century. Thus in 1809 fireships designed by Lord Cochrane (earl of Dundonald) were employed against the French ships at anchor in the Basque Roads; and in the War of Greek Independence the successes of the Greek fireships against the Ottoman navy, and the consequent demoralization of the ill-disciplined Turkish crews, largely

contributed to secure for the insurgents the command of the sea. In general, however, it was found that fireships hampered the movements of a fleet, were easily sunk by an enemy's fire, or towed aside by his boats, while a premature explosion was frequently fatal to the men who had to place them in position. They were made by building "a fire chamber" between the decks from the forecabin to a bulkhead constructed abaft the mainmast. This space was filled with resin, pitch, tallow and tar, together with gunpowder in iron vessels. The gunpowder and combustibles were connected by trains of powder, and by bundles of brushwood called "bavins." When a fireship was to be used, a body of picked men steered her down on the enemy, and when close enough set her alight, and escaped in a boat which was towed astern. As the service was peculiarly dangerous a reward of £100, or in lieu of it a gold chain with a medal to be worn as a mark of honour, was granted in the British navy to the successful captain of a fireship. A rank of *capitaine de brûlot* existed in the French navy of Louis XIV., and was next to the full captain—or *capitaine de vaisseau*.

FIRE-WALKING, a religious ceremony common to many races. The origin and meaning of the custom is very obscure, but it is shown to have been widespread in all ages. It still survives in Bulgaria, Trinidad, Fiji Islands, Tahiti, India, the Straits Settlements, Mauritius, and it is said Japan. The details of its ritual and its objects vary in different lands, but the essential feature of the rite, the passing of priests, fakirs, and devotees barefoot over heated stones or smouldering ashes is always the same. Fire-walking was usually associated with the spring festivals and was believed to ensure a bountiful harvest. Such was the Chinese vernal festival of fire. In the time of Kublai Khan the Taoist Buddhists held great festivals to the "High Emperor of the Sombre Heavens" and walked through a great fire barefoot, preceded by their priests bearing images of their gods in their arms. Though they were severely burned, these devotees held that they would pass unscathed if they had faith. J. G. Frazer (*Golden Bough*, vol. iii. p. 307) describes the ceremony in the Chinese province of Fo-kien. The chief performers are labourers who must fast for three days and observe chastity for a week. During this time they are taught in the temple how they are to perform their task. On the eve of the festival a huge brazier of charcoal, often twenty feet wide, is prepared in front of the temple of the great god. At sunrise the next morning the brazier is lighted. A Taoist priest throws a mixture of salt and rice into the flames. The two exorcists, barefooted and followed by two peasants, traverse the fire again and again till it is somewhat beaten down. The trained performers then pass through with the image of the god. Frazer suggests that, as the essential feature of the rite is the carrying of the deity through the flames, the whole thing is sympathetic magic designed to give to the coming spring sunshine (the supposed divine emanation), that degree of heat which the image experiences. Frazer quotes Indian fire-walks, notably that of the Dosadhs, a low Indian caste in Behar and Chota Nagpur. On the fifth, tenth, and full moon days of three months in the year, the priest walks over a narrow trench filled with smouldering wood ashes. The Bhuiyas, a Dravidian tribe of Mirzapur, worship their tribal hero Bir by a like performance, and they declare that the walker who is really "possessed" by the hero feels no pain. For fire-walking as observed in the Madras presidency see *Indian Antiquary*, vii. (1878) p. 126; iii. (1874) pp. 6-8; ii. (1873) p. 190 seq. In Fiji the ceremony is called *vilavilarevo*, and according to an eyewitness a number of natives walk unharmed across and among white-hot stones which form the pavement of a huge native oven. In Tahiti priests perform the rite. In April 1899 an Englishman saw a fire-walk in Tokio (see *The Field*, May 20th, 1899). The fire was six yards long by six wide. The rite was in honour of a mountain god. The fire-walkers in Bulgaria are called *Nistinares* and the faculty is regarded as hereditary. They dance in the fire on the 21st of May, the feast of SS. Helena and Constantine. Huge fires of faggots are made, and when these burn down the *Nistinares* (who turn blue in the face) dance on the red-hot

embers and utter prophecies, afterwards placing their feet in the muddy ground where libations of water have been poured.

The interesting part of fire-walking is the alleged immunity of the performers from burns. On this point authorities and eyewitnesses differ greatly. In a case in Fiji a handkerchief was thrown on to the stones when the first man leapt into the oven, and what remained of it snatched up as the last left the stones. Every fold that touched the stone was charred! In some countries a thick ointment is rubbed on the feet, but this is not usual, and the bulk of the reports certainly leave an impression that there is something still to be explained in the escape of the performers from shocking injuries. S. P. Langley, who witnessed a fire-walk in Tahiti, declares, however, that the whole rite as there practised is a mere symbolic farce (*Nature* for August 22nd, 1901).

For a full discussion of the subject with many eyewitnesses' reports in *extenso*, see A. Lang, *Magic and Religion* (1901). See also Dr Gustav Oppert, *Original Inhabitants of India*, p. 480; W. Crooke, *Introd. to Popular Religion and Folklore of Northern India*, p. 10 (1896); *Folklore Journal* for September 1895 and for 1903, vol. xiv. p. 87.

FIREWORKS. In modern times this term is principally associated with the art of "pyrotechny" (Gr. *πῦρ*, fire, and *τέχνη*, art), and confined to the production of pleasing scenic effects by means of fire and inflammable and explosive substances. But the history of the evolution of such displays is bound up with that of the use of such substances not only for scenic display but for exciting fear and for military purposes; and it is consequently complicated by our lack of exact knowledge as to the materials at the disposal of the ancients prior to the invention of gunpowder (see also the article GREEK FIRE). For the following historical account the term "fireworks" is therefore used in a rather general sense.

History.—It is usually stated that from very ancient times fireworks were known in China; it is, however, difficult to assign dates or quote trustworthy authorities. Pyrotechnic displays were certainly given in the Roman circus. While a passage in Manilius,¹ who lived in the days of Augustus, seems to bear this interpretation, there is the definite evidence of Vopiscus² that fireworks were performed for the emperor Carinus and later for the emperor Diocletian; and Claudian,³ writing in the 4th century, gives a poetical description of a set piece, where whirling wheels and dropping fountains of fire were displayed upon the *pegma*, a species of movable framework employed in the various spectacles presented in the circus. After the fall of the Western empire no mention of fireworks can be traced until the Crusaders carried back with them to Europe a knowledge of the incendiary compounds of the East, and gunpowder had made its appearance. Biringuccio,⁴ writing in 1540, says that at an anterior period it had been customary at Florence and Siena to represent a fable or story at the Feast of St John or at the Assumption, and that on these occasions stage properties, including effigies with wooden bodies and plaster limbs, were grouped upon lofty pedestals, and that these figures gave forth flames, whilst round about tubes or pipes were erected for projecting fire-balls into the air: but he adds that these shows were never heard of in his time except at Rome when a pope was elected or crowned. But if relinquished in Italy, fire festivals on the eve of St John were observed both in England and France; the custom was a very old one in the days of Queen Elizabeth,⁵ while De Frezier,⁶ writing in 1707, says it was commonly adhered to in his time, and that on one occasion the king of France himself set a light to the great Paris bonfire. Survivals of these curious rites have been noted quite recently in Scotland and Ireland.⁷ Early use also of fireworks was made in plays and pageants. Hell or hell's mouth was represented by a

¹ Manilius, *Astronomica*, lib. v., 438-443.

² Vopiscus, *Carus, Numerianus et Carinus*, ch. xix.

³ Claudianus, *De consulatu Manlii Theodori*, 325-330.

⁴ Vanuzzio Biringuccio, *Pyrotechnia*.

⁵ Strutt, *Sports and Pastimes of the English People*.

⁶ De Frezier, *Traité des feux d'artifice* (1707 and 1747).

⁷ *Notes and Queries*, series 5, vol. ix. p. 140, and series 8, vol. ii. pp. 145 and 254.

gigantic head out of which flames were made to issue:¹ in the river procession on the occasion of the marriage of Henry VII. and Elizabeth (1487) the "Bachelors' Barge" carried a dragon spouting flames, and Hall relates that at the marriage of Anne Boleyn (1538) "there went before the lord mayor's barge a foyst or wafter full of ordnance, which foyst also carried a great red dragon that spouted out wild fyre and round about were terrible monstrous and wild men casting fire and making a hideous noise."² These individuals were known as "green men." Their clothing was green, they wore fantastic masks, and carried "fire clubs." They were sometimes employed to clear the way at processions.³

Soon after the introduction of gunpowder the gunner and fireworker came into existence; at first they were not soldiers, but civilians who sometimes exercised military functions, and part of their duties was intimately connected with the preparation of fireworks both for peace and war. The emperor Charles V. brought his fireworks under definite regulations in 1535,⁴ and eventually other countries did the same. The *ignes triumphales* were an early form of public fireworks. Scaffold poles were erected with trophies at their summits, while fixed around them were tiers of casks filled with combustibles, so that they presented the appearance of huge flaming trees; at their bases crouched dragons or other mythical beasts. With such a display Antwerp welcomed the archduke of Austria in 1550.⁵ Then the "fire combat" came into fashion. Helmets from which flames would issue were provided for the performers; there were also swords and clubs that would give out sparks at every stroke, lances with fiery points, and bucklers that when struck gave forth a detonation and a flame. A picture of a combat with weapons such as these will be found in Hanzelct's *Recueil de machines militaires* (1620). In addition, the fireworker grew to be somewhat of a scenic artist who could devise a romantic background and fill it with shapes bizarre, beautiful or terrific; he had to make his castle, his cave or his rocky ravine, and people his stage with distressed damsel, errant knight or devouring dragon. Furthermore he had to give motion to the inanimate persons of the drama; thus his dragon would run down an incline on hidden wheels, be actuated by a rope, or be propelled by a rocket.⁶ In 1613 at the marriage of the prince palatine to the daughter of James, the pyrotechnic display was confided to four of the king's gunners, who provided a fiery drama which included a giant, a dragon, a lady, St George, a conjurer, and an enchanted castle, jumbled up together after the approved fashion of the Spenserian legends.⁷ As time went on a more refined taste rejected the bizarre features of the old displays, artistic merit began to creep into the designs, and an effort was made to introduce something appropriate to the occasion. Thus Clarmer of Nuremberg, a well-known fire-worker, celebrated the capture of Rochelle (1613) by an adaptation of the Andromeda legend, where Rochelle was the rock, Andromeda the Catholic religion, the monster Heresy, and Perseus on his Pegasus the all-conquering Louis XIII.⁸ In the first half of the 17th century many books⁹ on fireworks appeared, which avoided the old grotesque ideas and advocated skill and finesse. "It is a rare thing," says Nye

(1648), "to represent a tree or fountain in the air." The most celebrated work of them all was the *Great Art of Artillery* by Siemenowitz, which was considered important enough to be translated into English by order of the Board of Ordnance, nearly eighty years after it had appeared.¹⁰ The classic façade now came into fashion; on it and about it were placed emblematic figures, and disposed around were groups of rockets, Roman candles, &c., musket barrels for projecting stars, and mortars from which were fired shells called balloons, which were full of combustibles. The figures were carved out of wood which was soaped or waxed over and covered with papier mâché so that a skin was formed: this was cut vertically into two parts, removed from the wood, formed into a hollow figure, and filled with fireworks.

National fireworks now assumed a stately and dignified appearance, and for two centuries played a conspicuous part all over Europe in the public expression of thanksgiving or of triumph. Representations and sometimes accounts will be found in the British Museum¹¹ of the more important English displays, from the coronation of James II. down to the peace rejoicings of 1856, during which period national fireworks were provided by the officials of the Ordnance. But since the days of Ranelagh and Vauxhall fireworks have become a subject of private enterprise, and the triumphs of such firms as Messrs Brock or Messrs Pain at the Crystal Palace and elsewhere have been without an official rival. (J. R. J. J.)

Modern Fireworks.—In modern times the art of pyrotechny has been gradually improved by the work of specialists, who have had the advantage of being guided by the progress of scientific chemistry and mechanics. As in all such cases, however, science is useless without the aid of practical experience and acquired manual dexterity.

Many substances have a strong tendency to combine with oxygen, and will do so, in certain circumstances, so energetically as to render the products of the combination (which may be solid matter or gas) intensely hot and luminous. This is the general cause of the phenomenon known as fire. Its special character depends chiefly on the nature of the substances burned and on the manner in which the oxygen is supplied to them. As is well known, our atmosphere contains oxygen gas diluted with about four times its volume of nitrogen; and it is this oxygen which supports the combustion of our coal and candles. But it is not often that the pyrotechnist depends wholly upon atmospheric oxygen for his purposes; for the phenomena of combustion in it are too familiar, and too little capable of variation, to strike with wonder. Two cases, however, where he does so may be instanced, viz. the burning of magnesium powder and of lycopodium, both of which are used for the imitation of lightning in theatres. Nor does the pyrotechnist resort much to the use of pure oxygen, although very brilliant effects may be produced by burning various substances in glass jars filled with the gas. Indeed, the art could never have existed in anything like its present form had not certain solid substances become known which, containing oxygen in combination with other elements, are capable of being made to evolve large volumes of it at the moment it is required. The best examples of these solid *oxidizing agents* are potassium nitrate (nitre or saltpetre) and chlorate; and these are of the first importance in the manufacture of fireworks. If a portion of one of these salts be thoroughly powdered and mixed with the correct quantity of some suitable combustible body,¹² also reduced to powder, the resulting mixture is capable of burning with more or less energy without any aid from atmospheric oxygen, since each small piece of fuel is in close juxtaposition to an available and sufficient store of the gas. All that is required is that the liberation of the oxygen from the solid particles which contain it shall be started by the application of heat from without, and the

¹⁰ Translated by George Shelvocke, 1727, by order of the surveyor-general of the Ordnance.

¹¹ "Crace Collection" in the print-room; the King's Prints and Drawings in the library. See also "The Connection of the Ordnance Department with National and Royal Fireworks," *R. A. Journal*, vol. xxii. No. 11.

¹ J. B. Nichols & Sons, *London Pageants*.

² Hall's *Chronicles*.

³ J. Bate, *Mysteries of Nature and Art* (1635). This contains a picture of a green man.

⁴ *Geschichte des Feuerwerkswesens* (Berlin, 1887). The Jubilee pamphlet of the Brandenburg Artillery.

⁵ See "Fairholts' Collection" bequeathed to the Royal Society of Antiquaries.

⁶ *Journal of the Royal Artillery*, vol. xxxii. No. 11.

⁷ Somers' *Tracts*, vol. iii.

⁸ De Frezier.

⁹ Diego Ufano, *Artillery*, in Spanish (1614); Master Gunner Norton, *The Gunner and The Gunner's Dialogue* (1628); F. de Malthe (Malthus), *Artificial Fireworks*, in French and English (1628); "Hanzelct," *Recueil de plusieurs machines militaires et feux artificiels pour la guerre et récréation* (1620 and 1630); Furtenback, master gunner of Bavaria, *Halinitro Pyrobolito*, in German (1627); (John Babington Matross, *Pyrotechnia*, 1635); Nye, master gunner of Worcester, *Art of Gunnery* (Worcester, 1648); Casimir Siemenowitz, lieutenant-general of the Ordnance to the king of Poland, *The Great Art of Artillery*, in French (1650).

action then goes on unaided. This, then, is the fundamental fact of pyrotechny—that, with proper attention to the chemical nature of the substances employed, solid mixtures (*compositions* or *fuses*) may be prepared which contain within themselves all that is essential for the production of fire.

If nitre and potassium chlorate, with other salts of nitric and chloric acids and a few similar compounds, be grouped together as oxidizing agents, most of the other materials used in making firework compositions may be classed as *oxidizable substances*. Every composition must contain at least one sample of each class: usually there are present more than one oxidizable substance, and very often more than one oxidizing agent. In all cases the proportions by weight which the ingredients of a mixture bear to one another is a matter of much importance, for it greatly affects the manner and rate of combustion. The most important oxidizable substances employed are charcoal and sulphur. These two, it is well known, when properly mixed in certain proportions with the oxidizing agent nitre, constitute gunpowder; and gunpowder plays an important part in the construction of most fireworks. It is sometimes employed alone, when a strong explosion is required; but more commonly it is mixed with one or more of its own ingredients and with other matters. In addition to charcoal and sulphur, the following oxidizable substances are more or less employed:—many compounds of carbon, such as sugar, starch, resins, &c.; certain metallic compounds of sulphur, such as the sulphides of arsenic and antimony; a few of the metals themselves, such as iron, zinc, magnesium, antimony, copper. Of these metals iron (cast-iron and steel) is more used than any of the others. They are all employed in the form of powder or small filings. They do not contribute much to the burning power of the composition; but when it is ignited they become intensely heated and are discharged into the air, where they oxidize more or less completely and cause brilliant sparks and scintillations.

Sand, potassium sulphate, calomel and some other substances, which neither combine with oxygen nor supply it, are sometimes employed as ingredients of the compositions in order to influence the character of the fire. This may be modified in many ways. Thus the rate of combustion may be altered so as to give anything from an instantaneous explosion to a slow fire lasting many minutes. The flame may be clear, smoky, or charged with glowing sparks. But the most important characteristic of a fire—one to which great attention is paid by pyrotechnists—is its *colour*, which may be varied through the different shades and combinations of yellow, red, green and blue. These colours are imparted to the flame by the presence in it of the heated vapours of certain metals, of which the following are the most important:—sodium, which gives a yellow colour; calcium, red; strontium, crimson; barium, green; copper, green or blue, according to circumstances. Suitable salts of these metals are much used as ingredients of fire mixtures; and they are decomposed and volatilized during the process of combustion. Very often the chlorates and nitrates are employed, as they serve the double purpose of supplying oxygen and of imparting colour to the flame.

The number of fire mixtures actually employed is very great, for the requirements of each variety of firework, and of almost each size of each variety, are different. Moreover, every pyrotechnist has his own taste in the matter of compositions. They are capable, however, of being classified according to the nature of the work to which they are suited. Thus there are rocket-fuses, gerbe-fuses, squib-fuses, star-compositions, &c.; and, in addition, there are a few which are essential in the construction of most fireworks, whatever the main composition may be. Such are the *starting-powder*, which first catches the fire, the *bursting-powder*, which causes the final explosion, and the *quick-match* (cotton-wick, dried after being saturated with a paste of gunpowder and starch), employed for connecting parts of the more complicated works and carrying the fire from one to another. Of the general nature of fuses an idea may be had from the following two examples, which are selected at hazard from

among the numerous recipes for making, respectively, tourbillion fire and green stars:—

Tourbillion.		Green Stars.	
Meal gunpowder	24 parts.	Potassium chlorate	16 parts.
Nitre	10 "	Barium nitrate	48 "
Sulphur	7 "	Sulphur	12 "
Charcoal	4 "	Charcoal	1 "
Steel filings	8 "	Shellac	5 "
		Calomel	8 "
		Copper sulphide	2 "

Although the making of compositions is of the first importance, it is not the only operation with which the pyrotechnist has to do; for the construction of the *cases* in which they are to be packed, and the actual processes of packing and finishing, require much care and dexterity. These cases are made of paper or pasteboard, and are generally of a cylindrical shape. In size they vary greatly, according to the effect which it is desired to produce. The relations of length to thickness, of internal to external diameter, and of these to the size of the openings for discharge, are matters of extreme importance, and must always be attended to with almost mathematical exactness and considered in connexion with the nature of the composition which is to be used.

There is one very important property of fireworks that is due more to the mechanical structure of the cases and the manner in which they are filled than to the precise chemical character of the composition, *i.e.* their power of *motion*. Some are so constructed that the piece is kept at rest and the only motion possible is that of the flame and sparks which escape during combustion from the mouth of the case. Others, also fixed, contain, alternately with layers of some more ordinary compositions, balls or blocks of a special mixture cemented by some kind of varnish; and these *stars*, as they are called, shot into the air, one by one, like bullets from a gun, blaze and burst there with striking effect. But in many instances motion is imparted to the firework as a whole—to the case as well as to its contents. This motion, various as it is in detail, is almost entirely one of two kinds—*rotatory* motion round a fixed point, which may be in the centre of gravity of a single piece or that of a whole system of pieces, and *free ascending* motion through the air. In all cases the cause of motion is the same, *viz.* that large quantities of gaseous matter are formed by the combustion, that these can escape only at certain apertures, and that a backward pressure is necessarily exerted at the point opposite to them. When a large gun is discharged, it recoils a few feet. Movable fireworks may be regarded as very light guns loaded with heavy charges; and in them the recoil is therefore so much greater as to be the most noticeable feature of the discharge; and it only requires proper contrivances to make the piece fly through the air like a sky-rocket or revolve round a central axis like a Catherine wheel. Beauty of motion is hardly less important in pyrotechny than brilliancy of fire and variety of colour.

The following is a brief description of some of the forms of firework most employed:—

Fixed Fires.—*Theatre fires* consist of a slow composition which may be heaped in a conical pile on a tile or a flagstone and lit at the apex. They require no cases. Usually the fire is coloured—green, red or blue; and beautiful effects are obtained by illuminating buildings with it. It is also used on the stage; but, in that case, the composition must be such as to give no suffocating or poisonous fumes. *Bengal lights* are very similar, but are piled in saucers, covered with gummed paper, and lit by means of pieces of match. *Marroons* are small boxes wrapped round several times with lincord and filled with a strong composition which explodes with a loud report. They are generally used in *batteries*, or in combination with some other form of firework. *Squibs* are straight cylindrical cases about 6 in. long, firmly closed at one end, tightly packed with a strong composition, and capped with touch-paper. Usually a little bursting-powder is put in before the ordinary composition, so that the fire is finished by an explosion. The character of the fire is, of course, susceptible of great variation in colour, &c. *Crackers* are characterized by the cases being doubled backwards and forwards several times, the folds being pressed close and secured by twine. One end is primed; and when this is lit the cracker burns with a hissing noise, and a loud report occurs every time the fire reaches a bend. If the cracker is placed on the ground, it will give a jump at each report; so that it cannot quite fairly be classed among the fixed fireworks. *Roman candles* are straight cylindrical cases filled

with layers of composition and *stars* alternately. These stars are simply balls of some special composition, usually containing metallic filings, made up with gum and spirits of wine, cut to the required size and shape, dusted with gunpowder and dried. They are discharged like blazing bullets several feet into the air, and produce a beautiful effect, which may be enhanced by packing stars of differently coloured fire in one case. *Gerbes* are choked cases, not unlike Roman candles, but often of much larger size. Their fire spreads like a sheaf of wheat. They may be packed with variously coloured stars, which will rise 30 ft. or more. *Lances* are small straight cases charged with compositions like those used for making stars. They are mostly used in complex devices, for which purpose they are fixed with wires on suitable wooden frames. They are connected by *leaders*, i.e. by quick-match enclosed in paper tubes, so that they can be regulated to take fire all at the same time, singly, or in detachments, as may be desired. The devices and "set pieces" constructed in this way are often of an extremely elaborate character; and they include all the varieties of *lettered designs*, of *fixed suns*, *fountains*, *palm-trees*, *waterfalls*, *mosaic work*, *Highland tarian*, *portraits*, *ships*, &c.

Rotating Fireworks.—*Pin* or *Catherine wheels* are long paper cases filled with a composition by means of a funnel and packing-wire and afterwards wound round a disk of wood. This is fixed by a pin, sometimes vertically and sometimes horizontally; and the outer primed end of the spiral is lit. As the fire escapes the recoil causes the wheel to revolve in an opposite direction and often with considerable velocity. *Pastiles* are very similar in principle and construction. Instead of the case being wound in a spiral and made to revolve round its own centre point, it may be used as the engine to drive a wheel or other form of framework round in a circle. Many varied effects are thus produced, of which the *fire-wheel* is the simplest. Straight cases, filled with some fire-composition, are attached to the end of the spokes of a wheel or other mechanism capable of being rotated. They are all pointed in the same direction at an angle to the spokes, and they are connected together by leaders, so that each, as it burns out, fires the one next it. The pieces may be so chosen that brilliant effects of changing colour are produced; or various fire-wheels of different colours may be combined, revolving in different planes and different directions—some fast and some slowly. *Bisecting wheels*, *plural wheels*, *caprice wheels*, *spiral wheels*, are all more or less complicated forms; and it is possible to produce, by mechanism of this nature, a model in fire of the solar system.

Ascending Fireworks.—*Tourbillions* are fireworks so constructed as to ascend in the air and rotate at the same time, forming beautiful spiral curves of fire. The straight cylindrical case is closed at the centre and at the two ends with plugs of plaster of Paris, the composition occupying the intermediate parts. The fire finds vent by six holes pierced in the case. Two of these are placed close to the ends, but at opposite sides, so that one end discharges to the right and the other to the left; and it is this which imparts the rotatory motion. The other holes are placed along the middle line of what is the under-surface of the case when it is laid horizontally on the ground; and these, discharging downwards, impart an upward motion to the whole. A cross piece of wood balances the tourbillion; and the quick-match and touch-paper are so arranged that combustion begins at the two ends simultaneously and does not reach the holes of ascension till after the rotation is fairly begun. The *sky-rocket* is generally considered the most beautiful of all fireworks; and it certainly is the one that requires most skill and science in its construction. It consists essentially of two parts,—the body and the head. The body is a straight cylinder of strong pasted paper and is choked at the lower end, so as to present only a narrow opening for the escape of the fire. The composition does not fill up the case entirely, for a central hollow conical bore extends from the choked mouth up the body for three-quarters of its length. This is an essential feature of the rocket. It allows of nearly the whole composition being fired at once; the result of which is that an enormous quantity of heated gases collects in the hollow bore, and the gases, forcing their way downwards through the narrow opening, urge the rocket up through the air. The top of the case is closed by a plaster-of-Paris plug. A hole passes through this and is filled with a fuse, which serves to communicate the fire to the head after the body is burned out. This head, which is made separately and fastened on after the body is packed, consists of a short cylindrical paper chamber with a conical top. It serves the double purpose of cutting a way through the air and of holding the *garniture* of stars, sparks, crackers, serpents, gold and silver rain, &c., which are scattered by bursting fire as soon as the rocket reaches the highest point of its path. A great variety of beautiful effects may be obtained by the exercise of ingenuity in the choice and construction of this garniture. Many of the best results have been obtained by unpublished methods which must be regarded as the secrets of the trade. The *stick* of the sky-rocket serves the purpose of guiding and balancing it in its flight; and its size must be accurately adapted to the dimensions of the case. In *winged rockets* the stick is replaced by cardboard wings, which act like the feathers of an arrow. A *girandole* is the simultaneous discharge of a large number of rockets (often from one hundred to two hundred), which either spread like a peacock's tail or pierce the sky in all directions with rushing lines of fire. This is usually the final feat of a great pyrotechnic display.

See Chertier, *Sur les feux d'artifice* (Paris, 1841; 2nd ed., 1854), Mortimer, *Manual of Pyrotechny* (London, 1856); Tessier, *Chimie pyrotechnique, ou traité pratique des feux colorés* (Paris, 1858); Richardson and Watts, *Chemical Technology*, s.v. "Pyrotechny" (London, 1863–1867); Thomas Kentish, *The Pyrotechnist's Treasury* (London, 1878); Websky, *Lufffeuerwerkunst* (Leipzig, 1878).

(O. M.)

FIRM, an adjective originally indicating a dense or close consistency, hence steady, unshaken, unchanging or fixed. This word, in M. Eng. *ferme*, is derived through the French, from Lat. *firmus*. The medieval Latin substantive *firma* meant a fixed payment, either in the way of rent, composition for periodic payments, &c.; and this word, often represented by "firm" in translations of medieval documents, has produced the English "farm" (*q.v.*). From a late Latin use of *firmare*, to confirm by signature, *firma* occurs in many Romanic languages for a signature, and the English "firm" was thus used till the 18th century. From a transferred use came the meaning of a business house. In the Partnership Act 1890, persons who have entered into partnership with one another are called collectively a firm, and the name under which their business is carried on is called the firm-name.

FIRMAMENT, the sky, the heavens. In the Vulgate the word *firmamentum*, which means in classical Latin a strengthening or support (*firmare*, to make firm or strong) was used as the equivalent of *στέρωμα* (*στερεβειν*, to make firm or solid) in the LXX., which translates the Heb. *rāqīya'*. The Hebrew probably signifies literally "expanse," and is thus used of the expanse or vault of the sky, the verb from which it is derived meaning "to beat out." In Syriac the verb means "to make firm," and is the direct source of the Gr. *στέρωμα* and the Lat. *firmamentum*. In ancient astronomy the firmament was the eighth sphere containing the fixed stars surrounding the seven spheres of the planets.

FIRMAN (an adaptation of the Per. *fermān*, a mandate or patent, cognate with the Sanskrit *pramāna*, a measure, authority), an edict of an oriental sovereign, used specially to designate decrees, grants, passports, &c., issued by the sultan of Turkey and signed by one of his ministers. A decree bearing the sultan's sign-manual and drawn up with special formalities is termed a *hatti-sherif*, Arabic words meaning a line, writing or command, and lofty, noble. A written decree of an Ottoman sultan is also termed an *irade*, the word being taken from the Arab. *irādā*, will, volition, order.

FIRMICUS, MATERNUS JULIUS, a Latin writer, who lived in the reign of Constantine and his successors. About the year 346 he composed a work entitled *De erroribus profanarum religionum*, which he inscribed to Constantius and Constans, the sons of Constantine, and which is still extant. In the first part (chs. 1-17) he attacks the false objects of worship among the Oriental cults; in the second (chs. 18-20) he discusses a number of formulae and rites connected with the mysteries. The whole tone of the work is fanatical and declamatory rather than argumentative, and is thus in such sharp contrast with the eight books on astronomy (*Libri VIII. Matheseos*) bearing the same author's name, that the two works have usually been attributed to different writers. Mommsen (*Hermes* vol. 29, pp. 468-472) has, however, shown that the astronomy—a work interlarded with an urbane Neoplatonic spirit—was composed about 336 and not in 354 as was formerly held. When we add to this the similarity of style, and the fact that each betrays a connexion with Sicily, there is the strongest reason for claiming the same author for the two books, though it shows that in the 4th century acceptance of Christianity did not always mean an advance in ethical standpoint.

The Christian work is preserved in a Palatine MS. in the Vatican library. It was first printed at Strassburg in 1562, and has been reprinted several times, both separately and along with the writings of Minucius Felix, Cyprian or Arnobius. The most correct editions are those by Conr. Bursian (Leipzig, 1856), and by C. Halm, in his *Minucius Felix* (*Corp. Scr. Eccl. Lat. ii.*), (Vienna, 1867). The Neoplatonist work was first printed by Aldus Manutius in 1501, and has often been reprinted. For full discussions see G. Ebert, *Gesch. der chr. lat. Litt.*, ed. 1889, p. 129 ff.; O. Bardenhewer, *Patrologie*, ed. 1901, p. 354.

FIRMINY, a town of central France in the department of Loire, 8 m. S.W. of St Etienne by rail. Pop. (1906) 15,778. It has important coal mines known since the 14th century and extensive manufactures of iron and steel goods, including railway material, machinery and cannon. Fancy woollen hosiery is also manufactured.

FIRST-FOOT, in British folklore, especially that of the north and Scotland, the first person who crosses the threshold on Christmas or New Year's Eve. Good or ill luck is believed to be brought the house by First-Foot, and a female First-Foot is regarded with dread. In Lancashire a light-haired man is as unlucky as a woman, and it became a custom for dark-haired males to hire themselves out to "take the New Year in." In Worcestershire luck is ensured by stopping the first carol-singer who appears and leading him through the house. In Yorkshire it must always be a male who enters the house first, but his fairness is no objection. In Scotland first-footing was always more elaborate than in England, involving a subsequent entertainment.

FIRST OF JUNE, BATTLE OF THE. By this name we call the great naval victory won by Lord Howe over the French fleet of Admiral Villaret-Joyeuse, on the 1st of June 1794. No place name can be given to it, because the battle was fought 429 m. to the west of Ushant.

The French people were suffering much distress from the bad harvest of the previous year, and a great convoy of merchant ships laden with corn was expected from America. Admiral Vanstabel of the French navy had been sent to escort it with two ships of the line in December of 1793. He sailed with his charge from the Chesapeake on the 11th of April 1794. On the previous day six French ships of the line left Brest to meet Vanstabel in mid ocean. The British force designed to intercept the convoy was under Lord Howe, then in command of the channel fleet. He sailed from Spithead on the 2nd of May with 34 sail of the line and 15 smaller vessels, having under his charge nearly a hundred merchant ships which were to be seen clear of the Channel. On the 4th, when off the Lizard, the convoy was sent on its way protected by 8 line of battle ships and 6 or 7 frigates. Two of the line of battle ships were to accompany them throughout the voyage. The other six under Rear-admiral Montagu were to go as far as Cape Finisterre, and were then to cruise on the look-out for the French convoy between Cape Ortegal and Belle Isle. These detachments reduced the force under Lord Howe's immediate command to 26 of the line and 7 frigates. On the 5th of May he was off Ushant, and sent frigates to reconnoitre the harbour of Brest. They reported to him that the main French fleet, which was under the command of Villaret-Joyeuse, and was of 25 sail of the line, was lying at anchor in the roads. Howe then sailed to the latitude on which the convoy was likely to be met with, knowing that if the French admiral came out it would be to meet the ships with the food and cover them from attack. To seek the convoy was therefore the most sure way of forcing Villaret-Joyeuse to action. Till the 18th the British fleet continued cruising in the Bay of Biscay. On the 19th Lord Howe returned to Ushant and again reconnoitred Brest. It was then seen that Villaret-Joyeuse had gone to sea. He had sailed with his whole force on the 16th and had passed close to the British fleet on the 17th, unseen in a fog. On the 19th the French admiral was informed by the "Patriote" (74) that Nielly had fallen in with, and had captured, the British frigate "Castor" (32), under Captain Thomas Troubridge, together with a convoy from Newfoundland. On the same day Villaret-Joyeuse captured part of a Dutch convoy of 53 sail from Lisbon. On the 19th a frigate detached by Admiral Montagu joined Howe. It brought information that Montagu had recaptured part of the Newfoundland convoy, and had learnt that Nielly was to join Vanstabel at sea, and that their combined force would be 9 sail of the line. Montagu himself had steered to cruise on the route of the convoy between the 45th and 47th degrees of north latitude. Howe now steered to meet his subordinate who, he considered, would be in danger from the main French fleet. On the 21st he recaptured some of the Dutch

ships taken by Villaret-Joyeuse. From them he learnt that on the 19th the French fleet had been in latitude 47° 46' N. and in longitude 11° 22' N. and was steering westward. Judging that Montagu was too far to the south to be in peril from Villaret-Joyeuse, and considering him strong enough to perform the duty of intercepting the convoy, Lord Howe decided to pursue the main French fleet. The wind was changeable and the weather hazy. It was not till the 28th of May at 6.30 A.M. that the British fleet caught sight of the enemy in 47° 34' N. and 13° 39' W.

The wind was from the south-east, and the French were to windward. Villaret-Joyeuse bore down to a distance of 10 m. from the British, and then hauled to the wind on the port tack. It was difficult for the British fleet to force an action from leeward if the French were unwilling to engage. Lord Howe detached a light squadron of four ships, the "Bellerophon" (74), "Russel" (74), "Marlborough" (74), and "Thunderer" (74) under Rear-admiral Thomas Pasley, to attack the rear of the French line. Villaret-Joyeuse stood on and endeavoured to work to windward. In the course of the afternoon Rear-admiral Pasley's ships began to come up with the last of the French line, the "Révolutionnaire" (110). A partial action took place which went on till after dark; other British vessels joined. The "Révolutionnaire" was so damaged that she was compelled to leave her fleet, and the British "Audacious" (74) was also crippled and compelled to return to port. The "Révolutionnaire" was accompanied by another liner. During the night the two fleets continued on the same course, and next day Howe renewed his attempts to force an action from leeward. He tacked his fleet in succession—his first ship tacking first and the rest in order—in the hope that he would be able to cut through the French rear and gain the weather-gage. Villaret-Joyeuse then turned all his ships together and again headed in the same direction as the British. This movement brought him nearer the British fleet, and another partial action took place between the van of each force. Seeing that the French admiral was not disposed to charge home, Howe at noon once more ordered his fleet to tack in succession. His signal was poorly obeyed by the van, and his object, which was to cut through the French line, was not at once achieved. But the admiral himself finally set an example by tacking his flagship, the "Queen Charlotte" (100), and passing through the French, two ships from the end of their line. He was followed by his fleet, and Villaret-Joyeuse, seeing the peril of the ships in his rear, wore all his ships together to help them. Both forces had been thrown into considerable confusion by these movements, but the British had gained the weather-gage. Villaret-Joyeuse was able to save the two ships cut off, but he had fallen to leeward and the power to force on a battle had passed to Lord Howe. During the 30th the fleets lost sight of one another for a time. The French, who had four ships crippled, had been joined by four others, and were again 26 in number, including the "Patriote."

The 31st of May passed without a hostile meeting and in thick weather, but by the evening the British were close to windward of the French. As Howe, who had not full confidence in all his captains, did not wish for a night battle, he waited till the following morning, keeping the French under observation by frigates. On the 1st of June they were in the same relative positions, and at about a quarter past eight Howe bore down on the French, throwing his whole line on them at once from end to end, with orders to pass through from windward to leeward, and so to place the British ships on the enemy's line of retreat. It was a very bold departure from the then established methods of fighting, and most honourable in a man of sixty-eight, who had been trained in the old school. Its essential merit was that it produced a close *mêlée*, in which the better average gunnery and seamanship of the British fleet would tell. Lord Howe's orders were not fully obeyed by all his captains, but a signal victory was won,—six of the French line of battle ships were taken, and one, the "Vengeur," sunk. The convoy escaped capture, having passed over the spot on which the action of the 20th May was fought, on the following day, and it anchored at

Brest on the 3rd of June. Its safe arrival went far to console the French for their defeat. The failure to stop it was forgotten in England in the pleasure given by the victory.

See James's *Naval History*, vol. i. (1837); and Tronde, *Batailles navales de la France* (1867).

FIRTH, CHARLES HARDING (1857–), British historian, was born at Sheffield on the 16th of March 1857, and was educated at Clifton College and at Balliol College, Oxford. At his university he took the Stanhope prize for an essay on the marquess Wellesley in 1877, became lecturer at Pembroke College in 1887, and fellow of All Souls College in 1901. He was Ford's lecturer in English history in 1900, and became regius professor of modern history at Oxford in succession to F. York Powell in 1904. Firth's historical work was almost entirely confined to English history during the time of the Great Civil War and the Commonwealth; and although he is somewhat overshadowed by S. R. Gardiner, a worker in the same field, his books are of great value to students of this period. The chief of them are: *Life of the Duke of Newcastle* (1886); *Scotland and the Commonwealth* (1895); *Scotland and the Protectorate* (1899); *Narrative of General Venables* (1900); *Oliver Cromwell* (1900); *Cromwell's Army* (1902); and the standard edition of *Ludlow's Memoirs* (1894). He also edited the *Clarke Papers* (1891–1901), and Mrs Hutchinson's *Memoirs of Colonel Hutchinson* (1885), and wrote an introduction to the *Stuart Tracts* (1903), besides contributions to the *Dictionary of National Biography*. In 1909 he published *The Last Years of the Protectorate*.

FIRTH, MARK (1819–1880), English steel manufacturer and philanthropist, was born at Sheffield on the 25th of April 1819, the son of a steel smelter. At the age of fourteen Mark, with his brother, left school to join their father in the foundry where he was employed, and ten years later the three together started a six-hole furnace of their own. The venture proved successful, and besides an extensive home business, they soon established a large American connexion. Their huge Norfolk works were erected at Sheffield in 1849, and still greater were afterwards acquired at Whittington in Derbyshire and others at Clay Wheels near Wadsley. The manufacture of steel blocks for ordnance was the principal feature of their business, and they produced also shot and heavy forgings. They also installed a plant for the production of steel cores for heavy guns, and for some time they supplied nearly all the metal used for gun making by the British government and a large proportion of that used by the French. On the death of his father in 1848 Mark Firth became the head of the firm. In 1869 he built and endowed "Mark Firth's Almshouses" at Ranmoor near Sheffield, and in 1875, when mayor, he presented to his native place a freehold park of thirty-six acres. He founded and endowed Firth College, for lectures and classes in connexion with the extension of university education, which was opened in 1879. He died on the 28th of November 1880, and was accorded a public funeral.

FIRUZABAD, a town of Persia, in the province of Fars, 72 m. S. of Shiraz, in 28° 51' N. Pop. about 3000. It is situated in a fertile plain, 15 m. long and 7 m. broad, well watered by the river Khoja which flows through it from north to south. The town is surrounded by a mud wall and ditch. Three or four miles north-west of the town are the ruins of the ancient city and of a large building popularly known as the fire-temple of Ardashir, and beyond them on the face of the rock in the gorge through which the river enters the plain are two Sassanian bas-reliefs.

The river leaves the plain by a narrow gorge at the southern end, and according to Persian history it was there that Alexander the Great, when unable to capture the ancient city, built a dike across the gorge, thus damming up the water of the river and turning the plain into a lake and submerging the city and villages. The lake remained until the beginning of the 3rd century, when Ardashir, the first Sassanian monarch, drained it by destroying the dike. He built a new city, called it Gür, and made it the capital of one of the five great provinces or divisions of Fars. Firuz (or Peroz, *q.v.*), one of Ardashir's successors, called the district after his name Firuzabad ("the

abode of Firuz"), but the name of the city remained Gür until Azud ed Dowleh (Adod addaula) (949–982) changed it to its present name. He did this because he frequently resided at Gür, and the name meaning also "a grave" gave rise to unpleasant allusions, for instance, "People who go to Gür (grave) never return alive; our king goes to Gür (the town) several times a year and is not dead yet."

The district has twenty villages and produces much wheat and rice. It is said that the rice of Firuzabad bears sixty-fold. (A. H.-S.)

FIRÜZKŪH, a small province of Persia, with a population of about 5000, paying a yearly revenue of about £500. Its chief place is a village of the same name picturesquely situated in a valley of the Elburz, about 90 m. east of Teheran, at an elevation of 6700 ft. and in 35° 46' N. and 52° 48' E. It has post and telegraph offices and a population of 2500. A precipitous cliff on the eastern side of the valley is surmounted by the ruins of an ancient fort popularly ascribed to Alexander the Great.

FISCHART, JOHANN (c. 1545–1591), German satirist and publicist, was born, probably at Strassburg (but according to some accounts at Mainz), in or about the year 1545, and was educated at Worms in the house of Kaspar Scheid, whom in the preface to his *Eulenspiegel* he mentions as his "cousin and preceptor." He appears to have travelled in Italy, the Netherlands, France and England, and on his return to have taken the degree of *doctor juris* at Basel. From 1575 to 1581, within which period most of his works were written, he lived with, and was probably associated in the business of, his sister's husband, Bernhard Jobin, a printer at Strassburg, who published many of his books. In 1581 Fischart was attached, as advocate to the Reichskammergericht (imperial court of appeal) at Spire, and in 1583, when he married, was appointed *Amtmann* (magistrate) at Forbach near Saarbrücken. Here he died in the winter of 1590–1591. Fischart wrote under various feigned names, such as Mentzer, Menzer, Reznem, Huldreich Elloposkleros, Jesuwalt Pickhart, Winhold Alkofribas Wüstblutus, Ulrich Mansehr von Treubach, and Im Fischen Gilt's Mischen; and it is partly owing to this fact that there is doubt whether some of the works attributed to him are really his. More than 50 satirical works, however, both in prose and verse, remain authentic, among which are—*Nachtrab oder Nebelkräh* (1570), a satire against one Jakob Rabe, who had become a convert to the Roman Catholic Church; *Von St Dominici des Predigermönchs und St Francisci Barfüssers arlichem Leben* (1571), a poem with the expressive motto "Sie haben Nasen vnd riechen's nit" (Ye have noses and smell it not), written to defend the Protestants against certain wicked accusations, one of which was that Luther held communion with the devil; *Eulenspiegel Reimensweis* (written 1571, published 1572); *Aller Praktik Grossmutter* (1572), after Rabelais's *Prognostication Pantagrueline*; *Flöh Haz, Weiber Traz* (1573), in which he describes a battle between fleas and women; *Affentheuerliche und ungeheuerliche Geschichtschrift vom Leben, Rhaten und Thaten der . . . Helden und Herren Grandgusier Gargantua und Pantagruel*, also after Rabelais (1575, and again under the modified title, *Naupen-geheuerliche Geschichtkitterung*, 1577); *Neue künstliche Figuren biblischer Historien* (1576); *Anmahnung zur christlichen Kinderzucht* (1576); *Das glückhafte Schiff von Zürich* (1576, republished 1828, with an introduction by the poet Ludwig Uhland), a poem commemorating the adventure of a company of Zürich arquebusiers, who sailed from their native town to Strassburg in one day, and brought, as a proof of this feat, a kettleful of *Hirsebrei* (millet), which had been cooked in Zürich, still warm into Strassburg, and intended to illustrate the proverb "perseverance overcomes all difficulties"; *Podagrammisch Trostbüchlein* (1577); *Philosophisch Ehezuchtbüchlein* (1578); the celebrated *Bienenkorb des heiligen römischen Immenschwirms*, &c., a modification of the Dutch *De roomsche Byen-Korf*, by Philipp Marnix of St Aldegonde, published in 1579 and reprinted in 1847; *Der heilig Brotkorb* (1580), after Calvin's *Traité des reliques*; *Das vierhörnige Jesuiterhüllein*, a rhymed satire against the Jesuits (1580); and a number of smaller poems.

To Fischart also have been attributed some "Psalmen und geistliche Lieder" which appeared in a Strassburg hymn-book of 1576.

Fischart had studied not only the ancient literatures, but also those of Italy, France, the Netherlands and England. He was a lawyer, a theologian, a satirist and the most powerful Protestant publicist of the counter-reformation period; in politics he was a republican. Above all, he is a master of language, and was indefatigable with his pen. His satire was levelled mercilessly at all perversities in the public and private life of his time—at astrological superstition, scholastic pedantry, ancestral pride, but especially at the papal dignity and the lives of the priesthood and the Jesuits. He indulged in the wildest witticisms, the most abandoned caricature; but all this he did with a serious purpose. As a poet, he is characterized by the eloquence and picturesqueness of his style and the symbolical language he employed. Thirty years after Fischart's death his writings, once so popular, were almost entirely forgotten. Recalled to the public attention by Johann Jakob Bodmer and Gotthold Ephraim Lessing, it is only recently that his works have come to be a subject of investigation, and his position in German literature to be fully understood.

Freiherr von Meusebach, whose valuable collection of Fischart's works has passed into the possession of the royal library in Berlin, deals in his *Fischartstudien* (Halle, 1879) with the great satirist. Fischart's poetical works were published by Hermann Kurz in three volumes (Leipzig, 1866-1868); and selections by K. Goedeke (Leipzig, 1800) and by A. Hauffen in Kürschner's *Deutsche National-literatur* (Stuttgart, 1893); *Die Geschichtsklitterung* and some minor writings appeared in Scheible's *Kloster*, vols. 7 and 10 (Stuttgart, 1847-1848). *Das glückhafte Schiff* has been frequently reprinted, critical edition by J. Baechtold (1880). See for further biographical details, Erich Schmidt in the *Allgemeine deutsche Biographie*, vol. 7; A. F. C. Vilmar in Ersch and Gruber's *Encyclopaedie*; W. Wackernagel, *Johann Fischart von Strassburg und Basels Anteil an ihm* (2nd ed., Basel, 1875); P. Besson, *Étude sur Jean Fischart* (Paris, 1889); and A. Hauffen, "Fischart-Studien" (in *Euphorion*, 1896-1909).

FISCHER, EMIL (1852-), German chemist, was born at Euskirchen, in Rhenish Prussia, on the 9th of October 1852, his father being a merchant and manufacturer. After studying chemistry at Bonn, he migrated to Strassburg, where he graduated as Ph.D. in 1874. He then acted as assistant to Adolf von Baeyer at Munich for eight years, after which he was appointed to the chair of chemistry successively at Erlangen (1882) and Würzburg (1885). In 1892 he succeeded A. W. von Hofmann as professor of chemistry at Berlin. Emil Fischer devoted himself entirely to organic chemistry, and his investigations are characterized by an originality of idea and readiness of resource which make him the master of this branch of experimental chemistry. In his hands no substance seemed too complex to admit of analysis or of synthesis; and the more intricate and involved the subjects of his investigations the more strongly shown is the conspicuous skill in pulling, as it were, atom from atom, until the molecule stood revealed, and, this accomplished, the same skill combined atom with atom until the molecule was regenerated. His *forte* was to enter fields where others had done little except break the ground; and his researches in many cases completely elucidated the problem in hand, and where the solution was not entire, his methods and results almost always contained the key to the situation.

In 1875, the year following his engagement with von Baeyer, he published his discovery of the organic derivatives of a new compound of hydrogen and nitrogen, which he named hydrazine (*q.v.*). He investigated both the aromatic and aliphatic derivatives, establishing their relation to the diazo compounds, and he perceived the readiness with which they entered into combination with other substances, giving origin to a wealth of hitherto unknown compounds. Of such condensation products undoubtedly the most important are the hydrazones, which result from the interaction with aldehydes and ketones. His observations, published in 1886, that such hydrazones, by treatment with hydrochloric acid or zinc chloride, yielded derivatives of indol, the pyrrol of the benzene series and the parent substance of indigo, were a valuable confirmation of the views advanced by his master, von Baeyer, on the subject of indigo and the many substances related to it. Of greater moment was his discovery that phenyl hydrazine reacted with the sugars to form

substances which he named osazones, and which, being highly crystalline and readily formed, served to identify such carbohydrates more definitely than had been previously possible. He next turned to the rosaniline dyestuffs (the magenta of Sir W. H. Perkin), and in collaboration with his cousin Otto Fischer (b. 1852), then at Munich and afterwards professor at Erlangen, who has since identified himself mainly with the compounds of this and related groups, he published papers in 1878 and 1879 which indubitably established that these dyestuffs were derivatives of triphenyl methane. Fischer's next research was concerned with compounds related to uric acid. Here the ground had been broken more especially by von Baeyer, but practically all our knowledge of the so-called purin group (the word *purin* appears to have been suggested by the phrase *purum uricum*) is due to Fischer. In 1881-1882 he published papers which established the formulae of uric acid, xanthine, caffeine, theobromine and some other compounds of this group. But his greatest work in this field was instituted in 1894, when he commenced his great series of papers, wherein the compounds above mentioned were all referred to a nitrogenous base, purin (*q.v.*). The base itself was obtained, but only after much difficulty; and an immense series of derivatives were prepared, some of which were patented in view of possible therapeutical applications.¹ These researches were published in a collected form in 1907 with the title *Untersuchungen in der Puringruppe* (1882-1906). The first stage of his purin work successfully accomplished, he next attacked the sugar group. Here the pioneer work was again of little moment, and Fischer may be regarded as the prime investigator in this field. His researches may be taken as commencing in 1883; and the results are unparalleled in importance in the history of organic chemistry. The chemical complexity of these carbohydrates, and the difficulty with which they could be got into a manageable form—they generally appeared as syrups—occasioned much experimental difficulty; but these troubles were little in comparison with the complications due to stereochemical relations. However, Fischer synthesized fructose, glucose and a great number of other sugars, and having showed how to deduce, for instance, the formulae of the 16 stereoisomeric glucoses, he prepared several stereoisomerides, thereby completing a most brilliant experimental research, and simultaneously confirming the van't Hoff theory of the asymmetric carbon atom (see STEREO-ISOMERISM). The study of the sugars brought in its train the necessity for examining the nature, properties and reactions of substances which bring about the decomposition known as fermentation (*q.v.*). Fischer attacked the problem presented by ferments and enzymes, and although we as yet know little of this complex subject, to Fischer is due at least one very important discovery, viz. that there exists some relation between the chemical constitution of a sugar and the ferment and enzyme which breaks it down. The magnitude of his researches in this field may be gauged by his collected papers, *Untersuchungen über Kohlenhydrate und Fermente* (1884-1908), pp. viii. + 912 (Berlin, 1909).

From the sugars and ferments it is but a short step to the subject of the proteins, substances which are more directly connected with life processes than any others. The chemistry of the proteins, a subject which bids fair to be Fischer's great lifework, presents difficulties which are probably without equal in the whole field of chemistry, partly on account of the extraordinary chemical complexity of the substances involved, and partly upon the peculiar manner in which chemical reactions are brought about in the living organism. But by the introduction of new methods, Fischer succeeded in breaking down the complex albuminoid substances into amino acids and other nitrogenous compounds, the constitutions of most of which have been solved; and by bringing about the recombination of these units, appropriately chosen, he prepared synthetic peptides which approximate to the natural products. His methods led to the preparation of an octadeca-peptide of the molecular weight 1213, exceeding that of any other synthetic compound; but even this compound falls far short of the simplest natural peptide, which has a molecular weight of from 2000 to 3000. He considers, however, that the synthesis of more complex products is only a matter of trouble and cost. His researches made from 1899 to 1906 have been published with the title *Untersuchungen über Aminosäuren, Polypeptides und Proteine* (Berlin, 1907). The extraordinary merit of his many researches has been recognized by all the important scientific societies in the world, and he was awarded the Nobel prize for chemistry in 1902. Under his control the laboratory at Berlin became one of the most important in existence, and has attracted to it a constant stream of brilliant pupils, many of whom are to be associated with much of the experimental work indissolubly connected with Fischer.

FISCHER, ERNST KUNO BERTHOLD (1824-1907), German philosopher, was born at Sandewalde in Silesia, on the 23rd of July 1824. After studying philosophy at Leipzig and Halle, he became a privat-docent at Heidelberg in 1850. The Baden government in 1853 laid an embargo on his teaching owing to

¹ For a brief review of the pharmacology of purin derivatives see F. Francis and J. M. Fortescue-Brinkdale, *The Chemical Basis of Pharmacology* (1908).

his Liberal ideas, but the effect of this was to rouse considerable sympathy for his views, and in 1856 he obtained a professorship at Jena, where he soon acquired great influence by the dignity of his personal character. In 1872, on Zeller's removal to Berlin, Fischer succeeded him as professor of philosophy and the history of modern German literature at Heidelberg, where he died on the 4th of July 1907. His part in philosophy was that of historian and commentator, for which he was especially qualified by his remarkable clearness of exposition; his point of view is in the main Hegelian. His *Geschichte der neuern Philosophie* (1852–1893, new ed. 1897) is perhaps the most accredited modern book of its kind, and he made valuable contributions to the study of Kant, Bacon, Shakespeare, Goethe, Spinoza, Lessing, Schiller and Schopenhauer.

Some of his numerous works have been translated into English: *Francis Bacon of Verulam*, by J. Oxenford (1857); *The Life and Character of Benedict Spinoza*, by Frida Schmidt (1882); *A Commentary on Kant's Kritik of Pure Reason*, by J. P. Mahaffy (1866); *Descartes and his School*, by J. P. Gordy (1887); *A Critique of Kant*, by W. S. Hough (1888); see also H. Falkenheim, *Kuno Fischer und die litterar-historische Methode* (1892); and bibliography in J. M. Baldwin's *Dictionary of Philosophy and Psychology* (1905).

FISH, HAMILTON (1808–1893), American statesman, was born in New York City on the 3rd of August 1808. His father, Nicholas Fish (1758–1833), served in the American army during the War of American Independence, rising to the rank of lieutenant-colonel. The son graduated at Columbia College in 1827, and in 1830 was admitted to the bar, but practised only a short time. In 1843–1845 he was a Whig representative in Congress. He was the Whig candidate for lieutenant-governor of New York in 1846, and was defeated by Addison Gardner (Democrat); but when in 1847 Gardner was appointed a judge of the state court of appeals, Fish was elected (November 1847) to complete the term (to January 1849). He was governor of New York state from 1849 to 1851, and was United States senator in 1851–1857, acting with the Republicans during the last part of his term. In 1861–1862 he was associated with John A. Dix, William M. Evarts, William E. Dodge, A. T. Stewart, John Jacob Astor, and other New York men, on the Union Defence Committee, which (from April 22, 1861, to April 30, 1862) co-operated with the municipal government in the raising and equipping of troops, and disbursed more than a million dollars for the relief of New York volunteers and their families. Fish was secretary of state during President Grant's two administrations (1869–1877). He conducted the negotiations with Great Britain which resulted in the treaty of the 8th of May 1871, under which (Article 1) the "Alabama claims" were referred to arbitration, and the same disposition (Article 34) was made of the "San Juan Boundary Dispute," concerning the Oregon boundary line. In 1871 Fish presided at the Peace Conference at Washington between Spain and the allied republics of Peru, Chile, Ecuador and Bolivia, which resulted in the formulation (April 12) of a general truce between those countries, to last indefinitely and not to be broken by any one of them without three years' notice given through the United States; and it was chiefly due to his restraint and moderation that a satisfactory settlement of the "Virginus Affair" was reached by the United States and Spain (1873). Fish was vice-president-general of the Society of the Cincinnati from 1848 to 1854, and president-general from 1854 until his death. He died in Garrison, New York, on the 7th of September 1893.

His son, **NICHOLAS FISH** (1846–1902), was appointed second secretary of legation at Berlin in 1871, became secretary in 1874, and was *chargé d'affaires* at Berne in 1877–1881, and minister to Belgium in 1882–1886, after which he engaged in banking in New York City.

FISH (O. Eng. *fisc*, a word common to Teutonic languages, cf. Dutch *visch*, Ger. *Fisch*, Goth. *fisks*, cognate with the Lat. *piscis*), the common name of that class of vertebrate animals which lives exclusively in water, breathes through gills, and whose limbs take the form of fins (see **ICHTHYOLOGY**). The article **FISHERIES** deals with the subject from the economic and commercial point of view, and **ANGLING** with the catching of

fish as a sport. The constellation and sign of the zodiac known as "the fishes" is treated under **PISCES**.

The fish was an early symbol of Christ in primitive and medieval Christian art. The origin is to be found in the initial letters of the names and titles of Jesus in Greek, viz. Ἰησοῦς Χριστός, Θεοῦ Υἱός, Σώτηρ, Jesus Christ, Son of God, Saviour, which together spell the Greek word for "fish," ἰχθῆς. The fish is also said to be represented in the oval-shaped figure, pointed at both ends, and formed by the intersection of two circles. This figure, also known as the *vesica piscis*, is common in ecclesiastical seals and as a glory or aureole in paintings of sculpture, surrounding figures of the Trinity, saints, &c. The figure is, however, sometimes referred to the almond, as typifying virginity; the French name for the symbol is *Amande mystique*.

The word "fish" is used in many technical senses. Thus it is used of the purchase used in raising the flukes of an anchor to the bill-board; of a piece of wood or metal used to strengthen a sprung mast or yard; and of a plate of metal used, as in railway construction, for the strengthening of the meeting-place of two rails. This word is of doubtful origin, but it is probably an adaptation of the Fr. *fiche*, that which "fixes," a peg. This word also appears in the English form "fish," in the metal, pearl or bone counters, sometimes made in the form of fish, used for scoring points, &c., in many games.

FISHER, ALVAN (1792–1863), American portrait-painter, was born at Needham, Massachusetts, on the 9th of August 1792. At the age of eighteen he was a clerk in a country shop, and subsequently was employed by the village house painter, but at the age of twenty-two he began to paint portrait heads, alternating with rural scenes and animals, for which he found patrons at modest prices. In ten years he had saved enough to go to Europe, studying at the Paris schools and copying in the galleries of the Louvre. Upon his return he became one of the recognized group of Massachusetts portrait-painters. Along with Doughty, Harding and Alexander, in 1831, he held an exhibition of his work in Boston—perhaps the first joint display by painters ever held in that city. Though he had considerable talent for landscape, a lack of patronage for such work caused him to confine himself to portraiture, in which he was moderately successful. He died at Dedham, Mass., on the 16th of February 1863.

FISHER, GEORGE PARK (1827–1909), American theologian, was born at Wrentham, Massachusetts, on the 10th of August 1827. He graduated at Brown University in 1847, and at the Andover Theological Seminary in 1851, spent three years in study in Germany, was college preacher and professor of divinity at Yale College in 1854–1861, and was Titus Street professor of ecclesiastical history in the Yale Divinity School in 1861–1901, when he was made professor *emeritus*. He was president of the American Historical Association in 1897–1898. His writings have given him high rank as an authority on ecclesiastical history. They include *Essays on the Supernatural Origin of Christianity* (1865); *History of the Reformation* (1873), republished in several revisions; *The Beginnings of Christianity* (1877); *Discussions in History and Theology* (1880); *Outlines of Universal History* (1886); *History of the Christian Church* (1887); *The Nature and Method of Revelation* (1890); *Manual of Natural Theology* (1893); *A History of Christian Doctrine*, in the "International Theological Library" (1896); and *A Brief History of Nations* (1896). He died on the 20th of December 1909.

FISHER, JOHN (c. 1469–1535), English cardinal and bishop of Rochester, born at Beverly, received his first education at the collegiate church there. In 1484 he went to Michael House, Cambridge, where he took his degrees in arts in 1487 and 1491, and, after filling several offices in the university, became master of his college in 1499. He took orders; and his reputation for learning and piety attracted the notice of Margaret Beaufort, mother of Henry VII., who made him her confessor and chaplain. In 1501 he became vice-chancellor; and later on, when chancellor, he was able to forward, if not to initiate entirely, the beneficent schemes of his patroness in the foundations of St. John's and Christ's colleges, in addition to two lectureships, in Greek

and Hebrew. His love for Cambridge never waned, and his own benefactions took the form of scholarships, fellowships and lectures. In 1503 he was the first Margaret professor at Cambridge; and the following year was raised to the see of Rochester, to which he remained faithful, although the richer sees of Ely and Lincoln were offered to him. He was nominated as one of the English prelates for the Lateran council (1512), but did not attend. A man of strict and simple life, he did not hesitate at the legatine synod of 1517 to censure the clergy, in the presence of the brilliant Wolsey himself, for their greed of gain and love of display; and in the convocation of 1523 he freely opposed the cardinal's demand for a subsidy for the war in Flanders. A great friend of Erasmus, whom he invited to Cambridge, whilst earnestly working for a reformation of abuses, he had no sympathy with those who attacked doctrine; and he preached at Paul's Cross (12th of May 1521) at the burning of Luther's books. Although he was not the author of Henry's book against Luther, he joined with his friend, Sir Thomas More, in writing a reply to the scurrilous rejoinder made by the reformer. He retained the esteem of the king until the divorce proceedings began in 1527; and then he set himself sternly in favour of the validity of the marriage. He was Queen Catherine's confessor and her only champion and advocate. He appeared on her behalf before the legates at Blackfriars; and wrote a treatise against the divorce that was widely read.

Recognizing that the true aim of the scheme of church reform brought forward in parliament in 1529 was to put down the only moral force that could withstand the royal will, he energetically opposed the reformation of abuses, which doubtless under other circumstances he would have been the first to accept. In convocation, when the supremacy was discussed (11th of February 1531), he declared that acceptance would cause the clergy "to be hissed out of the society of God's holy Catholic Church"; and it was his influence that brought in the saving clause, *quantum per legem Dei licet*. By listening to the revelations of the "Holy Maid of Kent," the nun Elizabeth Barton (*q.v.*), he was charged with misprision of treason, and was condemned to the loss of his goods and to imprisonment at the king's will, penalties he was allowed to compound by a fine of £300 (25th of March 1534). Fisher was summoned (13th of April) to take the oath prescribed by the Act of Succession, which he was ready to do, were it not that the preamble stated that the offspring of Catherine were illegitimate, and prohibited all faith, trust and obedience to any foreign authority or potentate. Refusing to take the oath, he was committed (15th of April) to the Tower, where he suffered greatly from the rigours of a long confinement. On the passing of the Act of Supremacy (November 1534), in which the saving clause of convocation was omitted, he was attainted and deprived of his see. The council, with Thomas Cromwell at their head, visited him on the 7th of May 1535, and his refusal to acknowledge Henry as supreme head of the church was the ground of his trial. The constancy of Fisher, while driving Henry to a fury that knew no bounds, won the admiration of the whole Christian world, where he had been long known as one of the most learned and pious bishops of the time. Paul III., who had begun his pontificate with the intention of purifying the curia, was unaware of the grave danger in which Fisher lay; and in the hope of reconciling the king with the bishop, created him (20th of May 1535) cardinal priest of St Vitalis. When the news arrived in England it sealed his fate. Henry, in a rage, declared that if the pope sent Fisher a hat there should be no head for it. The cardinal was brought to trial at Westminster (17th of June 1535) on the charge that he did "openly declare in English that the king, our sovereign lord, is not supreme head on earth of the Church of England," and was condemned to a traitor's death at Tyburn, a sentence afterwards changed. He was beheaded on Tower Hill on the 22nd of June 1535, after saying the *Te Deum* and the psalm *In te Domine speravi*. His body was buried first at All Hallows, Barking, and then removed to St. Peter's *ad vincula* in the Tower, where it lies beside that of Sir Thomas More. His head was exposed on London Bridge and then thrown into the river. As

a champion of the rights of conscience, and as the only one of the English bishops that dared to resist the king's will, Fisher commends himself to all. On the 9th of December 1886 he was beatified by Pope Leo XIII.

Fisher's Latin works are to be found in the *Opera J. Fisheri quae hactenus inveniri potuerunt omnia* (Würzburg, 1595), and some of his published English works in the Early English Text Society (Extra series, No. 27, part i. 1876). There are others in manuscript at the P.R.O. (27, Henry VIII., No. 887). Besides the State papers, the main sources for his biography are *The Life and Death of that renowned John Fisher, Bishop of Rochester* (London, 1655), by an anonymous writer, the best edition being that of Van Ortrooy (Brussels, 1893); *Bridgett's Life of Blessed John Fisher, Bishop of Rochester* (London, 1880 and 1890); and Thureau, *Le bienheureux Jean Fisher* (Paris, 1907). (E. TN.)

FISHER, JOHN ARBUTHNOT FISHER, 1ST BARON (1841-), British admiral, was born on the 25th of January 1841, and entered the navy in June 1854. He served in the Baltic during the Crimean War, and was engaged as midshipman on the "Highflyer," "Chesapeake" and "Furious," in the Chinese War, in the operations required by the occupations of Canton, and of the Peiho forts in 1859. He became sub-lieutenant on the 25th of January 1860, and lieutenant on the 4th of November of the same year. The cessation of naval wars, at least of wars at sea in which the British navy had to take a part, after 1860, allowed few officers to gain distinction by actual services against the enemy. But they were provided with other ways of proving their ability by the sweeping revolution which transformed the construction, the armament, and the methods of propulsion of all the navies of the world, and with them the once accepted methods of combat. Lieutenant Fisher began his career as a commissioned officer in the year after the launching of the French "Gloire" had set going the long duel in construction between guns and armour. He early made his mark as a student of gunnery, and was promoted commander on the 2nd of August 1869, and post-captain on the 30th of October 1874. In this rank he was chosen to serve as president of the committee appointed to revise "The Gunnery Manual of the Fleet." It was his already established reputation which pointed Captain Fisher out for the command of H.M.S. "Inflexible," a vessel which, as the representative of a type, had supplied matter for much discussion. As captain of the "Inflexible" he took part in the bombardment of Alexandria (11th July 1882). The engagement was not arduous in itself, having been carried out against forts of inferior construction, indifferently armed, and worse garrisoned, but it supplied an opportunity for a display of gunnery, and it was conspicuous in the midst of a long naval peace. The "Inflexible" took a prominent part in the action, and her captain had the command of the naval brigade landed in Alexandria, where he adapted the ironclad train and commanded it in various skirmishes with the enemy. After the Egyptian campaign, he was, in succession, director of Naval Ordnance and Torpedoes (from October 1886 to May 1891); A.D.C. to Queen Victoria (18th June, 1887, to 2nd August 1890, at which date he became rear-admiral); admiral superintendent of Portsmouth dockyard (1891 to 1892); a lord commissioner of the navy and comptroller of the navy (1892 to 1897), and vice-admiral (8th May 1896); commander-in-chief on the North American and West Indian station (1897). In 1899 he acted as naval expert at the Hague Peace Conference, and on the 1st of July 1899 was appointed commander-in-chief in the Mediterranean. From the Mediterranean command, Admiral Fisher passed again to the admiralty as second sea lord in 1902, and became commander-in-chief at Portsmouth on the 31st of August 1903, from which post he passed to that of first sea lord. Besides holding the foreign Khedivial and Osmanieh orders, he was created K.C.B. in 1894 and G.C.B. in 1902. As first sea lord, during the years 1903-1909, Sir John Fisher had a predominant influence in all the far-reaching new measures of naval development and internal reform; and he was also one of the committee, known as Lord Esher's committee, appointed in 1904 to report on the measures necessary to be taken to put the administration and organization of the British army on a sound footing. The changes in naval administration made

under him were hotly canvassed among critics, who charged him with autocratic methods, and in 1906-1909 with undue subservience to the government's desire for economy; and whatever the efficiency of his own methods at the admiralty, the fact was undeniable that for the first time for very many years the navy suffered, as a service, from the party-spirit which was aroused. It was notorious that Admiral Lord Charles Beresford in particular was acutely hostile to Sir John Fisher's administration; and on his retirement in the spring of 1909 from the position of commander-in-chief of the Channel fleet, he put his charges and complaints before the government, and an inquiry was held by a small committee under the Prime Minister. Its report, published in August, was in favour of the Admiralty, though it encouraged the belief that some important suggestions as to the organization of a naval "general staff" would take effect. On the 9th of November Sir John Fisher was created a peer as Baron Fisher of Kilverstone, Norfolk. He retired from the Admiralty in January 1910.

FISHERIES,¹ a general term for the various operations engaged in for the capture of such aquatic creatures as are useful to man. From time immemorial fish have been captured by various forms of spears, nets, hooks and more elaborate apparatus, and a historical description of the methods and appliances that have been used would comprise a considerable portion of a treatise on the history of man. For the most part the operations of fishing have been comparable with those of primitive hunting rather than with agriculture; they have taken the least possible account of considerations affecting the supply; when one locality has been fished out, another has been resorted to. The increasing pressure on every source of food, and the enormous improvements in the catching power of the engines involved, has made some kind of regulation and control inevitable, with the result that in practically every civilized country there exists some authority for the investigation and regulation of fisheries.

The annexed table shows the department of state and the

The early years of the 20th century witnessed another great expansion of the sea fisheries of the United Kingdom. The herring fishery has been revolutionized partly by the successful introduction of steam drifters, which have markedly increased the aggregate catching power, and partly by the prosecution of the fishery on one part or other of the British coasts during the greater part of the year. The crews of many Scottish vessels which formerly worked at the herring and line fisheries in alternate seasons of the year now devote their energies almost entirely to the herring fishery, which they pursue in nomad fleets around all the coasts of Great Britain. The East Anglian drifters carry on their operations at different seasons of the year from Shetland in the north (for herrings) to Newlyn in the west (for mackerel). In Scotland the value of the nets employed on steam drifters has increased from £3000 in 1899 to £61,000 in 1906, and the average annual catch of herrings has increased from about four to about five million cwts. during the past ten years. In England also the annual catch of herrings, which reached a total of two million cwts. for the first time in 1899, has exceeded three millions in each year from 1902 to 1905.

In steam trawling also great enterprise has been shown. In 1906 Messrs Hellyer of Hull launched a new steam trawling fleet of 50 vessels for working the North Sea grounds, and the delivery of new steam trawlers at Grimsby was greater than at any previous period, these vessels being designed more especially to exploit the distant fishing grounds, the range of which has been extended from Morocco to the White Sea. About 100 vessels were added to the Grimsby fleet in the course of twelve months. These new vessels measure about 140 ft. in length and over 20 ft. in beam, and exceed 250 tons gross tonnage, the accommodation both for fish and crews being considerably in excess of that provided in vessels of this class hitherto.

Returns of the steam trawlers registered in 1907 in the chief European countries show the expanse of this industry, and the

Administration of Fisheries.

	Norway.	Sweden.	Denmark.	Germany.	Holland.	Belgium.
Department of State	Trade and Industry and Agriculture.	Agriculture.	Agriculture.	Imperial Department of Interior.	Agriculture.	Agriculture and Woods and Forests.
Approximate Annual Expenditure—						
1. Administration	£15,000	£5,500	£10,200	Conducted by Maritime States	£12,500	..
2. Scientific Fishery Research .	5,000	4,500	6,300	£27,750	2,500	£1,000
	Canada.	U.S. America.	England and Wales.	Scotland.	Ireland.	
Department of State	Marine and Fisheries.	Bureau of Fisheries under Commerce and Labour.	Agriculture and Fisheries.	Fishery Board.	Agriculture and Technical Instruction.	
Approximate Annual Expenditure—						
1. Administration	£159,000	Conducted by Coastal States	£8,000	£13,000	£10,000	
2. Scientific Fishery Research .	48,000	£141,000	14,000 (expended through agents)	800	..	

approximate expenditure on fisheries in some of the chief countries of the world. The figures are only approximate and are based on the expenditure for 1907. In the case of England and Wales the expenditure is not complete, as under the Sea Fisheries Regulation Act of 1888 the whole of the coast of England and Wales could be placed under local fisheries committees with power to levy rates for fishery purposes, and in a certain number of districts advantage has been taken of this act. But even with this addition, British expenditure on fisheries is less than that undertaken by most of the countries of northern Europe, although British fisheries are much more valuable than those of all the rest of Europe together.

enormous preponderance of Great Britain. The numbers are as follows:—

Belgium	23
Denmark	5
France	224
Germany	239
Netherlands	81
Norway	20
Portugal	13
Spain	12-18
Sweden	11
Scotland	292
Ireland	6
England and Wales	1317

A simultaneous development of the sea fisheries has been manifested in other maritime countries of Europe, particularly in Germany and Holland, but the total number of steam trawlers

¹ For fisheries in the cases of CORAL, OYSTER, PEARL, SALMON, SPONGES and WHALE, see these articles; for fishing as a sport see ANGLING.

belonging to those countries in 1905 scarcely exceeded the mere additions to the British fishing fleet in 1906.

The relative magnitude of British fisheries may best be gauged by a comparison with the proceeds of the chief fisheries of other European countries. The following table is based upon official returns and mainly derived from the *Bulletin Statistique* of the International Council for the Study of the Sea. It represents in pounds sterling the value of the produce of the various national fisheries during the year 1904, except in the case of France, for which country the latest available figures are those for 1902.

Values in Thousands of £.

	Herring.	Cod.	Plaice.	Other Fish.	Total.
British Isles	1870	1015	1100	5496	9,481,000
Norway	352	834	..	443	1,629,000
Denmark	117	60	171	223	571,000
Germany	220	64 ¹	40 ¹	512 ¹	836,000
Holland	575	53	58	311	997,000
France (1902)	635	851 ²	..	3562	5,048,000

The total value of the sea fisheries in the three chief subdivisions of the British Isles in the year 1905, according to the official returns, was as follows:

Fish landed in	Excluding Shellfish.	Including Shellfish.
England and Wales	£7,200,644	£7,502,768
Scotland	2,649,148	2,719,810
Ireland	360,577	414,364
Total	£10,210,369	£10,636,942

These figures show an increase of £1,000,000 as compared with the total value in 1900, and of more than £3,000,000 as compared with 1895 (cf. Table I. at end).

In England and Wales the trawl fisheries for cod, haddock, and flat fish yielded about three-quarters of the total, and the drift fisheries for herring and mackerel nearly the whole of the remaining quarter. The line fisheries in England and Wales are now relatively insignificant and yield only about one-fortieth of the total (cf. Table VIII. at end).

In Scotland, on the other hand, there is not so much difference in the relative importance of the three chief fisheries. In 1905 herrings and other net-caught fish yielded rather more than one-

east coasts. The remaining quarter is mainly derived from the trawl fisheries, the headquarters of which are at Dublin, Howth and Balbriggan on the east, and at Galway and Dingle on the west coast.

The value of the fishing boats and gear employed in the Scottish fisheries during 1905 is returned as nearly £4,120,000. Upon a moderate estimate, the total value of the boats and gear employed in the fisheries of Great Britain and Ireland cannot be less than £12,000,000.

The relative yield and value of the various fisheries on the separate coasts of the British Isles is illustrated in the table of landings from the latest data available.

From these figures it is manifest that the yield and value of the east coast fisheries of England and Scotland preponderate enormously over those of the western coasts, whether attention be paid to the drift-net fisheries for surface fish or to the fisheries for bottom fish with trawls and lines.

The preceding statistics and remarks, as well as the supplementary tables at the end of this article, indicate that the British fishing industry has enjoyed a period of unexampled prosperity. The community at large has benefited by the more plentiful supply, and the merchant by the general lowering of prices at the ports of landing (see Tables I.-IV. at end). But it is to be noted that this wave of prosperity, as on previous occasions, has been attained by the application of increased and more powerful means of capture and by the exploitation of new fishing grounds in distant waters, and not by any increase, natural or artificial, in the productivity of the home waters,—unless perhaps the abundance of herrings is to be ascribed to the destruction of their enemies by trawling. British fisheries are still pursued as a form of hunting rather than of husbandry. In 1892 the Iceland and Bay of Biscay trawling banks were discovered, in 1898 the Faroe banks, in 1905 rich plaice grounds in the White Sea. In 1905 one-half of the cod and a quarter of the haddock and plaice landed at east coast ports of England were caught in waters beyond the North Sea.

Table showing, in Thousands of Cwt., the Quantity of Fish landed by Steam Trawlers on the East Coast of England from Fishing Grounds within and beyond the North Sea respectively.

Year.	Within the North Sea.				Beyond the North Sea.			
	Cod.	Haddock.	Plaice.	All Kinds.	Cod.	Haddock.	Plaice.	All Kinds.
1903	729	2301	812	4776	470	389	114	1189
1904	637	2032	658	4228	447	429	284	1389
1905	640	1560	621	3739	603	518	244	1682

The statistics of the English Board of Agriculture and Fisheries have distinguished since 1903 between the catch of fish within and beyond the North Sea, and between the catch of trawlers and liners. Neglecting the catch of the liners as relatively insignificant, and of the sailing trawlers as relatively small and practically constant during the three years in question, we see from the board's figures (see table above) that the total catch of English steam trawlers within the North Sea during 1904 and 1905 was in each year 500,000 cwt. less than in the year before, amounting to a gross decrease of more than 25% in 1905 as compared with 1903, and, in relation to the catching power employed, to an average decrease of 2½ cwt. per boat per diem. This decrease may be largely explained by the occurrence in 1903 of one of those periodic "floods" of small cod

and haddock which take place in the North Sea from time to time; but the steady decline in the number of North Sea voyages by English steam trawlers—from 29,300 in 1903 to 26,700 in 1905—affords a clear indication of the fact that many of our trawling skippers are deserting the North Sea for more profitable fishing grounds. The number of Scottish steam trawlers "employed" at Scottish North Sea ports has

Fishery.	Trawl and Line.		Drift and Stake-nets.		Shellfish.
	Thousands of cwt.	Thousands of £.	Thousands of cwt.	Thousands of £.	Thousands of £.
England and Wales, 1905—					
East Coast	6017	4713	3042	1145	202
South Coast	303	245	728	268	64
West Coast	1002	720	219	111	36
Scotland, 1906—					
East Coast	2296	1202	2709	819	25
Orkney and Shetland	114	42	1735	642	10
West Coast	148	62	591	210	38
Ireland, 1905—					
North Coast	9	5	177	70	7
East Coast	79	70	110	32	18
South and West Coast	46	35	577	148	28

half of the total, the trawl fisheries nearly three-eighths, and the line fisheries one-eighth (cf. Table X.).

In Ireland the mackerel and herring fisheries provide nearly three-quarters of the total yield, the mackerel forming the chief item in the south and west, and the herring on the north and

¹ Estimated as regards about one-third of the total.

² Including the Newfoundland fishery.

also declined during the same period from 240 in 1903 to 228 in 1905.

The following table shows the number of British and foreign steam trawlers registered at North Sea ports, and for English vessels the number of fishing voyages made within and beyond the North Sea respectively:—

Year.	Boats Registered.	English Steam Trawlers. Voyages. ¹		Scottish. Employed.	German, Dutch and Belgian. Registered.
		Within North Sea.	Beyond North Sea.		
1903	1060	29,328	1822	240	181
1904	1049	28,589	2120	233	199
1905	1064	26,670	2671	228	228

Unfortunately the North Sea gains no rest from this withdrawal of British trawlers, since the place of the latter is filled year after year by increasing numbers of continental fishing boats. The number of fishing steamers (practically all trawlers) registered at North Sea ports in Germany and Holland was 159 in 1903, 177 in 1904, 205 in 1905, and 330 in 1907.

It is satisfactory under these circumstances to note the increased attention which has been paid in recent years to the acquisition of more exact knowledge upon the actual state of the fisheries and upon the biological and other factors which influence the supply.

A comprehensive programme of co-operative investigations, both scientific and statistical, was put into execution in the course of 1902 under the International Council for the Study of the Sea (see below). The Fishery Board for Scotland and the Marine Biological Association for England were commissioned to carry out the work at sea allotted to Great Britain, and the English fishery department was equipped soon afterwards with the means for collecting more adequate statistics.

Trawling investigations and the quantitative collection of fish eggs have located important spawning grounds of cod, haddock, plaice, sole, eel, &c.; marking experiments with cod, plaice and eel have thrown much light upon the migrations of these fishes; and the rate of growth of plaice, cod and herring has been elucidated in different localities. The percentage of marked plaice annually recaptured in the North Sea has been found to be remarkably high (from 25 to 50 %), and throws a significant light on the intensity of fishing under modern conditions. It seems probable that the impoverishment of the stock of plaice on the central grounds of the North Sea is mainly attributable to the excessive rate of capture of plaice during their annual off-shore migrations from the coast. On the other hand, it has been shown that the growth-rate of plaice on the Dogger Bank is constantly and markedly greater (five- or six-fold in weight) than on the coastal grounds where these fish are reared,—facts which open up the possibility of increasing the permanent supply of plaice from the North Sea by the adoption of some plan of commercial transplantation (see PISCICULTURE).

History.—A brief review may now be given of the history of the administration of British sea-fisheries since 1860, and of the steps which have been taken for the attainment of scientific and statistical information in relation thereto.

In 1860 a royal commission, consisting of Professor Huxley, Mr (afterwards Sir) John Caird, and Mr G. Shaw-Lefevre (afterwards Lord Eversley), was appointed to inquire into the condition of the British sea-fisheries, the harmfulness or otherwise of existing methods of fishing, and the necessity or otherwise of the existing legislation. The important report of this commission, issued in 1866, embodied the following main conclusions and recommendations:—(1) the total supply of fish obtained upon the British coasts is increasing and admits of further augmentation; (2) beam-trawling in the open sea is not a wastefully destructive mode of fishing; (3) all acts of parliament which profess to regulate or restrict the modes of fishing pursued in the open sea should be repealed and "unrestricted freedom

¹ Excluding the voyages of the fleeting trawlers which supply London by means of carriers.

of fishing be permitted hereafter"; (4) all fishing boats should be lettered and numbered as a condition of registration and licence.

In 1868 full effect was given to these recommendations by the passing of the Sea Fisheries Act. Regulations for the registration of fishing boats were issued by order in council in the following year. (New regulations were introduced in 1902.)

In 1878 a commission was given to Messrs Buckland and Walpole to inquire into the alleged destruction of the spawn and fry of sea fish, especially by the use of the beam-trawl and ground seine. Their report is an excellent summary of the condition of the sea fisheries at the time, and shows how little was then known with

regard to the eggs and spawning habits of our marine food fishes.

In 1882 the former Board of British White Herring was dissolved and the Fishery Board for Scotland instituted, the latter being empowered to take such measures for the improvement of the fisheries as the funds under their administration might admit of. Arrangements were made in the following year with Professor M'Intosh of St Andrews which enabled the latter to fit up a small marine laboratory and to begin a series of studies on the eggs and larvae of sea fishes, which have contributed greatly to the development of more exact knowledge concerning the reproduction of fishes. Under the Sea Fisheries (Scotland) Amendment Act of 1885 the board closed the Firth of Forth and St Andrews Bay against trawlers as an experiment for the purpose of ascertaining the result of such prohibition on the supply of fish on the grounds so protected. The treasury also, by a further grant of £3000, enabled the board to purchase the steam-yacht "Garland" as a means of carrying out regular experimental trawlings over the protected grounds. Reports on the results of these experiments have been annually published, and were summarized at the end of ten years' closure in the board's report for 1895. Dr Fulton's summary showed that "no very marked change took place in the abundance of food-fishes generally, either in the closed or open waters of the Firth of Forth or St Andrews Bay," as a consequence of the prohibition of trawling. Nevertheless, among flat fishes, plaice and lemon soles, which spawn off-shore, were reported to have decreased in numbers in all the areas investigated, whether closed or open, while dabs and long rough dabs showed a preponderating, if not quite universal, increase.

The results of this classical experiment point strongly to the presumptions (1) that trawling operations in the open sea have now exceeded the point at which their effect on the supply of eggs and fry for the upkeep of the flat fisheries is inappreciable; and (2) that protection of in-shore areas alone is insufficient to check the impoverishment caused by over-fishing off-shore. (For critical examinations of Dr Fulton's account see M'Intosh, *Resources of the Sea*, London, 1889; Garstang, "The Impoverishment of the Sea," *Journ. Mar. Biol. Ass.* vol. vi., 1900; and Archer, *Report of Ichthyological Committee*, Cd. 1312, 1902.)

A laboratory and sea-fish hatchery were subsequently established by the board at Dunbar in 1893, but removed to Aberdeen in 1900.

In 1883 a royal commission, under the chairmanship of the late earl of Dalhousie, was appointed to inquire into complaints against the practice of beam-trawling on the part of line and drift-net fishermen. A small sum of money (£200) was granted to the commission for the purpose of scientific trawling experiments, which were carried out by Professor M'Intosh.

The report of this commission was an important one, and its recommendations resulted in the institution of fishery statistics for England, Scotland and Ireland (1885-1887).

In 1884 the Marine Biological Association of the United Kingdom was founded for the scientific study of marine zoology and botany, especially as bearing upon the food, habits and life-conditions of British food-fishes, crustacea and molluscs. Professor Huxley was its first president, and Professor Ray

Lankester, who initiated the movement, succeeded him. A large and well-equipped laboratory was erected at Plymouth, and formally opened for work in 1888. The work of the association has been maintained by annual grants of £400 from the Fish-mongers' Company and £1000 from H. M. treasury, and by the subscriptions of the members. The association publishes a half-yearly journal recording the results of its investigations.

In 1886 a fishery department of the Board of Trade was organized under the Salmon and Freshwater Fisheries Act of that year. The department publishes annually a return of statistics of sea-fish landed, a report on salmon fisheries (transferred from the home office), and a report on sea fisheries. It consists of several inspectors under an assistant secretary of the board; it has no power to make scientific investigations or bye-laws and regulations affecting the sea-fisheries. In 1894 the administration of the acts relating to the registration of fishing vessels, &c., was transferred to the fisheries department.

In 1888 the Sea Fisheries Regulation Act provided for the constitution (by provisional order of the Board of Trade) of local fisheries committees having, within defined limits, powers for the regulation of coast fisheries in England and Wales. The powers of district committees were extended under Part II. of the Fisheries Act 1891, and again under the Fisheries (Shell Fish) Regulation Act 1894. Sea-fisheries districts have now been created round nearly the whole coast of England and Wales. Under bye-laws of these committees steam-trawling has been prohibited in nearly all the territorial waters of England and Wales, and trawling by smaller boats has been placed under a variety of restrictions. Local scientific investigations have been initiated under several of the committees, especially in Lancashire by Professor Herdman of Liverpool and his assistants.

In 1890 an important survey of the fishing grounds off the west coast of Ireland was undertaken by the Royal Dublin Society, with assistance from the government, and in the hands of Mr E. W. L. Holt led to the acquisition of much valuable information concerning the spawning habits of fishes and the distribution of fish on the Atlantic seaboard.

In 1892, under powers conferred by the Herring Fishery (Scotland) Act of 1889, the Fishery Board for Scotland closed the whole of the Moray Firth—including a large tract of extra-territorial waters—against trawling, in order to test experimentally the effect of protecting certain spawning grounds in the outer parts of the firth. The closure has given rise to a succession of protests from the leaders of the trawling industry in Aberdeen and England. It seems that the difficulty of policing so large an area, as well as the absence of any power to enforce the restriction on foreign vessels, have defeated the original intention; and the bye-law appears to be now retained mainly in deference to the wishes of the local line-fishermen, the decadence of whose industry—from economic causes which have been alluded to above—is manifest from the figures in Table X. below. The controversy has had the effect of causing the transference of a number of English trawlers to foreign flags, especially the Norwegian.

Statistics.—The following tables summarize the official statistics of fish landed on the coasts of England and Wales, Scotland and Ireland, and give some information relative to the numbers of fishing-boats and fishermen in the three countries.

TABLE I.—Summary of Statistics of Fish landed, imported and exported for the United Kingdom.

Year.	Fish landed (excluding Shell-fish).	Net Imports.	Exports of British Fish.
	Cwt.		
1890	12,774,010	£6,361,487	£1,795,267
1895	14,068,641	7,168,025	2,282,406
1900	14,671,070	9,242,491	3,000,852
1905	20,164,276	10,210,369	4,164,869

Note.—Imported fish afterwards re-exported (consisting chiefly of salted or cured fish to the value of over £900,000 in 1905) are not included in the above values of imports and exports. The exports consist mainly of herrings.

TABLE II.—Quantity and Average Landing Value of Flat Fishes landed on the Coasts of England and Wales (all caught with Trawl-nets, except Halibut in part).

Year.	Quantity (in Thousands of Cwt.).					Average Price (per Cwt.).				
	Sole.	Turbot.	Brill.	Plaice.	Halibut.	Sole.	Turbot.	Brill.	Plaice.	Halibut.
1890	72.1	51.9	15.4	623	95	£ 6	£ 7	£ 3	£ 13	£ 2
1895	82.8	77.9	19.0	789	114	6	16	3	17	2
1900	75.3	60.7	20.7	752	136	7	11	4	3	2
1905	80.1	89.5	22.4	1074	120	5	18	3	11	2

TABLE III.—Quantity and Average Landing Value of Round Fishes, caught with Trawls and Lines, landed on the Coasts of England and Wales.

Year.	Quantity (in Thousands of Cwt.).					Average Price (per Cwt.).				
	Cod.	Haddock.	Hake.	Ling.	Sundries.	Cod.	Haddock.	Hake.	Ling.	Sundries.
1890	363	1585	..	96	1151	s. 13	d. 10	s. 9	d. 7	s. 14
1895	496	2433	132	114	1013	12	8	9	9	16
1900	589	2487	233	100	1190	14	8	5	13	15
1905	1423	2148	484	165	1425	12	4	12	5	13

TABLE IV.—Quantity and Average Landing Value of Surface Fishes landed on the Coasts of England and Wales (caught with Drift-, Seine-, and Stow-nets).

Year.	Quantity (in Thousands of Cwt.).				Average Price (per Cwt.).			
	Mackerel.	Herring.	Pilchard.	Sprat.	Mackerel.	Herring.	Pilchard.	Sprat.
1890	509	1332	61	99	s. 15	d. 5	s. 7	d. 2
1895	375	1437	65	91	16	3	5	10
1900	321	2425	106	73	15	9	7	8
1905	682	3062	169	75	8	11	7	7

TABLE V.—Quantity and Average Landing Value of Shell-fish landed on the Coasts of England and Wales.

Year.	Number.				Average Price.			
	Thousands.		Mills.	Thou- sands of Cwt.	Per Hundred.		Per Cwt.	
	Crabs.	Lobsters.	Oysters.	Sundries.	Crabs.	Lobsters.	Oysters.	
1890	4808	922	47.6	505	£ 1	£ 4	£ 4	
1895	4501	677	25.3	590	1	4	4	
1900	5177	654	37.8	539	1	2	4	
1905	5106	503	35.4	423	1	3	4	

TABLE VI.—Total Quantity of the more important Fishes and Shell-fish landed in Scotland.

Year.	In Thousands of Cwt.										Cwt.	Number (Thousands).		
	Herring.	Lemon Sole.	Flounder, Plaice, and Brill.	Halibut.	Cod.	Ling.	Haddock.	Whiting.	Skate.	Mussels.		Crabs.	Lobsters.	Oysters.
1890	3980	17	81	20	449	170	754	75	54	181	2882	643	350	
1895	4077	19	80	20	459	165	1001	43	59	194	2548	610	239	
1900	3520	21	102	26	434	157	701	75	72	143	3128	680	796	
1905	5343	31	561	36	677	151	932	184	100	103	1990	760	218	

1 Plaice only.

TABLE VII.—Total Quantity of the more important Fishes and Shell-fish returned as landed on the Irish Coasts.

Year.	In Thousands of Cwt.									Number (Thousands).		
	Mackerel.	Herring.	Sole.	Turbot.	Cod.	Ling.	Haddock.	Whiting.	Hake.	Oysters.	Crabs.	LoBSTERS.
1890	502	85	4.5	1.4	39.6	14.8	16.4	13.5	25.3	576	228	238
1895	339	171	1.8	1.0	43.6	29.7	30.9	11.9	18.7	563	240	276
1900	278	284	3.1	1.5	33.6	11.9	12.4	11.9	16.3	236	202	286
1905	505	354	3.5	0.8	18.6	9.1	11.3	18.3	7.1	348	175	236

Note.—The Irish statistics of shell-fish are very incomplete, owing to the inadequate means at the disposal of the authorities for collecting statistics over large sections of the coast.

TABLE VIII.—Classified List of British Fishing Boats on the Register for 1905, omitting 2nd Class Steamers and Vessels under 18 Ft. Keel or Navigated by Oars only and Vessels unemployeD.

Mode of Fishing.	England and Wales.			Scotland.			Ireland.		
	Steamers. 1st Cl.	Sailing. 1st Cl.	Sailing. 2nd Cl.	Steamers. 1st Cl.	Sailing. 1st Cl.	Sailing. 2nd Cl.	Steamers. 1st Cl.	Sailing. 1st Cl.	Sailing. 2nd Cl.
Trawling .	1173	904	586	244	..	68	10	142	283
Drift-nets	263	562	539
Lines .	56	29	685	209	3403	2910	..	229	2776
Various .	21	215	2277
Total .	1513	1710	4087	453	3403	2978	10	371	3059

Note.—1st class=steamers of at least 15 tons gross tonnage, and other boats of at least 15 tons registered tonnage (in Scotland exceeding 30 ft. keel).
2nd class=less than 15 tons tonnage, or from 18 to 30 ft. keel.

TABLE IX.—Number (A) of Men and Boys constantly employed and (B) of other Persons occasionally employed in Fishing.

Year.	England and Wales.		Scotland.		Ireland.		United Kingdom.	
	A.	B.	A.	B.	A.	B.	A.	B.
1890	32,503	9312	34,319	20,829	10,121	13,081	78,450	46,437
1895	32,229	8995	31,044	12,329	8,692	18,218	75,090	41,230
1900	31,589	7994	27,288	10,288	8,677	18,982	68,708	37,814
1905	34,318	8132	29,064	10,487	8,744	17,079	73,293	36,131

TABLE X.—Catch and Value of Line-caught and Trawled Fish landed in Scotland.

Year.	Line-caught Fish.		Trawled Fish.	
	Cwt.	£	Cwt.	£
1890	1,577,299	£591,059	291,812	£203,620
1895	1,479,654	548,629	531,695	291,165
1900	757,416	371,173	1,077,082	703,427
1905	735,654	348,610	1,745,431	948,117

In 1893 a select committee of the House of Commons took evidence as to the expediency of adopting measures for the preservation of the sea-fisheries in the seas around the British Islands, with especial reference to the alleged wasteful destruction of under-sized fish. They recommended the adoption of a size-limit of 8 in. for soles and plaice, and 10 in. for turbot and brill, below which the sale of these fishes should be prohibited, on the ground that these limits would approximate to those already adopted by foreign countries.

In 1899 the Agriculture and Technical Instruction (Ireland) Act transferred the powers and duties of the inspectors of Irish fisheries to the Department of Agriculture and Technical Instruction for Ireland. The department is provided with a steam cruiser, the "Helga," 375 tons, fully equipped for fishery research, as well as with a floating marine laboratory. Mr Holt, formerly of the Marine Biological Association, was appointed to take charge of the scientific work.

In 1900 another select committee of the House of Commons was appointed to consider and take evidence on the proposals of the Sea Fisheries Bill, which had been framed in accordance with the recommendations of the select committee of 1893, but had failed to pass in several sessions of parliament. Owing to marked

divergencies of opinion on the question whether the low size-limits proposed would be effectual in keeping the trawlers from working on the grounds where small fish congregated, the committee reported against the bill, and urged the immediate equipment of the government departments with means for undertaking the necessary scientific investigations.

In 1901 an international conference of representatives of all the countries bordering upon the North and Baltic Seas met at Christiania to revise proposals which had been drafted at Stockholm in 1899 for a scientific exploration of these waters in the interest of the fisheries, to be undertaken concurrently by all the participating countries. The British government was represented by Sir Colin Scott-Moncrieff, K.C.M.G., with Professor D'Arcy W. Thompson, Mr (afterwards Professor) W. Garstang and Dr H. R. Mill as advisers. The proposals were subsequently accepted, with some restrictions, and an interna-

tional council of management was appointed by the participating governments. The Fishery Board for Scotland and the Marine Biological Association from England were commissioned in 1902 to carry out the work at sea allotted to Great Britain, and a special grant of £5500 per annum was made to each body by the Treasury for this purpose.

Two steamers, the "Huxley" and the "Goldseeker," were chartered for the investigations and began work in 1902 and 1903 from Lowestoft and Aberdeen respectively. Reports on the work of the first five years were published in 1909.

In 1901 the Board of Trade appointed a committee (the Committee on Ichthyological Research) to inquire and report as to the best means by which scientific fishery research could be organized and assisted in relation to the state or local authorities. The committee consisted of Sir Herbert Maxwell, M.P. (chairman), Mr W. F. Archer, Mr Donald Crawford, Rev. W. S. Green, Professor W. A. Herdman, Hon. T. H. W. Pelham, Mr S. E. Spring Rice and Professor J. A. Thomson. Sir Herbert Maxwell resigned his chairmanship before the report was drawn up (September 1902), and was succeeded by Sir Colin Scott-Moncrieff. The committee recommended the provision of more complete statistics; the provision and maintenance of five special steamers (where not already existing) to work in connexion with as many marine laboratories, viz. one for each of the three coasts of England and Wales, and one each for Scotland and Ireland; the provision of three biological assistants at each laboratory; the grant of statutory powers to local sea-fisheries committees to expend money on fishery research; the constitution of a fishery council for England and Wales, and of a conference of representatives of the central authorities in England, Scotland and Ireland. In 1903 the fishery department of the Board of Trade was transferred to the Board of Agriculture, Mr W. E. Archer, chief inspector of fisheries, becoming an assistant secretary of the new Board of Agriculture and Fisheries.

In 1907 a departmental treasury committee was appointed to inquire into the scientific and statistical investigations carried on in relation to the fishing industry of the United Kingdom. The committee consisted of Mr H. J. Tennant, M.P. (chairman), Lord Nunburnholme, Sir Reginald MacLeod, Mr N. W. Helms, M.P., Mr A. Williamson, M.P., Dr P. Chalmers Mitchell, F.R.S., Mr J. S. Gardiner, F.R.S., the Rev. W. S. Green, Mr R. H. Rew and Mr L. S. Hewby. This committee reviewed the work that had already been done and urged its continuation and extension under the direction of a central council composed of representatives of the government departments concerned with fishery matters in England, Scotland and Ireland, with a scientific

chairman and director, and further insisted on the need of international co-operation in the investigations.

United States Fisheries.—The administration of the fisheries of the United States of America is under the control of the several coastal states, but the Bureau of Fisheries at Washington, which reports to the secretary of commerce and labour, conducts a vast amount of scientific fishery investigation, issues admirable statistical and biological reports, and conducts on a very large scale work on the replenishment of the fishing stations by artificial means (see PISCICULTURE). Although in recent years Canada has given an increasing amount of state support to the investigation, control and assistance of her fisheries, an amount actually and relatively far exceeding that given in Great Britain, the fishing industry of the United States still far exceeds that of Canada. A considerable bulk of fish, taken by American ships from the Newfoundland coasts and from those of other British provinces, is landed at American ports, but as the following recent table shows, it is much less than that taken from American waters.

Quantities and Values of Fish landed by American Vessels at Boston and Gloucester, Mass., in 1905.

	Quantities.	Value.
(a) From fishing grounds off U.S. coasts	152,241,139	£669,640
(b) From fishing grounds off Newfoundland	17,165,083	103,145
(c) From fishing grounds off other British provinces	32,608,343	192,517

The fisheries of the United States show a substantial increase from year to year. There has been a decline in some important branches owing to indiscreet fishing and to the inevitable effects of civilization on certain kinds of animal life and in certain restricted areas. Such diminution has been more than compensated for by growth resulting from the invasion of new fishing grounds made possible by increase in the sea-going capacity of the vessels employed, by improvement in the preservation and handling of the catch, and by the greater utilization of products which until comparatively recently were disregarded or considered without economic value. The annual value of the water products taken and sold by the United States fishermen now amounts to over £11,000,000, and this sum does not include the very large quantities taken by the fishermen for home consumption or captured by sportsmen and amateurs. Between two and three hundred thousand persons make a livelihood by the industry, and the capital involved exceeds £16,000,000.

The oyster is the most valuable single product, and the output of the United States industry exceeds the combined output of all other countries in the world. The most notable feature of this fishery is that nearly half the total yield now comes from cultivated grounds, so that the business is being placed on a secure basis. Virginia has now taken the first rank as an oyster-producing state, oyster farming being now highly developed with an annual yield of nearly nine million bushels.

The high-sea fisheries for cod, haddock, hake, halibut, mackerel, herring, and so forth are on the whole not increasing in prosperity, the annual value being between one and two million pounds. The lobster fishery shows a markedly diminishing yield, the diminution having been progressive since about 1890, and being attributed to over-fishing and violation of the restrictive regulations. At present a large part of the lobsters consumed in the United States comes from Nova Scotia, but there is evidence of useful results coming from the extensive cultural operations now being carried out.

The whale fishery, at one time the leading fishing industry of the country, is now conducted chiefly in the North Pacific and Arctic oceans, but is decaying, being now expensive, uncertain and often unremunerative. The annual value of the take is now under £200,000.

The important group of anadromous fishes (those like salmon, shad, alewife, striped bass and sea perches, which ascend the rivers from the ocean) has continued to provide an increasing

source of income to fishermen, the combined value of the catch on the Atlantic and Pacific seaboard now amounting to over £3,000,000 annually. The fisheries of the Great Lakes yield about £600,000 annually. (W. GA.; P. C. M.)

FISHERY (LAW OF). This subject has (1) its international aspect; (2) its municipal aspect. On the high seas outside territorial waters the right of fishery is now recognized as common to all nations. Claims were made in former times by single nations to the exclusive right of fishing in tracts of open sea; such as that set up by Denmark in respect of the North Sea, as lying between its possessions of Norway and Iceland, against England in the 17th century, and against England and Holland in the 18th century, when she prohibited any foreigners fishing within 15 German miles of the shores of Greenland and Iceland. This claim, however, was always effectively resisted on the ground stated in Queen Elizabeth's remonstrance to Denmark on the subject in 1602, that "the law of nations alloweth of fishing in the sea everywhere, even in seas where a nation hath propriety of command." The enunciation of this principle is to be found, also, in the award of the arbitration court which decided the question of the fur-seal fishery in Bering Sea in 1894. (See BERING SEA ARBITRATION; ARBITRATION, INTERNATIONAL.) The right of nations to take fish in the sea may, however, be restrained or regulated by treaty or custom; and Great Britain has entered into conventions with other nations with regard to fishing in certain parts of the sea. The provisions of such conventions are made binding on British subjects by statutes.

Instances of these are the conventions of 1818 and 1872 between Great Britain and the United States as to the fisheries on the eastern coasts of British North America and the United States within certain limits, and the award of the Bering Sea arbitration tribunal under the treaty of 1892; the conventions between Great Britain and France in 1839 and 1867 as regards fishing in the seas adjoining these countries, the latter of which will come into force on the repeal of the former; the agreement of 1904 with respect to the Newfoundland fisheries (see NEWFOUNDLAND); the convention of 1882 between Belgium, Denmark, France, Germany, Great Britain and Holland, regarding the North Sea fisheries; that of 1887 between the same parties concerning the liquor traffic in the North Sea; and the declaration regarding the same waters made between Great Britain and Belgium for the settlement of differences between their fishermen subjects in such extra-territorial waters. At the instance of the Swedish government the British parliament also passed an act in 1875 to establish a close time for the seal fishery in the seas adjacent to the eastern coasts of Greenland.

Cases have come before British courts with regard to the whale fishery in northern and southern seas; and the customs proved to exist among the whaling ships of the nations engaged in a particular trade have been upheld if known to the parties to the action. In territorial waters, on the other hand, fishery is a right exclusively belonging to the subjects of the country owning such waters, and no foreigners can fish there except by convention.

(a) *Tidal Waters.*—In British territorial waters, it may be stated, as the general rule, that fishery is a right incidental to the soil covered by the waters in which that right is exercised.

The bed of all navigable rivers where the tide flows and reflows, and of all estuaries or arms of the sea, is vested in the crown; and therefore, in Lord Chief Justice Hale's words, "the right of the fishery in the sea and the creeks and arms thereof is originally lodged in the crown, as the right of depasturing is originally lodged in the owner of the waste whereof he is lord, or as the right of fishing belongs to him that is the owner of a private or inland river." "But," he continues, "though the king is the owner of this great waste, and as a consequent of his propriety hath the primary right of fishing in the sea and the creeks and arms thereof, yet the common people of England have regularly a liberty of fishing therein as a public common of piscary, and may not without injury to their right be restrained of it unless in such places or creeks or navigable rivers where either the king or some particular subject hath gained a propriety exclusive of that common liberty" (*De Jure Maris*, ch. iv.).

This right extends to all fish floating in the sea or left on the seashore, except certain fish known as royal fish, which, when taken in territorial waters, belong to the crown or its grantee, though caught by another person. These are whales, sturgeons and porpoises; and grampuses are also sometimes added (whales, porpoises and grampuses being "fishes" only in a legal sense). In Scotland only whales which are of large size can be so claimed:

but the rights of salmon fishing in the sea and in public and private rivers, and those of mussel and oyster fishing, except in private rivers, are *inter regalia*, and are only enjoyable by the crown or persons deriving title under it. As salmon fishery was formerly practised by nets and engines on the shore, and the mussel and oyster fisheries were necessarily carried on on the shore, the opinion was held at one time that angling for salmon was a public right, but the later decisions have established that the right of salmon fishing by whatever means is a *jus regale* in Scotland. In England the crown in early times made frequent grants of fisheries to subjects in tidal waters, and instances of such fisheries belonging to persons and corporations are very common at the present day: but by Magna Carta the crown declared that "no rivers shall be defended from henceforth, but such as were in defence in the time of King Henry, our grandfather, by the same places and the same bounds as they were wont to be in his time"; and thus bound itself not to create a private fishery in any navigable tidal river. Judicial decision and commentators having interpreted this statute according to the spirit and not the letter, at the present day the right of fishery in tidal waters *prima facie* belongs to the public, and they can only be excluded by a particular person or corporation on proof of an exclusive right to fish there not later in its origin than Magna Carta; and for this it is necessary either to prove an actual grant from the crown of that date to the claimant's predecessor in title, or a later grant or immemorial custom or prescription to that effect, from which such an original grant may be presumed. This exclusive right of fishing may be either a franchise derived from the crown, or may arise by virtue of ownership of the soil covered by the waters.

In Lord Hale's words: "Fishing may be of two kinds ordinarily, viz. fishing with a net, which may be either as a liberty without the soil, or as a liberty arising by reason of and in concomitance with the soil or an interest or propriety of it; or otherwise it is a local fishing that ariseth by or from the propriety of the soil,—such are *gurgites*, wears, fishing-places, *borachiae*, *stachiae*, which are the very soil itself, and so frequently agreed by our books. And such as these a subject may have by usage; either in gross, as many religious houses had, or as parcel of or appurtenant to their manors, as both corporations and others have had; and this not only in navigable rivers and arms of the sea but in creeks and ports and havens, yea, and in certain known limits in the open sea contiguous to the shore. And these kinds of fishings are not only for small sea-fish, such as herrings, &c., but for great fish, as salmons, and not only for them but for royal fish. . . . Most of the precedents touching such rights of fishing in the sea, and the arms and creeks thereof belonging by usage to subjects, appear to be by reason of the propriety of the very water and soil wherein the fishing is, and some of them even within parts of the seas" (*De Jure Maris*, ch. v.)

An instance of the former kind of fishery is to be found in the old case of *Royal Fishery of the River Bann* (temp. James I., Davis 655), and the modern one of *Wilson v. Crossfield*, 1885, 1 T.L.R. 601, where a right of fishery in gross was established; but the latter kind, as Hale says, is much more common, and the presumption is always in its favour; *à fortiori* where the fishing is proved to have been carried on by means of engines or structures fixed in the soil. In England the public have not at common law, as incidental to their right of fishing in tidal waters, the right to make use of the banks or shores for purposes incidental to the fishery, such as beaching their boats upon them, landing there, or drying their nets there (though they can do so by proving a custom from which such a grant may be presumed); but statutes relating to particular parts of the realm, such as Cornwall for the pilchard fishery, give them such rights. In Scotland a right of salmon fishing separate from land implies the right of access to and use of the banks, foreshores or beach for the purposes of the fishing; and so does white fishing by statute. But otherwise there is no right to do so, e.g. in a public river for trout fishing. A similar privilege is given to Irish fishermen for the purpose of sea fishery by special statute. There is no property in fish in the sea, and they belong to the first taker; and the custom of the trade decides when a fish is taken or not, e.g. in the whale fishery the question whether a fish is "loose" or not has come before English courts.

(b) *Fresh Waters*.—In non-tidal waters in England and

Ireland, for the reason given above, the presumption is in favour of the fishery in such waters belonging to the owners of the adjacent lands; "fresh waters of what kind soever do of common right belong to the owners of the soil adjacent, so that the owners of the one side have of common right the property of the soil, and consequently the right of fishing *usque ad filum aquae*, and the owners of the other side the right of soil or ownership and fishing unto the *filum aquae* on their side; and if a man be owner of the land on both sides, in common presumption he is owner of the whole river, and hath the right of fishing according to the extent of his land in length" (Hale, ch. i.). There is a similar presumption that the owner of the bed of a river has the exclusive right of fishery there, and this is so even though he does not own the banks; but these presumptions may be displaced by proof of a different state of things, e.g. where the banks of a stream are separately owned the owner of one bank may show by acts of ownership exercised over the whole stream that he has the fishery over it all. The crown prerogative of fishery, never it seems, extended to non-tidal waters flowing over the land of a subject, and it could not therefore grant such a franchise to a subject, nor has it any right *de jure* to the soil or fisheries of an inland lake such as Lough Neagh (*Bristow v. Cormican*, 1878, 3 App. Cas. 641). The public cannot acquire the right to fish in fresh waters by prescription or otherwise although they are navigable; such a right is unknown to law, because a profit *à prendre in alieno solo* is neither to be acquired by custom nor by prescription under the Prescription Act. It has been decided that the "dwellers" in a parish cannot acquire such a right, being of too vague a class; but the commoners in a manor may have it by custom; and the "free inhabitants of ancient tenelements" in a borough have been held capable of acquiring a right to dredge for oysters in a fishery belonging to the corporation of the borough on certain days in each year by giving proof of uninterrupted enjoyment of it from time immemorial, on the presumption that this was a condition to which the grant made to the corporation was subject.

In Scotland the law is similar. The right to fish for trout in private streams is a pertinent of the land adjacent, and owners of opposite banks may fish *usque ad medium filum aquae*; and where two owners own land round a private loch, both have a common of fishing over it. The public cannot prescribe for it, for a written title either to adjacent lands or to the fishery is necessary. A right of way along the bank of a river or loch does not give it, nor does the right of the public to be on or at a navigable but non-tidal river. The right of salmon fishing carries with it the right of trout fishing; and eel fishing passes in the same way.

In England and Ireland private fisheries have been divided into (a) several (*separalis*), (b) free (*libera*), (c) common of piscary (*communis*), whether in tidal or non-tidal waters. The distinction between several and free fisheries has always been uncertain. Blackstone's opinion was that several fishery implied a fishery in right of the soil under the water, while free fishery was confined to a public river and did not necessarily comprehend the soil. He is supported by later writers, such as Woolrych and Paterson. On the other hand, the opinions of Coke and Hale are opposed to this view. "A man may prescribe to have a several fishery in such a water, and the owner shall not fish there; but if he claim to have common of fishery or free fishery the owner of the soil shall fish there" (Co Littl. 122 A); "one man may have the river and others the soil adjacent: or one man may have the river and soil thereof, and another the free or several fishing in that river" (*De Jure Maris*, ch. i.). Lord Holt, though in one instance he distinguished them, in a later case thought that they were "all one." Later decisions have established the latter view, and it is now settled that although the owner of the several fishery is *prima facie* owner of the soil of the waters, this presumption may be displaced by showing that the terms of the grant only convey an incorporeal hereditament, and that the words "sole and exclusive fishery" give a several fishery *in alieno solo*. In the words of Mr Justice Willes, "the only substantial distinction is between an exclusive right of fishery, usually called

'several,' and sometimes 'free,' as in 'free warren,' and a right in common with others, usually called 'common of fishery,' and sometimes 'free,' as in 'free port.' A several fishery means an exclusive right to fish in a given place, either with or without the property in the soil" (*Malcolmson v. O'Dea*, 1863, 10 H.L.). A common of piscary, or "a right to fish in common with certain other persons in a particular stream," is usually found in manors, the commoners of which may have the right to enjoy it to an extent sufficient for the sustenance of their tenements; but they cannot, except by immemorial special prescription, exclude the lord of the manor therefrom, and have no rights over the soil itself. Decisions also establish that a grant of "fishery" will prima facie pass an exclusive fishery; a grant of soil covered by water or a lease of lands including water will pass the fishery therein; a several fishery will not merge on being resumed by the crown; and a fishery situate within a manor is presumed to belong to the owners of adjacent land, and not to the lord. A several fishery, as already seen, being an incorporeal hereditament, can only be transferred by deed, and therefore cannot be abandoned, and so acquired by the public, even on proof that the public have, as far back as living memory, exercised the right of fishing in the *locus in quo* to the knowledge of and without interruption from the claimant of the fishery. But to establish a title to a several fishery, a "paper title," *i.e.* one founded on documentary evidence only, is not sufficient; it must be supported by evidence of acts of ownership in recent times, for otherwise it will be presumed that a person other than the alleged owner is the real owner. If the waters of a tidal river leave their old channel and flow into another, the owner of a several fishery in the old channel cannot claim to have it in the new one; but, on the other hand, the owner of a several fishery can take advantage of a gradual encroachment by the river upon and into the land of a riparian owner, the limits of whose land are ascertained. The owner of an exclusive fishery, whether in tidal or fresh waters, has the right to take as many fish as he can, and may do so by means of fixed engines or dredging, provided that in navigable waters he does not interfere with the right of navigation, and that in navigable and other waters he does not interfere with the fishing rights of his neighbours or infringe the provisions made by old or modern statutes as to the methods of taking the fish, *e.g.* by weirs. These were forbidden in rivers by Magna Carta and later statutes, and on the seashore by a statute of James I.; but all weirs in navigable fresh waters traceable to a date not later than 25 Edward III. are lawful, for the statutes forbidding weirs do not apply to navigable waters. It seems, however, that at common law any fixed structures put up by the owner of a fishery in his part of a river, which at all prevent the free passage of fish to the waters above or below, give the owners of fisheries therein a right of action against him. So the grantee of an exclusive fishery with rod and line in an unnavigable river can prevent any person from polluting the river higher up and so damaging the fishery. At common law there is no property in fish when enjoying their natural liberty; the taker is entitled to keep them unless they are caught from a tank or small pond; or except in the case of salmon by statute.

Modern statutes now regulate all fisheries, sea or fresh, in territorial or inland waters. As regards sea fishery in England, the Board of Agriculture and Fisheries has (since 1903, when it took it over from the Board of Trade) power by order to create sea fisheries districts, comprising any part of the sea within which British subjects have, by international law, the exclusive right of fishing, and to provide for the constitution of a local fisheries committee to regulate the sea fisheries in such district, which can make by-laws for that purpose. It appoints fishery officers to enforce them, prescribes a close time for sea fish (which does not include salmon as defined in the Salmon Act), has summary jurisdiction over offences committed on the sea coast or at sea beyond the ordinary jurisdiction of a court of summary jurisdiction, can enforce the Sea Fisheries Acts, or regulate, protect and develop fisheries for all or any kind of shell fish. Special provision is also made by statute for the oyster

fishery and herring fishery (applicable also to Scotland), and that of mussels, cockles, lobsters and crabs (applicable to all the United Kingdom). In Scotland the Fishery Board can constitute sea fishery districts, and boards with like powers to those in England, and has general control over the coast and deep-sea fisheries of Scotland; and there are acts relative to herring, mussel and oyster fisheries, and allowing the appropriation of money intended to relieve local distress and taxation towards the encouragement of sea fisheries, and marine superintendence and enforcement of Scottish sea fisheries laws. In Ireland the sea fisheries are under the direction of the inspectors of Irish fisheries, who have replaced the former fishery commissioners and special commissioners for Irish fisheries; special statutes, besides the general ones applying to all the United Kingdom, deal with oyster fisheries and mussel fisheries; and money is also appropriated for sea fisheries under the head of technical instruction. In all three component parts of the United Kingdom there are also special statutes relative to salmon and freshwater fish: for England, the Salmon and Freshwater Fisheries Acts 1861-1907, and the Freshwater Fisheries Acts 1878-1886; for Scotland the chief Salmon Acts are those of 1862-1868, and for trout and freshwater fish those of 1845-1902; for Ireland, the Fisheries (Ireland) Acts 1842-1901. A similar scheme is adopted in each case, namely, fishery districts and district boards are set up which regulate the fishing by by-laws and protect the fish by fixing a close time, and prescribing passes, licences, inspection and the like, breaches of which are punishable by courts of summary jurisdiction. The supreme authorities in each case are—for England the Board of Agriculture and Fisheries, for Scotland the Fishery Board, and for Ireland the inspectors of fisheries, and in England a certain official number of conservators on such boards are appointed by the county councils. The Salmon and Freshwater Fisheries Act 1907 gives the Board of Agriculture and Fisheries power to make provisional orders for the regulation of salmon fisheries or freshwater fisheries within any area on the application of any board of conservators, or of a county council, or of the owners of one-fourth in value of private fisheries. There are also special acts dealing with the fishing in certain rivers, such as the Thames, Medway, Severn, Tweed and Esk. (The act of 1907 applies, however, to the Esk, but not otherwise to Scotland nor to Ireland.) Throughout the United Kingdom the use of dynamite or other explosive substance to catch or destroy fish in any public fishery is prohibited, as it is also in England in any private waters subject to the Salmon and Freshwater Fisheries Acts 1878, in which it is also forbidden to use poison or other noxious substance for destroying fish. Officers in the army or marines are forbidden (under penalty) to kill fish without written leave from the person entitled to grant it. There are also provisions of the criminal law dealing with the protection of fisheries generally, as well as the provisions of the acts already mentioned dealing with special kinds of fish.

Special provision is made by the Merchant Shipping Acts 1894-1906 for sea-fishing boats (except in Scotland and the colonies), relating to their registration, carrying official papers, carrying boats in proportion to their tonnage, the punishment of offences on board, the wages of their crews, and keeping record of all casualties, punishments and the like on board. As regards trawlers, especially in the case of those of 25 tons and upwards, a statutory form of agreement with the crew is prescribed, as well as accounts of wages and discharges; and skippers and second hands must have certificates of competency, which are granted under similar conditions to those required in the case of seagoing ships and are registered with the Board of Trade. Scottish fishing boats are regulated by a special statute of 1886 (except as regards agreements to pay crew by share of profits, dealt with by the above act) and by the Sea Fisheries Act of 1868, which applies to all British fishing boats. Particular lights must be carried by fishing boats in navigation. An act of 1908 (The Cran Measures Act) legalized the use of cran measures in connexion with trading in fresh herrings in England and Wales, the Board of Agriculture and Fisheries being empowered to make regulations under the act.

AUTHORITIES.—Green, *Encyclopaedia of Scots Law* (Edinburgh, 1896); Stewart, *Law of Fishing in Scotland* (Edinburgh, 1869); Woolrych, *Walters* (London, 1851); Paterson, *Fishery Laws of the United Kingdom* (London and Cambridge, 1863); Stuart Moore, *Foreshore* (London, 1888); Phillimore, *International Law* (3rd ed., London, 1879); Martens, *Causes célèbres du droit des gens* (Leipzig, 1827); Selwyn, *Nisi Prius, Fishery* (London, 1869). (G. G. P.)*

FISHGUARD (*Abergwaun*), a market town, urban district, contributory parliamentary borough and seaport of Pembrokeshire, Wales, near the mouth of the river Gwaun, which here flows into Fishguard Bay of St George's Channel. Pop. (1901) 2002. Its railway station, which is the chief terminus of the South Wales system of the Great Western railway, is at the hamlet of Goodwick across the bay, a mile distant to the south-west. Fishguard Bay is deep and well sheltered from all winds save those of the N. and N.E., and its immense commercial value has long been recognized. After many years of labour and at a great expenditure of money the Great Western railway has constructed a fine breakwater and railway pier at Goodwick across the lower end of the bay, and an important passenger and goods traffic with Rosslare on the opposite Irish coast was inaugurated in 1906.

The importance of Fishguard is due to the local fisheries and the excellence of its harbour, and its early history is obscure. The chief historical interest of the town centres round the so-called "Fishguard Invasion" of 1797, in which year on the 22nd of February three French men-of-war with troops on board, under the command of General Tate, an Irish-American adventurer, appeared off Carreg Gwastad Point in the adjoining parish of Llanwnda. To the great alarm of the inhabitants a body of about 1400 men disembarked, but it quickly capitulated, practically without striking a blow, to a combined force of the local militias under Sir Richard Philipps, Lord Milford and John Campbell, Lord Cawdor; the French frigates meanwhile sailing away towards Ireland. For many years the castles and prisons of Haverfordwest and Pembroke were filled to overflowing with French prisoners of war. Close to the banks of the Gwaun is the pretty estate of Glyn-y-mel, for many years the residence of Richard Fenton (1746-1821), the celebrated antiquary and historian of Pembrokeshire.

FISHKILL LANDING, or **FISHKILL-ON-THE-HUDSON**, a village of Fishkill township, Dutchess county, New York, U.S.A., about 58 m. N. of New York City, on the E. bank of the Hudson river, opposite Newburgh. Pop. (1890) 3617; (1900) 3673, of whom 540 were foreign-born; (1905) 3939; (1910) 3902, of Fishkill township (1890) 11,840; (1900) 13,016; (1905) 13,183; (1910) 13,858. In the township are also the villages of Matteawan (*q.v.*), Fishkill and Glenham. Fishkill Landing is served by the New York Central & Hudson River and the New York, New Haven & Hartford railways; by railway ferry and passenger ferries to Newburgh, connecting with the West Shore railway; by river steamboats and by electric railway to Matteawan. Four miles farther N. on Fishkill Creek is the village of Fishkill (incorporated in 1899), pop. (1905) 579. In this village are two notable old churches, Trinity (1769), and the First Dutch Reformed (1731), in which the New York Provincial Congress met in August and September 1776. At the old Verplanck mansion in Fishkill Landing the Society of the Cincinnati was organized in 1783. Among the manufactures of Fishkill Landing are rubber-goods, engines (Corliss) and other machinery, hats, silks, woollens, and brick and tile. The village of Fishkill Landing was incorporated in 1864. The first settlement in the township was made about 1690. The township of Fishkill was, like Newburgh, an important military post during the War of Independence, and was a supply depot for the northern Continental Army.

FISK, JAMES (1834-1872), American financier, was born at Bennington, Vermont, on the 1st of April 1834. After a brief period in school he ran away and joined a circus. Later he became a hotel waiter, and finally adopted the business of his father, a pedlar. He then became a salesman for a Boston dry goods firm, his aptitude and energy eventually winning for him a share in the business. By his shrewd dealing in army contracts during the Civil War, and it is said by engaging in cotton smuggling,

he accumulated a considerable capital which he soon lost in speculation. In 1864 he became a stockbroker in New York and was employed by Daniel Drew as a buyer. He aided Drew in his war against Vanderbilt for the control of the Erie railway, and as a result of the compromise that was reached he and Jay Gould became members of the Erie directorate. The association with Gould thus began continued until his death. Subsequently by a well-planned "raid," Fisk and Gould obtained control of the road. They carried financial "buccaneering" to extremes, their programme including open alliance with the Tweed "ring," the wholesale bribery of legislatures and the buying of judges. Their attempt to corner the gold market culminated in the fateful Black Friday of the 24th of September 1869. Fisk was shot and killed in New York City by E. S. Stokes, a former business associate, on the 6th of January 1872.

FISK, WILBUR (1792-1839), American educationist, was born in Brattleboro, Vermont, on the 31st of August 1792. He studied at the university of Vermont in 1812-1814, and then entered Brown University, where he graduated in 1815. He studied law, and in 1817 came under the influence of a religious revival in Vermont, where at Lyndon in the following year he was licensed as a local preacher and was admitted to the New England conference. His influence with the conference turned that body from its opposition to higher education as immoral in tendency to the establishment of secondary schools and colleges. Upon the removal in 1824 of the conference's academy at New Market, New Hampshire, to Wilbraham, Massachusetts, Fisk became one of its agents and trustees, and in 1826 its principal. He drafted the report of the committee on education to the general conference in 1828, at which time he declined the bishopric of the Canada conference. He was first president of Wesleyan University from the opening of the university in 1831 until his death on the 22nd of February 1839 in Middletown, Connecticut. His successful administration of the Wesleyan Academy at Wilbraham and of Wesleyan University were remarkable. He was an able controversialist, and in the interests of Arminianism attacked both New England Calvinism and Unitarianism; he published in 1837 *The Calvinistic Controversy*. He also wrote *Travels on the Continent of Europe* (1838).

See *Life and Writings of Wilbur Fisk* (New York, 1842), edited by Joseph Holdich, and the biography by George Prntice (Boston, 1890), in the *American Religious Leaders Series*; also a sketch in *Memoirs of Teachers and Educators* (New York, 1861), edited by Henry Barnard.

FISKE, JOHN (1842-1901), American historical, philosophical and scientific writer, was born in Hartford, Connecticut, on the 30th of March 1842, and died at Gloucester, Massachusetts, on the 4th of July 1901. His name was originally Edmund Fiske Green, but in 1855 he took the name of a great-grandfather, John Fiske. His boyhood was spent with a grandmother in Middletown, Connecticut; and prior to his entering college he had read widely in English literature and history, had surpassed most boys in the extent of his Greek and Latin work, and had studied several modern languages. He graduated at Harvard in 1863, continuing to study languages and philosophy with zeal; spent two years in the Harvard law school, and opened an office in Boston; but soon devoted the greater portion of his time to writing for periodicals. With the exception of one year, he resided at Cambridge, Massachusetts, from the time of his graduation until his death. In 1869 he gave a course of lectures at Harvard on the Positive Philosophy; next year he was history tutor; in 1871 he delivered thirty-five lectures on the Doctrine of Evolution, afterwards revised and expanded as *Outlines of Cosmic Philosophy* (1874); and between 1872 and 1879 he was assistant-librarian. After that time he devoted himself to literary work and lecturing on history. Nearly all of his books were first given to the public in the form of lectures or magazine articles, revised and collected under a general title, such as *Myths and Myth-Makers* (1872), *Darwinism and Other Essays* (1879), *Excursions of an Evolutionist* (1883), and *A Century of Science* (1899). He did much, by the thoroughness of his learning and the lucidity of his style, to spread a knowledge of Darwin and Spencer in America. His *Outlines of Cosmic*

Philosophy, while setting forth the Spencerian system, made psycholocial and sociological additions of original matter, in some respects anticipating Spencer's later conclusions. Of one part of the argument of this work Fiske wrote in the preface of one of his later books (*Through Nature to God*, 1899): "The detection of the part played by the lengthening of infancy in the genesis of the human race is my own especial contribution to the Doctrine of Evolution." In *The Idea of God as affected by Modern Knowledge* (1885) Fiske discusses the theistic problem, and declares that the mind of man, as developed, becomes an illuminating indication of the mind of God, which as a great immanent cause includes and controls both physical and moral forces. More original, perhaps, is the argument in the immediately preceding work, *The Destiny of Man, viewed in the Light of his Origin* (1884), which is, in substance, that physical evolution is a demonstrated fact; that intellectual force is a later, higher and more potent thing than bodily strength; and that, finally, in most men and some "lower animals" there is developed a new idea of the advantageous, a moral and non-selfish line of thought and procedure, which in itself so transcends the physical that it cannot be identified with it or be measured by its standards, and may or must be enduring, or at its best immortal.

It is principally, however, through his work as a historian that Fiske's reputation will live. His historical writings, with the exception of a small volume on *American Political Ideas* (1885), an account of the system of *Civil Government in the United States* (1890), *The Mississippi Valley in the Civil War* (1900), a school history of the United States, and an elementary story of the American Revolution, are devoted to studies, in a unified general manner, of separate yet related episodes in American history. The volumes have not appeared in chronological order of subject, but form a nearly complete colonial history, as follows: *The Discovery of America, with some Account of Ancient America, and the Spanish Conquest* (1892, 2 vols.); *Old Virginia and her Neighbours* (1897, 2 vols.); *The Beginnings of New England; or, The Puritan Theocracy in its Relations to Civil and Religious Liberty* (1889); *Dutch and Quaker Colonies in America* (1899); *The American Revolution* (1891, 2 vols.); and *The Critical Period of American History, 1783-1789* (1888). Of these the most original and valuable is the *Critical Period* volume, a history of the consolidation of the states into a government, and of the formation of the constitution. (C. F. R.)

FISKE, MINNIE MADDERN (1865-), American actress, was born in New Orleans, the daughter of Thomas Davey. As a child she played, under her mother's name of Maddern, with several well-known actors. In 1882 she first appeared as a "star," but in 1890 she married Harrison Grey Fiske and was absent from the stage for several years. In 1893 she reappeared in *Hester Crewe*, a play written by her husband, and afterwards acted a number of Ibsen's heroines, and in *Becky Sharp*, a dramatization of Thackeray's *Vanity Fair*. In 1901 she opened, in opposition to the American theatrical "trust," an independent theatre in New York, the Manhattan. She won a considerable reputation in the United States as an emotional actress.

FISTULA (Lat. for a pipe or tube), a term in surgery used to designate an abnormal communication leading either from the surface of the body to a normal cavity or canal, or from one normal cavity or canal to another. These communications are the result of disease or injury. They receive different names according to their situation: *lacrimal fistula* is the small opening left after the bursting of an abscess in the upper part of the tear-duct, near the root of the nose; *salivary fistula* is an opening into the salivary duct on the cheek; *anal fistula*, or *fistula in ano*, is a suppurating track near the outlet of the bowel; *urethral fistula* is the result of a giving way of the tissues behind a stricture. These are examples of the variety of the first kind of fistula; while *recto-vesical fistula*, a communication between the rectum and bladder, and *vesico-vaginal fistula*, a communication between the bladder and vagina, are examples of the second. The abnormal passage may be straight or tortuous, of considerable diameter or of narrow calibre. Fistulae may be caused by an obstruction of the normal channel, the result

of disease or injury, which prevents, for example, the tears, saliva or urine, as the case may be, from escaping; their retention gives rise to inflammation and ulceration in order that an exit may be obtained by the formation of an abscess, which bursts, for example, into the gut or through the skin; the cavity does not close, and a fistula is the result. The fistulous channel remains open as long as the contents of the cavity or canal with which it is connected can pass through it. To obliterate the fistula one must remove the obstruction and encourage the flow along the natural channel; for example, one must open up the nasal duct so as to allow the tears to reach the nasal cavity, and the *lacrimal fistula* will close; and so also in the *salivary* and *urethral* fistulae. Sometimes it may be necessary to lay the channel freely open, to scrape out the unhealthy material which lines the track, and to encourage it to fill up from its deepest part, as in *anal fistula*; in other cases it may be necessary to pare the edges of the abnormal opening and stitch them together. (E. O.)*

FIT, a word with several meanings. (1) A portion or division of a poem, a canto, in this sense often spelled "fytte." (2) A sudden but temporary seizure or attack of illness, particularly one with convulsive paroxysms accompanied by unconsciousness, especially an attack of apoplexy or epilepsy, but also applied to a transitory attack of gout, of coughing, fainting, &c., also of an outburst of tears, of merriment or of temper. In a transferred sense, the word is also used of any temporary or irregular periods of action or inaction, and hence in such expressions as "by fits and starts." (3) As an adjective, meaning suitable, proper, becoming, often with the idea of having necessary qualifications for a specific purpose, "a fit and proper person"; and also as prepared for, or in a good condition for, any enterprise. The verb "to fit" is thus used intransitively and transitively, to be adapted for, to suit, particularly to be of the right measurement or shape, of a dress, of parts of a mechanism, &c., and to make or render a thing in such a condition. Hence the word is used as a substantive.

The etymology of the word is difficult; the word may be one in origin, or may be a homonymous term, one in sound and spelling but with different origin in each different meaning. In Skeat's *Etymological Dictionary* (ed. 1898) (1) and (2) are connected and derived from the root of "foot," which appears in Lat. *pes, pedis*. The evolution of the word is: step, a part of a poem, a struggle, a seizure. (3) A word of Scandinavian origin, with the idea of "knitted together" (cf. Ice. *fitja*, to knit together, Goth. *fetjan*, to adorn); the ultimate origin is a Teutonic root meaning to seize (cf. "fetch"). The *New English Dictionary* suggests that this last root may be the origin of all the words, and that the underlying meaning is junction, meeting; the early use of "fit" (2) is that of conflict. It is also pointed out that the meanings of "fit," suitable, proper, have been modified by "feat," which comes through Fr. *fait*, from Lat. *factum, facere*, to do, make.

FITCH, JOHN (1743-1798), American pioneer of steam navigation, was born at Windsor, Connecticut, on the 21st of January 1743. He was the son of a farmer, and received the usual common school education. At the age of seventeen he went to sea, but he discontinued his sailor life after a few voyages and became successively a clockmaker, a brassfounder and a silversmith. During the War of Independence he was a sutler to the American troops, and amassed in that way a considerable sum of money, with which he bought land in Virginia. He was appointed deputy-surveyor for Kentucky in 1780, and when returning to Philadelphia in the following year he was captured by the Indians, but shortly afterwards regained his liberty. About this time he began an exploration of the north-western regions, with the view of preparing a map of the district; and while sailing on the great western rivers, the idea occurred to him that they might be navigated by steam. He endeavoured by the sale of his map to find money for the carrying out of his projects, but was unsuccessful. He next applied for assistance to the legislatures of different states, but though each reported in favourable terms of his invention, none of them would agree

to grant him any pecuniary assistance. He was successful, however, in 1786, in forming a company for the prosecution of his enterprise, and shortly afterwards a steam-packet of his invention was launched on the Delaware. His claim to be the inventor of steam-navigation was disputed by James Rumsey of Virginia, but Fitch obtained exclusive rights in steam-navigation in New Jersey, Pennsylvania and Delaware, while a similar privilege was granted to Rumsey in Virginia, Maryland and New York. A steam-boat built by Fitch conveyed passengers for hire on the Delaware in the summer of 1790, but the undertaking was a losing one, and led to the dissolution of the company. In 1793 he endeavoured to introduce his invention into France, but met with no success. On his return to America he found his property overrun by squatters, and reaping from his invention nothing but disappointment and poverty, he committed suicide at Bardstown, Kentucky, on the 2nd of July 1798.

He left behind him a record of his adventures and misfortunes, "inscribed to his children and future posterity"; and from this a biography was compiled by Thompson Westcott (Philadelphia, 1857.)

FITCH, SIR JOSHUA GIRLING (1824-1903), English educationist, second son of Thomas Fitch, of a Colchester family, was born in Southwark, London, in 1824. His parents were poor but intellectually inclined, and at an early age Fitch started work as an assistant master in the British and Foreign School Society's elementary school in the Borough Road, founded by Thomas Lancaster. But he continued to educate himself by assiduous reading and attending classes at University College; he was made headmaster of another school at Kingsland; and in 1850 he took his B.A. degree at London University, proceeding M.A. two years later. In 1852 he was appointed by the British and Foreign School Society to a tutorship at their Training College in the Borough Road, soon becoming vice-principal and in 1856 principal. He had previously done some occasional teaching there, and he was thoroughly imbued with the Lancasterian system. In 1863 he was appointed a government inspector of schools for the York district, from which, after intervals in which he was detached for work as an assistant commissioner (1865-1867) on the Schools Inquiry Commission, as special commissioner (1869), and as an assistant commissioner under the Endowed Schools Act (1870-1877), he was transferred in 1877 to East Lambeth. In 1883 he was made a chief inspector, to superintend the eastern counties, and in 1885 chief inspector of training colleges, a post he held till he retired in 1894. In the course of an extraordinarily active career, he acquired a unique acquaintance with all branches of education, and became a recognized authority on the subject, his official reports, lectures and books having a great influence on the development of education in England. He was a strong advocate and supporter of the movement for the higher education of women, and he was constantly looked to for counsel and direction on every sort of educational subject; his wide knowledge, safe judgment and amiable character made his co-operation of exceptional value, and after he retired from official life his services were in active request in inquiries and on boards and committees. In 1896 he was knighted; and besides receiving such academic distinctions as the LL.D. degree from St Andrews University, he was made a chevalier of the French Legion of Honour in 1889. He was a constant contributor to the leading reviews; he published an important series of *Lectures on Teaching* (1881), *Educational Aims and Methods*, *Notes on American Schools and Colleges* (1887), and an authoritative criticism of *Thomas and Matthew Arnold, and their Influence on English Education* (see also the article on **ARNOLD, MATTHEW**) in 1901; and he wrote the article on **EDUCATION** in the supplementary volumes (10th edition) of this encyclopaedia (1902). He died on the 14th of July 1903 in London. A civil list pension was given to his widow, whom, as Miss Emma Wilks, he had married in 1856.

See also *Sir Joshua Fitch*, by the Rev. A. L. Lilley (1906).

FITCH, RALPH (fl. 1583-1606), London merchant, one of the earliest English travellers and traders in Mesopotamia, the Persian Gulf and Indian Ocean, India proper and Indo-China.

In January 1583 he embarked in the "Tiger" for Tripoli and Aleppo in Syria (see Shakespeare, *Macbeth*, Act I. sc. 3), together with J. Newberie, J. Eldred and two other merchants or employees of the Levant Company. From Aleppo he reached the Euphrates, descended the river from Bir to Fallujah, crossed southern Mesopotamia to Bagdad, and dropped down the Tigris to Basra (May to July 1583). Here Eldred stayed behind to trade, while Fitch and the rest sailed down the Persian Gulf to Ormuz, where they were arrested as spies (at Venetian instigation, as they believed) and sent prisoners to the Portuguese viceroy at Goa (September to October). Through the sureties procured by two Jesuits (one being Thomas Stevens, formerly of New College, Oxford, the first Englishman known to have reached India by the Cape route in 1579) Fitch and his friends regained their liberty, and escaping from Goa (April 1584) travelled through the heart of India to the court of the Great Mogul Akbar, then probably at Agra. In September 1585 Newberie left on his return journey overland via Lahore (he disappeared, being presumably murdered, in the Punjab), while Fitch descended the Jumna and the Ganges, visiting Benares, Patna, Kuch Behar, Hugli, Chittagong, &c. (1585-1586), and pushed on by sea to Pegu and Burma. Here he visited the Rangoon region, ascended the Irawadi some distance, acquired a remarkable acquaintance with inland Pegu, and even penetrated to the Siamese Shan states (1586-1587). Early in 1588 he visited Malacca; in the autumn of this year he began his homeward travels, first to Bengal; then round the Indian coast, touching at Cochin and Goa, to Ormuz; next up the Persian Gulf to Basra and up the Tigris to Mosul (Nineveh); finally via Urfa, Bir on the Euphrates, Aleppo and Tripoli, to the Mediterranean. He reappeared in London on the 29th of April 1591. His experience was greatly valued by the founders of the East India Company, who specially consulted him on Indian affairs (e.g. 2nd of October 1600; 29th of January 1601; 31st of December 1606).

See Hakluyt, *Principal Navigations* (1599), vol. ii. part i. pp. 245-271, esp. 250-268; Linschoten, *Voyages (Itineraris)*, part i. ch. xcii. (vol. ii. pp. 158-169, &c., Hakluyt Soc. edition); Stevens and Birdwood, *Court Records of the East India Company 1590-1603* (1886), esp. pp. 26, 123; *State Papers, East Indies, &c., 1513-1616* (1862), No. 36; Pinkerton, *Voyages and Travels* (1808-1814), ix. 406-425.

FITCHBURG, a city and one of the county-seats of Worcester county, Massachusetts, U.S.A., situated, at an altitude varying from about 433 ft. to about 550 ft., about 23 m. N. of Worcester and about 45 m. W.N.W. of Boston. Pop. (1880) 12,429; (1890) 22,037; (1900) 31,531, of whom 10,917 were foreign-born, including 4063 French Canadians, 836 English Canadians, 2306 Irish and 963 Finns; (1910 census) 37,826. Fitchburg is traversed by the N. branch of the Nashua river, and is served by the Boston & Maine, and the New York, New Haven & Hartford railways, and by three interurban electric lines. The city area (27.7 sq.m.) is well watered, and is very uneven, with hill spurs running in all directions, affording picturesque scenery. The court house and the post office (in a park presented by the citizens) are the principal public buildings. Fitchburg is the seat of a state normal school (1895), with model and training schools; has a free public library (1859; in the Wallace library and art building), the Burbank hospital, the Fitchburg home for old ladies, and an extensive system of parks, in one of which is a fine fountain, designed by Herbert Adams. Fitchburg has large mercantile and financial interests, but manufacturing is the principal industry. The principal manufactures are paper and wood pulp, cotton and woollen goods, yarn and silk, machinery, saws, horn goods, and bicycles and firearms (the Iver Johnson Arms and Cycle Works being located here). In 1905 the city's total factory product was valued at \$15,390,507, of which \$3,019,118 was the value of the paper and wood pulp product, \$2,910,572 was the value of the cotton goods, and \$1,202,421 was the value of the foundry and machine shop products. The municipality owns and operates its (gravity) water works system. Fitchburg was included in Lunenburg until 1764, when it was incorporated as a township and was

named in honour of John Fitch, a citizen who did much to secure incorporation; it was chartered as a city in 1872.

See W. A. Emerson, *Fitchburg, Massachusetts, Past and Present* (Fitchburg, 1887).

FITTIG, RUDOLF (1835–), German chemist, was born at Hamburg on the 6th of December 1835. He studied chemistry at Göttingen, graduating as Ph.D. with a dissertation on acetone in 1858. He subsequently held several appointments at Göttingen, being privat docent (1860), and extraordinary professor (1870). In 1870 he obtained the chair at Tübingen, and in 1876 that at Strassburg, where the laboratories were erected from his designs. Fittig's researches are entirely in organic chemistry, and cover an exceptionally wide field. The aldehydes and ketones provided material for his earlier work. He observed that aldehydes and ketones may suffer reduction in neutral, alkaline, and sometimes acid solution to secondary and tertiary glycols, substances which he named pinacones; and also that certain pinacones when distilled with dilute sulphuric acid gave compounds, which he named pinacolines. The unsaturated acids also received much attention, and he discovered the internal anhydrides of oxyacids, termed lactones. In 1863 he introduced the reaction known by his name. In 1855 Adolph Wurtz had shown that when sodium acted upon alkyl iodides, the alkyl residues combined to form more complex hydrocarbons; Fittig developed this method by showing that a mixture of an aromatic and alkyl haloid, under similar treatment, yielded homologues of benzene. His investigations on Perkin's reaction led him to an explanation of its mechanism which appeared to be more in accordance with the facts. The question, however, is one of much difficulty, and the exact course of the reaction appears to await solution. These researches incidentally solved the constitution of coumarin, the odoriferous principle of woodruff. Fittig and Erdmann's observation that phenyl isocrotonic acid readily yielded α -naphthol by loss of water was of much importance, since it afforded valuable evidence as to the constitution of naphthalene. They also investigated certain hydrocarbons occurring in the high boiling point fraction of the coal tar distillate and solved the constitution of phenanthrene. We also owe much of our knowledge of the alkaloid piperine to Fittig, who in collaboration with Ira Remsen established its constitution in 1871. Fittig has published two widely used text-books; he edited several editions of Wohler's *Grundriss der organischen Chemie* (11th ed., 1887) and wrote an *Unorganische Chemie* (1st ed., 1872; 3rd, 1882). His researches have been recognized by many scientific societies and institutions, the Royal Society awarding him the Davy medal in 1906.

FITTON, MARY (c. 1578–1647), identified by some writers with the "dark lady" of Shakespeare's sonnets, was the daughter of Sir Edward Fitton of Gawsworth, Cheshire, and was baptized on the 24th of June 1578. Her elder sister, Anne, married John Newdigate in 1587, in her fourteenth year. About 1595 Mary Fitton became maid of honour to Queen Elizabeth. Her father recommended her to the care of Sir William Knollys, comptroller of the queen's household, who promised to defend the "innocent lamb" from the "wolfish cruelty and fox-like subtlety of the tame beasts of this place." Sir William was fifty and already married, but he soon became suitor to Mary Fitton, in hope of the speedy death of the actual Lady Knollys, and appears to have received considerable encouragement. There is no hint in her authenticated biography that she was acquainted with Shakespeare. William Kemp, who was a clown in Shakespeare's company, dedicated his *Nine Daies Wonder* to Mistress Anne (perhaps an error for Mary) Fitton, "Maid of Honour to Elizabeth"; and there is a sonnet addressed to her in an anonymous volume, *A Woman's Woorth defended against all the Men in the World* (1599). In 1600 Mary Fitton led a dance in court festivities at which William Herbert, later earl of Pembroke, is known to have been present; and shortly afterwards she became his mistress. In February 1601 Pembroke was sent to the Fleet in connexion with this affair, but Mary Fitton, whose child died soon after its birth, appears to have simply been dismissed from court. Mary Fitton seems to have gone to her sister, Lady

Newdigate, at Arbury. A second scandal has been fixed on Mary Fitton by George Ormerod, author of *History of Cheshire*, in a MS. quoted by Mr. T. Tyler (*Academy*, 27th Sept. 1884). Ormerod asserted, on the strength of the MSS. of Sir Peter Leycester, that she had two illegitimate daughters by Sir Richard Leveson, the friend and correspondent of her sister Anne. He also gives the name of her first husband as Captain Logher, and her second as Captain Polwhele, by whom she had a son and daughter. Polwhele died in 1609 or 1610, about three years after his marriage. But Ormerod was mistaken in the order of Mary Fitton's husbands, for her second husband, Logher, died in 1636. Her own will, which was proved in 1647, gives her name as "Mary Lougher." In Gawsworth church there is a painted monument of the Fittons, in which Anne and Mary are represented kneeling behind their mother. It is stated that from what remains of the colouring Mary was a dark woman, which is of course essential to her identification with the lady of the sonnets, but in the portraits at Arbury described by Lady Newdigate-Newdegate in her *Gossip from a Muniment Room* (1897) she has brown hair and grey eyes.

The identity of the Arbury portrait with Mary Fitton was challenged by Mr Tyler and by Dr Furnivall. For an answer to their remarks see an appendix by C. G. O. Bridgeman in the 2nd edition of Lady Newdigate-Newdegate's book.

The suggestion that Mary Fitton should be regarded as the false mistress of Shakespeare's sonnets rests on a very thin chain of reasoning, and by no means follows on the acceptance of the theory that William Herbert was the addressee of the sonnets, though it of course fails with the rejection of that supposition. Mr William Archer (*Fortnightly Review*, December 1897) found some support for Mary Fitton's identification with the "dark lady" in the fact that Sir William Knollys was also her suitor, thus numbering three "Wills" among her admirers. This supplies a definite interpretation, whether right or wrong, to the initial lines of Sonnet 135:—

"Whoever hath her wish, thou hast thy 'Will',
And 'Will' to boot, and 'Will' in overplus."

Arguments in favour of her adoption into the Shakespeare circle will be found in Mr Thomas Tyler's *Shakespeare's Sonnets* (1890, pp. 73-92), and in the same writer's *Herbert-Fitton Theory of Shakespeare's Sonnets* (1898).

FITTON, WILLIAM HENRY (1780–1861), British geologist was born in Dublin in January 1780. Educated at Trinity College, in that city, he gained the senior scholarship in 1798, and graduated in the following year. At this time he began to take interest in geology and to form a collection of fossils. Having adopted the medical profession he proceeded in 1808 to Edinburgh, where he attended the lectures of Robert Jameson, and thenceforth his interest in natural history and especially in geology steadily increased. He removed to London in 1809, where he further studied medicine and chemistry. In 1811 he brought before the Geological Society of London a description of the geological structure of the vicinity of Dublin, with an account of some rare minerals found in Ireland. He took a medical practice at Northampton in 1812, and for some years the duties of his profession engrossed his time. He was admitted M.D. at Cambridge in 1816. In 1820, having married a lady of means, he settled in London, and devoted himself to the science of geology with such assiduity and thoroughness that he soon became a leading authority, and in the end, as Murchison said, "one of the British worthies who have raised modern geology to its present advanced position." His "Observations on some of the Strata between the Chalk and the Oxford Oolite, in the South-east of England" (*Trans. Geol. Soc.* ser. 2, vol. iv.) embodied a series of researches extending from 1824 to 1836, and form the classic memoir familiarly known as Fitton's "Strata below the Chalk." In this great work he established the true succession and relations of the Upper and Lower Greensand, and of the Wealden and Purbeck formations, and elaborated their detailed structure. He had been elected F.R.S. in 1815, and he was president of the Geological Society of London 1827–1829. His house then became a meeting place for scientific workers, and during his presidency he held a conversazione open on Sunday evenings to all fellows of the Geological Society. From 1817 to 1841 he contributed to the *Edinburgh Review* many admirable essays on the progress of geological science; he also wrote "Notes on the

Progress of Geology in England" for the *Philosophical Magazine* (1832-1833). His only independent publication was *A Geological Sketch of the Vicinity of Hastings* (1833). He was awarded the Wollaston medal by the Geological Society in 1852. He died in London on the 13th of May 1861.

Obituary by R. I. Murchison in *Quart. Journ. Geol. Soc.*, vol. xviii., 1862, p. xxx.

FITZBALL, EDWARD (1792-1873), English dramatist, whose real patronymic was Ball, was born at Burwell, Cambridgeshire, in 1792. His father was a well-to-do farmer, and Fitzball, after receiving his schooling at Newmarket, was apprenticed to a Norwich printer in 1809. He produced some dramatic pieces at the local theatre, and eventually the marked success of his *Innkeeper of Abbeville, or The Ostler and the Robber* (1820), together with the friendly acceptance of one of his pieces at the Surrey theatre by Thomas Dibdin, induced him to settle in London. During the next twenty-five years he produced a great number of plays, most of which were highly successful. He had a special talent for nautical drama. His *Floating Beacon* (Surrey theatre, 19th of April 1824) ran for 140 nights, and his *Pilot* (Adelphi, 1825) for 200 nights. His greatest triumph in melodrama was perhaps *Jonathan Bradford, or the Murder at the Roadside Inn* (Surrey theatre, 12th of June 1833). He was at one time stock dramatist and reader of plays at Covent Garden, and afterwards at Drury Lane. He had a considerable reputation as a song-writer and as a librettist in opera. The last years of his life were spent in retirement at Chatham, where he died on the 27th of October 1873.

His autobiography, *Thirty-Five Years of a Dramatic Author's Life* (2 vols., 1859), is a naïve record of his career. Numbers of his plays are printed in *Cumberland's Minor British Theatre*, *Dick's Standard Plays* and *Lacy's Acting Edition of Plays*.

FITZGERALD, the name of an historic Irish house, which descends from Walter, son of Other, who at the time of the Domesday Survey (1086) was castellan of Windsor and a tenant-in-chief in five counties. From his eldest son William, known as "de Windsor," descended the Windsors of Stanwell, of whom Andrew Windsor was created Lord Windsor of Stanwell (a Domesday possession of the house) by Henry VIII., which barony is now vested in the earl of Plymouth, his descendant in the female line. Of Walter's younger sons, Robert was given by Henry I. the barony of Little Easton, Essex; Maurice obtained the stewardship (*dapiferatus*) of the great Suffolk abbey of Bury St Edmunds; Reinald the stewardship to Henry I.'s queen, Adeliza; and Gerald (also a *dapifer*) became the ancestor of the FitzGeralds. As constable and captain of the castle that Arnulf de Montgomery raised at Pembroke, Gerald strengthened his position in Wales by marrying Nesta, sister of Griffith, prince of South Wales, who bore to him famous children, "by whom the southern coast of Wales was saved for the English and the bulwarks of Ireland stormed." Of these sons William, the eldest, was succeeded by his son Odo, who was known as "de Carew," from the fortress of that name at the neck of the Pembroke peninsula, the eldest son Gerald having been slain by the Welsh. The descendants of Odo held Carew and the manor of Moulsoford, Berks, and some of them acquired lands in Ireland. But the wild claims of Sir Peter Carew, under Queen Elizabeth, to vast Irish estates, including half of "the kingdom of Cork," were based on a fictitious pedigree. Odo de Carew's brothers, Reimund "Fitz William" (known as "Le Gros") and Griffin "Fitz William," took an active part in the conquest of Ireland.

Returning to Gerald and Nesta, their son David "Fitz Gerald" became bishop of St David's (1147-1176), and their daughter Angharat mother of Gerald de Barri (Giraldus Cambrensis, *q. v.*), the well-known historian and the eulogist of his mother's family. A third son, Maurice, obtained from his brother the stewardship (*dapiferatus*) of St David's, *c.* 1174, and having landed in Ireland in 1169, on the invitation of King Dermot, founded the fortunes of his house there, receiving lands at Wexford, where he died and was buried in 1176. His eventual territory, however, was the great barony of the Naas in Ophaley (now in Kildare), which Strongbow granted him with Wicklow Castle; but his sons were

forced to give up the latter. His eldest son William succeeded him as baron of the Naas and steward of St David's, but William's granddaughter carried the Naas to the Butlers and so to the Loundresses. Gerald, a younger son of Maurice, who obtained lands in Ophaley, was father of Maurice "Fitz Gerald," who held the great office of justiciar of Ireland from 1232 to 1245. In 1234 he fought and defeated his overlord, the earl marshal, Richard, earl of Pembroke, and he also fought for his king against the Irish, the Welsh, and in Gascony, dying in 1257. He held Maynooth Castle, the seat of his descendants.

Much confusion follows in the family history, owing to the justiciar leaving a grandson Maurice (son of his eldest son Gerald) and a younger son Maurice, of whom the latter was justiciar for a year in 1272, while the former, as heir male and head of the race, inherited the Ophaley lands, which he is said to have bequeathed at his death (1287) to John "Fitz Thomas," whose fighting life was crowned by a grant of the castle and town of Kildare, and of the earldom of Kildare to him and the heirs male of his body (May 14th, 1316). Dying shortly after, he was succeeded by his son Thomas, son-in-law of Richard (de Burgh) the "red earl" of Ulster, who received the hereditary shrievalty of Kildare in 1317, and was twice (1320, 1327) justiciar of Ireland for a year. His younger son Maurice "Fitz Thomas," 4th earl (1331-1390), was frequently appointed justiciar, and was great-grandfather of Thomas, the 7th earl (1427-1477), who between 1455 and 1475 was repeatedly in charge of the government of Ireland as "deputy," and who founded the "brotherhood of St George" for the defence of the English Pale. He was also made lord chancellor of Ireland in 1463. His son Gerald, the 8th earl (1477-1513), called "More" (the Great), was deputy governor of Ireland from 1481 for most of the rest of his life, though imprisoned in the Tower two years (1494-1496) on suspicion as a Yorkist. He was mortally wounded while fighting the Irish as "deputy." Gerald, the 9th earl (1513-1534), followed in his father's steps as deputy, fighting the Irish, till the enmity of the earl of Ormonde, the hereditary rival of his house, brought about his deposition in 1520. In spite of temporary restorations he finally died a prisoner in the Tower.

In his anger at his rival's successes the 9th earl had been led, it was suspected, into treason, and while he was a prisoner in England his son Lord Thomas Fitzgerald, "Silken Thomas," broke out into open revolt (1534), and declared war on the government; his followers slew the archbishop of Dublin and laid siege to Dublin Castle. Meanwhile he made overtures to the native Irish, to the pope and to the emperor; but the Butlers took up arms against him, an English army laid siege to his castle of Maynooth, and, though its fall was followed by a long struggle in the field, the earl, deserted by O'Connor, had eventually to surrender himself to the king's deputy. He was sent to the Tower, where he was subsequently joined by his five uncles, arrested as his accomplices. They were all six executed as traitors in February 1537, and acts of attainder completed the ruin of the family.

But the earl's half-brother, Gerald (whose sister Elizabeth was the earl of Surrey's "fair Geraldine"), a mere boy, had been carried off, and, after many adventures at home and abroad, returned to England after Henry VIII.'s death, and to propitiate the Irish was restored to his estates by Edward VI. (1552). Having served Mary in Wyatt's rebellion, he was created by her earl of Kildare and Lord Offaley, on the 13th of May 1554, but the old earldom (though the contrary is alleged) remained under attainder. Although he conformed to the Protestant religion under Elizabeth and served against the Munster rebels and their Spanish allies, he was imprisoned in the Tower on suspicion of treason in 1583. But the acts attainting his family had been repealed in 1569, and the old earldom was thus regained. In 1585 he was succeeded by his son Henry ("of the Battleaxes"), who was mortally wounded when fighting the Tyrone rebels in 1597. On the death of his brother in 1599 the earldom passed to their cousin Gerald, whose claim to the estates was opposed by Lettice, Lady Digby, the heir-general. She obtained the ancestral castle of Geashill with its territory and was recognized

in 1620 as Lady Offaley for life. George, the 16th earl (1620-1660), had his castle of Maynooth pillaged by the Roman Catholics in 1642, and after its subsequent occupation by them in 1646 it was finally abandoned by the family.

The history of the earls after the Restoration was uneventful, save for the re-acquisition in 1739 of Carton, which thenceforth became the seat of the family, until James the 20th earl (1722-1773), who obtained a viscounty of Great Britain in 1747, built Leinster House in Dublin, and formed a powerful party in the Irish parliament. In 1756 he was made lord deputy; in 1760 he raised the royal Irish regiment of artillery; and in 1766 he received the dukedom of Leinster, which remained the only Irish dukedom till that of Abercorn was created in 1868. His wealth and connexions secured him a commanding position. Of his younger children one son was created Lord Lecale; another was the well-known rebel, Lord Edward Fitzgerald; another was the ancestor of Lord De Ros; and a daughter was created Baroness Rayleigh. William Robert, the 2nd duke (1749-1804), was a cordial supporter of the Union, and received nearly £30,000 for the loss of his borough influence. In 1883 the family was still holding over 70,000 acres in Co. Kildare; but, after a tenure of nearly 750 years, arrangements were made to sell them to the tenants under the recent Land Purchase Acts. In 1893 Maurice Fitzgerald (b. 1887) succeeded his father Gerald, the 5th duke (1851-1893), as 6th duke of Leinster.

The other great Fitzgerald line was that of the earls of Desmond, who were undoubtedly of the same stock and claimed descent from Maurice, the founder of the family in Ireland, through a younger son Thomas. It would seem that Maurice, grandson of Thomas, was father of Thomas "Fitz Maurice" *Nappagh* ("of the ape"), justice of Ireland in 1295, who obtained a grant of the territory of "Decies and Desmond" in 1292, and died in 1298. His son Maurice Fitz Thomas or Fitzgerald, inheriting vast estates in Munster, and strengthening his position by marrying a daughter of Richard de Burgh, earl of Ulster, was created earl of Desmond (*i.e.* south Munster) on the 22nd of August 1329, and Kerry was made a palatine liberty for him. The greatest Irish noble of his day, he led the Anglo-Irish party against the English representatives of the king, and was attacked as the king's enemy by the viceroy in 1345. He surrendered in England to the king and was imprisoned, but eventually regained favour, and was even made viceroy himself in 1355. He died, however, the following year. Two of his sons succeeded in turn, Gerald, the 3rd earl (1359-1398), being appointed justiciar (*i.e.* viceroy) in 1367, despite his adopting his father's policy which the crown still wished to thwart. But he was superseded two years later, and defeated and captured by the native king of Thomond shortly after. Yet his sympathies were distinctly Irish. The remote position of Desmond in the south-west of Ireland tended to make the succession irregular on native lines, and a younger son succeeded as 6th or 7th earl about 1422. His son Thomas, the next earl (1462-1467), governed Ireland as deputy from 1463 to 1467, and upheld the endangered English rule by stubborn conflict with the Irish. Yet Tiptoft, who superseded him, procured his attainder with that of the earl of Kildare, on the charge of alliance with the Irish, and he was beheaded on the 14th of February 1468, his followers in Munster avenging his death by invading the Pale. His younger son Maurice, earl from 1487 to 1520, was one of Perkin Warbeck's Irish supporters, and besieged Waterford on his behalf. His son James (1520-1529) was proclaimed a rebel and traitor for conspiring with the French king and with the emperor. At his death the succession reverted to his uncle Thomas (1529-1534), then an old man, at whose death there was a contest between his younger brother Sir John "of Desmond" and his grandson James, a court page of Henry VIII. Old Sir John secured possession till his death (1536), when his son James succeeded *de facto*, and *de jure* on the rightful earl being murdered by the usurper's younger brother in 1540. Intermarriage with Irish chieftains had by this time classed the earls among them, but although this James looked to their support before 1540, he thenceforth played so prudent a part that in spite of the efforts of the Butlers, the hereditary

foes of his race, he escaped the fate of the Kildare branch and kept Munster quiet and in order for the English till his death in 1558. His four marriages produced a disputed succession and a break-up of the family. His eldest son Thomas "Roe" (the Red) was disinherited, and failed to obtain the earldom, which was confirmed by Elizabeth to his half-brother Gerald "the rebel earl" (1558-1582), but Gerald had other enemies in his uncle Maurice (the murderer of 1540) and his son especially, the famous James "Fitz Maurice" Fitz Gerald. Gerald's turbulence and his strife with the Butlers led to his detention in England (1562-1564) and again in 1565-1566. In 1567 Sidney imprisoned him in Dublin Castle, whence, with his brother, Sir John "of Desmond," he was sent to England and the Tower, and not allowed to return to Ireland till 1573. Meanwhile the above James, in spite of the protests of Thomas "Roe," had usurped his position in his absence and induced the natives to choose him as "captain" or chieftain of Desmond. He formed a strong Irish Catholic party and broke into revolt in 1569. Suppressed by Sidney, he rebelled again, till crushed by Perrot in 1573. As Earl Gerald on his return would not join James in revolt, the latter withdrew to France. But Gerald himself, after some trimming, rose in rebellion (July 1574), though he soon submitted to the queen's forces. On the continent James Fitz Maurice offered the crown of Ireland in succession to France and to Spain, and finally to the nephew of Pope Gregory XIII. With the papal nuncio and a few troops he landed at Dingle in Kerry (June 1579) and called on the earls of Kildare and Desmond to join him, but the latter assured the English government of his loyalty, and James was killed in a skirmish. Yet Desmond was viewed with suspicion and finally forced, by being proclaimed as a traitor (Nov. 1st, 1579), into a miserable rebellion. His castles were soon captured, and he was hunted as a fugitive, till surprised and beheaded on the 11th of November 1583, after long wanderings, his head being fixed on London Bridge. His ruin is attributable to his restless turbulence and lack of settled policy. The vast estates of the earls, estimated at 600,000 acres, were forfeited by act of parliament.

But the influence of his mighty house was still great among the Irish. The disinherited Thomas "Roe" left a son James "Fitz Thomas," who, succeeding him in 1595 and finding that the territory of the earls would never be restored, assumed the earldom and joined O'Neill's rebellion in 1598, at the head of 8000 of his men. Long sheltered from capture by the fidelity of the peasantry, he was eventually seized (1601) by his kinsman the White Knight, Edmund Fitz Gibbon, whose sister-in-law he had married, and sent to the Tower. The "sugan" (sham) earl lingered there obscurely as "James M'Thomas" till his death. In consequence of his rebellion and the devotion of the Irish to his race, James, son of Gerald "the rebel earl," who had remained in the Tower since his father's death (1583), was restored as earl of Desmond and sent over to Munster in 1600, but he, known as "the queen's earl," could, as a Protestant, do nothing, and he died unmarried in 1601. The "sugan" earl's brother John, who had joined in his rebellion, escaped into Spain, and left a son Gerald, who appears to have assumed the title and was known as the Conde de Desmond. He was killed in the service of the emperor Ferdinand in 1632. The common origin of the earls of Desmond and of Kildare had never been forgotten, and intermarriage had cemented the bond. Just before his death the exile wrote as "Desmond *alias* Gerratt Fitz Gerald" to his "Most Noble Cosen" the earl of Kildare, that "wee must not be oblivious of the true amity and love that was inviolably observed betweene our antenates and elders."

There can be no doubt that the house of Fitzmaurice was also of this stock, although their actual origin, in the 12th century, is doubtful. From a very early date they were feudal lords of Kerry, and their dignity was recognized as a peerage by Henry VII. in 1489. The isolated position of their territory ("Clanmaurice") threw them even more among the Irish than the earls of Desmond, and they often adopted the native form of their name, "MacMorrish." Under Elizabeth the lords of Kerry narrowly escaped sharing the ruin of the earls. The conduct

of Thomas in the rebellion of James "Fitz Maurice" was suspicious, and his sons joined in that of the earl of Desmond, while he himself was a rebel in 1582. Patrick, his successor (1590-1600), was captured in rebellion (1587), and when free, joined the revolt of 1598, as did his son and heir Thomas, who continued in the field till he obtained pardon and restoration in 1603, though suspect till his death in 1630. His grandson withdrew to France with James II., but the next peer became a supporter of the Whig cause, married the eventual heiress of Sir William Petty, and was created earl of Kerry in 1723. From him descend the family of Petty-Fitzmaurice, who obtained the marquessate of Lansdowne (*q.v.*) in 1818, and still hold among their titles the feudal barony of Kerry together with vast estates in that county.

From the three sons by a second wife of one of the earls of Desmond's ancestors, descended the hereditary White Knights, Knights of Glin and Knights of Kerry, these feudal dignities having, it is said, been bestowed upon them by their father, as Lord Decies and Desmond. Glin Castle, county Limerick, is still the seat of the (Fitzgerald) Knight of Glin. Valencia Island is now the seat of the Knights of Kerry, who received a baronetcy in 1880.

AUTHORITIES.—Calendars of Irish documents and state papers and Carew papers; Gilbert's *Viceroy's of Ireland*; Lord Kildare's *Earls of Kildare*; G. E. Clokayne's *Complete Peerage*; Haymond Graves, *Unpublished Geraldine Documents*; *Annals of the Four Masters*; Calendar of the duke of Leinster's MSS. in 9th *Report on Historical MSS.*, part ii.; Ware's *Annals*; J. H. Round's "Origin of the Fitzgeralds" and "Origin of the Carews" in the *Ancestor*; his "Earldom of Kildare and Barony of Offaley" in *Genealogist*, ix., and "Barons of the Naas" in *Genealogist*, xv.; and his "Decies and Desmond" in *Eng. Hist. Rev.* xviii. (J. H. R.)

FITZGERALD, EDWARD (1809-1883), English writer, the poet of Omar Khayyám, was born as EDWARD PURCELL, at Bredfield House, in Suffolk, on the 31st of March 1809. His father, John Purcell, who had married a Miss FitzGerald, assumed in 1818 the name and arms of his wife's family. From 1816 to 1821 the FitzGerald lived at St Germain and at Paris, but in the latter year Edward was sent to school at Bury St Edmunds. In 1826 he proceeded to Trinity College, Cambridge, where, some two years later, he became acquainted with Thackeray and W. H. Thompson. With Tennyson, "a sort of Hyperion," his intimacy began about 1835. In 1830 he went to live in Paris, but in 1831 was in a farm-house on the battlefield of Naseby. He adopted no profession, and lived a perfectly stationary and rustic life, presently moving into his native county of Suffolk, and never again leaving it for more than a week or two. Until 1835 the FitzGerald lived at Wherstead; from that year until 1853 the poet resided at Boulge, near Woodbridge; until 1860 at Farlingay Hall; until 1873 in the town of Woodbridge; and then until his death at his own house hard by, called Little Grange.

During most of this time FitzGerald gave his thoughts almost without interruption to his flowers, to music and to literature. He allowed friends like Tennyson and Thackeray, however, to push on far before him, and long showed no disposition to emulate their activity. In 1851 he published his first book, *Euphranor*, a Platonic dialogue, born of memories of the old happy life at Cambridge. In 1852 appeared *Polonius*, a collection of "saws and modern instances," some of them his own, the rest borrowed from the less familiar English classics. FitzGerald began the study of Spanish poetry in 1850, when he was with Professor E. B. Cowell at Elmsett and that of Persian in Oxford in 1853. In the latter year he issued *Six Dramas of Calderon*, freely translated. He now turned to Oriental studies, and in 1856 he anonymously published a version of the *Salámán and Absál* of Jámi in Miltonic verse. In March 1857 the name with which he has been so closely identified first occurs in FitzGerald's correspondence—"Hafiz and Omar Khayyám ring like true metal." On the 15th of January 1859 a little anonymous pamphlet was published as *The Rubáiyát of Omar Khayyám*. In the world at large, and in the circle of FitzGerald's particular friends, the poem seems at first to have attracted no attention. The publisher allowed it to gravitate to the fourpenny or even

(as he afterwards boasted) to the penny box on the bookstalls. But in 1860 Rossetti discovered it, and Swinburne and Lord Houghton quickly followed. The *Rubáiyát* became slowly famous, but it was not until 1868 that FitzGerald was encouraged to print a second and greatly revised edition. Meanwhile he had produced in 1865 a version of the *Agamemnon*, and two more plays from Calderon. In 1880-1881 he issued privately translations of the two Oedipus tragedies; his last publication was *Readings in Crabbe*, 1882. He left in manuscript a version of Attar's *Mantic-Uttair* under the title of *The Bird Parliament*.

From 1861 onwards FitzGerald's greatest interest had centred in the sea. In June 1863 he bought a yacht, "The Scandal," and in 1867 he became part-owner of a herring-lugger, the "Meum and Tuum." For some years, till 1871, he spent the months from June to October mainly in "knocking about somewhere outside of Lowestoft." In this way, and among his books and flowers, FitzGerald gradually became an old man. On the 14th of June 1883 he passed away painlessly in his sleep. He was "an idle fellow, but one whose friendships were more like loves." In 1885 a stimulus was given to the steady advance of his fame by the fact that Tennyson dedicated his *Tiresias* to FitzGerald's memory, in some touching reminiscent verses to "Old Fitz." This was but the signal for that universal appreciation of Omar Khayyám in his English dress, which has been one of the curious literary phenomena of recent years. The melody of FitzGerald's verse is so exquisite, the thoughts he rearranges and strings together are so profound, and the general atmosphere of poetry in which he steeped his version is so pure, that no surprise need be expressed at the universal favour which the poem has met with among critical readers. But its popularity has gone much deeper than this; it is now probably better known to the general public than any single poem of its class published since the year 1860, and its admirers have almost transcended common sense in the extravagance of their laudation. FitzGerald married, in middle life, Lucy, the daughter of Bernard Barton, the Quaker poet. Of FitzGerald as a man practically nothing was known until, in 1889, Mr W. Aldis Wright, his intimate friend and literary executor, published his *Letters and Literary Remains* in three volumes. This was followed in 1895 by the *Letters to Fanny Kemble*. These letters constitute a fresh bid for immortality, since they discovered that FitzGerald was a witty, picturesque and sympathetic letter-writer. One of the most unobtrusive authors who ever lived, FitzGerald has, nevertheless, by the force of his extraordinary individuality, gradually influenced the whole face of English *belles-lettres*, in particular as it was manifested between 1890 and 1900.

The Works of Edward FitzGerald appeared in 1887. See also a chronological list of FitzGerald's works (Caxton Club, Chicago, 1899); notes for a bibliography by Col. W. F. Prideaux, in *Notes and Queries* (9th series, vol. vi.), published separately in 1901; *Letters and Literary Remains* (ed. W. Aldis Wright, 1902-1903); and the *Life of Edward FitzGerald*, by Thomas Wright (1904), which contains a bibliography (vol. ii. pp. 241-243) and a list of sources (vol. i. pp. xvi.-xvii.). The volume on FitzGerald in the "English Men of Letters" series is by A. C. Benson. The FitzGerald centenary was celebrated in March 1909. See the *Centenary Celebrations Souvenir* (Ipswich, 1909) and *The Times* for March 25, 1909. (E. G.)

FITZGERALD, LORD EDWARD (1763-1798), Irish conspirator, fifth son of James, 1st duke of Leinster, by his wife Emilia Mary, daughter of Charles Lennox, 2nd duke of Richmond, was born at Carton House, near Dublin, on the 15th of October 1763. In 1773 the duke of Leinster died, and his widow soon afterwards married William Ogilvie, who superintended Lord Edward's early education. Joining the army in 1779, Lord Edward served with credit in America on the staff of Lord Rawdon (afterwards marquess of Hastings), and at the battle of Eutaw Springs (8th of September 1781) he was severely wounded, his life being saved by a negro named Tony, whom Lord Edward retained in his service till the end of his life. In 1783 FitzGerald returned to Ireland, where his brother, the duke of Leinster, had procured his election to the Irish parliament as member for Athy. In parliament he acted with the small

Opposition group led by Grattan (*q.v.*), but took no prominent part in debate. After spending a short time at Woolwich to complete his military education, he made a tour through Spain in 1787; and then, dejected by unrequited love for his cousin Georgina Lennox (afterwards Lady Bathurst), he sailed for New Brunswick to join the 54th regiment with the rank of major. The love-sick mood and romantic temperament of the young Irishman found congenial soil in the wild surroundings of unexplored Canadian forests, and the enthusiasm thus engendered for the "natural" life of savagery may have been already fortified by study of Rousseau's writings, for which at a later period Lord Edward expressed his admiration. In February 1789, guided by compass, he traversed the country, practically unknown to white men, from Frederickstown to Quebec, falling in with Indians by the way, with whom he fraternized; and in a subsequent expedition he was formally adopted at Detroit by the Bear tribe of Hurons as one of their chiefs, and made his way down the Mississippi to New Orleans, whence he returned to England.

Finding that his brother had procured his election for the county of Kildare, and desiring to maintain political independence, Lord Edward refused the command of an expedition against Cadiz offered him by Pitt, and devoted himself for the next few years to the pleasures of society and his parliamentary duties. He was on terms of intimacy with his relative C. J. Fox, with R. B. Sheridan and other leading Whigs. According to Thomas Moore, Lord Edward Fitzgerald was the only one of the numerous suitors of Sheridan's first wife whose attentions were received with favour; and it is certain that, whatever may have been its limits, a warm mutual affection subsisted between the two. His Whig connexions combined with his transatlantic experiences to predispose Lord Edward to sympathize with the doctrines of the French Revolution, which he embraced with ardour when he visited Paris in October 1792. He lodged with Thomas Paine, and listened to the debates in the Convention. At a convivial gathering on the 18th of November he supported a toast to "the speedy abolition of all hereditary titles and feudal distinctions," and gave proof of his zeal by expressly repudiating his own title—a performance for which he was dismissed from the army. While in Paris Fitzgerald became enamoured of a young girl whom he chanced to see at the theatre, and who is said to have had a striking likeness to Mrs Sheridan. Procuring an introduction he discovered her to be a *protégée* of Madame de Sillery, comtesse de Genlis. The parentage of the girl, whose name was Pamela (?1776-1831), is uncertain; but although there is some evidence to support the story of Madame de Genlis that Pamela was born in Newfoundland of parents called Seymour or Sims, the common belief that she was the daughter of Madame de Genlis herself by Philippe (*Égalité*), duke of Orleans, was probably well founded. On the 27th of December 1792 Fitzgerald and Pamela were married at Tournay, one of the witnesses being Louis Philippe, afterwards king of the French; and in January 1793 the couple reached Dublin.

Discontent in Ireland was now rapidly becoming dangerous, and was finding a focus in the Society of the United Irishmen, and in the Catholic Committee, an organization formed a few years previously, chiefly under the direction of Lord Ker-mare, to watch the interests of the Catholics. French revolutionary doctrines had become ominously popular, and no one sympathized with them more warmly than Lord Edward Fitzgerald, who, fresh from the gallery of the Convention in Paris, returned to his seat in the Irish parliament and threw himself actively into the work of opposition. Within a week of his arrival he denounced in the House of Commons a government proclamation, which Grattan had approved, in language so violent that he was ordered into custody and required to apologize at the bar of the House. As early as 1794 the government had information that placed Lord Edward under suspicion; but it was not till 1796 that he joined the United Irishmen, whose aim after the recall of Lord Fitzwilliam in 1795 was avowedly the establishment of an independent Irish republic. In May 1796 Theobald Wolfe Tone was in Paris endeavouring to obtain French assist-

ance for an insurrection in Ireland. In the same month Fitzgerald and his friend Arthur O'Connor proceeded to Hamburg, where they opened negotiations with the Directory through Reinhard, French minister to the Hanseatic towns. The duke of York, meeting Pamela at Devonshire House on her way through London with her husband, had told her that "all was known" about his plans, and advised her to persuade him not to go abroad. The proceedings of the conspirators at Hamburg were made known to the government in London by an informer, Samuel Turner. Pamela was entrusted with all her husband's secrets and took an active part in furthering his designs; and she appears to have fully deserved the confidence placed in her, though there is reason to suppose that at times she counselled prudence. The result of the Hamburg negotiations was Hoche's abortive expedition to Bantry Bay in December 1796. In September 1797 the government learnt from the informer MacNally that Lord Edward was among those directing the conspiracy of the United Irishmen, which was now quickly maturing. He was specially concerned with the military organization, in which he held the post of colonel of the Kildare regiment and head of the military committee. He had papers showing that 280,000 men were ready to rise. They possessed some arms, but the supply was insufficient, and the leaders were hoping for a French invasion to make good the deficiency and to give support to a popular uprising. But French help proving dilatory and uncertain, the rebel leaders in Ireland were divided in opinion as to the expediency of taking the field without waiting for foreign aid. Lord Edward was among the advocates of the bolder course. His opinions and his proposals for action were alike violent. He was on intimate terms with apologists for assassination; there is some evidence that he favoured a project for the massacre of the Irish peers while in procession to the House of Lords for the trial of Lord Kingston in May 1798. It was probably abhorrence of such measures that converted Thomas Reynolds from a conspirator to an informer; at all events, by him and several others the authorities were kept posted in what was going on, though lack of evidence producible in court delayed the arrest of the ringleaders. But on the 12th of March 1798 Reynolds' information led to the seizure of a number of conspirators at the house of Oliver Bond. Lord Edward Fitzgerald, warned by Reynolds, was not among them. The government were anxious to save him from the consequences of his own folly, and Lord Clare said to a member of his family, "for God's sake get this young man out of the country; the ports shall be thrown open, and no hindrance whatever offered." Fitzgerald with chivalrous recklessness refused to desert others who could not escape, and whom he had himself led into danger. On the 30th of March a proclamation establishing martial law and authorizing the military to act without orders from the civil magistrate, which was acted upon with revolting cruelty in several parts of the country, precipitated the crisis.

The government had now no choice but to secure if possible the person of Lord Edward Fitzgerald, whose social position more than his abilities made him the most important factor in the conspiracy. On the 11th of May a reward of £1000 was offered for his apprehension. The 23rd of May was the date fixed for the general rising. Since the arrest at Bond's, Fitzgerald had been in hiding, latterly at the house of one Murphy, a feather dealer, in Thomas Street, Dublin. He twice visited his wife in disguise; was himself visited by his stepfather, Ogilvie, and generally observed less caution than his situation required. The conspiracy was honeycombed with treachery, and it was long a matter of dispute to whose information the government were indebted for Fitzgerald's arrest; but it is no longer open to doubt that the secret of his hiding place was disclosed by a Catholic barrister named Magan, to whom the stipulated reward was ultimately paid through Francis Higgins, another informer. On the 19th of May Major Swan and a Mr. Ryan proceeded to Murphy's house with Major H. C. Sirr and a few soldiers. Lord Edward was discovered in bed. A desperate scuffle took place, Ryan being mortally wounded by Fitzgerald with a dagger, while Lord Edward himself was only secured after Sirr had

disabled him with a pistol bullet in the shoulder. He was conveyed to Newgate gaol, where by the kindness of Lord Clare he was visited by two of his relatives, and where he died of his wound on the 4th of June 1798. An Act of Attainder (repealed in 1819) was passed, confiscating his property; and his wife—against whom the government probably possessed sufficient evidence to secure a conviction for treason—was compelled to leave the country before her husband had actually expired.

Pamela, who was scarcely less celebrated than Lord Edward himself, and whose remarkable beauty made a lasting impression on Robert Southey, repaired to Hamburg, where in 1800 she married J. Pitcairn, the American consul. Since her marriage with Lord Edward she had been greatly beloved and esteemed by the whole Fitzgerald family; and although after her second marriage her intimacy with them ceased, there is no sufficient evidence for the tales that represented her subsequent conduct as open to grave censure. She remained to the last passionately devoted to the memory of her first husband; and she died in Paris in November 1831. A portrait of Pamela is in the Louvre. She had three children by Lord Edward Fitzgerald: Edward Fox (1794–1863); Pamela, afterwards wife of General Sir Guy Campbell; and Lucy Louisa, who married Captain Lyon, R.N.

Lord Edward Fitzgerald was of small stature and handsome features. His character and career have been made the subject of eulogies much beyond their merits. He had, indeed, a winning personality, and a warm, affectionate and generous nature, which made him greatly beloved by his family and friends; he was humorous, light-hearted, sympathetic, adventurous. But he was entirely without the weightier qualities requisite for such a part as he undertook to play in public affairs. Hot-headed and impulsive, he lacked judgment. He was as conspicuously deficient in the statesmanship as he was in the oratorical genius of such men as Flood, Plunket or Grattan. One of his associates in conspiracy described him as "weak and not fit to command a sergeant's guard, but very zealous." Reinhard, who considered Arthur O'Connor "a far abler man," accurately read the character of Lord Edward Fitzgerald as that of a young man "incapable of falsehood or perfidy, frank, energetic, and likely to be a useful and devoted instrument; but with no experience or extraordinary talent, and entirely unfit to be chief of a great party or leader in a difficult enterprise."

See Thomas Moore, *Life and Death of Lord Edward Fitzgerald* (2 vols., London, 1832), also a revised edition entitled *The Memoirs of Lord Edward Fitzgerald*, edited with supplementary particulars by Martin MacDermott (London, 1897); R. R. Madden, *The United Irishmen* (7 vols., Dublin, 1842–1846); C. H. Teeling, *Personal Narrative of the Irish Rebellion of 1798* (Belfast, 1832); W. J. Fitzpatrick, *The Sham Squire, The Rebellion of Ireland and the Informers of 1798* (Dublin, 1866), and *Secret Service under Pitt* (London, 1892); J. A. Froude, *The English in Ireland in the Eighteenth Century* (3 vols., London, 1872–1874); W. E. H. Lecky, *History of England in the Eighteenth Century*, vols. vii. and viii. (London, 1896); Thomas Reynolds the younger, *The Life of Thomas Reynolds* (London, 1839); *The Life and Letters of Lady Sarah Lennox*, edited by the countess of Ilchester and Lord Stavordale (London, 1901); Ida A. Taylor, *The Life of Lord Edward Fitzgerald* (London, 1903), which gives a prejudiced and distorted picture of Pamela. For particulars of Pamela, and especially as to the question of her parentage, see Gerald Campbell, *Edward and Pamela Fitzgerald* (London, 1904); *Memoirs of Madame de Genlis* (London, 1825); Georgette Ducrest, *Chroniques populaires* (Paris, 1855); Thomas Moore, *Memoirs of the Life of R. B. Sheridan* (London, 1825). (R. J. M.)

FITZGERALD, RAYMOND, or **REDMOND** (d. ca. 1182), surnamed Le Gros, was the son of William Fitzgerald and brother of Odo de Carew. He was sent by Strongbow to Ireland in 1170, and landed at Dundunolf, near Waterford, where he was besieged in his entrenchments by the combined Irish and Ostmen, whom he repulsed. He was Strongbow's second in command, and had the chief share in the capture of Waterford and in the successful assault on Dublin. He was sent to Aquitaine to hand over Strongbow's conquests to Henry II., but was back in Dublin in July 1171, when he led one of the sallies from the town. Strongbow offended him later by refusing him the marriage of his sister Basilea, widow of Robert de Quenci, con-

stable of Leinster. Raymond then retired to Wales, and Hervey de Mountmaurice became constable in his place. At the outbreak of a general rebellion against the earl in 1174 Raymond returned with his uncle Meiler Fitz Henry, after receiving a promise of marriage with Basilea. Reinstated as constable he secured a series of successes, and with the fall of Limerick in October 1175 order was restored. Mountmaurice meanwhile obtained Raymond's recall on the ground that his power threatened the royal authority, but the constable was delayed by a fresh outbreak at Limerick, the earl's troops refusing to march without him. On the death of Strongbow he was acting governor until the arrival of William Fitz Aldhelm, to whom he handed over the royal fortresses. He was deprived of his estates near Dublin and Wexford, but the Geraldines secured the recall of Fitz Aldhelm early in 1183, and regained their power and influence. In 1182 he relieved his uncle Robert Fitzstephen, who was besieged in Cork. The date of his death, sometimes stated to be 1182, is not known.

FITZGERALD, LORD THOMAS (10th earl of Kildare), (1513–1537), the eldest son of Gerald Fitzgerald, 9th earl of Kildare, was born in London in 1513. He spent much of his youth in England, but in 1534 when his father was for the third time summoned to England to answer for his maladministration as lord deputy of Ireland, Thomas, at the council held at Drogheda, in February was made vice-deputy. In June the Ormond faction spread a report in Ireland that the earl had been executed in the Tower, and that his son's life was to be attempted. Inflamed with rage at this apparent treachery, Thomas rode at the head of his retainers¹ into Dublin, and before the council for Ireland (the 11th of June 1534) formally renounced his allegiance to the king and proclaimed a rebellion. His enemies, including Archbishop John Allen (of Dublin), who had been set by Henry VIII. to watch Fitzgerald, took refuge in Dublin Castle. In attempting to escape to England, Allen was taken by the rebels, and on the 28th of July 1534, was murdered by Fitzgerald's servants in his presence, but whether actually by his orders is uncertain. In any case he sent to the pope for absolution, but was solemnly excommunicated by the Irish Church. Leaving part of his army (with the consent of the citizens) to besiege Dublin Castle, Fitzgerald himself went against Piers Butler, earl of Ossory, and succeeded at first in making a truce with him. But the citizens of Dublin now rose against him, Ossory invaded Kildare, and the approach of an English army forced Fitzgerald to raise the siege. Part of the English army landed on the 17th of October, the rest a week later, but taking advantage of the inactivity of the new lord deputy, Sir William Skeffington, Fitzgerald from his stronghold at Maynooth ravaged Kildare and Meath throughout the winter. He had now succeeded to the earldom of Kildare, his father having died in the Tower on the 13th of December 1534, but he does not seem to have been known by that title. In March Skeffington stormed the castle, the stronghold of the Geraldines, which was defended, and some said betrayed, by Christopher Parse, Fitzgerald's foster-brother. It fell on the 23rd of March 1535, and most of the garrison were put to the sword. This proved the final blow to the rebellion. The news of what is known as the "pardon of Maynooth" reached Fitzgerald as he was returning from levying fresh troops in Offaley; his men fell away from him, and he retreated to Thomond, intending to sail for Spain. Changing his mind he spent the next few months in raids against the English and their allies, but his party gradually deserting him, on the 18th of August 1535 he surrendered himself to Lord Leonard Grey (d. 1541). It seems likely that he made some conditions, but what they were is very uncertain. He was taken to England and placed in the Tower. In February 1536 his five uncles were also, some of them with great injustice, seized and brought to England. The six Geraldines were hanged at Tyburn on the 3rd of February 1537. Acts of attainder against them and Gerald the 9th earl were passed by both the

¹ Fitzgerald was known by the sobriquet of "Silken Thomas," either from the silken fringes on his helmet, or from his distinguished manners.

Irish and English parliaments; but the family estates were restored by Edward VI. to Gerald, 11th earl of Kildare (step-brother of Thomas), and the attainder was repealed by Queen Elizabeth. Lord Thomas Fitzgerald married Frances, youngest daughter of Sir Adrian Fortescue, but had no children.

BIBLIOGRAPHY.—Richard Stanihurst, *Chronicles of Ireland* (vol. ii. of *Holinshed's Chronicles*); Sir James Ware, *Rerum Hibernicarum annales* (Dublin, 1664); *The Earls of Kildare*, by C. W. Fitzgerald, duke of Leinster (3rd ed., 1858); Richard Bagwell, *Ireland under the Tudors* (3 vols., 1885, vol. i. passim); *Calendar State Papers, Hen. VIII., Irish*; G. E. C.'s *Peerage*; John Lodge, *Peerage of Ireland*, ed. M. Archdall (1789), vol. i.

FITZHERBERT, SIR ANTHONY (1470–1538), English jurist, was born at Norbury, Derbyshire. After studying at Oxford, he was called to the English bar, and in 1523 became justice of the Court of Common Pleas, the duties of which office he continued to discharge till within a short time of his death in 1538. As a judge he left behind him a high reputation for fairness and integrity, and his legal learning is sufficiently attested by his published works.

He is the author of *La Graunde Abridgement*, a digest of important legal cases written in Old French, first printed in 1514; *The Office and Authority of Justices of the Peace*, first printed in 1538 (last ed. 1794); the *New Natura Brevium* (1534, last ed. 1794), with a commentary ascribed to Sir Matthew Hale. To Fitzherbert are sometimes attributed the *Book of Husbandry* (1523), the first published work on agriculture in the English language, and the *Book of Surveying and Improvements* (1523) (see AGRICULTURE).

FITZHERBERT, THOMAS (1552–1640), English Jesuit, was the eldest son and heir of William Fitzherbert of Swynerton in Staffordshire, and grandson of Sir Anthony Fitzherbert, judge of the common pleas. He was educated at Oxford, where, at the age of twenty, he was imprisoned for recusancy. On his release he went to London, where he was a member of the association of young men founded in 1580 to assist the Jesuits Edmund Campion and Robert Parsons. In 1582 he withdrew to the continent, where he was active in the cause of Mary, queen of Scots. He married in this year Dorothy, daughter of Edward East of Bledlow in Buckinghamshire. After the death of his wife (1588) he went to Spain, where on the recommendation of the duke of Feria he received a pension from the king. He continued his intrigues against the English government, and in 1598 he was charged with complicity in a plot to poison Queen Elizabeth. After this he was for a short while in the service of the duke of Feria at Milan, then went to Rome, where he was ordained priest (1601–1602) and became agent for the English clergy. He was unpopular with them, however, owing to his subserviency to the Jesuits, and resigned the agency in 1607 owing to the remonstrances of the English arch-priest George Birkhead. In 1613 he joined the Society of Jesus, and was appointed superior of the English mission at Brussels in 1616, and in 1618 rector of the English college at Rome. He held this post to within a year of his death, which occurred at Rome on the 7th of August (O.S.) 1640.

Father Fitzherbert, who is described as "a person of excellent parts, a notable politician, and of graceful behaviour and generous spirit," wrote many controversial works, a list of which is given in the article on him by Mr Thompson Cooper in the *Dictionary of National Biography*, together with authorities for his life.

FITZ NEAL or (FITZ NIGEL), **RICHARD** (d. 1198), treasurer of Henry II. and Richard I. of England, and bishop of London, belonged to a great administrative family whose fortunes were closely linked with those of Henry I., Henry II. and Richard I. The founder of the family was Roger, bishop of Salisbury, the great minister of Henry I. Before the death of that sovereign (1135) the care of the treasury passed from Roger to his nephew, Nigel, bishop of Ely (d. 1169), who held that office until the whole family were disgraced by Stephen (1139). Becoming a partisan of the empress, Nigel reaped his reward at the accession of her son, Henry II., who made him at first chancellor and then treasurer. Nigel's son, Richard, who was born before his father's elevation to the episcopate (1133), succeeded to the office of treasurer in 1158, and held it continuously for forty years. His name appears in the lists of itinerant justices for 1179 and 1194, but these are the only occasions on which he

exercised that office. Before 1184 he became dean of Lincoln, and was in that year presented by the chapter of Lincoln among three select candidates for the vacant see. The king passed him over in favour of Hugh of Avalon, having resolved on this occasion to make a disinterested appointment. Richard I., however, rewarded the treasurer's services with the see of London (1189).

Richard Fitz Neal is best remembered as an author. He lacked the broad statesmanship of his father and great-uncle; he avoided any connexion with political parties; he is only once mentioned as taking part in a debate of the Great Council (1193), and then spoke, in his character as a bishop, to support a royal demand for a special aid. But his work *De necessariis observantiis Scaccarii dialogus*, commonly called the *Dialogus de Scaccario*, is of unique interest to the historian. It is an account, in two books, of the procedure followed by the exchequer in the author's time. Richard handles his subject with the more enthusiasm because, as he explains, the "course" of the exchequer was largely the creation of his own family. When read in connexion with the Pipe Rolls the *Dialogus* furnishes a most faithful and detailed picture of English fiscal arrangements under Henry II. The speakers in the dialogue are Richard himself and an anonymous pupil. The latter puts leading questions which Richard answers in elaborate fashion. The date of the conversation is given in the prologue as 1176–1177. This probably marks the date at which the book was begun; it was not completed before 1178 or 1179. Soon after the author's death we find it already recognized as the standard manual for exchequer officials. It was frequently transcribed and has been used by English antiquarians of every period. Hence it is the more necessary to insist that the historical statements which the treatise contains are sometimes demonstrably erroneous; the author appears to have relied excessively upon oral tradition. But, as the work is only known to us through transcripts, it is possible that some of the blunders which it now contains are due to the misdirected zeal of editors. Richard Fitz Neal also compiled in his earlier years a register or chronicle of contemporary affairs, arranged in three parallel columns. This was preserved in the exchequer at the time when he wrote the *Dialogus*, but has since disappeared. Stubbs' conjectural identification of this *Liber tricoloris* with the first part of the *Gesta Henrici* (formerly attributed to Benedictus Abbas) is now abandoned as untenable.

See Madox's edition in his *History of the Exchequer* (1769); and that of A. Hughes, C. G. Crump and C. Johnson (Oxford, 1902). F. Liebermann's *Einleitung in den Dialogus de Scaccario* (Göttingen, 1875) contains the fullest account of the author. (H. W. C. D.)

FITZ-OSBERN, ROGER (fl. 1070), succeeded to the earldom of Hereford and the English estate of William Fitz-Osbern in 1071. He did not keep on good terms with William the Conqueror, and in 1075, disregarding the king's prohibition, married his sister Emma to Ralph Guader, earl of Norfolk, at the famous bridal of Norwich. Immediately afterwards the two earls rebelled. But Roger, who was to bring his force from the west to join the earl of Norfolk, was held in check at the Severn by the Worcestershire fyrd which the English bishop Wulfstan brought into the field against him. On the collapse of his confederate's rising, Roger was tried before the Great Council, deprived of his lands and earldom, and sentenced to perpetual imprisonment; but he was released, with other political prisoners, at the death of William I. in 1087.

FITZ-OSBERN, WILLIAM, Earl of Hereford (d. 1071), was an intimate friend of William the Conqueror, and the principal agent in preparing for the invasion of England. He received the earldom of Hereford with the special duty of pushing into Wales. During William's absence in 1067, Fitz-Osbern was left as his deputy in central England, to guard it from the Welsh on one side, and the Danes on the other. He also acted as William's lieutenant during the rebellions of 1069. In 1070 William sent him to assist Queen Matilda in the government of Normandy. But Richilde, widow of Baldwin VI. of Flanders, having offered to marry him if he would protect her son Arnulf against Robert the Frisian, Fitz-Osbern accepted

the proposal and joined Richilde in Flanders. He was killed, fighting against Robert, at Cassel in 1071.

See Freeman, *Norman Conquest*, vols. iii. and iv.; Sir James Ramsay, *Foundations of England*, vol. ii.

FITZ OSBERT, WILLIAM (d. 1196), was a Londoner of good position who had served in the Third Crusade, and on his return took up the cause of the poorer citizens against the magnates who monopolized the government of London and assessed the taxes, as he alleged, with gross partiality. It is affirmed that he entered on this course of action through a quarrel with his elder brother who had refused him money. But this appears to be mere scandal; the chronicler Roger of Hoveden gives Fitz Osbert a high character, and he was implicitly trusted by the poorer citizens. He attempted to procure redress for them from the king; but the city magistrates persuaded the justiciar Hubert Walter that Fitz Osbert and his followers meditated plundering the houses of the rich. Troops were sent to seize the demagogue. He was smoked out of the sanctuary of St Mary le Bow, in which he had taken refuge, and summarily dragged to execution at Tyburn.

FITZ PETER, GEOFFREY (d. 1213), earl of Essex and chief justiciar of England, began his official career in the later years of Henry II., whom he served as a sheriff, a justice itinerant and a justice of the forest. During Richard's absence on Crusade he was one of the five justices of the king's court who stood next in authority to the regent, Longchamp. It was at this time (1190) that Fitz Peter succeeded to the earldom of Essex, in the right of his wife, who was descended from the famous Geoffrey de Mandeville. In attempting to assert his hereditary rights over Walden priory Fitz Peter came into conflict with Longchamp, and revenged himself by taking an active part in the baronial agitation through which the regent was expelled from his office. The king, however, forgave Fitz Peter for his share in these proceedings; and, though refusing to give him formal investiture of the Essex earldom, appointed him justiciar in succession to Hubert Walter (1198). In this capacity Fitz Peter continued his predecessor's policy of encouraging foreign trade and the development of the towns; many of the latter received, during his administration, charters of self-government. He was continued in his office by John, who found him a useful instrument and described him in an official letter as "indispensable to the king and kingdom." He proved himself an able instrument of extortion, and profited to no small extent by the spoliation of church lands in the period of the interdict. But he was too closely connected with the baronage to be altogether trusted by the king. The contemporary *Histoire des ducs* describes Fitz Peter as living in constant dread of disgrace and confiscation. In the last years of his life he endeavoured to act as a mediator between the king and the opposition. It was by his mouth that the king promised to the nation the laws of Henry I. (at the council of St Albans, August 4th, 1213). But Fitz Peter died a few weeks later (Oct. 2), and his great office passed to Peter des Roches, one of the unpopular foreign favourites. Fitz Peter was neither a far-sighted nor a disinterested statesman; but he was the ablest pupil of Hubert Walter, and maintained the traditions of the great bureaucracy which the first and second Henries had founded.

See the original authorities specified for the reigns of Richard I. and John. Also Miss K. Norgate's *Angevin England*, vol. ii. (1887), and John Lackland (1902); A. Ballard in *English Historical Review*, xiv. p. 93; H. W. C. Davis' *England under the Normans and Angevins* (H. W. C. D.) (1905).

FITZROY, ROBERT (1805-1865), English vice-admiral, distinguished as a hydrographer and meteorologist, was born at Ampton Hall, Suffolk, on the 5th of July 1805, being a grandson, on the father's side, of the third duke of Grafton, and on the mother's, of the first marquis of Londonderry. He entered the navy from the Royal Naval College, then a school for cadets, on the 19th of October 1819, and on the 7th of September 1824 was promoted to the rank of lieutenant. After serving in the "Thetis" frigate in the Mediterranean and on the coast of South America, under the command of Sir John Phillimore and Captain Bingham, he was in August 1828 appointed to the "Ganges,"

as flag-lieutenant to Rear-Admiral Sir Robert Otway, the commander-in-chief on the South American station; and on the death of Commander Stokes of the "Beagle," on the 13th of November 1828, was promoted to the vacant command. The "Beagle," a small brig of about 240 tons, was then, and had been for the two previous years, employed on the survey of the coasts of Patagonia and Tierra del Fuego, under the orders of Commander King in the "Adventure," and, together with the "Adventure," returned to England in the autumn of 1830. Fitzroy had brought home with him four Fuegians, one of whom died of smallpox a few weeks after arriving in England; to the others he endeavoured, with but slight success, to impart a rudimentary knowledge of religion and of some useful handicrafts; and, as he had pledged himself to restore them to their native country, he was making preparations in the summer of the following year to carry them back in a merchant ship bound to Valparaiso, when he received his reappointment to the "Beagle," to continue the survey of the same wild coasts. The "Beagle" sailed from Plymouth on the 27th of December 1831, carrying as a supernumerary Charles Darwin, the afterwards famous naturalist. After an absence of nearly five years, and having, in addition to the survey of the Straits of Magellan and a great part of the coast of South America, run a chronometric line round the world, thus fixing the longitude of many secondary meridians with sufficient exactness for all the purposes of ordinary navigation, the "Beagle" anchored at Falmouth on the 2nd of October 1836. In 1835 Fitzroy had been advanced to the rank of captain and was now for the next few years principally employed in reducing and discussing his numerous observations. In 1837 he was awarded the gold medal of the Royal Geographical Society; and in 1839 he published, in two thick 8vo volumes, the narrative of the voyage of the "Adventure" and "Beagle," 1826-1830, and of the "Beagle," 1831-1836, with a third volume by Darwin—a book familiarly known as a record of scientific travel. Of Fitzroy's work as a surveyor, carried on under circumstances of great difficulty, with scanty means, and with an outfit that was semi-officially denounced as "shabby," Sir Francis Beaufort, the Hydrographer to the Admiralty, wrote, in a report to the House of Commons, 10th of February 1848, that "from the equator to Cape Horn, and from thence round to the river Plata on the eastern side of America, all that is immediately wanted has been already achieved by the splendid survey of Captain Robert Fitzroy." This was written before steamships made the Straits of Magellan a high-road to the Pacific. The survey that was sufficient then became afterwards very far from sufficient.

In 1841 Fitzroy unsuccessfully contested the borough of Ipswich, and in the following year was returned to parliament as member for Durham. About the same time he accepted the post of conservator of the Mersey, and in his double capacity obtained leave to bring in a bill for improving the condition and efficiency of officers in the mercantile marine. This was not proceeded with at the time, but gave rise to the "voluntary certificate" instituted by the Board of Trade in 1845, and furnished some important clauses to the Mercantile Marine Act of 1850.

Early in 1843 Fitzroy was appointed governor and commander-in-chief of New Zealand, then recently established as a colony. He arrived in his government in December, whilst the excitement about the Wairau massacre was still fresh, and the questions relating to the purchase of land from the natives were in a very unsatisfactory state. The early settlers were greedy and unscrupulous; Fitzroy, on the other hand, had made no secret of his partiality for the aborigines. Between such discordant elements agreement was impossible; the settlers insulted the governor; the governor did not conciliate the settlers, who denounced his policy as adverse to their interests, as unjust and illegal; colonial feeling against him ran very high; petition after petition for his recall was sent home, and the government was compelled to yield to the pressure brought to bear on it. Fitzroy was relieved by Sir George Grey in November 1845.

In September 1848 he was appointed acting superintendent

of the dockyard at Woolwich, and in the following March to the command of the "Arrogant," one of the early screw frigates which had been fitted out under his supervision, and with which it was desired to carry out a series of experiments and trials. When these were finished he applied to be superseded, on account at once of his health and of his private affairs. In February 1850 he was accordingly placed on half-pay; nor did he ever serve again, although advanced in due course by seniority to the ranks of rear- and vice-admiral on the retired list (1857, 1863). In 1851 he was elected a fellow of the Royal Society, and in 1854, after serving for a few months as private secretary to his uncle, Lord Hardinge, then commander-in-chief of the army, he was appointed to the meteorological department of the Board of Trade, with, in the first instance, the peculiar title of "Meteorological Statist."

From the date of his joining the "Beagle" in 1828 he had paid very great attention to the different phenomena foreboding or accompanying change of weather, and his narratives of the voyages of the "Adventure" and "Beagle" are full of interesting and valuable details concerning these. Accordingly, when in 1854 Lord Wrottesley, the president of the Royal Society, was asked by the Board of Trade to recommend a chief for its newly forming meteorological department, he, almost without hesitation, nominated Fitzroy, whose name and career became from that time identified with the progress of practical meteorology. His *Weather Book*, published in 1863, embodies in broad outline his views, far in advance of those then generally held; and in spite of the rapid march of modern science, it is still worthy of careful attention and exact study. His storm warnings, in their origin, indeed, liable to a charge of empiricism, were gradually developed on a more scientific basis, and gave a high percentage of correct results. They were continued for eighteen months after his death by the assistants he had trained, and though stopped when the department was transferred to the management of a committee of the Royal Society, they were resumed a few months afterwards; and under the successive direction of Dr R. H. Scott and Dr W. N. Shaw, have been developed into what we now know them. But though it is perhaps by these storm warnings that Fitzroy's name has been most generally known, seafaring men owe him a deeper debt of gratitude, not only for his labours in reducing to a more practical form the somewhat complicated wind charts of Captain Maury, but also for his great exertions in connexion with the life-boat association. Into this work, in its many ramifications, he threw himself with the energy of an excitable temperament, already strained by his long and anxious service in the Straits of Magellan. His last years were fully and to an excessive degree occupied by it; his health, both of body and mind, threatened to give way; but he refused to take the rest that was prescribed. In a fit of mental aberration he put an end to his existence on the 30th of April 1865.

Besides his works already named mention may be made of *Remarks on New Zealand* (1846); *Sailing Directions for South America* (1848); his official reports to the Board of Trade (1857-1865); and occasional papers in the journal of the Royal Geographical Society and of the Royal United Service Institution. (J. K. L.)

FITZROY, a city of Bourke county, Victoria, Australia, 2 m. by rail N.E. of and suburban to Melbourne. Pop. (1901) 31,610. It is a prosperous manufacturing town, well served with tramways and containing many fine residences.

FITZ STEPHEN, ROBERT (fl. 1150), son of Nesta, a Welsh princess and former mistress of Henry I., by Stephen, constable of Cardigan, whom Robert succeeded in that office, took service with Dermot of Leinster when that king visited England (1167). In 1169 Robert led the vanguard of Dermot's Anglo-Welsh auxiliaries to Ireland, and captured Wexford, which he was then allowed to hold jointly with Maurice Fitz Gerald. Taken prisoner by the Irish in 1171, he was by them surrendered to Henry II., who appointed him lieutenant of the justiciar of Ireland, Hugh de Lacy. Robert rendered good service in the troubles of 1173, and was rewarded by receiving, jointly with Miles Cogan, a grant of Cork (1177). He had difficulty in main-

taining his position and was nearly overwhelmed by a rising of Desmond in 1182. The date of his death is uncertain.

FITZ STEPHEN, WILLIAM (d. c. 1190), biographer of Thomas Becket and royal justice, was a Londoner by origin. He entered Becket's service at some date between 1154 and 1162. The chancellor employed Fitz Stephen in legal work, made him sub-deacon of his chapel and treated him as a confidant. Fitz Stephen appeared with Becket at the council of Northampton (1164) when the disgrace of the archbishop was published to the world; but he did not follow Becket into exile. He joined Becket's household again in 1170, and was a spectator of the tragedy in Canterbury cathedral. To his pen we owe the most valuable among the extant biographies of his patron. Though he writes as a partisan he gives a precise account of the differences between Becket and the king. This biography contains a description of London which is our chief authority for the social life of the city in the 12th century. Despite his connexion with Becket, William subsequently obtained substantial preferment from the king. He was sheriff of Gloucestershire from 1171 to 1190, and a royal justice in the years 1176-1180 and 1189-1190.

See his "Vita S. Thomae" in J. C. Robertson's *Materials for the History of Thomas Becket*, vol. iii. (Rolls series, 1877). Sir T. D. Hardy, in his *Catalogue of Materials*, ii. 330 (Rolls series, 1865), discusses the manuscripts of this biography and its value. W. H. Hutton, *St Thomas of Canterbury*, pp. 272-274 (1889), gives an account of the author. (H. W. C. D.)

FITZ THEDMAR, ARNOLD (d. 1274), London chronicler and merchant, was born in London on the 9th of August 1201. Both his parents were of German extraction. The family of his mother migrated to England from Cologne in the reign of Henry II.; his father, Thedmar by name, was a citizen of Bremen who had been attracted to London by the privileges which the Plantagenets conferred upon the Teutonic Hanse. Arnold succeeded in time to his father's wealth and position. He held an honourable position among the Hanse traders, and became their "alderman." He was also, as he tells us himself, alderman of a London ward and an active partisan in municipal politics. In the Barons' War he took the royal side against the populace and the mayor Thomas Fitz Thomas. The popular party planned, in 1265, to try him for his life before the folk-moot, but he was saved by the news of the battle of Evesham which arrived on the very day appointed for the trial. Even after the king's triumph Arnold suffered from the malice of his enemies, who contrived that he should be unfairly assessed for the tallages imposed upon the city. He appealed for help to Henry III., and again to Edward I., with the result that his liability was diminished. In 1270 he was one of the four citizens to whose keeping the muniments of the city were entrusted. To this circumstance we probably owe the compilation of his chronicle. *Chronica Maiorum et Vicecomitum*, which begins at the year 1188 and is continued to 1274. From 1239 onwards this work is a mine of curious information. Though municipal in its outlook, it is valuable for the general history of the kingdom, owing to the important part which London played in the agitation against the misrule of Henry III. We have the king's word for the fact that Arnold was a consistent royalist; but this is apparent from the whole tenor of the chronicle. Arnold was by no means blind to the faults of Henry's government, but preferred an autocracy to the mob-rule which Simon de Montfort countenanced in London. Arnold died in 1274; the last fact recorded of him is that, in this year, he joined in a successful appeal to the king against the illegal grants which had been made by the mayor, Walter Hervey.

The *Chronica Maiorum et Vicecomitum*, with the other contents of Arnold's common-place book, were edited for the Camden Society by T. Stapleton (1846), under the title *Liber de Antiquis Legibus*. Our knowledge of Arnold's life comes from the *Chronica* and his own biographical notes. Extracts, with valuable notes, are edited in G. H. Pertz's *Mon. Germaniae historica, Scriptores*, vol. xxviii. See also J. M. Lappenberg's *Urkundliche Geschichte des Hansischen Stalhofes zu London* (Hamburg, 1851). (H. W. C. D.)

FITZWALTER, ROBERT (d. 1235), leader of the baronial opposition against King John of England, belonged to the

official aristocracy created by Henry I. and Henry II. He served John in the Norman wars, and was taken prisoner by Philip of France, and forced to pay a heavy ransom. He was implicated in the baronial conspiracy of 1212. According to his own statement the king had attempted to seduce his eldest daughter; but Robert's account of his grievances varied from time to time. The truth seems to be that he was irritated by the suspicion with which John regarded the new baronage. Fitzwalter escaped a trial by flying to France. He was outlawed, but returned under a special amnesty after John's reconciliation with the pope. He continued, however, to take the lead in the baronial agitation against the king, and upon the outbreak of hostilities was elected "marshal of the army of God and Holy Church" (1215). To his influence in London it was due that his party obtained the support of the city and used it as their base of operations. The famous clause of Magna Carta (§ 39) prohibiting sentences of exile, except as the result of a lawful trial, refers more particularly to his case. He was one of the twenty-five appointed to enforce the promises of Magna Carta; and his aggressive attitude was one of the causes which contributed to the recrudescence of civil war (1215). His incompetent leadership made it necessary for the rebels to invoke the help of France. He was one of the envoys who invited Louis to England, and was the first of the barons to do homage when the prince entered London. Though slighted by the French as a traitor to his natural lord, he served Louis with fidelity until captured at the battle of Lincoln (May 1217). Released on the conclusion of peace he joined the Damietta crusade of 1219, but returned at an early date to make his peace with the regency. The remainder of his career was uneventful; he died peacefully in 1235.

See the list of chronicles for the reign of John. The *Histoire des ducs de Normandie et des rois d'Angleterre* (ed. F. Michel, Paris, 1840) gives the fullest account of his quarrel with the king. Miss K. Norgate's *John Lackland* (1902), W. McKechnie's *Magna Carta* (1905), and Stubbs's *Constitutional History*, vol. i. ch. xii. (1897), should also be consulted.

FITZWILLIAM, SIR WILLIAM (1526-1599), lord deputy of Ireland, was the eldest son of Sir William Fitzwilliam (d. 1576) of Milton, Northamptonshire, where he was born, and grandson of another Sir William Fitzwilliam (d. 1534), alderman and sheriff of London, who was also treasurer and chamberlain to Cardinal Wolsey, and who purchased Milton in 1506. On his mother's side Fitzwilliam was related to John Russell, 1st earl of Bedford, a circumstance to which he owed his introduction to Edward VI. In 1559 he became vice-treasurer of Ireland and a member of the Irish House of Commons; and between this date and 1571 he was (during the absences of Thomas Radclyffe, earl of Sussex, and of his successor, Sir Henry Sidney) five times lord justice of Ireland. In 1571 Fitzwilliam himself was appointed lord deputy, but like Elizabeth's other servants he received little or no money, and his period of government was marked by continuous penury and its attendant evils, inefficiency, mutiny and general lawlessness. Moreover, the deputy quarrelled with the lord president of Connaught, Sir Edward Fitton (1527-1579), but he compelled the earl of Desmond to submit in 1574. He disliked the expedition of Walter Devereux, earl of Essex; he had a further quarrel with Fitton, and after a serious illness he was allowed to resign his office. Returning to England in 1575 he was governor of Fotheringhay Castle at the time of Mary Stuart's execution. In 1588 Fitzwilliam was again in Ireland as lord deputy, and although old and ill he displayed great activity in leading expeditions, and found time to quarrel with Sir Richard Bingham (1528-1599), the new president of Connaught. In 1594 he finally left Ireland, and five years later he died at Milton. From Fitzwilliam, whose wife was Anne, daughter of Sir William Sidney, were descended the barons and earls Fitzwilliam.

See R. Bagwell, *Ireland under the Tudors*, vol. ii. (1885).

FITZWILLIAM, WILLIAM WENTWORTH FITZWILLIAM, 2ND EARL (1748-1833), English statesman, was the son of the 1st earl (peerage of the United Kingdom), who died in 1756. The English family of Fitzwilliam claimed descent from a natural son of William the Conqueror, and among its earlier members

were a Sir William Fitzwilliam (1460-1534), sheriff of London, who in 1506 acquired the family seat of Milton Manor in Northamptonshire, and his grandson Sir William Fitzwilliam (see above). The latter's grandson was made an Irish baron in 1620; and in later generations the Irish titles of Viscount Milton and Earl Fitzwilliam (1716) and the English titles of Baron Milton (1742) and Viscount Milton and Earl Fitzwilliam (1746), were added. These were all in the English house of the Fitzwilliams of Milton Manor. They were distinct from the Irish Fitzwilliams of Meryon, who descended from a member of the English family who went to Ireland with Prince John at the end of the 12th century, and whose titles of Baron and Viscount Fitzwilliam died out with the 8th viscount in 1833; the best known of these was Richard, 7th viscount (1745-1816), who left the Fitzwilliam library and a fund for creating the Fitzwilliam Museum to Cambridge University.

The 2nd earl inherited not only the Fitzwilliam estates in Northamptonshire, but also, on the death of his uncle the marquess of Rockingham in 1782, the valuable Wentworth estates in Yorkshire, and thus became one of the wealthiest noblemen of the day. He had been at Eton with C. J. Fox, and became an active supporter of the Whig party; and in 1794, with the duke of Portland, Windham and other "old Whigs" he joined Pitt's cabinet, becoming president of the council. At the end of the year, however, he was sent to Ireland as viceroy. Fitzwilliam, however, had set his face against the jobbery of the Protestant leaders, and threw himself warmly into Grattan's scheme for admitting the Catholics to political power; and in March 1795 he was recalled, his action being disavowed by Pitt, the result of a series of misunderstandings which appeared to Fitzwilliam to give him just cause of complaint. The quarrel was, however, made up, and in 1798 Fitzwilliam was appointed lord-lieutenant of the West Riding of Yorkshire. He continued to take an active part in politics, and in 1806 was president of the council, but his Whig opinions kept him mainly in opposition. He died in February 1833, his son, Charles William Wentworth, the 3rd earl (1786-1857), and later earls, being notable figures in the politics and social life of the north of England.

FIUME (Slav. *Rjeka, Rieka* or *Reka*, Ger. *St Veit am Flaum*), a royal free town and port of Hungary; situated at the northern extremity of the Gulf of Quarnero, an inlet of the Adriatic, and on a small stream called the Rjeka, Recina or Fiumara, 70 m. by rail S.E. of Trieste. Pop. (1900) 38,955; including 17,354 Italians, 14,885 Slavs (Croats, Serbs and Slovenes), 2482 Hungarians and 1945 Germans. Geographically, Fiume belongs to Croatia; politically the town, with its territory of some 7 sq. m., became a part of Hungary in August 1870. The picturesque old town occupies an outlying ridge of the Croatian Karst; while the modern town, with its wharves, warehouses, electric light and electric trams, is crowded into the amphitheatre left between the hills and the shore. On the north-west there is a fine public garden. The most interesting buildings are the cathedral church of the Assumption, founded in 1377, and completed with a modern façade copied from that of the Pantheon in Rome; the church of St Veit, on the model of Santa Maria della Salute in Venice; and the Pilgrimage church, hung with offerings from shipwrecked sailors, and approached by a stairway of 400 steps. In the old town is a Roman triumphal arch, said to have been erected during the 3rd century A.D. in honour of the emperor Claudius II. Fiume also possesses a theatre and a music-hall; palaces for the governor and the Austrian emperor; a high court of justice for commerce and marine; a chamber of commerce; an asylum for lunatics and the aged poor; an industrial home for boys; and several large schools, including the marine academy (1856) and the school of seamanship (1903). Municipal affairs are principally managed by the Italians, who sympathize with the Hungarians against the Slavs.

Fiume is the only seaport of Hungary, with which country it was connected, in 1809, by the Maria Louisa road, through Karlstadt. It has two railways, opened in 1873; one a branch of the southern railway from Vienna to Trieste, the other of the

Hungarian state railway from Karlstadt. There are several harbours, including the *Porto Canale*, for coasting vessels; the *Porto Baross*, for timber; and the *Porto Grande*, sheltered by the *Maria Theresia* mole and breakwater, besides four lesser moles, and flanked by the quays, with their grain-elevators. The development of the *Porto Grande*, originally named the *Porto Nuovo*, was undertaken in 1847, and carried on at intervals as trade increased. In 1902, arrangements were made for the construction of a new mole and an enlargement of the quays and breakwater; these works to be completed within 5 years, at a cost of £420,000. The exports, worth £6,460,000 in 1902, chiefly consisted of grain, flour, sugar, timber and horses; the imports, worth £3,678,000 in the same year, of coal, wine, rice, fruit, jute and various minerals, chemicals and oils. A large share in the carrying trade belongs to the Cunard, Adria, Ungaro-Croat and Austrian Lloyd Steamship Companies, subsidized by the state. A steady stream of Croatian and Hungarian emigrants, officially numbered in 1902 at 7500, passes through Fiume. Altogether 11,550 vessels, of 1,963,000 tons, entered at Fiume in 1902; and 11,535, of 1,956,000, cleared. Foremost among the industrial establishments are Whitehead's torpedo factory, Messrs Smith & Meynie's paper-mill, the royal tobacco factory, a chemical factory, and several flour-mills, tanneries and rope manufactories. In 1902 the last shipbuilding yard was closed. The soil of the surrounding country is stony, but the climate is warm, and wine is extensively produced. The Gulf of Quarnero yields a plentiful supply of fish, and the tunny trade with Trieste and Venice is of considerable importance. Steamboats ply daily from Fiume to the Istrian health-resort of Abbazia, the Croatian port of Buccari, and the islands of Veglia and Cherso.

Fiume is supposed to occupy the site of the ancient Liburnian town *Tersatica*; later it received the name of *Vitopolis*, and eventually that of *Fanum Sancti Viti ad Flumen*, from which its present name is derived. It was destroyed by Charlemagne in 799, from which time it probably long remained under the dominion of the Franks. It was held in feudal tenure from the patriarch of Aquileia by the bishop of Pola, and afterwards, in 1139, by the counts of Duino, who retained it till the end of the 14th century. It next passed into the hands of the counts of Wallsee, by whom it was surrendered in 1471 to the emperor Frederick III., who incorporated it with the dominions of the house of Austria. From this date till 1776 Fiume was ruled by imperial governors. In 1723 it was declared a free port by Charles VI., in 1776 united to Croatia by the empress Maria Theresa, and in 1779 declared a *corpus separatum* of the Hungarian crown. In 1809 Fiume was occupied by the French; but it was retaken by the British in 1813, and restored to Austria in the following year. It was ceded to Hungary in 1822, but after the revolution of 1848-1849 was annexed to the crown lands of Croatia, under the government of which it remained till it came under Hungarian control in 1870.

FIVES, a ball-game played by two or four players in a court enclosed on three or four sides, the ball being struck with the hand, usually protected by a glove, whence the game is known in America as "handball." The origin of the game is probably the French *jeu de paume*, tennis played with the hand, the hand in that case being eventually superseded by the racquet. Fives and racquets are probably both descended from the *jeu de paume*, of which they are simplified forms. The name fives may be derived from *la longue paume*, in which five on a side played, or from the five fingers, or from the fact that five points had to be made by the winners (in modern times the game consists of fifteen points). Fives is played in Great Britain principally at the schools and universities, although its encouragement is included in the functions of the Tennis Racquets and Fives Association, founded in 1908. In America it is much affected for training purposes by professional athletes and boxers. There are two forms of fives—the Eton game and the Rugby game—which require separate notice, though the main features of the two games are the serving of the ball to the taker of the service, the necessity of hitting the ball before the second

bounce, and of hitting it above a line and within the limits of the court.

Eton Fives.—The peculiar features of the Eton court arose from the fact that in early times the game was played against the chapel-wall, so that buttresses formed side walls and the balustrade of the chapel-steps projected into the court, while a step divided the court latitudinally. These were reproduced in the regular courts, the buttress being known as the "pepper-box" and the space between it and the step as the "hole." The riser of the step is about 5 in. The floor of the court is paved; there is no back wall. On the front wall is a ledge, known as the "line," 4 ft. 6 in. from the floor, and a vertical line, painted, 3 ft. 8 in. from the right-hand wall. Four people usually play, two against two; one of each pair plays in the forward court, the other in the back court. The server stands on the left of the forward court, his partner in the right-hand corner of the back court; the taker of the service by the right wall of the forward court, his partner at the left-hand corner of the back court. The forward court is known as "on-wall," the other as "off-wall." The server must toss the ball gently against the front wall, above the line, so that it afterwards hits the right wall and falls on the "off-wall," but the server's object is not, as at tennis and racquets, to send a service that cannot be returned. At fives he must send a service that hand-out can take easily; indeed hand-out can refuse to take any service that he does not like, and if he fails to return the ball above the line no stroke is counted. After the service has been returned either of the opponents returns the ball if he can, and so on, each side and either member of it returning the ball above the line alternately till one side or the other hits it below the line or out of court. Only hand-in can score. If hand-in wins a stroke, his side scores a point; if he misses a stroke he loses his innings and his partner becomes server, unless he has already served in this round, in which case the opponents become hand-in. The game is fifteen points. If the score is "13 all," the out side may "set" the game to 5 or 3; i.e. the game becomes one of 5 or 3 points; at "14 all" it may be set to three. The game and its terminology being somewhat intricate, can best be learnt in the court. No apparatus is required except padded gloves and fives-balls, which are covered with white leather tightly stretched over a hard foundation of cork, strips of leather and twine. The Eton balls are 1½ in. in diameter and weigh about 1¼ oz. apiece.

Rugby Fives is much less complicated owing to the simpler form of the court. The rules as to service, taking the balls, &c., are the same as in Eton Fives. The balls are rather smaller. The courts are larger, measuring about 34 ft. by 19 ft. 6 in. and may be roofed or open. The side walls slope from 20 ft. to 12 ft. Some courts have a dwarf back wall, some have none. The back wall, when there is one, is 5 ft. 8 in. in height. In some courts the side walls are plain; in others, where there is no back wall, a projection about 3 in. deep is built at right angles to the two side walls; in others a buttress, similar to the *tambour* of the tennis-court, is built out from the left-hand wall about 10 ft. from the front wall, and continued to the end of the court. The line is generally a board fixed across the front wall, its upper edge 34 in. from the ground, but the height varies slightly.

Handball, of ancient popularity in Ireland and much played in the United States, is practically identical with fives, though there are minor differences. The usual American court is about 60 ft. long, 24½ ft. wide and 35 ft. high at the front, tapering to 33 ft. at the back wall. The front wall is of brick faced with marble, the sides of cement and the floor of white pine laid on beams 10 in. apart. These are the dimensions of the Brooklyn court of the former American champion, Phil Casey (d. 1904), which has been extensively copied. Twenty-one aces constitute a game and gloves are not usually worn. The American ball is a trifle larger and softer than the Irish, which is called a "red ace" when made of solid red rubber, and "black ace" when made of black rubber. Baggs of Tipperary, who was in his prime about 1855, was the most celebrated Irish handball player. In his day nearly every village tavern in Ireland had a court. Browning and Lawlor, who won the Irish championship in 1885,

were his most prominent successors. In America Phil Casey and Michael Egan are the best-known names.

See A. Tait's *Fives* in the All England Series; "Fives" in the *Encyclopædia of Sport*; and *Official Handball Guide* in Spalding's Athletic Library.

FIX, THÉODORE (1800-1846), French journalist and economist, was born at Soleure in Switzerland in 1800. His father was a French physician whose ancestors had been expatriated by the revocation of the edict of Nantes. At first a land surveyor, he in 1830 became connected with the *Bulletin universel des sciences*, to which he contributed most of the geographical articles. In 1833 he founded the *Revue mensuelle d'économie politique*, which he edited during the three years of its existence. He then became engaged in journalistic work, till his essay on *L'Association des douanes allemandes* won him a prize from the Académie des Sciences Morales et Politiques in 1840, and also procured him work on the report on the progress of sciences since the Revolution, which the Institute was preparing. A few months before his death he published *Observations sur les classes ouvrières*, in which he argued against all attempts to regulate artificially the rate of wages, and attributed the condition of the working classes to their own thriftlessness and intemperance. He died suddenly at Paris on the 31st of July 1846.

FIXTURES (Lat. *figere*, to fix), in law, chattels which have been so fixed or attached to land (as it is expressed in English law, "so annexed to the freehold"), as to become, in contemplation of law, a part of it. All systems of law make a marked distinction for certain purposes, between immovables and movables, between real and personal property, between land and all other things. In the case of fixtures the question arises under which set of rights they are to fall—under those of real or of personal property. The general rule of English law is that everything attached to the land goes with the land—*quicquid plantatur solo, solo cedit*. This, like many other rules of English law, is all in favour of the freeholder; but its hardship has been modified by a large number of exceptions formulated from time to time by the courts as occasion arose.

In order to constitute a fixture there must be some degree of annexation to the land, or to a building which forms part of it. Thus it has been held that a barn laid on blocks of timber, but not fixed to the ground itself, is not a fixture; and the onus of showing that articles not otherwise attached to the land than by their own weight have ceased to be chattels, rests with those who assert the fact. On the other hand, an article, even slightly affixed to the land, is to be considered part of it, unless the circumstances show that it was intended to remain a chattel. The question is one of fact in each case—depending mainly on the mode, degree and object of the annexation, and the possibility of the removal of the article without injury to itself or the freehold. In certain cases the courts have recognized a constructive annexation, when the articles, though not fixed to the soil, pass with the freehold as if they were, e.g. the keys of a house, the stones of a dry wall, and the detached or duplicate portions of machines.

Questions as to the property in fixtures principally arise—(1) between landlord and tenant, (2) between heir and executor, (3) between executor and remainder-man or reversioner, (4) between seller and buyer.

1. At common law, if the tenant has affixed anything to the freehold during his occupation, he cannot remove it without the permission of his landlord. But an exception was established in favour of *trade fixtures*. In a case before Lord Holt it was held that a soap-boiler might, *during his term*, remove the vats he had set up for trade purposes, and that not by virtue of any special custom, but "by the common law in favour of trade, and to encourage industry," and it may be stated as a general rule that things which a tenant has fixed to the freehold for the purpose of trade or manufacture may be taken away by him, whenever the removal is not contrary to any prevailing practice, or the particular terms of the contract of tenancy, and can be effected without causing material injury to the estate or destroying the essential character of the articles themselves (*Lambourn v. McLellan*, 1903, 2 Ch. 269). Agricultural tenants are not entitled, at common law, to remove trade fixtures. But the Landlord and Tenant Act 1851 granted such a right of removal in the case of buildings or machinery erected by a

tenant at his own expense, and with his landlord's consent in writing, provided that the freehold was not injured or that any injury was made good, and that before removal a month's written notice was given to the landlord, who had an option of purchase. Under the Agricultural Holdings Act 1883 the tenant might, under similar conditions, remove fixtures, although the landlord had not consented to their erection. The Agricultural Holdings Act 1900 extended this provision to fixtures or buildings acquired, although not annexed or erected, by the tenant. Similar rights were created by the Allotments Compensation Act 1887, and by the Market Gardeners' Compensation Act 1895. All these provisions were re-enacted by the Agricultural Holdings Act 1908.

Again, *ornamental fixtures*, set up by the tenant for ornament and convenience, such as hangings and looking-glasses, tapestry, iron-backs to chimneys, wainscot fixed by screws, marble chimney-pieces, are held to belong to the tenant, and to be removable without the landlord's consent. Here again the extent of the privilege has been a matter of some uncertainty.

In all these cases the fixtures must be removed during the term. If the tenant gives up possession of the premises without removing the fixtures, it will be presumed, it appears, that he has made a gift of them to the landlord, and that presumption probably could not be rebutted by positive evidence of a contrary intention. His right to the fixtures is not, however, destroyed by the mere expiry of the term, if he still remains in possession; but if he has once left the premises he cannot come back and claim his fixtures. In one case where the fixtures had actually been severed from the freehold after the end of the term, it was held that the tenant had no right to recover them.

2. As between heir and executor or administrator. The question of fixtures arises between these parties on the death of a person owning land. The executor has no right to remove trade fixtures, set up for the benefit of the inheritance. As regards ornamental objects, the rule *quicquid plantatur solo, solo cedit* was in early times somewhat relaxed in favour of the executor. As far back as 1701, it was held that hangings fixed to a wall for ornament passed to the executor; and, although the effect of this relaxation was subsequently cut down, it is supported by the decisions of the courts affirming the executor's right to valuable tapestries affixed by a tenant for life to the walls of a house for ornament and their better enjoyment as chattels (*Leigh v. Taylor*, 1902, App. Cas. 157); and the same has been held as to statues and bronze groups set on pedestals in the grounds of a mansion house.

3. When a tenant for life of land dies, the question of fixtures arises between his representatives and the persons next entitled to the estate (the remainder-man or reversioner). The remainder-man is not so great a favourite of the law as the heir, and the right to fixtures is construed more favourably for executors than in the preceding cases between heir and executor. Whatever are executor's fixtures against the heir would therefore be executor's fixtures against the remainder-man. And the result of the cases seems to be that, as against the remainder, the executor of the tenant for life would be certainly entitled to trade fixtures. Agricultural fixtures are not removable by the executor of a tenant for life.

4. As between seller and buyer, a purchase of the lands includes a purchase of all the fixtures. But here the intention of the parties is of great importance. Similar questions may arise in other cases, e.g. as between mortgagor and mortgagee. When land is mortgaged the fixtures pass with it, unless a contrary intention is expressed in the conveyance; and this even where the chattels affixed are the subject of a hire purchase agreement (*Reynolds v. Ashby*, 1903, 1 K.B. 87). Again, in reference to bills of sale the question arises. Bills of sale are dispositions of personal property similar to mortgages, the possession remaining with the person selling them. To make them valid they must be registered, and so the question has arisen whether deeds conveying fixtures ought not to have been registered as bills of sale. Unless it was the intention of the parties to make the fixtures a distinct security, it seems that a deed of mortgage embracing them does not require to be registered as a bill of sale. The question of what is or is not a fixture must also often be considered in questions of rating or assessment.

The law of Scotland as to fixtures is the same as that of England. The Agricultural Holdings (Scotland) Acts 1883 (ss. 35, 42) and 1900 (as to market gardens) give a similar statutory right of removal. The law of Ireland has been the subject of the special legislation sketched in the article **LANDLORD AND TENANT**. The French Code Civil recognizes the right of the usufructuary to remove articles attached by him to the subject of his estate on the expiry of his term, on making good the place from which they were taken (Art. 599); and there are similar provisions in the Civil Codes of Italy (Art. 495), Spain (Arts. 487, 489), Portugal (Art. 2217) and Germany (Arts. 1037, 1049).

The law of the United States as to fixtures is substantially identical with English common law. Constructive, as well as actual, annexation is recognized. The same relaxations (from the common law rule *quicquid plantatur solo, solo cedit*) as regards trade fixtures, and ornamental fixtures, such as tapestry, have been recognized.

In Mauritius the provisions of the Code Civil are in force without modification. In Quebec (Civil Code, Arts. 374 et seq.) and St Lucia (Civil Code, Arts. 368 et seq.) they have been re-enacted in

substance. Some of the British colonies have conferred a statutory right to remove fixtures on tenants (cf. Tasmania, Landlord and Tenant Act 1874). In certain of the colonies acquired by cession or settlement (e.g. New Zealand) the English Landlord and Tenant Act 1851 is in force.

AUTHORITIES.—English law: Amos and Ferard, *Law of Fixtures* (3rd ed., London, 1883); Brown, *Law of Fixtures* (3rd ed., London, 1875); Ryde, on *Rating* (2nd ed., London, 1905). Scots Law: Hunter, *Landlord and Tenant*; Erskine's *Principles* (20th ed., Edin., 1903). American Law: Bronson, *Law of Fixtures* (St Paul, 1904); Reeves, *Real Property* (Boston, 1904); *Ruling Cases* (London and Boston, 1894-1901), Tit. "Fixtures" (American Notes).
(A. W. R.)

FIZEAU, ARMAND HIPPOLYTE LOUIS (1819-1896), French physicist, was born at Paris on the 23rd of September 1819. His earliest work was concerned with improvements in photographic processes; and then, in association with J. B. L. Foucault, he engaged in a series of investigations on the interference of light and heat. In 1849 he published the first results obtained by his method for determining the speed of propagation of light (see LIGHT), and in 1850 with E. Gounelle measured the velocity of electricity. In 1853 he described the employment of the condenser as a means for increasing the efficiency of the induction-coil. Subsequently he studied the expansion of solids by heat, and applied the phenomena of interference of light to the measurement of the dilatations of crystals. He died at Venteuil on the 18th of September 1896. He became a member of the French Academy in 1860 and of the Bureau des Longitudes in 1878.

FJORD, or **FIORD**, the anglicized Norwegian word for a long narrow arm of the sea running far inland, with more or less precipitous cliffs on each side. These "sea-lochs," as they are sometimes called, present many peculiar features. They differ entirely from an estuary in the fact that they are bounded seawards by a rocky sill, covered by shallow water, and they deepen inland for some distance before the bottom again curves up to the surface. They are thus true rock basins drowned in sea-water. It is pointed out by Dr H. R. Mill that Loch Morar on the west coast of Scotland, a fresh-water basin 178 fathoms deep, with its surface 30 ft. above sea-level, which is connected with the sea by a short river, is exactly similar in configuration to Loch Etive, 80 fathoms deep, filled with sea-water which pours over the seaward sill in a waterfall with the retreating tide; that Loch Nevis with a depth of 70 fathoms has its sill 8 fathoms below the surface, while the gigantic Sogne Fjord in Norway, more than 100 m. in length, is a rock basin with a maximum depth of 700 fathoms. Any inland rock basin such as Loch Morar would become a fjord if the seaward portion sank below sea-level. The origin of these rock basins has not yet been satisfactorily determined. Recent work upon somewhat similar basins in the high Alps has suggested local weathering of surface rock in fracture belts or faulted areas, or dikes, where material is easily eroded, thus producing a trough bounded by high walls in which a lake forms under favourable conditions. But investigations in such regions as the Rocky Mountains and the Yosemite Valley, where there is frequently a "reversed grade" similar to that near the seaward end of rock basins and fjords, seem to show, in some cases at least, that such a formation may be due to the "gouging" effect of a glacier coming down the valley which it constantly deepens where the ice pressure and the supply of eroding material are greatest. There may be several causes, but the results are the same in all these drowned valleys. The mass of sea-water in the depth of the basin is either unaffected by the seasonal changes in surface temperature, which in Norway penetrate no deeper than 200 fathoms, or else, as in Loch Goil, the fresher film of surface water responds quickly to seasonal changes, while the heat of advancing summer penetrates so slowly to the depth of the basin that it takes six months to reach the bottom, arriving there in winter. It has been found that where the fresher surface water has been frozen over, the temperature may be as much as 45° F. at a few fathoms from the surface. When the surface is warmest, on the other hand, the depths are coldest.

FLACCUS, a cognomen in the plebeian gens Fulvia, one of the most illustrious in ancient Rome. Cicero and Pliny state that

the family came from Tusculum, where some were still living in the middle of the 1st century B.C. Of the Fulvii Flacci the most important were the following:

QUINTUS FULVIUS FLACCUS, son of the first of the family, Marcus, who was consul with Appius Claudius Caudex in 264. He especially distinguished himself during the second Punic War. He was consul four times (237, 224, 212, 209), censor (231) pontifex maximus (216), praetor urbanus (215). During his first consulships he did good service against the Ligurians, Gauls and Insurbians. In 212 he defeated Hanno near Beneventum, and with his colleague Appius Claudius Pulcher began the siege of Capua. The capture of this place was considered so important that their imperium was prolonged, but on condition that they should not leave Capua until it had been taken. Hannibal's unexpected diversion against Rome interfered with the operations for the moment, but his equally unexpected retirement enabled Flaccus, who had been summoned to Rome to protect the city, to return, and bring the siege to a successful conclusion. He punished the inhabitants with great severity, alleging in excuse that they had shown themselves bitterly hostile to Rome. He was nominated dictator to hold the consular elections at which he was himself elected (209). He was appointed to the command of the army in Lucania and Bruttium, where he crushed all further attempts at rebellion. Nothing further is known of him. The chief authority for his life is the part of Livy dealing with the period (see PUNIC WARS).

His brother **GNAEUS** was convicted of gross cowardice against Hannibal near Herdoniae in 210, and went into voluntary exile at Tarquinii. His son, **QUINTUS**, waged war with signal success against the Celtiberians in 182-181, and the Ligurians in 179. Having vowed to build a temple to Fortuna Equestris, he dismantled the temple of Juno Lacinia in Bruttium of its marble slabs. This theft became known and he was compelled to restore them, though they were never put back in their places. Subsequently he lost his reason and hanged himself.

MARCUS FULVIUS FLACCUS, grandnephew of the first Quintus, lived in the times of the Gracchi, of whom he was a strong supporter. After the death of Tiberius Gracchus (133 B.C.) he was appointed in his place one of the commission of three for the distribution of the land. He was suspected of having had a hand in the sudden death of the younger Scipio (129), but there was no direct evidence against him. When consul in 125, he proposed to confer the Roman citizenship on all the allies, and to allow even those who had not acquired it the right of appeal to the popular assembly against penal judgments. This proposal, though for the time successfully opposed by the senate, eventually led to the Social War. The attack made upon the Massilians (who were allies of Rome) by the Salluvii (Salyes) afforded a convenient excuse for sending Flaccus out of Rome. After his return in triumph, he was again sent away (122), this time with Gaius Gracchus to Carthage to found a colony, but did not remain absent long. In 121 the disputes between the optimates and the party of Gracchus culminated in open hostilities, during which Flaccus was killed, together with Gracchus and a number of his supporters. It is generally agreed that Flaccus was perfectly honest in his support of the Gracchan reforms, but his hot-headedness did more harm than good to the cause. Cicero (*Brutus*, 28) speaks of him as an orator of moderate powers, but a diligent student.

See Livy, *Epit.* 59-61; Val. Max. ix. 5. 1; Vell. Pat. ii. 6; Appian, *Bell. Civ.* i. 18, 21, 24-26; Plutarch, *C. Gracchus*, 10. 13; also A. H. J. Greenidge, *Hist. of Rome* (1904), and authorities quoted under GRACCHUS.

FLACH, GEOFROI JACQUES (1846-), French jurist and historian, was born at Strassburg, Alsace, on the 16th of February 1846, of a family known at least as early as the 16th century, when Sigismond Flach was the first professor of law at Strassburg University. G. J. Flach studied classics and law at Strassburg, and in 1869 took his degree of doctor of law. In his theses as well as in his early writings—such as *De la subrogation réelle*, *La Bonorum possessio*, and *Sur la durée des effets de la minorité* (1870)—he endeavoured to explain the problems of laws by

means of history, an idea which was new to France at that time. The Franco-German War engaged Flach's activities in other directions, and he spent two years (described in his *Strasbourg après le bombardement*, 1873) at work on the rebuilding of the library and the museum, which had been destroyed by Prussian shells. When the time came for him to choose between Germany and France, he settled definitely in Paris, where he completed his scientific training at the École des Chartes and the École des Hautes Études. Having acted for some time as secretary to Jules Sénard, ex-president of the Constituent Assembly, he published an original paper on artistic copyright, but as soon as possible resumed the history of law. In 1879 he became assistant to the jurist Edouard Laboulaye at the Collège de France, and succeeded him in 1884 in the chair of comparative legislation. Since 1877 he had been professor of comparative law at the free school of the political sciences. To qualify himself for these two positions he had to study the most diverse civilizations, including those of the East and Far East (e.g. Hungary, Russia and Japan) and even the antiquities of Babylonia and other Asiatic countries. Some of his lectures have been published, particularly those concerning Ireland: *Histoire du régime agraire de l'Irlande* (1883); *Considérations sur l'histoire politique de l'Irlande* (1885); and *Jonathan Swift, son action politique en Irlande* (1886).

His chief efforts, however, were concentrated on the history of ancient French law. A celebrated lawsuit in Alsace, pleaded by his friend and compatriot Ignace Chauffour, aroused his interest by reviving the question of the origin of the feudal laws, and gradually led him to study the formation of those laws and the early growth of the feudal system. His great work, *Les Origines de l'ancienne France*, was produced slowly. In the first volume, *Le Régime seigneurial* (1886), he depicts the triumph of individualism and anarchy, showing how, after Charlemagne's great but sterile efforts to restore the Roman principle of sovereignty, the great landowners gradually monopolized the various functions in the state; how society modelled on antiquity disappeared; and how the only living organisms were vassalage and clientship. The second volume, *Les Origines communales, la féodalité et la chevalerie* (1893), deals with the reconstruction of society on new bases which took place in the 10th and 11th centuries. It explains how the Gallo-Roman *villa* gave place to the village, with its fortified castle, the residence of the lord; how new towns were formed by the side of old, some of which disappeared; how the townspeople united in corporations; and how the communal bond proved to be a powerful instrument of cohesion. At the same time it traces the birth of feudalism from the germs of the Gallo-Roman personal *comitatus*; and shows how the bond that united the different parties was the contract of the fief; and how, after a slow growth of three centuries, feudalism was definitely organized in the 12th century. In 1904 appeared the third volume, *La Renaissance de l'état*, in which the author describes the efforts of the Capetian kings to reconstruct the power of the Frankish kings over the whole of Gaul; and goes on to show how the clergy, the heirs of the imperial tradition, encouraged this ambition; how the great lords of the kingdom (the "princes," as Flach calls them), whether as allies or foes, pursued the same end; and how, before the close of the 12th century, the Capetian kings were in possession of the organs and the means of action which were to render them so powerful and bring about the early downfall of feudalism.

In these three volumes, which appeared at long intervals, the author's theories are not always in complete harmony, nor are they always presented in a very luminous or coherent manner, but they are marked by originality and vigour. Flach gave them a solid basis by the wide range of his researches, utilizing charters and cartularies (published and unpublished), chronicles, lives of saints, and even those dangerous guides, the *chansons de geste*. He owed little to the historians of feudalism who knew what feudalism was, but not how it came about. He pursued the same method in his *L'Origine de l'habitation et des lieux habités en France* (1899), in which he discusses some of the theories circulated by A. Meitzen in Germany and by Arbois de Jubain-

ville in France. Following in the footsteps of the jurist F. C. von Savigny, Flach studied the teaching of law in the middle ages and the Renaissance, and produced *Cujas, les glossateurs et les Bartolistes* (1883), and *Études critiques sur l'histoire du droit romain au moyen âge, avec textes inédits* (1890).

FLACIUS (Ger. *Flach*; Slav. *Vlakich*), **MATTHIAS** (1520–1575), surnamed **ILLYRICUS**, Lutheran reformer, was born at Albona, in Illyria, on the 3rd of March 1520. Losing his father in childhood, he was in early years self-educated, and made himself able to profit by the instructions of the humanist, Baptista Egnatius in Venice. At the age of seventeen he decided to join a monastic order, with a view to sacred learning. His intention was diverted by his uncle, Baldo Lupetino, provincial of the Franciscans, in sympathy with the Reformation, who induced him to enter on a university career, from 1539, at Basel, Tübingen and Wittenberg. Here he was welcomed (1541) by Melanchthon, being well introduced from Tübingen, and here he came under the decisive influence of Luther. In 1544 he was appointed professor of Hebrew at Wittenberg. He married in the autumn of 1545, Luther taking part in the festivities. He took his master's degree on the 24th of February 1546, ranking first among the graduates. Soon he was prominent in the theological discussions of the time, opposing strenuously the "Augsburg Interim," and the compromise of Melanchthon known as the "Leipzig Interim" (see **ADIAPHORISTS**). Melanchthon wrote of him with venom as a renegade ("alumnus in sinu serpentem"), and Wittenberg became too hot for him. He removed to Magdeburg (Nov. 9, 1551), where his feud with Melanchthon was patched up. On the 17th of May 1557 he was appointed professor of New Testament theology at Jena; but was soon involved in controversy with Strigel, his colleague, on the synergistic question (relating to the function of the will in conversion). Affirming the natural inability of man, he unwittingly fell into expressions consonant with the Manichean view of sin, as not an accident of human nature, but involved in its substance, since the Fall. Resisting ecclesiastical censure, he left Jena (Feb. 1562) to found an academy at Regensburg. The project was not successful, and in October 1566 he accepted a call from the Lutheran community at Antwerp. Thence he was driven (Feb. 1567) by the exigencies of war, and betook himself to Frankfort, where the authorities set their faces against him. He proceeded to Strassburg, was well received by the superintendent Marbach, and hoped he had found an asylum. But here also his religious views stood in his way; the authorities eventually ordering him to leave the city by Mayday 1573. Again betaking himself to Frankfort, the prioress, Catharina von Meerfeld, of the convent of White Ladies, harboured him and his family in despite of the authorities. He fell ill at the end of 1574; the city council ordered him to leave by Mayday 1575; but death released him on the 11th of March 1575. His first wife, by whom he had twelve children, died in 1564; in the same year he remarried and had further issue. His son Matthias was professor of philosophy and medicine at Rostock. Of a life so tossed about the literary fruit was indeed remarkable. His polemics we may pass over; he stands at the fountain-head of the scientific study of church history, and—if we except, a great exception, the work of Laurentius Valla—of hermeneutics also. No doubt his impelling motive was to prove popery to be built on bad history and bad exegesis. Whether that be so or not, the extirpation of bad history and bad exegesis is now felt to be of equal interest to all religionists. Hence the permanent and continuous value of the principles embodied in Flach's *Catalogus testium veritatis* (1556; revised edition by J. C. Dietericus, 1672) and his *Clavis scripturae sacrae* (1567), followed by his *Glossa compendiarie in N. Testamentum* (1570). His characteristic formula, "historia est fundamentum doctrinae," is better understood now than in his own day.

See J. B. Ritter, *Flacius's Leben u. Tod* (1725); M. Twisten, *M. Flacius Illyricus* (1844); W. Preger, *M. Flacius Illyricus u. seine Zeit* (1859–1861); G. Kawerau, in *Herzog-Hauck's Realencyklopädie* (1899). (A. Go.)*

FLACOURT, ÉTIENNE DE (1607-1660), French governor of Madagascar, was born at Orleans in 1607. He was named governor of Madagascar by the French East India Company in 1648. Flacourt restored order among the French soldiers, who had mutinied, but in his dealings with the natives he was less successful, and their intrigues and attacks kept him in continual harassment during all his term of office. In 1655 he returned to France. Not long after he was appointed director general of the company; but having again returned to Madagascar, he was drowned on his voyage home on the 10th of June 1660. He is the author of a *Histoire de la grande isle Madagascar* (1st edition 1658, 2nd edition 1661).

See A. Malotet, *Ét. de Flacourt, ou les origines de la colonisation française à Madagascar (1648-1661)*, (Paris, 1898).

FLAG (or "FLAGGE," a common Teutonic word in this sense, but apparently first recorded in English), a piece of bunting or similar material, admitting of various shapes and colours, and waved in the wind from a staff or cord for use in display as a standard, ensign or signal. The word may simply be derived onomatopoeically, or transferred from the botanical "flag"; or an original meaning of "a piece of cloth" may be connected with the 12th-century English "flage," meaning a baby's garment; the verb "to flag," *i.e.* droop, may have originated in the idea of a pendulous piece of bunting, or may be connected with the O. Fr. *flaguir*, to become flaccid. It is probable that almost as soon as men began to collect together for common purposes some kind of conspicuous object was used, as the symbol of the common sentiment, for the rallying point of the common force. In military expeditions, where any degree of organization and discipline prevailed, objects of such a kind would be necessary to mark out the lines and stations of encampment, and to keep in order the different bands when marching or in battle. In addition, it cannot be doubted that flags or their equivalents have often served, by reminding men of past resolves, past deeds and past heroes, to arouse to enthusiasm those sentiments of *esprit de corps*, of family pride and honour, of personal devotion, patriotism or religion, upon which, as well as upon good leadership, discipline and numerical force, success in warfare depends.

History.—Among the remains of the people which has left the earliest traces of civilization, the records of the forms of objects used as ensigns are frequently to be found. From their carvings and paintings, supplemented by ancient writers, it appears that several companies of the Egyptian army had their own particular standards. These were formed of such objects as, there is reason to believe, were associated in the minds of the men with feelings of awe and devotion. Sacred animals, boats, emblems or figures, a tablet bearing a king's name, fan and feather-shaped symbols, were raised on the end of a staff as standards, and the office of bearing them was looked upon as one of peculiar privilege and honour (fig. 1). Somewhat similar seem to have been the customs of the Assyrians and Jews. Among the sculptures unearthed by Layard and others at Nineveh, only two different designs have been noticed for standards: one is of a figure drawing a bow and standing on a running bull, the other of two bulls running in opposite directions (fig. 2). These may resemble the emblems of war and peace which were attached to the yoke of Darius's chariot. They are borne upon and attached to chariots; and this method of bearing such objects was the custom also of the Persians, and prevailed during the middle ages. That the custom survived to a comparatively modern period is proved from the fact that the "Guns," which are the "standards" of the artillery, have from time immemorial been entitled to all the parade honours prescribed by the usages of war for the flag, that is, the symbol of authority. In days comparatively recent there was a "flag gun," usually the heaviest piece, which emblemized authority and served also as the "gun of direction" in the few concerted movements then attempted. No representations of Egyptian or Assyrian naval standards have been found, but the sails of ships were embroidered and ornamented with devices, another custom which survived into the middle ages.

In both Egyptian and Assyrian examples, the staff bearing the

emblem is frequently ornamented immediately below with flag-like streamers. Rabbinical writers have assigned the different devices of the different Jewish tribes, but the authenticity of their testimony is extremely doubtful. Banners, standards and ensigns are frequently mentioned in the Bible. "Every man of the children of Israel shall pitch by his standard,

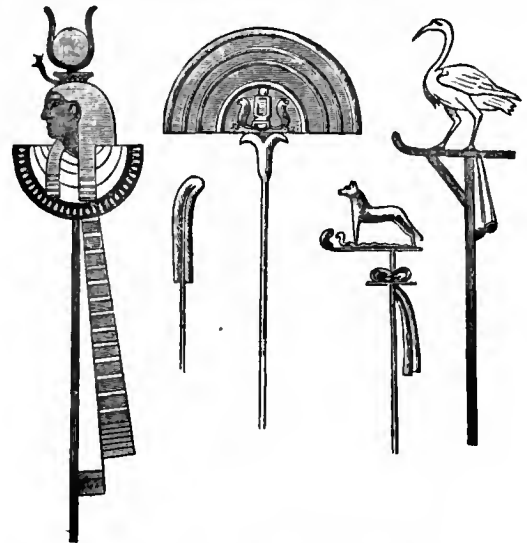

FIG. 1.—Egyptian Standards.

with the ensign of their father's house" (Num. ii. 2). "Who is she that looketh forth as the morning, fair as the moon, clear as the sun, terrible as an army with banners?" (Cant. vi. 10. See also Num. ii. 10, x. 14; Ps. xx. 5, lx. 4; Cant. ii. 4; Is. v. 26, x. 18, lix. 19; Jer. iv. 21).

The Persians bore an eagle fixed to the end of a lance, and the sun, as their divinity, was also represented upon their standards, which appear to have been formed of some kind of textile, and were guarded with the greatest jealousy by the bravest men of



FIG. 2.—Assyrian Standards.

the army. The Carian soldier who slew Cyrus, the brother of Artaxerxes, was allowed the honour of carrying a golden cock at the head of the army, it being the custom of the Carians to wear that bird as a crest on their helmets. The North American Indians carried poles fledge with feathers from the wings of eagles, and similar customs seem to have prevailed among other semi-savage peoples.

The Greeks bore a piece of armour upon a spear in early times; afterwards the several cities bore sacred emblems or

letters chosen for their particular associations—the Athenians the olive and the owl, the Corinthians a pegasus, the Thebans a sphinx, in memory of Oedipus, the Messenians their initial M, and the Lacedaemonians Λ. A purple dress was placed on the end of a spear as the signal to advance. The Dacians carried a standard representing a contorted serpent, while the dragon was the military sign of many peoples—of the Chinese, Dacians and Parthians among others—and was probably first used by the Romans as the ensign of barbarian auxiliaries (see fig. 3).



FIG. 3.—Roman Standards.

The question of the *signa militaria* of the Romans is a wide and very important one, having direct bearing on the history of heraldry, and on the origin of national, family and personal devices. With them the custom was reduced to system. "Each century, or at least each maniple," says Meyrick, "had its proper standard and standard-bearer." In the early days of the republic a handful of hay was borne on a pole, whence probably came the name *manipulus* (Lat. *manus*, a hand). The forms of standards in later times were very various; sometimes a cross piece of wood was placed at the end of a spear and surmounted by the figure of a hand in silver, below round or oval discs, with figures of Mars or Minerva, or in later times portraits of emperors or eminent generals (fig. 3). Figures of animals, as the wolf, horse, bear and others, were borne, and it was not till a later period that the eagle became the special standard of the legion. According to Pliny, it was Gaius Marius who, in his second consulship, ordained that the Roman legions should only have the eagle for their standard; "for before that time the eagle marched foremost with four others—wolves, minotaurs, horses and bears—each one in its proper order. Not many years passed before the eagle alone began to be advanced in battle, and the rest were left behind in the camp. But Marius rejected them altogether, and since this it is observed that scarcely is there a camp of a legion wintered at any time without having a pair of eagles."

The *vexillum*, which was the cavalry flag, is described by Livy as a square piece of cloth fastened to a piece of wood fixed crosswise to the end of a spear, somewhat resembling the medieval *gonfalon*. Examples of these vexilla are to be seen on various Roman coins and medals, on the sculptured columns of Trajan and Antoninus, and on the arch of Titus. The *labarum*, which was the imperial standard of later emperors, resembled in shape and fixing the *vexillum*. It was of purple silk richly embroidered with gold, and sometimes was not suspended as the *vexillum* from a horizontal crossbar, but displayed as our modern flags, that is to say, by the attachment of one of its sides to a staff. After Constantine, the *labarum* bore the monogram of Christ (fig. 5, A). It is supposed that the small scarf, which in medieval

days was often attached to the pastoral staff or crook of a bishop, was derived from the *labarum* of the first Christian emperor, Constantine the Great. The Roman standards were guarded with religious veneration in the temples at Rome; and the reverence of this people for their ensigns was in proportion to their superiority to other nations in all that tends to success in war. It was not unusual for a general to order a standard to be cast into the ranks of the enemy, to add zeal to the onset of his soldiers by exciting them to recover what to them was perhaps the most sacred thing the earth possessed. The Roman soldier swore by his ensign.

Although in earlier times drapery was occasionally used for standards, and was often appended as ornament to those of other material, it was probably not until the middle ages that it became the special material of military and other ensigns; and perhaps not until the practice of heraldry had attained to definite nomenclature and laws does anything appear which is in the modern sense a flag.

Early flags were almost purely of a religious character. In Bede's description of the interview between the heathen king Æthelberht and the Roman missionary Augustine, the followers of the latter are said to have borne banners on which silver crosses were displayed. The national banner of England for centuries—the red cross of St George—was a religious one; in fact the aid of religion seems ever to have been sought to give sanctity to national flags, and the origin of many can be traced to a sacred banner, as is notably the case with the oriflamme of France and the Dannebrog of Denmark. Of the latter the legend runs that King Waldemar of Denmark, leading his troops to battle against the enemy in 1219, saw at a critical moment a cross in the sky. This was at once taken as an answer to his prayers, and an assurance of celestial aid. It was forthwith adopted as the Danish flag and called the "Dannebrog," i.e. the strength of Denmark. Apart from all legend, this flag undoubtedly dates from the 13th century, and the Danish flag is therefore the oldest now in existence.

The ancient kings of France bore the blue hood of St Martin upon their standards. The Chape de St Martin was originally in the keeping of the monks of the abbey of Marmoutier, and the right to take this blue flag into battle with them was claimed by the counts of Anjou. Clovis bore this banner against Alaric in 507, for victory was promised him by a verse of the Psalms which the choir were chanting when his envoy entered the church of St Martin at Tours. Charlemagne fought under it at the battle of Narbonne, and it frequently led the French to victory. At what precise period the oriflamme, which was originally simply the banner of the abbey of St Denis, supplanted the Chape de St Martin as the sacred banner of all France is not known. Probably, however, it gradually became the national flag after the kings of France had transferred the seat of government to Paris, where the great local saint, St Denis, was held in high honour, and the banner hung over the tomb of the saint in the abbey church. The king of France himself was one of the vassals of the abbey of St Denis for the fief of the Vexin, and it was in his quality of count of Vexin that Louis VI., le Gros, bore this banner from the abbey to battle, in 1124. He is credited with having been the first French king to have taken the banner to war, and it appeared for the last time on the field of fight at Agincourt in 1415. The accounts also of its appearance vary considerably. Guillaume Guiart, in his *Chronicle* says:—

"Oriflamme est une bannière
De cendal voujoiant et simple
Sans portraiture d'autre affaire."

It would, therefore, seem to have been a plain scarlet flag; whilst an English authority states "the celestial auriflamb, so by the French admired, was but of one colour, a square redde banner." The *Chronique de Flandres* describes it as having three points with tassels of green silk attached. The banner of William the Conqueror was sent to him by the pope, and the early English kings fought under the banners of Edward the Confessor and St Edmund; while the blended crosses of St George, St Andrew and St Patrick still form the national ensign of the united

kingdoms of England, Scotland and Ireland, whose patron saints they severally were.

The Bayeux tapestry, commemorating the Norman conquest of England, contains abundant representations of the flags of the period borne upon the lances of the knights of William's army. They appear small in size, and pointed, frequently indented into three points and bearing pales, crosses and roundels. One, a Saxon pennon, is triangular, and roundly indented into four points; one banner is of segmental shape and rayed, and

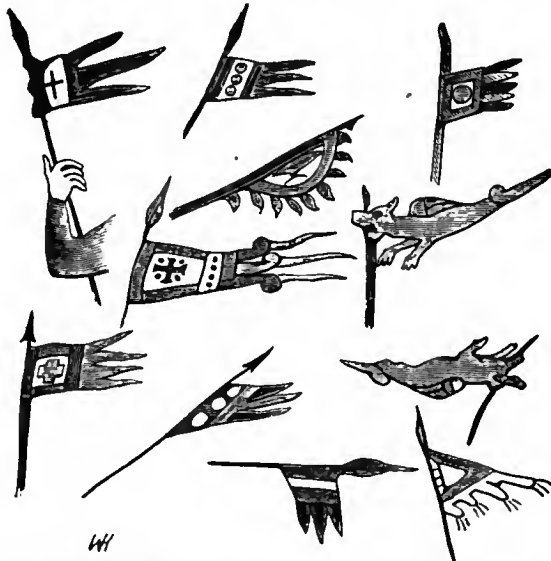

FIG. 4.—Pennons and Standards from the Bayeux Tapestry.

bears the figure of a bird, which has been supposed to represent the raven of the war-flag of the Scandinavian Vikings (fig. 4). In all, thirty-seven pennons borne on lances by various knights are represented in the Bayeux tapestry, and of these twenty-eight have triple points, whilst others have two, four or five. The devices on these pennons are very varied and distinctive, although the date is prior to the period in which heraldry became definitely established. In fact, the flags and their charges are probably not really significant of the people bearing them; for, even admitting that personal devices were used at the time, the figures may have been placed without studied intention, and so give the general figure only of such flags as happened to have come under the observation of the artists. The figures are probably rather ornamental and symbolic than strictly heraldic,—that is, personal devices, for the same insignia do not appear on the shields of the several bearers. The dragon standard which he is known to have borne is placed near Harold; but similar figures appear on the shields of Norman warriors, which fact has induced a writer in the *Journal of the Archaeological Association* (vol. xiii. p. 113) to suppose that on the spears of the Saxons they represent only trophies torn from the shields of the Normans, and that they are not ensigns at all. Standards in form much resembling these dragons appear on the Arch of Titus and the Trajan column as the standards of barbarians.

At the battle of the Standard in 1138 the English standard was formed of the mast of a ship, having a silver pyx at the top and bearing three sacred banners, dedicated severally to St Peter, St John of Beverley and St Wilfrid of Ripon, the whole being fastened to a wheeled vehicle. Representations of three-pointed, cross-bearing pennons are found on seals of as early date as the No man era, and the warriors in the first crusade bore three-pointed pennons. It is possible that the three points with the three roundels and cross, which so often appear on these banners, have some reference to the faith of the bearers in the Trinity and in the Crucifixion, for in contemporary representations of Christ's resurrection and descent into hell he bears a three-pointed banner with cross above. The triple indentation so common on the flags of this period has been supposed to be the origin of one of the honourable ordinaries

—the pile. The "pile," it may be explained, is in the form of a wedge, and unless otherwise specified in the blazon, occupies the central portion of the escutcheon, issuing from the middle chief. It may, however, issue from any other extremity of the shield, and there may be more than one. More secular characters were, however, not uncommon. In 1244 Henry III. gave order for a "dragon to be made in fashion of a standard of red silk sparkling all over with fine gold, the tongue of which should be made to resemble burning fire and appear to be continually moving, and the eyes of sapphires or other suitable stones." *The Siege of Carlaverock*, an Anglo-Norman poem of the 14th century, describes the heraldic bearings on the banners of the knights at the siege of that fortress. Of the king himself the writer says:—

" En sa bannière trois luparte
De or fin estoient mis en rouge;"

and he goes on to describe the kingly characteristics these may be supposed to symbolize. A MS. in the British Museum (one of Sir Christopher Barker's heraldic collection, Harl. 4632) gives drawings of the standards of English kings from Edward III. to Henry VIII., which are roughly but artistically coloured.

The principal varieties of flags borne during the middle ages were the pennon, the banner and the standard. The "guydhomes" or "guidons," "banderolls," "pennoncells," "streamers" or pendants, may be considered as minor varieties. The pennon (fig. 5, B) was a purely personal ensign, sometimes pointed, but more generally forked or swallow-tailed at the end. It was essentially the flag of the knight simple, as apart from the knight banneret, borne by him on his lance, charged with his personal armorial bearings so displayed that they stood in true position when he couched his lance for action. A MS. of the 16th century (Harl. 2358) in the British Museum, which gives minute particulars as to the size, shape and bearings of the standards, banners, pennons, guydhomes, pennoncells, &c., says "a pennon must be two yards and a half long, made round at the end, and conteyneth the armes of the owner," and warns that "from a standard or streamer a man may flee but not from his banner or pennon bearing his arms."

A pennoncell (or penselle) was a diminutive pennon carried by the esquires. Flags of this character were largely used on

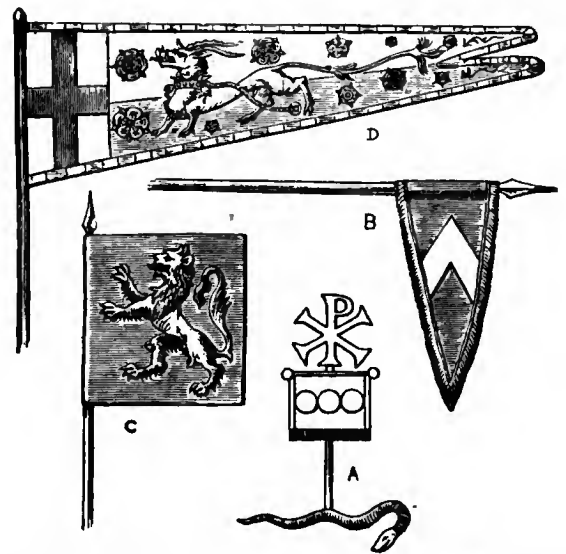

FIG. 5.—A, Labarum from medallion of Constantine; B, Medieval Pennon; C, Medieval Banner; D, Standard of Henry V.

any special occasion of ceremony; and more particularly at state funerals. For instance, we find "XII. doz. penselles" amongst the items that figured at the funeral of the duke of Norfolk in 1554, and in the description of the lord mayor's procession in the following year we read of "ij goodly pennes (state barges) deckt with flages and stremers, and a m (1000) penselles." Amongst

the items that ran the total cost of the funeral of Oliver Cromwell up to an enormous sum of money, we find mention of thirty dozen of pennoncells a foot long and costing twenty shillings a dozen, and twenty dozen of the same kind of flags at twelve shillings a dozen.

The banner was, in the earlier days of chivalry, a square flag, though at a later date it is often found greater in length than in depth, precisely as is the case in the ordinary national flags of to-day. In some very early examples it is found considerably longer in the depth on the staff than in its outward projection from the staff. The banner was charged in a manner exactly similar to the shield of the owner, and it was borne by knights banneret and all above them in rank. As a rough guide it may be taken that the banner of an emperor was 6 ft. square; of a king, 5 ft.; of a prince or duke, 4 ft.; of a marquis, earl, viscount or baron, 3 ft. square. As the function of the banner was to display the armorial bearings of the dignitary who had the right to carry it, it is evident that the square form was the most convenient and akin to the shield of primal heraldry. In fact, flags were originally heraldic emblems, though in modern devices the strict laws of heraldry have often been departed from.

The rank of knights bannerets was higher than that of ordinary knights, and they could be created on the field of battle only. To create a knight banneret, the king or commander-in-chief in person tore off the fly of the pennon on the lance of the knight, thus turning it roughly into the square flag or banner, and so making the knight a banneret. The date in which this dignity originated is uncertain, but it was probably about the period of Edward I. John Chandos is said to have been made a banneret by the Black Prince and the king of Castile at Najara on the 3rd of April 1367; John of Copeland was made a banneret in the reign of Edward III., he having taken prisoner David Bruce, the Scottish king, at the battle of Durham. In more modern times Captain John Smith, of Lord Bernard Stuart's troop of the King's Guards, who saved the royal banner from the parliamentary troops at Edgehill, was made a knight banneret by Charles I. From this time the custom of creating knights banneret ceased until it was revived by George II. after Dettingen in 1743, when the dignity was again conferred. It is true, however, that, when in 1763 Sir William Erskine presented to George III. sixteen stands of colours captured by his regiment [now the 15th (king's) Hussars] at Emsdorf, he was raised to the dignity of knight banneret, but as the ceremony was not performed on the field of battle, the creation was considered irregular, and his possession of the rank was not generally recognized.

The banner was therefore not only a personal ensign, but it also denoted that he who bore it was the leader of a military force, large or small according to his degree or estate. It was, in fact, the battle flag of the leader who controlled the particular force that followed it into the fight. Every baron who in time of war had furnished the proper number of men to his liege was entitled to charge with his arms the banner which they followed. There could indeed be at present found no better representative of the medieval "banner" than what we now term the "royal standard"; it is essentially the personal battle flag of the king of the United Kingdom of Great Britain and Ireland. It and other royal and imperial standards have now become "standards," inasmuch as they are to-day used for display in the same fashion, and for the same purposes as was the "standard" of old. The "gonfalon" or "gonfannon" was a battle flag differing from the ordinary banner in that it was not attached to the pole but hung from it crosswise, and was not always square in shape but serrated, so that the lower edge formed streamers. The gonfalon was in action borne close to the person of the commander-in-chief and denoted his position. In certain of the Italian cities chief magistrates had the privilege of bearing a gonfalon, and for this reason were known as "gonfaloniere."

The standard (fig. 5, D) was a flag of noble size, long, tapering towards the fly (the "fly" is that portion of the flag farther from the pole, the "hoist" the portion of the flag attached to the pole), the edges of the flag fringed or bordered, and with the ends split and rounded off. The shape was not, however, by

any means uniform during the middle ages nor were there any definite rules as to its charges. It varied in size according to the rank of the owner. The Tudor MS. mentioned above says of the royal standard of that time—"the Standard to be sett before the king's pavilion or tente, and not to be borne in battayle; to be in length eleven yards." A MS. of the time of Henry VII. gives the following dimensions for standards: "The King's had a length of eight yards; that of a duke, seven; a marquis, six and a half; an earl, six; a viscount, five and a half; a baron, five; a knight banneret, four and a half; and a knight four yards." The standard was, in fact, from its size, and as its very name implies, not meant to be carried into action, as was the banner, but to denote the actual position of its possessor on occasions of state ceremonial, or on the tilting ground, and to denote the actual place occupied by him and his following when the hosts were assembled in camp preparatory for battle. It was essentially a flag denoting position, whereas the banner was the rallying point of its followers in the actual field. Its uses are now fulfilled, as far as royalties are concerned, by the "banner" which has now become the "royal standard," and which floats over the palace where the king is in residence, is hoisted at the saluting point when he reviews his troops, and is broken from the mainmast of any ship in his navy the moment that his foot treads its deck. The essential condition of the standard was that it should always have the cross of St. George conspicuous in the innermost part of the hoist immediately contiguous to the staff; the remainder of the flag was then divided fesse-wise by two or more stripes of colours exactly as the heraldic "ordinary" termed "fesse" crosses the shield horizontally. The colours used as stripes, as also those used in the fringe or bordering of the standard, were those which prevailed in the arms of the bearer or were those of his livery. The standard here depicted (fig. 5, D) is that of Henry V.; the colours white and blue, a white antelope standing between two red roses, and in the interspaces more red roses. To quote again from the Harleian MS. above mentioned: "Every standard and guidon to have in the chief the cross of St George, the beast or crest with his devyce and word, and to be slitt at the end." The motto indeed usually figured on most standards, though occasionally it was missing. An excellent type of the old standard is that of the earls of Percy, which bore the blue lion, the crescent, and the fetterlock—all badges of the family—whilst, as tokens of matrimonial alliances with the families of Poynings, Bryan and Fitzpayne, a silver key, a bugle-horn and a falchion were respectively displayed. There was also the historic Percy motto, *Espérance en Dieu*. No one, whatsoever his rank, could possess more than one banner, since it displayed his heraldic arms, which were unchangeable. A single individual, however, might possess two or three standards since this flag displayed badges that he could multiply at discretion, and a motto that he could at any time change. For example, the standards of Henry VII., mostly green and white—the colours of the Tudor livery—had in one "a red fyre dragon," in another "a donne kowe," in a third "a silver greyhound and two red roses." The standard was always borne by an eminent person, and that of Henry V. at Agincourt is supposed to have been carried upon a car that preceded the king. At Nelson's funeral his banner and standard were borne in the procession, and around his coffin were the banderolls—square, bannerlike flags bearing the various arms of his family lineage. Nelson's standard bore his motto, *Palmam qui meruit ferat*, but, in lieu of the cross of St George, it bore the union of the crosses of St George, St Andrew and St Patrick, the medieval England having expanded into the United Kingdom of Great Britain and Ireland. Again, at the funeral of the duke of Wellington we find amongst the flags his personal banner and standard, and ten banderolls of the duke's pedigree and descent.

The guidon, a name derived from the Fr. *Guyd-homme*, was somewhat similar to the standard, but without the cross of St George, rounded at the end, less elongated and altogether less ornate. It was borne by a leader of horse, and according to a medieval writer "must be two and a half yards or three yards

long, and therein shall no armes be put, but only the man's crest, cognisance, and devyce."

The streamer, so called in Tudor days but now better known as the pennant or pendant, was a long, tapering flag, which it was directed "shall stand in the top of a ship or in the fore-castle, and therein be put no armes, but the man's cognisance or devyce, and may be of length twenty, thirty, forty or sixty yards, and is slitt as well as a guidon or standard." Amongst the fittings of the ship that took Beauchamp, earl of Warwick, to France in the reign of Henry VII. was a "grete stremour for the shippe xl yarges in length viij yarges in brede." In the hoist was "a grete bere holding a raggid staffe," and the rest of the fly "powdridd full of raggid staves."

NATIONAL FLAGS.—British. The royal standard of England was, when it was hoisted on the Tower on the 1st of January 1801, thus heraldically described:—"Quarterly; first and fourth, gules, three lions passant gardant, in pale, or, for England; second, or, a lion rampant, gules, within a double tressure flory counter flory of the last, for Scotland; third, azure, a harp or, stringed argent, for Ireland." The present standard connects in direct descent from the arms of the Conqueror. These were two leopards passant on a red field, and remained the same until the reign of Henry II., when lions were substituted for leopards, and a third added. The next change that took place was in the reign of Edward III. when the royal arms were for the first time quartered; *fleurs-de-lis* in the first and fourth quarters, and the three lions of England in the second and third. The *fleurs-de-lis* were assumed in token of the monarch's claim to the throne of France. In the "coats" of Edward III. and the two monarchs that succeeded him, the *fleurs-de-lis* were powdered over a blue ground, but under Henry V. the *fleurs-de-lis* were reduced in number to three, and the "coat" so devised remained the same until the death of Queen Elizabeth. The lion of Scotland and the Irish harp were added to the flag on the accession of James I., and the flag then had the French and English arms quartered in the first and fourth quarters, the lion of Scotland, red on a yellow ground, in the second quarter, and the harp of Ireland, gold on a blue ground, in the third quarter. With the exception of the period of the Commonwealth, to which reference will be made later, the flag remained thus until the accession of William III., who imposed upon the Stuart standard a central shield carrying the arms of Nassau. Queen Anne made further alterations; the first and fourth quarters were subdivided, the three lions of England being in one half, the lion of Scotland in the other. The *fleurs-de-lis* were in the second quarter; the Irish harp in the third. Under George I. and George II. the first, second and third quarters remained the same, the arms of Hanover being placed in the fourth quarter, and this continued to be the royal standard until 1801, when the standard was re-arranged as first described with the addition of the Hanoverian arms displayed on a shield in the centre. On the accession of Queen Victoria, the Hanoverian arms were removed, and the flag remained as it to-day exists. It is worthy of note, however, that in the royal standard of King Edward VII. which hangs in the chapel of St George at Windsor, the ordinary "winged woman" form of the harp in the Irish third quartering is altered to a harp of the old Irish pattern. At King Edward's accession this banner replaced that of Queen Victoria which for sixty-two years had hung in this, the chapel of the order of the Garter.

Up to the time of the Stuarts it had been the custom of the lord high admiral or person in command of the fleet to fly the royal standard as deputy of the sovereign. When royalty ceased to be, a new flag was devised by the council of state for the Commonwealth, which comprised the "arms of England and Ireland in two several escutcheons in a red flag within a compartment." In other words, it was a red flag containing two shields, the one bearing the cross of St George, red on a white ground, the other the harp, gold on a blue ground, and round the shields was a wreath of palm and shamrock leaves. One of these flags is still in existence at Chatham dockyard, where it is kept in a wooden chest which was taken out of a Spanish galleon at Vigo by Admiral Sir George Rooke in 1704. When Cromwell

became protector of the commonwealth of England, Scotland and Ireland, he devised for himself a personal standard. This had the cross of St George in the first and fourth quarters, the cross of St Andrew, a white saltire on a blue ground, in the second, and the Irish harp in the third. His own arms—a lion on a black shield—were imposed on the centre of the flag. No one but royalty has a right to fly the royal standard, and though it is constantly seen flying for purposes of decoration its use is irregular. There has, however, always been one exception, namely, that the lord high admiral when in executive command of a fleet has always been entitled to fly the royal standard. For example, Lord Howard flew it from the mainmast of the "Ark Royal" when he defeated the Spanish Armada; the duke of Buckingham flew it as lord high admiral in the reign of Charles I., and the duke of York fought under it when he commanded during the Dutch Wars.

The national flag of the British empire is the Union Jack, in which are combined in union the crosses of St George, St Andrew and St Patrick. St George had long been a patron saint of England, and his banner, argent, a cross gules, its national ensign. St Andrew in the same way was the patron saint of Scotland, and his banner, azure, a saltire argent, the national ensign of Scotland. On the union of the two crowns James I. issued a proclamation ordaining that "henceforth all our subjects of this Isle and Kingdom of Greater Britain and the members thereof, shall bear in their main-top the red cross commonly called St George's cross, and the white cross commonly called St Andrew's cross, joined together according to a form made by our heralds, and sent by us to our admiral to be published to our said subjects; and in their fore-top our subjects of south Britain shall wear the red cross only, as they were wont, and our subjects of north Britain in their fore-top, the white cross only as they were accustomed." This was the first Union Jack, as it is generally termed, though strictly the name of the flag is the "Great Union," and it is only a "Jack" when flown on the jackstaff of a ship of war. Probably the name of the Stuart king "Jacques," which James I. always signed, gave the name to the flag, and then to the staff at which it was hoisted. At the death of Charles I., the union with Scotland being dissolved, the ships of the parliament reverted to the simple cross of St George, but the union flag was restored when Cromwell became protector, with the Irish harp imposed upon its centre. On the Restoration, Charles II. removed the harp and so the original union flag was restored, and continued as described until the year 1801, when, on the legislative union with Ireland, the cross of St Patrick, a saltire gules, on a field argent, was incorporated in the union flag. To so combine these three crosses without losing the distinctive features of each was not easy; each cross must be distinct, and retain equally distinct its fimbriation, or bordering, which denotes the original ground. In the first union flag, the red cross of St George with the white fimbriation that represented the original white field was simply imposed upon the white saltire of St Andrew with its blue field. To place the red saltire of St Patrick on the white saltire of St Andrew would have been to obliterate the latter, nor would the red saltire have its proper bordering denoting its original white field; even were the red saltire narrowed in width the portion of the white saltire that would appear would not be the St Andrew saltire, but only the fimbriation appertaining to the saltire of St Patrick. The difficulty has been got over by making the white broader on one side of the red than the other. In fact, the continuity of direction of the arms of the St Patrick red saltire has been broken by its portions being removed from the centre of the oblique points that form the St Andrew's saltire. Thus both the Irish and Scottish saltires can be easily distinguished from one another, whilst the red saltire has its due white fimbriation.

The Union Jack is the most important of all British ensigns, and is flown by representatives of the empire all the world over. It flies from the jackstaff of every man-of-war in the navy. With the Irish harp on a blue shield displayed in the centre, it is flown by the lord-lieutenant of Ireland. When flown by the

FLAGS



GREAT BRITAIN.
Royal Standard.



GREAT BRITAIN.
White Ensign
(Royal Navy).

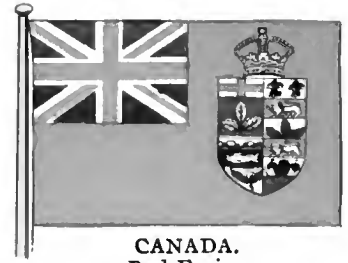

CANADA.
Red Ensign
(Mercantile Marine).

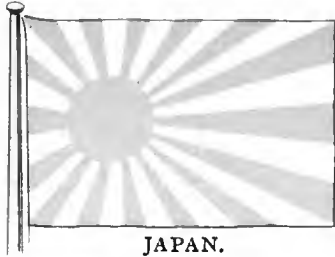

JAPAN.
Imperial Navy.



NEW ZEALAND.
Blue Ensign
(Government).

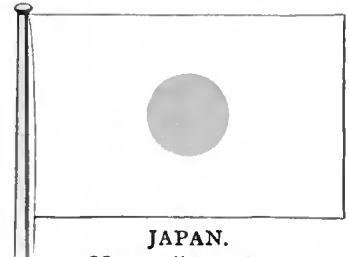

JAPAN.
Mercantile Marine.



GERMANY.
Imperial Navy.



GREAT BRITAIN.
Union Jack.



AUSTRIA-HUNGARY.
Imperial Navy.



GERMANY.
Mercantile Marine.



SPAIN.
Royal Navy.

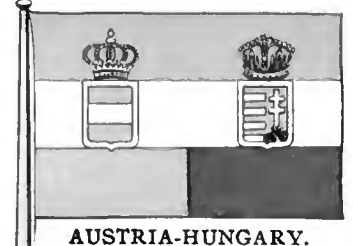

AUSTRIA-HUNGARY.
Mercantile Marine.



FRANCE.
National Flag.

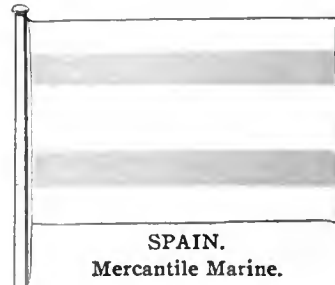

SPAIN.
Mercantile Marine.



ITALY.
Mercantile Marine.



PORTUGAL.
National Flag.



RUMANIA.
National Flag.

governor-general of India the star and device of the order of the Star of India are borne in the centre. Colonial governors fly it with the badge of their colony displayed in the centre. Diplomatic representatives use it with the royal arms in the centre. As a military flag, it is flown over fortresses and headquarters, and on all occasions of military ceremonial. Hoisted at the mainmast of a man-of-war it is the flag of an admiral of the fleet.

Military flags in the shape of regimental standards and colours, and flags used for signalling, are described elsewhere, and it will here be only necessary to deal with the navy and admiralty flags.

The origin of the three ensigns—the red, white, and blue—had its genesis in the navy. In the days of huge fleets, such as prevailed in the Tudor and Stuart navies, there were, besides the admiral in supreme command, a vice-admiral as second in command, and a rear-admiral as third in command, each controlling his own particular group or squadron. These were designated centre, van, and rear, the centre almost invariably being commanded by the admiral, the vice-admiral taking the van and the rear-admiral the rear squadron. In order that any vessel in any group could distinguish its own admiral's ship, the flagships of centre, van, and rear flew respectively a plain red, white, or blue flag, and so came into being those naval ranks of admiral, vice-admiral, and rear-admiral of the red, white, and blue which continued down to as late as 1864. As the admiral in supreme command flew the union at the main, there was no rank of admiral of the red, and it was not until November 1805 that the rank of admiral of the red was added to the navy as a special compliment to reward Trafalgar. About 1652, so that each individual ship in the squadron should be distinguishable as well as the flagships, each vessel carried a large red, white, or blue flag according as to whether she belonged to the centre, van, or rear, each flag having in the left-hand upper corner a canton, as it is termed, of white bearing the St George's cross. These flags were called ensigns, and it is, of course, due to the fact that the union with Scotland was for the time dissolved that they bore only the St George's cross. Even when the restoration of the Stuarts restored the *status quo* the cross of St George still remained alone on the ensign, and it was not altered until 1707 when the bill for the Union of England and Scotland passed the English parliament. In 1801, when Ireland joined the Union, the flag, of course, became as we know it to-day. All these three ensigns belonged to the royal navy, and continued to do so until 1864, but as far back as 1707 ships of the mercantile marine were instructed to fly the red ensign. As ironclads replaced the wooden vessels and fleets became smaller the inconvenience of three naval ensigns was manifest, and in 1864 the grades of flag officer were reduced again to admiral, vice-admiral, and rear-admiral, and the navy abandoned the use of the red and blue ensigns, retaining only the white ensign as its distinctive flag. The mercantile marine retained the red ensign which they were already using, whilst the blue ensign was allotted to vessels employed on the public service whether home or colonial.

The white ensign is therefore essentially the flag of the royal navy. It should not be flown anywhere or on any occasion except by a ship (or shore establishment) of the royal navy, with but one exception. By a grant of William IV. dating from 1829 vessels belonging to the Royal Yacht Squadron, the chief of all yacht clubs, are allowed to fly the white ensign. From 1821 to 1829 ships of the squadron flew the red ensign, as that of highest dignity, but as it was also used by merchant ships, they then obtained the grant of the white ensign as being more distinctive. Some few other yacht clubs flew it until 1842, when the privilege was withdrawn by an admiralty minute. By some oversight the order was not conveyed to the Royal Western of Ireland, whose ships flew the white ensign until in 1857 the usage was stopped. Since that date the Royal Yacht Squadron has alone had the privilege. Any vessel of any sort flying the white ensign, or pennant, of the navy is committing a grave offence, and the ship can be boarded by any officer of His

Majesty's service, the colours seized, the vessel reported to the authorities, and a penalty inflicted on the owners or captain or both. The penalty incurred is £500 fine for each offence, as laid down in the 73rd section of the Merchant Shipping Act 1894. In 1883 Lord Annesley's yacht, belonging to the Royal Yacht Squadron, was detained at the Dardanelles in consequence of her flying the white ensign of the royal navy which brought her under the category of a man-of-war, and no foreign man-of-war is allowed to pass the Dardanelles without first obtaining an imperial *irade*. Since then owners belonging to the squadron have been warned that they must either sail their ships through the straits under the red ensign common to all ships British owned, or obtain imperial permission if they wish to display the white ensign.

Besides the white ensign the ship of war flies a long streamer from the maintopgallant masthead. This, which is called a pennant, is flown only by ships in commission; it is, in fact, the sign of command, and is first hoisted when a captain commissions his ship. The pennant, which was really the old "pennoncell," was of three colours for the whole of its length, and towards the end left separate in two or three tails, and so continued till the end of the great wars in 1816. Now, however, the pennant is a long white streamer with the St George's cross in the inner portion close to the mast. Pennants have been carried by men-of-war from the earliest times, prior to 1653 at the yard-arm, but since that date at the maintopgallant masthead.

The blue ensign is exclusively the flag of the public service other than the royal navy, and is as well the flag of the royal naval reserve. It is flown also by certain authorized vessels of the British mercantile marine, the conditions governing this privilege being that the captain and a certain specified portion of the officers and crew shall belong to the ranks of the royal naval reserve. When flown by ships belonging to British government offices the seal or badge of the office is displayed in the fly. For example, hired transports fly it with the yellow anchor in the fly; the marine department of the Board of Trade has in the fly the device of a ship under sail; the telegraph branch of the post-office shows in the fly a device representing Father Time with his hour-glass shattered by lightning; the ordnance department displays upon the fly a shield with a cannon and cannon balls upon it. Certain yacht clubs are also authorized by special admiralty warrant to fly the blue ensign. Some of these display it plain; others show in the fly the distinctive badge of the club. Consuls-general, consuls and consular agents also have a right to fly the blue ensign, the distinguishing badge in their case being the royal arms.

The red ensign is the distinguishing flag of the British merchant service, and special orders to this effect were issued by Queen Anne in 1707, and again by Queen Victoria in 1864. The order of Queen Anne directed that merchant vessels should fly a red flag "with a Union Jack described in a canton at the upper corner thereof next the staff," and this is probably the first time that the term "Union Jack" was officially used. In some cases those yacht clubs which fly the red ensign change it slightly from that flown by the merchant service, for they are allowed to display the badge of the club in the fly. Colonial merchantmen usually display the ordinary red ensign, but, provided they have a warrant of authorization from the admiralty, they can use the ensign with the badge of the colony in the fly.

In regard to ensigns it is important to remember that they are purely maritime flags, and though the rule is more honoured in the breach than in the observance, the only flag that a private individual or a corporation has a right to display on shore is the national flag, the Union Jack, in its plain condition and without any emblazonment.

There are two other British sea flags which are worthy of brief notice. These are the admiralty flag and the flag of the master of Trinity House. The admiralty flag is a plain red flag with a clear anchor in the centre in yellow. In a sense it is a national flag, for the sovereign hoists it when afloat in conjunction with the royal standard and the Union Jack. It would

appear to have been first used by the duke of York as lord high admiral, who flew it when the sovereign was afloat and had the royal standard flying in another ship. When a board of commissioners was appointed to execute the office of lord high admiral this was the flag adopted, and in 1691 we find the admiralty, minuting the navy board, then a subordinate department, "requiring and directing it to cause a fitting red silk flag, with the anchor and cable therein, to be provided against Tuesday morning next, for the barge belonging to this board." In 1725, presumably as being more pretty and artistic, the cable in the device was twisted round the stock of the anchor. It was thus made into a "foul anchor," the thing of all others that a sailor most hates, and this despite the fact that the first lord at the time, the earl of Berkeley, was himself a sailor. The anchor retained its unseamanlike appearance, and was not "cleared" till 1815, and even to this day the buttons of the naval uniform bear a "foul anchor." The "anchor" flag is solely the emblem of an administrative board; it does not carry the executive or combatant functions which are vested in the royal standard, the union or an admiral's flag, but on two occasions it has been made use of as an executive flag. In 1719 the earl of Berkeley, who at the time was not only first lord of the admiralty, but vice-admiral of England, obtained the special permission of George I. to hoist it at the main instead of the union flag. Again in 1869, when Mr Childers, then first lord, accompanied by some members of his board, went on board the "Agincourt" he hoisted the admiralty flag and took command of the combined Mediterranean and Channel squadrons, thus superseding the flags of the two distinguished officers who at the time were in command of these squadrons. It is hardly necessary to add that throughout the navy there was a very distinct feeling of dissatisfaction at the innovation. When the admiralty flag is flown by the sovereign it is hoisted at the fore, his own standard being of course at the main, and the union at the mizzen.

The flag of the master of the Trinity House is the red cross of St George on its white ground, but with an ancient ship on the waves in each quarter; in the centre is a shield with a precisely similar device and surmounted by a lion.

The sign of a British admiral's command afloat is always the same. It is the St George's cross. Of old it was borne on the main, the fore, or the mizzen, according as to whether the officer to whom it pertained was admiral, vice-admiral, or rear-admiral, but, as ironclads superseded wooden ships, and a single pole mast took the place of the old three masts, a different method of indicating rank was necessitated. To-day the flag of an admiral is a square one, the plain St George's cross. When flown by a vice-admiral it bears a red ball on the white ground in the upper canton next to the staff; if flown by a rear-admiral there is a red ball in both the upper and lower cantons. As nowadays most battleships have two masts, the admiral's flag is hoisted at the one which has no masthead semaphore. The admiral's flag is always a square one, but that of a commodore is a broad white pennant with the St George's cross. If the commodore be first class the flag is plain; if of the second class the flag has a red ball in the upper canton next to the staff. The same system of differentiating rank prevails in most navies, though very often a star takes the place of the ball. In some cases, however, the indications of rank are differently shown. For instance, both in the Russian and Japanese navies the distinction is made by a line of colour on the upper or lower edges of the flag.

The flags of the British colonies are the same as those of the mother country, but differentiated by the badge of the colony being placed in the centre of the flag if it is the Union Jack, or in the fly if it be the blue or red ensign. Examples of these are shown in the Plate, where the blue ensign illustrated is that of New Zealand, the device of the colony being the southern cross in the fly. Precisely the same flag, with a large six-pointed star, emblematic of the six states immediately under the union, forms the flag of the federated commonwealth of Australia. The red ensign shown is that of the Dominion of Canada, the

device in the fly being the armorial bearings of the Dominion. As the lord-lieutenant of Ireland, as the representative of royalty, flies the Union Jack with a harp in the centre, or the viceroy of India flies the same flag with, in the centre, the badge of the order of the Star of India, so too colonial governors or high commissioners fly the union flag with the arms of the colony they preside over on a white shield in the centre and surrounded by a laurel wreath. In the case of Canada the wreath, however, is not of laurel but of maple, which is the special emblem of the Dominion.

French.—To come to flags of other countries, nowhere have historical events caused so much change in the standards and national ensigns of a country as in the case of France. The oriflamme and the Chape de St Martin were succeeded at the end of the 16th century, when Henry III., the last of the house of Valois, came to the throne, by the white standard powdered with *fleurs-de-lis*. This in turn gave place to the famous tricolour. The tricolour was introduced at the time of the Revolution, but the origin of this flag and its colours is a disputed question. Some maintain that the intention was to combine in the flag the blue of the Chape de St Martin, the red of the oriflamme, and the white flag of the Bourbons. By others the colours are said to be those of the city of Paris. Yet again, other authorities assert that the flag is copied from the shield of the Orleans family as it appeared after Philippe Égalité had knocked off the *fleurs-de-lis*. The tricolour is divided vertically into three parts of equal width—blue, white and red, the red forming the fly, the white the middle, and the blue the hoist of the flag. During the first and second empires the tricolour became the imperial standard, but in the centre of the white stripe was placed the eagle, whilst all three stripes were richly powdered over with the golden bees of the Napoleons. The tricolour is now the sole flag of France.

American.—Before the Declaration of Independence the flags of those colonies which now form the United States of America were very various. In the early days of New England the Puritans objected to the red cross of St George, not from any disloyalty to the mother country, but from a conscientious objection to what they deemed an idolatrous symbol. By the year 1700 most of the colonies had devised badges to distinguish their vessels from those of England and of each other. In the early stages of the revolution each state adopted a flag of its own; thus, that of Massachusetts bore a pine tree, South Carolina displayed a rattlesnake, New York had a white flag with a black beaver, and Rhode Island a white flag with a blue anchor upon it. Even after the Declaration of Independence, and the introduction of the stars and stripes, the latter underwent many changes in the manner of their arrangement before taking the position at present established. In 1775 a committee was appointed to consider the question of a single flag for the thirteen states. It recommended that the union be retained in the upper corner next to the staff, the remainder of the field of the flag to be of thirteen horizontally disposed stripes, alternately red and white. This flag, curiously enough, was precisely the same as the flag of the old Honourable East India Company. On the 14th of June 1777 congress resolved "that the flag of the United States be thirteen stripes, alternate red and white; that the Union be thirteen stars, white in a blue field, representing a new constellation." This was the origin of the national flag, but at first, as the number of the stripes were unequal, the flag very often varied, sometimes having seven white and six red stripes, and at other times seven red and six white, and it was not for some considerable time that it was authoritatively laid down that the latter arrangement was the one to be adopted. It has also been held that the stars and stripes of the American national flag, as well as the eagle, were suggested by the crest and arms of the Washington family. The latter supposition is absurd, for the Washington crest was a raven. The Washington arms were a white shield having two horizontal red bars, and above these a row of three red stars. This might, by a stretch of imagination, be supposed to have inspired the original idea of the flag which was that each state in the Union should be represented in the national flag by a star

FLAGS

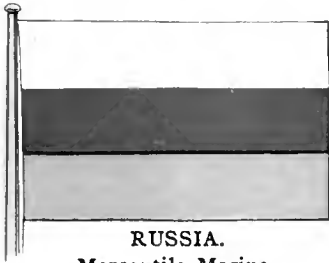

RUSSIA.
Mercantile Marine.



RUSSIA.
Imperial Navy.



BELGIUM.
National Flag.

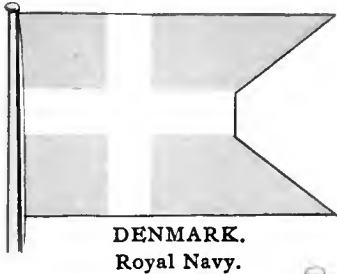

DENMARK.
Royal Navy.

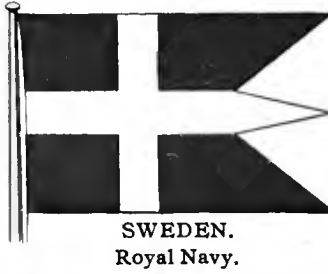

SWEDEN.
Royal Navy.

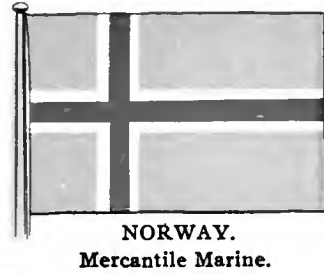

NORWAY.
Mercantile Marine.



NETHERLANDS.
National Flag.

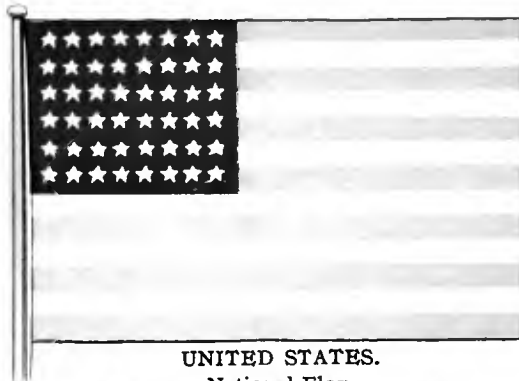

UNITED STATES.
National Flag.



GREECE.
Mercantile Marine.



SWITZERLAND.
National Flag.



MEXICO.
Naval.



TURKEY.
National Flag.



CHINA.
Imperial Navy.



CHILE.
National Flag.



BRAZIL.
National Flag.



ARGENTINA.
Naval.



PERU.
Naval.



VENEZUELA.
Naval.

and stripe. Naturally other states coming into the Union expected the same privilege. After Vermont in 1790 and Kentucky in 1792 had entered the Union, the stars and stripes were changed in number from thirteen to fifteen. Later on other states joined, and soon the flag came to consist of twenty stars and stripes. It was, however, found objectionable to be constantly altering the national flag, and in the year 1818 it was determined to go back to the original thirteen stripes, but to place a star for each state in the blue union canton in the top corner of the flag next the staff. Thus the stars always show the exact number of states that are in the Union, whilst the stripes denote the original number of the states that formed the union.¹ The presidential flag of the president of the United States is an eagle on a blue field, bearing on its breast a shield displaying stripes, and above the national motto *E pluribus unum*, and a design of the stars of the original thirteen states of the union.

Other Countries.—The most general and important of the various national flags are figured in the Plate. In the top line representing Great Britain are shown the royal standard, the Union Jack (the national flag), the white ensign of the royal navy, the blue ensign of government service, and the red ensign of the commercial marine, colonial flags being shown in the case of the two latter ensigns. The two Japanese flags shown are the man-of-war ensign—a rising sun, generally known as the sun-burst—and the flag of the mercantile marine, in which the red ball is used without the rays and placed in the centre of the white field. The imperial standard of Japan is a golden chrysanthemum on a red field. It is essential that the chrysanthemum should invariably have sixteen petals. Heraldry in Japan is of a simpler character than that of Europe, and is practically limited to the employment of “Mon,” which correspond very nearly to the “crests” of European heraldry. The great families of Japan possess at least one, and in many cases even three, “Mon.” The imperial family use two, the one *Kiku no go Mon* (the august chrysanthemum crest) and *Kiri no go Mon* (the august Kiri crest). The first represents the sixteen-petalled chrysanthemum, and, although the use of the chrysanthemum flower as a badge is not necessarily confined to the imperial family, they alone have the right to use the sixteen-petalled form. If used by any other family, or society or corporation, it must be with a number of petals less or more than sixteen. The second imperial “Mon” is composed of three leaves and three flower spikes of the Kiri (*Paulownia imperialis*). This, however, is not displayed as an official emblem, that being reserved for the chrysanthemum. The Kiri is used for more private purposes. For example, the chrysanthemum figures in the imperial standard, and the Kiri “Mon” adorns the harness of the emperor’s horses. It is very probable that the chrysanthemum crest did not originally represent the chrysanthemum flower at all but the sun with sixteen rays, and it will be noticed that in the “sun-burst” flag the sun’s rays are sixteen in number. The use of the number sixteen is probably traceable to Chinese geomantic ideas.

The German imperial navy and mercantile marine flags are next depicted. The “iron cross” in the navy flag is that of the Teutonic Order, and dates from the close of the 12th century. For five centuries black and white have been the Hohenzollern colours, and the first verse of the German war song, *Ich bin ein Preusse*, runs:—

“I am a Prussian! Know ye not my banner?
Before me floats my flag of black and white!
My fathers died for freedom, 'twas their manner,
So say these colours floating in your sight.”

The mercantile marine tricolour of black, white and red is emblematic of the joining of the Hohenzollern black and white with the red and white, which was the ensign of the Hanseatic League. This flag came into being when the North German Confederacy was established (November 25th, 1867) at the close of the Austro-Prussian War.

The German imperial standard has the iron cross with its white border displayed on a yellow field, diapered over in each of the four quarters with three black eagles and a crown. In the centre of the cross is a shield bearing the arms of Prussia surmounted by a crown,

and surrounded by a collar of the Order of the Black Eagle. In the four arms of the crown are the legend *Gott mit uns 1870*. The United States flag and the tricolour of France have already been fully dealt with, and in both countries the one flag is common to both men-of-war and ships of the mercantile marine.

The next depicted are the imperial navy and the mercantile marine flags of the Austro-Hungarian empire. In the latter the introduction of the green half stripe denotes the combination of the Austrian red, white and red with the Hungarian red, white and green. The shields with which the flag is charged contain respectively the arms of Austria and of Hungary. The former shield only is borne on the man-of-war ensign, and displays the heraldic device of the ancient dukes of Austria, which dates back to the year 1191. The Austrian imperial standard has, on a yellow ground, the black double-headed eagle, on the breast and wings of which are imposed shields bearing the arms of the provinces of the empire. The flag is bordered all round, the border being composed of equal-sided triangles with their apices alternately inwards and outwards, those with their apices pointing inwards being alternately yellow and white, the others alternately scarlet and black.

The green, white and red Italian tricolour was adopted in 1805, when Napoleon I. formed Italy into one kingdom. It was adopted again in 1848 by the Nationalists of the peninsula, accepted by the king of Sardinia, and, charged by him with the arms of Savoy, it became the flag of a united Italy. The man-of-war flag is precisely similar to that of the mercantile marine, except that in the case of the former the shield of Savoy is surmounted by a crown. The royal standard is a blue flag. In the centre is a black eagle crowned and displaying on its breast the arms of Savoy, the whole surrounded by the collar of the Most Sacred Annunziata, the third in rank of all European orders. In each corner of the flag is the royal crown.

For Portugal the flag is one of the few national flags that are parti-coloured. It is half blue, half white, with, in the centre, the arms of Portugal surmounted by the royal crown, and it is the same both in the mercantile marine and in the Portuguese navy. The royal standard of Portugal is an all-red flag charged in the centre with the royal arms, as shown in the national flag.

In the Spanish ensigns red and yellow are the prevailing colours, and here again the arrangement differs from that generally used. The navy flag has a yellow central stripe, with red above and below. To be correct the yellow should be half the width of the flag, and each of the red stripes a quarter of the width of the flag. The central yellow stripe is charged in the hoist with an escutcheon containing the arms of Castile and Leon, and surmounted by the royal crown. In the mercantile flag the yellow centre is without the escutcheon, and is one-third of the entire depth of the flag, the remaining thirds being divided into equal stripes of red and yellow, the yellow above in the upper part of the flag, the red in the lower. Of all royal standards that of Spain is the most elaborate, for it contains quarterings of the Spanish royal escutcheon, many of the bearings being as much an anachronism as if the royal arms of England were to-day to be quartered with the *fleur-de-lis*. In all, the quarterings displayed are those of Leon, Castile, Aragon, Sicily, Austria, Burgundy, Flandris, Antwerp, Brabant, Portugal and France. The flag is usually depicted as composed entirely of the quarterings. We believe, however, that it is more correctly a purple flag in the centre of which the quarterings are displayed on an oval shield surmounted by a crown and encircled by the collar of the order of the Golden Fleece.

The flag of the Russian mercantile marine is a horizontal tricolour of white, blue and red. Originally, it was a tricolour of blue, white and red, and it is said that the idea of its colouring was taken by Peter the Great when learning shipbuilding in Holland, for as the flag then stood it was simply the Dutch ensign reversed. Later, to make it more distinctive, the blue and white stripes changed places, leaving the tricolour as it stands to-day. The flag of the Russian navy is the blue saltire of St Andrew on a white ground. St Andrew is the patron saint of Russia, from whence the emblem. The imperial standard is of a character akin to that of Austria; the ground is yellow, and the centre bears the imperial double-headed eagle, a badge that dates back to 1472, when Ivan the Great married a niece of Constantine Palaeologus and assumed the arms of the Greek empire. On the breast of the eagle is an escutcheon charged with the emblem of St George and the Dragon on a red ground, and this is surrounded by the collar of the order of St Andrew. On the splayed wings of the eagle are small shields bearing the arms of the various provinces of the empire.

The Rumanian flag is a blue, yellow and red tricolour, the stripes vertical, with the blue stripe forming the fly. The Servian flag is a horizontal tricolour, the top stripe red, the middle blue and the lower white. When these tricolours are flown as royal standards the royal arms are displayed on the central stripe. The flag of Montenegro is a horizontal tricolour, the top stripe red, the centre blue, the lowermost white. The Bulgarian flag is a similar tricolour, white, green and red, the white stripe uppermost, but when flown as a war ensign there is a canton in the upper corner of the hoist in which is a golden lion on a red ground.

The flags of all the three Scandinavian kingdoms are somewhat similar in design. That of Denmark, the Dannebrog, has been already alluded to, and it is shown in our illustration as flown by the Danish

¹ By the admission of Oklahoma as a state in 1907 the number of stars became 46, arranged from the top in horizontal rows thus: 8, 7, 8, 7, 8, 8 = 46.

navy. The mercantile marine flag is precisely similar, but rectangular instead of being swallow-tailed. The Swedish flag is a yellow cross on a blue ground. When flown from a man-of-war it is forked as in the Danish, but the longer arm of the cross is not cut off but pointed, thus making it a three-pointed flag as illustrated. For the mercantile marine the flag is rectangular. When Norway separated from Denmark in 1814, the first flag was red with a white cross on it, and the arms of Norway in the upper corner of the hoist, but as this was found to resemble too closely the Danish flag, a blue cross with a white border was substituted for the red cross. This, it will be seen, is the Danish flag with a blue cross imposed upon the white one. For a man-of-war the flag is precisely similar to that of Sweden in shape; that is to say, converted from the rectangular into the three-pointed design. While Sweden and Norway remained united the flag of each remained distinct, but each bore in the top canton of the hoist a union device, being the combination of the Norwegian and Swedish national colours and crosses. In each of the three above nationalities the flag used for a royal standard is the man-of-war flag with the royal arms imposed on the centre of the cross.

The Belgian tricolour is vertical, the stripes being black next the hoist, yellow in the centre and red in the fly. That of the Netherlands is a horizontal tricolour, red above, white in the centre and blue below. In both countries the same flag is common to both navy and mercantile marine, but when the flag is used as a royal standard the royal arms are displayed in the central stripe. The black, yellow and red of the Belgian flag are the colours of the duchy of Brabant, and were adopted in 1831 when the monarchy was founded. The original Dutch colours adopted when Holland declared its independence were orange, white and blue, the colours of the house of Orange, and when and how the orange became red is not quite clear, though it was certainly prior to 1643.

The blue and white which form the colouring of the Greek flag shown in our illustration are the colours of the house of Bavaria, and were adopted in 1832, when Prince Otho of Bavaria was elected to the throne of Greece. The stripes are nine in number—five blue and four white—with, in the upper corner of the hoist, a canton bearing a white cross on a blue ground. The flag for the royal navy is similar to that flown by the mercantile marine, with the exception that it has the addition of a golden crown in the centre of the cross. The royal standard is a blue flag with a white cross, on the centre of which the royal arms are imposed. The cross is exactly similar to that in the Danish flag, that is to say, the arms of the cross are not of equal length, the shorter end being in the hoist of the flag.

The very simple flag of Switzerland is one of great antiquity, for it was the emblem of the nation as far back as 1339, and probably considerably earlier. In addition to the national flag of the Swiss confederation, each canton has its own cantonal colours. In each case the flag has its stripes disposed horizontally. Basel, for instance, is half black, half white; Berne, half black, half red; Glarus, red, black and white, &c., &c.

The Turkish crescent moon and star were the device adopted by Mahomet II. when he captured Constantinople in 1453. Originally they were the symbol of Diana, the patroness of Byzantium, and were adopted by the Ottomans as a triumph, for they had always been the special emblem of Constantinople, and even now in Moscow and elsewhere the crescent emblem and the cross may be seen combined in Russian churches, the crescent badge, of course, indicating the Byzantine origin of the Russian church. The symbol originated at the time of the siege of Constantinople by Philip the father of Alexander the Great, when a night attempt of the besiegers to undermine the walls was betrayed by the light of a crescent moon, and in acknowledgment of their escape the Byzantines raised a statue to Diana, and made her badge the symbol of the city. Both the man-of-war and mercantile marine flags are the same, but the imperial standard of the sultan is scarlet, and bears in its centre the device of the reigning sovereign. This device is known as the "Tughra," and consists of the name of the sultan, the title of khan, and the epithet *al-Muzaffar Daima*, which means "the ever victorious." The origin of the "Tughra" is that the sultan Murad I., who was not of scholarly parts, signed a treaty by wetting his open hand with ink, and pressing it on the paper, the first, second and third fingers making smears close together, the thumb and fourth finger leaving marks apart. Within the marks thus made the scribes wrote in the name of Murad, his title, and the epithet above quoted. The "Tughra" dates from the latter part of the 14th century. The smaller characters in the "Tughra" change, of course, on the accession of every fresh sovereign, but the leading form of the device always remains the same, namely, rounded lines to the left denoting the thumb, lines to the right denoting where the little finger made impression, and three upright lines indicating the other fingers.

The Mahomedan states tributary to Turkey also display the crescent and star. Morocco, Muscat and other Arab states where they use an ensign display a red flag, that of the Zanzibar protectorate having the British union in the centre of the red field.

The Persian flag is white with a border, green on the upper edge of the flag and in the fly, and red in the hoist and on the lower edge. On the white ground are the lion and sun.

The flag of Siam is a white elephant on a red ground. That of

Korea, a white flag with, in the centre, a ball, half red, half blue, the colours being curiously intermixed, the whole being precisely as if two large commas of equal size, one red and the other blue, were united to form a complete circle.

The Chinese flag is a yellow one, bearing on it the emblem of the dragon devouring the sun. As at present used, it is a square flag, but an earlier version was a triangular right-angled flag, hoisted with the right-angle in the base of the hoist. The merchant flag is red with a yellow ball in the centre.

Among the South American republics the Brazilian flag is peculiar inasmuch as it is the only national flag which carries a motto.

Mexico flies precisely the same tricolour as Italy, but plain in the case of the merchant ensign, and charged on the central stripe with the Mexican arms (as illustrated) when flown as a man-of-war ensign.

The Argentine flag is as illustrated flown by the navy, but, when used by the mercantile marine, the sun emblazoned on the central white stripe is omitted, the flag otherwise being precisely the same.

The Venezuelan flag shown is also that of the navy. The flag of the mercantile marine is the same, but the shield bearing the arms of the state is not introduced into the yellow top stripe in the corner near the hoist, as in the naval flag.

The Chilean ensign illustrated is used alike by men-of-war and vessels in the mercantile marine, but, when flown as the standard of the president, the Chilean arms and supporters are placed in the centre of the flag.

The plain red, white, red in vertical stripes, is the flag of the mercantile marine of Peru, and becomes the naval ensign when charged on the central stripe with the Peruvian arms as shown in our illustration. In fact, in nearly every case with the South American republics, the ordinary mercantile marine flag becomes that of the war navy by the addition of the national arms, and in some cases is used in the same way as a presidential flag.

In nearly every case the flags of the lesser American republics are tricolours, and in a very great many of them the flags are by no means such combinations as would meet with the approval of European heralds. All flag devising should be in accordance with heraldic laws, and one of the most important of these is that colour should not be placed on colour, nor metal on metal, yellow in blazonry being the equivalent of gold and white of silver. Hence, properly devised tricolours are such as, for example, those of France, where the red and blue are divided by white, or Belgium, where the black and red are divided by yellow. On the other hand, the yellow, blue, red of Venezuela is heraldically an abomination.

Manufacture and Miscellaneous Uses.—Flags, the manufacture of which is quite a large industry, are almost invariably made from bunting, a very light, tough and durable woollen material. The regulation bunting as used in the navy is made in 9 in. widths, and the flag classes in size according to the number of breadths of bunting of which it is composed. The great centre of the manufacture of flags, as far as the royal navy is concerned, is the dockyard at Chatham. Ensigns and Jacks are made in different sizes; the largest ensign made is 33 ft. long by 16½ ft. in width; the largest Jack issued is 24 ft. long and 12 ft. wide.

The dimensions of a flag according to heraldry should be either square or in the proportion of two to one, and it is this latter dimension that is used in the navy and generally.

Signalling flags are dealt with elsewhere (see SIGNAL), and here it will only be necessary to make brief allusion to some international customs with regard to the use of flags to indicate certain purposes. For long a blood-red flag has always been used as a symbol of mutiny or of revolution. The black flag was in days gone by the symbol of the pirate; to-day, in the only case in which it survives, it is flown after an execution to indicate that the requirements of the law have been duly carried out. All over the world a yellow flag is the signal of infectious illness. A ship hoists it to denote that there are some on board suffering from yellow fever, cholera or some such infectious malady, and it remains hoisted until she has received quarantine. This flag is also hoisted on quarantine stations. The white flag is universally used as a flag of truce.

At the sea striking of the flag denotes surrender. When the flag of one country is placed over that of another the victory of the former is denoted, hence in time of peace it would be an insult to hoist the flag of one friendly nation above that of another. If such were done by mistake, say in "dressing ship" for instance, an apology would have to be made. This custom of hoisting the flag of the vanquished beneath that of the victor is of comparatively modern date, as up to about a century ago the sign of victory was to trail the enemy's flag over the taffrail in the water.

Each national flag must be flown from its own flagstaff, and this is often seen when the allied forces of two or more powers are in joint occupation of a town or territory. To denote honour and respect a flag is "dipped." Ships at sea salute each other by "dipping" the flag, that is to say, by running it smartly down from the masthead, and then as quickly replacing it. When troops parade before the sovereign the regimental flags are lowered as they salute him. A flag flying half-mast high is the universal symbol of mourning. When a ship has to make the signal of distress, this is done by hoisting the national ensign reversed, that is to say, upside down. If it is wished to accentuate the imminence of the danger it is done by making the flag into a "weft," that is, by knotting it in the middle. This means of showing distress at sea is of very ancient usage, for in naval works written as far back as the reign of James I. we find the "weft" mentioned as a method of showing distress.

We have already alluded to the Union Jack as used for denoting nationality, and as a flag of command, but it also serves many other purposes. For instance, if a court-martial is being held on board any ship the Union Jack is displayed while the court is sitting, its hoisting being accompanied by the firing of a gun. In a fleet in company the ship that has the guard for the day flies it. With a white border it forms the signal for a pilot, and in this case is known as a Pilot Jack. In all combinations of signalling flags which denote a ship's name the Union Jack forms a unit. Lastly, it figures as the pall of every sailor or soldier of the empire who receives naval or military honours at his funeral.

BIBLIOGRAPHY.—See *Flags: Some Account of their History and Uses*, by A. MacGeorge (1881); *National Banners: Their History and Construction*, by W. Bland (1892) (one of a series of Heraldic Tracts, 1850-1892, Br. Museum Library, No. 9906, b. 9; this pamphlet gives the design of the national banners of St George, St Andrew and St Patrick, and illustrates and tells the story of the composition of the three flags into the great union flag, commonly known as the Union Jack); *Our Flags: Their Origin, Use and Traditions*, by Rear-Admiral S. Eardley-Wilmot (1901), an excellent treatise, historical and narrative, on all the flags of the British empire; *A History of the Flag of the United States* (Boston, 1872), by G. H. Preble; *Flags of the World: Their History, Blazonry and Associations*, by Edward Hulme, F.L.S., F.S.A. (1897), a most complete monograph on the subject, illustrated with a very complete series of plates; *Admiralty Book of Flags of all Nations*, printed for H.M. Stationery office, 1889, kept up to date by the publication periodically of *Errata*, officially issued under an admiralty covering letter; *Flags of Maritime Nations*, prepared by the Bureau of Equipment department of the navy, printed by authority (Washington, 1899). The last two works have no letterpress beyond titles, but contain, to scale, delineations of all the flags at present used officially by all nations. Between the two there are no discrepancies, and the delineation of a flag taken from either may be assumed as absolutely correct. Both are respectively the guides for flag construction in the royal navy and the United States navy. (H. L. S.)

FLAGELLANTS (from Lat. *flagellare*, to whip), in religion, the name given to those who scourge themselves, or are scourged, by way of discipline or penance. Voluntary flagellation, as a form of exalted devotion, occurs in almost all religions. According to Herodotus (ii. 40. 61), it was the custom of the ancient Egyptians to heat themselves during the annual festival in honour of their goddess Isis. In Sparta children were flogged before the altar of Artemis Orthia till the blood flowed (Plutarch, *Instil. Laced.* 40). At Alea, in the Peloponnese, women were flogged in the temple of Dionysus (Pausanias, *Arcad.* 23). The priests of Cybele, or *archigalli*, submitted to the discipline in the temple of the goddess (Plutarch, *Adv. Colot.* p. 1127; Apul., *Melam.* viii. 173). At the Roman Lupercalia women were flogged by the celebrants to avert sterility or as a purificatory ceremony (W. Mannhardt, *Mythol. Forsch.*, Strassburg, 1884, p. 72 seq.).

Ritual flagellation existed among the Jews, and, according to Buxtorf (*Synagoga judaica*, Basel, 1603), was one of the ceremonies of the day of the Great Pardon. In the Christian church flagellation was originally a punishment, and was practised not only by parents and schoolmasters, but also by bishops, who thus corrected offending priests and monks (St Augustine, *Ep. 159 ad Marcell.*; cf. *Conc. Agd.* 506, can. ii.).

Gradually, however, voluntary flagellation appeared in the *libri poenitentiales* as a very efficacious means of penance. In the 11th century this new form of devotion was extolled by some of the most ardent reformers in the monastic houses of the west, such as Abbot Popon of Stavelot, St Dominic Loricatus (so called from his practice of wearing next his skin an iron *lorica*, or cuirass of thongs), and especially Cardinal Pietro Damiani. Damiani advocated the substitution of flagellation for the recitation of the penitential psalms, and drew up a scale according to which 1000 strokes were equivalent to ten psalms, and 15,000 to the whole psalter. The majority of these reformers exemplified their preaching in their own persons, and St Dominic gained great renown by inflicting upon himself 300,000 strokes in six days. The custom of collective flagellation was introduced into the monastic houses, the ceremony taking place every Friday after confession.

The early Franciscans flagellated themselves with characteristic rigour, and it is no matter of surprise to find the Franciscan, St Anthony of Padua, preaching the praises of this means of penance. It is incorrect, however, to suppose that St Anthony took any part in the creation of the flagellant fraternities, which were the result of spontaneous popular movements, and later than the great Franciscan preacher; while Ranieri, a monk of Perugia, to whom the foundation of these strange communities has been attributed, was merely the leader of the flagellant brotherhood in that region. About 1259 these fraternities were distributed over the greater part of northern Italy. The contagion spread very rapidly, extending as far as the Rhine provinces, and, across Germany, into Bohemia. Day and night, long processions of all classes and ages, headed by priests carrying crosses and banners, perambulated the streets in double file, reciting prayers and drawing the blood from their bodies with leathern thongs. The magistrates in some of the Italian towns, and especially Uberto Pallavicino at Milan, expelled the flagellants with threats, and for a time the sect disappeared. The disorders of the 14th century, however, the numerous earthquakes, and the Black Death, which had spread over the greater part of Europe, produced a condition of ferment and mystic fever which was very favourable to a recrudescence of morbid forms of devotion. The flagellants reappeared, and made the state of religious trouble in Germany, provoked by the struggle between the papacy and Louis of Bavaria, subserve their cause. In the spring of 1349 bands of flagellants, perhaps from Hungary, began their propaganda in the south of Germany. Each band was under the command of a leader, who was assisted by two lieutenants; and obedience to the leader was enjoined upon every member on entering the brotherhood. The flagellants paid for their own personal maintenance, but were allowed to accept board and lodging, if offered. The penance lasted 33½ days, during which they flogged themselves with thongs fitted with four iron points. They read letters which they said had fallen from heaven, and which threatened the earth with terrible punishments if men refused to adopt the mode of penance taught by the flagellants. On several occasions they incited the populations of the towns through which they passed against the Jews, and also against the monks who opposed their propaganda. Many towns shut their gates upon them; but, in spite of discouragement, they spread from Poland to the Rhine, and penetrated as far as Holland and Flanders. Finally, a band of 100 marched from Basel to Avignon to the court of Pope Clement VI., who, in spite of the sympathy shown them by several of his cardinals, condemned the sect as constituting a menace to the priesthood. On the 20th of October 1349 Clement published a bull commanding the bishops and inquisitors to stamp out the growing heresy, and in pursuance of the pope's orders numbers of the sectaries perished at the stake or in the cells of the inquisitors and the episcopal justices. In 1389 the leader of a flagellant band in Italy called the *bianchi* was burned by order of the pope, and his following dispersed. In 1417, however, the Spanish Dominican St Vincent Ferrer pleaded the cause of the flagellants with great warmth at the council of Constance, and elicited a severe reply from John Gerson

(*Epistola ad Vincentium*), who declared that the flagellants were showing a tendency to slight the sacramental confession and penance, were refusing to perform the *cultus* of the martyrs venerated by the church, and were even alleging their own superiority to the martyrs.

The justice of Gerson's protest was borne out by events. In Germany, in 1414, there was a recrudescence of the epidemic of flagellation, which then became a clearly-formulated heresy. A certain Conrad Schmidt placed himself at the head of a community of Thuringian flagellants, who took the name of Brethren of the Cross. Schmidt gave himself out as the incarnation of Enoch, and prophesied the approaching fall of the Church of Rome, the overthrow of the ancient sacraments, and the triumph of flagellation as the only road to salvation. Numbers of Beghards joined the Brethren of the Cross, and the two sects were confounded in the rigorous persecution conducted in Germany by the inquisitor Eylard Schöneveld, who almost annihilated the flagellants. This mode of devotion, however, held its ground among the lower ranks of Catholic piety. In the 16th century it subsisted in Italy, Spain and southern France. Henry III. of France met with it in Provence, and attempted to acclimatize it at Paris, where he formed bands divided into various orders, each distinguished by a different colour. The king and his courtiers joined in the processions in the garb of penitents, and scourged themselves with ostentation. The king's encouragement seemed at first to point to a successful revival of flagellation; but the practice disappeared along with the other forms of devotion that had sprung up at the time of the league, and Henry III.'s successor suppressed the Paris brotherhood. Flagellation was occasionally practised as a means of salvation by certain Jansenist convulsionaries in the 18th century, and also, towards the end of the 18th century, by a little Jansenist sect known as the Fareinists, founded by the brothers Bonjour, *curés* of Fareins, near Trévoux (Ain). In 1820 a band of flagellants appeared during a procession at Lisbon; and in the Latin countries, at the season of great festivals, one may still see brotherhoods of penitents flagellating themselves before the assembled faithful.

For an account of flagellation in antiquity see S. Reinach, *Cultes, mythes et religions* (vol. i. pp. 173-183, 1906), which contains a bibliography of the subject. For a bibliography of the practice in medieval times, see M. Röhrich, "Bibliographische Beiträge zur Gesch. der Geissler" in *Briegers Zeitschrift für Kirchengeschichte*, i. 313. (P. A.)

FLAGELLATA, the name given to the Protozoa whose dominant phase is a "flagellula," or cell-body provided with one, few or rarely many long actively vibratile, cytoplasmic processes. Nutrition is variable:—(1) "Holozoic"; food taken in by ingestion, by amoeboid action either unspecialized or at one or more well-defined oral spots, or through an aperture (mouth); (2) "Saprophytic"; food taken in in solution through the general surface of the body; (3) "Holophytic"; food-material formed in the coloured plasm by fixation of carbon from the medium, with liberation of oxygen, in presence of light, as in green plants. Fission in the "active" state occurs and is usually longitudinal. Multiple fission rarely occurs save in a sporocyst, and produces microzoospores, which in some cases may conjugate with others as isogametes or with larger forms (megagametes). "Hypnocysts" to tide over unfavourable conditions are not infrequent, but have no necessary relation to reproduction. Many have a firm pellicle which may form a hard shell: again a distinct cell-wall of chitin or cellulose may be formed: finally, an open cup, "theca," of firm or gelatinous material may be present, with or without a stalk: such a cup and stalk are often found in colonial species, and are subject to much the same conditions as in Infusoria. The nucleus is simple in most cases; but in Haemoflagellates it is connected with a second nucleus, which again is in immediate relation with the motile apparatus; the former is termed the "trophonucleus," the latter the "kineto-nucleus."

As reserves the protoplasm may contain oil, starch, paramylum, leucosin (a substance soluble in water, and of doubtful composition), proteid granules. In the holophytic forms the cytoplasm contains specialized parts of more or less definite form,

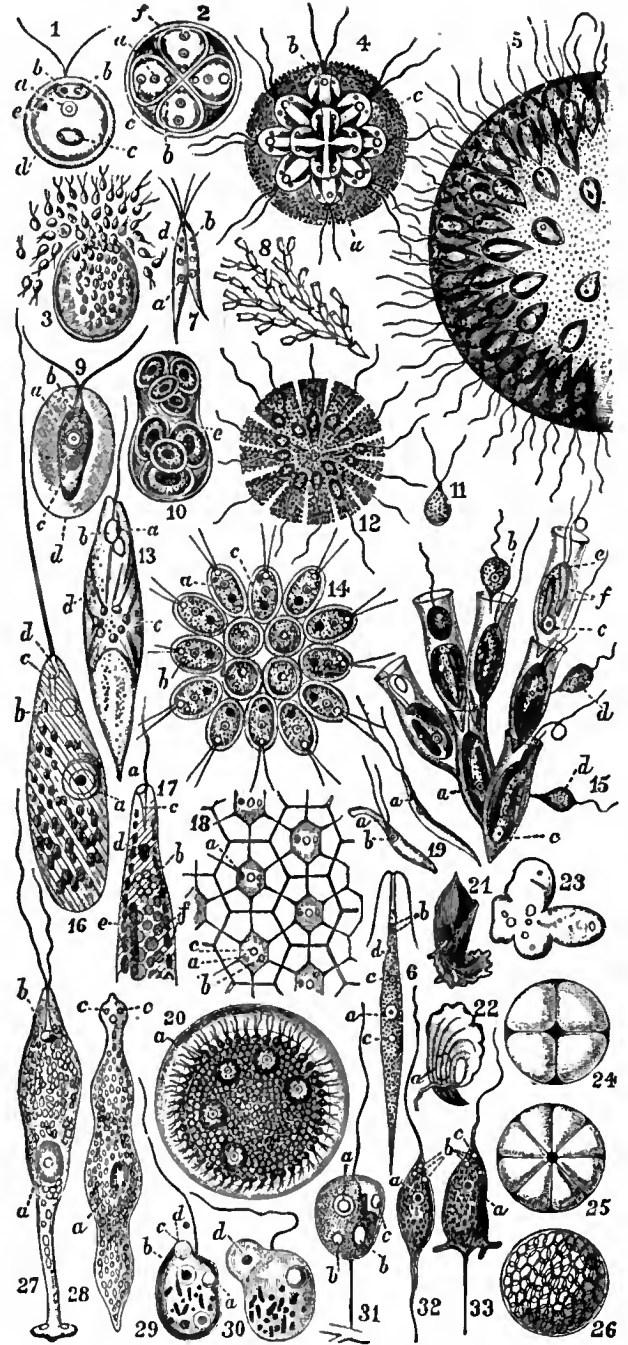

FIG. 1.—Flagellata.

1. *Chlamydomonas pulvisculus*, Ehr. (*Chlamydomonadidae*). Half of a large colony, the flagellates embedded in a common jelly.
a = nucleus.
b = contractile vacuole.
c = starch corpuscle.
d = cellulose investment.
e = stigma (eye-spot).
2. Resting stage of the same, with fourfold division of the cell-contents. Letters as before.
3. Breaking up of the cell-contents into minute biflagellate swarm-spores, which escape, and whose history is not further known.
4. *Syncrypta volvox*, Ehr. (*Chrysomonadidae*). A colony enclosed by a common gelatinous test c.
a = stigma.
b = vacuole (non-contractile).
5. *Uroglena volvox*, Ehr. (*Chrysomonadidae*). Half of a large colony, the flagellates embedded in a common jelly.
a = nucleus.
b = contractile vacuole.
c = starch grain.
d = eye-spot.
6. *Chlorogonium euchlorum*, Ehr. (*Chlamydomonadidae*).
a = nucleus.
b = contractile vacuole.
c = starch grain.
d = eye-spot.
7. *Chlorogonium euchlorum*, Ehr. (*Chlamydomonadidae*). Copulation of two liberated microgonidia.
a = nucleus.
b = contractile vacuole.
d = eye-spot (so-called).
8. Colony of *Dinobryon sertularia*, Ehr.; $\times 200$ (*Chrysomonadidae*).
9. *Haematococcus palustris*, Girod (= *Chlamydococcus*, Braun, *Protococcus*, Cohn), one of the

Chryomonadidae; ordinary individual with widely separated test.

- a = nucleus.
- b = contractile vacuole.
- c = amylo-nucleus (pyrenoid).

10. Dividing resting stage of the same, with eight fission products in the common test e.

11. A microgonidium of the same.

12. *Phalansterium consociatum*, Cienk. (*Choanoflagellata*); $\times 325$. Disk-like colony.

13. *Euglena viridis*, Ehr.; $\times 300$ (*Euglenidae*).

- a = pigment spot (stigma).
- b = clear space.
- c = paramylum granules.
- d = chromatophor (endochrome plate).

14. *Gonium pectorale*, O. F. Müller (*Volvocineae*). Colony seen from the flat side; $\times 300$.

- a = nucleus.
- b = contractile vacuole.
- c = amylo-nucleus.

15. *Dinobryon sertularia*, Ehr. (*Chryomonadidae*).

- a = nucleus.
- b = contractile vacuole.
- c = amylo-nucleus.
- d = free colourless flagellates, probably not belonging to *Dinobryon*.
- e = stigma (eye-spot).
- f = chromatophors.

16. *Peranema trichophorum*, Ehr. (*Peranemidae*), creeping individual seen from the back; $\times 140$.

- c = pharynx.
- d = mouth.

17. Anterior end of *Euglena acus*, Ehr., in profile.

- a = mouth.
- b = vacuoles.
- c = pharynx.
- d = stigma (eye-spot).
- e = paramylum-body.
- f = chlorophyll corpuscles.

18. Part of the surface of a colony of *Volvox globator*, L.

(*Volvocidae*), showing the intercellular connective fibrils.

- a = nucleus.
- b = contractile vacuole.
- c = starch granule.

19. Two microgametes (spermatozoa) of *Volvox globator*, L.

- a = nucleus.
- b = contractile vacuole.

20. Ripe asexually produced daughter-individual of *Volvox minor*, Stein, still enclosed in the cyst of the partheno-gonidium.

- a = young, partheno-gonidia.

21, 22. *Trypanosoma sanguinis*, Gruby (*Haematoflagellates*), from the blood of *Rana esculenta*.

- a = nucleus; $\times 500$.

23-26. Reproduction of *Bodo caudatus*, Duj. (*Bodonidae*), after Dallinger and Drysdale:—23, fusion of several individuals (plasmidium); 24, encysted fusion-product dividing into four; 25, later into eight; 26, cyst filled with swarm-spores.

27. *Distigma proteus*, Ehb., O. F. Müller (*Euglenidae*); $\times 440$. Individual with the two flagella, and strongly contracting hinder region of the body.

28. The same devoid of flagella. c, c = the two dark pigment spots (so-called eyes) near the mouth.

29. *Oicomonas termo* (*Monas termo*) Ehr. (one of the *Oicomonadidae*).

- c = food-ingesting vacuole.
- d = food-particle; $\times 440$.

30. The food-particle d has now been ingested by the vacuole.

31. *Oicomonas mutabilis*, Kent (*Oicomonadidae*), with adherent stalk.

- a = nucleus.
- b = contractile vacuole.
- c = food-particle in food vacuole.

32, 33. *Cercomonas crassicauda*, Duj. (*Oicomonadidae*), showing two conditions of the pseudopodium-protruding tail.

- a = nucleus.
- b = contractile vacuoles.
- c = mouth.

way, and indeed flagella agree with cilia in being mere vibratory extensions of cytoplasm. Symmetrically placed flagella may have a symmetrical reciprocating motion like that of cilia.

Many of the Flagellata are parasitic (some haematozoic); the majority live in the midst of putrefying organic matter in sea and fresh waters, but are not known to be active as agents of putrefaction. Dallinger and Drysdale have shown that the spores of *Bodo* and others will survive an exposure to a higher temperature than do any known Schizomycetes (Bacteria), viz. 250° to 300° Fahr., for ten minutes, although the adults are killed at 180°.

The Flagellata are for the most part very minute; the Protomastigopoda rarely exceeding 20 μ in length. The Euglenaceae contain the largest species, up to 130 μ in length, exclusive of the flagellum.

Our classification is modified from those of Senn (in Engler and Prantl, *Pflanzenfamilien*) and Hartog (in *Cambridge Natural History*).

I. RHIZOFLAGELLATA (PANTOSTOMATA)

Food taken in by pseudopodia at any part of the body. Order 1.—**HOLOMASTIGACEAE**. Body homaxial with uniform flagella. *Multicilia* (Cienkowski); *Grassia* (Fisch, in frog's blood and gastric mucus).

Order 2.—**RHIZOMASTIGACEAE**. Flagellum 1, 2 or few, diverging from anterior end. *Mastigamoeba* (F. E. Schulze).

II. EUFLAGELLATA

Food taken in at one or more definite mouth-spots, or by a true mouth, or by absorption; or nutrition holophytic.

Order 1.—**PROTOMASTIGACEAE**. Contractile vacuoles simple, one or more, or absent; either holozoic, ingesting food by a mouth-spot (or 2 or more), saprophytic, or parasitic.

Family 1.—**OICOMONADIDAE**. Flagellum 1, sometimes with a tail-like posterior prominence passing into a temporary flagellum, but without other cytoplasmic processes. *Oicomonas* (Kent); *Cercomonas* (Dujardin) (fig. 1, 32, 33); *Codonoeca* (James-Clark), with a gelatinous theca.

Family 2.—**BICOECIDAE**. Differs from *Oicomonadidae* in a unilateral proboscisiform process next the flagellum; often thecate and stalked, forming branched colonies, like *Choanoflagellates* in habit. *Bicoeca* (J.-Cl.), *Poteriodendron*.

Family 3.—**CHOANOFAGELLIDAE** (*Choanoflagellata*, Kent; *Craspedomonadina*, Stein). As in previous families, but with flagellum surrounded by an obconical or cylindrical rim of cytoplasm, at the base of which is the ingestive area. The cells of this group have the morphology of the flagellate cells (choanocytes) of sponges. They are often colonial, and in the gelatinous colony of *Proterospongia*, the more internal cells (fig. 2, 15) pass into a definite "reproductive state." Many stalked forms are epizoic on Entomostracan Crustacea.

(a) Naked forms often stalked: *Monosiga* (Kent), stalked solitary; *Codosiga* (Kent) (fig. 2, 3), stalked social; *Desmarella* (Kent), unstalked, and *Astrosiga* (Kent), stalked, form floating colonies.

(b) Forms enclosed in a vase-like shell: *Salpingoeca* (J.-Cl.); (fig. 2, 1, 6, 7) recalling the habit of *Monosiga* and *Cod sig*a; *Polyoeca* forming a branched free swimming colony.

(c) Forms surrounded by a gelatinous sheath: *Proterospongia* (Kent) (fig. 2, 15); *Phalansterium* (Cienk.) (fig. 1, 12), has a slender cylindrical collar, and a branching tubular stalk.

Family 4.—**HAEMOFLAGELLIDAE**. Forms with a complex nuclear apparatus, and a muscular undulating membrane with which one or two flagella are connected, parasitic in Metazoa (often in the blood). *Trypanosoma* (Gruby) (fig. 1, 21, 22), *Herpetomonas* (Kent), *Treponema* (Vuillemin) (= *Spirochaete*, auctt., nec. Ehrbg.).

Family 5.—**AMPHIMONADIDAE**. Flagella 2 anterior, both directed forward, equal and similar; in stalk sheath, &c., often recalling *Choanoflagellata*, *Amphimonas* (Kent), *Diplomitus* (Kent); *Spongomonas* (St.), with thick branching gelatinous sheath.

Family 6.—**MONADIDAE**. Flagella 2 (3), anterior all directed forwards, one long the other (or 2) accessory, short.

Monas (St.); *Anthophysa* (Bory) (fig. 2, 12, 13), with the stalk composed of the accumulation of faeces at the hinder end of the cells of the colony.

Family 7.—**BODONIDAE**. Flagella 2 (or 3) 1 anterior, the other (1 or 2) antero-lateral and trailing or becoming fixed at the end to form a temporary anchor.

Bodo (Ehrb.) (figs. 1, 23-26 and 2, 10). *B. lens* is the "hooked" and *B. saltans* the "springing monad" of Dallinger and Drysdale; *Dallingeria* (Kent) with a pair of

known generally as "plastids" or "chromatophores" impregnated with a lipochrome pigment, whether green (chlorophyll), yellow or brown (diatomin or some allied pigment), or again red (chlorophyll with phycoerythrin). In the active condition of such coloured holophytic forms there is usually at least one anterior "eye-spot," of a refractive globule embedded behind in a collection of red pigment granules. The single anterior "flagellum tractellum" of so many of the larger forms acts by the bending over of its free end in consecutive meridians, so as to describe a hollow cone with its apex backwards: we may imitate this by bending the head of a slender sapling round and round while it is implanted in the soil; and the result is to push the water backwards, or in other words to pull the body forwards, the whole rotating on its longitudinal axis as it moves on (Y. Delage). An anterior lateral trailing flagellum may modify this axial rotation, and help in steering. When the animal is at rest—attached by its base or with its body so curved as to resist onward motion—the current produced by the tractellum will bring suspended particles up against the protoplasm at its base of insertion. As noted by E. R. Lankester, the posterior flagellum of many *Haemoflagellates*, like that of the spermatozoon of Metazoa, propels the cell by a sculling motion behind; he terms it a "pulsellum." Such flagellar motion is distinct from that of cilia, which always move backwards and forwards, with a swift downstroke and a slower recovery in the same plane; though where the flagella are numerous they may behave in this

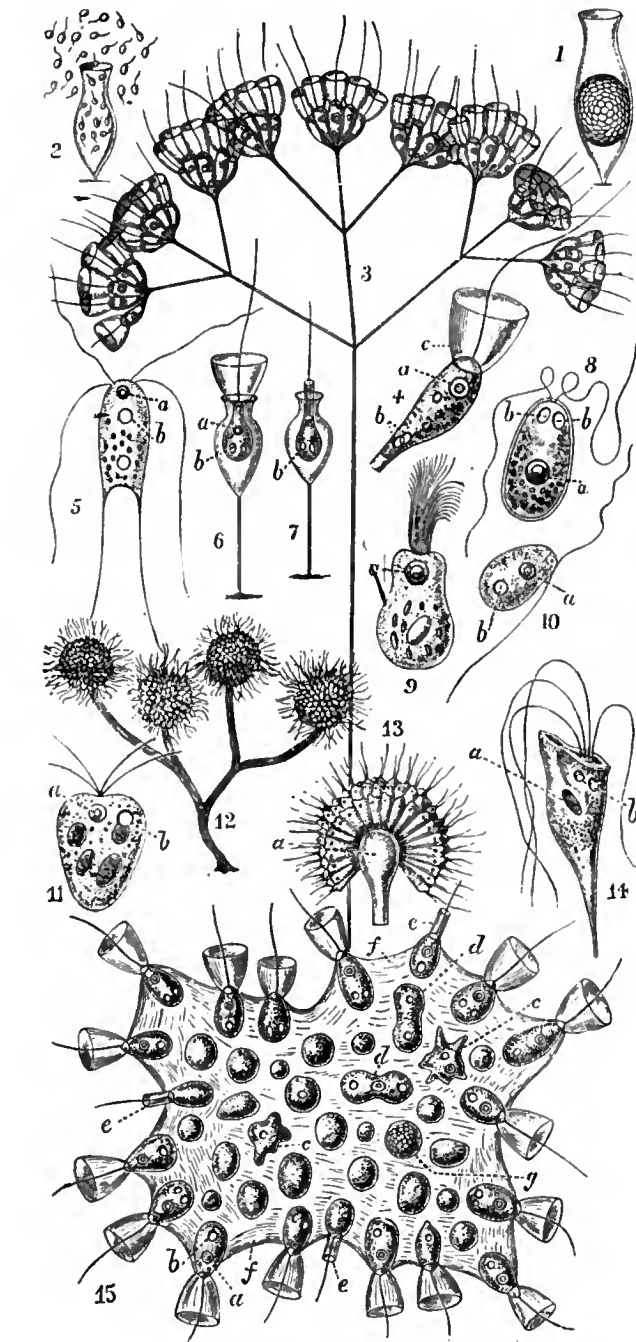

FIG. 2.—Flagellata.

1. *Salpingoeca fusiformis*, S. Kent (Choanoflagellata). The protoplasmic body is drawn together within the goblet-shaped shell, and divided into numerous spores; $\times 1500$.
 2. Escape of the spores of the same as monoflagellate and swarm-spores.
 3. *Codosiga umbellata*, Tatem (Choanoflagellata); adult colony formed by dichotomous growth; $\times 625$.
 4. A single zooid of the same; $\times 1250$.
 a = nucleus.
 b = contractile vacuole.
 c = the characteristic "collar" of naked streaming protoplasm.
 5. *Hexamita inflata*, Duj. (Distomatidae); $\times 650$; normal adult.

6, 7. *Salpingoeca urceolata*, S. Kent (Choanoflagellata):—6, with collar extended; 7, with collar retracted within the stalked cup.
 8. *Polytoma uella*, Müll. sp. (*Chlamydomonadidae*); $\times 800$.
 9. *Lophomonas blattarum*, Stein (*Trichonymphidae*) from the intestine of *Blatia orientalis*.
 10. *Bodo lens*, Müll.; $\times 800$. (*Bodoniidae*), the wavy filament is a tractellum, the straight one is a trailing thread.
 11. *Tetramitus sulcatus*, Stein (*Tetramitidae*); $\times 430$.
 12. *Anthophysa vegetans*, O. F. Müller (*Monadidae*); $\times 300$. A typical, erect, shortly-branched colony stock with four terminal monad-clusters.
 13. Monad cluster of the same in optical section ($\times 800$), show-

ing the relation of the individual monads or flagellate zooids to the stem d.

14. *Tetramitus rostratus*, Perty (*Tetramitidae*); $\times 1000$.
 a = nucleus.
 b = contractile vacuole.
 15. *Proterospongia Haeckeli*, Saville Kent (Choanoflagellata); $\times 800$. A social colony of about forty flagellate zooids.
 a = nucleus.
 b = contractile vacuole.
 c = amoebiform cell sunk

within the colonial gelatinous test compared by S. Kent to a mesoderm cell of the sponges.
 d = similar cell reproducing by transverse fission.
 e = normal cells, with their collars contracted.
 f = substance of test.
 g = individual reproducing by multiple fission, producing microzoospores, comparable to the spermatozoa of sponges.

antero-lateral flagella; *Costia necatrix* (Leclercq) is also 3-flagellate; causes destructive epidemics in fish-hatcheries.
 Family 8.—TETRAMITIDAE. Body pyriform, the pointed end posterior; flagella 4 anterior.

Tetramitus (Perty) (*T. calycinus* of Kent, fig. 2, 11, 14), is the "calycine monad" of Dallinger and Drysdale; *Trichomonas*, Donné, possesses a longitudinal undulating membrane, and is an innocuous human parasite; it is possibly related to Haemoflagellates on one hand and to *Trichonymphidae* on the other.

Family 9.—DISTOMATIDAE. Mouth-spots two, or one, with a distinct construction; flagella symmetrically arranged; nucleus bilobed or geminate. *Hexamitus* (Duj.) (fig. 2, 5), saprophytic and parasitic; *Trepomonas* (Duj.), freshwater; *Megastoma* (Grassi) (= *Lambia* of Blanchard), with constricted mouth-spot and blepharoplast (kinetoneucleus) parasitic in the small intestine of Mammals, including Man.

Family 10.—TRICHONYMPHIDAE. Flagella numerous, sometimes accompanied by one or more undulating membranes; cytoplasm highly differentiated; contractile vacuole absent; all parasitic in insects (all except *Lophomonas* in Termites—the so-called White Ants.)

Lophomonas (St.) (fig. 2, 9); parasitic in the cockroach; *Dinenympha* (Leidy), *Pyrsonympha* (Leidy); *Trichonympha* (Leidy) (fig. 3, 1).

Family 11.—OPALINIDAE. Flagella short, numerous, uniformly distributed over the flat oval body; nuclei small, numerous, uniform.

Only genus, *Opalina* (Purkinje and Valentin) (fig. 3, 2-6), in bladder and cloaca of the frog (usually regarded as an aberrant ciliate, but E. R. Lankester expressed doubts as to its position in the 9th edition of this encyclopaedia).

Order 2.—CHRYSOMONADACEAE. Contractile vacuole simple (in fresh-water forms) or absent; plastids yellow or brown always present; reserves fat.

Family 1.—CHRYSOMONADIDAE. Body naked, often amoeboid in active state, or sometimes with a cup-like theca, a gelatinous investment, a firm cuticle, or silicified shell; reserves fat or leucosin (starch in *Zooxanthella*); eye-spot present. *Chromulina* (Cienk.) often forms a golden scum on tanks; *Chrysamoeba* (Klebs); *Hydrurus* (Agardh), theca of colony

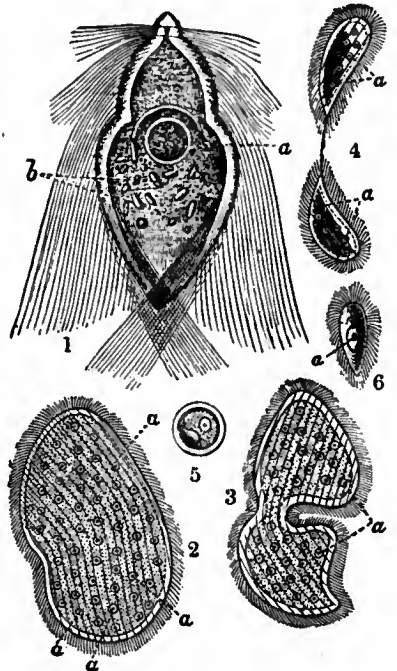

FIG. 3.

1. *Trichonympha agilis*, Leidy, from gut of White Ant (Termite); $\times 600$.
 2. *Opalina ranarum*, Purkinje parasitic in frog rectum multinucleate adult; $\times 100$.
 3, 4. Binary fissions of same, 1-nucleate individual at final stage of fission.
 5. Same encysted dejected from rectum to be swallowed by tadpole.
 6. Young 1-nucleate individual emerged from cyst, destined to grow, proliferating its nuclei to adult form.
 a = nucleus.
 b = food (?) particles in fig. 1.

forming branching tubes, simulating a yellow *Conferva* in mountain torrents; *Dinobryon* (Ehrb.) (fig. 1, 8, 15); *Stylochrysalis* (St.); *Uroglena* (Ehrb.); *Syncrypta* (Ehrb.), and *Synura* (Ehrb.) (fig. 1, 5) form floating spherical colonies; *Zooxanthella* (Brandt), symbiotic as "yellow cells" in *Radiolaria Foraminifera*, *Millepora*, and many Actinozoa.

Family 2.—**COCCOLITHOPHORIDAE**. Body invested in a spherical test strengthened by calcareous elements, tangential circular plates, "coccoliths," "discoliths," "cyatholiths," or radiating rods "rhabdoliths." These are often found in Foraminiferal ooze and its fossil condition, chalk; when coherent as in the complete test, they are known as "coccospheres" and "rhabdospheres." *Coccolithophora* (Lohmann), *Rhabdosphaera* (Haeckel).

Order 3.—**CRYPTOMONADACEAE**. Contractile vacuole (in freshwater forms) simple; plastids green, more rarely red, brown or absent; reserves starch; holophytic or saprophytic. *Cryptomonas* (Ehrb.); *Paramoeba* (Greeff) has yellow plastids and shows two cycles, in the one amoeboid, finally encysting to produce a brood of flagellulae; in the other flagellate, and multiplying by longitudinal fission (it differs from *Mastigamoeba* in possessing no flagellum in the amoeboid state, though it takes in food amoeba-fashion); *Chilomonas* (Ehrb.).

Order 4.—**CHLOROMONADACEAE**. Contractile vacuoles 1-3, a complex of variable arrangement; pellicle delicate; plastids discoid chlorophyll-bodies; reserves oil; eye-spot absent even in active state; holophytic or saprophytic, though with an anterior blind tubular depression simulating a pharynx. *Coelomonas* (St.), *Vacuolaria* (Cienk.).

Order 5.—**EUGLENACEAE**. Vacuole large, a reservoir for one or more accessory vacuoles, contractile and opening to the surface by a canal ("pharynx") in which are planted one or two strong flagella; pellicle strong often striated; nucleus large, chromatophores green, complex or absent; reserves paramylum granules of definite shape, and oil; nutrition variable; body stiff or "metabolic," never amoeboid. Among the true Flagellates these are the largest, few being below 40 μ and several attaining 130 μ in length of cell-body (excluding flagellum). Encysted condition common; the green forms sometimes multiply in this state and simulate unicellular Algae.

Family 1.—**EUGLENIDAE**. Radial (monaxial) forms; nutrition saprophytic or holophytic, mostly one flagellate. (1) Chromatophore large; eye-spot conspicuous. *Euglena* (Ehrb.) (fig. 1, 13, 17), with flexible cuticle and metabolic movements (this is probably Priestley's "green matter" through which he obtained oxygen gas)—a very common genus; *Colacium* (Ehbg.), in its resting state epizooic on Copepoda, which it colours green; *Eutreptia* (Perty), biflagellate; *Ascoglena* (St.); *Trachelomonas* (Ehrb.), with a hard brown cuticle; *Phacus* (Nitzsche), with a firm rigid pellicle, often symmetrically flattened; *Cryptoglena* (Ehbg.). (2) Chromatophores absent. *Astasia* (Duj.), body metabolic; *Menoidium* (Perty), body not metabolic, somewhat inflected and crescentic; *Sphenomonas* (Stein), with a short accessory trailing flagellum in front peeled; *Distigma* (Ehbg.) (fig. 1, 27, 28), very metabolic, with two unequal flagella and two dark pigment spots.

Family 2.—**PERANEMIDAE**. Bilaterally symmetrical, often creeping, pharynx highly developed, with a firm rod-like skeleton, sometimes protrusible; nutrition saprophytic and holozoic. *Peranema* (Ehbg.) and *Urceolus* (Mereschowsky), uni-flagellate creeping, very metabolic. *Petalomonas* (St.), uni-flagellate flattened with a deep ventral groove, not metabolic; *Heteronema* (Duj.) and *Tropidoscaphus* (St.), with a small accessory anterior trailing flagellum; *Anisonema* (Duj.) and *Entosiphon* (St.), with the trailing flagellum as long as the tractellum or even much longer.

Order 6.—**VOLVOCACEAE**. Contractile vacuole simple anterior; cell always enclosed in a cellulose wall (sometimes gelatinous) perforated by the two (more rarely four, five) diverging anterior flagella; reserves starch; chlorophyll almost always present, except in *Polytoma*, sometimes masked by a red pigment; nutrition usually holophytic, rarely saprophytic, never holozoic. Brood-division in active state common, radial.

Family 1.—**CHLAMYDOMONADIDAE**. Cell-wall firm not gelatinous, rarely forming colonies. Fore-end of the body with two or four (seldom five) flagella. Almost always green in consequence of the presence of a very large single chromatophore. Generally a delicate shell-like envelope of membranous consistence. 1 to 2 simple contractile vacuoles at the base of the flagella. Usually one eyespeck. Division of the protoplasm within the envelope may produce four, eight or more new individuals. This may occur in the swimming or in a resting stage. Also by more continuous fission microgametes of various sizes are formed. Conjugation is frequent.

Genera.—*Chlorangium* (Stein), lacking green chlorophyll; *Chlorogonium* (Ehr.) (fig. 1, 6, 7); *Polytoma* (Ehr.) (fig. 2, 8);

Chlamydomonas (Ehr.) (fig. 1, 1, 2, 3); *Haematococcus* (Agardh) (= *Chlamydococcus*, A. Braun, Stein); *Protococcus* (Cohn, Huxley and Martin); *Chlamydomonas* (Cienkowski), causes red snow and "bloody rain"; *Carteria* (Diesing), quadri-flagellate; *Spondylomorum* (Ehrb.), forming floating colonies; *Coccomonas* (St.); *Phacotus* (Perty); *Zoochlorella* (Brandt), is the name given to undetermined Chlamydomonads found multiplying in the resting state within and in symbiotic relation to other Protozoa, to the freshwater sponge, *Ephydatia*, *Hydra viridis*, and to the Turbellarian, *Convoluta viridis* (in which last species the active form has been recognized as a *Carteria*).

Family 2.—**VOLVOCIDAE**. Cell-wall gelatinous; always associated in colonies; cells, as in Family 1. The number of individuals united to form a colony varies very much, as does the shape of the colony. Reproduction by the continuous division of all or of only certain individuals of the colony, resulting in the production of a daughter colony (from each such individual). In some, probably in all, at certain times copulation of the individuals of distinct sexual colonies takes place, without or with a differentiation of the colonies and of the copulating cells as male and female. The result of the copulation is a resting zygospore (also called zygote or oosperm or fertilized egg), which after a time develops itself into one or more new colonies.

Genera.—*Gonium* (O. F. Müller) (fig. 1, 14); *Stephanosphaera* (Cohn); *Pandorina* (Bory de Vinc.); *Eudorina* (Ehr.); *Volvox* (Ehr.) (fig. 1, 18, 20).

The sexual reproduction of the colonies of the Volvocaceae is one of the most important phenomena presented by the Protozoa. In some families of Flagellata full-grown individuals become amoeboid, fuse, encyst, and then break up into flagellate spores which develop simply to the parental form (fig. 1, 23 to 26). In the *Chlamydomonadidae* a single adult individual by division produces small individuals, so-called "microgametes." These conjugate with one another or with similar microgametes formed by other adults (as in *Chlorogonium*, fig. 1, 7); or more rarely in certain genera a microgamete conjugates with an ordinary individual megagamete. The result, in either case is a "zygote," a cell formed by fusion of two which divides in the usual way to produce new individuals. The microgamete in this case is the male element and equivalent to a spermatozoon; the megagamete is the female and equivalent to an egg-cell. The zygote is a "fertilized egg," or oosperm. In some colony-building forms we find that only certain cells produce by division microgametes; and, regarding the colony as a multicellular individual, we may consider these cells as testis-cells and their microgametes as spermatozoa.

CYSTOFLAGELLATA (RHYNCHOFLAGELLATA of E. R. Lankester) and **DINOFLAGELLATA** are scarcely more than subdivisions of Flagellata; but, following O. Bütschli, we describe them separately; the three groups being united into his **MASTIGOPHORA**.

Further Remarks on the Flagellates.—Besides the work of special Protozoologists, such as F. Cienkowski, O. Bütschli, F. v. Stein, F. Schaudinn, W. Saville Kent, &c., the Flagellates have been a favourite study with botanists, especially algologists: we may cite N. Pringsheim, F. Cohn, W. C. Williamson, W. Zopf, P. A. Dangeard, G. Klebs, G. Senn, F. Schütt; the reason for this is obvious. They present a wide range of structure, from the simple amoeboid genera to the highly differentiated cells of Euglenaceae, and the complex colonies of *Proterospongia* and *Volvox*. By some they are regarded as the parent-group of the whole of the Protozoa—a position which may perhaps better be assigned to the Proteomyxa; but they seem undoubtedly ancestral to Dinoflagellates and to Cystoflagellates, as well as to Sporozoa, and presumably to Infusoria. Moreover, the only distinction between the *Chlamydomonadidae* and the true green Algae or Chlorophyceae is that when the former divide in the resting condition, or are held together by gelatinization of the older cell-walls (*Palmella* state), they round off and separate, while the latter divide by a "party wall" so as to give rise either to a cylindrical filament when the partitions are parallel and the axis of growth constant (*Conferva* type), or to a plate of tissue when the directions alternate in a plane. The same holds good for the *Chrysomonadaceae* and *Cryptomonadaceae*, so that these little groups are included in all text-books of botany. Again among Fungi, the zoospores of the Zoosporous Phycomycetes (*Chytridiaceae*, *Peronosporaceae*, *Saprolegniaceae*) have the characters of the *Bodonidae*. Thus in two directions the Flagellates lead up to undoubted Plants. Probably also the Chlamydomonads have an ancestral relation to the *Conjugatae* in the widest sense, and the *Chrysomonadaceae* to the *Diatomaceae*; both groups of obscure affinity, since even the reproductive bodies have no special organs of locomotion. For these reasons the Volvocaceae, Chloromonadaceae, Chrysomonadaceae and Cryptomonadaceae have been united as *Phytoflagellates*; and the Euglenaceae might well be added to these. It is easy to understand the relation of the saprophytic and the holophytic Flagellates to true plants. The capacity to absorb nutritive matter in solution (as contrasted with the ingestion of solid matter) renders the encysted condition compatible with active growth, and what in holozoic forms is a true hypnocyte, a state in which all functions are put to sleep, is here only a rest from active locomotion, nutrition being only limited by the supply of nutritive matter from without, and—in the

case of holophytic species—by the illumination: this latter condition naturally limits the possible growth in thickness in holophytes with undifferentiated tissues. The same considerations apply indeed to the larger parasitic organisms among Sporozoa, such as Gregarines and Myxosporidia and Dolichosporidia, which are giants among Protozoa.

LITERATURE.—W. S. Kent, *Manual of the Infusoria*, vol. i. Protozoa (1880-1882); O. Bütschli, *Die Flagellaten* (in Bronn's *Thierreich*, vol. i. Protozoa, 1885); these two works contain full bibliographies of the antecedent authors. See also J. Goroschankin (on Chlamydomonads) in *Bull. Soc. Nat.* (Moscow, iv. v., 1890-1891); G. Klebs, "Flagellatenstudien" in *Zeitsch. Wiss. Zool.* lv. (1892); Doflein, *Protozoen als Krankheitserreger* (1900); Senn, "Flagellaten," in Engler and Prant's *Pflanzenfamilien*, 1 Teil, Abt. 1a (1900); R. Francé, *Der Organismus der Craspedomonaden* (1897); Grassi and Sandias, "Trichonymphidae," in *Quart. J. Micr. Sci.* xxxix.-xl. (1897); Bezenberger, "Opa inidae," in *Arch. Protist.* iii. (1903); Marcus Hartog, "Protozoa," in *Cambridge Nat. Hist.* vol. i. (1906). (M. HA.)

FLAGEOLET, in music, a kind of *flûte-à-bec* with a new fingering, invented in France at the end of the 16th century, and in vogue in England from the end of the 17th to the beginning of the 19th century. The instrument is described and illustrated by Mersenne,¹ who states that the most famous maker and player in his day was Le Vacher. The flageolet differed from the recorder in that it had four finger-holes in front and two thumb-holes at the back instead of seven finger-holes in front and one thumb-hole at the back. This fingering has survived in the French flageolet still used in the provinces of France in small orchestras and for dance music. The arrangement of the holes was as follows: 1, left thumb-hole at the back near mouthpiece; 2 and 3, finger-holes stopped by the left hand; 4, finger-hole stopped by right hand; 5, thumb-hole at the back; 6, hole near the open end. According to Dr Burney (*History of Music*) the flageolet was invented by the Sieur Juvigny, who played it in the *Ballet comique de la Roynne*, 1581. Dr Edward Browne,² writing to his father from Cologne on the 20th of June 1673, relates, "We have with us here one . . . and Mr Hadly upon the flagelet, which instrument he hath so improved as to invent large ones and outgoe in sweetness all the basses whatsoever upon any other instrument." About the same time was published Thomas Greeting's *Pleasant Companion; or New Lessons and Instructions for the Flagelet* (London, 1675 or 1682), a rare book of which the British Museum does not possess a copy. The instrument retained its popularity until the beginning of the 19th century, when Bainbridge constructed double and triple flageolets.³ The three tubes were bored parallel through one piece of wood communicating near the mouthpiece which was common to all three. The lowest notes of the respective

tubes were 

The word flageolet was undoubtedly derived from the medieval Fr. *flajol*, the primitive whistle-pipe. (K. S.)

FLAGSHIP, the vessel in a fleet which carries the flag, the symbol of authority of an admiral.

FLAHAUT DE LA BILLARDERIE, AUGUSTE CHARLES JOSEPH, COMTE DE (1785-1870), French general and statesman, son of Alexandre Sébastien de Flahaut de la Billarderie, comte de Flahaut, beheaded at Arras in February 1793, and his wife Adélaïde Filleul, afterwards Mme de Souza (*q.v.*), was born in Paris on the 21st of April 1785. Charles de Flahaut was generally recognized to be the offspring of his mother's liaison with Talleyrand, with whom he was closely connected throughout his life. His mother took him with her into exile in 1792, and they remained abroad until 1798. He entered the army as a volunteer in 1800, and received his commission after the battle of Marengo. He became aide-de-camp to Murat, and was wounded at the battle of Landbach in 1805. At Warsaw he met Anne Poniatowski, Countess Potocka, with whom he rapidly became intimate. After the battle of Friedland he received the Legion of

Honour, and returned to Paris in 1807. He served in Spain in 1808, and then in Germany. Meanwhile the Countess Potocka had established herself in Paris, but Charles de Flahaut had by this time entered on his liaison with Hortense de Beauharnais, queen of Holland. The birth of their son was registered in Paris on the 21st of October 1811 as Charles Auguste Louis Joseph Demorny, known later as the duc de Morny. Flahaut fought with distinction in the Russian campaign of 1812, and in 1813 became general of brigade, aide-de-camp to the emperor, and, after the battle of Leipzig, general of division. After Napoleon's abdication in 1814 he submitted to the new government, but was placed on the retired list in September. He was assiduous in his attendance on Queen Hortense until the Hundred Days brought him into active service again. A mission to Vienna to secure the return of Marie Louise resulted in failure. He was present at Waterloo, and afterwards sought to place Napoleon II. on the throne. He was saved from exile by Talleyrand's influence, but was placed under police surveillance. Presently he elected to retire to Germany, and thence to England, where he married Margaret, daughter of Admiral George Keith Elphinstone, Lord Keith, and after the latter's death Baroness Keith in her own right. The French ambassador opposed the marriage, and Flahaut resigned his commission. His eldest daughter, Emily Jane, married Henry, 4th marquess of Lansdowne. The Flahauts returned to France in 1827, and in 1830 Louis Philippe gave the count the grade of lieutenant-general and made him a peer of France. He remained intimately associated with Talleyrand's policy, and was, for a short time in 1831, ambassador at Berlin. He was afterwards attached to the household of the duke of Orleans, and in 1841 was sent as ambassador to Vienna, where he remained until 1848, when he was dismissed and retired from the army. After the *coup d'état* of 1851 he was again actively employed, and from 1860 to 1862 was ambassador at the court of St James's. He died on the 1st of September 1870. The comte de Flahaut is perhaps better remembered for his exploits in gallantry, and the elegant manners in which he had been carefully trained by his mother, than for his public services, which were not, however, so inconsiderable as they have sometimes been represented to be.

See A. de Haricourt, *Madame de Souza et sa famille* (1907).

FLAIL (from Lat. *flagellum*, a whip or scourge, but used in the Vulgate in the sense of "flail"; the word appears in Dutch *vlegel*, Ger. *Flegel*, and Fr. *fléau*), a farm hand-implement formerly used for threshing corn. It consists of a short thick club called a "swingle" or "swipple" attached by a rope or leather thong to a wooden handle in such a manner as to enable it to swing freely. The "flail" was a weapon used for military purposes in the middle ages. It was made in the same way as a threshing-flail but much stronger and furnished with iron spikes. It also took the form of a chain with a spiked iron ball at one end swinging free on a wooden or iron handle. This weapon was known as the "morning star" or "holy water sprinkler." During the panic over the Popish plot in England from 1678 to 1681, clubs, known as "Protestant flails," were carried by alarmed Protestants (see GREEN RIBBON CLUB).

FLAMBARD, RANULF, or RALPH (d. 1128), bishop of Durham and chief minister of William Rufus, was the son of a Norman parish priest who belonged to the diocese of Bayeux. Migrating at an early age to England, the young Ranulf entered the chancery of William I. and became conspicuous as a courtier. He was disliked by the barons, who nicknamed him Flambard in reference to his talents as a mischief-maker; but he acquired the reputation of an acute financier and appears to have played an important part in the compilation of the Domesday survey. In that record he is mentioned as a clerk by profession, and as holding land both in Hants and Oxfordshire. Before the death of the old king he became chaplain to Maurice, bishop of London, under whom he had formerly served in the chancery. But early in the next reign Ranulf returned to the royal service. He is usually described as the chaplain of Rufus; he seems in that capacity to have been the head of the chancery and the custodian of the great seal. But he is also called treasurer;

¹ *Harmonie universelle* (Paris, 1636), bk. v. pp. 232-237.

² See Sir Thomas Browne's *Works*, vol. i. p. 206.

³ See Capt. C. R. Day, *Descriptive Catalogue of Musical Instruments* (London, 1801), pp. 18-22 and pl. 4; also *Complete Instructions for the Double Flageolet* (London, 1825); and *The Preceptor, or a Key to the Double Flageolet* (London, 1815).

and there can be no doubt that his services were chiefly of a fiscal character. His name is regularly connected by the chroniclers with the ingenious methods of extortion from which all classes suffered between 1087 and 1100. He profited largely by the tyranny of Rufus, farming for the king a large proportion of the ecclesiastical preferments which were illegally kept vacant, and obtaining for himself the wealthy see of Durham (1099). His fortunes suffered an eclipse upon the accession of Henry I., by whom he was imprisoned in deference to the popular outcry. A bishop, however, was an inconvenient prisoner, and Flambard soon succeeded in effecting his escape from the Tower of London. A popular legend represents the bishop as descending from the window of his cell by a rope which friends had conveyed to him in a cask of wine. He took refuge with Robert Curthose in Normandy and became one of the advisers who pressed the duke to dispute the crown of England with his younger brother; Robert rewarded the bishop by entrusting him with the administration of the see of Lisieux. After the victory of Tinchebrai (1106) the bishop was among the first to make his peace with Henry, and was allowed to return to his English see. At Durham he passed the remainder of his life. His private life was lax; he had at least two sons, for whom he purchased benefices before they had entered on their teens; and scandalous tales are told of the entertainments with which he enlivened his seclusion. But he distinguished himself, even among the bishops of that age, as a builder and a pious founder. He all but completed the cathedral which his predecessor, William of St Carilef, had begun; fortified Durham; built Norham Castle; founded the priory of Mottisfont and endowed the college of Christchurch, Hampshire. As a politician he ended his career with his submission to Henry, who found in Roger of Salisbury a financier not less able and infinitely more acceptable to the nation. Ranulf died on the 5th of September 1128.

See Orderic Vitalis, *Historia ecclesiastica*, vols. iii. and iv. (ed. le Prévost, Paris, 1845); the first continuation of Symeon's *Historia Ecclesiae Dunelmensis* (Rolls ed., 1882); William of Malmesbury in the *Gesta pontificum* (Rolls ed., 1870); and the *Peterborough Chronicle* (Rolls ed., 1861). Of modern writers E. A. Freeman in his *William Rufus* (Oxford, 1882) gives the fullest account. See also T. A. Archer in the *English Historical Review*, ii. p. 103; W. Stubbs's *Constitutional History of England*, vol. i. (Oxford, 1897); J. H. Round's *Feudal England* (London, 1895). (H. W. C. D.)

FLAMBOROUGH HEAD, a promontory on the Yorkshire coast of England, between the Filey and Bridlington bays of the North Sea. It is a lofty chalk headland, and the resistance it offers to the action of the waves may be well judged by contrast with the low coast of Holderness to the south. The cliffs of the Head, however, are pierced with caverns and fringed with rocks of fantastic outline. Remarkable contortion of strata is seen at various points in the chalk. Sea-birds breed abundantly on the cliffs. A lighthouse marks the point, in $54^{\circ} 7' N.$, $0^{\circ} 5' W.$

FLAMBOYANT STYLE, the term given to the phase of Gothic architecture in France which corresponds in period to the Perpendicular style. The word literally means "flowing" or "flaming," in consequence of the resemblance to the curved lines of flame in window tracery. The earliest examples of flowing tracery are found in England in the later phases of the Decorated style, where, in consequence of the omission of the enclosing circles of the tracery, the carrying through of the foliations resulted in a curve of contrary flexure of ogee form and hence the term flowing tracery. In the minster and the church of St Mary at Beverley, dating from 1320 and 1330, are the earliest examples in England; in France its first employment dates from about 1460, and it is now generally agreed that the flamboyant style was introduced from English sources. One of the chief characteristics of the flamboyant style in France is that known as "interpenetration," in which the base mouldings of one shaft are penetrated by those of a second shaft of which the faces are set diagonally. This interpenetration, which was in a sense a *tour de force* of French masons, was carried to such an extent that in a lofty rood-screen the mouldings penetrating the base-mould would be found to be those of a diagonal buttress situated 20 to 30 ft. above it. It was not limited, however, to

internal work; in late 15th and early 16th century ecclesiastical architecture it is found on the façades of some French cathedrals, and often on the outside of chapels added in later times.

FLAME (Lat. *flamma*; the root *flag-* appears in *flagrare*, to burn, blaze, and Gr. *φλέγειν*). There is no strict scientific definition of flame, but for the purpose of this article it will be regarded as a name for gas which is temporarily luminous in consequence of chemical action. It is well known that the luminosity of gases can be induced by the electrical discharge, and with rapidly alternating high-tension discharges in air an oxygen-nitrogen flame is produced which is long and flickering, can be blown out, yields nitrogen peroxide, and is in fact indistinguishable from an ordinary flame except by its electrical mode of maintenance. The term "flame" is also applied to solar protuberances, which, according to the common view, consist of gases whose glow is of a purely thermal origin. Even with the restricted definition given above, difficulties present themselves. It is found, for example, with a hydrogen flame that the luminosity diminishes as the purity of the hydrogen is increased and as the air is freed from dust, and J. S. Stas declared that under the most favourable conditions he was only able, even in a dark room, to localize the flame by feeling for it, an observation consistent with the fact that the line spectrum of the flame lies wholly in the ultra-violet. On the other hand, there are many examples of chemical combination between gases where the attendant radiation is below the pitch of visibility, as in the case of ethylene and chlorine. It will be obvious from these facts that a strict definition of flame is hardly possible. The common distinction between luminous and non-luminous flames is, of course, quite arbitrary, and only corresponds to a rough estimate of the degree of luminosity.

The chemical energy necessary for the production of flame may be liberated during combination or decomposition. A single substance like gun-cotton, which is highly endothermic and gives gaseous products, will produce a bright flame of decomposition if a single piece be heated in an evacuated flask. Combination is the more common case, and this means that we have two separate substances involved. If they be not mixed *en masse* before combination, the one which flows as a current into the other is called conventionally the "combustible," but the simple experiment of burning air in coal gas suffices to show the unreality of this distinction between combustible and supporter of combustion, which, in fact, is only one of the many partial views that are explained and perhaps justified by the dominance of oxygen in terrestrial chemistry.

Although hydrocarbon flames are the commonest and most interesting, it will be well to consider simpler flames first in order to discuss some fundamental problems. In hydrocarbon flames the complexity of the combustible, its susceptibility to change by heating, and the possibilities of fractional oxidation, create special difficulties. In the flame of hydrogen and oxygen or carbon monoxide and oxygen we have simpler conditions, though here, too, things may be by no means so simple as they seem from the equations $2H_2 + O_2 = 2H_2O$ and $2CO + O_2 = 2CO_2$. The influence of water vapour on both these actions is well known, and the molecular transactions may in reality be complicated. We shall, however, assume for the sake of clearness that in these cases we have a simple reaction taking place throughout the mass of flame. There are various ways in which a pair of gases may be burned, and these we shall consider separately. Let us first suppose the two gases to have been mixed *en masse* and a light to be applied to the stationary mixture. If the mixture be made within certain limiting proportions, which vary for each case, a flame spreads from the point where the light is applied, and the flame traverses the mixture. This flame may be very slow in its progress or it may attain a velocity of the order of one or two thousand metres per second. Until comparatively recent times great misunderstanding prevailed on this subject. The slow rate of movement of flame in short lengths of gaseous mixtures was taken to be the velocity of explosion, but more recent researches by M. P. E. Berthelot,

E. Mallard and H. L. le Chatelier and H. B. Dixon have shown that a distinction must be made between the slow *initial rate of inflammation* of gaseous mixtures and the *rapid rate of detonation*, or rate of the *explosive wave*, which in many cases is subsequently set up. We shall here deal only with the slow movements of flame. The development of a flame in such a gaseous mixture requires that a small portion of it should be raised to a temperature called the *temperature of ignition*. Here again considerable misunderstanding has prevailed. The temperature of ignition has often been regarded as the temperature at which chemical combination begins, whereas it is really the temperature at which combination has reached a certain rate. The combination of hydrogen and oxygen begins at temperatures far below that of ignition. It may indeed be supposed that the combination occurs with extreme slowness even at ordinary temperatures, and that as the temperature is raised the velocity of the reaction increases in accordance with the general expression according to which an increase of 10° C. will approximately double the rate. However that may be, it has been proved experimentally by J. H. van't Hoff, Victor Meyer and others that the combination of hydrogen and oxygen proceeds at perceptible rates far below the temperature of ignition. The phenomenon appears to be greatly influenced by the solid surfaces which are present; thus in a plain glass vessel the combination only began to be perceptible at 448° , whilst in a silvered glass vessel it would be detected at 182° C.

The same kind of thing is true for most oxidizable substances, including ordinary combustibles. We must look upon the application of heat to a combustible mixture as resulting in an increase of the rate of combination locally. Let us suppose that we are dealing with a stratum of the mixture in small contiguous sections. If we raise the temperature of the first section a° C., an increased rate of combination is set up. The heat produced by this combination will be dissipated by conduction and radiation, and we will suppose that it does not quite suffice to raise the adjacent section of the mixture to a° C. The combination in that section, therefore, will not be as rapid as in the first one, and so evidently the impulse to combination will go on abating as we pass along the stratum. Suppose now we start again and heat the first section of the mixture to a temperature c° C., such that the rate of combination is very rapid and the heat developed by combination suffices to raise the adjacent section of the mixture to a temperature higher than c° C. The rate of combination will then be greater than in the first section, and the impulse to combination will be intensified in the same way from section to section along the stratum until a maximum temperature is reached. It is obvious that there must be a temperature of b° C. between a° and c° which will satisfy this condition, that the heat which results from the combination stimulated in the first section just suffices to raise the temperature of the second section to b° . This temperature b° is the temperature of ignition of the mixture; so soon as it is attained by a portion of the mixture the combustion becomes self-sustaining and flame spreads through the mixture. Ignition temperature may be defined briefly as the temperature at which the initial loss of heat due to conduction, &c., is equal to the heat evolved in the same time by the chemical reaction (van't Hoff). From the above considerations we see that the temperature of ignition will vary not only when the gases are varied, but when the proportions of the same gases are varied, and also when the pressure is varied. We can see also that outside certain limiting proportions a mixture of gases will have no practicable ignition temperature, that is to say, the cooling effect of the gas which is in excess will carry off so much heat that no attainable initial heating will suffice to set up the transmission of a constant temperature. Thus in the case of hydrogen and air, mixtures containing less than 5 and more than 72% of hydrogen are not inflammable. The theory of ignition temperature enables us to understand why in an explosive mixture a very small electric spark may not suffice to induce explosion. Combination will indeed take place in the path of the spark, but the amount of it is not sufficient to meet the loss of heat by conduction, &c. It

must be added that the theory of ignition temperatures given above does not explain all the observed facts. F. Emich states that the inflammability of gaseous mixtures is not necessarily greatest when the gases are mixed in the proportions theoretically required for complete combination, and the influence of foreign gases does not appear to follow any simple law. The presence of a small quantity of a gas may exercise a profound influence on the ignition temperature as in the case of the addition of ethylene to hydrogen (Sir Edward Frankland), and again when a mixture of methane and air is raised to its ignition temperature a sensible interval (about 10 seconds) elapses before inflammation occurs.

The rate at which a flame will traverse a mixture of two gases which has been ignited depends on the proportions in which the gases are mixed. Fig. 1 (Bunte) represents this relationship for several common gases.

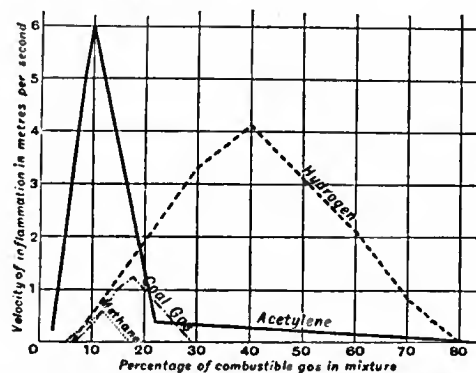

FIG. 1.—Rates of inflammation of combustible gases with air.

If a ready-made gaseous mixture is to be used for the production of a steady flame, it may be forced through a tube and ignited at the end; it is obvious that the velocity of efflux must be greater than the initial rate of inflammation of the mixture, for otherwise the mixture would fire back down the tube. If the velocity of efflux be considerably greater than the rate of inflammation, the flame will be separated from the end of the tube, and only appear as a flickering crown where the velocity and inflammability of the issuing gas have been diminished by admixture with air. With much increased velocity of efflux the flame will be blown out. J. B. A. Dumas used to show the experiment of blowing out a candle with electrolytic gas. A steady flame formed by burning a ready-made gaseous mixture at the end of a tube of circular section has the form shown in fig. 2. The small internal cone marks the lower limiting surface of the flame; it is the locus of all points where the velocity of efflux is just equal to the velocity of inflammation, and its conical form is explained by the fact that the rate of efflux of gas is greatest in the vertical axis of the tube where the flow is not retarded by friction with the walls, as well as by the further fact that the gas issuing from such an orifice spreads outwards, the inflammation proceeding directly against it. The flame, it will be seen, is of considerable thickness. If the gaseous mixture be hydrogen and oxygen, or carbon monoxide and oxygen, it will have no obvious features of structure beyond those shown in the figure; that is to say, the shaded region of burning gas has the appearance of homogeneity and uniform colour which might be expected to accompany a uniform chemical condition. Some admixture of the external air will, of course, take place, especially in the upper parts of the flame, and detectable quantities of oxides of nitrogen may be found in the products of combustion, but this is an inconsiderable feature. The flame just described is essentially that of a blowpipe.



FIG. 2.

A second way of producing a flame is the more common one of allowing one gas to stream into the other. Using the same gases as before, hydrogen or carbon monoxide with oxygen, we find

again that the flame is conical in form and uniform in colour, but in this case, if the velocity of efflux be not immoderate, the burning gas only extends over a comparatively thin shell, limited on the inside by the pure combustible and on the outside by a mixture of the products of combustion with oxygen. The combustible gas has to make its own inflammable mixture with the circumambient oxygen, and we may suppose the column of gas to be burned through as it ascends. The core of unburned gas thus becomes thinner as it ascends and the flame tapers to a point. The external surface of a flame of this kind will for the same consumption of gas be larger than that of a flame where the ready-made mixture of gases is used. If a jet of one gas be sent with a sufficient velocity into another, turbulent admixture takes place and an unsteady sheet of flame of uniform colour is obtained.

A third way of forming a flame is to allow the whole of one gas, mixed with a less quantity of the second than is sufficient for complete combustion, to issue into an atmosphere of the second. This is the case with what are generally known as atmospheric burners, of which the Bunsen burner is the prototype. The development of a flame of this kind can be well studied in the case of carbon monoxide and air. The carbon monoxide is fed into a Bunsen burner with closed air-valve, the burner-tube being prolonged by affixing a glass tube to it by means of a cork. The flame consists of a single conical blue sheet. If now the air-valve be opened very slightly, an internal cone of the same blue colour makes its appearance. The air which has entered through the air-valve ("primary" air) has become mixed with the carbon monoxide and so oxidizes its quota in an internal cone, the rest of the carbon monoxide (diluted now, of course, with carbon dioxide and nitrogen) wandering into the external atmosphere to burn (with "secondary" air) in a second cone. The existence of the internal cone and the subsequent thermal effect lead to slight convexity of surface in the outer cone. If the quantity of primary air be increased more internal combustion can take place. This, however, does not lead to an enlargement of the inner cone, for the increase of air increases the rate of inflammation of the mixture, and the inner cone (which only maintains its stability because the rate of efflux of the mixture is greater than the velocity of inflammation) contracts, and will, as the proportion of primary air is increased, soon evince a tendency to enter the burner-tube. At this stage an interesting phenomenon is to be noticed. When we have reached the point of aeration where the velocity of inflammation of the mixture just surpasses the velocity of efflux, the inner cone enters the burner-tube as a disk and descends, but this downward motion checks the suction flow of air through the valve at the base of the burner, whilst it does not appreciably check the pressure flow of the carbon monoxide through the gas nozzle. The result is that a stratum of gas-mixture poor in air, and therefore of low rate of inflammation, is formed, and when the descending disk of flame meets it, the descent is arrested and the disk returns to the top of the tube, reproducing the inner cone. The full air suction is now restored and the course of events is repeated. This oscillatory action can be maintained almost indefinitely long if the pressure and other conditions be maintained constant. With still more primary air the inner cone of flame simply fires back to the burner nozzle, or, in the last stage, we may have enough air entering to produce a flame of the blast blowpipe type, namely, one where the carbon monoxide mixed with an excess of primary air burns with a single cone in a steady flame.

By means of a simple contrivance devised by A. Smithells a two-coned flame of the kind described may be resolved into its components. The apparatus is like a half-extended telescope made of two glass tubes, and it is evident that the velocity of a mixture of gases flowing through it must be greater in the narrow tube than in the wider one. If the end of the narrower tube be fixed to a Bunsen burner and the flame be formed at the end of the wider one, then when the air-supply is increased to a certain point the inner cone will descend into the wide tube and attach itself to the upper end of the narrower one. This occurs

when the velocity of inflammation is just greater than the upward velocity of the gaseous stream in the wide tube and less than the upward velocity in the narrow tube. If the outer tube be now drawn down, a two-coned flame burns at the end of the inner tube; if the outer tube be slid up again, it detaches the outer cone and carries it upward. This apparatus has been of use in investigating the progress of combustion in various flames.

Temperature of Flames.—The term "flame-temperature" is used very vaguely and has no clear meaning unless qualified by some description. It is at least ambiguous when used in reference to flames where the combining gases are mixed in theoretical proportions before issuing from the burner. The flame in such a case has considerable thickness and uniformity, and, though the temperature is not constant throughout, flames of this type given by different combustibles admit of comparison. In other flames where the shells of combustion are thin and envelop large regions of unburned or partly-burned gas, it is not clear how temperature should be specified. An ordinary gas-flame will not, from the point of view of the practical arts, give a sufficient temperature for melting platinum, yet a very thin platinum wire may be melted at the edge of the lower part of such a flame. The maximum temperature of the flame is therefore not in any serious sense an available temperature. It will suffice to point out here that in order to burn a gas so that it may have the highest available temperature, we must burn it with the smallest external flame-surface obtainable. This is done when the combining gases are completely mixed before issuing from the burner. Where this is impracticable we may employ a burner of the Bunsen type, and arrange matters so that a large amount of primary air is supplied. It is in this direction that modern improvements have been made with a view to obtaining hot flames for heating the Welsbach mantle. The Kern burner, for example, employs the principle of the Venturi tube. Where much primary air is drawn in it is usual to provide for it being well mixed with the gas, otherwise an unsteady flame may be produced with a great tendency to light back. The burner head is therefore usually provided with a mixing chamber and the mixture issues through a slit or a mesh. A great many modified Bunsen burners have been produced, the aim in all of them being to produce a flame which shall combine steadiness with the smallest attainable external surface.

To estimate the temperature of flames several methods have been employed. The method of calculation, based on the supposition that the whole heat of combustion is localized in the product (or products) of combustion and heats it to a temperature depending on its specific heat, cannot be applied in a simple way. Apart from the assumption (which there is reason to suppose incorrect) that none of the chemical energy assumes the radiant form directly, we have to regard the possible change of specific heat at high temperatures, the likelihood of dissociation and the time of reaction. Any practical consideration of temperature must have regard to a large assemblage of molecules and not to a single one, and therefore any influence which means delay in combination will result in reduction of temperature by radiation and conduction. It can hardly be maintained that in the present state of knowledge we have the requisite data for the calculation of flame temperature, though good approximations may be made. Many attempts have been made to determine flame temperatures by means of thermo-electric couples and by radiation pyrometers. The couple most employed is that known as H. L. le Chatelier's, consisting of two wires, one of platinum and the other an alloy of 90% platinum and 10% of rhodium. When all possible precautions are taken it is possible by means of such thermo-couples to measure local flame temperatures with a considerable degree of accuracy. Subjoined are some results obtained at different times and by different observers with regard to the maximum temperatures of flames:—

Coal gas in Bunsen burner	(Waggener, 1896)	1770° C.
" " " "	(Berkenbusch, 1899)	1830°
" " " "	(White & Traver, 1902)	1780°
" " " "	(Féry, 1905)	1871°

The following are given by Féry:—

Acetylene	2548° C.
Alcohol	1705°
Hydrogen (in air)	1900°
Oxy-hydrogen	2420°
Oxy-coal gas blowpipe	2200°

Source of Light in Flames.—We may consider first those flames where solid particles are out of the question; for example, the flame of carbon monoxide in air. The old idea that the luminosity was due to the thermal glow of the highly heated product of combustion has been challenged independently by a number of observers, and the view has been advanced that the emission of light is due to radiation attendant upon a kind of discharge of chemical energy between the reacting molecules. E. Wiedemann proposed the name "chemi-luminescence" for radiation of this kind. The fact is that colourless gases cannot be made to glow by any purely thermal heating at present available, and products of combustion heated to the average temperature of the flames in which they are produced are non-luminous. On the other hand, it must be remembered that in a mass of burning gas only a certain proportion of the molecules are engaged at one instant in the act of chemical combination, and that the energy liberated in such individual transactions, if localized momentarily as heat, would give individual molecules a unique condition of temperature far transcending that of the average, and the distribution of heat in a flame would be very different from that existing in the same mixture of gases heated from an external source to the same average temperature. The view advocated by Smithells is that in the chemical combination of gases the initial phase of the formation of the new molecule is a vibratory one, which directly furnishes light, and that the damping down of this vibration by colliding molecules is the source of that translatory motion which is evinced as heat. This, it will be seen, is an exact reversal of the older view.

The view of Sir H. Davy that "whenever a flame is remarkably brilliant and dense it may always be concluded that some solid matter is produced in it" can be no longer entertained. The flames of phosphorus in oxygen and of carbon disulphide in nitric oxide contain only gaseous products, and Frankland showed that the flames of hydrogen and carbon monoxide became highly luminous under pressure. From his experiments Frankland was led to the generalization that high luminosity of flames is associated with high density of the gases, and he does not draw a distinction in this respect between high density due to high molecular weight and high density due to the close packing of lighter molecules. The increased luminosity of a compressed flame is not difficult to understand from the kinetic theory of gases, but no explanation has appeared of the luminosity considered by Frankland to be due merely to high molecular weight. It is possible that the electron theory may ultimately afford a better understanding of these phenomena.

Structure of Flame.—The vagueness of the term structure, as applied to flames, is to be seen from the very conflicting accounts which are current as to the number of differentiated parts in different flames. Unless this term is restricted to sharp differences in appearance, there is no limit to the number of parts which may be selected for mention. The flame of carbon monoxide, when the gas is not mixed with air before it issues from the burner, shows no clearly differentiated structure, but is a shell of blue luminosity of shaded intensity—a hollow cone if the orifice of the burner be circular and the velocity of the gas not immoderate, or a double sheet of fan shape if the burner have a slit or two inclined pores which cause the jets of issuing gas to spread each other out. Such a flame has but one single distinct feature, and this is not surprising, as there is no reason to suppose that there is any difference in the chemical process or processes that are occurring in different quarters of the flame. The amount of materials undergoing this transformation in different parts of the flame may and does vary; the gases become diluted with products of combustion, and the molecular vibrations gradually die down. These things may cause a variation in the intensity of the light in different quarters, but

the differences induced are not sharp or in any proper sense structural. A flame of this kind may develop a secondary feature of structure. If carbon monoxide be burnt in oxygen which is mixed or combined with another element there may be an additional chemical process that will give light; flames in air are sometimes surrounded by a faintly luminous fringe of a greenish cast, apparently associated with the combination of nitrogen with oxygen (H. B. Dixon). Carbon monoxide on being strongly heated begins to dissociate into carbon and carbon dioxide; if the unburnt carbon monoxide within a flame of that gas were so highly heated by its own burning walls as to reach the temperature of dissociation, we might expect to see a special feature of structure due to the separated carbon. Such a temperature does not, however, appear to be reached.

Apart from hydrocarbon flames not much has been published in reference to the structure of flames. The case of cyanogen is of peculiar interest. The beautiful flame of this gas consists of an almost crimson shell surrounded by a margin of bright blue. Investigations have shown that these two colours correspond to two steps in the progress of the combustion, in the first of which the carbon of the cyanogen is oxidized to carbon monoxide and in the second the carbon monoxide oxidized to carbon dioxide.

The inversion of combustion may bring new features of structure into existence; thus when a jet of cyanogen is burnt in oxygen no solid carbon can be found in the flame, but when a jet of oxygen is burnt in cyanogen solid carbon separates on the edge of the flame.

Hydrocarbon Flames.—As already stated the flames of carbon compounds and especially of hydrocarbons have been much more studied than any other kind, as is natural from their common use and practical importance. The earliest investigations were made with coal gas, vegetable oils and tallow, and the composite and complex nature of these substances led to difficulties and confusion in the interpretation of results. One such difficulty may be illustrated by the fact, often overlooked, that when a mixed gaseous combustible issues into air the individual component gases will separate spontaneously in accordance with their diffusibilities: hydrogen will thus tend to get to the outer edge of a flame and heavy hydrocarbons to lag behind.

The features of structure in a hydrocarbon flame depend of course on the manner in which the air is supplied. The extreme cases are (i.) when the issuing gas is supplied before it leaves the burner with sufficient air for complete combustion, as in the blast blowpipe, in which case we have a sheet of blue undifferentiated flame; and (ii.) when the gas has to find all the air it requires after leaving the burner. The intermediate stage is when the issuing gas is supplied before leaving the burner with a part of the air that is required. In this case a two-coned flame is produced. The general theory of such phenomena has already been discussed. It must be remarked that the transition of one kind of flame into the others can be effected gradually, and this is seen with particular ease and distinctness by burning benzene vapour admixed with gradually increasing quantities of air. The key to the explanation of the structure of an ordinary luminous flame, such as that of a candle, is to be found, according to Smithells, by observing the changes undergone by a well-aerated Bunsen flame as the "primary" air is gradually cut off by closing the air-ports at the base of the burner. It is then seen that the two cones of flame evolve or degenerate into the two recognizable blue parts of an ordinary luminous flame, whilst the appearance of the bright yellow luminous patch becomes increasingly emphasized as a hollow dome lying within the upper part of the blue sheath. There are thus three recognizable features of structure in an ordinary luminous flame, each region being as it were a mere shell and the interior of the flame filled with gas which has not yet entered into active combustion. If, as is suggested, the blue parts of an ordinary luminous flame are the relics of the two cones of a Bunsen flame, the chemistry of a Bunsen flame may be appropriately considered first. What happens chemically when a hydrocarbon is burned in a Bunsen burner? The air sent in with the gas is insufficient for complete

combustion so that the inner cone of the flame may be considered as air burning in an excess of coal gas. What will be the products of this combustion? This question has been answered at different times in very different ways. There are many conceivable answers: part of the hydrocarbon might be wholly oxidized and the rest left unaltered to mix with the outside air and burn as the outer cone; on the other hand, there might be (as has been so commonly assumed) a selective oxidation in the inner cone whereby the hydrogen was fully oxidized and the carbon set free or oxidized to carbon monoxide; or again the carbon might be oxidized to carbon dioxide or monoxide and the hydrogen set free. There might of course be other intermediate kinds of action. Now it is important at this point to insist upon a distinction between what can be found by direct analysis as to the products of partial combustion, and what can be imagined or inferred as the transitory existence of substances of which the products actually found in analysis are the outcome. We shall consider only in the first instance what substances are found by analysis. Earlier experiments on the Bunsen burner in which coal gas was used, and the gases withdrawn directly from the flame by aspiration, gave no very clear results, but the introduction of the cone-separating apparatus and the use of single hydrocarbons led to more definite conclusions. The analysis of the inter-conal gases from an ethylene flame gave the following numbers:—carbon dioxide = 3.6; water = 9.5; carbon monoxide = 15.6; hydrocarbons = 1.3; hydrogen = 9.4; nitrogen = 60.6.

It appears therefore, and it may be stated as a fact, that a considerable amount of hydrogen is left unoxidized, whilst practically all the carbon is converted into monoxide or dioxide. As the gases have cooled down before analysis and as the reaction $\text{CO} + \text{H}_2\text{O} \rightleftharpoons \text{CO}_2 + \text{H}_2$ is reversible, it may be objected that the inter-conal gases may have a composition when they are hot very different from what they show when cold. Experiments made to test this question have not sustained the objection. Subsequent experiments on the oxidation of hydrocarbons have made it appear undesirable to use the expression "preferential combustion" or "selective combustion" in connexion with the facts just stated; but for the purpose of describing in brief the chemistry of a hydrocarbon flame it is necessary to say that in the inner cone of a Bunsen flame hydrogen and carbon monoxide are the result of the limited oxidation, and that the combustion of these gases with the external air generates the outer cone of the flame. As to the actual stages in the limited oxidation of a hydrocarbon a large amount of very valuable work has been carried out by W. A. Bone and his collaborators. Different hydrocarbons mixed with oxygen have been circulated continuously through a vessel heated to various temperatures, beginning with that (about 250° C.) at which the rate of oxidation is easily appreciable. Proceeding in this way, Bone, without effecting a complete transformation of the hydrocarbon into partially oxidized substances, has isolated large quantities of such products, and concludes that the oxidation of a hydrocarbon involves nothing in the nature of a selective or preferential oxidation of either the hydrogen or the carbon. He maintains that it occurs in several well-defined stages during which oxygen enters into and is incorporated with the hydrocarbon molecule, forming oxygenated intermediate products among which are alcohols and aldehydes. The reactions between ethane and ethylene with an equal volume of oxygen would be represented as follows:—

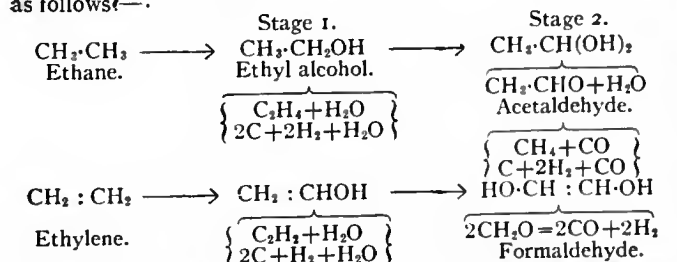

The affinity between the hydrocarbon and oxygen at a high

temperature is so great that, when the supply of oxygen is sufficient to carry the oxidation as far as the second stage, practically no decomposition of the monohydroxy molecule formed in the first stage occurs. This is especially the case with unsaturated hydrocarbons.

As a crucial test decisive against the hypothesis of preferential carbon oxidation, Bone cites the experiment of firing a mixture of equal volumes of ethane and oxygen sealed up in a glass bulb. In such a case a lurid flame fills the vessel, accompanied by a black cloud of carbon particles and considerable condensation of water. About 10% of methane is also found. It is impossible within the limits of this article to give a more extended account of these later researches on the oxidation of hydrocarbons. They make it evident that the relative oxidizability of carbon and hydrogen cannot form the basis of a general theory of the combustion of hydrocarbons, and that both the a priori view that hydrogen is the more oxidizable element, and the inference from the behaviour of ethylene when exploded with its own volume of oxygen, viz. that carbon is the more oxidizable element in hydrocarbons, are not in harmony with experimental facts.

The view that the bright luminosity of hydrocarbon flames is due "to the deposition of solid charcoal" was first put forward by Sir Humphry Davy in 1816. In explaining the origin of this charcoal, Davy used somewhat ambiguous language, stating that it "might be owing to a decomposition of a part of the gas towards the interior of the flame where the air was in smallest quantity." This statement was interpreted commonly as implying that the charcoal became free by the preferential combustion of the hydrogen, and such an interpretation was given explicitly by Faraday. Whatever may have been Davy's view with regard to this part of the theory, his conclusion that finely divided carbon was the cause of luminosity in hydrocarbon flames was not questioned until 1867, when E. Frankland, in connexion with researches already alluded to, maintained that the luminosity of such flames was not due in any important degree to solid particles of carbon, but to the incandescence of dense hydrocarbon vapours. Among the arguments adduced against this view the most decisive is furnished by the optical test first used by J. L. Soret. If the image of the sun be focussed upon the glowing part of a hydrocarbon flame the scattered light is found to be polarized, and it is indisputable that the luminous region is pervaded by a cloud of finely divided solid matter. The quantity of this solid (estimated by H. H. C. Bunte to be 0.1 milligram in a coal-gas flame burning 5 cub. ft. per hour) is sufficient to account for the luminosity, so that Davy's original view may be said to be now universally accepted.

The remaining question with regard to the luminosity of a hydrocarbon flame relates to the manner in which the carbon is set free. The fact that hydrocarbons when strongly heated in absence of air will deposit carbon has long been known and is daily evident in the operation of coal-gas making, when gas carbon accumulates as a hard deposit in the highly-heated crown of the retorts. There is no difficulty in supposing therefore that the carbon in a flame is separated from the hydrocarbon within it by the purely thermal action of the blue burning walls of the flame. Many experiments might be adduced to confirm this view. It is sufficient to name two. If a ring of metal wire be so disposed in a small flame as to make a girdle within the blue walls towards the base, the withdrawal of heat is rapid enough to prevent the maintenance of a temperature sufficient to cause a separation of carbon, and the bright luminosity disappears. Again, if the flame of a Bunsen burner be fed through the air-ports not with air but with some neutral gas such as nitrogen, carbon dioxide or steam, the dilution of the burning gas and the hydrocarbon within it becomes so great that the temperature of separation is not attained, no carbon is separated and the flame consists of a single blue shell.

Whilst it is thus easy to understand generally why carbon becomes separated as a solid within a flame, it is not easy to trace the processes by which the carbon becomes separated in the case of a given hydrocarbon. According to M. P. E. Berthelot, who made prolonged and elaborate researches on the

pyrogenetic relationships of hydrocarbons, these compounds only liberate carbon by a process of the continual coalescence of hydrocarbon molecules with the elimination of hydrogen, until there is left the limiting solid hydrocarbon hardly distinguishable from carbon itself and constituting the glowing soot of flames.

V. B. Lewes, on the other hand, basing his conclusions on a study of the thermal decomposition of hydrocarbons, on temperature measurements of flames and analysis of their gases, has more recently developed a theory of flame luminosity in which the formation and sudden exothermic decomposition of acetylene are regarded as the essential incidents productive of carbon separation and luminosity. Smithells has disputed the evidence on which this theory is based and it appears to have gained no adherence from those who have worked in the same field; but as it has not been formally disavowed by the author and has found its way into some text-books, it is mentioned here.

W. A. Bone and H. F. Coward (*Journ. Chem. Soc.*, 1908) published the results of a very careful study of the decomposition of hydrocarbons when heated in a stationary condition and when continually circulated through hot vessels. Their results disclose once more the great difficulty of tracing the processes of decomposition and of arriving at a generalization of wide applicability, but they appear to be conclusive against the views both of Berthelot and of Lewes.

They do not think that the decomposition of hydrocarbons can be adequately represented by ordinary chemical equations owing to the complexity of the changes which really take place. Methane, which is the most stable of the hydrocarbons, appears to be resolved at high temperatures directly into carbon and hydrogen, but the phenomenon is dependent mainly on surface action; ethane, ethylene and acetylene undergo decomposition throughout the body of the gas (*loc. cit.* p. 1197 et seq.).

"In the cases of ethane and ethylene it may be supposed that the primary effect of high temperature is to cause an elimination of hydrogen with a simultaneous loosening or dissolution of the bond between the carbon atoms, giving rise to (in the event of dissolution) residues such as $:CH_2$ and $:CH$. These residues, which can only have a very fugitive separate existence, may either (a) form $H_2C : CH_2$ and $HC : CH$, as the result of encounters with other similar residues, or (b) break down directly into carbon and hydrogen, or (c) be directly hydrogenized to methane in an atmosphere rich in hydrogen. These three possibilities may all be realized simultaneously in the same decomposing gas in proportions dependent on the temperature, pressure and amount of hydrogen present. The whole process may be represented by the following scheme, the dotted line indicating the tendency to dissolve a bond between the carbon atoms which becomes actually effective at higher temperatures:—

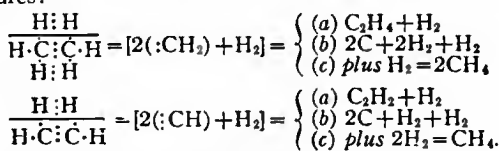

"In the case of acetylene, the main primary change may be either one of polymerization or of dissolution according to the temperature, and if the latter, it may be supposed that the molecule breaks down across the triple bond between the carbon atoms, giving rise to $2(:CH)$, and that these residues are subsequently either resolved into carbon and hydrogen or "hydrogenized" according to circumstances, thus:—

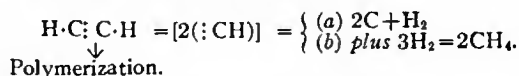

"Acetylene is, moreover, distinguished by its power of polymerization at moderate temperatures so that whether it is the gas initially heated or whether it is a prominent product of the decomposition of another hydrocarbon polymerization will occur to an extent dependent on temperature."

We may describe briefly the view to which we are led as to the genesis of an ordinary luminous hydrocarbon flame:—

The gaseous hydrocarbon issues from the burner or wick, let us suppose, in a cylindrical column. This column is not sharply marked off from the air but is so penetrated by it that we must suppose a gradual transition from the pure hydrocarbon in the centre of column to the pure air on the outside. Let us

take a thin transverse slice of the flame, near the lower part of the wick or close to the burner tube. At what lateral distance from the centre will combustion begin? Clearly, where enough oxygen has penetrated the column to give such partial combustion as takes place in the inner cone of a Bunsen burner. This then defines the blue region. Outside this the combustion of the carbon monoxide, hydrogen and any hydrocarbons which pass from the blue region takes place in a faintly luminous fringe. These two layers form a sheath of active combustion, surrounding and intensely heating the enclosed hydrocarbons in the middle of the column. These heated hydrocarbons rise and are heated to a higher temperature as they ascend. They are accordingly decomposed with separation of carbon in the higher parts of the flame, giving the region of bright yellow luminosity. There remains a central core in which neither is there any oxygen for combustion nor a sufficiently high temperature to cause carbon separation. This constitutes the dark interior region of the flame. We thus account for the different parts of the flame. It is to be noted, however, that the bright blue layer only surrounds the lower part of the flame, whilst the pale, faintly-luminous fringe surrounds the whole flame. The flame also is conical and not cylindrical. The foregoing explanation is therefore not quite complete. Let us suppose that the changes have gone on in the small section of the flame exactly as described and consider how the processes will differ in parts above this section. The central core of unburned gases will pass upwards and we may treat it as a new cylindrical column which will undergo changes just as the original one, leaving, however, a smaller core of unburned gases, or, in other words, each succeeding section of the flame will be of smaller diameter. This gives us the conical form of the flame. Again, the higher we ascend the flame the greater proportionally is the amount of separated carbon, for we have not only the heat of laterally outlying combustion to effect decomposition, but also that of the lower parts of the flame. The lower part of a luminous flame accordingly contains less separated carbon than the upper. Where the hydrocarbon is largely decomposed before combustion we have no longer the conditions of the Bunsen flame, and so in the upper parts of a luminous flame the bright blue part fades away. The luminous fringe would, however, be continued, for the separated hydrogen has still to burn. In this way then we may reasonably account for the existence, position and relative sizes of the four regions of an ordinary luminous flame. (A. S.)

FLAMEL, NICOLAS (c. 1330–1418), reputed French alchemist and scrivener to the university of Paris, was born in Paris or Pontoise about 1330, and died in Paris in 1418, bequeathing the bulk of his property to the church of Saint-Jacques-la-Boucherie, where he was buried. During his life he contributed freely to charitable and religious purposes from the considerable wealth he amassed either by the practice of his craft, or, as some surmise without definite proof, by fortunate speculation or money lending, or, as legend has it, by alchemy. According to a document purporting to be written by himself in 1413 (printed in Waite's *Lives of the Alchemistical Philosophers*, London, 1888), there fell into his hands in 1357, at the cost of two florins, a book on alchemy by Abraham the Jew, which taught in plain words the transmutation of metals. It did not, however, explain the *materia prima*, but merely figured or depicted it, and for more than 20 years Flamel strove in vain to find out the secret. Then, returning from a journey to Spain, he fell in with a Christian Jew, named Canches, who gave him the explanation, and after three more years' work he succeeded in preparing the *materia prima*, thus being enabled in 1382 to transmute mercury into both silver and gold. But this fantastic story was disposed of by the facts, derived from parish records, set forth in Vilain's *Essai sur l'histoire de Saint-Jacques-la-Boucherie*, 1758, and his *Histoire critique de Nicolas Flamel et de Pernelle sa femme, recueillie d'actes anciens qui justifient l'origine et la médiocrité de leur fortune contre les imputations des alchimistes*, 1761.

A book on alchemy in the Paris-Bibliothèque, *Le Trésor de philosophie*, professing to be written and illuminated by Flamel with his

own hand, is of very doubtful authenticity, and other treatises bearing his name, such as the *Sommaire philosophique de Nicolas Flamel*, published in 1561 in a collection of alchemist treatises entitled *Transformation métallique*, are certainly spurious.

FLAMEN (from *flare*, "to blow up" the altar fire), a Roman sacrificial priest. The flamens were subject to the pontifex (*q.v.*) maximus, and were consecrated to the service of some particular deity. The highest in rank were the *flamen Dialis*, *flamen Martialis* and *flamen Quirinalis*, who were always selected from among the patricians. Their institution is generally ascribed to Numa. When the number of flamens was raised from three to fifteen, those already mentioned were entitled *majores*, in contradistinction to the other twelve, who were called *minores*, as connected with less important deities, and were chosen from the plebs. Towards the end of the republic the number of the lesser flamens seems to have diminished. The flamens were held to be elected for life, but they might be compelled to resign office for neglect of duty, or on the occurrence of some ill-omened event (such as the cap falling off the head) during the performance of their rites. The characteristic dress of the flamens in general was the *apex*, a white conical cap, the *laena* or mantle, and a laurel wreath. The official insignia of the *flamen Dialis* (of Jupiter), the highest of these priests, were the white cap (*pileus, albogalerus*), at the top of which was an olive branch and a woollen thread; the *laena*, a thick woollen *toga praetexta* woven by his wife; the sacrificial knife; and a rod to keep the people from him when on his way to offer sacrifice. He was never allowed to appear without these emblems of office, every day being considered a holy day for him. By virtue of his office he was entitled to a seat in the senate and a curule chair. The sight of fetters being forbidden him, his toga was not allowed to be tied in a knot but was fastened by means of clasps, and the only kind of ring permitted to be worn on his finger was a broken one. If a person in fetters took refuge in his house he was immediately loosed from his bonds; and if a criminal on his way to the scene of his punishment met him and threw himself at his feet he was respited for that day. The *flamen Dialis* was not allowed to leave the city for a single night, to ride or even touch a horse (a restriction which incapacitated him for the consulship), to swear an oath, to look at an army, to touch anything unclean, or to look upon people working. His marriage, which was obliged to be performed with the ceremonies of *confarreatio* (*q.v.*), was dissoluble only by death, and on the death of his wife (called *flaminica Dialis*) he was obliged to resign his office. The *flaminica Dialis* assisted her husband at the sacrifices and other religious duties which he performed. She wore long woollen robes; a veil and a kerchief for the head, her hair being plaited up with a purple band in a conical form (*tutulus*); and shoes made of the leather of sacrificed animals; like her husband, she carried the sacrificial knife. The main duty of the flamens was the offering of daily sacrifices; on the 1st of October the three major flamens drove to the Capitol and sacrificed to *Fides Publica* (the Honour of the People). Some of the municipal towns in Italy had flamens as well as Rome.

We may mention, as distinct from the above, the *flamen curialis*, who assisted the *curio*, the priest who attended to the religious affairs of each curia (*q.v.*); the flamens of various sacerdotal corporations, such as the Arval Brothers; the *flamen Augustalis*, who superintended the worship of the emperor in the provinces.

See Marquardt, *Römische Staatsverwaltung*, iii. (1885), pp. 326-336, 473; H. Dessau, in *Ephemeris epigraphica*, iii. (1877); and the exhaustive article by C. Jullian in Daremberg and Saglio, *Dictionnaire des antiquités*.

FLAMINGO (Port. *Flamingo*, Span. *Flamenco*), one of the tallest and most beautiful birds, conspicuous for the bright flame-coloured or scarlet patch upon its wings, and long known by its classical name *Phoenicopterus*, as an inhabitant of most of the countries bordering the Mediterranean Sea. Flamingos have a very wide distribution, and the sole genus comprises only a few species. *Ph. roseus* or *antiquorum*, white, with a rosy tinge above, and with scarlet wing-coverts, while the remiges are black (as in all species), ranges from the Cape Verde Islands

to India and Ceylon, north as far as Lake Baikal; southwards through Africa and Madagascar, eventually as *P. minor*. *P. ruber*, entirely light vermilion, extends from Florida to Para and the Galapagos; *P. chilensis* s. *ignipalliatus*, from Peru to Patagonia, more resembles the classical species; while *P. andinus*, the tallest of all, which lacks the hallux, inhabits the salt lakes of the elevated desert of Atacama, whence it extends into Chile and Argentina. Fossil remains of flamingos have been described from the Lower Miocene of France as *P. croizeti*, and from the Pliocene of Oregon. From the Mid-Miocene to the Oligocene of France are known several species of *Palaeodus*, *Elornis* and *Agnopterus*, which have relatively shorter legs, longer toes and a complicated hypotarsus, and represent an earlier family, less specialized although not directly ancestral to the flamingos. *Palaeodidae* and *Phoenicopteridae* together form the larger group Phoenicopterii. These are in many respects exactly intermediate between Anserine and stork-like birds, so much so in fact that

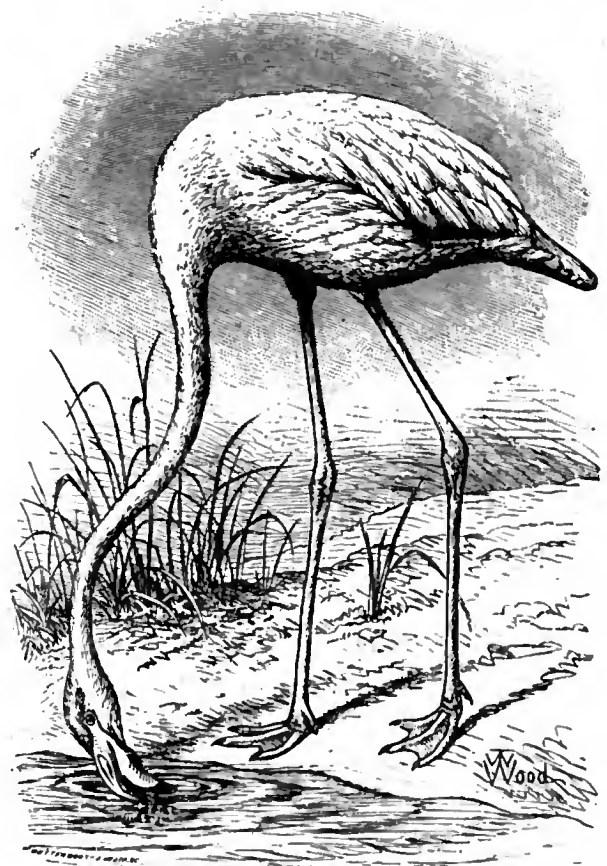

The Flamingo.

T. H. Huxley preferred to keep them separate as *Amphimorphae*. However, if we carefully sift their characters, the flamingos obviously reveal themselves as much nearer related to the *Ciconiæ*, especially to *Platalea* and *Ibis*, than to the Anseres. This is the opinion arrived at by W. F. R. Weldon, M. Fuerbringer and Gadow, while others prefer the goose-like voice and the webbed toes as reliable characters. (For a detailed analysis of this instructive question see Bronn's *Thierreich*, Aves Syst. p. 146.)

The food of the flamingo seems to consist chiefly of small aquatic invertebrate animals which live in the mud of lagoons, for instance Mollusca, but also of Confervae and other low salt-water algae. Whilst feeding, the bird wades about, stirs up the mud with its feet, and, reversing the ordinary position of its head so as to hold the crown downwards and to look backwards, sifts the mud through its bill. This is abruptly bent down in the middle, as if broken; the upper jaw is rather flat and narrow, while the lower jaw is very roomy and furnished with numerous lamellae, which, together with the thick and

large tongue, act like a sieve, an arrangement enhanced by the considerable movability of the upper jaw. Then the bird erects its long neck to swallow the selected food. When flying, flamingos present a striking and beautiful sight, with legs and neck stretched out straight, looking like white and rosy or scarlet crosses with black arms. Not less fascinating is a flock of these sociable birds when at rest, standing on one or both legs, with their long necks twisted or coiled upon the body in any conceivable position.

The nest is likewise peculiar. It is built of mud, a somewhat conical structure rising above the water according to the depth, of which the cone is from a few inches to 2 ft. in height. If, as often happens, the water-level sinks, the nests stand out higher. On the top is a shallow cup for the reception of the one or two eggs, which have a bluish-white shell with chalky incrustation. Of course the hen sits with her legs doubled up under her, as does any other long-legged bird. It seems strange that many ornithologists should have given credence to W. Dampier's statement of the mode of incubation (*New Voyage round the World*, ed. 2, i. p. 71, London, 1699): "And when they lay their eggs, or hatch them, they stand all the while, not on the hillock, but close by it with their legs on the ground and in the water, resting themselves against the hillock, and covering the hollow nest upon it with their rumps," &c. P. S. Pallas (*Zoograph. Rosso-Asiatica*, ii. p. 208) tried to improve upon this by stating that the standing bird leans upon the nest with its breast! The young, which are hatched after about four weeks' incubation, look very different from the adult. The small bill is still quite straight and the legs are short. The whole body is covered with a thick coat of short nestling feathers, pure white in colour. These *neossoptiles* or first feathers bear no resemblance to those of the Anseriform birds, but agree in detail with those of spoonbills, the young of which the little flamingos resemble to a striking extent, but they leave the nest soon after their birth to shift for themselves like ducks and geese. (H. F. G.)

FLAMINIA, VIA, an ancient high road of Italy, constructed by C. Flaminius during his censorship (220 B.C.). It led from Rome to Ariminum, and was the most important route to the north. We hear of frequent improvements being made in it during the imperial period. Augustus, when he instituted a general restoration of the roads of Italy, which he assigned for the purpose among various senators, reserved the Flaminia for himself, and rebuilt all the bridges except the Pons Mulvius, by which it crosses the Tiber, 2 m. N. of Rome (built by M. Scaurus in 109 B.C.), and an unknown Pons Minucius. Triumphal arches were erected in his honour on the former bridge and at Ariminum, the latter of which is still preserved. Vespasian constructed a new tunnel through the pass of Intercisa, modern Furlo, in A.D. 77 (see CALES), and Trajan, as inscriptions show, repaired several bridges along the road.

The Via Flaminia runs due N. from Rome, considerable remains of its pavement being extant in the modern high road, passing slightly E. of the site of the Etruscan Falerii, through Ocriculi and Narnia. Here it crossed the Nar by a splendid four-arched bridge to which Martial alludes (*Epigr.* vii. 93, 8), one arch of which and all the piers are still standing; and went on, followed at first by the modern road to Sangemini which passes over two finely preserved ancient bridges, past Carsulæ to Mevania, and thence to Forum Flaminii. Later on a more circuitous route from Narnia to Forum Flaminii was adopted, passing by Interamna, Spoletium and Fulginium (from which a branch diverged to Perugia), and increasing the distance by 12 m. The road thence went on to Nuceria (whence a branch road ran to Septempeda and thence either to Ancona or to Tolentinum and Urbs Salvia) and Helvillum, and then crossed the main ridge of the Apennines, a temple of Jupiter Apenninus standing at the summit of the pass. Thence it descended to Cales (where it turned N.E.), and through the pass of Intercisa to Forum Sempronii (Fossombrone) and Forum Fortunæ, where it reached the coast of the Adriatic. Thence it ran N.W. through Pisaurum to Ariminum. The total distance from Rome was 210 m. by the older road and 222 by the newer. The road

gave its name to a juridical district of Italy from the 2nd century A.D. onwards, the former territory of the Senones, which was at first associated with Umbria (with which indeed under Augustus it had formed the sixth region of Italy), but which after Constantine was always administered with Picenum. (T. As.)

FLAMININUS, TITUS QUINCTIUS (c. 228-174 B.C.), Roman general and statesman. He began his public life as a military tribune under M. Claudius Marcellus, the conqueror of Syracuse. In 199 he was quaestor, and the next year, passing over the regular stages of aedile and praetor, he obtained the consulship.

Flaminius was one of the first and most successful of the rising school of Roman statesmen, the opponents of the narrow patriotism of which Cato was the type, the disciples of Greek culture, and the advocates of a wide imperial policy. His winning manners, his polished address, his knowledge of men, his personal fascination, and his intimate knowledge of Greek, all marked him out as the fittest representative of Rome in the East. Accordingly, the province of Macedonia, and the conduct of the war with Philip V. of Macedon, in which, after two years, Rome had as yet gained little advantage, were assigned to him. Flaminius modified both the policy and tactics of his predecessors. After an unsuccessful attempt to come to terms, he drove the Macedonians from the valley of the Aous by skilfully turning an impregnable position. Having thus practically made himself master of Macedonia, he proceeded to Greece, where Philip still had allies and supporters. The Achaean League (*q.v.*) at once deserted the cause of Macedonia, and Nabis, the tyrant of Sparta, entered into an alliance with Rome; Acarnania and Boeotia submitted in less than a year, and, with the exception of the great fortresses, Flaminius had the whole of Greece under his control. The demand of the Greeks for the expulsion of Macedonian garrisons from Demetrias, Chalcis and Corinth, as the only guarantee for the freedom of Greece, was refused, and negotiations were broken off. Hostilities were renewed in the spring of 197, and Flaminius took the field supported by nearly the whole of Greece. At Cynoscephalæ the Macedonian phalanx and the Roman legion for the first time met in open fight, and the day decided which nation was to be master of Greece and perhaps of the world. It was a victory of superior tactics. The left wing of the Roman army was retiring in confusion before the Macedonian right led by Philip in person, when Flaminius, leaving them to their fate, boldly charged the left wing under Nicanor, which was forming on the heights. Before the left wing had time to form, Flaminius was upon them, and a massacre rather than a fight ensued. This defeat was turned into a general rout by a nameless tribune, who collected twenty companies and charged in the rear the victorious Macedonian phalanx, which in its pursuit had left the Roman right far behind. Macedonia was now at the mercy of Rome, but Flaminius contented himself with his previous demands. Philip lost all his foreign possessions, but retained his Macedonian kingdom almost entire. He was required to reduce his army, to give up all his decked ships except five, and to pay an indemnity of 1000 talents (£244,000). Ten commissioners arrived from Rome to regulate the final terms of peace, and at the Isthmian games a herald proclaimed to the assembled crowds that "the Roman people, and T. Quinctius their general, having conquered King Philip and the Macedonians, declare all the Greek states which had been subject to the king henceforward free and independent." Flaminius's last act before returning home was characteristic. Of the Achaeans, who vied with one another in showering upon him honours and rewards, he asked but one personal favour, the redemption of the Italian captives who had been sold as slaves in Greece during the Hannibalic War. These, to the number of 1200, were presented to him on the eve of his departure (spring, 194), and formed the chief ornament of his triumph.

In 192, on the rupture between the Romans and Antiochus III. the Great, Flaminius returned to Greece, this time as the civil representative of Rome. His personal influence and skilful diplomacy secured the wavering Achaean states, cemented the alliance with Philip, and contributed mainly to the Roman

victory at Thermopylae (191). In 183 he undertook an embassy to Prusias, king of Bithynia, to induce him to deliver up Hannibal, who forestalled his fate by taking poison. Nothing more is known of Flaminius, except that, according to Plutarch, his end was peaceful and happy.

There seems no doubt that Flaminius was actuated by a genuine love of Greece and its people. To attribute to him a Machiavellian policy, which foresaw the overthrow of Corinth fifty years later and the conversion of Achaea into a Roman province, is absurd and disingenuous. There is more force in the charge that his Hellenic sympathies prevented him from seeing the innate weakness and mutual jealousies of the Greek states of that period, whose only hope of peace and safety lay in submitting to the protectorate of the Roman republic. But if the event proved that the liberation of Greece was a political mistake, it was a noble and generous mistake, and reflects nothing but honour on the name of Flaminius, "the liberator of the Greeks."

His life has been written by Plutarch, and in modern times by F. D. Gerlach (1871); see also Mommsen, *Hist. of Rome* (Eng. tr.), bk. iii. chs. 8, 9.

FLAMINIUS, GAIUS, Roman statesman and general, of plebeian family. During his tribuneship (232 B.C.), in spite of the determined opposition of the senate and his own father, he carried a measure for distributing among the plebeians the *ager Gallicus Picenus*, an extensive tract of newly-acquired territory to the south of Ariminum (Cicero, *De senectute*, 4, *Brutus*, 14). As praetor in 227, he gained the lasting gratitude of the people of his province (Sicily) by his excellent administration. In 223, when consul with P. Furius Philus, he took the field against the Gauls, who were said to have been roused to war by his agrarian law. Having crossed the Po to punish the Insubrians, he at first met with a severe check and was forced to capitulate. Reinforced by the Cenomani, he gained a decisive victory on the banks of the Addua. He had previously been recalled by the optimates, but ignored the order. The victory seems to have been due mainly to the admirable discipline and fighting qualities of the soldiers, and he obtained the honour of a triumph only after the decree of the senate against it had been overborne by popular clamour. During his censorship (220) he strictly limited the freedmen to the four city tribes (see *COMITIA*). His name is further associated with two great works. He erected the Circus Flaminius on the Campus Martius, for the accommodation of the plebeians, and continued the military road from Rome to Ariminum, which had hitherto only reached as far as Spolegium (see *FLAMINIA, VIA*). He probably also instituted the "plebeian" games. In 218, as a leader of the democratic opposition, Flaminius was one of the chief promoters of the measure brought in by the tribune Quintus Claudius, which prohibited senators and senators' sons from possessing sea-going vessels, except for the transport of the produce of their own estates, and generally debarred them from all commercial speculation (Livy xxi. 63). His effective support of this measure vastly increased the popularity of Flaminius with his own order, and secured his second election as consul in the following year (217), shortly after the defeat of T. Sempronius Longus at the Trebia. He hastened at once to Arretium, the termination of the western high road to the north, to protect the passes of the Apennines, but was defeated and killed at the battle of the Trasimene lake (see *PUNIC WARS*).

The testimony of Livy (xxi., xxii.) and Polybius (ii., iii.)—no friendly critics—shows that Flaminius was a man of ability, energy and probity. A popular and successful democratic leader, he cannot, however, be ranked among the great statesmen of the republic. As a general he was headstrong and self-sufficient and seems to have owed his victories chiefly to personal boldness favoured by good fortune.

His son, **GAIUS FLAMINIUS**, was quaestor under P. Scipio Africanus the elder in Spain in 210, and took part in the capture of New Carthage. Fourteen years later, when curule aedile, he distributed large quantities of grain among the citizens at a very low price. In 193, as praetor, he carried on a successful war

against the insubordinate populations of his recently constituted province of Hispania Citerior. In 187 he was consul with M. Aemilius Lepidus, and subjugated the warlike Ligurian tribes. In the same year the branch of the Via Aemilia connecting Bononia with Arretium was constructed by him. In 181 he founded the colony of Aquileia. The chief authority for his life is the portion of Livy dealing with the history of the period.

FLAMSTEED, JOHN (1646–1719), English astronomer, was born at Denby, near Derby, on the 19th of August 1646. The only son of Stephen Flamsteed, a maltster, he was educated at the free school of Derby, but quitted it finally in May 1662, in consequence of a rheumatic affection of the joints, due to a chill caught while bathing. Medical aid having proved of no avail, he went to Ireland in 1665 to be "stroked" by Valentine Greatrakes, but "found not his disease to stir." Meanwhile, he solaced his enforced leisure with astronomical studies. Beginning with J. Sacrobosco's *De sphaera*, he read all the books on the subject that he could buy or borrow; observed a partial solar eclipse on the 12th of September 1662; and attempted the construction of measuring instruments. A tract on the equation of time, written by him in 1667, was published by Dr John Wallis with the *Posthumous Works* of J. Horrocks (1673); and a paper embodying his calculations of appulses to stars by the moon, which appeared in the *Philosophical Transactions* (iv. 1099), signed *In Mathesi a sole fundes*, an anagram of "Johannes Flamsteedius," secured for him, from 1670, general scientific recognition.

On his return from a visit to London in 1670 he became acquainted with Isaac Newton at Cambridge, entered his name at Jesus college, and took, four years later, a degree of M.A. by letters-patent. An essay composed by him in 1673 on the true and apparent diameters of the planets furnished Newton with data for the third book of the *Principia*, and he fitted numerical elements to J. Horrocks's theory of the moon. In 1674, and again in 1675, he was invited to London by Sir Jonas Moore, governor of the Tower, who proposed to establish him in a private observatory at Chelsea, but the plan was anticipated by the determination of Charles II. to have the tables of the heavenly bodies corrected, and the places of the fixed stars rectified "for the use of his seamen," and Flamsteed was appointed "astronomical observer" by a royal warrant dated 4th of March 1675. His salary of £100 a year was cut down by taxation to £90; he had to provide his own instruments, and to instruct, into the bargain, two boys from Christ's hospital. Sheer necessity drove him, in addition, to take many private pupils; but having been ordained in 1675, he was presented by Lord North in 1684 to the living of Burstow in Surrey; and his financial position was further improved by a small inheritance on his father's death in 1688. He now ordered, at an expense of £120, a mural arc from Abraham Sharp, with which he began to observe systematically on the 12th of September 1689 (see *ASTRONOMY: History*). The latter part of Flamsteed's life passed in a turmoil of controversy regarding the publication of his results. He struggled to withhold them until they could be presented in a complete form; but they were urgently needed for the progress of science, and the astronomer-royal was a public servant. Sir Isaac Newton, who depended for the perfecting of his lunar theory upon "places of the moon" reluctantly doled out from Greenwich, led the movement for immediate communication; whence arose much ill-feeling between him and Flamsteed. At last, in 1704, Prince George of Denmark undertook the cost of printing; a committee of the Royal Society was appointed to arrange preliminaries, and Flamsteed, protesting and exasperated, had to submit. The work was only partially through the press when the prince died, on the 28th of October 1708, and its completion devolved upon a board of visitors to the observatory endowed with ample powers by a royal order of the 12th of December 1712. As the upshot, the *Historia coelestis*, embodying the first Greenwich star-catalogue, together with the mural arc observations made 1689–1705, was issued under Edmund Halley's editorship in 1712. Flamsteed denounced the production as surreptitious; he committed to

the flames three hundred copies, of which he obtained possession through the favour of Sir Robert Walpole; and, in defiance of bodily infirmities, vigorously prosecuted his designs for the entire and adequate publication of the materials he continued to accumulate. They were but partially executed when he died on the 31st of December 1719. The preparation of his monumental work, *Historia coelestis Britannica* (3 vols. folio, 1725), was finished by his assistant, Joseph Crosthwait, aided by Abraham Sharp. The first two volumes included the whole of Flamsteed's observations at Derby and Greenwich; the third contained the *British Catalogue* of nearly 3000 stars. Numerous errors in this valuable record having been detected by Sir William Herschel, Caroline Herschel drew up a list of 560 stars observed, but not catalogued, while 111 of those catalogued proved to have never been observed (*Phil. Trans.* lxxxvii. 293; see also F. Baily, *Memoirs Roy. Astr. Society*, iv. 129). The appearance of the *Atlas coelestis*, corresponding to the *British Catalogue*, was delayed until 1729. A portrait of Flamsteed, painted by Thomas Gibson in 1712, hangs in the rooms of the Royal Society. The extent and quality of his performance were the more remarkable considering his severe physical sufferings, his straitened means, and the antagonism to which he was exposed. Estimable in private life, he was highly susceptible in professional matters, and hence failed to keep on terms with his contemporaries.

Francis Baily's *Account of the Rev. John Flamsteed* (1835) is the leading authority for his life. It comprises an autobiographical narrative pieced together from various sources, a large collection of Flamsteed's letters, a revised and enlarged edition of the *British Catalogue*, besides authoritative and detailed introductory discussions. Some clamour was raised by a publication in which blame for harsh dealings was freely imputed to Newton, but W. Whewell vindicated his character in *Flamsteed and Newton* (1836).

See also *General Dictionary*, vol. v. (1737), from materials supplied by James Hodgson, Flamsteed's nephew-in-law; *Biographia Britannica*, iii. 1943 (1750); S. Rigaud's *Correspondence of Scientific Men*; Cunningham's *Lives of Eminent Englishmen*, iv. 366 (1835); Mark Noble's Continuation of James Granger's *Biog. Hist. of England*, ii. 132; R. Grant's *Hist. of Phys. Astronomy*, p. 467; W. Whewell's *Hist. of the Inductive Sciences*, ii. 162; J. S. Bailly's *Hist. de l'Astronomie moderne*, ii. 423, 589, 650; J. Delambre's *Hist. de l'Astronomie au XVIII^e siècle*, p. 93; *Observatory*, xv. 355, 379, 382. (A. M. C.)

FLANDERS (Flem. *Vlaanderen*), a territorial name for part of the Netherlands, Europe. Originally it applied only to Bruges and the immediate neighbourhood. In the 8th and 9th centuries it was gradually extended to the whole of the coast region from Calais to the Scheldt. In the middle ages this was divided into two parts, one looking to Bruges as its capital, and the other to Ghent. The name is retained in the two Belgian provinces of West and East Flanders.

1. West Flanders is the portion bordering the North Sea, and its coast-line extends from the French to the Dutch frontier for a little over 40 m. Its capital is Bruges, and the principal towns of the province are Ostend, Courtrai, Ypres and Roulers. Agriculture is the chief occupation of the population, and the country is under the most careful and skilful cultivation. The admiration of the foreign observer for the Belgian system of market gardening is not diminished on learning that the subsoil of most of this tract is the sand of the "dunes." Fishing employs a large proportion of the coast population. The area of West Flanders is officially computed at 808,667 acres or 1263 sq. m. In 1904 the population was 845,732, giving an average of 669 to the sq. m.

2. East Flanders lies east and north-east of the western province; and extends northwards to the neighbourhood of Antwerp. It is still more productive and richer than Western Flanders, and is well watered by the Scheldt. The district of Waes, land entirely reclaimed within the memory of man, is supposed to be the most productive district of its size in Europe. The principal towns are Ghent (capital of the province), St Nicolas, Alost, Termonde, Eecloo and Oudenarde. The area is given at 749,987 acres or 1172 sq. m. In 1904 the population was 1,073,507, showing an average of 916 per sq. m.

History.—The ancient territory of Flanders comprised not only the modern provinces known as East and West Flanders, but the southernmost portion of the Dutch province of Zeeland

and a considerable district in north-western France. In the time of Caesar it was inhabited by the Morini, Atrebates and other Celtic tribes, but in the centuries that followed the land was repeatedly overrun by German invaders, and finally became a part of the dominion of the Franks. On the break-up of the Carolingian empire the river Scheldt was by the treaty of Verdun (843) made the line of division between the kingdom of East Francia (Austrasia) under the emperor Lothaire, and the kingdom of West Francia (Neustria) under Charles the Bald. In virtue of this compact Flanders was henceforth attached to the West Frankish monarchy (France). It thus acquired a position unique among the provinces of the territory known in later times as the Netherlands, all of which were included in that northern part of Austrasia assigned on the death of the emperor Lothaire (855) to King Lothaire II., and from his name called Lotharingia or Lorraine.

The first ruler of Flanders of whom history has left any record is Baldwin, surnamed *Bras-de-fer* (Iron-arm). This man, a brave and daring warrior under Charles the Bald, fell in love with the king's daughter Judith, the youthful widow of two English kings, married her, and fled with his bride to Lorraine. Charles, though at first very angry, was at last conciliated, and made his son-in-law margrave (*Marchio Flandriae*) of Flanders, which he held as an hereditary fief. The Northmen were at this time continually devastating the coast lands, and Baldwin was entrusted with the possession of this outlying borderland of the west Frankish dominion in order to defend it against the invaders. He was the first of a line of strong rulers, who at some date early in the 10th century exchanged the title of margrave for that of count. His son, Baldwin II.—the Bald—from his stronghold at Bruges maintained, as did his father before him, a vigorous defence of his lands against the incursions of the Northmen. On his mother's side a descendant of Charlemagne, he strengthened the dynastic importance of his family by marrying Aelfthryth, daughter of Alfred the Great. On his death in 918 his possessions were divided between his two sons Arnulf the Elder and Adolphus, but the latter survived only a short time and Arnulf succeeded to the whole inheritance. His reign was filled with warfare against the Northmen, and he took an active part in the struggles in Lorraine between the emperor Otto I. and Hugh Capet. In his old age he placed the government in the hands of Baldwin, his son by Adela, daughter of the count of Vermandois, and the young man, though his reign was a very short one, did a great deal for the commercial and industrial progress of the country, establishing the first weavers and fullers at Ghent, and instituting yearly fairs at Ypres, Bruges and other places.

On Baldwin III.'s death in 961 the old count resumed the control, and spent the few remaining years of his life in securing the succession of his grandson Arnulf II.—the Younger. The reign of Arnulf was terminated by his death in 989, and he was followed by his son Baldwin IV., named *Barbatus* or the Bearded. This Baldwin fought successfully both against the Capetian king of France and the emperor Henry II. Henry found himself obliged to grant to Baldwin IV. in fief Valenciennes, the burgraveship of Ghent, the land of Waes, and Zeeland. The count of Flanders thus became a feudatory of the empire as well as of the French crown. The French fiefs are known in Flemish history as Crown Flanders (*Kroon-Vlaanderen*), the German fiefs as Imperial Flanders (*Rijks-Vlaanderen*). Baldwin's son—afterwards Baldwin V.—rebelled in 1028 against his father at the instigation of his wife Adela, daughter of Robert II. of France; but two years later peace was sworn at Oudenaarde, and the old count continued to reign till his death in 1036. Baldwin V. proved a worthy successor, and acquired from the people the surname of *Débonnaire*. He was an active enterprising man, and greatly extended his power by wars and alliances. He obtained from the emperor Henry IV. the territory between the Scheldt and the Dender as an imperial fief, and the margraviate of Antwerp. So powerful had he become that the Flemish count on the decease of Henry I. of France in 1060 was appointed regent during the minority of Philip I. (see

FRANCE). Before his death he saw his eldest daughter Matilda (d. 1083) sharing the English throne with William the Conqueror, his eldest son Baldwin of Mons in possession of Hainaut in right of his wife Richilde, heiress of Regnier V. (d. 1036) and widow of Hermann of Saxony (d. 1050/1) (see HAINAUT), and his second son Robert the Frisian regent (*voogd*) of the county of Holland during the minority of Dirk V., whose mother, Gertrude of Saxony, widow of Floris I. of Holland (d. 1061), Robert had married (see HOLLAND). On his death in 1067 his son Baldwin of Mons, already count of Hainaut, succeeded to the countship of Flanders. Baldwin V. had granted to Robert the Frisian on his marriage in 1063 his imperial fiefs. His right to these was disputed by Baldwin VI., and war broke out between the two brothers. Baldwin was killed in battle in 1070. Robert now claimed the tutelage of Baldwin's children and obtained the support of the emperor Henry IV., while Richilde, Baldwin's widow, appealed to Philip I. of France. The contest was decided at Ravenshoven, near Cassel, on the 22nd of February 1071, where Robert was victorious. Richilde was taken prisoner and her eldest son Arnulf III. was slain. Robert obtained from Philip I. the investiture of Crown Flanders, and from Henry IV. the fiefs which formed Imperial Flanders.

The second son of Richilde was recognized as count of Hainaut (see HAINAUT), which was thus after a brief union separated from Flanders. Robert died in 1093, and was succeeded by his son Robert II., who acquired great renown by his exploits in the first crusade, and won the name of the Lance and Sword of Christendom. His fame was second only to that of Godfrey of Bouillon. Robert returned to Flanders in 1100. He fought with his suzerain Louis the Fat of France against the English, and was drowned in 1111 by the breaking of a bridge. His son and successor, Baldwin VII., or Baldwin with the Axe, also fought against the English in France. He died at the age of twenty-seven from the wound of an arrow, in 1119, leaving no heir. He nominated as his successor his cousin Charles, son of Knut IV. of Denmark and of Adela, daughter of Robert the Frisian. Charles tried his utmost to put down oppression and to promote the welfare of his subjects, and obtained the surname of "the Good." His determination to enforce the right made him many enemies, and he was foully murdered on Ash Wednesday, 1127, at Bruges. He died childless, and there were no less than six candidates to the countship. The contest lay between two of these, William Clito, son of Robert of Normandy and grandson of William the Conqueror and Matilda of Flanders, and Thierry or Dirk of Alsace, whose mother Gertrude was a daughter of Robert the Frisian. William Clito, through the support of Louis of France, was at first accepted by the Flemish nobles as count, but he gave offence to the communes, who supported Thierry. A struggle ensued and William was killed before Alost. Thierry then became count without further opposition. He married the widow of Charles the Good, Marguerite of Clermont, and proved himself at home a wise and prudent prince, encouraging the growth of popular liberty and of commerce. In 1146 he took part in the second crusade and distinguished himself by his exploits. In 1157 he resigned the countship to his son Philip of Alsace and betook himself once more to Jerusalem. On his return from the East twenty years later Thierry retired to a monastery to die in his own land.

Count Philip of Alsace was a strong and able man. He did much to promote the growth of the municipalities for which Flanders was already becoming famous. Ghent, Bruges, Ypres, Lille and Douai under him made much progress as flourishing industrial towns. He also conferred rights and privileges on a number of ports, Hulst, Nieuwport, Sluis, Dunkirk, Axel, Damme, Gravelines and others. But while encouraging the development of the communes and "free towns," Philip sternly repressed any spirit of independence or attempted uprisings against his authority. This count was a powerful prince. He acted for a time as regent in France during the minority of his godson Philip Augustus, and married his ward to his niece Isabella of Hainaut (1180). Philip took part in the third

crusade, and died in the camp before Acre of the pestilence in 1191.

As he had no children, the succession passed to Baldwin of Hainaut, who had married Philip's sister Margaret. The countships of Flanders and Hainaut were thus united under the same ruler. Baldwin did not obtain possession of Flanders without strong opposition on the part of the French king, and he was obliged to cede Artois, St Omer, Lens, Hesdin and a great part of southern Flanders to France, and to allow Matilda of Portugal, the widow of Philip of Alsace, to retain certain towns in right of her dowry. Margaret died in 1194 and Baldwin the following year, and their eldest son Baldwin IX. succeeded to both countships. Baldwin IX. is famous in history as the founder of the Latin empire at Constantinople. He perished in Bulgaria in 1206. The emperor's two daughters were both under age, and the government was carried on by their uncle Philip, marquis of Namur, whom Baldwin had appointed regent on his departure to Constantinople. Philip proved faithless to his charge, and he allowed his nieces to fall into the hands of Philip Augustus, who married the elder sister Johanna of Constantinople to his nephew Ferdinand of Portugal. The Flemings were averse to the French king's supremacy, and Ferdinand, who acted as governor in the name of his wife, joined himself to the confederacy formed by Germany, England, and the leading states of the Netherlands against Philip Augustus. Ferdinand was, however, taken prisoner at the disastrous battle of Bouvines (1214) and was kept for twelve years a prisoner in the Louvre. The countess Johanna ruled the united countships with prudence and courage. On Ferdinand's death she married Thomas of Savoy, but died in 1244, leaving no heirs. She was succeeded in her dignities by her younger sister Margaret of Constantinople, commonly known amongst her contemporaries as "Black Meg" (*Zwarte Griet*). Margaret had been twice married. Her first husband was (1212) Buchard of Avesnes, one of the first of Hainaut's nobles and a man of knightly prowess, but originally destined for the church. On this ground he was excommunicated by Innocent III. and imprisoned by the countess Johanna, with the result that Margaret at last was driven to repudiate him. She married in second wedlock (1225) William of Dampierre. Two sons were the issue of the first marriage, three sons and three daughters of the second.

When Margaret in 1244 became countess of Flanders and Hainaut, she wished her son William of Dampierre to be acknowledged as her successor. John of Avesnes, her eldest son, strongly protested against this and was supported by the French king. A civil war ensued, which ended in a compromise (1246), the succession to Flanders being granted to William of Dampierre, that of Hainaut to John of Avesnes. Margaret, however, ruled with a strong hand for many years and survived both her sons, dying at the age of eighty in 1280. On her death her grandson, John II. of Avesnes, became count of Hainaut; Guy of Dampierre, her second son by her second marriage, count of Flanders.

The two counties were once more under separate dynasties. The government of Guy of Dampierre was unfortunate. It was the interest of the Flemish weavers to be on good terms with England, the wool-producing country, and Guy entered into an alliance with Edward I. against France. This led to an invasion and conquest of Flanders by Philip the Fair. Guy with his sons and the leading Flemish nobles were taken prisoners to Paris, and Flanders was ruled as a French dependency. But though in the principal towns, Ghent, Bruges and Ypres, there was a powerful French faction—known as *Leliaerts* (adherents of the lily)—the arbitrary rule of the French governor and officials stirred up the mass of the Flemish people to rebellion. The anti-French partisans (known as *Clauwaerts*) were strongest at Bruges under the leadership of Peter de Conynck, master of the cloth-weavers, and John Breydel, master of the butchers. The French garrison at Bruges were massacred (May 10th, 1302), and on the following 11th of July a splendid French army of invasion was utterly defeated near Courtray. Peace was concluded in 1305, but owing to Guy of Dampierre, and the leading Flemish nobles being in the hands of the French king, on terms

very disadvantageous to Flanders. Very shortly afterwards the aged count Guy died, as did also Philip the Fair. Robert of Bethune, his son and successor, had continual difficulties with France during the whole of his reign, the Flemings offering a stubborn resistance to all attempts to destroy their independence. Robert was succeeded in 1322 by his grandson Louis of Nevers. Louis had been brought up at the French court, and had married Margaret of France. His sympathies were entirely French, and he made use of French help in his contests with the communes.

Under Louis of Nevers Flanders was practically reduced to the status of a French province. In his time the long contest between Flanders and Holland for the possession of the island of Zeeland was brought to an end by a treaty signed on the 6th of March 1323, by which West Zeeland was assigned to the count of Holland, the rest to the count of Flanders. The latter part of the reign of Louis of Nevers was remarkable for the successful revolt of the Flemish communes, now rapidly advancing to great material prosperity under Jacob van Artevelde (see ARTEVELDE, JACOB VAN). Artevelde allied himself with Edward III. of England in his contest with Philip of Valois for the French crown, while Louis of Nevers espoused the cause of Philip. He fell at the battle of Crécy (1346). He was followed in the countship by his son Louis II. of Mâle. The reign of this count was one long struggle with the communes, headed by the town of Ghent, for political supremacy. Louis was as strong in his French sympathies as his father, and relied upon French help in enforcing his will upon his refractory subjects, who resented his arbitrary methods of government, and the heavy taxation imposed upon them by his extravagance and love of display. Had the great towns with their organized guilds and great wealth held together in their opposition to the count's despotism, they would have proved successful, but Ghent and Bruges, always keen rivals, broke out into open feud. The power of Ghent reached its height under Philip van Artevelde (see ARTEVELDE, PHILIP VAN) in 1382. He defeated Louis, took Bruges and was made *ruward* of Flanders. But the triumph of the White Hoods, as the popular party was called, was of short duration. On the 27th of November 1382 Artevelde suffered a crushing defeat from a large French army at Roosebeke and was himself slain. Louis of Mâle died two years later, leaving an only daughter Margaret, who had married in 1369 Philip the Bold, duke of Burgundy.

Flanders now became a portion of the great Burgundian domain, which in the reign of Philip the Good, Margaret's grandson, had absorbed almost the whole of the Netherlands (see BURGUNDY; NETHERLANDS). The history of Flanders as a separate state ceases from the time of the acquisition of the countship by the Burgundian dynasty. There were revolts from time to time of great towns against the exactions even of these powerful princes, but they were in vain. The conquest and humiliation of Bruges by Philip the Good in 1440, and the even more relentless punishment inflicted on rebellious Ghent by the emperor Charles V. exactly a century later are the most remarkable incidents in the long-continued but vain struggle of the Flemish communes to maintain and assert their privileges. The Burgundian dukes and their successors of the house of Habsburg were fully alive to the value to them of Flanders and its rich commercial cities. It was Flanders that furnished to them no small part of their resources, but for this very reason, while fostering the development of Flemish industry and trade, they were the more determined to brook no opposition which sought to place restrictions upon their authority.

The effect of the revolt of the Netherlands and the War of Dutch Independence which followed was ruinous to Flanders. Albert and Isabel on their accession to the sovereignty of the southern Netherlands in 1599 found "the great cities of Flanders and Brabant had been abandoned by a large part of their inhabitants; agriculture hardly in a less degree than commerce and industry had been ruined." In 1633 with the death of Isabel, Flanders reverted to Spanish rule (1633). By the treaty of Munster the north-western portion of Flanders, since known as States (or Dutch) Flanders, was ceded by Philip IV. to the United Provinces (1648). By a succession of later treaties—of

the Pyrenees (1659), Aix-la-Chapelle (1668), Nijmegen (1679) and others—a large slice of the southern portion of the old county of Flanders became French territory and was known as French Flanders.

From 1795 to 1814 Flanders, with the rest of the Belgic provinces, was incorporated in France, and was divided into two departments—*département de l'Escaut* and *département de la Lys*. This division has since been retained, and is represented by the two provinces of East Flanders and West Flanders in the modern kingdom of Belgium. The title of count of Flanders was revived by Leopold I. in 1840 in favour of his second son, Philip Eugene Ferdinand (d. 1905). (G. E.)

FLANDRIN, JEAN HIPPOLYTE (1809–1864), French painter, was born at Lyons in 1809. His father, though brought up to business, had great fondness for art, and sought himself to follow an artist's career. Lack of early training, however, disabled him for success, and he was obliged to take up the precarious occupation of a miniature painter. Hippolyte was the second of three sons, all painters, and two of them eminent, the third son Paul (b. 1811) ranking as one of the leaders of the modern landscape school of France. Auguste (1804–1842), the eldest, passed the greater part of his life as professor at Lyons, where he died. After studying for some time at Lyons, Hippolyte and Paul, who had long determined on the step and economized for it, set out to walk to Paris in 1829, to place themselves under the tuition of Hersent. They chose finally to enter the atelier of Ingres, who became not only their instructor but their friend for life. At first considerably hampered by poverty, Hippolyte's difficulties were for ever removed by his taking, in 1832, the Grand Prix de Rome, awarded for his picture of the "Recognition of Theseus by his Father." This allowed him to study five years at Rome, whence he sent home several pictures which considerably raised his fame. "St Clair healing the Blind" was done for the cathedral of Nantes, and years after, at the exhibition of 1855, brought him a medal of the first class. "Jesus and the Little Children" was given by the government to the town of Lisieux. "Dante and Virgil visiting the Envious Men struck with Blindness," and "Euripides writing his Tragedies," belong to the museum at Lyons. Returning to Paris through Lyons in 1838 he soon received a commission to ornament the chapel of St John in the church of St Séverin at Paris, and reputation increased and employment continued abundant for the rest of his life. Besides the pictures mentioned above, and others of a similar kind, he painted a great number of portraits. The works, however, upon which his fame most surely rests are his monumental decorative paintings. Of these the principal are those executed in the following churches:—in the sanctuary of St Germain des Prés at Paris (1842–1844), in the choir of the same church (1846–1848), in the church of St Paul at Nismes (1848–1849), of St Vincent de Paul at Paris (1850–1854), in the church of Ainay at Lyons (1855), in the nave of St Germain des Prés (1855–1861). In 1856 Hippolyte Flandrïn was elected to the Académie des Beaux-Arts. In 1863 his failing health, rendered worse by incessant toil and exposure to the damp and draughts of churches, induced him again to visit Italy. He died of small-pox at Rome on the 21st of March 1864. As might naturally be expected in one who looked upon painting as but the vehicle for the expression of spiritual sentiment, he had perhaps too little pride in the technical qualities of his art. There is shown in his works much of that austerity and coldness, expressed in form and colour, which springs from a faith which feels itself in opposition to the tendencies of surrounding life. He has been compared to Fra Angelico; but the faces of his long processions of saints and martyrs seem to express rather the austerity of souls convicted of sin than the joy and purity of never-corrupted life which shines from the work of the early master.

See Delaborde, *Lettres et pensées de H. Flandrïn* (Paris, 1865); Beulé, *Notice historique sur H. F.* (1869).

FLANNEL, a woollen stuff of various degrees of weight and fineness, made usually from loosely spun yarn. The origin of the word is uncertain, but in the 16th century flannel was a well-known production of Wales, and a Welsh origin has been

suggested. The French form *flanelle* was used late in the 17th century, and the Ger. *Flanell* early in the 18th century. Baize, a kind of coarse flannel with a long nap, is said to have been first introduced to England about the middle of the 16th century by refugees from France and the Netherlands. The manufacture of flannel has naturally undergone changes, and, in some cases, deteriorations. Flannels are frequently made with an admixture of silk or cotton, and in low varieties cotton has tended to become the predominant factor. Formerly a short staple wool of fine quality from a Southdown variety of the Sussex breed was principally in favour with the flannel manufacturers of Rochdale, who also used largely the wool from the Norfolk breed, a cross between the Southdown and Norfolk sheep. In Wales the short staple wool of the mountain sheep was used, and in Ireland that of the Wicklow variety of the Cottagh breed, but now the New Zealand, Cape and South American wools are extensively employed, and English wools are not commonly used alone. Over 2000 persons are employed in flannel manufacture in Rochdale alone, which is the historic seat of the industry, and a good deal of flannel is now made in the Spen Valley district, Yorkshire. Blankets, which constitute a special branch of the flannel trade, are largely made at Bury in Lancashire and Dewsbury in Yorkshire. Welsh flannels have a high reputation, and make an important industry in Montgomeryshire. There are also flannel manufactories in Ireland.

A moderate export trade in flannel is done by Great Britain. The following table gives the quantities exported during three years:—

	1904.	1905.	1906.
Yards . . .	9,758,300	9,220,500	8,762,200

In 1877 the export was 9,273,429 yds., so it appears that this trade has varied comparatively little. The imports of flannel are not very large.

Many so-called flannels have been made with a large admixture of cotton, but the Merchandise Marks Act has done something to limit the indiscriminate use of names. Unquestionably the development of the flannel trade has been checked by the great increase in the production of flannelettes, the better qualities of which have become formidable competitors with flannel. There must, however, be a regular and large demand for flannel while theory and experience confirm its value as a clothing particularly suitable for immediate contact with the body.

FLANNELETTE, a cotton cloth made to imitate flannel. The word seems to have been first used in the early 'eighties, and there is a reference in the *Daily News* of 1887 to "a poverty-stricken article called flannelette." Now it is used very extensively for underclothing, night gear, dresses, dressing-gowns, shirts, &c. It is usually made with a much coarser weft than warp, and its flannel-like appearance is obtained by the raising or scratching up of this weft, and by various finishing processes. Some kinds are raised equally on both sides, and the nap may be long or short according to the purpose for which the cloth is required. A considerable trade is done in plain cloths dyed, and also in woven coloured stripes and checks, but almost any heavy or coarse cotton cloth can be made into flannelette. It is now largely used by the poorer classes of the community, and the flimsier kinds have been a frequent source of accident by fire. It is, however, when used discreetly and in a fair quality, a cheap and useful article. A flannelette, patented under the title of "Non-flam," has been made with fire-resisting properties, but its sale has been more in the better qualities than in the lower and more dangerous ones. Flannelette is made largely on the continent of Europe, and in the United States as well as in Great Britain.

FLASK, in its earliest meaning in Old English a vessel for carrying liquor, made of wood or leather. The principal applications in current usage are (1) to a vessel of metal or wood, formerly of horn, used for carrying gunpowder; (2) to a long-necked, round-bodied glass vessel, usually covered with plaited straw or maize leaves, containing olive or other oil or Italian wines—it is often known as a "Florence flask": similarly shaped vessels are used for experiments, &c., in a laboratory;

(3) to a small metal or glass receptacle for spirits, wine or other liquor, of a size and shape to fit into a pocket or holster, usually covered with leather, basket-work or other protecting substance, and with a detachable portion of the case shaped to form a cup. "Flask" is also used in metal-founding of a wooden frame or case to contain part of the mould. The word "flagon," which is by derivation a doublet of "flask," is usually applied to a larger type of vessel for holding liquor, more particularly to a type of wine-bottle with a short neck and circular body with flattened sides. The word is also used of a jug-shaped vessel with a handle, spout and lid, into which wine may be decanted from the bottle for use at table, and of a similarly shaped vessel to contain the Eucharistic wine till it is poured into the chalice. "Flask" (in O. Eng. *flasce* or *flaxe*) is represented both in Teutonic and Romanic languages. The earliest examples are found in Med. Lat. *flasco*, *flascotis*, whence come Ital. *flascone*, O. Fr. *flascun* (mod. *flacon*), adapted in the Eng. "flagon." Another Lat. form is *flasca*, this gave a Fr. *flasque*, which in the sense of "powder flask" remained in use till later than the 16th century. In Teutonic languages the word, in its various forms, is the common one for "bottle," so in Ger. *Flasche*, Dutch *flesch*, &c. If the word is of Romanic origin it is probably a metathesized form of the Lat. *vasculum*, diminutive of *vas*, vessel. There is no very satisfactory etymology if the word is of Teutonic origin; the New English Dictionary considers a connexion with "flat" probable phonetically, but finds no evidence that the word was used originally for a flat-shaped vessel.

FLAT (a modification of O. Eng. *flet*, an obsolete word of Teutonic origin, meaning the ground beneath the feet), a term commonly used as an adjective, signifying level in surface, level with the ground, and so, figuratively, fallen, dead, inanimate, tasteless, dull; or, by another transference, downright; or, in music, below the true pitch. In a substantival form, the term is used in physical geography for a level tract.

The word is also generally applied by modern usage to a self-contained residence or separate dwelling (in Scots law, the term *flatted house* is still used), consisting of a suite of rooms which form a portion, usually on a single floor, of a larger building, called the tenement house, the remainder being similarly divided. The approach to it is over a hall, passage and stairway, which are common to all residents in the building, but from which each private flat is divided off by its own outer door (Clode, *Tenement Houses and Flats*, pp. 1, 2).

There is in England a considerable body of special law applicable to flats. The following points deserve notice:—(i.) The occupants of distinct suites of rooms in a building divided into flats are generally, and subject, of course, to any special terms in their agreements, not lodgers but tenants with exclusive possession of separate dwelling-houses placed one above the other. They are, therefore, liable to distress by the immediate landlord, and each flat is separately rateable, though as a general rule by the contract of tenancy the rates are payable by the landlord. Flats used solely for business purposes are exempt from house tax, by the Customs and Inland Revenue Act 1878 (see *Grant, v. Langston*, 1900, A.C. 383); and, by the Revenue Act 1903 (s. 11), provision is made for excluding from assessment or for assessing at a low rate buildings used for providing separate dwellings at rents not exceeding £60 a year. It appears that tenants of a flat would not come within the meaning of "lodger" for the purposes of the Lodgers' Goods Protection Act 1871. (ii.) The owner of an upper storey, without any express grant or enjoyment for any given time, has a right to the support of the lower storey (*Dalton v. Angus*, 1881, 6 A.C. 740, 793). The owner of the lower storey, however, so long as he does nothing actively in the way of withdrawing its support, is not bound to repair, in the absence of a special covenant imposing that obligation upon him. The right of support being an easement in favour of the owner of the upper storey, it is for him to repair. He is in law entitled to enter on the lower storey for the purpose of doing the necessary repairs. It appears, however, that there is an implied obligation by the landlord to the tenants to keep the common stair and the lift or elevator in repair, and, for breach

of this duty, he will be liable to a third party who, while visiting a tenant in the course of business, is injured by its defective condition (*Miller v. Hancock*, 1893, 2 Q.B. 177). No such liability would be involved in a mere licence to the tenants to use a part of the building not essential to the enjoyment of their flats. (iii.) In case of the destruction of the flat by fire, the rent abates *pro tanto* and an apportionment is made; *pari ratione*, where a flat is totally destroyed, the rent abates altogether (Clode, p. 14); unless the tenant has entered into an express and unqualified agreement to pay rent, when he will remain liable till the expiration of his tenancy. (iv.) Where the agreements for letting the flats in a single building are in common form, an agreement by the lessor not to depart from the kind of building there indicated may be held to be implied. Thus an injunction has been granted to restrain the conversion into a club of a large part of a building, adapted to occupation in residential flats, at the instance of a tenant who held under an agreement in a common form binding the tenants to rules suitable only for residential purposes (*Hudson v. Cripps*, 1896, 1 Ch. 265). (v.) The porter is usually appointed and paid by the landlord, who is liable for his acts while engaged on his general duties; while engaged on any special duty for any tenant the porter is the servant of the latter, who is liable for his conduct within the scope of his employment.

In Scots law the rights and obligations of the lessors and lessees of flats, or—as they are called—“flatted houses,” spring partly from the exclusive possession by each lessee of his own flat, partly from the common interest of all in the tenement as a whole. The “law of the tenement” may be thus summed up. The *solum* on which the flatted house stands, the area in front and the back ground are presumed to belong to the owner of the lowest floor or the owners of each floor severally, subject to the common right of the other proprietors to prevent injury to their flats, especially by depriving them of light. The external walls belong to each owner in so far as they enclose his flat; but the other owners can prevent operations on them which would endanger the security of the building. The roof and uppermost storey belong to the highest owner or owners, but he or they may be compelled to keep them in repair and to refrain from injuring them. The gables are common to the owner of each flat, so far as they bound his property, and to the owner of the adjoining house; but he and the other owners in the building have cross rights of common interest to prevent injury to the stability of the building. The floor and ceiling of each flat are divided in ownership by an ideal line drawn through the middle of the joists; they may be used for ordinary purposes, but may not be weakened or exposed to unusual risk from fire. The common passages and stairs are the common property of all to whose premises they form an access, and the walls which bound them are the common property of those persons and of the owners on their farther side.

In the United States the term “apartment-house” is applied to what in England are called flats. The general law is the same as in England. The French Code Civil provides (Art. 664) that where the different storeys of a house belong to different owners the main walls and roof are at the charge of all the owners, each one in proportion to the value of the storey belonging to him. The proprietor of each storey is responsible for his own flooring. The proprietor of the first storey makes the staircase which leads to it, the proprietor of the second, beginning from where the former ended, makes the staircase leading to his and so on. There are similar provisions in the Civil Codes of Belgium (Art. 664), Quebec (Art. 521), St Lucia (Art. 471).

AUTHORITIES.—ENGLISH LAW: Clode, *Law of Tenement-Houses and Flats* (London, 1889); Daniels, *Manual of the Law of Flats* (London, 1905). SCOTS LAW: Erskine, *Principles of the Law of Scotland* (20th ed., Edinburgh, 1903); Bell, *Principles of the Law of Scotland* (10th ed., Edinburgh, 1899). AMERICAN LAW: Bouvier, *Law Dicty.* (Boston and London, 1897). FOREIGN LAWS: Burge, *Foreign and Colonial Laws* (2nd ed., London, 1906). (A. W. R.)

FLATBUSH, formerly a township of Kings county, Long Island, New York, U.S.A., annexed to Brooklyn in 1894, and after the 1st of January 1898 a part of the borough of Brooklyn,

New York City. The first settlement was made here by the Dutch about 1651, and was variously called “Midwout,” “Midwoud” and “Medwoud” (from the Dutch words, *med*, “middle” and *woud*, “wood”) for about twenty years, when it became more commonly known as Vlachte Bos (*vlachte*, “wooded”; *bos*, “plain”) or Flackebos, whence, by further corruption, the present name. Farming was the chief occupation of the early settlers. On the 23rd of August 1776 the village was occupied by General Cornwallis’s division of the invading force under Lord Howe, and on the 27th, at the disastrous battle of Long Island (or “battle of Flatbush,” as it is sometimes called), “Flatbush Pass,” an important strategic point, was vigorously defended by General Sullivan’s troops.

FLAT-FISH (*Pleuronectidae*), the name common to all those fishes which swim on their side, as the halibut, turbot, brill, plaice, flounder, sole, &c. The side which is turned towards the bottom, and in some kinds is the right, in others the left, is generally colourless, and called “blind,” from the absence of an eye on this side. The opposite side, which is turned upwards and towards the light, is variously, and in some tropical species even vividly, coloured, both eyes being placed on this side of the head. All the bones and muscles of the upper side are more strongly developed than on the lower; but it is noteworthy that these fishes when hatched, and for a short time afterwards, are symmetrical like other fishes.

Assuming that they are the descendants of symmetrical fishes, the question has been to determine which group of Teleosteans may be regarded as the ancestors of the flat-fishes. The old notion that they are only modified Gadids (Anacanthini) was the result of the artificial classification of the past and is now generally abandoned. The condition of the caudal fin, which in the cod tribe departs so markedly from that of ordinary Teleosteans, is in itself a sufficient reason for dismissing the idea of the homocercal flat-fishes being derived from the Anacanthini, and the whole structure of the two types of fishes speaks against such an assumption. On the other hand it has been shown, as noticed in the article DORY, that considerable, deep-seated resemblances exist between the Zeidae or John Dories and the more generalized of the Pleuronectidae; and that a fossil fish from the Upper Eocene, *Amphistium paradoxum*, evidently allied to the Zeidae, appears to realize in every respect the prototype of the Pleuronectidae before they had assumed the asymmetry which characterizes them as a group. In accordance with these views the flat-fishes are placed by G. A. Boulenger in the suborder Acanthopterygii, in a division called *Zeorhombi*. The three families included in that division can be traced back to the Upper Eocene, and their common ancestors will probably be found in the Upper Cretaceous associated with the *Berycidae*, to which they will no doubt prove to be related. The very young are transparent and symmetrical, with an eye on each side, and swim in a vertical position. As they grow, the eye of one side moves by degrees to the other side, where it becomes the upper eye. If at that age the dorsal fin does not extend to the frontal region, the migrating eye simply moves over the line of the profile, temporarily assuming the position which it preserves in some of the less modified genera, such as *Psittodes*; in other genera, the dorsal fin has already extended to the snout before the migration takes place, and the eye, passing between the frontal bone and the tissues supporting the fin, appears to make its way from side to side through the head, as was believed by some of the earlier observers.

About 500 species of flat-fish are known, mostly marine, a few species allied to the sole being confined to the fresh waters of South America, West Africa, and the Malay Archipelago, whilst a few others, such as the English flounder, ascend streams, though still breeding in the sea. They range from the Arctic Circle to the southern coasts of the southern hemisphere and may occur at great depths. (G. A. B.)

FLATHEADS, a tribe of North American Indians of Salishan stock. They formerly occupied the mountains of north-western Montana and the country around. They have always been friendly to the whites. Curiously enough they have not the

custom, so general among American tribes, of flattening the heads of their infants. Father P. J. de Smet in 1841 founded among them a mission which proved the most successful in the north-west. With the Pend d'Oreille tribe and some Kutenais they are on a reservation in Montana, and number a few hundreds.

FLAUBERT, GUSTAVE (1821-1880), French novelist, was born at Rouen on the 12th of December 1821. His father, of whom many traits are reproduced in Flaubert's character of Charles Bovary, was a surgeon in practice at Rouen; his mother was connected with some of the oldest Norman families. He was educated in his native city, and did not leave it until 1840, when he came up to Paris to study law. He is said to have been idle at school, but to have been occupied with literature from the age of eleven. Flaubert in his youth "was like a young Greek," full of vigour of body and a certain shy grace, enthusiastic, intensely individual, and apparently without any species of ambition. He loved the country, and Paris was extremely distasteful to him. He made the acquaintance of Victor Hugo, and towards the close of 1840 he travelled in the Pyrenees and Corsica. Returning to Paris, he wasted his time in sombre dreams, living on his patrimony. In 1846, his mother being left quite alone through the deaths of his father and his sister Caroline, Flaubert gladly abandoned Paris and the study of the law together, to make a home for her at Croisset, close to Rouen. This estate, a house in a pleasant piece of ground which ran down to the Seine, became Flaubert's home for the remainder of his life. From 1846 to 1854 he carried on relations with the poetess, Mlle Louise Colet; their letters have been preserved, and according to M. Émile Faguet, this was the only sentimental episode of any importance in the life of Flaubert, who never married. His principal friend at this time was Maxime du Camp, with whom he travelled in Brittany in 1846, and through the East in 1849. Greece and Egypt made a profound impression upon the imagination of Flaubert. From this time forth, save for occasional visits to Paris, he did not stir from Croisset.

On returning from the East, in 1850, he set about the composition of *Madame Bovary*. He had hitherto scarcely written anything, and had published nothing. The famous novel took him six years to prepare, but was at length submitted to the *Revue de Paris*, where it appeared in serial form in 1857. The government brought an action against the publisher and against the author, on the charge of immorality, but both were acquitted; and when *Madame Bovary* appeared in book-form it met with a very warm reception. Flaubert paid a visit to Carthage in 1858, and now settled down to the archaeological studies which were required to equip him for *Salammô*, which, however, in spite of the author's ceaseless labours, was not finished until 1862. He then took up again the study of contemporary manners, and, making use of many recollections of his youth and childhood, wrote *L'Éducation sentimentale*, the composition of which occupied him seven years; it was published in 1869. Up to this time the sequestered and laborious life of Flaubert had been comparatively happy, but misfortunes began to gather around him. He felt the anguish of the war of 1870 so keenly that the break-up of his health has been attributed to it; he began to suffer greatly from a distressing nervous malady. His best friends were taken from him by death or by fatal misunderstanding; in 1872 he lost his mother, and his circumstances became greatly reduced. He was very tenderly guarded by his niece, Mme Commonville; he enjoyed a rare intimacy of friendship with George Sand, with whom he carried on a correspondence of immense artistic interest, and occasionally he saw his Parisian acquaintances, Zola, A. Daudet, Tourgenieff, the Goncourts; but nothing prevented the close of Flaubert's life from being desolate and melancholy. He did not cease, however, to work with the same intensity and thoroughness. *La Tentation de Saint-Antoine*, of which fragments had been published as early as 1857, was at length completed and sent to press in 1874. In that year he was subjected to a disappointment by the failure of his drama *Le Candidat*. In 1877 Flaubert published, in one volume, entitled *Trois contes, Un Cœur simple, La Légende de*

Saint-Julien-l'Hospitalier and *Hérodiade*. After this something of his judgment certainly deserted him; he spent the remainder of his life in the toil of building up a vast satire on the utility of human knowledge and the omnipresence of mediocrity, which he left a fragment. This is the depressing and bewildering *Bouvard et Pécuchet* (posthumously printed, 1881), which, by a curious irony, he believed to be his masterpiece. Flaubert had rapidly and prematurely aged since 1870, and he was quite an old man when he was carried off by a stroke of apoplexy at the age of only 58, on the 8th of May 1880. He died at Croisset, but was buried in the family vault in the cemetery of Rouen. A beautiful monument to him by Chapu was unveiled at the museum of Rouen in 1890.

The personal character of Flaubert offered various peculiarities. He was shy, and yet extremely sensitive and arrogant; he passed from silence to an indignant and noisy flow of language. The same inconsistencies marked his physical nature; he had the build of a guardsman, with a magnificent Viking head, but his health was uncertain from childhood, and he was neurotic to the last degree. This ruddy giant was secretly gnawed by misanthropy and disgust of life. His hatred of the "bourgeois" began in his childhood, and developed into a kind of monomania. He despised his fellow-men, their habits, their lack of intelligence, their contempt for beauty, with a passionate scorn which has been compared to that of an ascetic monk. Flaubert's curious modes of composition favoured and were emphasized by these peculiarities. He worked in sullen solitude, sometimes occupying a week in the completion of one page, never satisfied with what he had composed, violently tormenting his brain for the best turn of a phrase, the most absolutely final adjective. It cannot be said that his incessant labours were not rewarded. His private letters show that he was not one of those to whom easy and correct language is naturally given; he gained his extraordinary perfection with the unceasing sweat of his brow. One of the most severe of academic critics admits that "in all his works, and in every page of his works, Flaubert may be considered a model of style." That he was one of the greatest writers who ever lived in France is now commonly admitted, and his greatness principally depends upon the extraordinary vigour and exactitude of his style. Less perhaps than any other writer, not of France, but of modern Europe, Flaubert yields admission to the inexact, the abstract, the vaguely inapt expression which is the bane of ordinary methods of composition. He never allowed a *cliché* to pass him, never indulgently or wearily went on, leaving behind him a phrase which "almost" expressed his meaning. Being, as he is, a mixture in almost equal parts of the romanticist and the realist, the marvellous propriety of his style has been helpful to later writers of both schools, of every school. The absolute exactitude with which he adapts his expression to his purpose is seen in all parts of his work, but particularly in the portraits he draws of the figures in his principal romances. The degree and manner in which, since his death, the fame of Flaubert has extended, form an interesting chapter of literary history. The publication of *Madame Bovary* in 1857 had been followed by more scandal than admiration; it was not understood at first that this novel was the beginning of a new thing, the scrupulously truthful portraiture of life. Gradually this aspect of his genius was accepted, and began to crowd out all others. At the time of his death he was famous as a realist, pure and simple. Under this aspect Flaubert exercised an extraordinary influence over E. de Goncourt, Alphonse Daudet and M. Zola. But even since the decline of the realistic school Flaubert has not lost prestige; other facets of his genius have caught the light. It has been perceived that he was not merely realistic, but real; that his clairvoyance was almost boundless; that he saw certain phenomena more clearly than the best of observers had done. Flaubert is a writer who must always appeal more to other authors than to the world at large, because the art of writing, the indefatigable pursuit of perfect expression, were always before him, and because he hated the lax felicities of improvisation as a disloyalty to the most sacred procedures of the literary artist.

His *Œuvres complètes* (8 vols., 1885) were printed from the original manuscripts, and included, besides the works mentioned already, the two plays, *Le Candidat* and *Le Château des cœurs*. Another edition (10 vols.) appeared in 1873-1885. Flaubert's correspondence with George Sand was published in 1884 with an introduction by Guy de Maupassant. Other posthumous works are *Par les champs et par les grèves* (1885), the result of a tour in Brittany; and four volumes of *Correspondance* (1887-1893). See also Paul Bourget, *Essais de psychologie contemporaine* (1887); Émile Faguet, *Flaubert* (1899); Henry James, *French Poets and Novelists* (1878); Émile Zola, *Les Romanciers naturalistes* (1881); C. A. Sainte-Beuve, *Causeries du lundi*, vol. xiii., *Nouveaux lundis*, vol. iv.; and the *Souvenirs littéraires* (2 vols., 1882-1883) of Maxime du Camp. (E. G.)

FLAVEL, JOHN (c. 1627-1691), English Presbyterian divine, was born at Bromsgrove in Worcestershire, probably in 1627. He was the elder son of Richard Flavel, described in contemporary records as "a painful and eminent minister." After receiving his early education, partly at home and partly at the grammar-schools of Bromsgrove and Haslar, he entered University College, Oxford. Soon after taking orders in 1650 he obtained a curacy at Diptford, Devon, and on the death of the vicar he was appointed to succeed him. From Diptford he removed in 1656 to Dartmouth. He was ejected from his living by the passing of the Act of Uniformity in 1662, but continued to preach and administer the sacraments privately till the Five Mile Act of 1665, when he retired to Slapton, 5 m. away. He then lived for a time in London, but returned to Dartmouth, where he laboured till his death in 1691. He was married four times. He was a vigorous and voluminous writer, and not without a play of fine fancy.

His principal works are his *Navigation Spiritualized* (1671); *The Fountain of Life, in forty-two Sermons* (1672); *The Method of Grace* (1680); *Pneumatologia, a Treatise on the Soul of Man* (1698); *A Token for Mourners; Husbandry Spiritualized* (1699). Collected editions appeared throughout the 18th century, and in 1823 Charles Bradley edited a 2 vol. selection.

FLAVIAN I. (d. 404), bishop or patriarch of Antioch, was born about 320, most probably in Antioch. He inherited great wealth, but resolved to devote his riches and his talents to the service of the church. In association with Diodorus, afterwards bishop of Tarsus, he supported the Catholic faith against the Arian Leontius, who had succeeded Eustathius as bishop of Antioch. The two friends assembled their adherents outside the city walls for the observance of the exercises of religion; and, according to Theodoret, it was in these meetings that the practice of antiphonal singing was first introduced in the services of the church. When Meletius was appointed bishop of Antioch in 361 he raised Flavian to the priesthood, and on the death of Meletius in 381 Flavian was chosen to succeed him. The schism between the two parties was, however, far from being healed; the bishop of Rome and the bishops of Egypt refused to acknowledge Flavian, and Paulinus, who by the extreme Eustathians had been elected bishop in opposition to Meletius, still exercised authority over a portion of the church. On the death of Paulinus in 383, Evagrius was chosen as his successor, but after the death of Evagrius (c. 393) Flavian succeeded in preventing his receiving a successor, though the Eustathians still continued to hold separate meetings. Through the intervention of Chrysostom, soon after his elevation to the patriarchate of Constantinople (398), and the influence of the emperor Theodosius, Flavian was acknowledged in 399 as legitimate bishop of Antioch by the Church of Rome; but the Eustathian schism was not finally healed till 415. Flavian, who died in February 404, is venerated in both the Western and Eastern churches as a saint.

See also the article **MELETIUS OF ANTIOCH**, and the article "Flavianus von Antiochien" by Loofs in Herzog-Hauck's *Realencyklop.* (ed. 3). For the Meletian schism see also A. Harnack's, *Hist. of Dogma*, iv. 95.

FLAVIAN II. (d. 518), bishop or patriarch of Antioch, was chosen by the emperor Anastasius I. to succeed Palladius, most probably in 498. He endeavoured to please both parties by steering a middle course in reference to the Chalcedon (*q.v.*) decrees, but was induced after great hesitation to agree to the request of Anastasius that he should accept the Henoticon, or decree of union, issued by the emperor Zeno. His doing so, while it brought upon him the anathema of the patriarch of

Constantinople, failed to secure the favour of Anastasius, who in 511 found in the riots which were occurring between the rival parties in the streets of Antioch a pretext for deposing Flavian, and banishing him to Petra, where he died in 518. Flavian was soon after his death enrolled among the saints of the Greek Church, and after some opposition he was also canonized by the Latin Church.

FLAVIAN (d. 449), bishop of Constantinople, and an adherent of the Antiochene school, succeeded Proclus in 447. He presided at the council which deposed Eutyches (*q.v.*) in 448, but in the following year he was deposed by the council of Ephesus (the "robber synod"), which reinstated Eutyches in his office. Flavian's death shortly afterwards was attributed, by a pious fiction, to ill treatment at the hands of his theological opponents. The council of Chalcedon canonized him as a martyr, and in the Latin Church he is commemorated on the 18th of February.

FLAVIGNY, a town of eastern France, in the department of Côte-d'Or, situated on a promontory overlooking the river Ozerain, 33 m. W.N.W. of Dijon by road. Pop. (1906) 725. Among its antiquities are the remains of an abbey of the 8th century, which has been rebuilt as a factory for the manufacture of anise, an industry connected with the town as early as the 17th century. There is also a church of the 13th and 15th centuries, containing carved stalls (15th century) and a fine rood-screen (early 16th century). A Dominican convent, some old houses and ancient gateways are also of interest. About 3 m. north-west of Flavigny rises Mont Auxois, the probable site of the ancient Alesia, where Caesar in A.D. 52 defeated the Gallic chieftain Vercingetorix, to whom a statue has been erected on the summit of the height. Numerous remains of the Gallo-Roman period have been discovered on the hill.

FLAVIN (Lat. *flavus*, yellow), the commercial name for an extract or preparation of quercitron bark (*Quercus tinctoria*), which is used as a yellow dye in place of the ground and powdered bark (see **QUERCITRON**).

FLAX. The terms flax or lint (Ger. *Flachs*, Fr. *lin*, Lat. *linum*) are employed at once to denote the fibre so called, and the plant from which it is prepared. The flax plant (*Linum usitatissimum*) belongs to the natural order *Linaceae*, and, like most plants which have been long under cultivation, it possesses numerous varieties, while its origin is doubtful. As cultivated it is an annual with an erect stalk rising to a height of from 20 to 40 in., with alternate, sessile, narrowly lance-shaped leaves, branching only at the top, each branch or branchlet ending in a bright blue flower. The flowers are regular and symmetrical, having five sepals, tapering to a point and hairy on the margin, five petals which speedily fall, ten stamens, and a pistil bearing five distinct styles. The fruit or boll is round, containing five cells, each of which is again divided into two, thus forming ten divisions, each of which contains a single seed. The seeds of the flax plant, well known as linseed, are heavy, smooth, glossy and of a bright greenish-brown colour. They are oval in section, but their maximum contour represents closely that of a pear with the stalk removed. The contents are of an oily nature, and when liquefied are of great commercial value.

The earliest cultivated flax was *Linum angustifolium*, a smaller plant with fewer and narrower leaves than *L. usitatissimum*, and usually perennial. This is known to have been cultivated by the inhabitants of the Swiss lake-dwellings, and is found wild in south and west Europe (including England), North Africa, and western Asia. The annual flax (*L. usitatissimum*) has been cultivated for at least four or five thousand years in Mesopotamia, Assyria and Egypt, and is wild in the districts included between the Persian Gulf, the Caspian Sea and the Black Sea. This annual flax appears to have been introduced into the north of Europe by the Finns, afterwards into the west of Europe by the western Aryans, and perhaps here and there by the Phoenicians; lastly, into Hindustan by the eastern Aryans after their separation from the European Aryans. (De Candolle, *Origin of Cultivated Plants*.)

The cultivation and preparation of flax are among the most ancient of all textile industries, very distinct traces of their

existence during the stone age being preserved to the present day. "The use of flax," says Ferdinand Keller (*Lake Dwellings of Switzerland*, translated by J. E. Lee), "reaches back to the very earliest periods of civilization, and it was most extensively and variously applied in the lake-dwellings, even in those of the stone period. But of the mode in which it was planted, steeped, heckled, cleansed and generally prepared for use, we can form no idea any more than we can of the mode or tools employed by the settlers in its cultivation. . . . Rough or unworked flax is found in the lake-dwellings made into bundles, or what are technically called heads, and, as much attention was given to this last operation, it was perfectly clean and ready for use." As to its applications at this early period, Keller remarks: "Flax was the material for making lines and nets for fishing and catching wild animals, cords for carrying the earthenware vessels and other heavy objects; in fact, one can hardly imagine how



FIG. 1.—Flax Plant (*Linum usitatissimum*).

navigation could be carried on, or the lake-dwellings themselves be erected, without the use of ropes and cords; and the erection of memorial stones (menhirs, dolmens), at whichever era, and to whatever people these monuments may belong, would be altogether impracticable without the use of strong ropes."

Manufacture.—That flax was extensively cultivated and was regarded as of much importance at a very early period in the world's history there is abundant testimony. Especially in ancient Egypt the fibre occupied a most important place, linen having been there not only generally worn by all classes, but it was the only material the priestly order was permitted to wear, while it was most extensively used as wrappings for embalmed bodies and for general purposes. In the Old Testament we are told that Pharaoh arrayed Joseph "in vestures of fine linen" (Gen. xlii. 42), and among the plagues of Egypt that of hail destroyed the flax and barley crops, "for the barley was in the ear, and the flax was balled" (Exod. ix. 31). Further, numerous pictorial representations of flax culture and preparation exist to the present day on the walls of tombs and in Egypt. Sir J. G. Wilkinson in his description of ancient Egypt shows clearly the great antiquity of the ordinary processes of preparing flax. "At Beni Hassan," he says, "the mode of cultivating the plant, in the same square beds now met with throughout Egypt (much resembling our salt pans), the process of beating the stalks and making them into ropes, and the manufacture of a piece of cloth are distinctly pointed out." The preparation of the fibre as conducted in Egypt is illustrated by Pliny, who says: "The stalks themselves are immersed in water, warmed by the heat of the sun, and are kept down by weights placed upon

them, for nothing is lighter than flax. The membrane, or rind, becoming loose is a sign of their being sufficiently macerated. They are then taken out and repeatedly turned over in the sun until perfectly dried, and afterwards beaten by mallets on stone slabs. That which is nearest the rind is called *stupa* ['tow'], inferior to the inner fibres, and fit only for the wicks of lamps. It is combed out with iron hooks until the rind is all removed. The inner part is of a whiter and finer quality. Men are not ashamed to prepare it" (Pliny, *N.H.* xix. 1). For many ages, even down to the early part of the 14th century, Egyptian flax occupied the foremost place in the commercial world, being sent into all regions with which open intercourse was maintained. Among Western nations it was, without any competitor, the most important of all vegetable fibres till towards the close of the 18th century, when, after a brief struggle, cotton took its place as the supreme vegetable fibre of commerce.

Flax prospers most when grown upon land of firm texture resting upon a moist subsoil. It does well to succeed oats or potatoes, as it requires the soil to be in fresh condition without being too rich. Lands newly broken up from pasture suit it well, as these are generally freer from weeds than those that have been long under tillage. It is usually inexpedient to apply manure directly to the flax crop, as the tendency of this is to produce over-luxuriance, and thereby to mar the quality of the fibre, on which its value chiefly depends. For the same reason it must be thickly seeded, the effect of this being to produce tall, slender stems, free from branches. The land, having been ploughed in autumn, is prepared for sowing by working it with the grubber, harrow and roller, until a fine tilth is obtained. On the smooth surface the seed is sown broadcast by hand or machine, at the rate of 3 bushels per acre, and covered in the same manner as clover seeds. It is advisable immediately to hand-rake it with common hay-rakes, and thus to remove all stones and clods, and to secure a uniform close cover of plants. When these are about 2 to 3 in. long the crop must be carefully hand-weeded. This is a tedious and expensive process, and hence the importance of sowing the crop on land as free as possible from weeds of all kinds. The weeders, faces to the wind, move slowly on hands and knees, and should remove every vestige of weed in order that the flax plants may receive the full benefit of the land. When flax is cultivated primarily on account of the fibre, the crop ought to be pulled before the capsules are quite ripe, when they are just beginning to change from a green to a pale-brown colour, and when the stalks of the plant have become yellow throughout about two-thirds of their height.

The various operations through which the crop passes from this point till flax ready for the market is produced are—(1) Pulling, (2) Rippling, (3) Retting, (4) Drying, (5) Rolling, (6) Scutching.

Pulling and rippling may be dismissed very briefly. Flax is always pulled up by the root, and under no circumstances is it cut or shorn like cereal crops. The pulling ought to be done in dry clear weather; and care is to be taken in this, as in all the subsequent operations, to keep the root-ends even and the stalks parallel. At the same time it is desirable to have, as far as possible, stalks of equal length together,—all these conditions having considerable influence on the quality and appearance of the finished sample. As a general rule the removal of the "bolls" or capsules by the process of rippling immediately follows the pulling, the operation being performed in the field; but under some systems of cultivation, as, for example, the Courtrai method, alluded to below, the crop is made up into sheaves, dried and stacked, and is only balled and retted in the early part of the next ensuing season. The best rippler, or apparatus for separating the seed capsules from the branches, consists of a kind of comb having, set in a wooden frame, iron teeth made of round-rod iron $\frac{1}{8}$ ths of an inch asunder at the bottom, and half an inch at the top, and 18 in. long, to allow a sufficient spring, and save much breaking of flax. The points should begin to taper 3 in. from the top. A sheet or other cover being spread on the field, the apparatus is placed in the middle of it, and two rippers sitting opposite each other, with

the machine between them, work at the same time. It is unadvisable to ripple the flax so severely as to break or tear the delicate fibres at the upper part of the stem. The two valuable commercial products of the flax plant, the seeds and the stalk, are separated at this point. We have here to do with the latter only.

Retting or rotting is an operation of the greatest importance, and one in connexion with which in recent years numerous experiments have been made, and many projects and processes put forth, with the view of remedying the defects of the primitive system or altogether supplanting it. From the earliest times two leading processes of retting have been practised, termed respectively water-retting and dew-retting; and as no method has yet been introduced which satisfactorily supersedes these operations, they will first be described.

Water-retting.—For this—the process by which flax is generally prepared—pure soft water, free from iron and other materials which might colour the fibre, is essential. Any water much impregnated with lime is also specially objectionable. The dams or ponds in which the operation is conducted are of variable size, and usually between 4 and 5 ft. in depth. The rippled stalks are tied in small bundles and packed, roots downwards, in the dams till they are quite full; over the top of the upper layer is placed a stratum of rushes and straw, or sods with the grassy side downwards, and above all stones of sufficient weight to keep the flax submerged. Under favourable circumstances a process of fermentation should immediately be set up, which soon makes itself manifest by the evolution of gaseous bubbles. After a few days the fermentation subsides; and generally in from ten days to two weeks the process ought to be complete. The exact time, however, depends upon the weather and upon the particular kind of water in which the flax is immersed. The immersion itself is a simple matter; the difficulty lies in deciding when the process is complete. If allowed to remain under water too long, the fibre is weakened by what is termed “over-retting,” a condition which increases the amount of codilla in the scutching process; whilst “under-retting” leaves part of the gummy or resinous matter in the material, which hinders the subsequent process of manufacture. As the steeping is such a critical operation, it is essential that the stalks be frequently examined and tested as the process nears completion. When it is found that the fibre separates readily from the woody “shove” or core, the beets or small bundles are ready for removing from the dams. It is drained, and then spread, evenly and equally, over a grassy meadow to dry. The drying, which takes from a week to a fortnight, must be uniform, so that all the fibres may spin equally well. To secure this uniformity, it is necessary to turn the material over several times during the process. It is ready for gathering when the core cracks and separates easily from the fibre. At this point advantage is taken of fine dry weather to gather up the flax, which is now ready for scutching, but the fibre is improved by stooking and stacking it for some time before it is taken to the scutching mill.

Dew-retting is the process by which all the Archangel flax and a large portion of that sent out from St Petersburg are prepared. By this method the operation of steeping is entirely dispensed with, and the flax is, immediately after pulling, spread on the grass where it is under the influence of air, sunlight, night-dews and rain. The process is tedious, the resulting fibre is brown in colour, and it is said to be peculiarly liable to undergo heating (probably owing to the soft heavy quality of the flax) if exposed to moisture and kept close packed with little access of air. Archangel flax is, however, peculiarly soft and silky in structure, although in all probability water-retting would result in a fibre as good or even better in quality.

The theory of retting, according to the investigations of J. Kolb, is that a peculiar fermentation is set up under the influence of heat and moisture, resulting in a change of the intercellular substance—pectose or an analogue of that body—into pectin and pectic acid. The former, being soluble, is left in the water; but the latter, an insoluble body, is in part attached to the

fibres, from which it is only separated by changing into soluble metapectic acid under the action of hot alkaline ley in the subsequent process of bleaching.

To a large extent retting continues to be conducted in the primitive fashions above described, although numerous and persistent attempts have been made to improve upon it, or to avoid the process altogether. The uniform result of all experiments has only been to demonstrate the scientific soundness of the ordinary process of water-retting, and all the proposed improvements of recent times seek to obviate the tediousness, difficulties and uncertainties of the process as carried on in the open air. In the early part of the 19th century much attention was bestowed, especially in Ireland, on a process invented by Mr James Lee. He proposed to separate the fibre by purely mechanical means without any retting whatever; but after the Irish Linen Board had expended many thousands of pounds and much time in making experiments and in erecting his machinery, his entire scheme ended in complete failure. About the year 1851 Chevalier Claussen sought to revive a process of “cottonizing” flax—a method of proceeding which had been suggested three-quarters of a century earlier. Claussen’s process consisted in steeping flax fibre or tow for twenty-four hours in a weak solution of caustic soda, next boiling it for about two hours in a similar solution, and then saturating it in a solution containing 5% of carbonate of soda, after which it was immersed in a vat containing water acidulated with $\frac{1}{2}$ % of sulphuric acid. The action of the acid on the carbonate of soda with which the fibre was impregnated caused the fibre to split up into a fine cotton-like mass, which it was intended to manufacture in the same manner as cotton. A process to turn good flax into bad cotton had, however, on the face of it, not much to recommend it to public acceptance; and Claussen’s process therefore remains only as an interesting and suggestive experiment.

The only modification of water-retting which has hitherto endured the test of prolonged experiment, and taken a firm position as a distinct improvement, is the warm-water retting patented in England in 1846 by an American, Robert B. Schenck. For open pools and dams Schenck substitutes large wooden vats under cover, into which the flax is tightly packed in an upright position. The water admitted into the tanks is raised to and maintained at a temperature of from 75° to 95° F. during the whole time the flax is in steep. In a short time a brisk fermentation is set up, gases at first of pleasant odour, but subsequently becoming very repulsive, being evolved, and producing a frothy scum over the surface of the water. The whole process occupies only from 50 to 60 hours. A still further improvement, due to Mr Pownall, comes into operation at this point, which consists of immediately passing the stalks as they are taken out of the vats between heavy rollers over which a stream of pure water is kept flowing. By this means, not only is all the slimy glutinous adherent matter thoroughly separated, but the subsequent processes of breaking and scutching are much facilitated.

A process of retting by steam was introduced by W. Watt of Glasgow in 1852, and subsequently modified and improved by J. Buchanan. The system possessed the advantages of rapidity, being completed in about ten hours, and freedom from any noxious odour; but it yielded only a harsh, ill-spinning fibre, and consequently failed to meet the sanguine expectations of its promoters.

In connexion with improvements in retting, Mr Michael Andrews, secretary of the Belfast Flax Supply Association, made some suggestions and experiments which deserve close attention. In a paper contributed to the International Flax Congress at Vienna in 1873 he entered into details regarding an experimental rettery he had formed, with the view of imitating by artificial means the best results obtained by the ordinary methods. In brief, Mr Andrews’ method consists in introducing water at the proper temperature into the retting vat, and maintaining that temperature by keeping the air of the chamber at a proper degree of heat. By this means the flax is kept at a uniform temperature with great certainty, since even should the

heat of the air vary considerably through neglect, the water in the vat only by slow degrees follows such fluctuations. "It may be remarked," says Mr Andrews, "that the superiority claimed for this method of retting flax over what is known as the 'hot-water steeping' is uniformity of temperature; in fact the experiments have demonstrated that an absolute control can be exercised over the means adopted to produce the artificial climate in which the vats containing the flax are situated."

Several other attempts have been made with a view of obtaining a quick and practical method of retting flax. The one by Messrs Doumer and Deswarte appears to have been well received in France, but in Ireland the invention of Messrs Loppens and Deswarte has recently received the most attention. The apparatus consists of a tank with two chambers, the partition being perforated. The flax is placed in the upper chamber and covered by two sets of rods or beams at right angles to each other. Fresh water is allowed to enter the lower chamber immediately under the perforated partition. As the tank fills, the water enters the upper chamber and carries with it the flax and the beams, the latter being prevented from rising too high. The soluble substances are dissolved by the water, and the liquid thus formed being heavier than water, sinks to the bottom of the tank where it is allowed to escape through an outlet. By this arrangement the flax is almost continually immersed in fresh water, a condition which hastens the retting. The flow of the liquids, in and out, can be so arranged that the motion is very slow, and hence the liquids of different densities do not mix. When the operation is completed, the whole of the water is run off, and the flax remains on the perforated floor, where it drains thoroughly before being removed to dry.

The Department of Agriculture and Technical Instruction for Ireland, and the Belfast Flax Supply Association, have jointly made some experiments with this method, and the following extract from the Association's report for 1905 shows the success which attended their efforts:—

"By desire of the department (which has taken up the position of an impartial critic of the experiment) a quantity of flax straw was divided into two equal lots. One part was retted at Millisle by the patent-system of Loppens and Deswarte; the other was sent to Courtrai and steeped in the Lys. Both lots when retted and scutched were examined by an inspector of the department and by several flax spinners. That which was retted at Millisle was pronounced superior to the other" . . .

"To summarise results up to date—

1. It has been proved that flax can be thoroughly dried in the field in Ireland.
2. That the seed can be saved, and is of first quality.
3. That the system of retting (Loppens and Deswarte's patent) is at least equal to the Lys, as to quality and yield of fibre produced."

Since these results appear to be satisfactory, it is natural to expect further attempts with the same object of supplanting the ordinary steeping. A really good chemical, mechanical or other method would probably be the means of reviving the flax industry in the remote parts of the British Isles.

Scutching is the process by which the fibre is freed from its woody core and rendered fit for the market. For ordinary water-retted flax two operations are required, first breaking and then scutching, and these are done either by hand labour or by means of small scutching or lint mills, driven either by water or steam power. Hand labour, aided by simple implements, is still much used in continental countries; also in some parts of Ireland where labour is cheap or when very fine material is desired; but the use of scutching mills is now very general, these being more economical. The breaking is done by passing the stalks between grooved or fluted rollers of different pitches; these rollers, of which there may be from 5 to 7 pairs, are sometimes arranged to work alternately forwards and backwards in order to thoroughly break the woody material or "boon" of the straw, while the broken "shoves" are beaten out by suspending the fibre in a machine fitted with a series of revolving blades, which, striking violently against the flax, shake out the bruised and broken woody cores. A great many modified scutching machines

and processes have been proposed and introduced with the view of promoting economy of labour and improving the turn-out of fibre, both in respect of cleanness and in producing the least proportion of codilla or scutching tow.

The celebrated Courtrai flax of Belgium is the most valuable staple in the market, on account of its fineness, strength and particularly bright colour. There the flax is dried in the field, and housed or stacked during the winter succeeding its growth, and in the spring of the following year it is retted in crates sunk in the sluggish waters of the river Lys. After the process has proceeded a certain length, the crates are withdrawn, and the sheaves taken out and stooked. It is thereafter once more tied up, placed in the crates, and sunk in the river to complete the retting process; but this double steeping is not invariably practised. When finally taken out, it is unloosed and put up in cones, instead of being grassed, and when quite dry it is stored for some time previous to undergoing the operation of scutching. In all operations the greatest care is taken, and the cultivators being peculiarly favoured as to soil, climate and water, Courtrai flax is a staple of unapproached excellence.

An experiment made by Professor Hodges of Belfast on 7770 lb of air-dried flax yielded the following results. By ripping he separated 1946 lb of bolls which yielded 910 lb of seed. The 5824 lb (52 cwt.) of flax straw remaining lost in steeping 13 cwt., leaving 39 cwt. of retted stalks, and from that 6 cwt. 1 qr. 2 lb (702 lb) of finished flax was procured. Thus the weight of the fibre was equal to about 9% of the dried flax with the bolls, 12% of the balled straw, and over 16% of the retted straw. One hundred tons treated by Schenck's method gave 33 tons bolls, with 27.50 tons of loss in steeping; 32.13 tons were separated in scutching, leaving 5.90 tons of finished fibre, with 1.47 tons of tow and pluckings. The following analysis of two varieties of heckled Belgian flax is by Dr Hugo Müller (Hoffmann's *Berichte über die Entwicklung der chemischen Industrie*):—

Ash	0.70	1.32
Water	8.65	10.70
Extractive matter	3.65	6.02
Fat and wax	2.39	2.37
Cellulose	82.57	71.50
Intercellular substance and pectose bodies	2.74	9.41

According to the determinations of Julius Wiesner (*Die Rohstoffe des Pflanzenreiches*), the fibre ranges in length from 20 to 140 centimetres, the length of the individual cells being from 2.0 to 4.0 millimetres, and the limits of breadth between 0.012 and 0.025 mm., the average being 0.016 mm.

Among the circumstances which have retarded improvement both in the growing and preparing of flax, the fact that, till comparatively recent times, the whole industry was conducted only on a domestic scale has had much influence. At no very remote date it was the practice in Scotland for every small farmer and cotter not only to grow "lint" or flax in small patches, but to have it retted, scutched, cleaned, spun, woven, bleached and finished entirely within the limits of his own premises, and all by members or dependents of the family. The same practice obtained and still largely prevails in other countries. Thus the flax industry was long kept away from the most powerful motives to apply to it labour-saving devices, and apart from the influence of scientific inquiry for the improvement of methods and processes. As cotton came to the front, just at the time when machine-spinning and power-loom weaving were being introduced, the result was that in many localities where flax crops had been grown for ages, the culture gradually drooped and ultimately ceased. The linen manufacture by degrees ceased to be a domestic industry, and began to centre in and become the characteristic factory employment of special localities, which depended, however, for their supply of raw material primarily on the operations of small growers, working, for the most part, on the poorer districts of remote thinly populated countries. The cultivation of the plant and the preparation of the fibre have therefore, even at the present day, not come under the influence (except in certain favoured localities) of scientific knowledge and experience.

Cultivation.—The approximate number of acres (1905) under cultivation in the principal flax-growing countries is as follows:—

Russia	3,500,000 acres.
Caucasia	450,000 "
Austria	175,000 "
Italy	120,000 "
Poland	95,000 "
Rumania	80,000 "
Germany	75,000 "
France	65,000 "
Belgium	53,000 "
Hungary	50,000 "
Ireland	46,000 "
Holland	38,000 "

Although the amount grown in Russia exceeds considerably the combined quantity grown in the rest of the above-mentioned countries, the quality of the fibre is inferior. The fibre is cultivated in the Russian provinces of Archangel, Courland, Esthonia, Kostroma, Livonia, Novgorod, Pskov, Smolensk, Tver, Vyatka, Vitebsk, Vologda and Yaroslav or Jaroslav, while the bulk of the material is exported through the Baltic ports. Riga and St Petersburg (including Cronstadt) are the principal ports, but flax is also exported from Revel, Windau, Pernau, Libau, Narva and Konigsberg. Sometimes it is exported from Archangel, but this port is frost-bound for a great period of the year; moreover, most of the districts are nearer to the Baltic.

The raw flax is almost invariably known by the same name as the district in which it is grown, and it is further classified by

The marks in the Crown flaxes have the following signification:—

K	means Crown and is usually the base mark.
H	Light and represents a rise of about £1
P	Picked " " " £3
G	Grey " " " £3
S	Superior " " " £4
W	White " " " £4
Z	Zins " " " £10

Each additional mark means a rise in the price, but it must be understood that it is quite possible for a quality denoted by two letters to be more valuable than one indicated by three or more, since every mark has not the same value.

If we take £25 as the value of the base mark, the value per ton for the different groups would be:—

K	£25	HSPK	£33
HK	£26	GSPK	£35
PK	£28	WSPK	£36
HPK	£29	ZK	£35
GPK	£31	HZK	£36
SPK	£32	GZK	£38, &c.

The Hoffs flaxes are reckoned in a similar way. Here H is for Hoffs, D for Dreiband, P for picked, F for fine, S for superior, and R for Risten. In addition to these marks, an X may appear before, after or in both places. With £20 as base mark we have:—

HD	£20 per ton.
PHD	£23 " "
FPHD	£26 " "
SFPHD	£29 " "
XHDX	£32 " "
XXR	£35 " "

The following Prices, taken from the Dundee Year Books, show the Change in Price of a few well-known Varieties.

	Dec. 1897.	Dec. 1898.	Dec. 1899.	Dec. 1900.	Dec. 1901.	Dec. 1902.	Dec. 1903.	Dec. 1904.	Dec. 1905.	Dec. 1906.
Riga—										
SPK	£ 23½	21 to 22	28 to 32	42	28 to 32	32	39	33	35	32
XHDX	27	26½	32½ to 33	43½	34	35	42	34	36	33
W	16 to 16½	15½ to 16	22½ to 24	31	18 to 19	22	29	23	24	24
St Petersburg—										
Bajetsky	28 to 29	26 to 27	32 to 32½	46	37	33	49	36	42	38
Jaropol	24 to 25	23 to 23½	30	42	32	30	42	33	35	33
Tows—										
Mologin	24 to 24½	23 to 23½	24½ to 25	31½	32	32	42	32	34	32½
Novgorod	23½ to 24½	23	26 to 26½	33	31½	32½	41	31½	37	34½
Archangel—										
½ and ¾ tow	25	24 to 24½	26 to 27	32	31	32	41	31½	32½	31
2nd Codilla	25	24 to 24½	25½ to 26	32	31	32	41	32	33	31

special marks. The following names amongst others are given to the fibre:—Archangel, Bajetsky, Courish, Dorpat, Drogobusher, Dunaberg, Fabrichnoi, Fellin, Gjatsk, Glazoff, Griazourtz, Iwashkower, Jaransk, Janowitz, Jaropol, Jaroslav, Kama, Kashin, Konigsberg, Kostroma, Kotelnitch, Kowns, Krasnoholm, Kurland (Courland), Latischki, Livonian Crowns, Malmuish, Marienberg, Mochenetz, Mologin, Newel, Nikolsky, Nolinsk, Novgorod, Opotchka, Ostroff, Ostrow, Othornoy, Ouglitch, Pernau, Pskoff, Revel, Riga, Rjeff, St Petersburg, Seretz, Slanitz, Slobodskoi, Smolensk, Sytcheffka, Taroslav, Tehesna, Totma, Twer, Ustjuga, Viatka, Vishni, Vologda, Werro, Wiasma, Witebsk.

These names indicate the particular district in which the flax has been grown, but it is more general to group the material into classes such as Livonian Crowns, Rija Crowns, Hoffs, Wracks, Dreiband, Zins, Ristens, Pernau, Archangel, &c.

The quotations for the various kinds of flaxes are made with one or other special mark termed a base mark; this usually, but not necessarily, indicates the lowest quality. The September–October 1906 quotations appeared as under:—

Livonian	basis K	£26 to £27	per ton.
Hoffs	HD	£21 to £22	"
Pernau	D	£28 to £28 : 10	"
Dorpat	D	£32 to £32 : 10	"
	cleaned.		

It will, of course, be understood that the base mark is subject to variation, the ruling factors being the amount of crop, quality and demand.

18 and 2, which means 80 % of one quality and 20 % of another. Sometimes other proportions obtain, while it is not unusual to have quotations for flaxes containing four different kinds.

Of the lower qualities of Riga flax the following may be named:

W, Wrack flax.	PW, Picked wrack flax.
WPW, White picked wrack.	GPW, Grey picked wrack flax.
D, Dreiband (Threeband).	PD, Picked Dreiband flax.
LD, Livonian Dreiband.	PLD, Picked Livonian Dreiband.
SD, Slanitz Dreiband.	PSD, Picked Slanitz Dreiband.

The last-named (SD and PSD) are dew-retted qualities shipped from Riga either as Lithuanian Slanitz, Wellish Slanitz or Wiasma Slanitz, showing from what district they come, as there are differences in the quality of the produce of each district. The lowest quality of Riga flax is marked DW, meaning Dreiband Wrack.

Another Russian port from which a large quantity of flax is imported is Pernau, where the marks in use are comparatively few. The leading marks are:—

LOD, indicating Low Ordinary Dreiband (Threeband).
OD, " Ordinary Dreiband.
D, " Dreiband.
HD, " Light Dreiband.
R, " Risten.
G, " Cut.
M, " Marienburg.

Pernau flax is shipped as Livonian and Fellin sorts, the latter being the best.

Both dew-retted and water-retted flax are exported from St Petersburg, the dew-retted or Slanitz flax being marked 1st, 2nd, 3rd and 4th Crown, also Zebrack No. 1 and Zebrack No. 2, while all the Archangel flax is dew-retted.

Some idea of the extent of the Russian flax trade may be gathered from the fact that 233,000 tons were exported in 1905. Out of this quantity a little over 53,000 tons came to the United Kingdom. The chief British ports for the landing of flax are:—Belfast, Dundee, Leith, Montrose, London and Arbroath, the two former being the chief centres of the flax industry.

The following table, taken from the annual report of the Belfast Flax Supply Association, shows the quantities received from all sources into the different parts of the United Kingdom:—

Year.	Imports to the United Kingdom.	Imports to Ireland.	Imports to England and Scotland.
	Tons.	Tons.	Tons.
1895	102,622	33,506	67,116
1896	95,199	36,650	58,549
1897	98,802	37,715	61,087
1898	97,253	34,440	62,813
1899	99,052	40,145	58,907
1900	71,586	31,563	40,023
1901	75,565	28,785	46,780
1902	73,611	29,727	43,884
1903	94,701	38,168	56,533
1904	74,917	33,024	41,893
1905	90,098	40,063	50,035

The extent of flax cultivation in Ireland is considerable, but the acreage has been gradually diminishing during late years. In 1864 it reached the maximum, 301,693 acres; next year it fell to 251,433. After 1869 it declined, there being 229,252 acres in flax crop that year, and only 122,003 in 1872. From this year to 1889 it fluctuated considerably, reaching 157,534 acres in 1880 and dropping to 89,225 acres in 1884. Then for five successive years the acreage was above 108,000. From 1890 to 1905 it only once reached 100,000, while the average in 1903, 1904 and 1905 was a little over 45,000 acres. (T. Wo.)

FLAXMAN, JOHN (1755-1826), English sculptor and draughtsman, was born on the 6th of July 1755, during a temporary residence of his parents at York. The name John was hereditary in the family, having been borne by his father after a forefather who, according to the family tradition, had fought on the side of parliament at Naseby, and afterwards settled as a carrier or farmer, or both, in Buckinghamshire. John Flaxman, the father of the sculptor, carried on with repute the trade of a moulder and seller of plaster casts at the sign of the Golden Head, New Street, Covent Garden, London. His wife's maiden name was See, and John was their second son. Within six months of his birth the family returned to London, and in his father's back shop he spent an ailing childhood. His figure was high-shouldered and weakly, the head very large for the body. His mother having died about his tenth year, his father took a second wife, of whom all we know is that her maiden name was Gordon, and that she proved a thrifty housekeeper and kind stepmother. Of regular schooling the boy must have had some, since he is reputed as having remembered in after life the tyranny of some pedagogue of his youth; but his principal education he picked up for himself at home. He early took delight in drawing and modelling from his father's stock-in-trade, and early endeavoured to understand those counterfeits of classic art by the light of translations from classic literature.

Customers of his father took a fancy to the child, and helped him with books, advice, and presently with commissions. The two special encouragers of his youth were the painter Romney, and a cultivated clergyman, Mr Mathew, with his wife, in whose house in Rathbone Place the young Flaxman used to meet the best "blue-stocking" society of those days, and, among associates of his own age, the artists Blake and Stothard, who became his closest friends. Before this he had begun to work with precocious success in clay as well as in pencil. At twelve years old he won the first prize of the Society of Arts for a medal, and became a public exhibitor in the gallery of the Free Society of Artists; at fifteen he won a second prize from the Society of Arts and began to exhibit in the Royal Academy, then in the second year of its existence. In the same year, 1770, he entered as an Academy student and won the silver medal. But all these successes were followed by a discomfiture. In the competition for the gold medal of the Academy in 1772, Flaxman, who had made sure of victory, was defeated, the prize being adjudged by the president, Sir Joshua Reynolds, to another competitor named Engleheart. But this reverse proved no discouragement, and indeed seemed to have had a wholesome effect in curing the successful lad of a tendency to conceit and self-sufficiency which made Thomas Wedgwood say of him in 1775: "It is but a few years since he was a most supreme coxcomb."

He continued to ply his art diligently, both as a student in the schools and as an exhibitor in the galleries of the Academy,

occasionally also attempting diversions into the sister art of painting. To the Academy he contributed a wax model of Neptune (1770); four portrait models in wax (1771); a terracotta bust, a wax figure of a child, a figure of History (1772); a figure of Comedy, and a relief of a Vestal (1773). During these years he received a commission from a friend of the Mathew family, for a statue of Alexander. But by heroic and ideal work of this class he could, of course, make no regular livelihood. The means of such a livelihood, however, presented themselves in his twentieth year, when he first received employment from Josiah Wedgwood and his partner Bentley, as a modeller of classic and domestic friezes, plaques, ornamental vessels and medallion portraits, in those varieties of "jasper" and "basalt" ware which earned in their day so great a reputation for the manufacturers who had conceived and perfected the invention. In the same year, 1775, John Flaxman the elder moved from New Street, Covent Garden, to a more commodious house in the Strand (No. 420). For twelve years, from his twentieth to his thirty-second (1775-1787), Flaxman subsisted chiefly by his work for the firm of Wedgwood. It may be urged, of the minute refinements of figure outline and modelling which these manufacturers aimed at in their ware, that they were not the qualities best suited to such a material; or it may be regretted that the gifts of an artist like Flaxman should have been spent so long upon such a minor and half-mechanical art of household decoration; but the beauty of the product it would be idle to deny, or the value of the training which the sculptor by this practice acquired in the delicacies and severities of modelling in low relief and on a minute scale.

By 1780 Flaxman had begun to earn something in another branch of his profession, which was in the future to furnish his chief source of livelihood, viz. the sculpture of monuments for the dead. Three of the earliest of such monuments by his hand are those of Chatterton in the church of St Mary Redcliffe at Bristol (1780), of Mrs Morley in Gloucester cathedral (1784), and of the Rev. T. and Mrs Margaret Ball in the cathedral at Chichester (1785). During the rest of Flaxman's career memorial bas-reliefs of the same class occupied a principal part of his industry; they are to be found scattered in many churches throughout the length and breadth of England, and in them the finest qualities of his art are represented. The best are admirable for pathos and simplicity, and for the alliance of a truly Greek instinct for rhythmical design and composition with that spirit of domestic tenderness and innocence which is one of the secrets of the modern soul.

In 1782, being twenty-seven years old, Flaxman was married to Anne Denman, and had in her the best of helpmates until almost his life's end. She was a woman of attainments in letters and to some extent in art, and the devoted companion of her husband's fortunes and of his travels. They set up house at first in Wardour Street, and lived an industrious life, spending their summer holidays once and again in the house of the hospitable poet Hayley, at Eartham in Sussex. After five years, in 1787, they found themselves with means enough to travel, and set out for Rome, where they took up their quarters in the Via Felice. Records more numerous and more consecutive of Flaxman's residence in Italy exist in the shape of drawings and studies than in the shape of correspondence. He soon ceased modelling himself for Wedgwood, but continued to direct the work of other modellers employed for the manufacture at Rome. He had intended to return after a stay of a little more than two years, but was detained by a commission for a marble group of a Fury of Athamas, a commission attended in the sequel with circumstances of infinite trouble and annoyance, from the notorious Comte-Èvêque, Frederick Hervey, earl of Bristol and bishop of Derry. He did not, as things fell out, return until the summer of 1794, after an absence of seven years,—having in the meantime executed another ideal commission (a "Cephalus and Aurora") for Mr Hope, and having sent home models for several sepulchral monuments, including one in relief for the poet Collins in Chichester cathedral, and one in the round for Lord Mansfield in Westminster Abbey.

But what gained for Flaxman in this interval a general and European fame was not his work in sculpture proper, but those outline designs to the poets, in which he showed not only to what purpose he had made his own the principles of ancient design in vase-paintings and bas-reliefs, but also by what a natural affinity, better than all mere learning, he was bound to the ancients and belonged to them. The designs for the *Iliad* and *Odyssey* were commissioned by Mrs Hare Naylor; those for Dante by Mr Hope; those for Aeschylus by Lady Spencer; they were all engraved by Piroli, not without considerable loss of the finer and more sensitive qualities of Flaxman's own lines.

During their homeward journey the Flaxmans travelled through central and northern Italy. On their return they took a house, which they never afterwards left, in Buckingham Street, Fitzroy Square. Immediately afterwards we find the sculptor publishing a spirited protest against the scheme already entertained by the Directory, and carried out five years later by Napoleon, of equipping at Paris a vast central museum of art with the spoils of conquered Europe.

The record of Flaxman's life is henceforth an uneventful record of private affection and contentment, and of happy and tenacious industry, with reward not brilliant but sufficient, and repute not loud but loudest in the mouths of those whose praise was best worth having—Canova, Schlegel, Fuseli. He took for pupil a son of Hayley's, who presently afterwards sickened and died. In 1797 he was made an associate of the Royal Academy. Every year he exhibited work of one class or another: occasionally a public monument in the round, like those of Paoli (1798), or Captain Montague (1802) for Westminster Abbey, of Sir William Jones for St Mary's, Oxford (1797–1801), of Nelson or Howe for St Paul's; more constantly memorials for churches, with symbolic Acts of Mercy or illustrations of Scripture texts, both commonly in low relief [Miss Morley, Chertsey (1797), Miss Cromwell, Chichester (1800), Mrs Knight, Milton, Cambridge (1802), and many more]; and these pious labours he would vary from time to time with a classical piece like those of his earliest predilection. Soon after his election as associate, he published a scheme, half grandiose, half childish, for a monument to be erected on Greenwich Hill, in the shape of a Britannia 200 ft. high, in honour of the naval victories of his country. In 1800 he was elected full Academician. During the peace of Amiens he went to Paris to see the despoiled treasures collected there, but bore himself according to the spirit of protest that was in him. The next event which makes any mark in his life is his appointment to a chair specially created for him by the Royal Academy—the chair of Sculpture: this took place in 1810. We have ample evidence of his thoroughness and judiciousness as a teacher in the Academy schools, and his professorial lectures have been often reprinted. With many excellent observations, and with one singular merit—that of doing justice, as in those days justice was hardly ever done, to the sculpture of the medieval schools—these lectures lack point and felicity of expression, just as they are reported to have lacked fire in delivery, and are somewhat heavy reading. The most important works that occupied Flaxman in the years next following this appointment were the monument to Mrs Baring in Micheldever church, the richest of all his monuments in relief (1805–1811); that for the Worsley family at Campsall church, Yorkshire, which is the next richest; those to Sir Joshua Reynolds for St Paul's (1807); to Captain Webbe for India (1810); to Captains Walker and Beckett for Leeds (1811); to Lord Cornwallis for Prince of Wales's Island (1812); and to Sir John Moore for Glasgow (1813). At this time the antiquarian world was much occupied with the vexed question of the merits of the Elgin marbles, and Flaxman was one of those whose evidence before the parliamentary commission had most weight in favour of the purchase which was ultimately effected in 1816.

After his Roman period he produced for a good many years no outline designs for the engraver except three for Cowper's translations of the Latin poems of Milton (1810). Other sets of outline illustrations drawn about the same time, but not published, were one to the *Pilgrim's Progress*, and one to a

Chinese tale in verse, called "The Casket," which he wrote to amuse his womenkind. In 1817 we find him returning to his old practice of classical outline illustrations and publishing the happiest of all his series in that kind, the designs to Hesiod, excellently engraved by the sympathetic hand of Blake. Immediately afterwards he was much engaged designing for the goldsmiths—a testimonial cup in honour of John Kemble, and following that, the great labour of the famous and beautiful (though quite un-Homeric) "Shield of Achilles." Almost at the same time he undertook a frieze of "Peace, Liberty and Plenty," for the duke of Bedford's sculpture gallery at Woburn, and an heroic group of Michael overthrowing Satan, for Lord Egremont's house at Petworth. His literary industry at the same time is shown by several articles on art and archaeology contributed to Rees's *Encyclopaedia* (1819–1820).

In 1820 Mrs Flaxman died, after a first warning from paralysis six years earlier. Her younger sister, Maria Denman, and the sculptor's own sister, Maria Flaxman, remained in his house, and his industry was scarcely at all relaxed. In 1822 he delivered at the Academy a lecture in memory of his old friend and generous fellow-craftsman, Canova, then lately dead; in 1823 he received from A. W. von Schlegel a visit of which that writer has left us the record. From an illness occurring soon after this he recovered sufficiently to resume both work and exhibition, but on the 3rd of December 1826 he caught cold in church, and died four days later, in his seventy-second year. Among a few intimate associates, he left a memory singularly dear; having been in companionship, although susceptible and obstinate when his religious creed—a devout Christianity with Swedenborgian admixtures—was crossed or slighted, yet in other things genial and sweet-tempered beyond most men, full of modesty and playfulness and withal of a homely dignity, a true friend and a kind master, a pure and blameless spirit.

Posterity will doubt whether it was the fault of Flaxman or of his age, which in England offered neither training nor much encouragement to a sculptor, that he is weakest when he is most ambitious, and most inspired when he makes the least effort; but so it is. Not merely does he fail when he seeks to illustrate the intensity of Dante, or to rival the tumultuousness of Michelangelo—to be intense or tumultuous he was never made; but he fails, it may almost be said, in proportion as his work is elaborate and far carried, and succeeds in proportion as it is partial and suggestive. Of his completed ideal sculptures, the "St Michael" at Petworth is the best, and is indeed admirably composed from all points of view; but it lacks fire and force, and it lacks the finer touches of the chisel; a little bas-relief like the diploma piece of the "Apollo" and "Marpessa" in the Royal Academy compares with it favourably. This is one of the very few things which he is recorded to have executed in the marble entirely with his own hand; ordinarily he entrusted the finishing work of the chisel to the Italian workmen in his employ, and was content with the smooth mechanical finish which they imitated from the Roman imitations (themselves often reworked at the Renaissance) of Greek originals. Of Flaxman's complicated monuments in the round, such as the three in Westminster Abbey and the four in St Paul's, there is scarcely one which has not something heavy and infelicitous in the arrangement, and something empty and unsatisfactory in the surface execution. But when we come to his simple monuments in relief, in these we find almost always a far finer quality. The truth is that he did not thoroughly understand composition on the great scale and in the round, but he thoroughly understood relief, and found scope in it for his remarkable gifts of harmonious design, and tender, grave and penetrating feeling. But if we would see even the happiest of his conceptions at their best, we must study them, not in the finished marble but rather in the casts from his studio sketches (marred though they have been by successive coats of paint intended for their protection) of which a comprehensive collection is preserved in the Flaxman gallery at University College. And the same is true of his happiest efforts in the classical and poetical vein, like the well-known relief of "Pandora conveyed to Earth by Mercury." Nay.

going farther back still among the rudiments and first conceptions of his art, we can realize the most essential charm of his genius in the study, not of his modelled work at all, but of his sketches in pen and wash on paper. Of these the principal public collections are at University College, in the British Museum, and the Victoria & Albert Museum; many others are dispersed in public and private cabinets. Every one knows the excellence of the engraved designs to Homer, Dante, Aeschylus and Hesiod, in all cases save when the designer aims at that which he cannot hit, the terrible or the grotesque. To know Flaxman at his best it is necessary to be acquainted not only with the original studies for such designs as these (which, with the exception of the Hesiod series, are far finer than the engravings), but still more with those almost innumerable studies from real life which he was continually producing with pen, tint or pencil. These are the most delightful and suggestive sculptor's notes in existence; in them it was his habit to set down the leading and expressive lines, and generally no more, of every group that struck his fancy. There are groups of Italy and London, groups of the parlour and the nursery, of the street, the garden and the gutter; and of each group the artist knows how to seize at once the structural and the spiritual secret, expressing happily the value and suggestiveness, for his art of sculpture, of the contacts, intervals, interlacements and balancings of the various figures in any given group, and not less happily the charm of the affections which link the figures together and inspire their gestures.

The materials for the life of Flaxman are scattered in various biographical and other publications; the principal are the following:—An anonymous sketch in the *European Magazine* for 1823; an anonymous "Brief Memoir," prefixed to *Flaxman's Lectures* (ed. 1829, and reprinted in subsequent editions); the chapter in Allan Cunningham's *Lives of the Most Eminent British Painters, &c.*, vol. iii.; notices in the *Life of Nollekens*, by John Thomas Smith; in the *Life of Josiah Wedgwood*, by Miss G. Meteyard (London, 1865); in the *Diaries and Reminiscences of H. Crabbe Robinson* (London, 1869), the latter an authority of great importance; in the *Lives of Stothard*, by Mrs Bray, of Constable, by Leslie, of Watson, by Dr Lonsdale, and of Blake, by Messrs Gilchrist and Rossetti; a series of illustrated essays, principally on the monumental sculpture of Flaxman, in the *Art Journal* for 1867 and 1868, by Mr G. F. Teniswood; *Essays in English Art*, by Frederick Wedmore; *The Drawings of Flaxman, in 32 plates, with Descriptions, and an Introductory Essay on the Life and Genius of Flaxman*, by Sidney Colvin (London, 1876); and the article "Flaxman" in the *Dictionary of National Biography*. (S. C.)

FLEA (O. Eng. *flēah*, or *flēa*, cognate with *flee*, to run away from, to take flight), a name typically applied to *Pulex irritans*, a well-known blood-sucking insect-parasite of man and other mammals, remarkable for its powers of leaping, and nearly cosmopolitan. In ordinary language the name is used for any species of *Siphonaptera* (otherwise known as *Aphaniptera*), which, though formerly regarded as a suborder of *Diptera* (*q.v.*), are now considered to be a separate order of insects. All *Siphonaptera*, of which more than 100 species are known, are parasitic on mammals or birds. The majority of the species belong to the family *Pulicidae*, of which *P. irritans* may be taken as the type; but the order also includes the *Sarcopsyllidae*, the females of which fix themselves firmly to their host, and the *Ceratopsyllidae*, or bat-fleas.

Fleas are wingless insects, with a laterally compressed body, small and indistinctly separated head, and short thick antennae situated in cavities somewhat behind and above the simple eyes, which are always minute and sometimes absent. The structure of the mouth-parts is different from that seen in any other insects. The actual piercing organs are the mandibles, while the upper lip or labrum forms a sucking tube. The maxillae are not piercing organs, and their function is to protect the mandibles and labrum and separate the hairs or feathers of the host. Maxillary and labial palpi are also present, and the latter, together with the labrum or lower lip, form the rostrum.

Fleas are oviparous, and undergo a very complete metamorphosis. The footless larvae are elongate, worm-like and very active; they feed upon almost any kind of waste animal matter, and when full-grown form a silken cocoon. The human flea is considerably exceeded in size by certain other species found

upon much smaller hosts; thus the European *Hystrichopsylla talpae*, a parasite of the mole, shrew and other small mammals, attains a length of 5½ millimetres; another large species infests the Indian porcupine. Of the *Sarcopsyllidae* the best known species is the "jigger" or "chigoe" (*Dermatophilus penetrans*), indigenous in tropical South America and introduced into West Africa during the second half of last century. Since then this pest has spread across the African continent and even reached Madagascar. The impregnated female jigger burrows into the feet of men and dogs, and becomes distended with eggs until its abdomen attains the size and appearance of a small pea. If in extracting the insect the abdomen be ruptured, serious trouble may ensue from the resulting inflammation. At least four species of fleas (including *Pulex irritans*) which infest the common rat are known to bite man, and are believed to be the active agents in the transmission of plague from rats to human beings. (E. E. A.)

FLÈCHE (French for "arrow"), the term generally used in French architecture for a spire, but more especially employed to designate the timber spire covered with lead, which was erected over the intersection of the roofs over nave and transepts; sometimes these were small and unimportant, but in cathedrals they were occasionally of large dimensions, as in the flèche of Notre-Dame, Paris, where it is nearly 100 ft. high; this, however, is exceeded by the example of Amiens cathedral, which measures 148 ft. from its base on the cresting to its finial.

FLÉCHIER, ESPRIT (1632–1710), French preacher and author, bishop of Nîmes, was born at Pernes, department of Vaucluse, on the 10th of June 1632. He was brought up at Tarascon by his uncle, Hercule Audiffret, superior of the Congrégation des Doctrinaires, and afterwards entered the order. On the death of his uncle, however, he left it, owing to the strictness of its rules, and went to Paris, where he devoted himself to writing poetry. His French poems met with little success, but a description in Latin verse of a tournament (*carrousel, circus regius*), given by Louis XIV. in 1662, brought him a great reputation. He subsequently became tutor to Louis Urbain Lefèvre de Caumartin, afterwards *intendant* of finances and counsellor of state, whom he accompanied to Clermont-Ferrand (*q.v.*), where the king had ordered the *Grands Jours* to be held (1665), and where Caumartin was sent as representative of the sovereign. There Fléchier wrote his curious *Mémoires sur les Grand Jours tenus à Clermont*, in which he relates, in a half romantic, half historical form, the proceedings of this extraordinary court of justice. In 1668 the duke of Montausier procured for him the post of *lecteur* to the dauphin. The sermons of Fléchier increased his reputation, which was afterwards raised to the highest pitch by his funeral orations. The most important are those on Madame de Montausier (1672), which gained him the membership of the Academy, the duchesse d'Aiguillon (1675), and, above all, Marshal Turenne (1676). He was now firmly established in the favour of the king, who gave him successively the abbacy of St Séverin, in the diocese of Poitiers, the office of almoner to the dauphiness, and in 1685 the bishopric of Lavaur, from which he was in 1687 promoted to that of Nîmes. The edict of Nantes had been repealed two years before; but the Calvinists were still very numerous at Nîmes. Fléchier, by his leniency and tact, succeeded in bringing over some of them to his views, and even gained the esteem of those who declined to change their faith. During the troubles in the Cévennes (see HUGUENOTS) he softened to the utmost of his power the rigour of the edicts, and showed himself so indulgent even to what he regarded as error, that his memory was long held in veneration amongst the Protestants of that district. It is right to add, however, that some authorities consider the accounts of his leniency to have been greatly exaggerated, and even charge him with going beyond what the edicts permitted. He died at Montpellier on the 16th of February 1710. Pulpit eloquence is the branch of belles-lettres in which Fléchier excelled. He is indeed far below Bossuet, whose robust and sublime genius had no rival in that age; he does not equal Bourdaloue in earnestness of thought and vigour of expression; nor can he rival the philosophical depth or the insinuating and

impressive eloquence of Massillon. But he is always ingenious, often witty, and nobody has carried farther than he the harmony of diction, sometimes marred by an affectation of symmetry and an excessive use of antithesis. His two historical works, the histories of Theodosius and of Ximenes, are more remarkable for elegance of style than for accuracy and comprehensive insight.

The last complete edition of Fléchier's works is by J. P. Migne (Paris, 1856); the *Mémoires sur les Grands Jours* was first published in 1844 by B. Gonod (2nd ed. as *Mém. sur les Gr. J. d'Auvergne*, with notice by Sainte-Beuve and an appendix by M. Chéruel, 1862). His chief works are: *Histoire de Théodose le Grand, Oraisons funèbres, Histoire du Cardinal Ximènes, Sermons de morale, Panégyriques des saints*. He left a *portrait or caractère* of himself, addressed to one of his friends. The *Life of Theodosius* has been translated into English by F. Manning (1693), and the "Funeral Oration of Marshal Turenne" in H. C. Fish's *History and Repository of Pulpit Eloquence* (ii., 1857). On Fléchier generally see Antonin V. D. Fabre, *La Jeunesse de Fléchier* (1882), and Adolphe Fabre, *Fléchier, orateur* (1886); A. Delacroix, *Hist. de Fléchier* (1865).

FLECKEISEN, CARL FRIEDRICH WILHELM ALFRED (1820–1899), German philologist and critic, was born at Wolfenbüttel on the 23rd of September 1820. He was educated at the Helmstedt gymnasium and the university of Göttingen. After holding several educational posts, he was appointed in 1861 to the vice-principalship of the Vitzthum'sches Gymnasium at Dresden, which he held till his retirement in 1889. He died on the 7th of August 1899. Fleckeisen is chiefly known for his labours on Plautus and Terence; in the knowledge of these authors he was unrivalled, except perhaps by Ritschl, his life-long friend and a worker in the same field. His chief works are: *Exercitationes Plautinae* (1842), one of the most masterly productions on the language of Plautus; "Analecta Plautina," printed in *Philologus*, ii. (1847); *Plauti Comoediae*, i., ii. (1850–1851, unfinished), introduced by an *Epistula critica ad F. Ritschlium*; *P. Terentii Afri Comoediae* (new ed., 1898). In his editions he endeavoured to restore the text in accordance with the results of his researches on the usages of the Latin language and metre. He attached great importance to the question of orthography, and his short treatise *Fünfszig Artikel* (1861) is considered most valuable. Fleckeisen also contributed largely to the *Jahrbücher für Philologie*, of which he was for many years editor.

See obituary notice by G. Götz in C. Bursian's *Biographisches Jahrbuch für Altertumskunde* (xxiii., 1901), and article by H. Usener in *Allgemeine deutsche Biographie* (where the date of birth is given as the 20th of September).

FLECKNOE, RICHARD (c. 1600–1678?), English dramatist and poet, the object of Dryden's satire, was probably of English birth, although there is no corroboration of the suggestion of J. Gillow (*Bibliog. Dict. of the Eng. Catholics*, vol. ii., 1885), that he was a nephew of a Jesuit priest, William Flecknoe, or more properly Flexney, of Oxford. The few known facts of his life are chiefly derived from his *Relation of Ten Years' Travels in Europe, Asia, Afrique and America* (1655?), consisting of letters written to friends and patrons during his travels. The first of these is dated from Ghent (1640), whither he had fled to escape the troubles of the Civil War. In Brussels he met Béatrix de Cosenza, wife of Charles IV., duke of Lorraine, who sent him to Rome to secure the legalization of her marriage. There in 1645 Andrew Marvell met him, and described his leanness and his rage for versifying in a witty satire, "Flecknoe, an English Priest at Rome." He was probably, however, not in priest's orders. He then travelled in the Levant, and in 1648 crossed the Atlantic to Brazil, of which country he gives a detailed description. On his return to Europe he entered the household of the duchess of Lorraine in Brussels. In 1645 he went back to England. His royalist and Catholic convictions did not prevent him from writing a book in praise of Oliver Cromwell, *The Idea of His Highness Oliver . . .* (1659), dedicated to Richard Cromwell. This publication was discounted at the restoration by the *Heroick Portraits* (1660) of Charles II. and others of the Stuart family. John Dryden used his name as a stalking horse from behind which to assail Thomas Shadwell in *Mac Flecknoe* (1682). The opening lines run:—

"All human things are subject to decay,
And, when fate summons, monarchs must obey.
This Flecknoe found, who, like Augustus, young
Was called to empire, and had governed long;
In prose and verse was owned, without dispute,
Throughout the realms of nonsense, absolute."

Dryden's aversion seems to have been caused by Flecknoe's affectation of contempt for the players and his attacks on the immorality of the English stage. His verse, which hardly deserved his critic's sweeping condemnation, was much of it religious, and was chiefly printed for private circulation. None of his plays was acted except *Love's Dominion*, announced as a "pattern for the reformed stage" (1654), that title being altered in 1664 to *Love's Kingdom*, with a *Discourse of the English Stage*. He amused himself, however, by adding lists of the actors whom he would have selected for the parts, had the plays been staged. Flecknoe had many connexions among English Catholics, and is said by Gerard Langbaine, to have been better acquainted with the nobility than with the muses. He died probably about 1678.

A Discourse of the English Stage, was reprinted in W. C. Hazlitt's *English Drama and Stage* (Roxburghe Library, 1869); Robert Southey, in his *Omniana* (1812), protested against the wholesale depreciation of Flecknoe's works. See also "Richard Flecknoe" (Leipzig, 1905, in *Münchener Beiträge zur . . . Philologie*), by A. Lohr, who has given minute attention to his life and works.

FLEET, a word in all its significances, derived from the root of the verb "to fleet," from O. Eng. *fleolan*, to float or flow, which ultimately derives from an Indo-European root seen in Gr. *πλέειν*, to sail, and Lat. *pluere*, to rain; cf. Dutch *vlicssen*, and Ger. *fliesen*. In English usage it survives in the name of many places, such as Byfleet and Northfleet, and in the Fleet, a stream in London that formerly ran into the Thames between the bottom of Ludgate Hill and the present Fleet Street. From the idea of "float" comes the application of the word to ships, when in company, and particularly to a large number of warships under the supreme command of a single officer, with the individual ships, or groups of ships, under individual and subordinate command. The distinction between a fleet and a squadron is often one of name only. In the British navy the various main divisions are or have been called fleets and squadrons indifferently. The word is also frequently used of a company of fishing vessels, and in fishing is also applied to a row of drift-nets fastened together. From the original meaning of the word "flowing" comes the adjectival use of the word, swift, or speedy; so also "fleeting," of something evanescent or fading away, with the idea of the fast-flowing lapse of time.

FLEET PRISON, an historic London prison, formerly situated on the east side of Farringdon Street, and deriving its name from the Fleet stream, which flowed into the Thames. Concerning its early history little is known, but it certainly dated back to Norman times. It came into particular prominence from being used as a place of reception for persons committed by the Star Chamber, and, afterwards, for debtors, and persons imprisoned for contempt of court by the court of chancery. It was burnt down in the great fire of 1666; it was rebuilt, but was destroyed in the Gordon riots of 1780 and again rebuilt in 1781–1782. In pursuance of an act of parliament (5 & 6 Vict. c. 22, 1842), by which the Marshalsea, Fleet, and Queen's Bench prisons were consolidated into one under the name of Queen's prison, it was finally closed, and in 1844 sold to the corporation of the city of London, by whom it was pulled down. The head of the prison was termed "the warden," who was appointed by patent. It became a frequent practice of the holder of the patent to "farm out" the prison to the highest bidder. It was this custom which made the Fleet prison long notorious for the cruelties inflicted on prisoners. One purchaser of the office was of particularly evil repute, by name Thomas Bambridge, who in 1728 paid, with another, the sum of £5000 to John Huggins for the wardenship. He was guilty of the greatest extortions upon prisoners, and, in the words of a committee of the House of Commons appointed to inquire into the state of the gaols of the kingdom, "arbitrarily and unlawfully loaded with irons, put into dungeons,

and destroyed prisoners for debt, treating them in the most barbarous and cruel manner, in high violation and contempt of the laws of this kingdom." He was committed to Newgate, and an act was passed to prevent his enjoying the office of warden or any other office whatsoever. The liberties or rules of the Fleet were the limits within which particular prisoners were allowed to reside outside the prison walls on observing certain conditions.

Fleet Marriages.—By the law of England a marriage was recognized as valid, so long as the ceremony was conducted by a person in holy orders, even if those orders were not of the Church of England. Neither banns nor licence were necessary, and the time and place were alike immaterial. Out of this state of the marriage law, in the period of laxness which succeeded the Commonwealth, resulted innumerable clandestine marriages. They were contracted at first to avoid the expenses attendant on the public ceremony, but an act of 1696, which imposed a penalty of £100 on any clergyman who celebrated, or permitted another to celebrate, a marriage otherwise than by banns or licence, acted as a considerable check. To clergymen imprisoned for debt in the Fleet, however, such a penalty had no terrors, for they had "neither liberty, money nor credit to lose by any proceedings the bishop might institute against them." The earliest recorded date of a Fleet marriage is 1613, while the earliest recorded in a Fleet register took place in 1674, but it was only on the prohibition of marriage without banns or licence that they began to be clandestine. Then arose keen competition, and "many of the Fleet parsons and tavern-keepers in the neighbourhood fitted up a room in their respective lodgings or houses as a chapel," and employed touts to solicit custom for them. The scandal and abuses brought about by these clandestine marriages became so great that they became the object of special legislation. In 1753 Lord Hardwicke's Act (26 Geo. ii. c. 33) was passed, which required, under pain of nullity, that banns should be published according to the rubric, or a licence obtained, and that, in either case, the marriage should be solemnized in church; and that in the case of minors, marriage by licence must be by the consent of parent or guardian. This act had the effect of putting a stop to these clandestine marriages, so far as England was concerned, and henceforth couples had to fare to Gretna Green (*q.v.*).

The *Fleet Registers*, consisting of "about two or three hundred large registers" and about a thousand rough or "pocket" books, eventually came into private hands, but were purchased by the government in 1821, and are now deposited in the office of the registrar-general, Somerset House. Their dates range from 1686 to 1754. In 1840 they were declared not admissible as evidence to prove a marriage.

AUTHORITIES.—J. S. Burn, *The Fleet Registers; comprising the History of Fleet Marriages, and some Account of the Parsons and Marriage-house Keepers, &c.* (London, 1833); J. Ashton, *The Fleet: its River, Prison and Marriages* (London, 1888).

FLEETWOOD, CHARLES (d. 1692), English soldier and politician, third son of Sir Miles Fleetwood of Aldwinkle, Northamptonshire, and of Anne, daughter of Nicholas Luke of Woodend, Bedfordshire, was admitted into Gray's Inn on the 30th of November 1638. At the beginning of the Great Rebellion, like many other young lawyers who afterwards distinguished themselves in the field, he joined Essex's life-guard, was wounded at the first battle of Newbury, obtained a regiment in 1644 and fought at Naseby. He had already been appointed receiver of the court of wards, and in 1646 became member of parliament for Marlborough. In the dispute between the army and parliament he played a chief part, and was said to have been the principal author of the plot to seize King Charles at Holmby, but he did not participate in the king's trial. In 1649 he was appointed a governor of the Isle of Wight, and in 1650, as lieutenant-general of the horse, took part in Cromwell's campaign in Scotland and assisted in the victory of Dunbar. The next year he was elected a member of the council of state, and being recalled from Scotland was entrusted with the command of the forces in England, and played a principal part in gaining the

final triumph at Worcester. In 1652 he married¹ Cromwell's daughter, Bridget, widow of Ireton, and was made commander-in-chief in Ireland, to which title that of lord deputy was added. The chief feature of his administration, which lasted from September 1652 till September 1655, was the settlement of the soldiers on the confiscated estates and the transplantation of the original owners, which he carried out ruthlessly. He showed also great severity in the prosecution of the Roman Catholic priests, and favoured the Anabaptists and the extreme Puritan sects to the disadvantage of the moderate Presbyterians, exciting great and general discontent, a petition being finally sent in for his recall.

Fleetwood was a strong and unswerving follower of Cromwell's policy. He supported his assumption of the protectorate and his dismissal of the parliaments. In December 1654 he became a member of the council, and after his return to England in 1655 was appointed one of the major-generals. He approved of the "Petition and Advice," only objecting to the conferring of the title of king on Cromwell; became a member of the new House of Lords; and supported ardently Cromwell's foreign policy in Europe, based on religious divisions, and his defence of the Protestants persecuted abroad. He was therefore, on Cromwell's death, naturally regarded as a likely successor, and it is said that Cromwell had in fact so nominated him. He, however, gave his support to Richard's assumption of office, but allowed subsequently, if he did not instigate, petitions from the army demanding its independence, and finally compelled Richard by force to dissolve parliament. His project of re-establishing Richard in close dependence upon the army met with failure, and he was obliged to recall the Long Parliament on the 6th of May 1659. He was appointed immediately a member of the committee of safety and of the council of state, and one of the seven commissioners for the army, while on the 9th of June he was nominated commander-in-chief. In reality, however, his power was undermined and was attacked by parliament, which on the 11th of October declared his commission void. The next day he assisted Lambert in his expulsion of the parliament and was reappointed commander-in-chief. On Monk's approach from the North, he stayed in London and maintained order. While hesitating with which party to ally his forces, and while on the point of making terms with the king, the army on the 24th of December restored the Rump, when he was deprived of his command and ordered to appear before parliament to answer for his conduct. The Restoration therefore took place without him. He was included among the twenty liable to penalties other than capital, and was finally incapacitated from holding any office of trust. His public career then closed, though he survived till the 4th of October 1692.

FLEETWOOD, WILLIAM (1656–1723), English divine, was descended of an ancient Lancashire family, and was born in the Tower of London on New Year's Day 1656. He received his education at Eton and at King's College, Cambridge. About the time of the Revolution he took orders, and was shortly afterwards made rector of St Austin's, London, and lecturer of St Dunstan's in the West. He became a canon of Windsor in 1702, and in 1708 he was nominated to the see of St Asaph, from which he was translated in 1714 to that of Ely. He died at Tottenham, Middlesex, on the 4th of August 1723. Fleetwood was regarded as the best preacher of his time. He was accurate in learning, and effective in delivery, and his character stood deservedly high in general estimation. In episcopal administration he far excelled most of his contemporaries. He was a zealous Hanoverian, and a favourite with Queen Anne in spite of his Whiggism. His opposition to the doctrine of non-resistance brought him into conflict with the tory ministry of 1712 and with Swift, but he never entered into personal controversy.

His principal writings are—*An Essay on Miracles* (1701); *Chronicon preciosum* (an account of the English coinage, 1707); and *Free Sermons* (1712), containing discourses on the death of Queen Mary,

¹ He had lost his first wife, Frances Smith; and later he had a third wife, Mary, daughter of Sir John Coke and widow of Sir Edward Hartopp.

the duke of Gloucester and King William. The preface to this last was condemned to public burning by parliament, but, as No. 384 of *The Spectator*, circulated more widely than ever. A collected edition of his works, with a biographical preface, was published in 1737.

FLEETWOOD, a seaport and watering-place in the Blackpool parliamentary division of Lancashire, England, at the mouth of the Wyre, 230 m. N.W. by N. from London, the terminus of a joint branch of the London & North-Western and Lancashire & Yorkshire railways. Pop. (1891) 9274; (1901) 12,082. It dates its rise from 1836, and takes its name from Sir Peter Hesketh Fleetwood, by whom it was laid out. The seaward views, especially northward over Morecambe Bay, are fine, but the neighbouring country is flat and of little interest. The two railways jointly are the harbour authority. The dock is provided with railways and machinery for facilitating traffic, including a large grain elevator. The shipping traffic is chiefly in the coasting and Irish trade. Passenger steamers serve Belfast and Londonderry regularly, and the Isle of Man and other ports during the season. The fisheries are important, and there are salt-works in the neighbourhood. There is a pleasant promenade, with other appointments of a watering-place. There are also barracks with a military hospital and a rifle range. Rossall school, to the S.W., is one of the principal public schools in the north of England. Rossall Hall was the seat of Sir Peter Fleetwood, but was converted to the uses of the school on its foundation in 1844. The school is primarily divided into classical and modern sides, with a special department for preparation for army, navy or professional examinations. A number of entrance scholarships and leaving scholarships tenable at the universities are offered annually. The number of boys is about 350.

FLEGEL, EDWARD ROBERT (1855–1886), German traveller in West Africa, was born on the 1st of October 1855 at Wilna, Russia. After receiving a commercial education he obtained in 1875 a position in Lagos, West Africa. In 1879 he ascended the Benue river some 125 m. above the farthest point hitherto reached. His careful survey of the channel secured him a commission from the German African Society to explore the whole Benue district. In 1880 he went up the Niger to Gomba, and then visited Sokoto, where he obtained a safe-conduct from the sultan for his intended expedition to Adamawa. This expedition was undertaken in 1882, and on the 18th of August in that year Flegel discovered the source of the Benue at Ngaundere. In 1883–1884 he made another journey up the Benue, crossing for the second time the Benue-Congo watershed. After a short absence in Europe Flegel returned to Africa in April 1885 with a commission from the German African Company and the Colonial Society to open up the Niger-Benue district to German trade. This expedition had the support of Prince Bismarck, who endeavoured, unsuccessfully, to obtain for Germany this region, already secured as a British sphere of influence by the National African Company (the Royal Niger Company). Flegel, despite a severe illness, ascended the Benue to Yola, but was unable to accomplish his mission. He returned to the coast and died at Brass, at the mouth of the Niger, on the 11th of September 1886. (See further **GOLDIE, SIR GEORGE**.)

Flegel wrote *Lose Blätter aus dem Tagebuche meiner Haussaafreunde* (Hamburg, 1885), and *Vom Niger-Benue. Briefe aus Afrika* (edited by K. Flegel, Leipzig, 1890).

FLEISCHER, HEINRICH LEBERECHE (1801–1888), German Orientalist, was born at Schandau, Saxony, on the 21st of February 1801. From 1819 to 1824 he studied theology and oriental languages at Leipzig, subsequently continuing his studies in Paris. In 1836 he was appointed professor of oriental languages at Leipzig University, and retained this post till his death. His most important works were editions of Abulfeda's *Historia ante-Islamica* (1831–1834), and of Beidhawi's *Commentary on the Koran* (1846–1848). He compiled a catalogue of the oriental MSS. in the royal library at Dresden (1831); published an edition and German translation of Ali's *Hundred Sayings* (1837); the continuation of Babicht's edition of *The Thousand and One Nights* (vols. ix.-xii., 1842–1843); and an

edition of Mahommed Ibrhim's *Persian Grammar* (1847). He also wrote an account of the Arabic, Turkish and Persian MSS. at the town library in Leipzig. He died there on the 10th of February 1888. Fleischer was one of the eight foreign members of the French Academy of Inscriptions and a knight of the German *Ordre pour le mérite*.

FLEMING, PAUL (1609–1640), German poet, was born at Hartenstein in the Saxon Erzgebirge, on the 5th of October 1609, the son of the village pastor. At the age of fourteen he was sent to school at Leipzig and subsequently studied medicine at the university. Driven away by the troubles of the Thirty Years' War, he was fortunate enough to become attached to an embassy despatched in 1634 by Duke Frederick of Holstein-Gottorp to Russia and Persia, and to which the famous traveller Adam Olearius was secretary. In 1639 the mission returned to Reval, and here Fleming, having become betrothed, determined to settle as a physician. He proceeded to Leiden to procure a doctor's diploma, but died suddenly at Hamburg on his way home on the 2nd of April 1640.

Though belonging to the school of Martin Opitz, Fleming is distinguished from most of his contemporaries by the ring of genuine feeling and religious fervour that pervades his lyric poems, even his occasional pieces. In the sonnet, his favourite form of verse, he was particularly happy. Among his religious poems the hymn beginning "In allen meinen Taten lass ich den Höchsten raten" is well known and widely sung.

Fleming's *Teutsche Poëmata* appeared posthumously in 1642; they are edited by J. M. Lappenberg, in the *Bibliothek des litterarischen Vereins* (2 vols., 1863; a third volume, 1866, contains Fleming's Latin poems). Selections have been edited by J. Tittmann in the second volume of the series entitled *Deutsche Dichter des siebzehnten Jahrhunderts* (Leipzig, 1870), and by H. Österley (Stuttgart, 1885). A life of the poet will be found in Varnhagen von Ense's *Biographische Denkmale*, Bd. iv. (Berlin, 1826). See also J. Straumer, *Paul Flemings Leben und Orientreise* (1892); L. G. Wysocky, *De Pauli Flemingi Germanice scriptis et ingenio* (Paris, 1892).

FLEMING, RICHARD (d. 1431), bishop of Lincoln, and founder of Lincoln College, Oxford, was born at Crofton in Yorkshire. He was descended from a good family, and was educated at University College, Oxford. Having taken his degrees, he was made prebendary of York in 1406, and the next year was junior proctor of the university. About this time he became an ardent Wycliffite, winning over many persons, some of high rank, to the side of the reformer, and incurring the censure of Archbishop Arundel. He afterwards became one of Wycliffe's most determined opponents. Before 1415 he was instituted to the rectory of Boston in Lincolnshire, and in 1420 he was consecrated bishop of Lincoln. In 1428–1429 he attended the councils of Pavia and Siena, and in the presence of the pope, Martin V., made an eloquent speech in vindication of his native country, and in eulogy of the papacy. It was probably on this occasion that he was named chamberlain to the pope. To Bishop Fleming was entrusted the execution of the decree of the council for the exhumation and burning of Wycliffe's remains. The see of York being vacant, the pope conferred it on Fleming; but the king (Henry V.) refused to confirm the appointment. In 1427 Fleming obtained the royal licence empowering him to found a college at Oxford for the special purpose of training up disputants against Wycliffe's heresy. He died at Sleaford, on the 26th of January 1431. Lincoln College was, however, completed by his trustees, and its endowments were afterwards augmented by various benefactors.

FLEMING, SIR SANDFORD (1827–), Canadian engineer and publicist, was born at Kirkcaldy, Scotland, on the 7th of January 1827, but emigrated to Canada in 1845. Great powers of work and thoroughness in detail brought him to the front, and he was from 1867 to 1880 chief engineer of the Dominion government. Under his control was constructed the Intercolonial railway, and much of the Canadian Pacific. After his retirement in 1880 he devoted himself to the study of Canadian and Imperial problems, such as the unification of time reckoning throughout the world, and the construction of a state-owned system of telegraphs throughout the British empire. After

years of labour he saw the first link forged in the chain, in the opening in 1902 of the Pacific Cable between Canada and Australia. Though not a party man he strongly advocated Federation in 1864-1867, and in 1891 vehemently attacked the Liberal policy of unrestricted reciprocity with the United States. He took the deepest interest in education, and in 1880 became chancellor of Queen's University, Kingston.

He published *The Intercolonial: a History* (Montreal and London, 1876); *England and Canada* (London, 1884); and numerous brochures and magazine articles on scientific, social and political subjects.

FLEMING, SIR THOMAS (1544-1613), English judge, was born at Newport, Isle of Wight, in April 1544, and was called to the bar at Lincoln's Inn in 1574. He represented Winchester in parliament from 1584 to 1601, when he was returned for Southampton. In 1594 he was appointed recorder of London, and in 1595 was chosen solicitor-general in preference to Bacon. This office he retained under James I. and was knighted in 1603. In 1604 he was created chief baron of the exchequer and presided over many important state trials. In 1607 he was promoted to the chief justiceship of the king's bench, and was one of the judges at the trial of the *post-nati* in 1608, siding with the majority of the judges in declaring that persons born in Scotland after the accession of James I. were entitled to the privileges of natural-born subjects in England. He was praised by his contemporaries, more particularly Coke, for his "great judgments, integrity and discretion." He died on the 7th of August 1613 at his seat, Stoneham Park, Hampshire.

See Foss, *Lives of the Judges*.

FLEMISH LITERATURE. The older Flemish writers are dealt with in the article on DUTCH LITERATURE; after the separation of Belgium, however, from the Netherlands in 1830 there was a great revival of Flemish literature. The immediate result of the revolution was a reaction against everything associated with Dutch, and a disposition to regard the French language as the speech of liberty and independence. The provisional government of 1830 suppressed the official use of the Flemish language, which was relegated to the rank of a patois. For some years before 1830 Jan Frans Willems¹ (1793-1846) had been advocating the claims of the Flemish language. He had done his best to allay the irritation between Holland and Belgium and to prevent a separation. As archivist of Antwerp he made use of his opportunities by writing a history of Flemish letters. After the revolution his Dutch sympathies had made it necessary for him to live in seclusion, but in 1835 he settled at Ghent, and devoted himself to the cultivation of Flemish. He edited old Flemish classics, *Reinaert de Vos* (1836), the rhyming Chronicles of Jan van Heelu and Jan le Clerc, &c., and gathered round him a band of Flemish enthusiasts, the chevalier Philipp Blommaert (1800-1871), Karel Lodewijk Ledeganck (1805-1847), Fr. Rens (1805-1874), F. A. Snellaert (1809-1872), Prudens van Duyse (1804-1859), and others. Blommaert, who was born at Ghent on the 27th of August 1809, founded in 1834 in his native town the *Nederduitsche letteroefeningen*, a review for the new writers, and it was speedily followed by other Flemish organs, and by literary societies for the promotion of Flemish. In 1851 a central organization for the Flemish propaganda was provided by a society, named after the father of the movement, the "Willemsfonds." The Catholic Flemings founded in 1874 a rival "Davidsfonds," called after the energetic J. B. David (1801-1866), professor at the university of Louvain, and the author of a Flemish history of Belgium (*Vaderlandsche historie*, Louvain, 1842-1866). As a result of this propaganda the Flemish language was placed on an equality with French in law, and in administration, in 1873 and 1878, and in the schools in 1883. Finally in 1886 a Flemish Academy was established by royal authority at Ghent, where a course in Flemish literature had been established as early as 1854.

The claims put forward by the Flemish school were justified by the appearance (1837) of *In't Wonderjaar 1566* (In the Wonder-

ful year) of Hendrik Conscience (*q.v.*), who roused national enthusiasm by describing the heroic struggles of the Flemings against the Spaniards. Conscience was eventually to make his greatest successes in the description of contemporary Flemish life, but his historical romances and his popular history of Flanders helped to give a popular basis to a movement which had been started by professors and scholars.

The first poet of the new school was Ledeganck, the best known of whose poems are those on the "three sister cities" of Bruges, Ghent and Antwerp (*Die drie zustersteden, vaderlandsche trilogie*, Ghent, 1846), in which he makes an impassioned protest against the adoption of French ideas, manners and language, and the neglect of Flemish tradition. The book speedily took its place as a Flemish classic. Ledeganck, who was a magistrate, also translated the French code into Flemish. Jan Theodoor van Rijswijck (1811-1849), after serving as a volunteer in the campaign of 1830, settled down as a clerk in Antwerp, and became one of the hottest champions of the Flemish movement. He wrote a series of political and satirical songs, admirably suited to his public. The romantic and sentimental poet, Jan van Beers (*q.v.*), was typically Flemish in his sincere and moral outlook on life. Prudens van Duyse, whose most ambitious work was the epic *Artavelde* (1859), is perhaps best remembered by a collection (1844) of poems for children. Peter Frans Van Kerckhoven (1818-1857), a native of Antwerp, wrote novels, poems, dramas, and a work on the Flemish revival (*De Vlaemsche Beweging*, 1847).

Antwerp produced a realistic novelist in Jan Lambrecht Damien Sleenckx (1818-1901). An inspector of schools by profession, he was an indefatigable journalist and literary critic. He was one of the founders in 1844 of the *Vlaemsch België*, the first daily paper in the Flemish interest. His works include a long list of plays, among them *Jan Steen* (1852), a comedy; *Grètry*, which gained a national prize in 1861; *De Visschers van Blankenberg* (1863); and the patriotic drama of *Zannekin* (1865). His talent as a novelist was diametrically opposed to the idealism of Conscience. He was precise, sober and concrete in his methods, relying for his effect on the accumulation of carefully observed detail. He was particularly successful in describing the life of the shipping quarter of his native town. Among his novels are: *In't Schipperskwartier* (1856), *Dirk Meyer* (1860), *Tybaerts en K'se* (1867), *Kunst en Liefde* ("Art and Love," 1870), and *Vesalius in Spanje* (1895). His complete works were collected in 17 vols. (1877-1884).

Jan Renier Snieders (1812-1888) wrote novels dealing with North Brabant; his brother, August Snieders (b. 1825), began by writing historical novels in the manner of Conscience, but his later novels are satires on contemporary society. A more original talent was displayed by Anton Bergmann (1835-1874), who, under the pseudonym of "Tony," wrote *Ernest Staas, Advocaat*, which gained the quinquennial prize of literature in 1874. In the same year appeared the *Novellen* of the sisters Rosalie (1834-1875) and Virginie Loveling (b. 1836). These simple and touching stories were followed by a second collection in 1876. The sisters had published a volume of poems in 1870. Virginie Loveling's gifts of fine and exact observation soon placed her in the front rank of Flemish novelists. Her political sketches, *In onze Vlaamsche gewesten* (1877), were published under the name of "W. G. E. Walter." *Sophie* (1885), *Een dure Eed* (1892), and *Het Land der Verbeelding* (1896) are among the more famous of her later works. Reimond Styns (b. 1850) and Isidoor Teirlinck (b. 1851) produced in collaboration one very popular novel, *Arm Vlaanderen* (1884), and some others, and have since written separately. Cyril Buysse, a nephew of Mme Loveling, is a disciple of Zola. *Het Recht van den Sterkste* ("The Right of the Strongest," 1893) is a picture of vagabond life in Flanders; *Schoppenboer* ("The Knave of Spades," 1898) deals with brutalized peasant life; and *Sursum corda* (1895) describes the narrowness and religiosity of village life.

In poetry Julius de Geyter (b. 1830), author of a rhymed translation of *Reinaert* (1874), an epic poem on Charles V. (1888), &c., produced a social epic in three parts, *Drie menschen van in*

¹See Max Rooses, *Keus van Dicht- en Prozewerken van J. F. Willems*, and his *Brieven* in the publications of the Willemsfonds (Ghent, 1872-1874).

de wieg tot in het graf ("Three Men from the Cradle to the Grave," 1861), in which he propounded radical and humanitarian views. The songs of Julius Vuylsteke (1836-1903) are full of liberal and patriotic ardour; but his later life was devoted to politics rather than literature. He had been the leading spirit of a students' association at Ghent for the propagation of "*flamingant*" views, and the "Willemsfonds" owed much of its success to his energetic co-operation. His *Uit het studenten leven* appeared in 1868, and his poems were collected in 1881. The poems of Mme van Ackere (1803-1884), *née* Maria Doolacghe, were modelled on Dutch originals. Joanna Courtmans (1811-1890), *née* Berchmans, owed her fame rather to her tales than her poems; she was above all a moralist, and her fifty tales are sermons on economy and the practical virtues. Other poets were Emmanuel Hiel (*q.v.*), author of comedies, opera libretti and some admirable songs; the abbé Guido Gezelle (1830-1899), who wrote religious and patriotic poems in the dialect of West Flanders; Lodewijk de Koninck (b. 1838), who attempted a great epic subject in *Menschdom Verlost* (1872); J. M. Dautzenberg (1808-1869), author of a volume of charming *Volksliederen*. The best of Dautzenberg's work is contained in the posthumous volume of 1869, published by his son-in-law, Frans de Cort (1834-1878), who was himself a song-writer, and translated songs from Burns, from Jasmin and from the German. The *Makamen en Ghazelen* (1866), adapted from Rückert's version of Hariri, and other volumes by "Jan Ferguut" (J. A. van Droogenbroeck, b. 1835) show a growing preoccupation with form, and with the work of Theodoor Antheunis (b. 1840), they prepare the way for the ingenious and careful workmanship of the younger school of poets, of whom Charles Polydore de Mont is the leader. He was born at Wambeke in Brabant in 1857, and became professor in the academy of the fine arts at Antwerp. He introduced something of the ideas and methods of contemporary French writers into Flemish verse; and explained his theories in 1898 in an *Inleiding tot de Poëzie*. Among Pol de Mont's numerous volumes of verse dating from 1877 onwards are *Claribella* (1893), and *Iris* (1894), which contain amongst other things a curious "*Uit de Legende van Jeschoea-ben-Jossef*," a version of the gospel story from a Jewish peasant.

Mention should also be made of the history of Ghent (*Gent van den vroegsten Tijd tot heden*, 1882-1889) of Frans de Potter (b. 1834), and of the art criticisms of Max Rooses (b. 1839), curator of the Plantin museum at Antwerp, and of Julius Sabbe (b. 1846).

See Ida van Düringsfeld, *Von der Schelde bis zur Maas. Das geistige Leben der Vlamingen* (Leipzig, 3 vols., 1861); J. Stecher, *Histoire de la littérature néerlandaise en Belgique* (1886); *Geschiedenis der Vlaamsche Letterkunde van het jaar 1830 tot heden* (1899), by Theodoor Coopman and L. Scharpé; A. de Koninck, *Bibliographie nationale* (3 vols., 1886-1897); and *Histoire politique et littéraire du mouvement flamand* (1894), by Paul Hamelius. The *Vlaamsche Bibliographie*, issued by the Flemish Academy of Ghent, by Frans de Potter, contains a list of publications between 1830 and 1890; and there is a good deal of information in the excellent *Biographisch woordenboek der Noord- en Zuid-Nederlandsche Letterkunde* (1878) of Dr W. J. A. Huberts and others. (E. G.)

FLENSBURG (Danish, *Flensborg*), a seaport of Germany, in the Prussian province of Schleswig-Holstein, at the head of the Flensburg Fjord, 20 m. N.W. from Schleswig, at the junction of the main line Altona-Vamdrup (Denmark), with branches to Kiel and Glücksburg. Pop. (1905) 48,922. The principal public buildings are the Nikolai Kirche (built 1390, restored 1894), with a spire 295 ft. high; the Marienkirche, also a medieval church, with a lofty tower; the law courts; the theatre and the exchange. There are two gymnasia, schools of marine engineering, navigation, wood-carving and agriculture. The cemetery contains the remains of the Danish soldiers who fell at the battle of Idstedt (25th of July 1850), but the colossal Lion monument, erected by the Danes to commemorate their victory, was removed to Berlin in 1864. Flensburg is a busy centre of trade and industry, and is the most important town in what was formerly the duchy of Schleswig. It possesses excellent wharves, does a large import trade in coal, and has shipbuilding yards, breweries, distilleries, cloth and paper factories, glass-works, copper-works,

soap-works and rice mills. Its former extensive trade with the West Indies has lately suffered owing to the enormous development of the North Sea ports, but it is still largely engaged in the Greenland whale and the oyster fisheries.

Flensburg was probably founded in the 12th century. It attained municipal privileges in 1284, was frequently pillaged by the Swedes after 1643, and in 1848 became the capital, under Danish rule, of Schleswig.

See Holdt, *Flensburg früher und jetzt* (1884).

FLERS, a manufacturing town of north-western France, in the arrondissement of Domfront, and department of Orne, on the Vère, 41 m. S. of Caen on the railway to Laval. Pop. (1906) 11,188. A modern church in the Romanesque style and a restored château of the 15th century are its principal buildings. There is a tribunal of commerce, a board of trade-arbitrators, a communal college and a branch of the Bank of France. Flers is the centre of a cotton and linen-manufacturing region which includes the towns of Condé-sur-Noireau and La Ferté-Macé. Manufactures are very important, and include, besides cotton and linen fabrics, of which the annual value is about £1,500,000, drugs and chemicals; there are large brick and tile works, flour mills and dyeworks.

FLETA, a treatise, with the sub-title *seu Commentarius juris Anglicani*, on the common law of England. It appears, from internal evidence, to have been written in the reign of Edward I., about the year 1290. It is for the most part a poor imitation of Bracton. The author is supposed to have written it during his confinement in the Fleet prison, hence the name. It has been conjectured that he was one of those judges who were imprisoned for malpractices by Edward I. Fleta was first printed by J. Selden in 1647, with a dissertation (2nd edition, 1685).

FLETCHER, ALICE CUNNINGHAM (1845-), American ethnologist, was born in Boston, Massachusetts, in 1845. She studied the remains of Indian civilization in the Ohio and Mississippi valleys, became a member of the Archaeological Institute of America in 1879, and worked and lived with the Omahas as a representative of the Peabody Museum of American Archaeology and Ethnology, Harvard University. In 1883 she was appointed special agent to allot lands to the Omaha tribes, in 1884 prepared and sent to the New Orleans Exposition an exhibit showing the progress of civilization among the Indians of North America in the quarter-century previous, in 1886 visited the natives of Alaska and the Aleutian Islands on a mission from the commissioner of education, and in 1887 was United States special agent in the distribution of lands among the Winnebagoes and Nez Percés. She was made assistant in ethnology at the Peabody Museum in 1882, and received the Thaw fellowship in 1891; was president of the Anthropological Society of Washington and of the American Folk-Lore Society, and vice-president of the American Association for the Advancement of Science; and, working through the Woman's National Indian Association, introduced a system of making small loans to Indians, wherewith they might buy land and houses. In 1888 she published *Indian Education and Civilization*, a special report of the Bureau of Education. In 1898 at the Congress of Musicians held at Omaha during the Trans-Mississippi Exposition she read "several essays upon the songs of the North American Indians... in illustration of which a number of Omaha Indians... sang their native melodies." Out of this grew her *Indian Story and Song from North America* (1900), illustrating "a stage of development antecedent to that in which culture music appeared."

FLETCHER, ANDREW, of Saltoun (1655-1716), Scottish politician, was the son and heir of Sir Robert Fletcher (1625-1664), and was born at Saltoun, the modern Salton, in East Lothian. Educated by Gilbert Burnet, afterwards bishop of Salisbury, who was then the parish minister of Saltoun, he completed his education by spending some years in travel and study, entering public life as member of the Scottish parliament which met in 1681. Possessing advanced political ideas, Fletcher was a fearless and active opponent of the measures introduced by John Maitland, duke of Lauderdale, the representative of

Charles II. in Scotland, and his successor, the duke of York, afterwards King James II.; but he left Scotland about 1682, subsequently spending some time in Holland as an associate of the duke of Monmouth and other malcontents.

Although on grounds of prudence Fletcher objected to the rising of 1685, he accompanied Monmouth to the west of England, but left the army after killing one of the duke's trusted advisers. This incident is thus told by Sir John Dalrymple:

"Being sent upon an expedition, and not esteeming times of danger to be times of ceremony, he had seized for his own riding the horse of a country gentleman (the mayor of Lynne) which stood ready equipt for its master. The master hearing this ran in a passion to Fletcher, gave him opprobrious language, shook his cane and attempted to strike. Fletcher, though rigid in the duties of morality, yet having been accustomed to foreign services both by sea and land in which he had acquired high ideas of the honour of a soldier and a gentleman and of the affront of a cane, pulled out his pistol and shot him dead on the spot. The action was unpopular in countries where such refinements were not understood. A clamour was raised against it among the people of the country: in a body they waited upon the duke with their complaints; and he was forced to desire the only soldier and almost the only man of parts in his army, to abandon him."

Another, but less probable account, represents Fletcher as quitting the rebel army because he disapproved of the action of Monmouth in proclaiming himself king.

His history during the next few years is rather obscure. He probably travelled in Spain, and fought against the Turks in Hungary; and having in his absence lost his estates and been sentenced to death, he joined William of Orange at the Hague, and returned to Scotland in 1689 in consequence of the success of the Revolution of 1688. His estates were restored to him; and he soon became a leading member of the "club," an organization which aimed at reducing the power of the crown in Scotland, and in general an active opponent of the English government. In 1703, at a critical stage in the history of Scotland, Fletcher again became a member of the Scottish parliament. The failure of the Darien expedition had aroused a strong feeling of resentment against England, and Fletcher and the national party seized the opportunity to obtain a greater degree of independence for their country.

His attitude in this matter, and also to the proposal for the union of the two crowns, is thus described by a writer in the third edition of the *Encyclopaedia Britannica*:—

"The thought of England's domineering over Scotland was what his generous soul could not endure. The indignities and oppression which Scotland lay under galled him to the heart, so that in his learned and elaborate discourses he exposed them with undaunted courage and pathetic eloquence. In that great event, the Union, he performed essential service. He got the act of security passed, which declared that the two crowns should not pass to the same head till Scotland was secured in her liberties civil and religious. Therefore Lord Godolphin was forced into the Union, to avoid a civil war after the queen's demise. Although Mr Fletcher disapproved of some of the articles, and indeed of the whole frame of the Union, yet, as the act of security was his own work, he had all the merit of that important transaction."

Soon after the passing of the Act of Union Fletcher retired from public life. Employing his abilities in another direction, he did a real, if homely, service to his country by introducing from Holland machinery for sifting grain. He died unmarried in London in September 1716.

Contemporaries speak very highly of Fletcher's integrity, but he was also choleric and impetuous. Burnet describes him as "a Scotch gentleman of great parts and many virtues, but a most violent republican and extremely passionate." In appearance he was "a low, thin man, of a brown complexion; full of fire; with a stern, sour look." Fletcher was a fine scholar and a graceful writer, and both his writings and speeches afford bright glimpses of the manners and state of the country in his time. His chief works are: *A Discourse of Government relating to Militias* (1698); *Two Discourses concerning the Affairs of Scotland* (1698); and *An Account of a Conversation concerning a right regulation of Governments for the common good of Mankind* (1704). In *Two Discourses* he suggests that the numerous vagrants who infested Scotland should be brought into compulsory and hereditary servitude; and in *An Account of a*

Conversation occurs his well-known remark, "I knew a very wise man so much of Sir Christopher's (Sir C. Musgrave) sentiment, that he believed if a man were permitted to make all the ballads, he need not care who should make the laws of a nation."

The *Political Works of Andrew Fletcher* were published in London in 1737. See D. S. Erskine, 11th earl of Buchan, *Essay on the Lives of Fletcher of Saltoun and the Poet Thomson* (1792); J. H. Burton, *History of Scotland*, vol. viii. (Edinburgh, 1905); and A. Lang, *History of Scotland*, vol. iv. (Edinburgh, 1907).

FLETCHER, GILES (c. 1548–1611), English author, son of Richard Fletcher, vicar of Cranbrook, Kent, and father of the poets Phineas and Giles Fletcher, was born in 1548 or 1549. He was educated at Eton and at King's College, Cambridge, taking his B.A. degree in 1569. He was a fellow of his college, and was made LL.D. in 1581. In 1580 he had married Joan Sheafe of Cranbrook. In that year he was commissary to Dr Bridgewater, chancellor of Ely, and in 1585 he sat in parliament for Winchelsea. He was employed on diplomatic service in Scotland, Germany and Holland, and in 1588 was sent to Russia to the court of the czar Theodore with instructions to conclude an alliance between England and Russia, to restore English trade, and to obtain better conditions for the English Russia Company. The factor of the company, Jerome Horsey, had already obtained large concessions through the favour of the protector, Boris Godunov, but when Dr Fletcher reached Moscow in 1588 he found that Godunov's interest was alienated, and that the Russian government was contemplating an alliance with Spain. The envoy was badly lodged, and treated with obvious contempt, and was not allowed to forward letters to England, but the English victory over the Armada and his own indomitable patience secured among other advantages for English traders exclusive rights of trading on the Volga and their security from the infliction of torture. Fletcher's treatment at Moscow was later made the subject of formal complaint by Queen Elizabeth. He returned to England in 1589 in company with Jerome Horsey, and in 1591 he published *Of the Russe Commonwealth, Or Maner of Government by the Russe Emperour (commonly called The Emperour of Moskovia) with the manners and fashions of the people of that Countrey*. In this comprehensive account of Russian geography, government, law, methods of warfare, church and manners, Fletcher, who states that he began to arrange his material during the return journey, doubtless received some assistance from the longer experience of his travelling companion, who also wrote a narrative of his travels, published in *Purchas his Pilgrimes* (1626). The Russia Company feared that the freedom of Fletcher's criticisms would give offence to the Muscovite authorities, and accordingly damage their trade. The book was consequently suppressed, and was not reprinted in its entirety until 1856, when it was edited from a copy of the original edition for the Hakluyt Society, with an introduction by Mr Edward A. Bond.

Fletcher was appointed "Remembrancer" to the city of London, and an extraordinary master of requests in 1596, and became treasurer of St Paul's in 1597. He contemplated a history of the reign of Queen Elizabeth, and in a letter to Lord Burghley he suggested that it might be well to begin with an account from the Protestant side of the marriage of Henry VIII. and Ann Boleyn. But personal difficulties prevented the execution of this plan. He had become security to the exchequer for the debts of his brother, Richard Fletcher, bishop of London, who died in 1596, and was only then saved from imprisonment by the protection of the earl of Essex. He was actually in prison in 1601, when he addressed a somewhat ambiguous letter to Burghley from which it may be gathered that his prime offence had been an allusion to Essex's disgrace as being the work of Sir Walter Raleigh. Fletcher was employed in 1610 to negotiate with Denmark on behalf of the "Eastland Merchants," and he died next year, and was buried on the 11th of March in the parish of St Catherine Colman, London.

The *Russe Commonwealth* was issued in an abridged form in *Hakluyt's Principal Navigations, Voyages, &c.* (vol. i. p. 473, ed. of 1598), a somewhat completer version in *Purchas his Pilgrimes* (pt. iii. ed. 1625), also as *History of Russia* in 1643 and 1657.

Fletcher also wrote *De literis antiquae Britanniae* (ed. by Phineas Fletcher, 1633), a treatise on "The Tartars," printed in *Israel Redux* (ed. by S(amuel) L(ee), 1677), to prove that they were the ten lost tribes of Israel, Latin poems published in various miscellanies, and *Licia*, or *Poemes of Love in Honour of the admirable and singular virtues of his Lady, to the imitation of the best Latin Poets . . . whereunto is added the Rising to the Crowne of Richard the third* (1593). This series of love sonnets, followed by some other poems, was published anonymously. Most critics, with the notable exception of Alexander Dyce (Beaumont and Fletcher, *Works*, i. p. xvi., 1843) have accepted it as the work of Dr Giles Fletcher on the evidence afforded in the first of the *Piscatory Eclogues* of his son Phineas, who represents his father (Thelgon), as having "raised his rime to sing of Richard's climbing."

See E. A. Bond's Introduction to the Hakluyt Society's edition; also Dr A. B. Grosart's prefatory matter to *Licia* (*Fuller Worthies Library*, Miscellanies, vol. iii., 1871), and to the works (1869) of Phineas Fletcher in the same series. Fletcher's letters relative to the college dispute with the provost, Dr Roger Goad, are preserved in the Lansdowne MSS. (xxiii. art. 18 et seq.), and are translated in Grosart's edition.

FLETCHER, GILES (c. 1584-1623), English poet, younger son of the preceding, was born about 1584. Fuller in his *Worthies of England* says that he was a native of London, and was educated at Westminster school. From there he went to Trinity College, Cambridge, where he took his B.A. degree in 1606, and became a minor fellow of his college in 1608. He was reader in Greek grammar (1615) and in Greek language (1618). In 1603 he contributed a poem on the death of Queen Elizabeth to *Sorrow's Joy*. His great poem of *Christ's Victory* appeared in 1610, and in 1612 he edited the *Remains* of his cousin Nathaniel Pownall. It is not known in what year he was ordained, but his sermons at St Mary's were famous. Fuller tells us that the prayer before the sermon was a continuous allegory. He left Cambridge about 1618, and soon after received, it is supposed from Francis Bacon, the rectory of Alderton, on the Suffolk coast, where "his clownish and low-parted parishioners . . . valued not their pastor according to his worth; which disposed him to melancholy and hastened his dissolution." (Fuller, *Worthies of England*, ed. 1811, vol. ii. p. 82). His last work, *The Reward of the Faithful*, appeared in the year of his death (1623).

The principal work by which Giles Fletcher is known is *Christ's Victorie and Triumph, in Heaven, in Earth, over and after Death* (1610). An edition in 1640 contains seven full-page illustrative engravings by George Tate. It is in four cantos and is epic in design. The first canto, "Christ's Victory in Heaven," represents a dispute in heaven between Justice and Mercy, assuming the facts of Christ's life on earth; the second, "Christ's Victory on Earth," deals with an allegorical account of the Temptation; the third, "Christ's Triumph over Death," treats of the Passion; and the fourth, "Christ's Triumph after Death," treating of the Resurrection and Ascension, concludes with an affectionate eulogy of his brother Phineas Fletcher (*q.v.*) as "Thyrillis." The metre is an eight-line stanza owing something to Spenser. The first five lines rhyme ababb, and the stanza concludes with a rhyming triplet, resuming the conceit which nearly every verse embodies. Giles Fletcher, like his brother Phineas, to whom he was deeply attached, was a close follower of Spenser. In his very best passages Giles Fletcher attains to a rich melody which charmed the ear of Milton, who did not hesitate to borrow very considerably from the *Christ's Victory and Triumph* in his *Paradise Regained*. Fletcher lived in an age which regarded as models the poems of Marini and Gongora, and his conceits are sometimes grotesque in connexion with the sacredness of his subject. But when he is carried away by his theme and forgets to be ingenious, he attains great solemnity and harmony of style. His descriptions of the Lady of Vain Delight, in the second canto, and of Justice and of Mercy in the first, are worked out with much beauty of detail into separate pictures, in the manner of the *Faerie Queene*.

Giles Fletcher's poem was edited (1868) for the *Fuller Worthies Library*, and (1876) for the *Early English Poets* by Dr A. B. Grosart. It is also reprinted for *The Ancient and Modern Library of Theological Literature* (1888), and in R. Cattermole's and H. Stebbing's *Sacred Classics* (1834, &c.) vol. 20. In the library of King's College, Cambridge, is a MS. *Aegidii Fletcherii versio poetica Lamentationum Jeremiae*.

FLETCHER, JOHN WILLIAM (1729-1785), English divine, was born at Nyon in Switzerland on the 12th of September 1729, his original name being DE LA FLÉCHÈRE. He was educated at Geneva, but, preferring an army career to a clerical one, went to Lisbon and enlisted. An accident prevented his sailing with his regiment to Brazil, and after a visit to Flanders, where an uncle offered to secure a commission for him, he went to England, picked up the language, and in 1752 became tutor in a Shropshire family. Here he came under the influence of the new Methodist preachers, and in 1757 took orders, being ordained by the bishop of Bangor. He often preached with John Wesley and for him, and became known as a fervent supporter of the revival. Refusing the wealthy living of Dunham, he accepted the humble one of Madeley, where for twenty-five years (1760-1785) he lived and worked with unique devotion and zeal. Fletcher was one of the few parish clergy who understood Wesley and his work, yet he never wrote or said anything inconsistent with his own Anglican position. In theology he upheld the Arminian against the Calvinist position, but always with courtesy and fairness; his resignation on doctrinal grounds of the superintendency (1768-1771) of the countess of Huntingdon's college at Trevecca left nounpleasantness. The outstanding feature of his life was a transparent simplicity and saintliness of spirit, and the testimony of his contemporaries to his godliness is unanimous. Wesley preached his funeral sermon from the words "Mark the perfect man." Southey said that "no age ever provided a man of more fervent piety or more perfect charity, and no church ever possessed a more apostolic minister." His fame was not confined to his own country, for it is said that Voltaire, when challenged to produce a character as perfect as that of Christ, at once mentioned Fletcher of Madeley. He died on the 14th of August 1785.

Complete editions of his works were published in 1803 and 1836. The chief of them, written against Calvinism, are *Five Checks to Antinomianism*, *Scripture Scales to weigh the Gold of Gospel Truth*, and the *Portrait of St Paul*. See lives by J. Wesley (1786); L. Tyerman (1882); F. W. Macdonald (1885); J. Maratt (1902); also C. J. Ryle, *Christian Leaders of the 18th Century*, pp. 384-423 (1869).

FLETCHER, PHINEAS (1582-1650), English poet, elder son of Dr Giles Fletcher, and brother of Giles the younger, noticed above, was born at Cranbrook, Kent, and was baptized on the 8th of April 1582. He was admitted a scholar of Eton, and in 1600 entered King's College, Cambridge. He graduated B.A. in 1604, and M.A. in 1608, and was one of the contributors to *Sorrow's Joy* (1603). His pastoral drama, *Sicelides or Piscatory* (pr. 1631) was written (1614) for performance before James I., but only produced after the king's departure at King's College. He had been ordained priest and before 1611 became a fellow of his college, but he left Cambridge before 1616, apparently because certain emoluments were refused him. He became chaplain to Sir Henry Willoughby, who presented him in 1621 to the rectory of Hilgay, Norfolk, where he married and spent the rest of his life. In 1627 he published *Locustae, vel Pictas Jesuitica*. *The Locusts or Apollyonists*, two parallel poems in Latin and English furiously attacking the Jesuits. Dr Grosart saw in this work one of the sources of Milton's conception of Satan. Next year appeared an erotic poem, *Brittains Ida*, with Edmund Spenser's name on the title-page. It is certainly not by Spenser, and is printed by Dr Grosart with the works of Phineas Fletcher. *Sicelides*, a play acted at King's College in 1614, was printed in 1631. In 1632 appeared two theological prose treatises, *The Way to Blessedness and Joy in Tribulation*, and in 1633 his *magnum opus*, *The Purple Island*. The book was dedicated to his friend Edward Benlowes, and included his *Piscatorie Ecloges and other Poetical Miscellanies*. He died in 1650, his will being proved by his widow on the 13th of December of that year. *The Purple Island, or the Isle of Man*, is a poem in twelve cantos describing in cumbrous allegory the physiological structure of the human body and the mind of man. The intellectual qualities are personified, while the veins are rivers, the bones the mountains of the island, the whole analogy being worked out with great ingenuity. The manner of Spenser is preserved throughout, but Fletcher never lost sight of his moral

aim to lose himself in digressions like those of the *Faerie Queene*. What he gains in unity of design, however, he more than loses in human interest and action. The chief charm of the poem lies in its descriptions of rural scenery. The *Piscatory Eclogues* are pastorals the characters of which are represented as fisher boys on the banks of the Cam, and are interesting for the light they cast on the biography of the poet himself (Thyrtil) and his father (Thelgon). The poetry of Phineas Fletcher has not the sublimity sometimes reached by his brother Giles. The mannerisms are more pronounced and the conceits more far-fetched, but the verse is fluent, and lacks neither colour nor music.

A complete edition of his works (4 vols.) was privately printed by Dr A. B. Grosart (Fuller Worthies Library, 1869).

FLEURANGES, ROBERT (III.) DE LA MARCK, SEIGNEUR DE (1491–1537), marshal of France and historian, was the son of Robert II. de la Marck, duke of Bouillon, seigneur of Sedan and Fleuranges, whose uncle was the celebrated William de la Marck, "The Wild Boar of the Ardennes." A fondness for military exercises displayed itself in his earliest years, and at the age of ten he was sent to the court of Louis XII., and placed in charge of the count of Angoulême, afterwards King Francis I. In his twentieth year he married a niece of the cardinal d'Amboise, but after three months he quitted his home to join the French army in the Milanese. With a handful of troops he threw himself into Verona, then besieged by the Venetians; but the siege was protracted, and being impatient for more active service, he rejoined the army. He then took part in the relief of Mirandola, besieged by the troops of Pope Julius II., and in other actions of the campaign. In 1512 the French being driven from Italy, Fleuranges was sent into Flanders to levy a body of 10,000 men, in command of which, under his father, he returned to Italy in 1513, seized Alessandria, and vigorously assailed Novara. But the French were defeated, and Fleuranges narrowly escaped with his life, having received more than forty wounds. He was rescued by his father and sent to Vercellae, and thence to Lyons. Returning to Italy with Francis I. in 1515, he distinguished himself in various affairs, and especially at Marignano, where he had a horse shot under him, and contributed so powerfully to the victory of the French that the king knighted him with his own hand. He next took Cremona, and was there called home by the news of his father's illness. In 1519 he was sent into Germany on the difficult errand of inducing the electors to give their votes in favour of Francis I.; but in this he failed. The war in Italy being rekindled, Fleuranges accompanied the king thither, fought at Pavia (1525), and was taken prisoner with his royal master. The emperor, irritated by the defection of his father, Robert II. de la Marck, sent him into confinement in Flanders, where he remained for some years. During this imprisonment he was created marshal of France. He employed his enforced leisure in writing his *Histoire des choses mémorables advenues du règne de Louis XII et de François I, depuis 1499 jusqu'en l'an 1521*. In this work he designates himself *Jeune Adventureux*. Within a small compass he gives many curious and interesting details of the time, writing only of what he had seen, and in a very simple but vivid style. The book was first published in 1735, by Abbé Lambert, who added historical and critical notes; and it has been reprinted in several collections. The last occasion on which Fleuranges was engaged in active service was at the defence of Péronne, besieged by the count of Nassau in 1536. In the following year he heard of his father's death, and set out from Amboise for his estate of La Marck; but he was seized with illness at Longjumeau, and died there in December 1537.

See his own book in the *Nouvelle Collection des mémoires pour servir à l'histoire de France* (edited by J. F. Michaud and J. J. F. Poujoulat, series i. vol. v. Paris, 1836 seq.).

FLEUR-DE-LIS (Fr. "lily flower"), an heraldic device, very widespread in the armorial bearings of all countries, but more particularly associated with the royal house of France. The conventional fleur-de-lis, as Littré says, represents very imperfectly three flowers of the white lily (*Lilium*) joined together,

the central one erect, and each of the other two curving outwards. The fleur-de-lis is a common device in ancient decoration, notably in India and in Egypt, where it was the symbol of life and resurrection, the attribute of the god Horus. It is common also in Etruscan bronzes. It is uncertain whether the conventional fleur-de-lis was originally meant to represent the lily or white iris—the flower-de-luce of Shakespeare—or an arrow-head, a spear-head, an amulet fastened on date-palms to ward off the evil eye, &c. In Roman and early Gothic architecture the fleur-de-lis is a frequent sculptured ornament. As early as 1120 three fleurs-de-lis were sculptured on the capitals of the Chapelle Saint-Aignan at Paris. The fleur-de-lis was first definitely connected with the French monarchy in an *ordonnance* of Louis le Jeune (c. 1147), and was first figured on a seal of Philip Augustus in 1180. The use of the fleur-de-lis in heraldry dates from the 12th century, soon after which period it became a very common charge in France, England and Germany, where every gentleman of coat-armour desired to adorn his shield



Middle Ages.



17th century.



18th and 19th centuries.

with a loan from the shield of France, which was at first *d'azur, semé de fleurs de lis d'or*. In February 1376 Charles V. of France reduced the number of fleurs-de-lis to three—in honour of the Trinity—and the kings of France thereafter bore *d'azur, à trois fleurs de lis d'or*. Tradition soon attributed the origin of the fleur-de-lis to Clovis, the founder of the Frankish monarchy, and explained that it represented the lily given to him by an angel at his baptism. Probably there was as much foundation for this legend as for the more rationalistic explanation of William Newton (*Display of Heraldry*, p. 145), that the fleur-de-lis was the figure of a reed or flag in blossom, used instead of a sceptre at the proclamation of the Frankish kings. Whatever be the true origin of the fleur-de-lis as a conventional decoration, it is demonstrably far older than the Frankish monarchy, and history does not record the reason of its adoption by the royal house of France, from which it passed into common use as an heraldic charge in most European countries. An order of the Lily, with a fleur-de-lis for badge, was established in the Roman states by Pope Paul III. in 1546; its members were pledged to defend the patrimony of St Peter against the enemies of the church. Another order of the Lily was founded by Louis XVIII. in 1816, in memory of the silver fleurs-de-lis which the comte d'Artois had given to the troops in 1814 as decorations; it was abolished by the revolution of 1830.

FLEURUS, a village of Belgium, in the province of Hennegau, 5 m. N.E. of Charleroi, famous as the scene of several battles. The first of these was fought on August 19/29, 1622, between the forces of Count Mansfeld and Christian of Brunswick and the Spaniards under Cordovas, the latter being defeated. The second is described below, and the third and fourth, incidents of Jourdan's campaign of 1794, under FRENCH REVOLUTIONARY WARS. The ground immediately north-east of Fleurus forms the battlefield of Ligny (June 16, 1815), for which see WATERLOO CAMPAIGN.

The second battle was fought on the 1st of July 1690 between 45,000 French under François-Henri de Montgomery-Bouteville, duke of Luxemburg, and 37,000 allied Dutch, Spaniards and Imperialists under George Frederick, prince of Waldeck. The latter had formed up his army between Heppignies and St Amand in what was then considered an ideal position; a double barrier of marshy brooks was in front, each flank rested on a village, and the space between, open upland, fitted his army exactly. But Luxemburg, riding up with his advanced guard from Velaine, decided, after a cursory survey of the ground, to

attack the front and both flanks of the Allies' position at once—a decision which few, if any, generals then living would have dared to make, and which of itself places Luxemburg in the same rank as a tactician as his old friend and commander Condé. The left wing of cavalry was to move under cover of woods, houses and hollows to gain Wangenies, where it was to connect with the frontal attack of the French centre from Fleurus and to envelop Waldeck's right. Luxemburg himself with the right wing of cavalry and some infantry and artillery made a wide sweep round the enemy's left by way of Ligny and Les Trois Burettes, concealed by the high-standing corn. At 8 o'clock the frontal attack began by a vigorous artillery engagement, in which the French, though greatly outnumbered in guns, held their own, and three hours later Waldeck, whose attention had been absorbed by events on the front, found a long line of the enemy

FLEURUS 1690

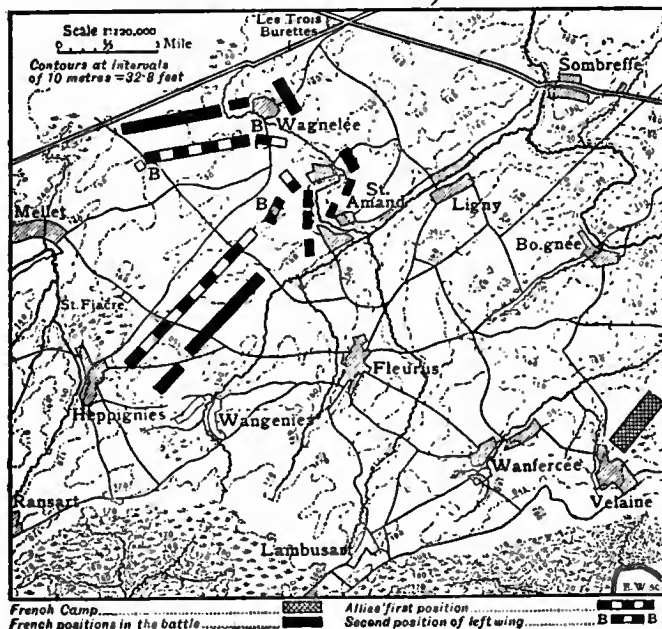

already formed up in his rear. He at once brought his second line back to oppose them, but while he was doing so the French leader filled up the gap between himself and the frontal assailants by posting infantry around Wagnelée, and also guns on the neighbouring hill whence their fire enfiladed both halves of the enemy's army up to the limit of their ranging power. At 1 P.M. Luxemburg ordered a general attack of his whole line. He himself scattered the cavalry opposed to him and hustled the Dutch infantry into St Amand, where they were promptly surrounded. The left and centre of the French army were less fortunate, and in their first charge lost their leader, Lieutenant-General Jean Christophe, comte de Gournay, one of the best cavalry officers in the service. But Waldeck, hoping to profit by this momentary success, sent a portion of his right wing towards St Amand, where it merely shared the fate of his left, and the day was decided. Only a quarter of the cavalry and 14 battalions of infantry (English and Dutch) remained intact, and Waldeck could do no more, but with these he emulated the last stand of the Spaniards at Rocroi fifty years before. A great square was formed of the infantry, and a handful of cavalry joined them—the French cavalry, eager to avenge Gournay, had swept away the rest. Then slowly and in perfect order, they retired into the broken ground above Mellet, where they were in safety. The French slept on the battlefield, and then returned to camp with their trophies and 8000 prisoners. They had lost some 2500 killed, amongst them Gournay and Berber du Metz, the chief of artillery, the Allies twice as many, as well as 48 guns, and Luxemburg was able to send 150 colours and standards to decorate Notre-Dame. But the victory was not followed up, for Louis XIV. ordered Luxemburg to keep in line with other French armies

which were carrying on more or less desultory wars of manoeuvre on the Meuse and Moselle.

FLEURY [ABRAHAM JOSEPH BÉNARD] (1750–1822), French actor, was born at Chartres on the 26th of October 1750, and began his stage apprenticeship at Nancy, where his father was at the head of a company of actors attached to the court of King Stanislaus. After four years in the provinces, he came to Paris in 1778, and almost immediately was made *sociétaire* at the Comédie Française, although the public was slow to recognize him as the greatest comedian of his time. In 1793 Fleury, like the rest of his fellow-players, was arrested in consequence of the presentation of Laya's *L'Ami des lois*, and, when liberated, appeared at various theatres until, in 1799, he rejoined the rehabilitated Comédie Française. After forty years of service he retired in 1818, and died on the 3rd of March 1822. He was notoriously illiterate, and it is probable that the interesting *Mémoire de Fleury* owes more to its author, Lafitte, than to the subject whose "notes and papers" it is said to contain.

FLEURY, ANDRÉ HERCULE DE (1653–1743), French cardinal and statesman, was born at Lodève (Hérault) on the 22nd of June 1653, the son of a collector of taxes. Educated by the Jesuits in Paris, he entered the priesthood, and became in 1679, through the influence of Cardinal Bonzi, almoner to Maria Theresa, queen of Louis XIV., and in 1698 bishop of Fréjus. Seventeen years of a country bishopric determined him to seek a position at court. He became tutor to the king's great-grandson and heir, and in spite of an apparent lack of ambition, he acquired over the child's mind an influence which proved to be indestructible. On the death of the regent Orleans in 1723 Fleury, although already seventy years of age, deferred his own supremacy by suggesting the appointment of Louis Henri, duke of Bourbon, as first minister. Fleury was present at all interviews between Louis XV. and his first minister, and on Bourbon's attempt to break through this rule Fleury retired from court. Louis made Bourbon recall the tutor, who on the 11th of July 1726 took affairs into his own hands, and secured the exile from court of Bourbon and of his mistress Madame de Prie. He refused the title of first minister, but his elevation to the cardinalate in that year secured his precedence over the other ministers. He was naturally frugal and prudent, and carried these qualities into the administration, with the result that in 1738–1739 there was a surplus of 15,000,000 livres instead of the usual deficit. In 1726 he fixed the standard of the currency and secured the credit of the government by the regular payment thenceforward of the interest on the debt. By exacting forced labour from the peasants he gave France admirable roads, though at the cost of rousing angry discontent. During the seventeen years of his orderly government the country found time to recuperate its forces after the exhaustion caused by the extravagances of Louis XIV. and of the regent, and the general prosperity rapidly increased. Internal peace was only seriously disturbed by the severities which Fleury saw fit to exercise against the Jansenists. He imprisoned priests who refused to accept the bull *Unigenitus*, and he met the opposition of the parlement of Paris by exiling forty of its members.

In foreign affairs his chief preoccupation was the maintenance of peace, which was shared by Sir Robert Walpole, and therefore led to a continuance of the good understanding between France and England. It was only with reluctance that he supported the ambitious projects of Elizabeth Farnese, queen of Spain, in Italy by guaranteeing in 1729 the succession of Don Carlos to the duchies of Parma and Tuscany. Fleury had economized in the army and navy, as elsewhere, and when in 1733 war was forced upon him he was hardly prepared. He was compelled by public opinion to support the claims of Louis XV.'s father-in-law Stanislaus Leszczyński, ex-king of Poland, to the Polish crown on the death of Frederick Augustus I., against the Russo-Austrian candidate; but the despatch of a French expedition of 1500 men to Danzig only served to humiliate France. Fleury was driven by Chauvelin to more energetic measures; he concluded a close alliance with the Spanish Bourbons and sent two armies against the Austrians. Military successes on the

Rhine and in Italy secured the favourable terms of the treaty of Vienna (1735-1738). France had joined with the other powers in guaranteeing the succession of Maria Theresa under the Pragmatic sanction, but on the death of Charles VI. in 1740 Fleury by a diplomatic quibble found an excuse for repudiating his engagements, when he found the party of war supreme in the king's counsels. After the disasters of the Bohemian campaign he wrote in confidence a humble letter to the Austrian general Königsegg, who immediately published it. Fleury disavowed his own letter, and died a few days after the French evacuation of Prague on the 29th of January 1743. He had enriched the royal library by many valuable oriental MSS., and was a member of the French Academy, of the Academy of Science, and the Academy of Inscriptions.

BIBLIOGRAPHY.—F. J. Bataille, *Éloge historique de M. le Cardinal A. H. de Fleury* (Strassburg, 1737); C. Frey de Neuville, *Oraison funèbre de S.E. Mgr. le Cardinal A. H. Fleury* (Paris, 1743); P. Vicaire, *Oraison funèbre du Cardinal A. H. de Fleury* (Caen, 1743); M. van Hoey, *Lettres et négociations pour servir à l'histoire de la vie du Cardinal de Fleury* (London, 1743); *Leben des Cardinals A. H. Fleury* (Freiburg, 1743); F. Morénas, *Parallèle du ministère du Cardinal Richelieu et du Cardinal de Fleury* (Avignon, 1743); *Nachrichten von dem Leben und der Verwaltung des Cardinals Fleury* (Hamburg, 1744).

FLEURY, CLAUDE (1640-1723), French ecclesiastical historian, was born at Paris on the 6th of December 1640. Destined for the bar, he was educated at the aristocratic college of Clermont (now that of Louis-le-Grand). In 1658 he was nominated an advocate to the parlement of Paris, and for nine years followed the legal profession. But he had long been of a religious disposition, and in 1667 turned from law to theology. He had been some time in orders when Louis XIV., in 1672, selected him as tutor of the princes of Conti, with such success that the king next entrusted to him the education of the count of Vermandois, one of his natural sons, on whose death in 1683 Fleury received for his services the Cistercian abbey of Loc-Dieu, in the diocese of Rhodéz. In 1689 he was appointed sub-preceptor of the dukes of Burgundy, of Anjou, and of Berry, and thus became intimately associated with Fénelon, their chief tutor. In 1696 he was elected to fill the place of La Bruyère in the French Academy; and on the completion of the education of the young princes the king bestowed upon him the rich priory of Argenteuil, in the diocese of Paris (1706). On assuming this benefice he resigned, with rare disinterestedness, that of the abbey of Loc-Dieu. About this time he began his great work, the first of the kind in France, and one for which he had been collecting materials for thirty years—the *Histoire ecclésiastique*. Fleury's evident intention was to write a history of the church for all classes of society; but at the time in which his great work appeared it was less religion than theology that absorbed the attention of the clergy and the educated public; and his work accordingly appealed to the student rather than to the popular reader, dwelling as it does very particularly on questions of doctrine, of discipline, of supremacy, and of rivalry between the priesthood and the imperial power. Nevertheless it had a great success. The first edition, printed at Paris in 20 volumes 4to, 1691, was followed by many others, among which may be mentioned that of Brussels, in 32 vols. 8vo, 1692, and that of Nismes, in 25 vols. 8vo, 1778 to 1780. The work of Fleury only comes down to the year 1414. It was continued by J. Claude Fabre and Goujet down to 1595, in 16 vols. 4to. In consulting the work of Fleury and its supplement, the general table of contents, published by Rondel, Paris, 1758, 1 vol. 4to. will be found very useful. Translations have been made of the entire work into Latin, German and Italian. The Latin translation, published at Augsburg, 1758-1759, 85 vols. 8vo, carries the work down to 1684. Fleury, who had been appointed confessor to the young king Louis XV. in 1716, because, as the duke of Orleans said, he was neither Jansenist nor Molinist, nor Ultramontanist, but Catholic, died on the 14th of July 1723. His great learning was equalled by the modest simplicity of his life and the uprightness of his conduct.

Fleury left many works besides his *Histoire ecclésiastique*. The following deserve special mention:—*Histoire du droit français* (1674,

12mo); *Mœurs des Israélites* (1681, 12mo); *Mœurs des Chrétiens* (1682, 12mo); *Traité du choix et de la méthode des études* (1686, 2 vols. 12mo); *Les Devoirs des maîtres et des domestiques* (1688, 12mo). A number of the smaller works were published in one volume at Paris in 1807. The Roman Congregation of the Index condemned his *Catéchisme historique* (1679) and the *Institution du droit ecclésiastique* (1687).

See C. Ernst Simonetti, *Der Charakter eines Geschichtsschreibers in dem Leben und aus den Schriften des Abts C. Fleury* (Göttingen, 1746, 4to); C. F. P. Jaeger, *Notice sur C. Fleury, considéré comme historien de l'église* (Strassburg, 1847, 8vo); Reichlin-Meldegg, *Geschichte des Christentums*, i.

FLIEDNER, THEODOR (1800-1864), German Protestant divine, was born on the 21st of January 1800 at Epstein (near Wiesbaden), the small village in which his father was pastor. He studied theology at the universities of Giessen and Göttingen, and at the theological seminary of Herborn, and at the age of twenty he passed his final examination. After a year spent in teaching and preaching, in 1821 he accepted a call from the Protestant church at Kaiserswerth, a little town on the Rhine, a few miles below Düsseldorf. To help his people and to provide an endowment for his church, he undertook journeys in 1822 through part of Germany, and then in 1823 to Holland and England. He met with considerable success, and had opportunities of observing what was being done towards prison reform; in England he made the acquaintance of the philanthropist Elizabeth Fry. The German prisons were then in a very bad state. The prisoners were huddled together in dirty rooms, badly fed, and left in complete idleness. No one dreamed of instructing them, or of collecting statistics to form the basis of useful legislation on the subject. Fliedner, at first singly, undertook the work. He applied for permission to be imprisoned for some time, in order that he might look at prison life from the inside. This petition was refused, but he was allowed to hold fortnightly services in the Düsseldorf prison, and to visit the inmates individually. Those interested in the subject banded themselves together, and on the 18th of June 1826 the first Prison Society of Germany (*Rheinisch-Westfälischer Gefängnisverein*) was founded. In 1833 Fliedner opened in his own parsonage garden at Kaiserswerth a refuge for discharged female convicts. His circle of practical philanthropy rapidly increased. The state of the sick poor had for some time excited his interest, and it seemed to him that hospitals might be best served by an organized body of specially trained women. Accordingly in 1836 he began the first deaconess house, and the hospital at Kaiserswerth. By their ordination vows the deaconesses devoted themselves to the care of the poor, the sick and the young; but their engagements were not final—they might leave their work and return to ordinary life if they chose. In addition to these institutions Fliedner founded in 1835 an infant school, then a normal school for infant school mistresses (1836), an orphanage for orphan girls of the middle class (1842), and an asylum for female lunatics (1847). Moreover, he assisted at the foundation and in the management of similar institutions, not only in Germany, but in various parts of Europe.

In 1849 he resigned his pastoral charge, and from 1849 to 1851 he travelled over a large part of Europe, America and the East—the object of his journeys being to found “mother houses,” which were to be not merely training schools for deaconesses, but also centres whence other training establishments might arise. He established a deaconess house in Jerusalem, and after his return assisted by counsel and money in the erection of establishments at Constantinople, Smyrna, Alexandria and Bucharest. Among his later efforts may be mentioned the Christian house of refuge for female servants in Berlin (connected with which other institutions soon arose) and the “house of evening rest” for retired deaconesses at Kaiserswerth. In 1855 Fliedner received the degree of doctor in theology from the university of Bonn, in recognition rather of his practical activity than of his theological attainments. He died on the 4th of October 1864, leaving behind him over 100 stations attended by 430 deaconesses; and these by 1876 had increased to 150 with an attendance of 600.

Fliedner's son FRITZ FLIEDNER (1845-1901), after studying in Halle and Tübingen, became in 1870 chaplain to the embassy in

Madrid. He followed in his father's footsteps by founding several philanthropic institutions in Spain. He was also the author of a number of books, amongst which was an autobiography, *Aus meinem Leben. Erinnerungen und Erfahrungen* (1901).

Theodor Fliedner's writings are almost entirely of a practical character. He edited a periodical, *Der Armen und Kranken Freund*, which contained information regarding the various institutions, and also the yearly almanac of the Kaiserswerth institution. Besides purely educational and devotional works, he wrote *Buch der Märtyrer* (1852); *Kurze Geschichte der Entstehung der ersten evang. Liebesanstalten zu Kaiserswerth* (1856); *Nachricht über das Diakonissen-Werk in der Christ. Kirche* (5th ed., 1867); *Die evangel. Märtyrer Ungarns und Siebenbürgens*; and *Beschreibung der Reise nach Jerusalem und Constantinopel*. All were published at Kaiserswerth. There is a translation of the German life by C. Winkworth (London, 1867). See also G. Fliedner, *Theodor Fliedner, kurzer Abriss seines Lebens und Wirkens* (3rd ed., 1892). See also on Fliedner and his work *Kaiserswerth Deaconesses* (London, 1857); Dean John S. Howson's *Deaconesses* (London, 1862); *The Service of the Poor*, by E. C. Stephen (London, 1871); W. F. Stevenson's *Praying and Working* (London, 1865).

FLIGHT and FLYING. Of the many scientific problems of modern times, there are few possessing a wider or more enduring interest than that of aerial navigation (see also AERONAUTICS). To fly has always been an object of ambition with man; nor will this occasion surprise when we remember the marvellous freedom enjoyed by volant as compared with non-volant animals. The subject of aviation is admittedly one of extreme difficulty. To tread upon the air (and this is what is really meant) is, at first sight, in the highest degree utopian; and yet there are thousands of living creatures which actually accomplish this feat. These creatures, however varied in form and structure, all fly according to one and the same principle; and this is a significant fact, as it tends to show that the air must be attacked in a particular way to ensure flight. It behoves us then at the outset to scrutinize very carefully the general configuration of flying animals, and in particular the size, shape and movements of their flying organs.

Flying animals differ entirely from sailing ships and from balloons, with which they are not unfrequently though erroneously compared; and a flying machine constructed upon proper principles can have nothing in common with either of those creations. The ship floats upon water and the balloon upon air; but the ship differs from the balloon, and the ship and the balloon differ from the flying creature and flying machine. The water and air, moreover, have characteristics of their own. The analogies which connect the water with the air, the ship with the balloon, and the ship and the balloon with the flying creature and flying machine are false analogies. A sailing ship is supported by the water and requires merely to be propelled; a flying creature and a flying machine constructed on the living type require to be both supported and propelled. This arises from the fact that water is much denser than air, and because water supports on its surface substances which fall through air. While water and air are both fluid media, they are to be distinguished from each other in the following particulars. Water is comparatively very heavy, inelastic and incompressible; air, on the other hand, is comparatively very light, elastic and compressible. If water be struck with violence, the recoil obtained is great when compared with the recoil obtained from air similarly treated. In water we get a maximum recoil with a minimum of displacement; in air, on the contrary, we obtain a minimum recoil with a maximum of displacement. Water and air when unconfined yield readily to pressure. They thus form *movable fulcra* to bodies acting upon them. In order to meet these peculiarities the travelling organs of aquatic and flying animals (whether they be feet, fins, flippers or wings) are made not of rigid but of elastic materials. The travelling organs, moreover, increase in size in proportion to the tenuity of the fluid to be acted upon. The difference in size of the travelling organs of animals becomes very marked when the land animals are contrasted with the aquatic, and the aquatic with the aerial, as in figs. 1, 2 and 3.

The peculiarities of water and air as supporting media are well

illustrated by a reference to swimming, diving and flying birds. A bird when swimming extends its feet simultaneously or alternately in a backward direction, and so obtains a forward recoil. The water supports the bird, and the feet simply propel. In this case the bird is lighter than the water, and the long axis of the body is horizontal (*a* of fig. 4). When the bird dives, or flies under water, the long axis of the body is inclined obliquely downwards and forwards, and the bird forces itself into and beneath the water by the action of its feet, or wings, or both. In diving or sub-aquatic flight the feet strike upwards and backwards, the wings downwards and backwards (*b* of fig. 4). In aerial flying everything

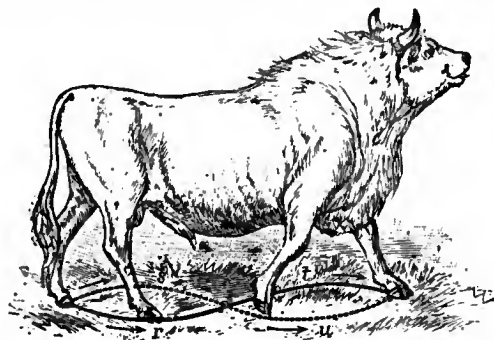

FIG. 1.—Chillingham Bull (*Bos Scoticus*). Small travelling extremities adapted for land. *r, s, t, u*, figure-of-8 described by the feet in walking.

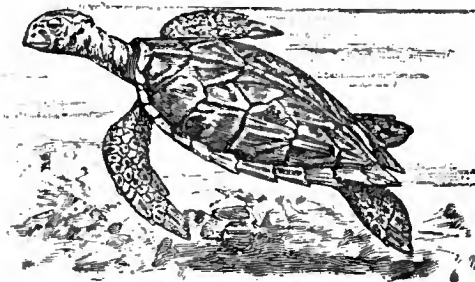

FIG. 2.—The Turtle (*Chelonia imbricata*). Enlarged travelling extremities (flippers) adapted for water.



FIG. 3.—The Bat (*Phyllocina gracilis*). Greatly expanded travelling extremities adapted for air.

is reversed. The long axis of the bird is inclined obliquely upwards and forwards, and the wings strike, not downwards and backwards, but downwards and forwards (*c* of fig. 4). These changes in the direction of the long axis of the bird in swimming, diving and flying, and in the direction of the stroke of the wings in sub-aquatic and aerial flight, are due to the fact that the bird is heavier than the air and lighter than the water.

The physical properties of water and air explain in a great measure how the sailing ship differs from the balloon, and how the latter differs from the flying creature and flying machine constructed on the natural type. The sailing ship is, as it were, immersed in two oceans, viz. an ocean of water and an ocean of air—the former being greatly heavier and denser than the latter. The ocean of water buoys or floats the ship, and the ocean of air, or part of it in motion, swells the sails which propel the ship. The moving air, which strikes the sails directly, strikes the hull of the vessel indirectly and forces it through the water, which, as explained, is a comparatively dense fluid. When the

ship is in motion it can be steered either by the sails alone, or by the rudder alone, or by both combined. A balloon differs from a sailing ship in being immersed in only one ocean, viz. the ocean of air. It resembles the ship in floating upon the air, as the ship

take. No machine, however light and powerful, will ever fly whose travelling surfaces are not properly fashioned and properly applied to the air.

It was supposed at one time that the air sacs of birds contributed in some mysterious way to flight, but this is now known to be erroneous. The bats and some of the best-flying birds have no air sacs. Similar remarks are to be made of the heated air imprisoned within the bones of certain birds.¹ Feathers even are not necessary to flight. Insects and bats have no feathers, and yet fly well. The only facts in natural history which appear even indirectly to countenance the flotation theory are the presence of a swimming bladder in some fishes, and the existence of membranous expansions or pseudo-wings in certain animals, such as the flying fish, flying dragon and flying squirrel. As, however, the animals referred to do not actually fly, but merely dart into the air and there sustain themselves for brief intervals, they afford no real support to the theory. The so-called floating animals are depicted at figs. 5, 6 and 7.

It has been asserted, and with some degree of plausibility, that a fish lighter than the water might swim, and that a bird lighter than the air might fly: it ought, however, to be borne in mind

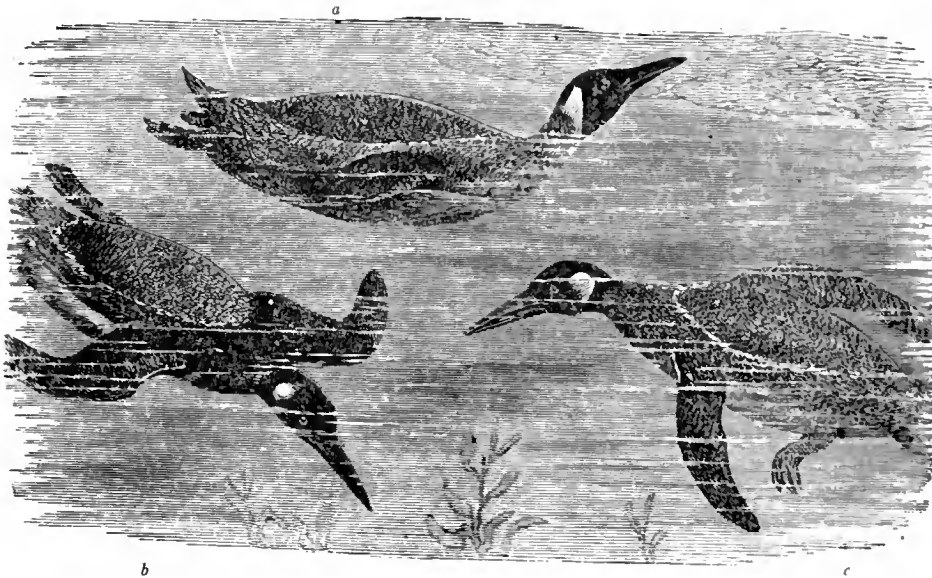

FIG. 4.—The King Penguin in the positions assumed by a bird in (a) swimming, (b) diving, and (c) flying.

floats upon the water; in other words, the balloon is lighter than the air, as the ship is lighter than the water. But here all analogy ceases. The ship, in virtue of its being immersed in two fluids having different densities, can be steered and made to tack about in a horizontal plane in any given direction. This in the case of the balloon, immersed in one fluid, is impossible. The balloon in a calm can only rise and fall in a vertical line. Its horizontal movements, which ought to be the more important, are accidental movements due to air currents, and cannot be controlled; the balloon, in short, cannot be guided. One might as well attempt to steer a boat carried along by currents of water in the absence of oars, sails and wind, as to steer a balloon carried along by currents of air. The balloon has no hold upon the air, and this consequently cannot be employed as a *fulcrum* for regulating its course. The balloon, because of its vast size and from its being lighter than the air, is completely at the mercy of the wind. It forms an integral part, so to speak, of the wind for the time being, and the direction of the wind in every instance determines the horizontal motion of the balloon. The force required to propel a balloon against even a moderate breeze would result in its destruction. The balloon cannot be transferred with any degree of certainty from one point of the earth's surface to another, and hence the chief danger in its employment. It may, quite as likely as not, carry its occupants out to sea. The balloon is a mere lifting machine and is in no sense to be regarded as a flying machine. It resembles the flying creature only in this, that it is immersed in the ocean of air in which it sustains itself. The mode of suspension is wholly different. The balloon floats because it is lighter than the air; the flying creature floats because it extracts from the air, by the vigorous downward action of its wings, a certain amount of upward recoil. The balloon is passive; the flying creature is active. The balloon is controlled by the wind; the flying creature controls the wind. The balloon in the absence of wind can only rise and fall in a vertical line; the flying creature can fly in a horizontal plane in any given direction. The balloon is inefficient because of its levity; the flying creature is efficient because of its weight.

Weight, however paradoxical it may appear, is necessary to flight. Everything which flies is vastly heavier than the air. The inertia of the mass of the flying creature enables it to control and direct its movements in the air. Many are of opinion that flight is a mere matter of levity and power. This is quite a mis-

lighter than the water might swim, and that a bird lighter than the air might fly: it ought, however, to be borne in mind



FIG. 5.—The Red-throated Dragon (*Draco haematopogon*).

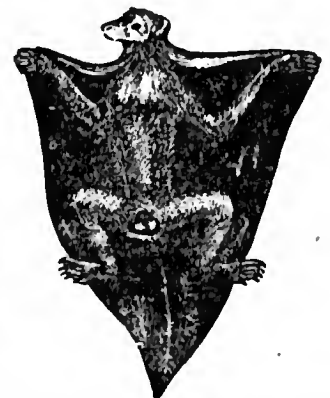

FIG. 6.—The Flying Colugo (*Galeopithecus volans*); also called flying lemur and flying squirrel.

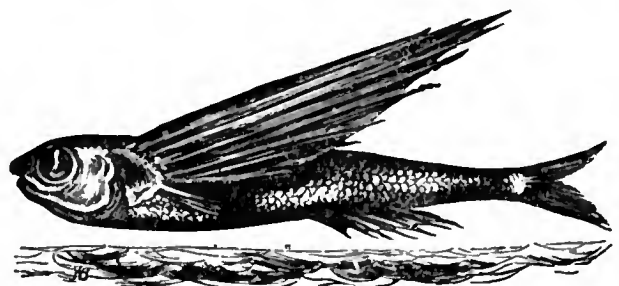

FIG. 7.—The Flying Fish (*Exocoetus exiliens*).

that, in point of fact, a fish lighter than the water could not hold its own if the water were in the least perturbed, and that a bird lighter than the air would be swept into space by even a moderate

¹ According to Dr Crisp, the swallow, martin, snipe and many birds of passage have no air in their bones.—*Proc. Zool. Soc. Lond.* part xxv., 1857, p. 13.

breeze without hope of return. Weight and power are always associated in living animals, and the fact that living animals are made heavier than the medium they are to navigate may be regarded as a conclusive argument in favour of weight being necessary alike to the swimming of the fish and the flying of the bird. It may be stated once for all that flying creatures are for the most part as heavy, bulk for bulk, as other animals, and that flight in every instance is the product, not of superior levity, but of *weight* and *power* directed upon properly constructed flying organs.

This fact is important as bearing on the construction of flying machines. It shows that a flying machine need not necessarily be a light, airy structure exposing an immoderate amount of surface. On the contrary, it favours the belief that it should be a compact and moderately heavy and powerful structure, which trusts for elevation and propulsion entirely to its flying appliances—whether actively moving wings, or screws, or aeroplanes wedged forward by screws. It should attack and subdue the air, and never give the air an opportunity of attacking or subduing it. It should smite the air intelligently and as a master, and its vigorous well-directed thrusts should in every instance elicit an upward and forward recoil. The flying machine must be *multum in parvo*. It must launch itself in the ocean of air, and must extract from that air, by means of its travelling surfaces—however fashioned and however applied—the recoil or resistance necessary to elevate and carry it forward. Extensive inert surfaces indeed are contra-indicated in a flying machine, as they approximate it to the balloon, which, as has been shown, cannot maintain its position in the air if there are air currents. A flying machine which could not face air currents would necessarily be a failure. To obviate this difficulty we are forced to fall back upon *weight*, or rather the structures and appliances which weight represents. These appliances as indicated should not be unnecessarily expanded, but when expanded they should, wherever practicable, be converted into actively moving flying surfaces, in preference to fixed or inert dead surfaces.

The question of surface is a very important one in aviation: it naturally resolves itself into one of active and passive surface. As there are active and passive surfaces in the flying animal, so there are, or should be, active and passive surfaces in the flying machine. Art should follow nature in this matter. The active surfaces in flying creatures are always greatly in excess of the passive ones, from the fact that the former virtually increase in proportion to the spaces through which they are made to travel. Nature not only distinguishes between active and passive surfaces in flying animals, but she strikes a just balance between them, and utilizes both. She regulates the surfaces to the strength and weight of the flying creature and the air currents to which the surfaces are to be exposed and upon which they are to operate. In her calculations she never forgets that her flying subjects are to control and not to be controlled by the air. As a rule she reduces the passive surfaces of the body to a minimum; she likewise reduces as far as possible the actively moving or flying surfaces. While, however, diminishing the surfaces of the flying animal as a whole, she increases as occasion demands the active or wing surfaces by wing movements, and the passive or dead surfaces by the forward motion of the body in progressive flight. She knows that if the wings are driven with sufficient rapidity they practically convert the spaces through which they move into solid bases of support; she also knows that the body in rapid flight derives support from all the air over which it passes. The manner in which the wing surfaces are increased by the wing movements will be readily understood from the accompanying illustrations of the blow-fly with its wings at rest and in motion (figs. 8 and 9). In fig. 8 the surfaces exposed by the body of the insect and the wings are, as compared with those of fig. 9, trifling. The wing would have much less purchase on fig. 8 than on fig. 9, provided the surfaces exposed by the latter were passive or dead surfaces. But they are not dead surfaces: they represent the spaces occupied by the rapidly vibrating wings, which are actively moving flying organs. As, moreover, the wings travel at a much higher speed than any wind that blows, they are superior

to and control the wind; they enable the insect to dart through the wind in whatever direction it pleases.

The reader has only to imagine figs. 8 and 9 cut out in paper to realize that extensive, inert, horizontal aeroplanes¹ in a flying machine would be a mistake. It is found to be so practically, as will be shown by and by. Fig. 9 so cut out would be heavier than fig. 8, and if both were exposed to a current of air, fig. 9 would be more blown about than fig. 8.

It is true that in beetles and certain other insects there are the elytra or wing cases—thin, light, horny structures inclined

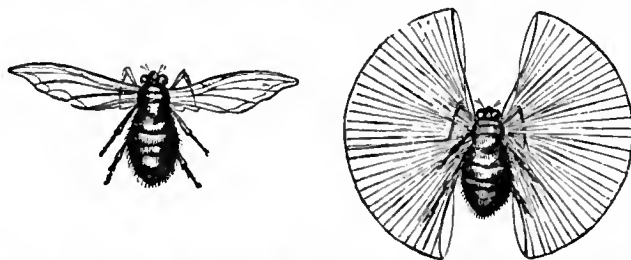

FIG. 8.—Blow-fly (*Musca vomitoria*) FIG. 9.—Blow-fly with its wings with its wings at rest. in motion as in flight.

slightly upwards—which in the act of flight are spread out and act as sustainers or gliders. The elytra, however, are comparatively long narrow structures which occupy a position in front of the wings, of which they may be regarded as forming the anterior parts. The elytra are to the delicate wings of some insects what the thick anterior margins are to stronger wings. The elytra, moreover, are not wholly passive structures. They can be moved, and the angles made by their under surfaces with the horizon adjusted. Finally, they are not essential to flight, as flight in the great majority of instances is performed without them. The elytra serve as protectors to the wings when the wings are folded upon the back of the insect, and as they are extended on either side of the body more or less horizontally when the insect is flying they contribute to flight indirectly, in virtue of their being carried forward by the body in motion.

Natural Flight.—The manner in which the wings of the insect traverse the air, so as practically to increase the basis of support, raises the whole subject of natural flight. It is necessary, therefore, at this stage to direct the attention of the reader somewhat fully to the subject of flight, as witnessed in the insect, bird and bat, a knowledge of natural flight preceding, and being in some sense indispensable to, a knowledge of artificial flight. The bodies of flying creatures are, as a rule, very strong, comparatively light and of an elongated form,—the bodies of birds being specially adapted for cleaving the air. Flying creatures, however, are less remarkable for their strength, shape and comparative levity than for the size and extraordinarily rapid and complicated movements of their wings. Prof. J. Bell Pettigrew first satisfactorily analysed those movements, and reproduced them by the aid of artificial wings. This physiologist in 1867² showed that all natural wings, whether of the insect, bird or bat, are screws structurally, and that they act as screws when they are made to vibrate, from the fact that they twist in opposite directions during the down and up strokes. He also explained that all wings act upon a common principle, and that they present oblique, kite-like surfaces to the air, through which they pass much in the same way that an oar passes through water in sculling. He further pointed out that the wings of flying creatures (contrary to received opinions, and as has been already indicated) strike downwards and *forwards* during the down strokes, and upwards and *forwards* during the up strokes. Lastly he demonstrated that the wings of flying creatures, when the

¹ By the term aeroplane is meant a thin, light, expanded structure inclined at a slight upward angle to the horizon intended to float or rest upon the air, and calculated to afford a certain amount of support to any body attached to it.

² "On the Various Modes of Flight in relation to Aeronautics," by J. Bell Pettigrew, *Proc. Roy. Inst.*, 1867; "On the Mechanical Appliances by which Flight is attained in the Animal Kingdom," by the same author, *Trans. Linn. Soc.*, 1867.

bodies of said creatures are fixed, describe *figure-of-8 tracks* in space—the figure-of-8 tracks, when the bodies are released and advancing as in rapid flight, being opened out and converted into *waved tracks*.

It may be well to explain here that a claim has been set up by his admirers for the celebrated artist, architect and engineer, Leonardo da Vinci, to be regarded as the discoverer of the principles and practice of flight (see Theodore Andrea Cook, *Spirals in Nature and Art*, 1903). The claim is, however, unwarranted; Leonardo's chief work on flight, bearing the title *Codice sul Volo degli Uccelli e Varie Altre Materie*, written in 1505, consists of a short manuscript of twenty-seven small quarto pages, with simple sketch illustrations interspersed in the text. In addition he makes occasional references to flight in his other manuscripts, which are also illustrated. In none of Leonardo's manuscripts, however, and in none of his figures, is the slightest hint given of his having any knowledge of the spiral movements made by the wing in flight or of the spiral structure of the wing itself. It is claimed that Leonardo knew the direction of the stroke of the wing, as revealed by recent researches and proved by modern instantaneous photography. As a matter of fact, Leonardo gives a wholly inaccurate account of the direction of the stroke of the wing. He states that the wing during the down stroke strikes downwards and backwards, whereas in reality it strikes downwards and forwards. In speaking of artificial flight Leonardo says: "The wings have to row downwards and backwards to support the machine on high, so that it moves forward." In speaking of natural flight he remarks: "If in its descent the bird rows backwards with its wings the bird will move rapidly; this happens because the wings strike the air which successively runs behind the bird to fill the void whence it comes." There is nothing in Leonardo's writings to show that he knew either the anatomy or physiology of the wing in the modern sense.

Pettigrew's discovery of the figure-of-8 and waved movements made by the wing in stationary and progressive flight was confirmed some two years after it was made by Prof. E. J. Marey of Paris¹ by the aid of the "sphygmograph."² The movements in question are now regarded as fundamental, from the fact that they are alike essential to natural and artificial flight.

The following is Pettigrew's description of wings and wing movements published in 1867:—

"The wings of insects and birds are, as a rule, more or less triangular in shape, the base of the triangle being directed towards the body, its sides anteriorly and posteriorly. They are also conical on section from within outwards and from before backwards, this shape converting the pinions into delicately graduated instruments balanced with the utmost nicety to satisfy the requirements of the muscular system on the one hand and the resistance and resiliency of the air on the other. While all wings are graduated as explained, innumerable varieties occur as to their general contour, some being falcated or scythe-like, others oblong, others rounded or circular, some lanceolate and some linear. The wings of insects may consist either of one or two pairs—the anterior or upper pair, when two are present, being in some instances greatly modified and presenting a corneous condition. They are then known as clytra, from the Gr. *κλυτρον*, a sheath. Both pairs are composed of a duplicature of the integument, or investing membrane, and are strengthened in various directions by a system of hollow, horny tubes, known to entomologists as the *neuræ* or *nervures*. These *nervures* taper towards the extremity of the wing, and are strongest towards its root and anterior margin, where they supply the place of the arm in birds and bats. The *neuræ* are arranged at the axis of the wing after the manner of a fan or spiral stair—the anterior one occupying a higher position than that farther back, and so of the others. As this arrangement extends also to the margins, the wings are more or less twisted upon themselves and present a certain degree of convexity on their superior or upper surface, and a corresponding concavity on their inferior or under surface,—their free edges supplying those fine curves which act with such efficacy upon the air in obtaining the maximum of resistance and the minimum of displacement. As illustrative examples of the form of wings alluded to, those of the beetle, bee and fly may be cited—the pinions in those insects acting as *helices*, or *twisted levers*, and

elevating weights much greater than the area of the wings would seem to warrant" (figs. 10 and 11). . . . "To confer on the wings the multiplicity of movements which they require, they are supplied with double hinge or compound joints, which enable them to move not only in an upward, downward, forward and backward direction, but also at various intermediate degrees of obliquity. An insect with wings thus hinged may, as far as steadiness of body is concerned, be not inaptly compared to a compass set upon gimbals, where the universality of motion in one direction ensures comparative fixedness in another." . . . "All wings obtain their leverage by presenting oblique surfaces to the air, the degree of obliquity gradually increasing in a direction from behind, forwards and downwards, during extension when the sudden or effective stroke is being given, and gradually decreasing in an opposite direction during flexion, or when the wing is being more slowly recovered preparatory to making a second stroke. The effective stroke in insects, and this holds true also of birds, is therefore delivered *downwards and forwards*, and not, as the majority of writers believe, vertically, or even slightly backwards. . . . The wing in the insect is more flattened than in the bird; and advantage is taken on some occasions of this circumstance, particularly in heavy-bodied, small-winged, quick-flying insects, to *reverse the pinion more or less completely during the down and up strokes*." . . . "This is effected in the following manner. The posterior margin of the wing is made to rotate, during the down stroke, in a direction from above downwards and from behind forwards—the anterior margin travelling in an opposite direction and reciprocating. The wing may thus be said to attack the air by a *screwing movement* from above. During the up or return stroke, on the other hand, the posterior margin rotates in a direction from below upwards and from before backwards, so that by a similar but *reverse screwing motion* the pinion attacks the air from beneath." . . . "A *figure-of-8*, compressed laterally and placed obliquely with its long axis running from left to right of the spectator, represents the movements in question. The *down and up strokes*, as will be seen from this account, *cross each other*, the wing smiting the air during its descent from above, as in the bird and bat, and during its ascent from below as in the flying fish and boy's kite" (fig. 12).

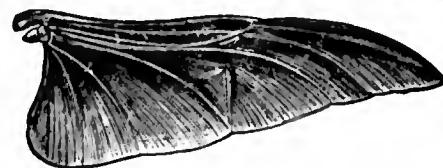

FIG. 10.—Right Wing of the Beetle (*Goliathus micans*) when at rest; seen from above.



FIG. 11.—Right Wing of the Beetle (*Goliathus micans*) when in motion; seen from behind. This figure shows how the wing twists and untwists when in action, and how it forms a true screw.

During the up or return stroke, on the other hand, the posterior margin rotates in a direction from below upwards and from before backwards, so that by a similar but reverse screwing motion the pinion attacks the air from beneath." . . . "A figure-of-8, compressed laterally and placed obliquely with its long axis running from left to right of the spectator, represents the movements in question. The down and up strokes, as will be seen from this account, cross each other, the wing smiting the air during its descent from above, as in the bird and bat, and during its ascent from below as in the flying fish and boy's kite" (fig. 12).

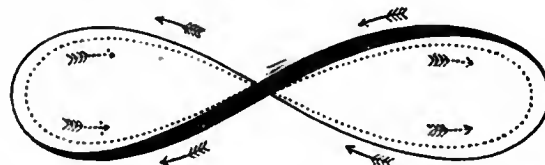

FIG. 12 shows the figure-of-8 made by the margins of the wing in extension (continuous line), and flexion (dotted line). As the tip of the wing is mid-way between its margins, a line between the continuous and dotted lines gives the figure-of-8 made by the tip. The arrows indicate the reversal of the planes of the wing, and show how the down and up strokes cross each other.

. . . "The figure-of-8 action of the wing explains how an insect or bird may fix itself in the air, the backward and forward reciprocating action of the pinion affording support, but no propulsion. In these instances the backward and forward strokes are made to counterbalance each other. Although the figure-of-8 represents with considerable fidelity the twisting of the wing upon its axis during extension and flexion, when the insect is playing its wings before an object, or still better when it is artificially fixed, it is otherwise when the down stroke is added and the insect is fairly on the wing and progressing rapidly. In this case the wing, in virtue of its being carried forward by the body in motion, describes an undulating or spiral course, as shown in fig. 13."

. . . "The down and up strokes are compound movements—the termination of the down stroke embracing the beginning of the up stroke, and the termination of the up stroke including the beginning of the down stroke. This is necessary in order that the down and up strokes may glide into each other in such a manner as to prevent jerking and unnecessary retardation."³ . . .

³ This continuity of the down into the up stroke and the converse is greatly facilitated by the elastic ligaments at the root and in the

¹ *Revue des cours scientifiques de la France et de l'Étranger*, 1869.

² The sphygmograph, as its name indicates, is a recording instrument. It consists of a smoked cylinder revolving by means of clock-work at a known speed, and a style or pen which inscribes its surface by scratching or brushing away the lampblack. The movements to be registered are transferred to the style or pen by one or more levers, and the pen in turn transfers them to the cylinder, where they appear as legible tracings. In registering the movements of the wings the tips and margins of the pinions were, by an ingenious modification, employed as the styles or pens. By this arrangement the different parts of the wings were made actually to record their own movements. As will be seen from this account, the figure-of-8 or wave theory of stationary and progressive flight has been made the subject of a rigorous *experimentum crucis*.

"The wing of the bird, like that of the insect, is concavo-convex, and more or less twisted upon itself when extended, so that the anterior or thick margin of the pinion presents a different degree of curvature to that of the posterior or thin margin. This twisting is in a great measure owing to the manner in which the bones of the wing are twisted upon themselves, and the spiral nature of their articular surfaces—the long axes of the joints always intersecting each other



FIG. 13.—Wave track made by the wing in progressive flight. *a, b*, Crests of the wave; *c, d, e*, up strokes; *x, x*, down strokes; *f*, point corresponding to the anterior margin of the wing, and forming a centre for the downward rotation of the wing (*a, g*); *g*, point corresponding to the posterior margin of the wing, and forming a centre for the upward rotation of the wing (*d, f*).

at right angles, and the bones of the elbow and wrist making a quarter of a turn or so during extension and the same amount during flexion. As a result of this disposition of the articular surfaces, the wing may be shot out or extended, and retracted or flexed in nearly the same plane, the bones composing the wing rotating on their axes during either movement (fig. 14). The secondary action, or the revolving of

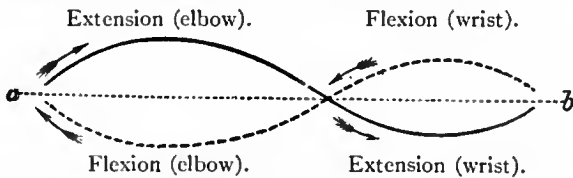

FIG. 14.—*a, b*, line along which the wing travels during extension and flexion. The arrows indicate the direction in which the wing is spread out in extension and closed or folded in flexion.

the component bones on their own axes, is of the greatest importance in the movements of the wing, as it communicates to the hand and forearm, and consequently to the primary and secondary feathers which they bear, the precise angles necessary for flight. It in fact ensures that the wing, and the curtain or fringe of the wing which the primary and secondary feathers form, shall be screwed into and down upon the wind in extension, and unscrewed or withdrawn from the wind during flexion. The wing of the bird may therefore be compared to a huge gimlet or auger, the axis of the gimlet representing the bones of the wing, the flanges or spiral thread of the gimlet



FIG. 15.—Right Wing of the Red-legged Partridge (*Perdix rubra*). Dorsal aspect as seen from above.

... "The wing, both when at rest and when in motion, may not inaptly be compared to the blade of an ordinary screw propeller as employed in navigation. Thus the general outline of the wing corresponds closely with the outline of the propeller (figs. 11, 16 and 18), and the track described by the wing in space is twisted upon itself propeller fashion¹ (figs. 12, 20, 21, 22, 23). The great velocity with which the wing is driven converts the impression or blur made by it into what is equivalent to a solid for the time being, in the same way that the spokes of a wheel in violent motion, as is well understood, more or less completely



FIG. 16.—Right Wing of the Red-legged Partridge (*Perdix rubra*). Dorsal and ventral aspects as seen from behind; showing auger-like conformation of wing. Compare with figs. 11 and 18.

substance of the wing. These assist in elevating, and, when necessary, in flexing and elevating it. They counteract in some measure what may be regarded as the dead weight of the wing, and are especially useful in giving it continuous play.

¹ "The importance of the twisted configuration or screw-like form cannot be over-estimated. That this shape is intimately associated with flight is apparent from the fact that the rowing feathers of the wing of the bird are every one of them distinctly spiral in their nature; in fact, one entire rowing feather is equivalent—morphologically and physiologically—to one entire insect wing. In the

occupy the space contained within the rim or circumference of the wheel" (figs. 9, 20 and 21).

... "The wing of the bat bears a considerable resemblance to that of the insect, inasmuch as it consists of a delicate, semi-transparent, continuous membrane, supported in divers directions, particularly towards its anterior margin, by a system of osseous stays or stretchers which confer upon it the degree of rigidity requisite for flight. It is, as a rule, deeply concave on its under or ventral surface, and in this respect resembles the wing of the heavy-bodied birds. The movement of the bat's wing in extension is a spiral one, the spiral running alternately from below upwards and forwards and from above downwards and backwards. The bat, and the movements of its component



FIG. 17.—Right Wing of the Bat (*Phyllocolpa gracilis*). Dorsal aspect as seen from above.

... "The wing strikes the air precisely as a boy's kite would if it were jerked by its string, the only difference being that the kite is pulled forwards upon the wind by the string and the hand, whereas in the insect, bird and bat the wing is pushed forwards on the wind by the weight of the body and the power residing in the pinion itself" (fig. 19).²



FIG. 18.—Right Wing of the Bat (*Phyllocolpa gracilis*). Dorsal and ventral aspects, as seen from behind. These show the screw-like configuration of the wing, and also how the wing twists and untwists during its action.



FIG. 19.—The Cape Barn-owl (*Strix capensis*), showing the kite-like surfaces presented by the ventral aspect of the wings and body in flight.

The figure-of-8 and kite-like action of the wing referred to lead us to explain how it happens that the wing, which in many instances is a comparatively small and delicate organ, can yet attack the air with such vigour as to extract from it the recoil necessary to elevate and propel the flying creature. The accompanying figures from one of Pettigrew's later memoirs³ will serve to explain the rationale (figs. 20, 21, 22 and 23).

As will be seen from these figures, the wing during its vibration sweeps through a comparatively very large space. This space, as already explained, is practically a solid basis of support for the wing and for the flying animal. The wing attacks the air in such a manner as virtually to have no slip—this for two reasons. The wing reverses instantly and acts as a kite during nearly the entire down and up strokes. The angles, moreover, made by the wing with the horizon during the down and up strokes are at no two intervals the same, but (and this is a

wing of the martin, where the bones of the pinion are short, and in some respects rudimentary, the primary and secondary feathers are greatly developed, and banked up in such a manner that the wing as a whole presents the same curves as those displayed by the insect's wing, or by the wing of the eagle, where the bones, muscles and feathers have attained a maximum development. The conformation of the wing is such that it presents a waved appearance in every direction—the waves running longitudinally, transversely and obliquely. The greater portion of the wing may consequently be removed without essentially altering either its form or its functions. This is proved by making sections in various directions, and by finding that in some instances as much as two-thirds of the wing may be lopped off without materially impairing the power of flight."—*Trans. Roy. Soc. Edin.* vol. xxvi. pp. 325, 326.

² "On the Various Modes of Flight in relation to Aeronautics," *Proc. Roy. Inst.*, 1867; "On the Mechanical Appliances by which Flight is attained in the Animal Kingdom," *Trans. Linn. Soc.*, 1867, 26.

³ "On the Physiology of Wings; being an analysis of the movements by which flight is produced in the Insect, Bat and Bird," *Trans. Roy. Soc. Edin.* vol. 26.

remarkable circumstance) they are always adapted to the speed at which the wing is travelling for the time being. The increase and decrease in the angles made by the wing as it hastens to and fro are due partly to the resistance offered by the air, and partly to the mechanism and mode of application of the wing to the air. The wing, during its vibrations, rotates upon two separate centres, the tip rotating round the root of the wing as an axis (short axis of wing), the posterior margin rotating around

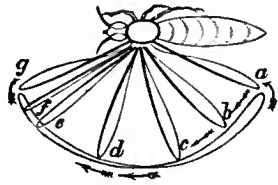

FIG. 20.

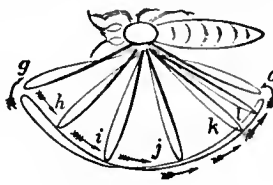

FIG. 21.

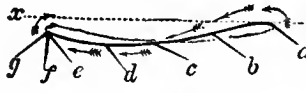

FIG. 22.



FIG. 23.

FIGS. 20, 21, 22 and 23 show the area mapped out by the left wing of the Wasp when the insect is fixed and the wing made to vibrate. These figures illustrate the various angles made by the wing with the horizon as it hastens to and fro, and show how the wing reverses and reciprocates, and how it twists upon itself in opposite directions, and describes a figure-of-8 track in space. Figs. 20 and 22 represent the forward or down stroke (*a b c d e f g*), figs. 21 and 23 the backward or up stroke (*g h i j k l a*). The terms forward and back strokes are here employed with reference to the head of the insect. *x, x'*, line to represent the horizon. If fig. 22, representing the down or forward stroke, be placed upon fig. 23, representing the up or backward stroke, it will be seen that *the wing crosses its own track* more or less completely at every stage of the down and up strokes.

the anterior margin (long axis of wing). The wing is really eccentric in its nature, a remark which applies also to the rowing feathers of the bird's wing. The compound rotation goes on throughout the entire down and up strokes, and is intimately associated with the power which the wing enjoys of alternately seizing and evading the air.

The compound rotation of the wing is greatly facilitated by the wing being elastic and flexible. It is this which causes the wing to twist and untwist diagonally on its long axis when it is made to vibrate. The twisting referred to is partly a vital and partly a mechanical act;—that is, it is occasioned in part by the action of the muscles and in part by the greater resistance experienced from the air by the tip and posterior margin of the wing as compared with the root and anterior margin,—the resistance experienced by the tip and posterior margin causing them to reverse always subsequently to the root and anterior margin, which has the effect of throwing the anterior and posterior margins of the wing into figure-of-8 curves, as shown at figs. 9, 11, 12, 16, 18, 20, 21, 22 and 23.

The compound rotation of the wing, as seen in the bird, is represented in fig. 24.

Not the least curious feature of the wing movements is the remarkable power which the wing possesses of making and utilizing its own currents. Thus, when the wing descends it draws after it a strong current, which, being met by the wing during its ascent, greatly increases the efficacy of the up stroke. Similarly and conversely, when the wing ascends, it creates an upward current, which, being met by the wing when it descends, powerfully contributes to the efficiency of the down stroke. This statement can be readily verified by experiment both with natural and artificial wings. Neither the up nor the down strokes are complete in themselves.

The wing to act efficiently must be driven at a certain speed, and in such a manner that the down and up strokes shall glide into each other. It is only in this way that the air can be made to pulsate, and that the rhythm of the wing and the air waves can be made to correspond. The air must be seized and let go in a certain order and at a certain speed to extract a maximum

recoil. The rapidity of the wing movements is regulated by the size of the wing, small wings being driven at a very much higher speed than larger ones. The different parts of the wing, moreover, travel at different degrees of velocity—the tip and posterior margin of the wing always rushing through a much greater space, in a given time, than the root and anterior margin.

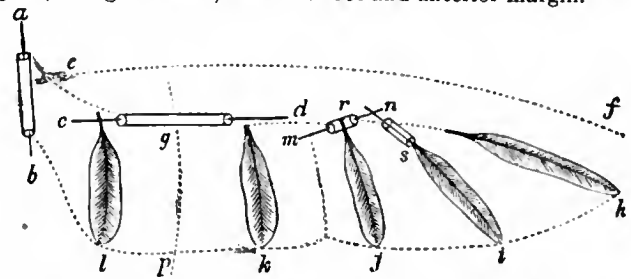

FIG. 24.—Wing of the Bird with its root (*a, b*) cranked forwards.

- a, b*, Short axis of the wing (axis for tip of wing, *h*).
- c, d*, Long axis (axis for posterior margin of wing, *h, i, j, k, l*).
- m, n*, Short axis of rowing feathers of wing.
- r, s*, Long axis of rowing feathers *ef, g p*, concave shape presented by the under surface of the wing.

The rapidity of travel of the insect wing is in some cases enormous. The wasp, for instance, is said to ply its wings at the rate of 110, and the common house-fly at the rate of 330 beats per second. Quick as are the vibrations of natural wings, the speed of certain parts of the wing is amazingly increased. Wings as a rule are long and narrow. As a consequence, a comparatively slow and very limited movement at the root confers great range and immense speed at the tip, the speed of each portion of the wing increasing as the root of the wing is receded from. This is explained on a principle well understood in mechanics, viz. that when a wing or rod hinged at one end is made to move in a circle, the tip or free end of the wing or rod describes a much wider circle in a given time than a portion of the wing or rod nearer the hinge (fig. 25).

One naturally inquires why the high speed of wings, and why the progressive increase of speed at their tips and posterior margins? The answer is not far to seek. If the wings were not driven at a high speed, and if they were not eccentrics made to revolve upon two separate axes, they would of necessity be large cumbersome structures; but large heavy wings would be difficult to work, and what is worse, they would (if too large), instead of controlling the air, be controlled by it, and so cease to be flying organs. There is, however, another reason why wings should be made to vibrate at high speeds. The air, as explained, is a very light, thin, elastic medium, which yields on the slightest pressure, and unless the wings attacked it with great violence the necessary recoil or resistance could not be obtained. The atmosphere, because of its great tenuity, mobility and comparative imponderability, presents little resistance to bodies passing through it at low velocities. If, however, the speed be greatly accelerated,

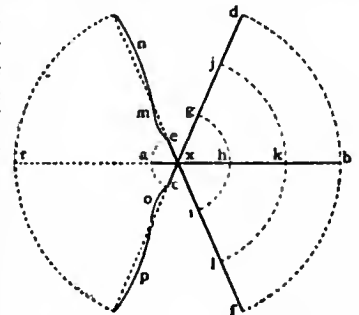

FIG. 25 shows how different portions of the wing travel at different degrees of speed. In this figure the rod *a, b*, hinged at *x*, represents the wing. When the wing is made to vibrate, its several portions travel through the spaces *d b f, j k l, g h i*, and *e a c* in exactly the same interval of time. The part of the wing marked *b*, which corresponds with the tip, consequently travels very much more rapidly than the part marked *a*, which corresponds with the root. *m n, o p*, curves made by the wing at the end of the up and down strokes; *r*, position of the wing at the middle of the stroke.

large heavy wings would be difficult to work, and what is worse, they would (if too large), instead of controlling the air, be controlled by it, and so cease to be flying organs.

There is, however, another reason why wings should be made to vibrate at high speeds. The air, as explained, is a very light, thin, elastic medium, which yields on the slightest pressure, and unless the wings attacked it with great violence the necessary recoil or resistance could not be obtained. The atmosphere, because of its great tenuity, mobility and comparative imponderability, presents little resistance to bodies passing through it at low velocities. If, however, the speed be greatly accelerated,

the action of even an ordinary cane is sufficient to elicit a recoil. This comes of the action and reaction of matter, the resistance experienced varying according to the density of the atmosphere and the shape, extent and velocity of the body acting upon it. While, therefore, scarcely any impediment is offered to the progress of an animal in motion in the air, it is often exceedingly difficult to compress the air with sufficient rapidity and energy to convert it into a suitable fulcrum for securing the necessary support and forward impetus. This arises from the fact that bodies moving in air experience a *minimum of resistance* and occasion a *maximum of displacement*. Another and very obvious difficulty is traceable to the great disparity in the weight of air as compared with any known solid, and the consequent want of buoying or sustaining power which that disparity involves. If we compare air with water we find it is nearly 1000 times lighter. To meet these peculiarities the insect, bird and bat are furnished with extensive flying surfaces in the shape of wings, which they apply with singular velocity and power to the air, as levers of the third order. In this form of lever the power is applied between the fulcrum and the weight to be raised. The power is represented by the wing, the fulcrum by the air, and the weight by the body of the flying animal. Although the third order of lever is particularly inefficient when the fulcrum is rigid and immobile, it possesses singular advantages when these conditions are reversed, that is, when the fulcrum, as happens with the air, is *elastic and yielding*. In this instance a very slight movement at the root of the pinion, or that end of the lever

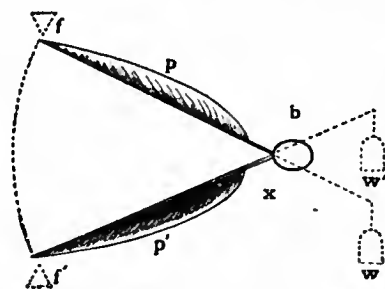

FIG. 26.—In this figure f, f' represent the movable fulcrum furnished by the air, p, p' the power residing in the wing, and b the body to be moved. In order to make the problem of flight more intelligible, the lever formed by the wing is prolonged beyond the body (b), and to the root of the wing so extended the weight (w, w') is attached; x represents the universal joint by which the wing is attached to the body. When the wing ascends as shown at p , the air (fulcrum f) resists its upward passage, and forces the body (b) or its representative (w) slightly downwards. When the wing descends as shown at p' , the air (fulcrum f') resists its downward passage, and forces the body (b) or its representative (w') slightly upwards. From this it follows that when the wing rises the body falls, and vice versa—the wing describing the arc of a large circle (f, f'), the body (b), or the weights (w, w') representing it, describing the arc of a small circle.

active and the wings more or less passive. It is in this way that weight forms a factor in flight, the wings and the weight of the body reciprocating and mutually assisting and relieving each other. This is an argument for employing four wings in artificial flight,—the wings being so arranged that the two which are up shall always by their fall mechanically elevate the two which are down. Such an arrangement is calculated greatly to conserve the driving power, and as a consequence, to reduce the weight.

¹ The other forces which assist in elevating the wings are—(a) the elevator muscles of the wings, (b) the elastic properties of the wings, and (c) the reaction of the compressed air on the under surfaces of the wings.

That the weight of the body plays an important part in the production of flight may be proved by a very simple experiment. If two quill feathers are fixed in an ordinary cork, and so arranged that they expand and arch above it (fig. 27), it is found that if the apparatus be dropped from a vertical height of 3 yds. it does not fall vertically downwards, but downwards and forwards in a curve, the forward travel amounting in some instances to a yard and a half. Here the cork, in falling, acts upon the feathers (which are to all intents and purposes wings), and these in turn act upon the air, in such a manner as to produce a horizontal transference.

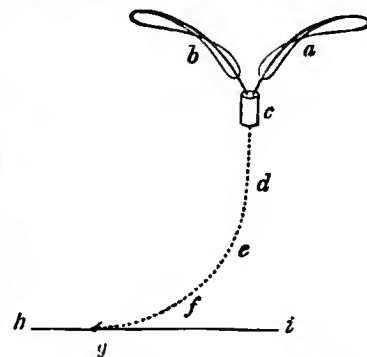

FIG. 27.— a, b , quill feathers; c , cork; d, e, f, g , downward and forward curved trajectory made by the feathers and cork before reaching the ground (h, i).

In order to utilize the air as a means of transit, the body in motion, whether it moves in virtue of the life it possesses, or because of a force super-added, must be heavier than air. It must tread with its wings and rise upon the air as a swimmer upon the water, or as a kite upon the wind. This is necessary for the simple reason that the body must be active, the air passive. The flying body must act against gravitation, and elevate and carry itself forward at the expense of the air and of the force which resides in it, whatever that may be. If it were otherwise—if it were rescued from the law of gravitation on the one hand, and bereft of independent movement on the other, it would float about uncontrolled and uncontrollable like an ordinary balloon.

In flight one of two things is necessary. Either the wings must attack the air with great violence, or the air in rapid motion must attack the wings: either suffices. If a bird attempts to fly in a calm, the wings must be made to smite the air after the manner of a boy's kite with great vigour and at a high speed. In this case the wings fly the bird. If, however, the bird is fairly launched in space and a stiff breeze is blowing, all that is required in many instances is to extend the wings at a slight upward angle to the horizon so that the under parts of the wings present kite-like surfaces. In these circumstances the rapidly moving air flies the bird. The flight of the albatross supplies the necessary illustration. If by any chance this magnificent bird alights upon the sea he must flap and beat the water and air with his wings with tremendous energy until he gets fairly launched. This done he extends his enormous pinions² and sails majestically along, seldom deigning to flap his wings, the breeze doing the work for him. A familiar illustration of the same principle may be witnessed any day when children are engaged in the pastime of kite-flying. If two boys attempt to fly a kite in a calm, the one must hold up the kite and let go when the other runs. In this case the under surface of the kite is made to strike the still air. If, however, a stiff autumn breeze be blowing, it suffices if the boy who formerly ran when the kite was let go stands still. In this case the air in rapid motion strikes the under surface of the kite and forces it up. The string and the hand are to the kite what the weight of the flying creature is to the inclined planes formed by its wings.

The area of the insect, bird and bat, when the wings are fully expanded, is greater than that of any other class of animal, their weight being proportionally less. As already stated, however, it ought never to be forgotten that even the lightest insect, bird or bat is vastly heavier than the air, and that no fixed relation exists between the weight of body and expanse of wing in any of the orders. We have thus light-bodied and

² The wings of the albatross, when fully extended, measure across the back some 14 ft. They are exceedingly narrow, being sometimes under a foot in width.

large-winged insects and birds, as the butterfly and heron; and others with heavy bodies and small wings, as the beetle and partridge. Similar remarks are to be made of bats. Those apparent inconsistencies in the dimensions of the body and wings are readily explained by the greater muscular development of the heavy-bodied, small-winged insects, birds and bats, and the increased power and rapidity with which the wings in them are made to oscillate. This is of the utmost importance in the science of aviation, as showing that flight may be attained by a heavy powerful animal with comparatively small wings, as well as by a lighter one with greatly enlarged wings. While, therefore, there is apparently no correspondence between the area of the wing and the animal to be raised, there is, except in the case of sailing insects, birds and bats, an unvarying relation as to the weight and number of oscillations; so that the problem of flight would seem to resolve itself into one of weight, power, velocity and small surfaces, *versus* buoyancy, debility, diminished speed and extensive surfaces—weight in either case being a *sine qua non*.

That no fixed relation exists between the area of the wings and the size and weight of the body to be elevated is evident on comparing the dimensions of the wings and bodies of the several orders of insects, bats and birds. If such comparison be made, it will be found that the pinions in some instances diminish while the bodies increase, and the converse. No practical good can therefore accrue to aviation from elaborate measurements of the wings and body of any flying thing; neither can any rule be laid down as to the extent of surface required for sustaining a given weight in the air. The statements here advanced are borne out by the fact that the wings of insects, bats and birds may be materially reduced without impairing their powers of flight. In such cases the speed with which the wings are driven is increased in the direct ratio of the mutilation. The inference to be deduced from the foregoing is plainly this, that even in large-bodied, small-winged insects and birds the wing-surface is greatly in excess, the surplus wing area supplying

this we have a partial explanation of the buoyancy of insects, and the great lifting power possessed by birds and bats,—the bats carrying their young without inconvenience, the birds elevating surprising quantities of fish, game, carrion, &c. (fig. 28).

While as explained, no definite relation exists between the weight of a flying animal and the size of its flying surfaces, there being, as stated, heavy-bodied and small-winged insects, birds and bats, and the converse, and while, as has been shown, flight is possible within a wide range, the wings being, as a rule, in excess of what are required for the purposes of flight,—still it appears from the researches of L. de Lucy that there is a general law, to the effect that the larger the volant animal, the smaller, by comparison, are its flying surfaces. The existence of such a law is very encouraging so far as artificial flight is concerned, for it shows that the flying surfaces of a large, heavy, powerful flying machine will be comparatively small, and consequently comparatively compact and strong. This is a point of very considerable importance, as the object desiderated in a flying machine is elevating capacity.

De Lucy tabulated his results as under:—

INSECTS.			BIRDS.		
Names.	Flying Surface referred to the Kilogramme = 2 lb 8 oz. 3 dwt. 2 gr. avoird. = 2 lb 3 oz. 4.428 dr. troy.		Names.	Flying Surface referred to the Kilogramme.	
	sq. yds.	ft. in.		sq. yds.	ft. in.
Gnat	11	8 92	Swallow	1	1 104
Dragon-fly (small)	7	2 56	Sparrow	0	5 142
Coccinella (Lady-bird)	5	13 87	Turtle-dove	0	4 100
Dragon-fly (common)	5	2 89	Pigeon	0	2 113
Tipula, or Daddy-long-legs	3	5 11	Stork	0	2 20
Bee	1	2 74½	Vulture	0	1 116
Meat-fly	1	3 54½	Crane of Australia	0	0 130
Drone (blue)	1	2 20			
Cockchafer	1	2 50			
Lucanus { Stag-beetle (female) }	1	1 39½			
cervus { Stag-beetle (male) }	0	8 33			
Rhinoceros-beetle	0	6 122½			

"It is easy, by the aid of this table, to follow the order, always decreasing, of the surfaces, in proportion as the winged animal increases in size and weight. Thus, in comparing the insects with one another, we find that the gnat, which weighs 460 times less than the stag-beetle, has 14 times more of surface. The lady-bird weighs 150 times less than the stag-beetle, and possesses 5 times more of surface, &c. It is the same with the birds. The sparrow weighs about 10 times less than the pigeon, and has twice as much surface. The pigeon weighs about 8 times less than the stork, and has twice as much surface. The sparrow weighs 339 times less than the Australian crane, and possesses 7 times more surface, &c. If now we compare the insects and the birds, the gradation will become even much more striking. The gnat, for example, weighs 97,000 times less than the pigeon, and has 40 times more surface; it weighs three millions of times less than the crane of Australia, and possesses 140 times more of surface than this latter, the weight of which is about 9 kilogrammes 500 grammes (25 lb 5 oz. 9 dwt. troy, 20 lb 15 oz. 2½ dr. avoirdupois).

The Australian crane, the heaviest bird weighed, is that which has the smallest amount of surface, for, referred to the kilogramme, it does not give us a surface of more than 899 square centimetres (139 sq. in.), that is to say, about an eleventh part of a square metre. But every one knows that these gallatorial animals are excellent birds of flight. Of all travelling birds they undertake the longest and most remote journeys. They are, in addition, the eagle excepted, the birds which elevate themselves the highest, and the flight of which is the longest maintained."

The way in which the natural wing rises and falls on the air, and reciprocates with the body of the flying creature, has a very obvious bearing upon artificial flight. In natural flight the body of the flying creature falls slightly forward in a curve when the



FIG. 28.—Hawk and Pigeon.

that degree of elevating and sustaining power which is necessary to prevent undue exertion on the part of the volant animal. In

¹ On the Flight of Birds, of Bats and of Insects, in reference to the subject of Aerial Locomotion, by L. de Lucy (Paris).

wing ascends, and is slightly elevated in a curve when the wing descends. The wing and body are consequently always playing at cross purposes, the wing rising when the body is falling and vice versa. The alternate rise and fall of the body and wing of the bird are well seen when contemplating the flight of the gull

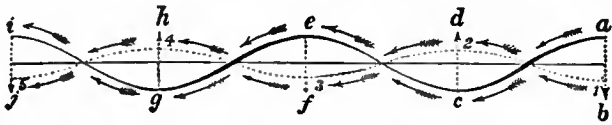

FIG. 29 shows how in progressive flight the wing and the body describe *waved tracks*,—the crests of the waves made by the wing (*a, c, e, g, i*) being placed opposite the crests of the waves made by the body *1, 2, 3, 4, 5*.

from the stern of a steamboat, as the bird is following in the wake of the vessel. The complementary movements referred to are indicated at fig. 29, where the continuous waved line represents the trajectory made by the wing, and the dotted waved line that made by the body. As will be seen from this figure, *the wing advances both when it rises and when it falls*. It is a peculiarity of natural wings, and of artificial wings constructed on the principle of living wings, that when forcibly elevated or depressed, even in a strictly vertical direction, they inevitably dart forward. If, for instance, the wing is suddenly depressed in a vertical direction, as at *a b* of fig. 29, it at once darts downwards and forwards in a double curve (see continuous line of figure) to *c*, thus converting the vertical down stroke into a *down, oblique, forward stroke*. If, again, the wing be suddenly elevated in a strictly vertical direction, as at *c d*, the wing as certainly darts upwards and forwards in a double curve to *e*, thus converting the vertical up strokes into an *upward, oblique, forward stroke*. The same thing happens when the wing is depressed from *e* to *f* and elevated from *g* to *h*, the wing describing a *waved track* as at *e g, g i*.

There are good reasons why the wings should always be in advance of the body. A bird when flying is a body in motion; but a body in motion tends to fall not vertically downwards, but *downwards and forwards*. The wings consequently must be made to strike *forwards* and kept in advance of the body of the bird if they are to prevent the bird from falling *downwards and forwards*. If the wings were to strike backwards in aerial flight, the bird would turn a forward somersault.

That the wings invariably strike forwards during the down and up strokes in aerial flight is proved alike by observation and experiment. If any one watches a bird rising from the ground or the water, he cannot fail to perceive that the head and body are slightly tilted upwards, and that the wings are made to descend with great vigour in a downward and *forward* direction. The dead natural wing and a properly constructed artificial wing act in precisely the same way. If the wing of a gannet, just shot, be removed and made to flap in what the operator believes to be a strictly vertical downward direction, the tip of the wing, in spite of him, will dart forwards between 2 and 3 ft.—the amount of forward movement being regulated by the rapidity of the down stroke. This is a very striking experiment. The same thing happens with a properly constructed artificial wing. The down stroke with the artificial as with the natural wing is invariably converted into an oblique, downward and forward stroke. No one ever saw a bird in the air flapping its wings towards its tail. The old idea was that the wings during the down stroke *pushed* the body of the bird in an upward and forward direction; in reality the wings do not push but *pull*, and in order to pull they must always be in advance of the body to be flown. If the wings did not themselves fly *forward*, they could not possibly cause the body of the bird to fly forward. It is the wings which cause the bird to fly.

It only remains to be stated that the wing acts as a true kite, during both the down and the up strokes, its under concave or biting surface, in virtue of the forward travel communicated to it by the body of the flying creature, being closely applied to the air, during both its ascent and its descent. This explains

how the wing furnishes a persistent buoyancy alike when it rises and when it falls (fig. 30).

The natural kite formed by the wing differs from the artificial kite only in this, that the former is capable of being moved in all its parts, and is more or less flexible and elastic, whereas the latter is comparatively rigid. The flexibility and elasticity of the kite formed by the natural wing are rendered necessary by the fact that the wing, as already stated, is practically hinged at its root and along its anterior margin, an arrangement which necessitates its several parts travelling at different degrees of speed, in proportion as they are removed from the axes of rotation. Thus the tip travels at a higher speed than the root, and the posterior margin than the anterior margin. This begets a *twisting diagonal movement* of the wing on its long axis, which, but for the elasticity referred to, would break the wing into fragments. The elasticity contributes also to the continuous play of the wing, and ensures that no two parts of it shall reverse at exactly the same instant. If the wing was inelastic, every part of it would reverse at precisely the same moment, and its vibration would be characterized by pauses or dead points at the end of the down and up strokes which would be fatal to it as a flying organ.

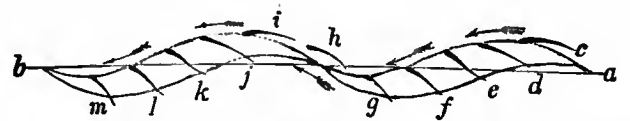

FIG. 30 shows the kite-like action of the wing during the down and up strokes, how the angles made by the wing with the horizon (*a, b*) vary at every stage of these strokes, and how the wing evades the superimposed air during the up stroke, and seizes the nether air during the down stroke. In this figure the spaces between the double dotted lines (*c g, i b*) represent the down strokes, the single dotted line (*h, i*) representing the up stroke. The kite-like surfaces and angles made by the wing with the horizon (*a, b*) during the down strokes are indicated at *c d e f g, j k l m*,—those made during the up strokes being indicated at *g h i*. As the down and up strokes run into each other, and the convex surface of the wing is always directed upwards and the concave surface downwards, it follows that the upper surface of the wing evades in a great measure the upper air, while the under surface seizes the nether air. It is easy to understand from this figure how the wing always flying forwards furnishes a persistent buoyancy.

The elastic properties of the wing are absolutely essential, when the mechanism and movements of the pinion are taken into account. A rigid wing can never be an effective flying instrument.

The kite-like surfaces referred to in natural flight are those upon which the constructors of flying machines very properly ground their hopes of ultimate success. These surfaces may be conferred on artificial wings, aeroplanes, aerial screws or similar structures; and these structures, if we may judge from what we find in nature, *should be of moderate size and elastic*. The power of the flying organs will be increased if they are driven at a comparatively high speed, and particularly if they are made to reverse and reciprocate, as in this case they will practically create the currents upon which they are destined to rise and advance. The angles made by the kite-like surfaces with the horizon should vary according to circumstances. They should be small when the speed is high, and vice versa. This, as stated, is true of natural wings. It should also be true of artificial wings and their analogues.

Artificial Flight.—We are now in a position to enter upon a consideration of artificial wings and wing movements, and of artificial flight and flying machines.

We begin with artificial wings. The first properly authenticated account of an artificial wing was given by G. A. Borelli in 1670. This author, distinguished alike as a physiologist, mathematician and mechanic, describes and figures a bird with artificial wings, each of which consists of a *rigid rod in front and flexible feathers behind*. The wings are represented as striking *vertically downwards*, as the annexed duplicate of Borelli's figure shows (fig. 31).

Borelli was of opinion that flight resulted from the application of an inclined plane, which beats the air, and which has a wedge

action. He, in fact, endeavours to prove that a bird wedges itself forward upon the air by the perpendicular vibration of its wings, the wings during their action forming a wedge, the base of

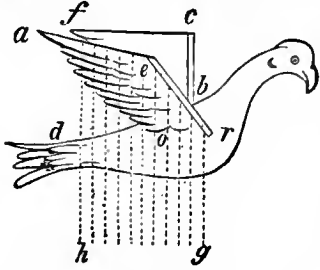

FIG. 31.

- Borelli's bird with artificial wings.
- r e*, Anterior margin of the right wing, consisting of a rigid rod.
 - o a*, Posterior margin of the right wing, consisting of flexible feathers.
 - b c*, Anterior; and
 - f*, Posterior margins of the left wing same as the right.
 - d*, Tail of the bird.
 - r g, d h*, Vertical direction of the down stroke of the wing.

which (*c b e*) is directed towards the head of the bird, the apex (*a f*) being directed towards the tail (*d*). In the 196th proposition of his work (*De motu animalium*, Leiden, 1685) he states that—

“If the expanded wings of a bird suspended in the air shall strike the undisturbed air beneath it with a motion perpendicular to the horizon, the bird will fly with a transverse motion in a plane parallel with the horizon.” “If,” he adds, “the wings of the bird be expanded, and the under surfaces of the wings be struck by the air ascending perpendicularly to the horizon with such a force as shall prevent the bird gliding downwards (*i.e.* with a tendency to glide downwards) from falling, it will be urged in a horizontal direction.”

The same argument is restated in different words as under:—“If the air under the wings be struck by the flexible portions of the wings (*flabella*, literally fly flaps or small fans) with a motion perpendicular to the horizon, the sails (*vela*) and flexible portions of the wings (*flabella*) will yield in an upward direction and form a wedge, the point of which is directed towards the tail. Whether, therefore, the air strikes the wings from below, or the wings strike the air from above, the result is the same,—the posterior or flexible margins of the wings yield in an upward direction, and in so doing urge the bird in a horizontal direction.”

There are three points in Borelli's argument to which it is necessary to draw attention: (1) the direction of the down stroke: it is stated to be vertically downwards; (2) the construction of the anterior margin of the wing: it is stated to consist of a rigid rod; (3) the function delegated to the posterior margin of the wing: it is said to yield in an upward direction during the down stroke.

With regard to the first point. It is incorrect to say the wing strikes vertically downwards, for, as already explained, the body of a flying bird is a body in motion; but as a body in motion tends to fall downwards and forwards, the wing must strike downwards and forwards in order effectually to prevent its fall. Moreover, in point of fact, all natural wings, and all artificial wings constructed on the natural type, invariably strike downwards and forwards.

With regard to the second point, viz. the supposed rigidity of the anterior margin of the wing, it is only necessary to examine the anterior margins of natural wings to be convinced that they are in every case flexible and elastic. Similar remarks apply to properly constructed artificial wings. If the anterior margins of natural and artificial wings were rigid, it would be impossible to make them vibrate smoothly and continuously. This is a matter of experiment. If a rigid rod, or a wing with a rigid anterior margin, be made to vibrate, the vibration is characterized by an unequal jerky motion, at the end of the down and up strokes, which contrasts strangely with the smooth, steady fanning movement peculiar to natural wings.

As to the third point, viz. the upward bending of the posterior margin of the wing during the down stroke, it is necessary to remark that the statement is true if it means a slight upward bending, but that it is untrue if it means an extensive upward bending.

Borelli does not state the amount of upward bending, but one of his followers, E. J. Marey, maintains that during the down stroke the wing yields until its under surface makes a backward angle with the horizon of 45°. Marey further states that during the up stroke the wing yields to a corresponding extent in an opposite direction—the posterior margin of the wing, according

to him, passing through an angle of 90°, plus or minus according to circumstances, every time the wing rises and falls.

That the posterior margin of the wing yields to a slight extent during both the down and up strokes will readily be admitted, alike because of the very delicate and highly elastic properties of the posterior margins of the wing, and because of the comparatively great force employed in its propulsion; but that it does not yield to the extent stated by Marey is a matter of absolute certainty. This admits of direct proof. If any one watches the horizontal or upward flight of a large bird he will observe that the posterior or flexible margin of the wing never rises during the down stroke to a perceptible extent, so that the under surface of the wing, as a whole, never looks backwards. On the contrary, he will perceive that the under surface of the wing (during the down stroke) invariably looks forwards and forms a true kite with the horizon, the angles made by the kite varying at every part of the down stroke, as shown more particularly at *c d e f g, i j k l m* of fig. 30.

The authors who have adopted Borelli's plan of artificial wing, and who have endorsed his mechanical views of the wing's action most fully, are J. Chabrier, H. E. G. Strauss-Dürckheim and Marey. Borelli's artificial wing, it will be remembered, consists of a rigid rod in front and a flexible sail behind. It is also made to strike vertically downwards. According to Chabrier, the wing has only one period of activity. He believes that if the wing be suddenly lowered by the depressor muscles, it is elevated solely by the reaction of the air. There is one unanswerable objection to this theory: the birds and bats, and some if not all the insects, have distinct elevator muscles, and can elevate their wings at pleasure when not flying and when, consequently, the reaction of the air is not elicited. Strauss-Dürckheim agrees with Borelli both as to the natural and the artificial wing. He is of opinion that the insect abstracts from the air by means of the inclined plane a component force (composant) which it employs to support and direct itself. In his theology of nature he describes a schematic wing as consisting of a rigid ribbing in front, and a flexible sail behind. A membrane so constructed will, according to him, be fit for flight. It will suffice if such a sail elevates and lowers itself successively. It will of its own accord dispose itself as an inclined plane, and receiving obliquely the reaction of the air, it transfers into tractile force a part of the vertical impulsion it has received. These two parts of the wing, moreover, are equally indispensable to each other.

Marey repeats Borelli and Dürckheim with very trifling modifications, so late as 1869. He describes two artificial wings, the one composed of a rigid rod and sail—the rod representing the stiff anterior margin of the wing; the sail, which is made of paper bordered with cardboard, the flexible posterior margin. The other wing consists of a rigid nervure in front and behind of thin parchment which supports fine rods of steel. He states that if the wing only elevates and depresses itself, “the resistance of the air is sufficient to produce all the other movements. In effect (according to Marey) the wing of an insect has not the power of equal resistance in every part. On the anterior margin the extended nervures make it rigid, while behind it is fine and flexible. During the vigorous depression of the wing, the nervure has the power of remaining rigid, whereas the flexible portion, being pushed in an upward direction on account of the resistance it experiences from the air, assumes an oblique position which causes the upper surface of the wing to look forwards.” The reverse of this, in Marey's opinion, takes place during the elevation of the wing—the resistance of the air from above causing the upper surface of the wing to look backwards. . . . “At first,” he says, “the plane of the wing is parallel with the body of the animal. It lowers itself—the front part of the wing strongly resists, the sail which follows it being flexible yields. Carried by the ribbing (the anterior margin of the wing) which lowers itself, the sail or posterior margin of the wing being raised meanwhile by the air, which sets it straight again, the sail will take an intermediate position and incline itself about 45° plus or minus according to circumstances. . . . The wing continues its movements of depression inclined to the horizon; but the impulse of the air,

which continues its effect, and naturally acts upon the surface which it strikes, has the power of resolving itself into two forces, a vertical and a horizontal force; the first suffices to raise the animal, the second to move it along."¹ Marey, it will be observed, reproduces Borelli's artificial wing, and even his text, at a distance of nearly two centuries.

The artificial wing recommended by Pettigrew is a more exact imitation of nature than either of the foregoing. It is of a more or less triangular form, thick at the root and anterior margin, and thin at the tip and posterior margin. No part of it is rigid. It is, on the contrary, highly elastic and flexible throughout. It is furnished with springs at its root to contribute to its continued play, and is applied to the air by a direct piston action in such a way that it descends in a downward and forward direction during the down stroke, and ascends in an upward and forward direction during the up stroke. It elevates and propels both when it rises and falls. It, moreover, twists and untwists during its action and describes figure-of-8 and waved tracks in space, precisely as the natural wing does. The twisting is most marked at the tip and posterior margin, particularly that half of the posterior margin next the tip. The wing when in action may be divided into two portions by a line running diagonally between the tip of the wing anteriorly and the root of the wing posteriorly. The tip and posterior parts of the wing are more active than the root and anterior parts, from the fact that the tip and posterior parts (the wing is an eccentric) always travel through greater spaces, in a given time, than the root and anterior parts.

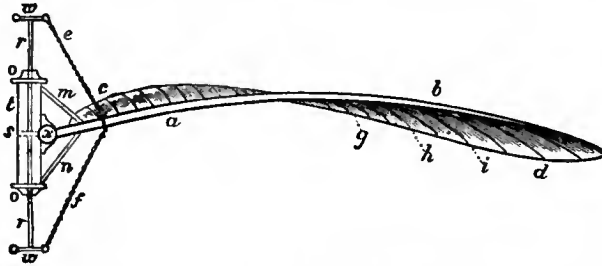

FIG. 32.—Elastic Spiral Wing, which twists and untwists during its action, to form a mobile helix or screw. This wing is made to vibrate by a direct piston action, and by a slight adjustment can be propelled vertically, horizontally or at any degree of obliquity.

- a b, Anterior margin of wing, to which the neuræ or ribs are affixed.
- c d, Posterior margin of wing crossing anterior one.
- x, Ball-and-socket joint at root of wing, the wing being attached to the side of the cylinder by the socket.
- l, Elbow joint.
- r r, Piston, with cross heads (w, w) and piston head (s).
- o o, Stuffing boxes.
- e, f, Driving chains.
- m, Superior elastic band, which assists in elevating the wing.
- n, Inferior elastic band, which antagonizes m. The alternate stretching of the superior and inferior elastic bands contributes to the continuous play of the wing, by preventing dead points at the end of the down and up strokes. The wing is free to move in a vertical and horizontal direction and at any degree of obliquity.

The wing is so constructed that the posterior margin yields freely in a downward direction during the up stroke, while it yields comparatively little in an upward direction during the down stroke; and this is a distinguishing feature, as the wing is thus made to fold and elude the air more or less completely during the up stroke, whereas it is made to expand and seize the air with avidity during the down stroke. The oblique line referred to as running diagonally across the wing virtually divides the wing into an active and a passive part, the former elevating and propelling, the latter sustaining.

It is not possible to determine with exactitude the precise function discharged by each part of the wing, but experiment tends to show that the tip of the wing elevates, the posterior margin propels, and the root sustains.

The wing—and this is important—is driven by a direct piston

¹ E. J. Marey, *Revue des cours scientifiques de la France et de l'étranger* (1869).

action with an irregular hammer-like movement, the pinion having communicated to it a smart click at the beginning of every down stroke—the up stroke being more uniform. The following is the arrangement (fig. 32). If the artificial wing here represented (fig. 32) be compared with the natural wing as depicted at fig. 33, it will be seen that there is nothing in the one which is not virtually reproduced in the other. In addition to the foregoing, Pettigrew recommended a double elastic wing to be applied to the air like a steam-hammer, by being fixed to the

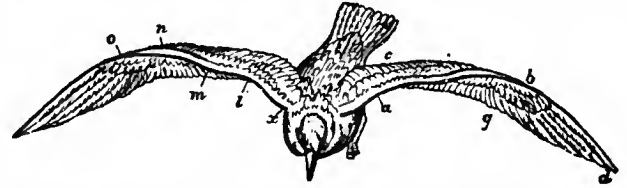

FIG. 33 shows the Spiral Elastic Wings of the Gull. Each wing forms a mobile helix or screw.

- a b, Anterior margin of left wing.
- c d, Posterior margin of ditto.
- d g, Primary or rowing feathers of left wing.
- g a, Secondary feathers ditto.
- x, Root of right wing with ball-and-socket joint.
- l, Elbow joint.
- m, Wrist joint.
- n, o, Hand and finger joints.

head of the piston. This wing, like the single wing described, twists and untwists as it rises and falls, and possesses all the characteristics of the natural wing (fig. 34).

He also recommends an elastic aerial screw consisting of two blades, which taper and become thinner towards the tips and

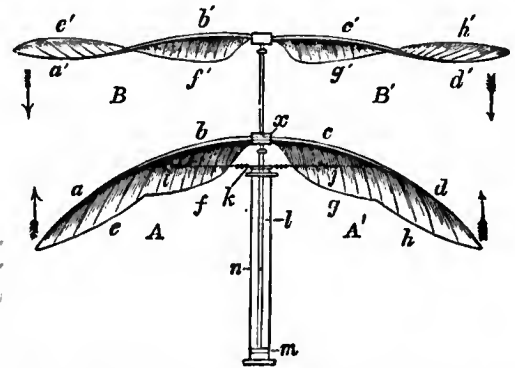

FIG. 34.—Double Elastic Wing driven by direct piston action. During the up stroke of the piston the wing is very decidedly convex on its upper surface (a b c d, A A'); its under surface (e f g h, A A') being deeply concave and inclined obliquely upwards and forwards. It thus evades, to a considerable extent, the air during the up stroke. During the down stroke of the piston the wing is flattened out in every direction, and its extremities twisted in such a manner as to form two screws, as seen at a' b' c' d', e' f' g' h', B, B'. The active area of the wing is by this arrangement considerably diminished during the up stroke, and considerably augmented during the down stroke; the wing seizing the air with greater avidity during the down than during the up stroke. i, j, k, elastic band to regulate the expansion of the wing; l, piston; m, piston head; n, cylinder.

posterior margins. When the screw is made to rotate, the blades, because of their elasticity, assume a great variety of angles, the angles being least where the speed of the blades is greatest and vice versa. The pitch of the blades is thus regulated by the speed attained (fig. 35).

The peculiarity of Pettigrew's wings and screws consists in their elasticity, their twisting action, and their great comparative length and narrowness. They offer little resistance to the air when they are at rest, and when in motion the speed with which they are driven is such as to ensure that the comparatively large spaces through which they travel shall practically be converted into solid bases of support.

After Pettigrew enunciated his views (1867) as to the screw configuration and elastic properties of natural wings, and more especially after his introduction of spiral, elastic artificial wings, and elastic screws, a great revolution took place in the construction of flying models. Elastic aeroplanes were advocated by

D. S. Brown,¹ elastic aerial screws by J. Armour,² and elastic aeroplanes, wings and screws by Alphonse Pénaud.³

Pénaud's experiments are alike interesting and instructive. He constructed models to fly by three different methods:—(a) by means of screws acting vertically upwards; (b) by aeroplanes propelled horizontally by screws; and (c) by wings which

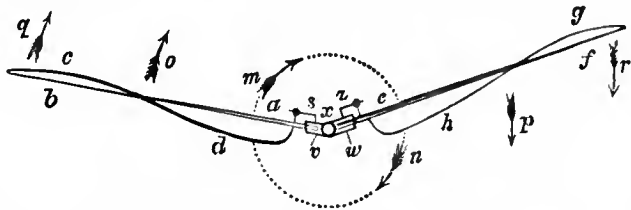

FIG. 35.—Elastic Aerial Screw with twisted blades resembling wings (a b c d, e f g h).

x, End of driving shaft.
 v, w, Sockets in which the roots of the blades of the screw rotate, the degree of rotation being limited by steel springs (z, s).
 a b, e f, tapering elastic rods forming anterior or thick margins of blades of screw.
 d c, h g, Posterior or thin elastic margins of blades of screw. The arrows m, n, o, p, q, r indicate the direction of travel.

flapped in an upward and downward direction. An account of his hélicoptère or screw model appeared in the *Aeronaut* for January 1872, but before giving a description of it, it may be well to state very briefly what is known regarding the history of the screw as applied to the air.

The first suggestion on this subject was given by A. J. P. Paucan in 1768. This author, in his treatise on the *Théorie de la vis d'Archimède*, describes a machine provided with two screws which he calls a "ptérophores." In 1796 Sir George

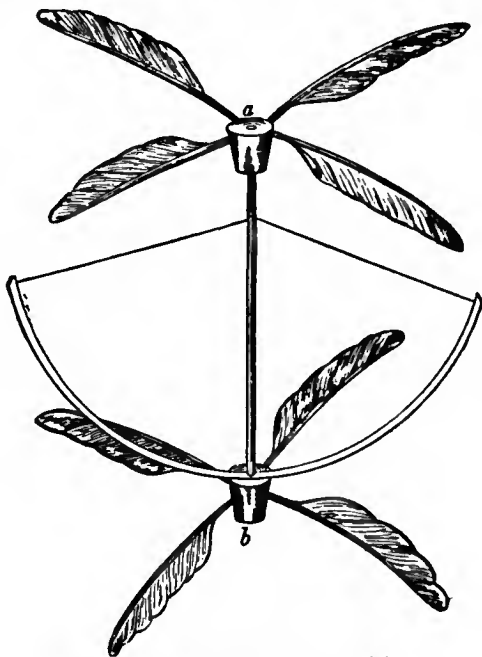

FIG. 36.—Cayley's Flying Model.

Cayley gave a practical illustration of the efficacy of the screw as applied to the air by constructing a small machine, consisting of two screws made of quill feathers, a representation of which we annex (fig. 36). Sir George writes as under:—

"As it may be an amusement to some of your readers to see a machine rise in the air by mechanical means, I will conclude my present communication by describing an instrument of this kind, which any one can construct at the expense of ten minutes' labour.

¹ "The Aero-bi-plane, or First Steps to Flight," *Ninth Annual Report of the Aeronautical Society of Great Britain*, 1874.

² "Resistance to Falling Planes on a Path of Translation," *Ninth Annual Report of the Aeronautical Society of Great Britain*, 1874.

³ The *Aeronaut* for January 1872 and February 1875.

"a and b, fig. 36, are two corks, into each of which are inserted four wing feathers from any bird, so as to be slightly inclined like the sails of a windmill, but in opposite directions in each set. A round shaft is fixed in the cork a, which ends in a sharp point. At the upper part of the cork b is fixed a whalebone bow, having a small pivot hole in its centre to receive the point of the shaft. The bow is then to be strung equally on each side to the upper portion of the shaft, and the little machine is completed. Wind up the string by turning the flyers different ways, so that the spring of the bow may unwind them with their anterior edges ascending; then place the cork with the bow attached to it upon a table, and with a finger on the upper cork press strong enough to prevent the string from unwinding, and, taking it away suddenly, the instrument will rise to the ceiling."

Cayley's screws were peculiar, inasmuch as they were superimposed and rotated in opposite directions. He estimated that if the area of the screws was increased to 200 sq. ft., and moved by a man, they would elevate him. His interesting experiment is described at length, and the apparatus figured in *Nicolson's Journal*, 1809, p. 172.

Other experimenters, such as J. Degen in 1816 and Ottoris Sarti in 1823, followed Cayley at moderate intervals, constructing flying models on the vertical screw principle. In 1842 W. H. Phillips succeeded, it is stated, in elevating a steam model by the aid of revolving fans, which according to his account flew across two fields after having attained a great altitude; and in 1859 H. Bright took out a patent for a machine to be sustained by vertical screws. In 1863 the subject of aviation by vertical screws received a fresh impulse from the experiments of Gustave de Ponton d'Amécourt, G. de la Landelle, and A. Nadar, who exhibited models driven by clock-work springs, which ascended with graduated weights a distance of from 10 to 12 ft. These models were so fragile that they usually broke in coming in contact with the ground in their descent. Their flight, moreover, was unsatisfactory, from the fact that it only lasted a few seconds.

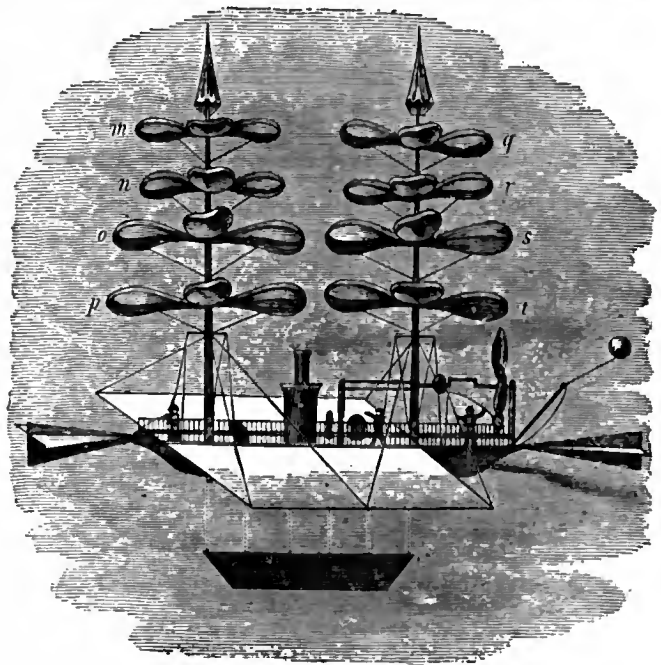

FIG. 37.—De la Landelle's Flying-machine. m, n, o, p; q, r, s, t, Screws arranged on vertical axes to act vertically upwards. The vertical axes are surmounted by two parachutes, and the body of the machine is furnished with an engine, propeller, rudders and an extensive aeroplane.

Stimulated by the success of his spring models, Ponton d'Amécourt had a small steam model constructed. This model, which was shown at the exhibition of the Aeronautical Society of Great Britain at the Crystal Palace in 1868, consisted of two superposed screws propelled by an engine, the steam for which was generated (for lightness) in an aluminium boiler. This steam model proved a failure, inasmuch as it only lifted a third of its own weight. Fig. 37 embodies de la Landelle's ideas.

All the models referred to (Cayley's excepted¹) were provided with rigid screws. In 1872 Pénaud discarded the rigid screws in favour of elastic ones, as Pettigrew had done some years before.

Pénaud also substituted india-rubber under torsion for the whalebone and clock springs of the smaller models, and the steam of the larger ones. His hélicoptère or screw-model is remarkable for its lightness, simplicity and power. The accompanying sketch will serve to illustrate its construction (fig. 38). It con-

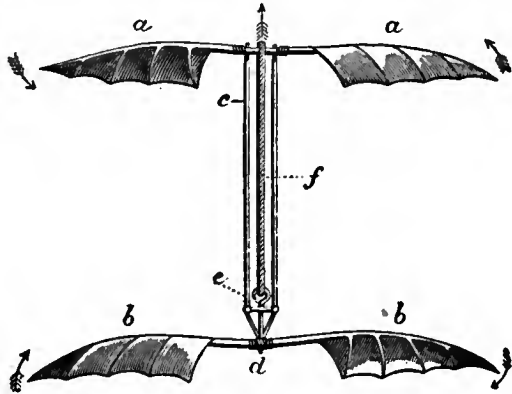

FIG. 38.—Hélicoptère or Screw-Model, by Pénaud.

sists of two superposed elastic screws (*a a, b b*), the upper of which (*a a*) is fixed in a vertical frame (*c*), which is pivoted in the central part (*d*) of the under screw. From the centre of the under screw an axle provided with a hook (*e*), which performs the part of a crank, projects in an upward direction. Between the hook or crank (*e*) and the centre of the upper screw (*a a*), the india-rubber in a state of torsion (*f*) extends. By fixing the lower screw and turning the upper one a sufficient number of times the requisite degree of torsion and power is obtained. The apparatus when liberated flies into the air sometimes to a height of 50 ft., and gyrates in large circles for a period varying from 15 to 30 seconds.

Pénaud next directed his attention to the construction of a model, to be propelled by a screw and sustained by an elastic aeroplane extending horizontally. Sir George Cayley proposed such a machine in 1810, and W. S. Henson constructed and patented a similar machine in 1842. Several inventors succeeded in making models fly by the aid of aeroplanes and screws, as, e.g. J. Stringfellow in 1847,² and F. du Temple in 1857. These models flew in a haphazard sort of a way, it being found exceedingly difficult to confer on them the necessary degree of stability fore and aft and laterally. Pénaud succeeded in overcoming the difficulty in question by the invention of what he designated an automatic rudder. This consisted of a small elastic aeroplane placed aft or behind the principal aeroplane which is also elastic. The two elastic aeroplanes extended horizontally and made a slight upward angle with the horizon, the angle made by the smaller aeroplane (the rudder) being slightly in excess of that made by the larger. The motive power was india-rubber in the condition of torsion; the propeller, a screw. The reader will understand the arrangement by a reference to the accompanying drawing (fig. 39).

Models on the aeroplane screw type may be propelled by two screws, one fore and one aft, rotating in opposite directions; and in the event of only one screw being employed it may be placed in front of or behind the aeroplane.

When such a model is wound up and let go it descends about 2 ft., after which, having acquired initial velocity, it rises and flies in a forward direction at a height of from 8 to 10 ft. from

¹ Cayley's screws, as explained, were made of feathers, and consequently elastic. As, however, no allusion is made in his writings to the superior advantages possessed by elastic over rigid screws, it is to be presumed that feathers were employed simply for convenience and lightness. Pettigrew, there is reason to believe, was the first to advocate the employment of elastic screws for aerial purposes.

² Stringfellow constructed a second model, which is described and figured further on (fig. 44).

the ground for a distance of from 120 to 130 ft. It flies this distance in from 10 to 11 seconds, its mean speed being something like 12 ft. per second. From experiments made with this model, Pénaud calculates that one horse-power would elevate and support 85 lb.

D. S. Brown also wrote (1874) in support of elastic aeroplanes. His experiments proved that two elastic aeroplanes united by a central shaft or shafts, and separated by a wide

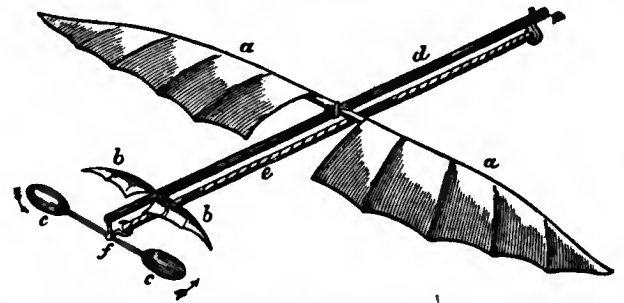

FIG. 39.—Aeroplane Model with Automatic Rudder.

- a a*, Elastic aeroplane.
- b b*, Automatic rudder.
- c c*, Aerial screw centred at *f*.
- d*, Frame supporting aeroplane, rudder and screw.
- e*, India-rubber, in a state of torsion, attached to hook or crank at *f*.

By holding the aeroplane (*a a*) and turning the screw (*c c*) the necessary power is obtained by torsion. (Pénaud.)

interval, always produce increased stability. The production of flight by the vertical flapping of wings is in some respects the most difficult, but this also has been attempted and achieved. Pénaud and A. H. de Villeneuve each constructed winged models. Marey was not so fortunate. He endeavoured to construct an artificial insect on the plan advocated by Borelli, Strauss-Dürckheim and Chabrier, but signally failed, his insect never having been able to lift more than a third of its own weight.

De Villeneuve and Pénaud constructed their winged models on different types, the former selecting the bat, the latter the bird.

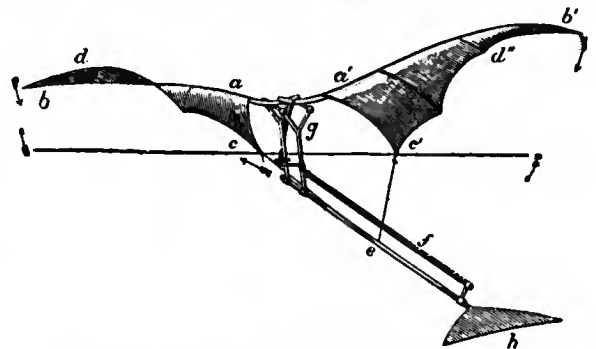

FIG. 40.—Pénaud's Artificial Flying Bird.

- a b c d, a' b' c' d'*, Elastic wings, which twist and untwist when made to vibrate.
- a b, a' b'*, Anterior margins of wings.
- c d, c' d'*, Posterior margins of wings.
- e, e'*, Inner portions of wings attached to central shaft of model by elastic bands at *e*.
- f*, India-rubber in a state of torsion, which provides the motive power, by causing the crank situated between the vertical wing supports (*g*) to rotate; as the crank revolves the wings are made to vibrate by means of two rods which extend between the crank and the roots of the wings.
- h*, Tail of artificial bird.

De Villeneuve made the wings of his artificial bat conical in shape and comparatively rigid. He controlled the movements of the wings, and made them strike downwards and forwards in imitation of natural wings. His model possessed great power of rising. It elevated itself from the ground with ease, and flew in a horizontal direction for a distance of 24 ft., and at a velocity of 20 m. an hour. Pénaud's model differed from de Villeneuve's in being provided with elastic wings, the posterior margins of which in addition to being elastic were free to move round the

anterior margins as round axes (see fig. 24). India-rubber springs were made to extend between the inner posterior parts of the wings and the frame, corresponding to the backbone of the bird.

A vertical movement having been communicated by means of india-rubber in a state of torsion to the roots of the wings, the wings themselves, in virtue of their elasticity, and because of the resistance experienced from the air, twisted and untwisted and formed reciprocating screws, precisely analogous to those originally described and figured by Pettigrew in 1867. Pénaud's arrangement is shown in fig. 40.

If the left wing of Pénaud's model (*a b, c d* of fig. 40) be compared with the wing of the bat (fig. 18), or with Pettigrew's artificial wing (fig. 32), the identity of principle and application is at once apparent.

In Pénaud's artificial bird the equilibrium is secured by the addition of a tail. The model cannot raise itself from the ground, but on being liberated from the hand it descends 2 ft. or so, when, having acquired initial velocity, it flies horizontally for a distance of 50 or more feet, and rises as it flies from 7 to 9 ft. The following are the measurements of the model in question:—length of wing from tip to tip, 32 in.; weight of wing, tail, frame, india-rubber, &c., 73 grammes (about 2½ ounces). (J. B. P.)

Flying Machines.—Henson's flying machine, designed in 1843, was the earliest attempt at aviation on a great scale. Henson was one of the first to combine aerial screws with extensive supporting structures occupying a nearly horizontal position. The accompanying illustration explains the combination (fig. 41).

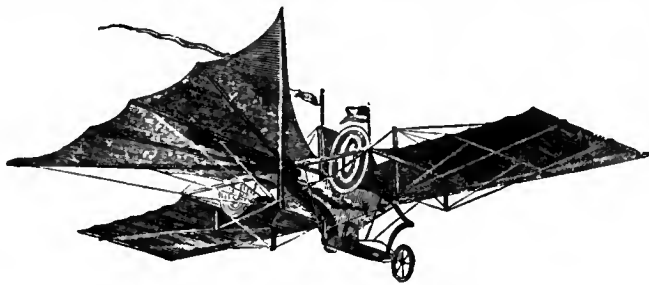

FIG. 41.—Henson's Aerostat.

"The chief feature of the invention was the very great expanse of its sustaining planes, which were larger in proportion to the weight it had to carry than those of many birds. The machine advanced with its front edge a little raised, the effect of which was to present its under surface to the air over which it passed, the resistance of which, acting upon it like a strong wind on the sails of a windmill, prevented the descent of the machine and its burden. The sustaining of the whole, therefore, depended upon the speed at which it travelled through the air, and the angle at which its under surface impinged on the air in its front. . . . The machine, fully prepared for flight, was started from the top of an inclined plane, in descending which it attained a velocity necessary to sustain it in its further progress. That velocity would be gradually destroyed by the resistance of the air to the forward flight; it was, therefore, the office of the steam-engine and the vanes it actuated simply to repair the loss of velocity; it was made, therefore, only of the power and weight necessary for that small effect." The editor of *Newton's Journal of Arts and Sciences* speaks of it thus:—"The apparatus consists of a car containing the goods, passengers, engines, fuel, &c., to which a rectangular frame, made of wood or bamboo cane, and covered with canvas or oiled silk, is attached. This frame extends on either side of the car in a similar manner to the outstretched wings of a bird; but with this difference, that the frame is immovable. Behind the wings are two vertical fan wheels, furnished with oblique vanes, which are intended to propel the apparatus through the air. The rainbow-like circular wheels are the propellers, answering to the wheels of a steam-boat, and acting upon the air after the manner of a windmill. These wheels receive motions from bands and pulleys from a steam or other engine contained in the car. To an axis at the stern of the car a triangular frame is attached, resembling the tail of a bird, which is also covered with canvas or oiled silk. This may be expanded or contracted at pleasure, and is moved up and down for the purpose of causing the machine to ascend or descend. Beneath the tail is a rudder for directing the course of the machine to the right or to the left; and to facilitate the steering a sail is stretched between two masts which rise from the car. The amount of canvas or oiled silk necessary for buoying up the machine is stated to be equal to one square foot for each half pound of weight."

F. H. Wenham, thinking to improve upon Henson, invented in 1866 what he designated his aeroplanes.¹ These were thin, light, long, narrow structures, arranged above each other in tiers like so many shelves. They were tied together at a slight upward angle, and combined strength and lightness. The idea was to obtain great sustaining area in comparatively small space with comparative ease of control. It was hoped that when the aeroplanes were wedged forward in the air by vertical screws, or by the body to be flown, each aeroplane would rest or float upon a stratum of undisturbed air, and that practically the aeroplanes would give the same support as if spread out horizontally. The accompanying figures illustrate Wenham's views (figs. 42 and 43).

Stringfellow, who was originally associated with Henson, and built a successful flying model in 1847, made a second model

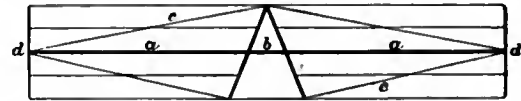

FIG. 42.—Wenham's system of Acroplanes designed to carry a man.
a, a, Thin planks, tapering at each end, and attached to a triangle.
b, Similar plank for supporting the aeronaut.
c, c, Thin bands of iron with truss planks *a, a,* and
d, d, Vertical rods. Between these are stretched five bands of holland 15 in. broad and 16 ft. long, the total length of the web being 80 ft. This apparatus, when caught by a gust of wind, actually lifted the aeronaut.

in 1868, in which Wenham's aeroplanes were combined with aerial screws. This model was on view at the exhibition of the Aeronautical Society of Great Britain, held at the Crystal Palace,



FIG. 43.—A similar system, planned by Wenham.
a, a, Main spar 16 ft. long;
b, b, Panels, with base board for aeronaut attached to main spar.
e, e, Thin tie-band of steel with struts starting from main spar. This forms a strong light framework for the aeroplanes, consisting of six webs of thin holland 15 in. broad. The aeroplanes are kept in parallel plane by vertical divisions of holland 2 ft. wide.
c, c', Wing propellers driven by the feet.

London, in 1868. It was remarkably compact, elegant and light, and obtained the £100 prize of the exhibition for its engine, which was the lightest and most powerful so far constructed. The illustration below (fig. 44), drawn from a photograph, gives a

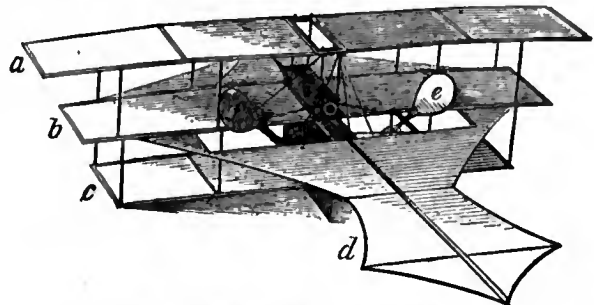

FIG. 44.—Stringfellow's Flying Machine.

very good idea of the arrangement—*a, b, c* representing the superimposed aeroplanes, *d* the tail, *e, f* the screw propellers. The superimposed aeroplanes (*a, b, c*) in this machine contained a sustaining area of 28 sq. ft., in addition to the tail (*d*). Its engine represented a third of a horse power, and the weight of the whole (engine, boiler, water, fuel, superimposed aeroplanes and

¹"On Aerial Locomotion," *Aeronautical Society's Report* for 1867.

propellers) was under 12 lb. Its sustaining area, if that of the tail (*d*) be included, was something like 36 sq. ft., *i.e.* 3 sq. ft. for every pound. The model was forced by its propellers along a wire at a great speed, but so far as an observer could determine, failed to lift itself, notwithstanding its extreme lightness and the comparatively very great power employed. Stringfellow, however, stated that it occasionally left the wire and was sustained by its aeroplanes alone.

The aerial steamer of Thomas Moy (fig. 45), designed in 1874, consisted of a light, powerful, skeleton frame resting on three wheels; a very effective light engine constructed on a new principle, which dispensed with the old-fashioned, cumbrous boiler; two long, narrow, horizontal aeroplanes; and two comparatively very large aerial screws. The idea was to get up the initial velocity by a preliminary run on the ground. This accomplished it was hoped that the weight of the machine would gradually be thrown upon the aeroplanes in the same way that the weight of certain birds—the eagle, *e.g.*—is thrown upon

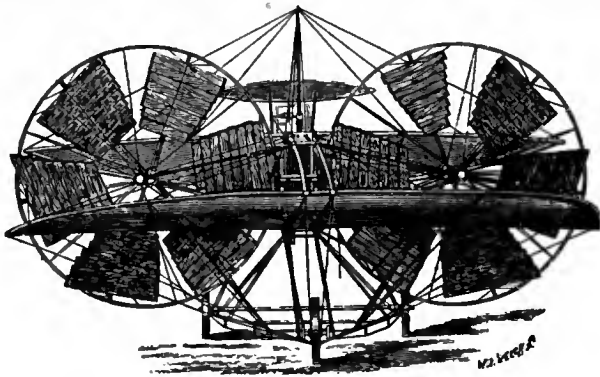

FIG. 45.—Moy's Aerial Steamer.

the wings after a few hops and leaps. Once in the air the aeroplanes, it was believed, would become effective in proportion to the speed attained. The machine, however, did not realize the high expectations formed of it, and like all its predecessors it was doomed to failure.

Two of the most famous of the next attempts to solve the problem of artificial flight, by means of aeroplanes, were those of Prof. S. P. Langley and Sir Hiram S. Maxim, who began their aerial experiments about the same time (1889–1890). By 1893–1894 both had embodied their views in models and large flying machines.

Langley, who occupied the position of secretary to the Smithsonian Institution, Washington, U.S.A., made many small flying models and one large one. These he designated "aerodromes." They were all constructed on a common principle, and were provided with extensive flying surfaces in the shape of rigid aeroplanes inclined at an upward angle to the horizon, and more or less fixed on the plan advocated by Henson. The cardinal idea was to force the aeroplanes (slightly elevated at their anterior margins) forwards, kite-fashion, by means of powerful vertical screw propellers driven at high speed—the greater the horizontal speed provided by the propellers, the greater, by implication, the lifting capacity of the aerodrome. The bodies, frames and aeroplanes of the aerodromes were strengthened by vertical and other supports, to which were attached aluminium wires to ensure absolute rigidity so far as that was possible. Langley aimed at great lightness of construction, and in this he succeeded to a remarkable extent. His aeroplanes were variously shaped, and were, as a rule, concavo-convex, the convex surface being directed upwards. He employed a competent staff of highly trained mechanics at the Smithsonian Institution, and great secrecy was observed as to his operations. He flew his smallest models in the great lecture room of the National Museum, and his larger ones on the Potomac river about 40 m. below Washington.

While Langley conducted his preliminary experiments in 1889, he did not construct and test his steam-driven flying

models until 1893. These were made largely of steel and aluminium, and one of them in 1896 made the longest flight then recorded for a flying machine, namely, fully half a mile on the Potomac river. The largest aerodrome, intended to carry passengers and to be available for war purposes, was built to the order and at the expense of the American government, which granted a sum of fifty thousand dollars for its construction.

Langley's machine shown in fig. 46 was a working model, not intended to carry passengers. In configuration the body-portion

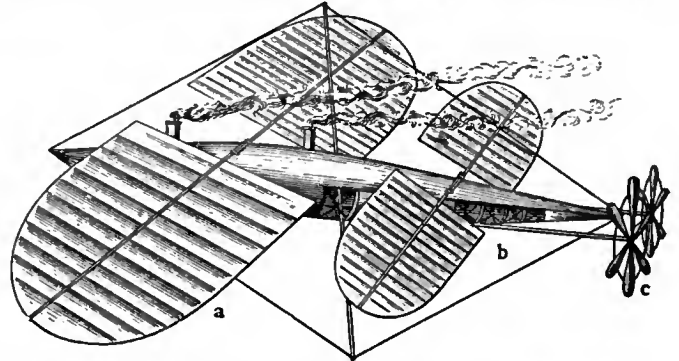

FIG. 46.—Langley's Flying Machine. *a*, Large aeroplane; *b*, Small aeroplane; *c*, Propelling screws.

closely resembled a mackerel. The backbone was a light but very rigid tube of aluminium steel, 15 ft. in length, and a little more than 2 in. in diameter. The engines were located in the portion of the framework corresponding to the head of the fish; they weighed 60 oz. and developed one horse-power. There were four boilers made of thin hammered copper and weighing a little more than 7 lb each; these occupied the middle portion of the fish. The fuel used was refined gasoline, and the extreme end of the tail of the fish was utilized for a storage tank with a capacity of one quart. There were twin screw propellers, which could be adjusted to different angles in practice, to provide for steering, and made 1700 revolutions a minute. The wings, or aeroplanes, four in number, consisted of light frames of tubular aluminium steel covered with china silk. The pair in front were 42 in. wide and 40 ft. from tip to tip. They could be adjusted at different angles. The machine required to be dropped from a height, or a preliminary forward impetus had to be given to it, before it could be started. Fixity of all the parts was secured by a tubular mast extending upwards and downwards through about the middle of the craft, and from its extremities ran stays of aluminium wire to the tips of the aeroplanes and the end of the tubular backbone. By this trussing arrangement the whole structure was rendered exceedingly stiff.

In the larger aerodrome (fig. 47) the aeroplanes were concavo-convex, narrow, greatly elongated and square at their free extremities,

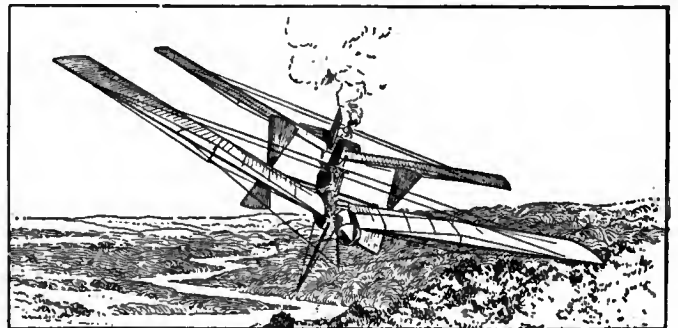

FIG. 47.—Langley's Aerodrome in flight.

the two propellers, which were comparatively very large, being placed amidships, so to speak. At the first trial of this machine, on the 7th of October 1903, just as it left the launching track it was jerked violently down at the front (being caught, as subsequently appeared, by the falling ways), and under the full power of its engine was pulled into the water, carrying with it its engineer. When the aerodrome rose to the surface, it was found that while the front sustaining surfaces had been broken by their impact with the water, yet the rear ones were comparatively uninjured. At the second and last attempt, on the 8th of December 1903, another disaster, again due to the launching ways, occurred as the machine was leaving the track. This time the back part of the machine, in some way still unexplained, was caught by a portion of the launching car, which caused the rear sustaining surface to break, leaving the rear entirely without support,

and it came down almost vertically into the water. Darkness had come before the engineer, who had been in extreme danger, could aid in the recovery of the aerodrome. The boat and machine had drifted apart, and one of the tugs in its zeal to render assistance had fastened a rope to the frame of the machine in the reverse position from what it should have been attached, and had broken the frame entirely in two. Owing to lack of funds further trials were abandoned (see *Annual Report of the Smithsonian Institution, 1904, p. 122*).

Sir Hiram S. Maxim, like Langley, employed a staff of highly skilled workmen. His machine (fig. 48) consisted of a platform, on which stood a large water-tube boiler, a number of concavo-convex aeroplanes arranged in tiers like shelves, each making a slight upward angle with the horizon, two very large vertical screws placed aft and propelled by steam engines, tanks for the storage of water, naphtha, &c. The boiler was especially noteworthy. The water was contained in about 2000 bent copper tubes, only $\frac{3}{8}$ in. in external diameter, heated by over 7000 gas jets arranged in rows. The fuel was naphtha or gasoline. Steam could be got up in the short space of half a minute. The steam-generating appliances, which weighed only 1000 lb in all, were placed in the front of the machine. The motive power was

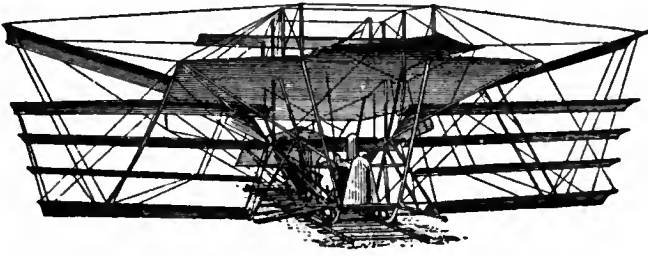

FIG. 48.—Sir H. Maxim's Flying Machine.

provided by a pair of two-cylinder, compound engines, poised about 8 ft. from the ground, and about 6 ft. apart. Each of them was independently governed, and furnished together 363 horse-power in actual effect, an amount which, considering that their total weight was only 600 lb, gave the extraordinary efficiency of over 1 horse-power for every 2 lb weight. The high and the low pressure cylinders were 5 and 8 in. in diameter respectively, and the stroke was 12 in. When going at full speed these engines conferred 425 revolutions per minute on the two gigantic propellers that drove the machine along. These were in appearance like two-bladed marine propellers except that they were square instead of rounded at the ends, and were broad and thin. They were built from overlapping strips of American pine, planed smooth and covered with glued canvas. They weighed 135 lb each, the length of each blade being close upon 9 ft. and the width at the ends 5½ ft. The pitch was 16 ft. They were carefully stayed by steel wires to their shafts, or the first revolution would have snapped them off short. The material of which the framework was built was thin steel tubing, exceedingly light. All the wires and ties were of the best steel, capable of standing a strain of 100 tons to the square inch. The body of the machine was oblong in shape, with the fore-part cut away like a water-chute boat, and a long counter at the stern over which the propellers revolved. It had canvas stretched all over it. High overhead, like a gigantic awning, was the slightly concavo-convex main aeroplane, tilted towards the front at an imperceptible angle, and stretched taut. Its area was 1400 sq. ft., increased by side wings to 2700 sq. ft. There were also side aeroplanes arranged in tiers, and large aeroplanes in front, which were pivoted and served for vertical steering. The machine was strengthened in every direction by vertical and other supports and securely wired together at all points. It was furnished with four strong flanged wheels and ran along a light broad-gauge (9 ft.) railway track, 1800 ft. long, in the hope that when the speed reached a certain point it would leave the rails, but it was prevented from rising more than an inch or so by four arms, or outriggers, furnished with wheels, which projected from its sides and ran under an inverted wooden upper or safety track outside the railway track proper.

At a trial carried out in 1894 at Bexley, Kent, only the main aeroplane, the fore and aft rudders, and the top and bottom side planes were in position. After everything had been got in readiness, careful observers were stationed along the track, and the machine was connected to a dynamometer. The engines were then started and the pump set so as to deliver over 5000 lb of water per hour into the boiler. The gas was then carefully turned on until the pressure amounted to 310 lb per sq. in., and the dynamometer showed a thrust of more than 2100 lb. A small safety-valve placed in the steam pipe had been adjusted so as to blow off slightly at 310 lb and with a strong blast at 320 lb. The signal being given to let go, the machine darted forward at a terrific pace, and the safety-valve ceased to blow. More gas was instantly turned on, and before the machine had advanced 300 ft., the steam had mounted to 320 lb per sq. in., and the safety-valve was blowing off a steady blast. When the machine had travelled only a few hundred feet, all four of the small outrigger wheels were fully engaged, which showed that the machine was lifting at least 8000 lb. The speed rapidly increased until when the

machine had run about 900 ft. one of the rear axletrees, which were of 2 in. steel tubing, doubled up and set the rear end of the machine completely free. When the machine had travelled about 1000 ft., the left-hand forward wheel became disengaged from the safety track, and shortly after this the right-hand wheel broke the upper track—3 in. by 9 in. Georgia pine—and a plank became entangled in the framework of the machine. Steam had already been shut off, and the machine coming to rest fell directly to the ground, all four of its wheels sinking deeply into the turf without leaving other marks. Before making this run the wheels which were to engage the upper track were painted, and the paint left by them on the upper track indicated the exact point where the machine lifted. The area of the aeroplanes was very nearly 4000 sq. ft. and the total lifting effect was fully 10,000 lb. The planes therefore lifted 2.5 lb per sq. ft., and 5 lb for each pound thrust. Nearly half of the power of the engines was lost in the screw slip. This showed that the diameter of the screws was not great enough; it should have been at least 22 ft.

In 1897 M. C. Ader, who had already tested, with indifferent results, two full-sized flying machines, built a third apparatus with funds furnished by the French government. This reproduced the structure of a bird with almost servile imitation, save that traction was obtained by two screw-propellers. The steam engine weighed about 7 lb per horse-power, but the equilibrium of the apparatus was defective.

Largely with the view of studying the problem of maintaining equilibrium, several experimenters, including Otto Lilienthal, Percy Pilcher and Octave Chanute, cultivated gliding flight by means of aeroplanes capable of sustaining a man. They depended mainly on the utilization of natural air currents, trusting for stability and balance to movements in their own bodies, or in portions of their machines which they could control. They threw themselves from natural or artificial elevations, or, facing the wind, they ran or were dragged forwards against it until they got under way and the wind caught hold of their aeroplanes. To Lilienthal in Germany belongs the double credit of demonstrating the superiority of arched over flat surfaces, and of reducing gliding flight to regular practice. He made over 2000 glides safely, using gravity as his motive power, with concave, batlike wings, in some cases with superposed surfaces (fig. 49).

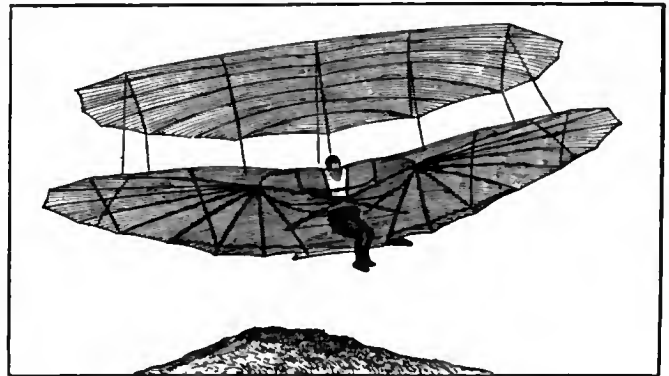

FIG. 49.—Lilienthal's Gliding Machine.

It was with a machine of the latter type that he was upset by a sudden gust of wind and killed in 1896. Pilcher in England improved somewhat on Lilienthal's apparatus, but used the same general method of restoring the balance, when endangered, by shifting the weight of the operator's body. He too made several hundred glides in safety, but finally was thrown over by a gust of wind and killed in 1899. Chanute in America confined his endeavours to the production of automatic stability, and made the surfaces movable instead of the man. He used several different forms of apparatus, including one with five superposed pairs of wings and a tail (fig. 50) and another with two continuous aeroplanes, one above the other (fig. 51). He made over 1000 glides without accident.

Similar experiments were meanwhile conducted by Wilbur and Orville Wright of Dayton, Ohio, in whose hands the glider developed into a successful flying machine. These investigators began their work in 1900, and at an early stage introduced two characteristic features—a horizontal rudder in front for steering in the vertical plane, and the flexing or bending of the ends of

the main supporting aeroplanes as a means of maintaining the structure in proper balance. Their machines to begin with were merely gliders, the operator lying upon them in a horizontal position, but in 1903 a petrol motor was added, and a flight lasting 59 seconds was performed. In 1905 they made forty-five flights, in the longest of which they remained in the air for half

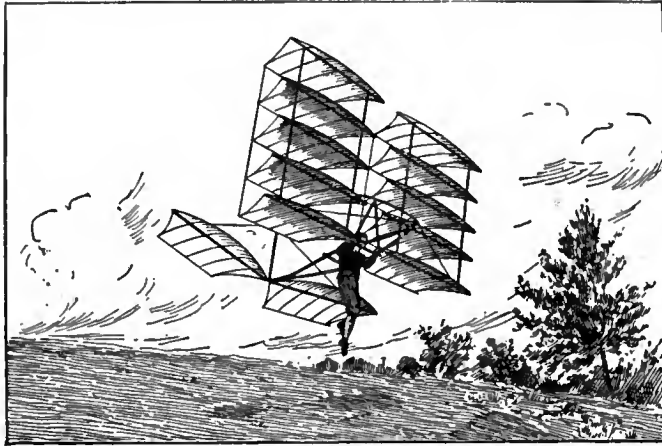

FIG. 50.—Chanute's Multiple Gliding Machine.

an hour and covered a distance of $24\frac{1}{2}$ m. The utmost secrecy, however, was maintained concerning their experiments, and in consequence their achievements were regarded at the time with doubt and suspicion, and it was hardly realized that their success would reach the point later achieved.

Thanks, however, to the efforts of automobile engineers, great improvements were now being effected in the petrol engine, and, although the certainty and trustworthiness of its action still left something to be desired, it provided the designers of flying machines with what they had long been looking for—a motor

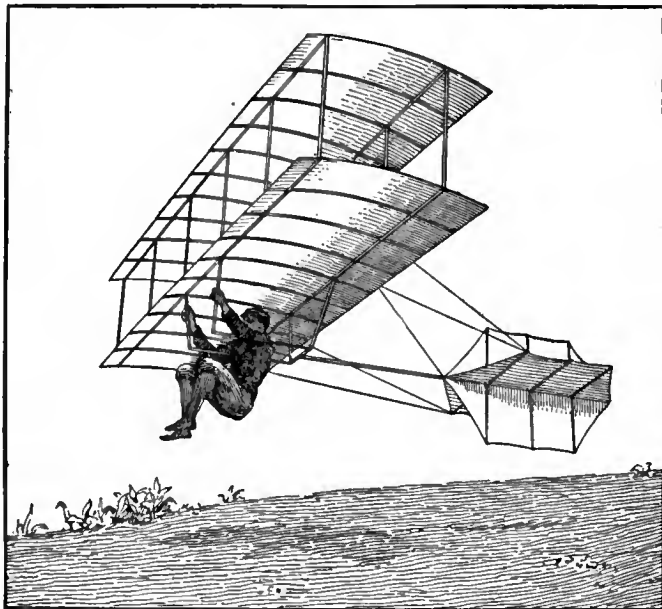

FIG. 51.—Chanute's Biplane Gliding Machine.

very powerful in proportion to its weight. Largely in consequence of this progress, and partly no doubt owing to the stimulus given by the activity of builders of dirigible balloons, the construction of motor-driven aeroplanes began to attract a number of workers, especially in France. In 1906 A. Santos Dumont, after a number of successful experiments with dirigible cigar-shaped gas balloons, completed an aeroplane flying machine. It consisted of the following parts:—(a) A system of aeroplanes arranged like the capital letter T at a certain upward angle to the horizon and bearing a general resemblance to box kites;

(b) a pair of very light propellers driven at a high speed; and (c) an exceedingly light and powerful petrol engine. The driver occupied a position in the centre of the arrangement, which is shown in fig. 52. The machine was furnished with two wheels and vertical supports which depended from the anterior parts of the aeroplanes and supported it when it touched the ground

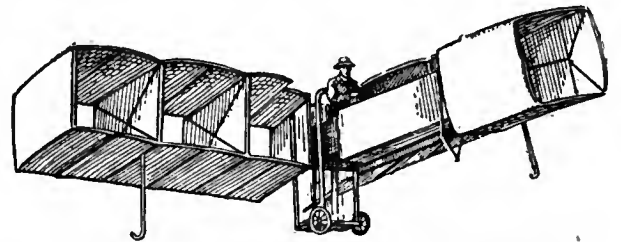

FIG. 52.—Santos Dumont's Flying Machine.

on either side. With this apparatus he traversed on the 12th of November 1906 a distance of 220 metres in 21 seconds.

About a year later Henry Farman made several short flights on a machine of the biplane type, consisting of two main supporting surfaces one above the other, with a box-shaped vertical rudder behind and two small balancing aeroplanes in front. The engine was an eight-cylinder Antoinette petrol motor, developing 49 horse-power at 1100 revolutions a minute, and driving directly a single metal screw propeller. On the 27th of October 1906 he flew a distance of nearly half a mile at Issy-les-Molineaux, and on the 13th of January 1908 he made a circular flight of one kilometre, thereby winning the Deutsch-Archdeacon prize of £2000. In March he remained in the air for $3\frac{1}{2}$ minutes, covering a distance of $1\frac{1}{4}$ m.; but in the following month a rival, Leon Delagrangé, using a machine of the same type and constructed by the same makers, Messrs Voisin, surpassed this performance by flying nearly $2\frac{1}{2}$ m. in $6\frac{1}{2}$ minutes. In July Farman remained in the air for over 20 minutes; on the 6th of September Delagrangé increased the time to nearly 30 minutes, and on the 29th of the same month Farman again came in front with a flight lasting 42 minutes and extending over nearly $24\frac{1}{2}$ m.

But the best results were obtained by the Wright brothers—Orville Wright in America and Wilbur Wright in France. On the 9th of September 1908 the former, at Fort Myer, Virginia, made three notable flights; in the first he remained in the air $57\frac{1}{2}$ minutes and in the second 1 hour 3 minutes, while in the third he took with him a passenger and covered nearly 4 m. in 6 minutes. Three days later he made a flight of 45 m. in 1 hour $14\frac{1}{2}$ minutes, but on the 17th he had an accident, explained as being due to one of his propellers coming into contact with a stay, by which his machine was wrecked, he himself seriously injured, and Lieutenant Selfridge, who was with him, killed. Four days afterwards Wilbur Wright at Le Mans in France beat all previous records with a flight lasting 1 hour 31 minutes $25\frac{1}{4}$ seconds, in which he covered about 56 m.; and subsequently, on the 11th of October, he made a flight of 1 hour 9 minutes accompanied by a passenger. On the 31st of December he succeeded in remaining in the air for 2 hours 20 minutes 23 seconds.

Wilbur Wright's machine (fig. 53), that used by his brother being essentially the same, consisted of two slightly arched supporting surfaces, each $12\frac{1}{2}$ metres long, arranged parallel one above the other at a distance of $1\frac{1}{2}$ metres apart. As they were each about 2 metres wide their total area was about 50 sq. metres. About 3 metres in front of them was arranged a pair of smaller horizontal aeroplanes, shaped like a long narrow ellipse, which formed the rudder that effected changes of elevation, the driver being able by means of a lever to incline them up or down according as he desired to ascend or descend. The rudder for lateral steering was placed about $2\frac{1}{2}$ metres behind the main surfaces and was formed of two vertical pivoted aeroplanes. The lever by which they were turned was connected with the device by which the ends of the main aeroplanes could be flexed simultaneously though in opposite directions; *i.e.* if the ends of the aeroplanes on one side were bent downwards, those on the

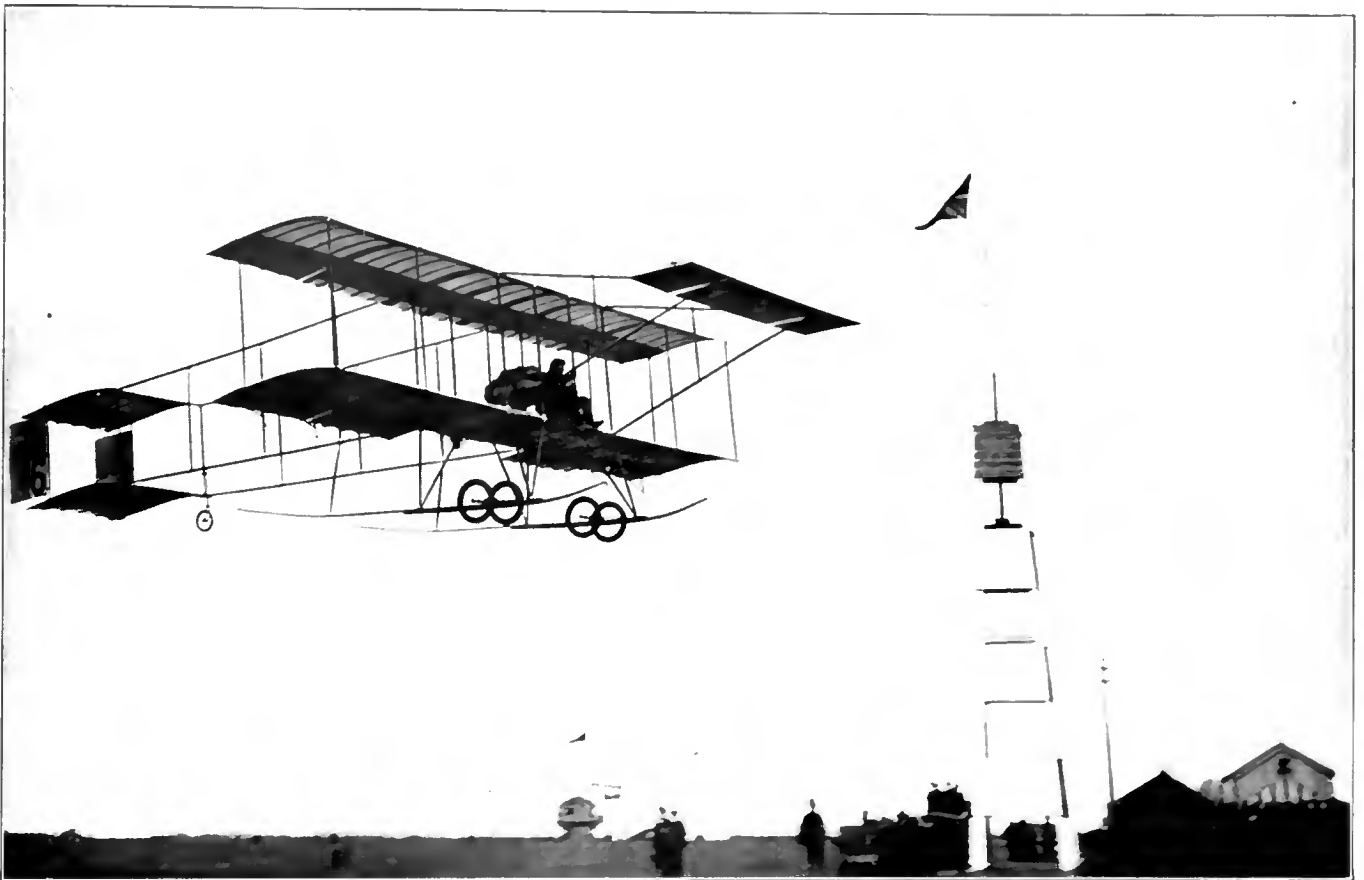

FIG. 1.—PAULHAN FLYING ON FARMAN BIPLANE.

Photo, Topical Press.

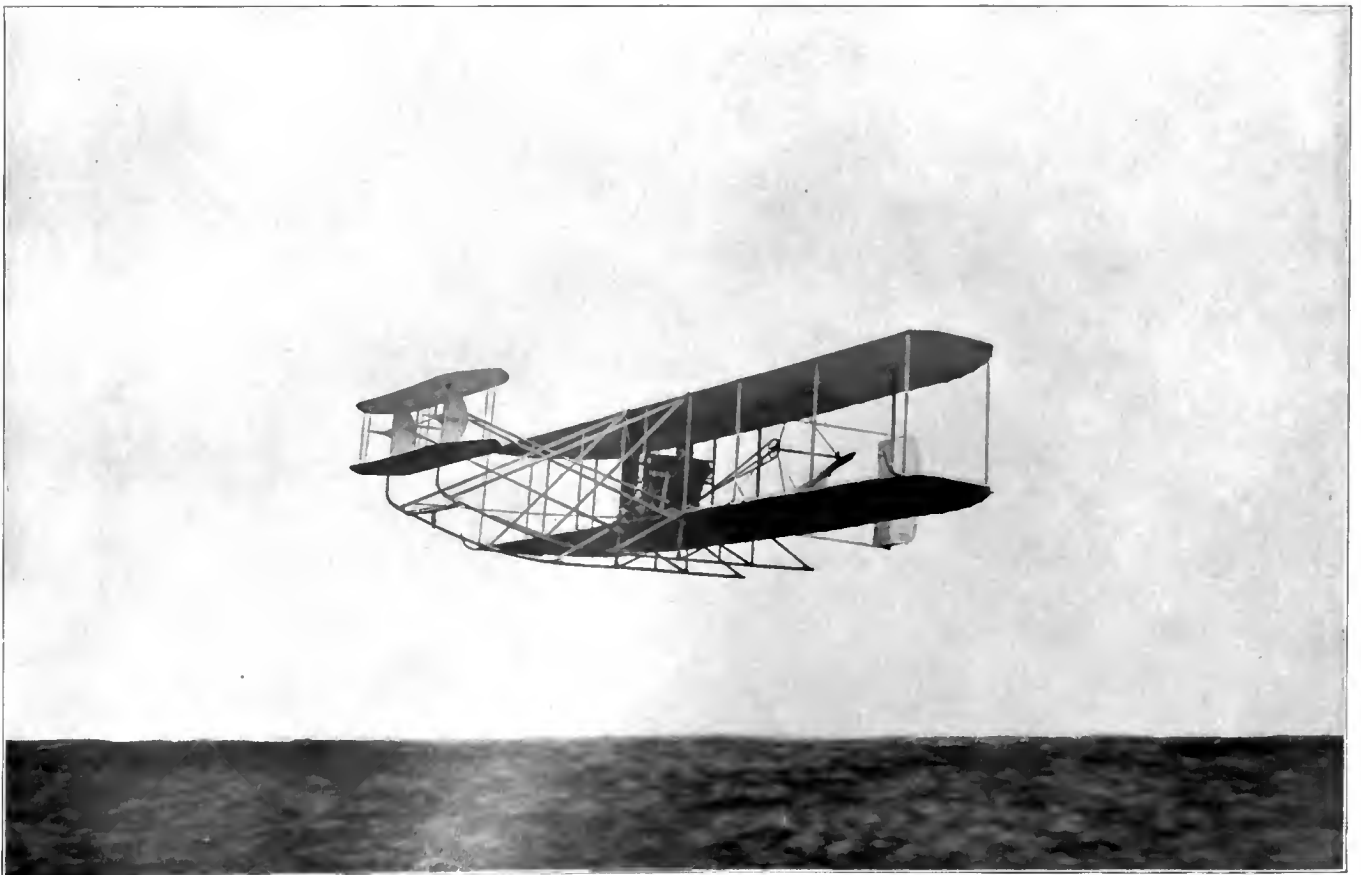

FIG. 2.—WRIGHT BIPLANE.

Photo, Topical Press.

FLIGHT AND FLYING



FIG. 3.—BLÉRIOT MONOPLANE.

Photo, Topical Press.



FIG. 4.—A. V. ROE'S TRIPLANE.

Photo, Topical Press.

other were bent upwards. By the aid of this arrangement the natural cant of the machine when making a turn could be checked, if it became excessive. The four-cylinder petrol engine was placed on the lower aeroplane a little to the right of the central line, being counterbalanced by the driver (and passenger

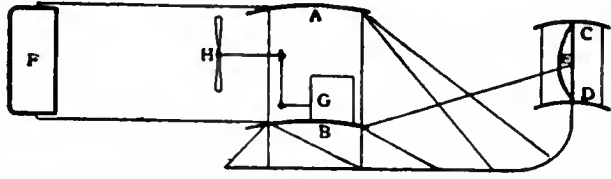

FIG. 53.—Wright Flying Machine; diagrammatic sketch.
 A, B, Main supporting surfaces. F, Vertical rudder.
 C, D, Aeroplanes of horizontal rudder with fixed semilunar fin E. G, Motor.
 H, Screws.

if one was carried), who sat a little to the left of the same line. Making about 1200 revolutions a minute, it developed about 24 horse-power, and was connected by chain gearing to two wooden propellers, 2½ metres in diameter and 3½ metres apart, the speed of which was about 450 revolutions a minute. The whole machine, with aeronaut, weighed about 1100 lb, the weight of the motor being reputed to be 200 lb.

A feature of the year 1909 was the success obtained with monoplanes having only a single supporting surface, and it was on a machine of this type that the Frenchman Blériot on July 25th flew across the English Channel from Calais to Dover in 31 minutes. Hubert Latham all but performed the same feat on an Antoinette monoplane. The year saw considerable increases in the periods for which aviators were able to remain in the air, and Roger Sommer's flight of nearly 2½ hours on August 7th was surpassed by Henry Farman on November 3rd, when he covered a distance estimated at 137¼ m. in 4 hr. 17 min. 53 sec. In both these cases biplanes were employed. Successful aviation meetings were held, among other places, at Reims, Juvisy, Doncaster and Blackpool; and at Blackpool a daring flight was made in a wind of 40 m. an hour by Latham. This aviator also proved the possibility of flying at considerable altitudes by attaining on December 1st a height of over 1500 ft., but this record was far surpassed in the following January by L. Paulhan, who on a biplane rose to a height of 1383 yds. at Los Angeles. In the course of the year three aviators were killed—Lefèvre and Ferber in September and Fernandez in December; and four men perished in September by the destruction of the French airship "République," the gas-bag of which was ripped open by a broken propeller. In January 1910 Delagrangé was killed by the fracture of one of the wings of a monoplane on which he was flying. On April 27th-28th, 1910, Paulhan successfully flew from London to Manchester, with only one stop, within 24 hours, for the *Daily Mail's* £10,000 prize.

The progress made by all these experiments at aviation had naturally created widespread interest, both as a matter of

sport and also as indicating a new departure in the possibilities of machines of war. And in 1909 the British government appointed a scientific committee, with Lord Rayleigh as chairman, as a consultative body for furthering the development of the science in England.

The table below gives some details, approximately correct, of the principal experiments made with flying machines up to 1908.

REFERENCES.—Some of the books mentioned under AERONAUTICS contain details of flying machines; see H. W. L. Moedebeck, *A Pocket-book of Aeronautics*, trans. by W. Mansergh Varley (London, 1907); Sir Hiram S. Maxim, *Artificial and Natural Flight* (London, 1908); F. W. Lanchester, *Aerodynamics and Aerodromics* (London, 1907 and 1908); C. C. Turner, *Aerial Navigation of To-day* (London, 1909); also two papers on "Aerial Navigation" read by Colonel G. O. Fullerton before the Royal United Service Institution in 1892 and 1906; papers read by Major B. F. S. Baden-Powell and E. S. Bruce before the Society of Arts, London, in April 1907 and December 1908 respectively; Cantor Lectures by F. W. Lanchester (Society of Arts, 1909); and the *Proceedings of the Aeronautical Society* (founded 1865), &c.

FLINCK, GOVERT (1615-1660), Dutch painter, born at Cleves in 1615, was apprenticed by his father to a silk mercer, but having secretly acquired a passion for drawing, was sent to Leuwarden, where he boarded in the house of Lambert Jacobszon, a Mennonite, better known as an itinerant preacher than as a painter. Here Flinck was joined by Jacob Backer, and the companionship of a youth determined like himself to be an artist only confirmed his passion for painting. Amongst the neighbours of Jacobszon at Leuwarden were the sons and relations of Rombert Ulenburg, whose daughter Saske married Rembrandt in 1634. Other members of the same family lived at Amsterdam, cultivating the arts either professionally or as amateurs. The pupils of Lambert probably gained some knowledge of Rembrandt by intercourse with the Ulenburgs. Certainly J. von Sandrart, who visited Holland in 1637, found Flinck acknowledged as one of Rembrandt's best pupils, and living habitually in the house of the dealer Hendrik Ulenburg at Amsterdam. For many years Flinck laboured on the lines of Rembrandt, following that master's style in all the works which he executed between 1636 and 1648; then he fell into peculiar mannerisms by imitating the swelling forms and grand action of Rubens's creations. Finally he sailed with unfortunate complacency into the Dead Sea of official and diplomatic painting. Flinck's relations with Cleves became in time very important. He was introduced to the court of the Great Elector, Frederick William of Brandenburg, who married in 1646 Louisa of Orange. He obtained the patronage of John Maurice of Orange, who was made stadtholder of Cleves in 1649. In 1652 a citizen of Amsterdam, Flinck married in 1656 an heiress, daughter of Ver Hoeven, a director of the Dutch East India Company. He was already well known even then in the patrician circles over which the burgomasters De Graef and the Echevin Six presided; he was on terms of intimacy with the poet Vondel and the treasurer Uitenbogaard. In his house, adorned with antique casts, costumes, and a noble collection of prints, he often

Year.	Experimenter.	Tip to Tip.	Surface.	Weight.	Pounds per sq. ft.	Speed per hour.	Maximum Flight.	Motor.	Horse-power.	Pounds sustained per h.p.
1879	Tatin	Ft. 6·2	Sq. ft. 7·5	lb. 3·85	0·51	18	100?	Compressed air	0·03	110?
1885 } 1889 }	Hargrave (No. 16)	5·5	26·0	5·00	0·19	10	343	"	0·06	79
1893	Phillips	22·0	136·0	402·00	3·00	28	500?	Steam	5·6	72?
1894	Maxim*	50·0	4000·0	8000·00	2·5	36	300?	"	363·00	28
1896	Langley	12·0	70·0	30·00	0·43	24	4,000	"	1·00	30
1897	Tatin and Richet	21·0	86·0	72·00	0·83	40	460	"	1·33	55
1897	Ader*	49·0	270·0	1100·00	4·00	50?	100?	"	40·00	27
1895	Lilienthal*	23·0	151·0	220·00	1·46	23	1,200	Gravity	2·00	110
1896	Pilcher*	23·0	170·0	200·00	1·17	25	900	"	2·00	100
1896	Chanute*	16·0	135·0	178·00	1·31	22	360	"	2·00	89
1906	S. Dumont*	39	560	550	0·98	22·26	2,900	Petrol	50	23
1908	W. Wright*	41	650	1100	1·7	37	295,000	Petrol	24	46

*The apparatus marked thus * carried a man or men.

received the stadtholder John Maurice, whose portrait is still preserved in the work of the learned Barleius.

The earliest of Flinck's authentic pieces is a likeness of a lady, dated 1636, in the gallery of Brunswick. His first subject picture is the "Blessing of Jacob," in the Amsterdam museum (1638). Both are thoroughly Rembrandtesque in effect as well as in vigour of touch and warmth of flesh tints. The four "civic guards" of 1642, and "the twelve musketeers" with their president in an arm-chair (1648), in the town-hall at Amsterdam, are fine specimens of composed portrait groups. But the best of Flinck's productions in this style is the peace of Münster in the museum of Amsterdam, a canvas with 19 life-size figures full of animation in the faces, "radiant with Rembrandtesque colour," and admirably distributed. Flinck here painted his own likeness to the left in a doorway. The mannered period of Flinck is amply illustrated in the "Marcus Curius eating Turnips before the Samnite Envoys," and "Solomon receiving Wisdom," in the palace on the Dam at Amsterdam. Here it is that Flinck shows most defects, being faulty in arrangement, gaudy in tint, flat and shallow in execution, and partial to whitened flesh that looks as if it had been smeared with violet powder and rouge. The chronology of Flinck's works, so far as they are seen in public galleries, comprises, in addition to the foregoing, the "Grey Beard" of 1639 at Dresden, the "Girl" of 1641 at the Louvre, a portrait group of a male and female (1646) at Rotterdam, a lady (1651) at Berlin. In November 1659 the burgo-master of Amsterdam contracted with Flinck for 12 canvases to represent four heroic figures of David and Samson and Marcus Curius and Horatius Cocles, and scenes from the wars of the Batavians and Romans. Flinck was unable to finish more than the sketches. In the same year he received a flattering acknowledgment from the town council of Cleves on the completion of a picture of Solomon which was a counterpart of the composition at Amsterdam. This and other pictures and portraits, such as the likenesses of Frederick William of Brandenburg and John Maurice of Nassau, and the allegory of "Louisa of Orange attended by Victory and Fame" and other figures at the cradle of the first-born son of the elector, have disappeared. Of several pictures which were painted for the Great Elector, none are preserved except the "Expulsion of Hagar" in the Berlin museum. Flinck died at Amsterdam on the 22nd of February 1660.

FLINDERS, MATTHEW (1774-1814), English navigator, explorer, and man of science, was born at Donington, near Boston, in Lincolnshire, on the 16th of March 1774. Matthew was at first designed to follow his father's profession of surgeon, but his enthusiasm in favour of a life of adventure impelled him to enter the royal navy, which he did on the 23rd of October 1789. After a voyage to the Friendly Islands and West Indies, and after serving in the "Bellerophon" during Lord Howe's "glorious first of June" (1794) off Ushant, Flinders went out in 1795 as midshipman in the "Reliance" to New South Wales. For the next few years he devoted himself to the task of accurately laying down the outline and bearings of the Australian coast, and he did his work so thoroughly that he left comparatively little for his successors to do. With his friend George Bass, the surgeon of the "Reliance," in the year of his arrival he explored George's river; and, after a voyage to Norfolk Island, again in March 1796 the two friends in the same boat, the "Tom Thumb," only 8 ft. long, and with only a boy to help them, explored a stretch of coast to the south of Port Jackson. After a voyage to the Cape of Good Hope, when he was promoted to a lieutenantcy, Flinders was engaged during February 1798 in a survey of the Furneaux Islands, lying to the north of Tasmania. His delight was great when, in September of the same year, he was commissioned along with Bass, who had already explored the sea between Tasmania and the south coast to some extent and inferred that it was a strait, to proceed in the sloop "Norfolk" (25 tons) to prove conclusively that Van Diemen's Land was an island by circumnavigating it. In the same month, in the summer of next year, Flinders made an exploration to the north of Port Jackson, the object being mainly to survey Glasshouse Bay

(Moreton Bay) and Hervey's Bay. Returning to England he was appointed to the command of an expedition for the thorough exploration of the coasts of Terra Australis, as the southern continent was still called, though Flinders is said to have been the first to suggest for it the name Australia. On the 18th of July 1801 the sloop "Investigator" (334 tons), in which the expedition sailed, left Spithead, Flinders being furnished with instructions and with a passport from the French government to all their officials in the Eastern seas. Among the scientific staff was Robert Brown, one of the most eminent English botanists; and among the midshipmen was Flinders's relative, John Franklin, of Arctic fame. Cape Leeuwin, on the southwest coast of Australia, was reached on November 6, and King George's sound on the 9th of December. Flinders sailed round the Great Bight, examining the islands and indentations on the east side, noting the nature of the country, the people, products, &c., and paying special attention to the subject of the variation of the compass. Spenser and St Vincent Gulfs were discovered and explored. On the 8th of April 1802, shortly after leaving Kangaroo Islands, at the mouth of St Vincent Gulf, Flinders fell in with the French exploring ship, "Le Géographe," under Captain Nicolas Baudin, in the bay now known as Encounter Bay. In the narrative of the French expedition published in 1807 (when Flinders was a prisoner in the Mauritius) by M. Peron, the naturalist to the expedition, much of the land west of the point of meeting was claimed as having been discovered by Baudin, and French names were extensively substituted for the English ones given by Flinders. It was only in 1814, when Flinders published his own narrative, that the real state of the case was fully exposed. Flinders continued his examination of the coast along Bass's Strait, carefully surveying Port Phillip. Port Jackson was reached on the 9th of May 1802.

After staying at Port Jackson for about a couple of months, Flinders set out again on the 22nd of July to complete his circumnavigation of Australia. The Great Barrier Reef was examined with the greatest care in several places. The northeast entrance of the Gulf of Carpentaria was reached early in November; and the next three months were spent in an examination of the shores of the gulf, and of the islands that skirt them. An inspection of the "Investigator" showed that she was in so leaky a condition that only with the greatest precaution could the voyage be completed in her. Flinders completed the survey of the Gulf of Carpentaria, and after touching at the island of Timor, the "Investigator" sailed round the west and south of Australia, and Port Jackson was reached on the 9th of June 1803. Much suffering was endured by nearly all the members of the expedition: a considerable proportion of the men succumbed to disease, and their leader was so reduced by scurvy that his health was greatly impaired.

Flinders determined to proceed home in H.M.S. "Porpoise" as a passenger, submit the results of his work to the Admiralty, and obtain, if possible, another vessel to complete his exploration of the Australian coast. The "Porpoise" left Port Jackson on the 10th of August, accompanied by the H.E.I.C.'s ship "Bridgewater" (750 tons) and the "Cato" (450 tons) of London. On the night of the 17th the "Porpoise" and "Cato" suddenly struck on a coral reef and were rapidly reduced to wrecks. The officers and men encamped on a small sandbank near, 3 or 4 ft. above high-water, a considerable quantity of provisions, with many of the papers and charts, having been saved from the wrecks. The reef was in about 22° 11' S. and 155° E., and about 800 m. from Port Jackson. Flinders returned to Port Jackson in a six-oared cutter in order to obtain a vessel to rescue the party. The reef was again reached on the 8th of October, and all the officers and men having been satisfactorily disposed of, Flinders on the 11th left for Jones Strait in an unsound schooner of 29 tons, the "Cumberland," with ten companions, and a valuable collection of papers, charts, geological specimens, &c. On the 15th of December he put in at Mauritius, when he discovered that France and England were at war. The passport he possessed from the French government was for the "Investigator"; still, though he was now on board another ship, his mission was

essentially the same, and the work he was on was simply a continuation of that commenced in the unfortunate vessel. Nevertheless, on her arrival at Port Louis the "Cumberland" was seized by order of the governor-general de Caen. Flinders's papers were taken possession of, and he found himself virtually a prisoner. We need not dwell on the sad details of this unjustifiable captivity, which lasted to June 1810. But there can be no doubt that the hardships and inactivity Flinders was compelled to endure for upwards of six years told seriously on his health, and brought his life to a premature end. He reached England in October 1810, after an absence of upwards of nine years. The official red-tapeism of the day barred all promotion to the unfortunate explorer, who set himself to prepare an account of his explorations, though unfortunately an important part of his record had been retained by de Caen. The results of his labours were published in two large quarto volumes, entitled *A Voyage to Terra Australis*, with a folio volume of maps. The very day (July 19, 1814) on which his work was published Flinders died, at the early age of forty. The great work is a model of its kind, containing as it does not only a narrative of his own and of previous voyages, but masterly statements of the scientific results, especially with regard to magnetism, meteorology, hydrography and navigation. Flinders paid great attention to the errors of the compass, especially to those caused by the presence of iron in ships. He is understood to have been the first to discover the source of such errors (which had scarcely been noticed before), and after investigating the laws of the variations, he suggested counter-attractions, an invention for which Professor Barlow got much credit many years afterwards. Numerous experiments on ships' magnetism were conducted at Portsmouth by Flinders, by order of the admiralty, in 1812. Besides the *Voyage*, Flinders wrote *Observations on the Coast of Van Diemen's Land, Bass's Strait, &c.*, and two papers in the *Phil. Trans.*—one on the "Magnetic Needle" (1805), and the other, "Observations on the Marine Barometer" (1806). (J. S. K.)

FLINSBERG, a village and watering-place of Germany, in the Prussian province of Silesia, on the Queis, at the foot of the Iserkamm, 1,450 ft. above the sea, 5 m. W. of Friedeberg, the terminus station of the railway from Greiffenberg. Pop. (1900) 1957. It contains an Evangelical and a Roman Catholic church, and has some manufactures of wooden wares. Flinsberg is celebrated for its chalybeate waters, specific in cases of feminine disorders, and used both for bathing and drinking. It is also a climatic health resort of some reputation, and the visitors number about 8,500 annually.

See Adam, *Bad Flinsberg als klimatischer Kurort* (Görlitz, 1891).

FLINT, AUSTIN (1812-1886), American physician, was born at Petersham, Massachusetts, on the 20th of October 1812, and graduated at the medical department of Harvard University in 1833. From 1847 to 1852 he was professor of the theory and practice of medicine in Buffalo Medical College, of which he was one of the founders, and from 1852 to 1856 he filled the same chair in the university of Louisville. From 1861 to 1886 he was professor of the principles and practice of medicine and clinical medicine in Bellevue Hospital Medical College, New York. He wrote many text-books on medical subjects, among these being *Diseases of the Heart* (1859-1870); *Principles and Practice of Medicine* (1866); *Clinical Medicine* (1870); and *Physical Exploration of the Lungs by means of Auscultation and Percussion* (1882). He died in New York on the 13th of March 1886.

His son, **AUSTIN FLINT**, junr., who was born at Northampton, Massachusetts, on the 28th of March 1836, after studying at Harvard and at the university of Louisville, graduated at the Jefferson Medical College, Philadelphia, in 1857. He then became professor of physiology at the university of Buffalo (1858) and subsequently at other centres, his last connexion being with the Cornell University Medical College (1898-1906). He was better known as a teacher and writer on physiology than as a practitioner, and his *Text-book of Human Physiology* (1876) was for many years a standard book in American medical colleges. He also published an extensive *Physiology of Man* (5 vols., 1866-

1874), *Chemical Examination of the Urine in Disease* (1870), *Effects of Severe and Protracted Muscular Exercise* (1871), *Source of Muscular Power* (1878), and *Handbook of Physiology* (1905). In 1896 he became a consulting physician to the New York State Hospital for the Insane.

FLINT, ROBERT (1838-), Scottish divine and philosopher, was born near Dumfries and educated at the university of Glasgow. After a few years of pastoral service, first in Aberdeen and then at Kilconquhar, Fife, he was appointed professor of moral philosophy and political economy at St Andrews in 1864. From 1876 to 1903 he was professor of divinity at Edinburgh. He contributed a number of articles to the 9th edition of the *Encyclopaedia Britannica*. His chief works are *Christ's Kingdom upon Earth* (Sermons, 1865); *Philosophy of History in Europe* (1874; partly rewritten with reference to France and Switzerland, 1894); *Theism and Anti-theistic Theories* (2 vols., being the Baird Lectures for 1876-1877; often reprinted); *Socialism* (1894); *Sermons and Addresses* (1899); *Agnosticism* (1903).

FLINT, TIMOTHY (1780-1840), American clergyman and writer, was born in Reading, Massachusetts, on the 11th of July 1780. He graduated at Harvard in 1800, and in 1802 settled as a Congregational minister in Lunenburg, Mass., where he pursued scientific studies with interest; and his labours in his chemical laboratory seemed so strange to the people of that retired region, that some persons supposed and asserted that he was engaged in counterfeiting. This, together with political differences, led to disagreeable complications, which resulted in his resigning his charge (1814) and becoming a missionary (1815) in the valley of the Mississippi. He was also for a short period a teacher and a farmer. His observations on the manners and character of the settlers of the Ohio and Mississippi valleys were recorded in a picturesque work called *Recollections of the Last Ten Years passed in the Valley of the Mississippi* (1826; reprinted in England and translated into French), the first account of the western states which brought to light the real life and character of the people. The success which this work met with, together with the failing health of the writer, led him to relinquish his more active labours for literary pursuits, and, besides editing the *Western Review* in Cincinnati from 1825 to 1828 and *Knickerbocker's Magazine* (New York) in 1833, he published a number of books, including *Francis Berrian, or the Mexican Patriot* (1826), his best novel; *A Condensed Geography and History of the Western States, or the Mississippi Valley* (2 vols., 1828); *Arthur Clenning* (1828), a novel; and *Indian Wars in the West* (1833). His style is vivid, plain and forcible, and his matter interesting; and his works on the western states are of great value. He died in Salem, Mass., on the 16th of August 1840.

FLINT, a city and the county-seat of Genesee county, Michigan, U.S.A., on Flint river, 68 m. (by rail) N.W. of Detroit. Pop. (1890) 9803; (1900) 13,103, of whom 2165 were foreign-born; (1910, census) 38,550. It is served by the Grand Trunk and the Père Marquette railways, and by an electric line, the Detroit United railway, connecting with Detroit. The city has a fine court-house (1904), a federal building (1908), a city hall (1908) and a public library. The Michigan school for the deaf, established in 1854, and the Oak Grove hospital (private) for the treatment of mental and nervous diseases, are here. Flint has important manufacturing interests, its chief manufactures being automobiles, wagons, carriages—Flint is called "the vehicle city,"—flour, woollen goods, iron goods, cigars, beer, and bricks and tiles; and its grain trade is of considerable importance. In 1904 the total value of the city's factory product was \$6,177,170, an increase of 31.1% over that of 1900. The settlement of the place, then called the Grand Traverse of the Flint, began in 1820, but Flint's growth was very slow until 1831, when it was platted as a village; it was chartered as a city in 1855.

FLINT, or **FLINTSHIRE** (*str Gallestr*), a county of North Wales, the smallest in the country, bounded N. by the Irish Sea and the Dee estuary, N.E. by the Dee, E. by Cheshire, and S.W. by Denbighshire. Area, 257 sq. m. Included in Flint is the detached hundred of Maelor, lying 8 m. S.E. of the main part of the county,

and shut in by Cheshire on the N. and N.E., by Shropshire on the S., and by Denbighshire on the W. and N.W. The Clwyd valley is common to Flint and Denbigh. Those of the Alyn and Wepre (from Ewloe Castle to the Dee) are fine. The Dee, entering the county near Overton, divides Maelor from Denbigh on the W., passes Chester and bounds most of the county on the N. The Clwyd enters Flint near Bodfary, and joining the Elwy near Rhuddlan, reaches the Irish Sea near Rhyl. The Alyn enters the county under Moel Famman, passes Cilcen and Mold (*y Wydd-grug*), runs underground near Hesb-Alyn (Alyn's drying-up), bends south to Caergwrle, re-enters Denbighshire and joins the Dee. Llyn Helyg (willow-pool), near Whitford, is the chief lake.

Both for their influence upon the physical features and for their economic value the carboniferous rocks of Flintshire are the most important. From Prestatyn on the coast a band of carboniferous limestone passes close by Holywell and through Caerwen; it forms the Halkin Mountain east of Halkin, whence it continues past Mold to beyond the county boundary. The upper portion of this series is cherty in the north—the chert is quarried for use in the potteries of Staffordshire—but traced southward it passes into sandstones and grits; above these beds come the Holywell shales, possibly the equivalent of the Pendleside series of Lancashire and Derbyshire, while upon them lies the Gwespyr sandstone, which has been thought to correspond to the Gannister coal measures of Lancashire, but may be a representative of the Millstone Grit. Farther to the east, the coal measures, with valuable coals, some oil shale, and with fireclays and marls which are used for brick and tile-making, extend from Talacre through Flint, Northop, Hawarden and Broughton to Hope. The carboniferous rocks appear again through the intervention of a fault, in the neighbourhood of St Asaph. Silurian strata, mostly of Wenlock age, lie below the carboniferous limestone on the western border of the county. Triassic red beds of the Bunter fill the Clwyd valley and appear again on the coal measures S.E. of Chester. Lead and zinc ores have been worked in the lower carboniferous rocks in the north of the county, and caves in the same formation, at Caer Gwyn and Ffynnon Beuno, have yielded the remains of Pleistocene mammals along with palaeolithic implements. Much glacial drift obscures the older rocks on the east and north and in the vale of Clwyd. Short stretches of blown sand occur on the coast near Rhyl and Talacre.

The London & North-Western railway follows the coast-line. Other railways which cross the county are the Great Western, and the Wrexham, Mold & Connah's Quay, acquired by the Great Central company. For pasture the vale of Clwyd is well known. Oats, turnips and swedes are the chief crops. Stock and dairy farming prospers, native cattle being crossed with Herefords and Downs, native sheep with Leicesters and South-downs, while in the thick mining population a ready market is found for meat, cheese, butter, &c. The population (81,700 in 1901) nearly doubled in the 19th century, and Flintshire to-day is one of the most densely populated counties in North Wales. The area of the ancient county is 164,744 acres, and that of the administrative county 163,025 acres. The collieries begin at Llanasa, run through Whitford, Holywell, Flint, Halkin (Halcyn), Northop, Buckley, Mold and Hawarden (Penarlåg). At Halkin, Mold, Holywell, Prestatyn and Talacre lead is raised, and is sometimes sent to Bagillt, Flint or Chester to be smelted. Zinc, formerly only worked at Dyserth, has increased in output, and copper mines also exist, as at Talargoch, together with smelting works, oil, vitriol, potash and alkali manufactories. Potteries around Buckley send their produce chiefly to Connah's Quay, whence a railway crosses the Dee to the Birkenhead (Cheshire) district. Iron seams are now thin, but limestone quarries yield building stone, lime for burning and small stone for chemical works. Fisheries are unproductive and textile manufactures small.

The county returns one member to parliament. The parliamentary borough district (returning one member), consists of Caergwrle, Caerwys, Flint, Holywell, Mold, Overton, St Asaph and Rhuddlan. In addition, there is a small part of the Chester parliamentary borough. There is one municipal borough, Flint (pop. 4625). The other urban districts are: Buckley (5780), Connah's Quay (3369), Holywell (2652), Mold (4263), Prestatyn (1261) and Rhyl (8473). Flint is in the North Wales and Chester circuit, assizes being held at Mold. The Flint borough has a separate commission of the peace, but no separate court of quarter sessions. The ancient county, which is in the

dioceses of Chester, Lichfield and St Asaph, contains forty-six entire ecclesiastical parishes and districts, with parts of eleven others.

Among sites of antiquarian or historical interest, besides the fragmentary ruin of Flint Castle, the following may be mentioned:—Caerwys, near Flint, still shows traces of Roman occupation. Bodfary (Bodfari) was traditionally occupied by the Romans. Moel y gaer (bald hill of the fortress), near Northop, is a remarkably perfect old British post. Maes y Garmon (perhaps for *Meusydd Garmon*, as *y*, the article, has no significance before a proper name, and so to be translated, battlefields of Germanus). A mile from Mold is the reputed scene of *une victoire sans larmes, gagnée non par les armes, mais par la foi* (E. H. Vollet). The Britons, says the legend, were threatened by the Picts and Saxons, at whose approach the *Alleluia* of that Easter (A.D. 430) was sung. Panic duly seized the invaders, but the victor, St Germanus, confessor and bishop of Auxerre (A.D. 380–448), had to return to the charge in 446. He has, under the name Garmon, a great titular share in British topography. At Bangor Iscoed, "the great high choir in Maelor," was the monastery, destroyed with over 2000 monks, by Æthelfred of Northumberland in 607, as (by a curious coincidence) its namesake Bangor in Ireland was sacked by the Danes in the 9th century. Bede says (ii. 2) that Bangor monastery was in seven sections, with three hundred (working) monks. The supposed lines of direction of Watt's and Offa's dykes were: Basingwerk, Halkin, Hope, Alyn valley, Oswestry (*Croes Oswall*, "Oswald's cross"), for Watt's, and Prestatyn, Mold, Minera, across the Severn (*Hafren*, or Sabrina) for Offa's. Owain Gwynedd (Gwynedd or Venedocia, is North Wales) defeated Henry II. at Coed Ewloe (where is a tower) and at Coleshill (*Cynsyllt*). Near Pant Asa (*pant* is a bottom) is the medieval Maen Achwynfan (*achwyn*, to complain, *maen*, stone), and tumuli, menhirs (*meini hirion*) and inscribed stones are frequent throughout the county. There is a 14th-century cross in Newmarket churchyard. Caergwrle Castle seems early Roman, or even British; but most of the castles in the county date from the early Edwards.

See H. Taylor, *Flint* (London, 1883).

FLINT, a municipal borough and the county town of the above; a seaport and contributory parliamentary borough, on the south of the Dee estuary, 192 m. from London by the London & North-Western railway. Pop. (1901) 4265. The seat of great alkali manufactures, it imports chiefly sulphur and other chemicals, exporting coal, soda, potash, copper, &c. The county gaol here, as at Haverfordwest, occupied an angle of the castle, was removed to Mold, and is now Chester Castle (jointly with Cheshire.)

Flint Castle was built on a lonely rock by the riverside by Edward I. Here met Edward II. and Piers Gaveston. Edward III. bestowed its constablership upon the earls of Chester, and here Richard II. surrendered to Bolingbroke. It was twice taken, after siege, by the parliamentarians, and finally dismantled in 1647. There remain a square court (with angle towers), round tower and drawbridge, all three entrusted to a constable, appointed by the crown under the Municipal Corporations Reforms Act. Made a borough by Edward I., Flint was chartered by Edward III., and by Edward the Black Prince, as earl of Chester.

FLINT (a word common in Teutonic and Scandinavian languages, possibly cognate with the Gr. *πλινθος*, a tile), in petrology, a dark grey or dark brown crypto-crystalline substance which has an almost vitreous lustre, and when pure appears structureless to the unaided eye. In the mass it is dark and opaque, but thin plates or the edges of splinters are pale yellow and translucent. Its hardness is greater than that of steel, so that a knife blade leaves a grey metallic streak when drawn across its surface. Its specific gravity is 2.6 or only a little less than that of crystalline quartz. It is brittle, and when hammered readily breaks up into a powder of angular grains. The fracture is perfectly conchoidal, so that blows with a hammer detach flakes which have convex, slightly undulating surfaces. At the point of impact a bulb of percussion, which is a somewhat

elevated conical mark, is produced. This serves to distinguish flints which have been fashioned by human agencies from those which have been split merely by the action of frost and the weather. The bulb is evidence of a direct blow, probably intentionally made, and is a point of some importance to archaeologists investigating Palaeolithic implements. With skill and experience a mass of flint can be worked to any simple shape by well directed strokes, and further trimming can be effected with pressure by a pointed stone in a direction slightly across the edge of the weapon. The purest flints have the most perfect conchoidal fracture, and prehistoric man is known to have quarried or mined certain bands of flint which were especially suitable for his purposes.

Silica forms nearly the whole substance of flint; calcite and dolomite may occur in it in small amounts, and analysis has also detected minute quantities of volatile ingredients, organic compounds, &c., to which the dark colour is ascribed by some authorities. These are dispelled by heat and the flint becomes white and duller in lustre. Microscopic sections show that flint is very finely crystalline and consists of quartz or chalcedonic silica; colloidal or amorphous silica may also be present but cannot form any considerable part of the rock. Spicules of sponges and fragments of other organisms, such as molluscs, polyzoa, foraminifera and brachiopods, often occur in flint, and may be partly or wholly silicified with retention of their original structure. Nodules of flint when removed from the chalk which encloses them have a white dull rough surface, and exposure to the weather produces much the same appearance on broken flints. At first they acquire a bright and very smooth surface, but this is subsequently replaced by a dull crust, resembling white or yellowish porcelain. It has been suggested that this change is due to the removal of the colloidal silica in solution, leaving behind the fibres and grains of more crystalline structure. This process must be a very slow one as, from its chemical composition, flint is a material of great durability. Its great hardness also enables it to resist attrition. Hence on beaches and in rivers, such as those of the south-east of England, flint pebbles exist in vast numbers. Their surfaces often show minute crescentic or rounded cracks which are the edges of small conchoidal fractures produced by the impact of one pebble on another during storms or floods.

Flint occurs primarily as concretions, veins and tabular masses in the white chalk of such localities as the south of England (see CHALK). It is generally nodular, and forms rounded or highly irregular masses which may be several feet in diameter. Although the flint nodules often lie in bands which closely follow the bedding, they were not deposited simultaneously with the chalk; very often the flint bands cut across the beds of the limestone and may traverse them at right angles. Evidently the flint has accumulated along fissures, such as bedding planes, joints and other cracks, after the chalk had to some extent consolidated. The silica was derived from the tests of radiolaria and the spicular skeletons of sponges. It has passed into solution, filtered through the porous matrix, and has been again precipitated when the conditions were suitable. Its formation is consequently the result of "concretionary action." Where the flints lie the chalk must have been dissolved away; we have in fact a kind of metasomatic replacement in which a siliceous rock has slowly replaced a calcareous one. The process has been very gradual and the organisms of the original chalk often have their outlines preserved in the flint. Shells may become completely silicified, or may have their cavities occupied by flint with every detail of the interior of the shell preserved in the outer surface of the cast. Objects of this kind are familiar to all collectors of fossils in chalk districts.

Chert is a coarser and less perfectly homogeneous substance of the same nature and composition as flint. It is grey, black or brown, and commonly occurs in limestone (e.g. the Carboniferous Limestone) in the same way as flint occurs in chalk. Some cherts contain tests of radiolaria, and correspond fairly closely to the siliceous radiolarian oozes which are gathering at the present day at the bottom of some of the deepest parts of the oceans. Brownish cherts are found in the English Greensand; these often contain remains of sponges.

The principal uses to which flint has been put are the fabrication of weapons in Palaeolithic and Neolithic times. Other materials have been employed where flint was not available, e.g. obsidian, chert, chalcedony, agate and quartzite, but to prehistoric man (see FLINT IMPLEMENTS below) flint must have been of great value and served many of the uses to which steel is put at the present day. Flint gravels are widely employed for dressing walks and roads, and for rough-cast work in architecture. For road-mending flint, though very hard, is not regarded with favour, as it is brittle and pulverizes readily; binds badly, yielding a surface which breaks up with heavy traffic and in bad weather; and its fine sharp-edged chips do much damage to tires of motors and cycles. Seasoned flints

from the land, having been long exposed to the atmosphere, are preferred to flints freshly dug from the chalk pits. Formerly flint and steel were everywhere employed for striking a light; and gun flints were required for fire-arms. A special industry in the shaping of gun flints long existed at Brandon in Suffolk. In 1870 about thirty men were employed. Since then the trade has become almost extinct as gun flints are in demand only in semi-savage countries where modern fire-arms are not obtainable. Powdered flint was formerly used in the manufacture of glass, and is still one of the ingredients of many of the finer varieties of pottery. (J. S. F.)

FLINT IMPLEMENTS AND WEAPONS. The excavation of these remains of the prehistoric races of the globe in river-drift gravel-beds has marked a revolution in the study of Man's history (see ARCHAEOLOGY). Until almost the middle of the 19th century no suspicion had arisen in the minds of British and European archaeologists that the momentous results of the excavations then proceeding in Egypt and Assyria would be dwarfed by discoveries at home which revolutionized all previous ideas of Man's antiquity. It was in 1841 that Boucher de Perthes observed in some sand containing mammalian remains, at Menchecourt near Abbeville, a flint, roughly worked into a cutting implement. This "find" was rapidly followed by others, and Boucher de Perthes published his first work on the subject, *Antiquités celtiques et antédiluviennes: mémoire sur l'industrie primitive et les arts à leur origin* (1847), in which he proclaimed his discovery of human weapons in beds unmistakably belonging to the age of the Drift. It was not until 1859 that the French archaeologist convinced the scientific world. An English mission then visited his collection and testified to the great importance of his discoveries. The "finds" at Abbeville were followed by others in many places in England, and in fact in every country where siliceous stones which are capable of being flaked and fashioned into implements are to be found. The implements occurred in beds of rivers and lakes, in the tumuli and ancient burial-mounds; on the sites of settlements of prehistoric man in nearly every land, such as the shell-heaps and lake-dwellings; but especially embedded in the high-level gravels of England and France which have been deposited by river-floods and long left high and dry above the present course of the stream. These gravels represent the Drift or Palaeolithic period when man shared Europe with the mammoth and woolly-haired rhinoceros. The worked flints of this age are, however, unevenly distributed; for while the river-gravels of south-eastern England yield them abundantly, none has been found in Scotland or the northern English counties. On the continent the same partial distribution is observable: while they occur plentifully in the north-western area of France, they are not discovered in Sweden, Norway or Denmark. The association of these flints, fashioned for use by chipping only, with the bones of animals either extinct or no longer indigenous, has justified their reference to the earlier period of the Stone Age, generally called Palaeolithic. Those flint implements, which show signs of polishing and in many cases remarkably fine workmanship, and are found in tumuli, peat-bogs and lake-dwellings mixed with the bones of common domestic animals, are assigned to the Neolithic or later Stone Age. The Palaeolithic flints are hammers, flakes, scrapers, implements worked to a cutting edge at one side, implements which resemble rude axes, flat ovoid implements worked to an edge all round, and a great quantity of spear and arrow heads. None of these is ground or polished. The Neolithic flints, on the other hand, exhibit more variety of design, are carefully finished, and the particular use of each weapon can be easily detected. Man has reached the stage of culture when he could socket a stone into a wooden handle, and fix a flaked flint as a handled dagger or knife. The workmanship is superior to that shown in any of the stone utensils made by savage tribes of historic times. The manner of making flint implements appears to have been in all ages much the same. Flint from its mode of fracture is the only kind of stone which can be chipped or flaked into almost any shape, and thus forms the principal material of these earliest weapons. The blows must be carefully aimed or the flakes

dislodged will be shattered: a gun-flint maker at Brandon, Suffolk, stated that it took him two years to acquire the art.

For accounts of the gun-flint manufacture at Brandon, and detailed descriptions of ancient flint-working, see Sir John Evans, *Ancient Stone Implements* (1897), Lord Avebury's *Prehistoric Times* (1865, 1900); also Thomas Wilson, "Arrow-heads, Spear-heads and Knives of Prehistoric Times," in *Smithsonian Report* for 1897; and W. K. Moorehead, *Prehistoric Implements* (1900).

FLOAT (in O. Eng. *flot* and *flota*, in the verbal form *flēotan*; the Teutonic root is *flut-*, another form of *flu-*, seen in "flow," cf. "fleet"; the root is seen in Gr. *πλέειν*, to sail, Lat. *pluere*, to rain; the Lat. *fluere* and *fluctus*, wave, is not connected), the action of moving on the surface of water, or through the air. The word is used also of a wave, or the flood of the tide, river, backwater or stream, and of any object floating in water, as a mass of ice or weeds; a movable landing-stage, a flat-bottomed boat, or a raft, or, in fishing, of the cork or quill used to support a baited line or fishing-net. It is also applied to the hollow or inflated organ by means of which certain animals, such as the "Portuguese man-of-war," swim, to a hollow metal ball or piece of whinstone, &c., used to regulate the level of water in a tank or boiler, and to a piece of ivory in the cistern of a barometer. "Float" is also the name of one of the boards of a paddle-wheel or water-wheel. In a theatrical sense, it is used to denote the footlights. The word is also applied to something broad, level and shallow, as a wooden frame attached to a cart or wagon for the purpose of increasing the carrying capacity; and to a special kind of low, broad cart for carrying heavy weights, and to a platform on wheels used for shows in a procession. The term is applied also to various tools, especially to many kinds of trowels used in plastering. It is also used of a dock where vessels may float, as at Bristol, and of the trenches used in "floating" land. In geology and mining, loose rock or ore brought down by water is known as "float," and in tin-mining it is applied to a large trough used for the smelted tin. In weaving the word is used of the passing of weft threads over part of the warp without being woven in with it, also of the threads so passed. In the United States a voter not attached to any particular party and open to bribery is called a "float" or "floater."

FLOCK. 1. (A word found in Old English and Old Norwegian, from which come the Danish and Swedish words, and not in other Teutonic languages), originally a company of people, now mainly, except in figurative usages, of certain animals when gathered together for feeding or moving from place to place. For birds it is chiefly used of geese; and for other animals most generally of sheep and goats. It is from the particular application of the word to sheep that "flock" is used of the Christian Church in its relation to the "Good Shepherd," and also of a congregation of worshippers in its relation to its spiritual head.

2. (Probably from the Lat. *floccus*, but many Teutonic languages have the same word in various forms), a tuft of wool, cotton or similar substance. The name "flock" is given to a material formed of wool or cotton refuse, or of shreds of old woollen or cotton rags, torn by a machine known as a "devil." This material is used for stuffing mattresses or pillows, and also in upholstery. The name is also applied to a special kind of wall-paper, which has an appearance almost like cloth, or, in the more expensive kinds, of velvet. It is made by dusting on a specially prepared adhesive surface finely powdered fibres of cotton or silk. The word "flocculent" is used of many substances which have a fleecy or "flock"-like appearance, such as a precipitate of ferric hydrate.

FLODDEN, or **FLODDEN FIELD**, near the village of Branxton, in Northumberland, England (10 m. N.W. of Wooler), the scene of a famous battle fought on the 9th of September 1513 between the English and the Scots. On the 22nd of August a great Scottish army under King James IV. had crossed the border. For the moment the earl of Surrey (who in King Henry VIII.'s absence was charged with the defence of the realm) had no organized force in the north of England, but James wasted much precious time among the border castles, and when Surrey appeared at Wooler, with an army equal in strength to his own,

which was now greatly weakened by privations and desertion, he had not advanced beyond Ford Castle. The English commander promptly sent in a challenge to a pitched battle, which the king, in spite of the advice of his most trusted counsellors, accepted. On the 6th of September, however, he left Ford and took up a strong position facing south, on Flodden Edge. Surrey's reproaches for the alleged breach of faith, and a second challenge to fight on Millfield Plain were this time disregarded. The English commander, thus foiled, executed a daring and skilful march round the enemy's flank, and on the 9th drew up for battle in rear of the hostile army. It is evident that Surrey was confident of victory, for he placed his own army, not less than the enemy, in a position where defeat would involve utter ruin. On his appearance the Scots hastily changed front and took post on Branxton Hill, facing north. The battle began at 4 P.M. Surrey's archers and cannon soon gained the upper hand, and the Scots, unable quietly to endure their losses, rushed to close quarters. Their left wing drove the English back, but Lord Dacre's reserve corps restored the fight on this side. In all other parts of the field, save where James and Surrey were personally opposed, the English gradually gained ground. The king's corps was then attacked by Surrey in front, and by Sir Edward Stanley in flank. As the Scots were forced back, a part of Dacre's force closed upon the other flank, and finally Dacre himself, boldly neglecting an almost intact Scottish division in front of him, charged in upon the rear of King James's corps. Surrounded and attacked on all sides, this, the remnant of the invading army, was doomed. The circle of spearmen around the king grew less and less, and in the end James and a few of his nobles were alone left standing. Soon they too died, fighting to the last man. Among the ten thousand Scottish dead were all the leading men in the kingdom of Scotland, and there was no family of importance that had not lost a member in this great disaster. The "King's Stone," said to mark the spot where James was killed, is at some distance from the actual battlefield. "Sybil's Well," in Scott's *Marmion*, is imaginary.

FLODOARD (894-966), French chronicler, was born at Epernay, and educated at Reims in the cathedral school which had been established by Archbishop Fulcon (822-900). As canon of Reims, and favourite of the archbishops Herivauc (d. 922) and Seulfus (d. 925), he occupied while still young an important position at the archiepiscopal court, but was twice deprived of his benefices by Heribert, count of Vermandois, on account of his steady opposition to the election of the count's infant son to the archbishopric. Upon the final triumph of Archbishop Artold in 947, Flodoard became for a time his chief adviser, but withdrew to a monastery in 952, and spent the remaining years of his life in literary and devotional work. His history of the cathedral church at Reims (*Historia Remensis Ecclesiae*) is one of the most remarkable productions of the 10th century. Flodoard had been given charge of the episcopal archives, and constructed his history out of the original texts, which he generally reproduces in full; the documents for the period of Hincmar being especially valuable. The *Annales* which Flodoard wrote year by year from 919 to 966 are doubly important, by reason of the author's honesty and the central position of Reims in European affairs in his time. Flodoard's poetical works are of hardly less historical interest. The long poem celebrating the triumph of Christ and His saints was called forth by the favour shown him by Pope Leo VII., during whose pontificate he visited Rome, and he devotes fourteen books to the history of the popes.

Flodoard's works were published in full by J. P. Migne (*Patrologia Latina*, vol. 135); a modern edition of the *Annales* is the one edited by P. Lauer (Paris, 1906). For bibliography see A. Molinier, *Sources de l'histoire de France* (No. 932).

FLOE (of uncertain derivation; cf. Norse *flo*, layer, level plain), a sheet of floating ice detached from the main body of polar ice. It is of less extent than the field of "pack" ice, which is a compacted mass of greater depth drifting frequently under the influence of deep currents, while the floating floe is driven by the wind.

FLOOD, HENRY (1732-1791), Irish statesman, son of Warden Flood, chief justice of the king's bench in Ireland, was born in 1732, and was educated at Trinity College, Dublin, and afterwards at Christ Church, Oxford, where he became proficient in the classics. His father was a man of good birth and fortune, and he himself married a member of the influential Beresford family, who brought him a large fortune. In his early years he was handsome, witty, good-tempered, and a brilliant conversationalist. His judgment was sound, and he had a natural gift of eloquence which had been cultivated and developed by study of classical oratory and the practice of elocution. Flood therefore possessed every personal advantage when, in 1759, he entered the Irish parliament as member for Kilkenny in his twenty-seventh year. There was at that time no party in the Irish House of Commons that could truly be called national, and until a few years before there had been none that deserved even the name of an opposition. The Irish parliament was still constitutionally subordinate to the English privy council; it had practically no powers of independent legislation, and none of controlling the policy of the executive, which was nominated by the ministers in London (see GRATTAN, HENRY). Though the great majority of the people were Roman Catholics, no person of that faith could either enter parliament or exercise the franchise; the penal code, which made it almost impossible for a Roman Catholic to hold property, to follow a learned profession, or even to educate his children, and which in numerous particulars pressed severely on the Roman Catholics and subjected them to degrading conditions, was as yet unrepealed, though in practice largely obsolete; the industry and commerce of Ireland were throttled by restrictions imposed, in accordance with the economic theories of the period, in the interest of the rival trade of Great Britain. Men like Anthony Malone and Hely-Hutchison fully realized the necessity for far-reaching reforms, and it only needed the ability and eloquence of Flood in the Irish House of Commons to raise up an independent party in parliament, and to create in the country a public opinion with definite intelligible aims.

The chief objects for which Flood strove were the shortening of the duration of parliament—which had then no legal limit in Ireland except that of the reigning sovereign's life,—the reduction of the scandalously heavy pension list, the establishment of a national militia, and, above all, the complete legislative independence of the Irish parliament. For some years little was accomplished; but in 1768 the English ministry, which had special reasons at the moment for avoiding unpopularity in Ireland, allowed an octennial bill to pass, which was the first step towards making the Irish House of Commons in some measure representative of public opinion. It had become the practice to allow crown patronage in Ireland to be exercised by the owners of parliamentary boroughs in return for their undertaking to manage the House in the government interest. But during the viceroyalty of Lord Townsend the aristocracy, and more particularly these "undertakers" as they were called, were made to understand that for the future their privileges in this respect would be curtailed. When, therefore, an opportunity was taken by the government in 1768 for reasserting the constitutional subordination of the Irish parliament, these powerful classes were thrown into temporary alliance with Flood. In the following year, in accordance with the established procedure, a money bill was sent over by the privy council in London for acceptance by the Irish House of Commons. Not only was it rejected, but contrary to custom a reason for this course was assigned, namely, that the bill had not originated in the Irish House. In consequence parliament was peremptorily prorogued, and a recess of fourteen months was employed by the government in securing a majority by the most extensive corruption.¹ Nevertheless when parliament met in February 1771 another money bill was thrown out on the motion of Flood; and the next year Lord Townsend, the lord lieutenant whose policy had provoked this conflict, was recalled. The struggle was the occasion of a publication, famous in its day, called *Baratariana*, to which

¹ Walpole's *George III.*, iv. 348.

Flood contributed a series of powerful letters after the manner of Junius, one of his collaborators being Henry Grattan.

The success which had thus far attended Flood's efforts had placed him in a position such as no Irish politician had previously attained. He had, as an eminent historian of Ireland observes, "proved himself beyond all comparison the greatest popular orator that his country had yet produced, and also a consummate master of parliamentary tactics. Under parliamentary conditions that were exceedingly unfavourable, and in an atmosphere charged with corruption, venality and subserviency, he had created a party before which ministers had begun to quail, and had inoculated the Protestant constituencies with a genuine spirit of liberty and self-reliance."² Lord Harcourt, who succeeded Townsend as viceroy, saw that Flood must be conciliated at any price "rather than risk the opposition of so formidable a leader." Accordingly, in 1775, Flood was offered and accepted a seat in the privy council and the office of vice-treasurer with a salary of £3500 a year. For this step he has been severely criticized. The suggestion that he acted corruptly in the matter is groundless; and although it is true that he lost influence from the moment he became a minister of the crown, Flood may reasonably have held that he had a better prospect of advancing his policy by the leverage of a ministerial position than by means of any opposition party he could hope to muster in an unreformed House of Commons.³ The result, however, was that the leadership of the national party passed from Flood to Grattan, who entered the Irish parliament in the same session that Flood became a minister.

Flood continued in office for nearly seven years. During this long period he necessarily remained silent on the subject of the independence of the Irish parliament, and had to be content with advocating minor reforms as occasion offered. He was thus instrumental in obtaining bounties on the export of Irish corn to foreign countries and some other trifling commercial concessions. On the other hand he failed to procure the passing of a Habeas Corpus bill and a bill for making the judges irremovable, while his support of Lord North's American policy still more gravely injured his popularity and reputation. But an important event in 1778 led indirectly to his recovering to some extent his former position in the country; this event was the alliance of France with the revolted American colonies. Ireland was thereby placed in peril of a French invasion, while the English government could provide no troops to defend the island. The celebrated volunteer movement was then set on foot to meet the emergency; in a few weeks more than 40,000 men, disciplined and equipped, were under arms, officered by the country gentry, and controlled by the wisdom and patriotism of Lord Charlemont. This volunteer force, in which Flood was a colonel, while vigilant for the defence of the island, soon made itself felt in politics. A Volunteer Convention, formed with all the regular organization of a representative assembly, but wielding the power of an army, began menacingly to demand the removal of the commercial restrictions which were destroying Irish prosperity. Under this pressure the government gave way; the whole colonial trade was in 1779 thrown open to Ireland for the first time, and other concessions were also extorted. Flood, who had taken an active though not a leading part in this movement, now at last resigned his office to rejoin his old party. He found to his chagrin that his former services had been to a great extent forgotten, and that he was eclipsed by Grattan. When in a debate on the constitutional question in 1779 Flood complained of the small consideration shown him in relation to a subject which he had been the first to agitate, he was reminded that by the civil law "if a man should separate from his wife, and abandon her for seven years, another might then take her and give her his protection." But though Flood had lost control of the movement for independence of the Irish parliament, the agitation, backed as it now was by the Volunteer Convention

² W. E. H. Lecky, *Leaders of Public Opinion in Ireland* (enlarged edition, 2 vols., 1903), i. 48.

³ See Hardy's *Life of Charlemont*, i. 356.

and by increasing signs of popular disaffection, led at last in 1782 to the concession of the demand, together with a number of other important reforms (see GRATTAN, HENRY).

No sooner, however, was this great success gained than a question arose—known as the Simple Repeal controversy— as to whether England, in addition to the repeal of the Acts on which the subordination of the Irish parliament had been based, should not be required expressly to renounce for the future all claim to control Irish legislation. The chief historical importance of this dispute is that it led to the memorable rupture of friendship between Flood and Grattan, each of whom assailed the other with unmeasured but magnificently eloquent invective in the House of Commons. Flood's view prevailed—for a Renunciation Act such as he advocated was ungrudgingly passed by the English parliament in 1783—and for a time he regained popularity at the expense of his rival. Flood next (28th of November 1783) introduced a reform bill, after first submitting it to the Volunteer Convention. The bill, which contained no provision for giving the franchise to Roman Catholics—a proposal which Flood always opposed—was rejected, ostensibly on the ground that the attitude of the volunteers threatened the freedom of parliament. The volunteers were perfectly loyal to the crown and the connexion with England. They carried an address to the king, moved by Flood, expressing the hope that their support of parliamentary reform might be imputed to nothing but “a sober and laudable desire to uphold the constitution . . . and to perpetuate the cordial union of both kingdoms.” The convention then dissolved, though Flood had desired, in opposition to Grattan, to continue it as a means of putting pressure on parliament for the purpose of obtaining reform.

In 1776 Flood had made an attempt to enter the English House of Commons. In 1783 he tried again, this time with success. He purchased a seat for Winchester from the duke of Chandos, and for the next seven years he was a member at the same time of both the English and Irish parliaments. He reintroduced, but without success, his reform bill in the Irish House in 1784; supported the movement for protecting Irish industries; but short-sightedly opposed Pitt's commercial propositions in 1785. He remained a firm opponent of Roman Catholic emancipation, even defending the penal laws on the ground that after the Revolution they “were not laws of persecution but of political necessity”; but after 1786 he does not appear to have attended the parliament in Dublin. In the House at Westminster, where he refused to enrol himself as a member of either political party, he was not successful. His first speech, in opposition to Fox's India Bill on the 3rd of December 1783, disappointed the expectations aroused by his celebrity. His speech in opposition to the commercial treaty with France in 1787 was, however, most able; and in 1790 he introduced a reform bill which Fox declared to be the best scheme of reform that had yet been proposed, and which in Burke's opinion retrieved Flood's reputation. But at the dissolution in the same year he lost his seat in both parliaments, and he then retired to Farmley, his residence in county Kilkenny, where he died on the 2nd of December 1791.

When Peter Burrowes, notwithstanding his close personal friendship with Grattan, declared that Flood was “perhaps the ablest man Ireland ever produced, indisputably the ablest man of his own times,” he expressed what was probably the general opinion of Flood's contemporaries. Lord Charlemont, who knew him intimately though not always in agreement with his policy, pronounced him to be “a man of consummate ability.” He also declared that avarice made no part of Flood's character. Lord Mountmorres, a critic by no means partial to Flood, described him as a pre-eminently truthful man, and one who detested flattery. Grattan, who even after the famous quarrel never lost his respect for Flood, said of him that he was the best tempered and the most sensible man in the world. In his youth he was genial, frank, sociable and witty; but in later years disappointment made him gloomy and taciturn. As an orator he was less polished, less epigrammatic than Grattan; but a closer reasoner and a greater master of sarcasm and invective. Personal ambition often governed his actions, but his political judgment was usually

sound; and it was the opinion of Bentham that Flood would have succeeded in carrying a reform bill which might have preserved Irish parliamentary independence, if he had been supported by Grattan and the rest of his party in keeping alive the Volunteer Convention in 1783. Though he never wavered in loyalty to the British crown and empire, Ireland never produced a more sincere patriot than Henry Flood.

See Warden Flood, *Memoirs of Henry Flood* (London, 1838); Henry Grattan, *Memoirs of the Life and Times of the Right Hon. H. Grattan* (5 vols., London, 1839-1846); Charles Phillips, *Recollections of Curran and some of his Contemporaries* (London, 1822); *The Irish Parliament 1775*, from an official and contemporary manuscript, edited by William Hunt (London, 1907); W. J. O'Neill Daunt, *Ireland and her Agitators*; Lord Mountmorres, *History of the Irish Parliament* (2 vols., London, 1792); W. E. H. Lecky, *History of England in the Eighteenth Century* (8 vols., London, 1878-1890); and *Leaders of Public Opinion in Ireland* (enlarged edition, 2 vols., London, 1903); J. A. Froude, *The English in Ireland*, vols. ii. and iii. (London, 1881); Horace Walpole, *Memoirs of the Reign of George III.* (4 vols., London, 1845, 1894); Sir Jonah Barrington, *Rise and Fall of the Irish Nation* (London, 1833); Francis Plowden, *Historical Review of the State of Ireland* (London, 1803); Alfred Webb, *Compendium of Irish Biography* (Dublin, 1878); F. Hardy, *Memoirs of Lord Charlemont* (London, 1812), especially for the volunteer movement, on which see also *Proceedings of the Volunteer Delegates of Ireland 1784* (Anon. Pamphlet, Brit. Mus.); also *The Charlemont Papers*, and *Irish Parl. Debates*, vols. i.-iv. (R. J. M.)

FLOOD (in O. Eng. *flōd*, a word common to Teutonic languages, cf. Ger. *Flut*, Dutch *vloed*, from the same root as is seen in “flow,” “float”), an overflow of water, an expanse of water submerging land, a deluge, hence “the flood,” specifically, the Noachian deluge of Genesis, but also any other catastrophic submersion recorded in the mythology of other nations than the Hebrew (see DELUGE, THE). In the sense of “flowing water,” the word is applied to the inflow of the tide, as opposed to “ebb.”

FLOOD PLAIN, the term in physical geography for a plain formed of sediment dropped by a river. When the slope down which a river runs has become very slight, it is unable to carry the sediment brought from higher regions nearer its source, and consequently the lower portion of the river valley becomes filled with alluvial deposits; and since in times of flood the rush of water in the high regions tears off and carries down a greater quantity of sediment than usual, the river spreads this also over the lower valley where the plain is flooded, because the rush of water is checked, and the stream in consequence drops its extra load. These flood plains are sometimes of great extent. That of the Mississippi below Ohio has a width of from 20 to 80 m., and its whole extent has been estimated at 50,000 sq. m. Flood plains may be the result of planation, with aggradation, that is, they may be due to a graded river working in meanders from side to side, widening its valley by this process and covering the widened valley with sediment. Or the stream by cutting into another stream (piracy), by cutting through a barrier near its head waters, by entering a region of looser or softer rock, and by glacial drainage, may form a flood plain simply by filling up its valley (alluviation only). Any obstruction across a river's course, such as a band of hard rock, may form a flood plain behind it, and indeed anything which checks a river's course and causes it to drop its load will tend to form a flood plain; but it is most commonly found near the mouth of a large river, such as the Rhine, the Nile, or the Mississippi, where there are occasional floods and the river usually carries a large amount of sediment. “Levees” are formed, inside which the river usually flows, gradually raising its bed above the surrounding plain. Occasional breaches during floods cause the overloaded stream to spread in a great lake over the surrounding country, where the silt covers the ground in consequence. Sections of the Missouri flood plain made by the United States geological survey show a great variety of material of varying coarseness, the stream bed being scoured at one place, and filled at another by currents and floods of varying swiftness, so that sometimes the deposits are of coarse gravel, sometimes of fine sand, or of fine silt, and it is probable that any section of such an alluvial plain would show deposits of a similar character. The flood plain during its formation is marked by meandering, or anastomosing streams, ox-bow lakes and bayous,

marshes or stagnant pools, and is occasionally completely covered with water. When the drainage system has ceased to act or is entirely diverted owing to any cause, the flood plain may become a level area of great fertility, similar in appearance to the floor of an old lake. The flood plain differs, however, inasmuch as it is not altogether flat. It has a gentle slope down-stream, and often for a distance from the sides towards the centre.

FLOOR (from O. Eng. *flor*, a word common to many Teutonic languages, cf. Dutch *vloer*, and Ger. *Flur*, a field, in the feminine, and a floor, masculine), generally the lower horizontal surface of a room, but specially employed for one covered with boarding or parquetry. The various levels of rooms in a house are designated as "ground-floor," "first-floor," "mezzanine-floor," &c. The principal floor is the storey which contains the chief apartments whether on the ground- or first-floor; in Italy they are always on the latter and known as the "piano nobile." The storey below the ground-floor is called the "basement-floor," even if only a little below the level of the pavement outside; the storey in a roof is known as the "attic-floor." The expressions one pair, two pair, &c., apply to the storeys above the first flight of stairs from the ground (see also CARPENTRY).

FLOORCLOTH, a rough flannel cloth used for domestic cleaning; also a generic term applied to a variety of materials used in place of carpets for covering floors, and known by such trade names as kamptulicon, oil-cloth, linoleum, corticine, cork-carpet, &c. Kamptulicon (*καμπτός*, flexible, *ούλος*, thick) was patented in 1844 by E. Galloway, but did not attract much attention till about 1862. It was essentially a preparation of indiarubber masticated up with ground cork, and rolled out into sheets between heavy steam-heated rollers, sometimes over a backing of canvas. Owing to its expensiveness, it has given place to cheaper materials serving the same purpose. Oil-cloth is a coarse canvas which has received a number of coats of thick oil paint, each coat being rubbed smooth with pumice stone before the application of the next. Its surface is ornamented with patterns printed in oil colours by means of wooden blocks. Linoleum (*linum*, flax, *oleum*, oil), patented by F. Walton in 1860 and 1863, consists of oxidized linseed oil and ground cork. These ingredients, thoroughly incorporated with the addition of certain gummy and resinous matters, and of pigments such as ochre and oxide of iron as required, are pressed on to a rough canvas backing between steam-heated rollers. Patterns may be printed on its surface with oil paint, or by an improved method may be inlaid with coloured composition so that the colours are continuous through the thickness of the linoleum, instead of being on the surface only, and thus do not disappear with wear. Lincrusta-Walton is a similar material to linoleum, also having oxidized linseed oil as its base, which is stamped out in embossed patterns and used as a covering for walls.

FLOQUET, CHARLES THOMAS (1828-1896), French statesman, was born at St Jean-Pied-de-Port (Basses-Pyrénées) on the 2nd of October 1828. He studied law in Paris, and was called to the bar in 1851. The *coup d'état* of that year aroused the strenuous opposition of Floquet, who had, while yet a student, given proof of his republican sympathies by taking part in the fighting of 1848. He made his name by his brilliant and fearless attacks on the government in a series of political trials, and at the same time contributed to the *Temps* and other influential journals. When the tsar Alexander II. visited the Palais de Justice in 1867, Floquet was said to have confronted him with the cry "Vive la Pologne, monsieur!" He delivered a scathing indictment of the Empire at the trial of Pierre Bonaparte for killing Victor Noir in 1870, and took a part in the revolution of the 4th of September, as well as in the subsequent defence of Paris. In 1871 he was elected to the National Assembly by the department of the Seine. During the Commune he formed the *Ligue d'union républicaine des droits de Paris* to attempt a reconciliation with the government of Versailles. When his efforts failed, he left Paris, and was imprisoned by order of Thiers, but soon released. He became editor of the *République Française*, was chosen president of the municipal council, and in 1876 was elected deputy for the eleventh arrondissement. He took a

prominent place among the extreme radicals, and became president of the group of the "Union républicaine." In 1882 he held for a short time the post of prefect of the Seine. In 1885 he succeeded M. Brisson as president of the chamber. This difficult position he filled with such tact and impartiality that he was re-elected the two following years. Having approached the Russian ambassador in such a way as to remove the prejudice existing against him in Russia since the incident of 1867, he rendered himself eligible for office; and on the fall of the Tirard cabinet in 1888 he became president of the council and minister of the interior in a radical ministry, which pledged itself to the revision of the constitution, but was forced to combat the proposals of General Boulanger. Heated debates in the chamber culminated on the 13th of July in a duel between Floquet and Boulanger in which the latter was wounded. In the following February the government fell on the question of revision, and in the new chamber of November Floquet was re-elected to the presidential chair. The Panama scandals, in which he was compelled to admit his implication, dealt a fatal blow to his career: he lost the presidency of the chamber in 1892, and his seat in the house in 1893, but in 1894 was elected to the senate. He died in Paris on the 18th of January 1896.

See *Discours et opinions de M. Charles Floquet*, edited by Albert Faivre (1885).

FLOR, ROGER DI, a military adventurer of the 13th-14th century, was the second son of a falconer in the service of the emperor Frederick II., who fell at Tagliacozzo (1268), and when eight years old was sent to sea in a galley belonging to the Knights Templars. He entered the order and became commander of a galley. At the siege of Acre by the Saracens in 1291 he was accused and denounced to the pope as a thief and an apostate, was degraded from his rank, and fled to Genoa, where he began to play the pirate. The struggle between the kings of Aragon and the French kings of Naples for the possession of Sicily was at this time going on; and Roger entered the service of Frederick, king of Sicily, who gave him the rank of vice-admiral. At the close of the war, in 1302, as Frederick was anxious to free the island from his mercenary troops (called *Almúgavares*), whom he had no longer the means of paying, Roger induced them under his leadership to seek new adventures in the East, in fighting against the Turks, who were ravaging the empire. The emperor Andronicus II. accepted his offer of service; and in September 1303 Roger with his fleet and army arrived at Constantinople. He was adopted into the imperial family, was married to a grand-daughter of the emperor, and was made grand duke and commander-in-chief of the army and the fleet. After some weeks lost in dissipation, intrigues and bloody quarrels, Roger and his men were sent into Asia, and after some successful encounters with the Turks they went into winter quarters at Cyzicus. In May 1304 they again took the field, and rendered the important service of relieving Philadelphia, then invested and reduced to extremities by the Turks. But Roger, bent on advancing his own interests rather than those of the emperor, determined to found in the East a principality for himself. He sent his treasures to Magnesia, but the people slew his Catalans and seized the treasures. He then formed the siege of the town, but his attacks were repulsed, and he was compelled to retire. Being recalled to Europe, he settled his troops in Gallipoli and other towns, and visited Constantinople to demand pay for the *Almúgavares*. Dissatisfied with the small sum granted by the emperor, he plundered the country and carried on intrigues both with and against the emperor, receiving reinforcements all the while from all parts of southern Europe. Roger was now created Caesar, but shortly afterwards the young emperor Michael Palaeologus, not daring to attack the fierce and now augmented bands of adventurers, invited Roger to Adrianople, and there contrived his assassination and the massacre of his Catalan cavalry (April 4, 1306). His death was avenged by his men in a fierce and prolonged war against the Greeks.

See Moncada, *Expedición de los Catalanes y Aragoneses contra Turcos y Griegos* (Paris, 1840).

FLORA, in Roman mythology, goddess of spring-time and flowers, later identified with the Greek Chloris. Her festival at Rome, the Floralia, instituted 238 B.C. by order of the Sibylline books and at first held irregularly, became annual after 173. It lasted six days (April 28–May 3), the first day being the anniversary of the foundation of her temple. It included theatrical performances and animal hunts in the circus, and vegetables were distributed to the people. The proceedings were characterized by excessive merriment and licentiousness. According to the legend, her worship was instituted by Titus Tatius, and her priest, the flamen Floralis, by Numa. In art Flora was represented as a beautiful maiden, bedecked with flowers (Ovid, *Fasti*, v. 183 ff.; Tacitus, *Annals*, ii. 49).

The term "flora" is used in botany collectively for the plant-growth of a district; similarly "fauna" is used collectively for the animals.

FLORE AND BLANCHEFEUR, a 13th-century romance. This tale, generally supposed to be of oriental origin, relates the passionate devotion of two children, and their success in overcoming all the obstacles put in the way of their love. The romance appears in differing versions in French, English, German, Swedish, Icelandic, Italian, Spanish, Greek and Hungarian. The various forms of the tale receive a detailed notice in E. Hausknecht's version of the 13th-century Middle English poem of "Floris and Blanchefleur" (*Samml. eng. Denkmäler*, vol. v. Berlin, 1885). Nothing definite can be stated of the origin of the story, but France was in the 12th and 13th centuries the chief market of romance, and the French version of the tale, *Floire et Blanchefleur*, is the most widespread. Floire, the son of a Saracen king of Spain, is brought up in constant companionship with Blanchefleur, the daughter of a Christian slave of noble birth. Floire's parents, hoping to destroy this attachment, send the boy away at fifteen and sell Blanchefleur to foreign slave-merchants. When Floire returns a few days later he is told that his companion is dead, but when he threatens to kill himself, his parents tell him the truth. He traces her to the tower of the maidens destined for the harem of the emir of Babylon, into which he penetrates concealed in a basket of flowers. The lovers are discovered, but their constancy touches the hearts of their judges. They are married, and Floire returns to his kingdom, when he and all his people adopt Christianity. Of the two 12th-century French poems (ed. Édélestand du Méril, Paris, 1856), the one contains the love story with few additions, the other is a romance of chivalry, containing the usual battles, single combats, &c. Two lyrics based on episodes of the story are printed by Paulin Paris in his *Romancero français* (Paris, 1883). The English poem renders the French version without amplifications, such as are found in other adaptations. Its author has less sentiment than his original, and less taste for detailed description. Among the other forms of the story must be noted the prose romance (c. 1340) of Boccaccio, *Il Filocolo*, and the 14th-century *Leggenda della reina Rosana e di Rosana sua figliuola* (pr. Leghorn, 1871). The similarity between the story of Floire and Blanchefleur and *Chante-fable of Aucassin et Nicolette*¹ has been repeatedly pointed out, and they have even been credited with a common source.

See also editions by I. Bekker (Berlin, 1844) and E. Hausknecht (Berlin, 1885); also H. Sundmacher, *Die altfr. und mittelhochdeutsche Bearbeitung der Sage von Floire et Blanchefleur* (Göttingen, 1872); H. Herzog, *Die beiden Sagenkreise von Floire und Blanchefleur* (Vienna, 1884); *Zeitschrift für deut. Altertum* (vol. xxi.) contains a Rhenish version; the Scandinavian *Flores Saga ok Blankiflur*, ed. E. Kölbjng (Halle, 1896); the 13th-century version of Konrad Fleck, *Flore und Blanchefleur*, ed. E. Sommer (Leipzig, 1846); the Swedish by G. E. Klemming (Stockholm, 1844). The English poem was also edited by Hartschorne (*English Metrical Tales*, 1829), by Laing (Abbotsford Club, 1829), and by Lumly (Early Eng. Text Soc., 1866, re-edited G. H. McKnight, 1901). J. Reinhold (*Floire et Blanchefleur*, Paris, 1906) suggests a parallelism with the story of Cupid and Psyche as

told by Apuleius; also that the oriental setting does not necessarily imply a connexion with Arab tales, as the circumstances might with small alteration have been taken from the Vulgate version of the book of Esther.

FLORENCE, WILLIAM JERMYN (1831–1891), American actor, of Irish descent, whose real name was Bernard Conlin, was born on the 26th of July 1831 at Albany, N.Y., and first attracted attention as an actor at Brougham's Lyceum in 1851. Two years later he married Mrs Malvina Pray Littel (*d.* 1906), in association with whom, until her retirement in 1889, he won all his successes, notably in Benjamin Woolf's *The Mighty Dollar*, said to have been presented more than 2500 times. In 1856 they had a successful London season, Mrs Florence being one of the first American actresses to appear on the English stage. In 1889 Florence entered into partnership with Joseph Jefferson, playing Sir Lucius O'Trigger to his Bob Acres and Mrs John Drew's Mrs Malaprop on a very successful tour. His last appearance was with Jefferson on the 14th of November 1891, as Ezekiel Homespun in *The Heir-at-law*, and he died on the 18th of November in Philadelphia.

FLORENCE OF WORCESTER (d. 1118), English chronicler, was a monk of Worcester, who died, as we learn from his continuator, on the 7th of July 1118. Beyond this fact nothing is known of his life. He compiled a chronicle called *Chronicon ex chronicis* which begins with the creation and ends in 1117. The basis of his work was a chronicle compiled by Marianus Scotus, an Irish recluse, who lived first at Fulda, afterwards at Mainz. Marianus, who began his work after 1069, carried it up to 1082. Florence supplements Marianus from a lost version of the English Chronicle, and from Asser. He is always worth comparing with the extant English Chronicles; and from 1106 he is an independent annalist, dry but accurate. Either Florence or a later editor of his work made considerable borrowings from the first four books of Eadmer's *Historia novorum*. Florence's work is continued, up to 1141, by a certain John of Worcester, who wrote about 1150. John is valuable for the latter years of Henry I. and the early years of Stephen. He is friendly to Stephen, but not an indiscriminate partisan.

The first edition of these two writers is that of 1592 (by William Howard). The most accessible is that of B. Thorpe (*Eng. Hist. Soc.*, 2 vols., 1848–1849); but Thorpe's text of John's continuation needs revision. Thorpe gives, without explanations, the insertions of an ill-informed Gloucester monk who has obscured the accurate chronology of the original. Thorpe also prints a continuation by John Taxter (died c. 1295), a 13th-century writer and a monk of Bury St Edmunds. Florence and John of Worcester are translated by J. Stevenson in his *Church Historians of England*, vol. ii. pt. i. (London, 1853); T. Forester's translation in Bohn's *Antiquarian Library* (London, 1854) gives the work of Taxter also. (H. W. C. D.)

FLORENCE, the county-seat of Lauderdale county, Alabama, U.S.A., on the N. bank of the Tennessee river, at the foot of Muscle Shoals Canal, and about 560 ft. above sea-level. Pop. (1880) 1359; (1890) 6012; (1900) 6478 (1952 negroes); (1910) 6689. It is served by the Southern, the Northern Alabama (controlled by the Southern), and the Louisville & Nashville railways, and by electric railway to Sheffield and Tusculumbia, and the Tennessee river is here navigable. Florence is situated in the fertile agricultural lands of the Tennessee river valley on the edge of the coal and iron districts of Alabama, and has various manufactures, including pig-iron, cotton goods, wagons, stoves, fertilizers, staves and mercantile supplies. At Florence are the state Normal College, the Florence University for Women, and the Burrell Normal School (for negroes; founded in 1903 by the American Missionary Association). Florence was founded in 1818, Andrew Jackson, afterwards president of the United States, and ex-president James Madison being among the early property holders. For several years Florence and Nashville, Tennessee, were commercial rivals, being situated respectively at the head of navigation on the Tennessee and Cumberland rivers. The first invasion of Alabama by Federal troops in the Civil War was by a gunboat raid up the Tennessee to Florence on the 8th of February 1862. On the 11th of April 1863 another Federal gunboat raid was attempted, but the vessels were repulsed by a force under Gen. S. A. Wood. On the 26th

¹ Ed. H. Suchier (Paderborn, 1878, 5th ed. 1903); modern French by G. Michaut, with preface by J. Bédier (Tours, 1901); English by Andrew Lang (1887), by F. W. Bourdillon (Oxford, 1896), and by Laurence Housman (1902).

of May following, Federal troops entered Florence, and destroyed cotton mills and public and private property; but they were driven back by Gen. Philip D. Roddy (1820-1897). On the 11th of December 1863 the town was again raided, but the Federals did not secure permanent possession. Florence was chartered as a city in 1889.

FLORENCE (Ital. *Firenze*, Lat. *Florentia*), formerly the capital of Tuscany, now the capital of a province of the kingdom of Italy, and the sixth largest city in the country. It is situated 43° 46' N., 11° 14' E., on both banks of the river Arno, which at this point flows through a broad fertile valley enclosed between spurs of the Apennines. The city is 165 ft. above sea-level, and occupies an area of 3 sq. m. (area of the commune, 16½ sq. m.). The geological formation of the soil belongs to the Quaternary and Pliocene period in its upper strata, and to the Eocene and Cretaceous in the lower. *Pietra forte* of the Cretaceous period is quarried north and south of the city, and has been used for centuries as paving stone and for the buildings. *Pietra serena* or *macigno*, a stone of a firm texture also used for building purposes, is quarried at Monte Ceceri below Fiesole. The soil is very fertile; wheat, Indian corn, olives, vines, fruit trees of many kinds cover both the plain and the surrounding hills; the chief non-fruit-bearing trees are the stone pine, the cypress, the ilex and the poplar, while many other varieties are represented. The gardens and fields produce an abundance of flowers, which justify the city's title of *la città dei fiori*.

Climate and Sanitary Conditions.—The climate of Florence is very variable, ranging from severe cold accompanied by high winds from the north in winter to great heat in the summer, while in spring-time sudden and rapid changes of temperature are frequent. At the same time the climate is usually very agreeable from the end of February to the beginning of July, and from the end of September to the middle of November. The average temperature throughout the year is about 57° Fahr.; the maximum heat is about 96·8°, and the minimum 36·5°, sometimes sinking to 21°. The longest day is 15 hours and 33 minutes, the shortest 8 hours and 50 minutes. The average rainfall is about 37½ inches. Epidemic diseases are rare and children's diseases mild; cholera has visited Florence several times, but the city has been free from it for many years. Diphtheria first appeared in 1868 and continued as a severe epidemic until 1872, since when it has only occurred at rare intervals and in isolated cases. Typhoid, pneumonia, tuberculosis, measles and scarlatina, and influenza are the commonest illnesses. The drainage system is still somewhat imperfect, but the water brought from the hills or from the Arno in pipes is fairly good, and the general sanitary conditions are satisfactory.

Public Buildings.—Of the very numerous Florentine churches the Duomo (Santa Maria del Fiore) is the largest and most important, founded in 1298 on the plans of Arnolfo di Cambio, completed by Brunelleschi, and consecrated in 1436; the façade, however, was not finished until the 19th century—it was begun in 1875 on the designs of de Fabris and unveiled in 1888. Close by the Duomo is the no less famous Campanile built by Giotto, begun in 1332, and adorned with exquisite bas-reliefs. Opposite is the Baptistery built by Arnolfo di Cambio in the 13th century on the site of an earlier church, and adorned with beautiful bronze doors by Ghiberti in the 15th century. The Badia, Santo Spirito, Santa Maria Novella, are a few among the many famous and beautiful churches of Florence. The existence of these works of art attracts students from all countries, and a German art school subsidized by the imperial government has been instituted.

The streets and piazze of the city are celebrated for their splendid palaces, formerly, and in many cases even to-day the residences of the noble families of Florence. Among others we may mention the Palazzo Vecchio, formerly the seat of the government of the Republic and now the town hall, the Palazzo Riccardi, the residence of the Medici and now the prefecture, the palaces of the Strozzi, Antinori (one of the most perfect specimens of Florentine *quattrocento* architecture), Corsini, Davanzati, Pitti (the royal palace), &c. The palace of the Arte della Lana or

guild of wool merchants, tastefully and intelligently restored, is the headquarters of the Dante Society. The centre of Florence, which was becoming a danger from a hygienic point of view, was pulled down in 1880-1890, but, unfortunately, sufficient care was not taken to avoid destroying certain buildings of historic and artistic value which might have been spared without impairing the work of sanitation, while the new structures erected in their place, especially those in the Piazza Vittorio Emanuele, are almost uniformly ugly and quite out of keeping with Florentine architecture. The question aroused many polemics at the time both in Italy and abroad. After the new centre was built, a society called the *Società per la difesa di Firenze antica* was formed by many prominent citizens to safeguard the ancient buildings and prevent them from destruction, and a spirit of intelligent conservatism seems now to prevail in this connexion. The city is growing in all directions, and a number of new quarters have sprung up where the houses are more sanitary than in the older parts, but unfortunately few of them evince much aesthetic feeling. The *viali* or boulevards form pleasant residential streets with gardens, and the system of building separate houses for each family (*villini*) instead of large blocks of flats is becoming more and more general.

Florence possesses four important libraries besides a number of smaller collections. The *Biblioteca Nazionale*, originally founded by Antonio Magliabecchi in 1747, enjoys the right, shared by the *Vittorio Emanuele* library of Rome, of receiving a copy of every work printed in Italy, since 1870 (since 1848 it had enjoyed a similar privilege with regard to works printed in Tuscany). It contains some 500,000 printed volumes, 700,000 pamphlets, over 9000 prints and drawings (including 284 by Albert Dürer), nearly 20,000 MSS., and 40,000 letters. The number of readers in 1904 was over 50,000. Unfortunately, however, the confusion engendered by a defective organization has long been a byword among the people; there is no printed catalogue, quantities of books are buried in packing-cases and unavailable, the collection of foreign books is very poor, hardly any new works being purchased, and the building itself is quite inadequate and far from safe; but the site of a new one has now been purchased and the plans are agreed upon, so that eventually the whole collection will be transferred to more suitable quarters. The *Biblioteca Marucelliana*, founded in 1752, contains 150,000 books, including 620 incunabula, 17,000 engravings and 1500 MSS.; it is well managed and chiefly remarkable for its collection of illustrated works and art publications. The *Biblioteca Mediceo-Laurenziana*, founded in 1571, has its origin in the library of Cosimo de' Medici the Elder, and was enlarged by Piero, Giovanni and above all by Lorenzo the Magnificent. Various princes and private persons presented it with valuable gifts and legacies, among the most important of which was the collection of *editiones principes* given by Count d'Elci, in 1841, and the Ashburnham collection of MSS. purchased by the Italian Government in 1885. It contains nearly 10,000 MSS., including many magnificent illuminated missals and Bibles and a number of valuable Greek and Latin texts, 242 incunabula and 11,000 printed books, chiefly dealing with palaeography; it is in some ways the most important of the Florentine libraries. The *Biblioteca Riccardiana*, founded in the 16th century by Romolo Riccardi, contains nearly 4000 MSS., over 32,000 books and 650 incunabula, chiefly relating to Florentine history. The state archives are among the most complete in Italy, and contain over 450,000 *filze* and *registri* and 126,000 charters, covering the period from 726 to 1856.

Few cities are as rich as Florence in collections of works of artistic and historic interest, although the great majority of them belong to a comparatively limited period—from the 13th to the 16th century. The chief art galleries are the Uffizi, the Pitti and Accademia. The two former are among the finest in the world, and are filled with masterpieces by Raphael, Andrea del Sarto, Perugino, Ghirlandaio, Botticelli, the Lippi, and many other Florentine, Umbrian, Venetian, Dutch and Flemish artists, as well as numerous admirable examples of antique, medieval and Renaissance

*Galleries
of Fine
Arts and
Museums.*

sculpture. The Pitti collection is in the royal palace (formerly the residence of the grand dukes), and a fine new stairway and vestibule have been constructed by royal munificence. In the Uffizi the pictures are arranged in strict chronological order. In the Accademia, which is rich in early Tuscan masters, the Botticelli and Perugino rooms deserve special mention. Other pictures are scattered about in the churches, monasteries and private palaces. Of the monasteries, that of St Mark should be mentioned, as containing many works of Fra Angelico, besides relics of Savonarola, while of the private collections the only one of importance is that of Prince Corsini. There is a splendid museum of medieval and Renaissance antiquities in the Bargello, the ancient palace of the Podestà, itself one of the finest buildings in the city; among its many treasures are works of Donatello, Ghiberti, Verrocchio and other sculptors, and large collections of ivory, enamel and bronze ware. The Opera del Duomo contains models and pieces of sculpture connected with the cathedral; the Etruscan and Egyptian museum, the gallery of tapestries, the Michelangelo museum, the museum of natural history and other collections are all important in different ways.

The total population of Florence in 1905, comprising foreigners and a garrison of 5500 men, was 220,879. In 1861 it was 114,363; it increased largely when the capital of Italy was in Florence (1865-1872), but decreased or increased very slightly after the removal of the capital to Rome, and increased at a greater rate from 1881 onwards. At present the rate of increase is about 22 per 1000, but it is due to immigration, as the birth rate was actually below the death rate down to 1903, since when there has been a slight increase of the former and a decrease of the latter.

Florence is the capital of a province of the same name, and the central government is represented by a prefect (*prefetto*), while local government is carried on by a mayor (*sindaco*) and an elective town council (*consiglio comunale*). The city is the seat of a court of cassation (for civil cases only), of a court of appeal, besides minor tribunals. It is the headquarters of an army corps, and an archiepiscopal see.

There are 22 public elementary schools for boys and 18 for girls (education being compulsory and gratuitous), with about 20,000 pupils, and 56 private schools with 5700 pupils. Secondary education is provided by one higher and four lower technical schools with 1375 pupils, three *ginnasii* or lower classical schools, and three *licei* or higher classical schools, with 1000 pupils, and three training colleges with over 700 pupils. Higher education is imparted at the university (*Istituto di studii superiori e di perfezionamento*), with 600 to 650 students; although only comprising the faculties of literature, medicine and natural science, it is, as regards the first-named faculty, one of the most important institutions in Italy. The original *Studio Fiorentino* was founded in the 14th century, and acquired considerable fame as a centre of learning under the Medici, enhanced by the presence in Florence of many learned Greeks who had fled from Constantinople after its capture by the Turks (1453). Although in 1472 some of the faculties and several of the professors were transferred to Pisa, it still retained importance, and in the 17th and 18th centuries it originated a number of learned academies. In 1859 after the annexation of Tuscany to the Italian kingdom it was revived and reorganized; since then it has become to some extent a national centre of learning and culture, attracting students from other parts of Italy, partly on account of the fact that it is in Florence that the purest Italian is spoken. The revival of classical studies on scientific principles in modern Italy may be said to have begun in Florence, and great activity has also been displayed in reviving the study of Dante, Dante lectures being given regularly by scholars and men of letters from all parts of the country, above the church of Or San Michele as in the middle ages, under the auspices of the *Società Dantesca*. Palaeography, history and Romance languages are among the other subjects to which especial importance is given. Besides the *Istituto di studii superiori* there is the *Istituto di scienze sociali* "Cesare Alfieri," founded by the marchese Alfieri di Sostegno for the education of aspirants to the diplomatic and consular services, and for students of economics and social sciences (about 50 students); an academy of fine arts, a conservatoire of music, a higher female training-college with 150 students, a number of professional and trade schools, and an academy of recitation. There are also many academies and learned societies of different kinds, of which one of the most important is the *Accademia della Crusca* for the study of the Italian language, which undertook the publication of a monumental dictionary.

Several of the Florence hospitals are of great antiquity, the most

important being that of Santa Maria Nuova, which, founded by Folco Portinari, the father of Dante's Beatrice, has been thoroughly renovated according to modern scientific principles. There are numerous other hospitals both general and special, a founding hospital dating from the 13th century (Santa Maria degli Innocenti), an institute for the blind, one for the deaf and dumb, &c. Most of the hospitals and other charitable institutions are endowed, but the endowments are supplemented by private contributions.

Florence is the centre of a large and fertile agricultural district, and does considerable business in wine, oil and grain, and supplies the neighbouring peasantry with goods of all kinds. There are no important industries, except a few flour-mills, some glass works, iron foundries, a motor car factory, straw hat factories, and power-houses supplying electricity for lighting and for the numerous tramcars. There are, however, some artistic industries in and around the city, of which the most important is the Ginori-Richard porcelain works, and the Cantagalli majolica works. There are many other smaller establishments, and the Florentine artificer seems to possess an exceptional skill in all kinds of work in which art is combined with technical ability. Another very important source of revenue is the so-called "tourist industry," which in late years has assumed immense proportions; the city contains a large number of hotels and boarding-houses which every year are filled to overflowing with strangers from all parts of the world. (L. V. *)

HISTORY

Florentia was founded considerably later than *Faesulae* (Fiesole), which lies on the hill above it; indeed, as its name indicates, it was built only in Roman times and probably in connexion with the construction by C. Flaminius in 187 B.C. of a road from Bononia to Arretium (which later on formed part of the Via Cassia) at the point where this road crossed the river Arnus. We hear very little of it in ancient times; it appears to have suffered at the end of the war between Marius and Sulla, and in A.D. 15 (by which period it seems to have been already a colony) it successfully opposed the project of diverting part of the waters of the Clanis into the Arno (see CHIANA). Tacitus mentions it, and Florus describes it as one of the *municipia splendidissima*. A bishop of Florence is mentioned in A.D. 313. A group of Italic cremation tombs a *pozzo* of the Villanova period were found under the pavement of the medieval Vicolo del Campidoglio. This took its name from the *Capitolium* of Roman times, the remains of which were found under the Piazza Luna; the three *cellae* were clearly traceable. The capitals of the columns were Corinthian, about 4 ft. in diameter, and it became clear that this temple had supplied building materials for S. Giovanni and S. Miniato. Fragments of a fine octagonal altar, probably belonging to the temple, were found. Remains of baths have been found close by, while the ancient amphitheatre has been found near S. Croce outside the Roman town, which formed a rectangle of about 400 by 600 yds., with four gates, the *Decumanus* being represented by the Via Strozzi and Via del Corso, and the *Cardo* by the Via Calcinara, while the Mercato Vecchio occupied the site of the Forum.

See L. A. Milani, "Reliquie di Firenze antica," in *Monumenti dei Lincei*, vi. (1896), 5 seq. (T. As.)

The first event of importance recorded is the siege of the city by the Goths, A.D. 405, and its deliverance by the Roman general Stilicho. Totila besieged Florence in 542, but was repulsed by the imperial garrison under Justin, and later it was occupied by the Goths. We find the Longobards in Tuscany in 570, and mention is made of one *Gudibrandus Dux civitatis Florentinorum*, which suggests that Florence was the capital of a duchy (one of the regular divisions of the Longobard empire). Charlemagne was in Florence in 786 and conferred many favours on the city, which continued to grow in importance owing to its situation on the road from northern Italy to Rome. At the time of the agitation against simony and the corruption of the clergy, the head of the movement in Florence was San Giovanni Gualberto, of the monastery of San Salvi. The simoniacal election of Pietro Mezzabarba as bishop of Florence (1068) caused serious disturbances and a long controversy with Rome, which ended in the triumph, after a trial by fire, of the monk Petrus Igneus, champion of the popular reform movement; this event indicates the beginnings of a popular conscience among the Florentines.

Under the Carolingian emperors Tuscany was a March or margraviate, and the marquises became so powerful as to be even a danger to the Empire. Under the emperor Otto I. one Ugo (d. 1001) was marquis, and the emperor Conrad II. (elected in 1024) appointed Boniface of Canossa marquis of Tuscany, a territory then extending from the Po to the borders of the Roman state. Boniface died in 1052, and in the following year

The countess Matilda. the margraviate passed to his daughter, the famous countess Matilda, who ruled for forty years and played a prominent part in the history of Italy in that period.

In the Wars of the Investitures Matilda was ever on the papal (afterwards called Guelph) side against the emperor and the faction afterwards known as Ghibelline, and she herself often led armies to battle. It is at this time that the people of Florence first began to acquire influence, and while the countess presided at the courts

Guelphs and Ghibellines. of justice in the name of the Empire, she was assisted by a group of great feudal nobles, judges, lawyers, &c., who formed, as elsewhere in Tuscany, the *boni homines* or *sapientes*. As the countess was frequently absent these *boni homines* gave judgment without her, thus paving the way for a free commune. The citizens found themselves in opposition to the nobility of the hills around the city, Teutonic feudatories of Ghibelline sympathies, who interfered with their commerce. Florence frequently waged war with these nobles and with other cities on its own account, although in the name of the countess, and the citizens began to form themselves into groups and associations which were the germs of the *arti* or gilds. After the death of

Beginnings of the commune. Countess Matilda in 1115 the *grandi* or *boni homines* continued to rule and administer justice, but in the name of the people—a change hardly noticed at first, but which marks the foundation of the commune.

After 1138 the *boni homines* began to be called *consules*, while the population was divided into the *grandi* or *delle torri*, i.e. the noble families who had towers, and the *arti* or trade and merchant gilds. At first the *consules*, of whom there seem to have been twelve, two for each *sestiere* or ward, were chosen by the men of the towers, and assisted by a council of 100 *boni homines*, in which the *arti* were predominant; the government thus came to be in the hands of a few powerful families. The republic now proceeded to extend its power. In 1125 Fiesole was sacked and destroyed, but the feudal nobles of the *contado* (surrounding country), protected by the imperial margraves, were still powerful. The early margraves had permitted the Florentines to wage war against the Alberti family, whose castles they destroyed. The emperor Lothair when in Italy forced Florence to submit to his authority, but at his death in 1137 things returned to their former state and the Florentines fought successfully against the powerful counts Guidi. Frederick Barbarossa, however, elected emperor in 1152, made his authority felt in Tuscany, and appointed one Welf of Bavaria as margrave. Florence and other cities were forced to supply troops to the emperor for his Lombard campaigns, and he began to establish a centralized imperial bureaucracy in Tuscany, appointing a *potestas*, who resided at San Miniato (whence the name of "San Miniato al Tedesco"), to represent him and exercise authority in the *contado*; this double authority of the *consoli* in the town and the *potestas* or *podestà* outside generated confusion. By 1176 the Florentines were masters of all the territory comprised in the dioceses of

War with the nobles. Florence and Fiesole; but civil commotion within the city broke out between the *consoli* and the greater nobles, headed by the Alberti and strengthened by the many feudal families who had been forced to leave their castles and dwell in the city (1177–1180). In the end the Alberti, though not victorious, succeeded in getting occasionally admitted to the consulship. Florence now formed a league with the chief cities of Tuscany, made peace with the Guidi, and humbled the Alberti whose castle of Semifonte was destroyed (1202). Later

The potestas. we find a *potestas* within the city, elected for a year and assisted by seven councillors and seven *rectores super capitibus artium*. This represented the triumph of the feudal party, which had gained the support of the *arti*

minori or minor gilds. The *potestates* subsequently were foreigners, and in 1207 the dignity was conferred on Guelfredotto of Milan; a new council was formed, the *consiglio del comune*, while the older senate still survived. The Florentines now undertook to open the highways of commerce towards Rome, for their city was already an important industrial and banking centre.

Discord among the great families broke out again, and the attempt to put an end to it by a marriage between Buondelmonte de' Buondelmonti and a daughter of the Amidei, only led to further strife (1215), although the causes of these broils were deeper and wider, being derived from the general division between Guelphs and Ghibellines all over Italy. But the work of crushing the nobles of the *contado* and of asserting the city's position among rival communes continued. In 1222 Florence waged war successfully on Pisa, Lucca and Pistoia, and during the next few years against the Sieneze with varying results; although the emperor supported the latter as Ghibellines, on his departure for Germany in 1235 they were forced to accept peace on onerous terms. During the interregnum (1241–1243) following on the death of Pope Gregory IX. the Ghibelline cause revived in Tuscany and imperial authority was re-established. The tumults against the Paterine heretics (1244–1245), among whom were many Ghibelline nobles favoured by the *podestà* Pace di Pesamigola, indicate a successful Guelphic reaction; but Frederick II., having defeated his enemies both in Lombardy and in the Two Sicilies, appointed his natural son, Frederick of Antioch, imperial vicar in Tuscany, who, when civil war broke out, entered the city with 1600 German knights. The Ghibellines now triumphed completely, and in 1249 the Guelph leaders were driven into exile—the first of many instances in Florentine history of exile

Comane and popolo. *en masse* of a defeated party. The attempt to seize Montevarchi and other castles where the Guelph exiles were congregated failed, and in 1250 the burghers elected thirty-six *caporali di popolo*, who formed the basis of the *primo popolo* or body of citizens independent of the nobles, headed by the *capitano del popolo*. The Ghibellines being unable to maintain their supremacy, the city came to be divided into two almost autonomous republics, the *comune* headed by the *podestà*, and the *popolo* headed by the *capitano* and militarily organized into twenty companies; the central power was represented by twelve *anziani* or elders. The *podestà*, who was always a foreigner, usually commanded the army, represented the city before foreign powers, and signed treaties. He was assisted by the *consiglio speciale* of 90 and the *consiglio generale e speciale* of 300, composed of nobles, while the *capitano del popolo* had also two councils composed of burghers, heads of the gilds, *gonfalonieri* of the companies, &c. The *anziani* had a council of 36 burghers, and then there was the *parlamento* or general assembly of the people, which met only on great occasions. At this time the *podestà's* palace (the Bargello) was built, and the gold florin was first coined and soon came to be accepted as the standard gold piece throughout Europe. But, although greatly strengthened, the Guelphs, who now may be called the democrats as opposed to the Ghibelline aristocrats, were by no means wholly victorious, and in 1251 they had to defend themselves against a league of Ghibelline cities (Siena, Pisa and Pistoia) assisted by Florentine Ghibellines; the Florentine Uberti, who had been driven into exile after their plot of 1258, took refuge in Siena and encouraged that city in its hostility to Florence. Fresh disputes about the possession of Montepulciano and other places having arisen, the Florentines declared war once more. A Florentine army assisted by Guelphs of other towns was cunningly induced to believe that Siena would surrender at the first summons; but it was met by a Sieneze army reinforced by Florentine exiles, including Farinata degli Uberti and other Ghibellines, and by the cavalry of Manfred (*q.v.*) of Sicily, led by Count Giordano and the count of Arras, with the result that the Florentines were totally routed at Montaperti on the 4th of September 1260. Count Giordano entered Florence, appointed Count Guido Novello *podestà*, and began a series of persecutions

Battle of Montaperti (1260).

against the Guelphs. The Ghibellines even proposed to raze the walls of the city, but Farinata degli Uberti strongly opposed the idea, saying that "he had fought to regain and not to ruin his fatherland."

During this new Ghibelline predominance (1260-1266) the old liberties were abolished, and the *popolo* was deprived of all share in the administration. But when Charles I. (q.v.) of Anjou descended into Italy as champion of the papacy, and Manfred was defeated and killed (1266), the *popolo*, who had acquired wealth in trade and industry, was ready to rise. After some disturbances Guido Novello and the Ghibellines were expelled, but it was not the *popolo* who triumphed; the pope and Charles were the real masters of the situation, and the Florentines found they had exchanged a foreign and Ghibelline protector for one who was foreign and Guelph. Nevertheless much of the old order was restored; the *podestà* who represented King Charles was assisted by 12 *buoni uomini*, and by the council of the 100 *buoni uomini del popolo*, "without the deliberation of whom," says Villani, "no great matter nor expenditure could be undertaken." Other bodies and magistrates were maintained, and the *capitano del popolo*, now called *capitano della massa di parte Guelpha*, tended to become a very important person. The property of the Ghibellines was confiscated, and a commission of six *capitani di parte Guelpha* appointed to administer it and in general to expend it for the persecution of the Ghibellines. The whole constitution of the republic, although of very democratic tendencies, seemed designed to promote civil strife and weaken the central power.

While the constitution was evolving in a manner which seemed to argue small political ability and no stability in the Florentines, the people had built up a wonderful commercial organization. Each of the seven *arti maggiori* or greater guilds was organized like a small state with its councils, statutes, assemblies, magistrates, &c., and in times of trouble constituted a citizen militia. Florentine cloth especially was known and sold all over Europe, and the Florentines were regarded as the first merchants of the age. If the life of the city went on uninterruptedly even during the many changes of government and the almost endemic civil war, it was owing to the solidity of the guilds, who could carry on the administration without a government.

After Charles's victory over Conradin in 1268 the Florentines defeated the Sieneze (1269) and made frequent raids into Pisan territory. As Charles perpetually interfered in their affairs, always favouring the *grandi* or Guelph nobles, some of the Ghibellines were recalled as a counterpoise, which, however, only led to further civil strife. Rudolph of Habsburg, elected king of the Romans in 1273, having come to terms with Pope Nicholas III., Charles was obliged in 1278 to give up his title of imperial vicar in Tuscany, which he had held during the interregnum following on the death of Frederick II. In 1279 Pope Nicholas sent his nephew, the friar preacher Latino Frangipani Malabranca, whom he had created cardinal bishop of Ostia the same year, to reconcile the parties in Florence once more. Cardinal Latino to some extent succeeded, and was granted a kind of temporary dictatorship. He raised the 12 *buoni uomini* to 14 (8 Guelphs and 6 Ghibellines), to be changed every two months; and they were assisted by a council of 100. A force of 1000 men was placed at the disposal of the *podestà* and *capitano* (now both elected by the people) to keep order and oblige the *grandi* to respect the law. The Sicilian Vespers (q.v.) by weakening Charles strengthened the commune, which aimed at complete independence of emperors, kings and popes. After 1282 the *signoria* was composed of the 3 (afterwards 6) *priori* of the guilds, who ended by ousting the *buoni uomini*, while a *defensor artificum et artium* takes the place of the *capitano*; thus the republic became an essentially trading community, governed by the *popolani grassi* or rich merchants.

The republic now turned to the task of breaking the power of the Ghibelline cities of Pisa and Arezzo. In 1289 the Aretini were completely defeated by the Florentines at Campaldino, a

battle made famous by the fact that Dante took part in it. War against the Pisans, who had been defeated by the Genoese in the naval battle of La Meloria in 1284, was carried on in a desultory fashion, and in 1293 peace was made. But the *grandi*, who had largely contributed to the victory of Campaldino, especially men like Corso Donati and Vieri de' Cerchi, were becoming more powerful, and Charles had increased their number by creating a great many knights; but their attempts to interfere with the administration of justice were severely repressed, and new laws were passed to reduce their influence. Among other internal reforms the abolition of the last traces of servitude in 1289, and the increase in the number of *arti*, first to 12 and then to 21 (7 *maggiori* and 14 *minori*) must be mentioned. This, however, was not enough for the Florentine democracy, who viewed with alarm the increasing power and arrogance of the *grandi*, who in spite of their exclusion from many offices were still influential and constituted independent clans within the state. The law obliged each member of the clan (*consorteria*) to *sodare* for all the other members, i.e. to give a pecuniary guarantee to ensure payment of fines for offences committed by any one of their number, a provision made necessary by the fact that the whole clan acted collectively. But as the laws were not always enforced new and severe ones were enacted. These were the famous *Ordinamenti della Giustizia* of 1293, by which all who were not of the *arti* were definitely excluded from the signory. The *priori* were to remain in office two months and elected the *gonfaloniere*, also for two months; there were the *capitadini* or councils of the guilds, and two *savi* for each *sestiere*, with 1000 soldiers at their disposal; the number of the *grandi* families was fixed at 38 (later 72). Judgment in matters concerning the *Ordinamenti* was delivered in a summary fashion without appeal. The leading spirit of this reform was Giano della Bella, a noble who by engaging in trade had become a *popolano*; the *grandi* now tried to make him unpopular with the *popolani grassi*, hoping that without him the *Ordinamenti* would not be executed, and opened negotiations with Pope Boniface VIII. (elected 1294), who aimed at extending his authority in Tuscany. A signory adverse to Giano having been elected, he was driven into exile in 1295. The *grandi* regained some of their power by corrupting the *podestà* and by the favour of the *popolo minuto* or unorganized populace; but their quarrels among themselves prevented them from completely succeeding, while the *arti* were solid.

In 1295 a signory favourable to the *grandi* enacted a law attenuating the *Ordinamenti*, but now the *grandi* split into two factions, one headed by the Donati, which hoped to abolish the *Ordinamenti*, and the other by the Cerchi, which had given up all hope of their abolition; afterwards these parties came to be called *Neri* (Blacks) and *Bianchi* (Whites). A plot of the Donati to establish their influence over Florence with the help of Boniface VIII. having been discovered (May 1300), serious riots broke out between the *Neri* and the *Bianchi*. The pope's attempt to unite the *grandi* having failed, he summoned Charles of Valois to come to his assistance, promising him the imperial crown; in 1301 Charles entered Italy, and was created by the pope *paciario* or peace-maker of Tuscany, with instructions to crush the *Bianchi* and the *popolo* and exalt the *Neri*. On the 1st of November Charles reached Florence, promising to respect its laws; but he permitted Corso Donati and his friends to attack the *Bianchi*, and the new *podestà*, Cante dei Gabrielli of Gubbio, who had come with Charles, punished many of that faction; among those whom he exiled was the poet Dante (1302). Corso Donati, who for some time was the most powerful man in Florence, made himself many enemies by his arrogance, and was obliged to rely on the *popolo grasso*, the irritation against him resulting in a rising in which he was killed (1308). In this same year Henry of Luxemburg was elected king of the Romans and with the pope's favour he came to Italy in 1310; the Florentine exiles and all the Ghibellines of Italy regarded him as a saviour and regenerator of the country, while the Guelphs of Florence on the contrary opposed

Battle of Campaldino
(1289).

Ordinamenti della Giustizia
(1293).

Florentine trade and the guilds.

Cardinal Latino.

The Bianchi and the Neri.

both him and the pope as dangerous to their own liberties and accepted the protection of King Robert of Naples, disregarding Henry's summons to submission. In 1312 Henry was crowned emperor as Henry VII. in Rome, but instead of the universal ruler and pacifier which he tried to be, he was forced by circumstances into being merely a German kaiser who tried to subjugate free Italian communes. He besieged Florence without success, and died of disease in 1313.

The Pisans, fearing the vengeance of the Guelphs now that Henry was dead, had accepted the lordship of Ugucione della Fagginola, imperial vicar in Genoa. A brave general and an ambitious man, he captured Lucca and defeated the Florentines and their allies from Naples at Montecatini in 1315, but the following year he lost both Pisa and Lucca and had to fly from Tuscany. A new danger now threatened Florence in the person of Castruccio Castracani degli Antelminelli (*q.v.*), who made himself lord of Lucca and secured help from Matteo Visconti, lord of Milan, and other Ghibellines of northern Italy. Between 1320 and 1323 he harried the Florentines and defeated them several times, captured Pistoia, devastated their territory up to the walls of the city in spite of assistance from Naples under Raymundo de Cardona and the duke of Calabria (King Robert's son); never before had Florence been so humiliated, but while Castruccio was preparing to attack Florence he died in 1328. Two months later the duke of Calabria, who had been appointed protector of the city in 1325, died, and further constitutional reforms were made. The former councils were replaced by the *consiglio del popolo*, consisting of 300 *popolani* and presided over by the *capitano*, and the *consiglio del comune* of 250 members, half of them nobles and half *popolani*, presided over by the *podestà*. The *priori* and other officers were drawn by lot from among the Guelphs over thirty years old who were declared fit for public office by a special board of 98 citizens (1329). The system worked well at first, but abuses soon crept in, and many persons were unjustly excluded from office; trouble being expected in 1335 a captain of the guard was created. But the first one appointed, Jacopo dei Gabrielli of Gubbio, used his dictatorial powers so ruthlessly that at the end of his year of office no successor was chosen.

The Florentines now turned their eyes towards Lucca; they might have acquired the city immediately after Castruccio's death for 80,000 florins, but failed to do so owing to differences of opinion in the signory; Martino della Scala, lord of Verona, promised it to them in 1335, but broke his word, and although their finances were not then very flourishing they allied themselves with Venice to make war on him. They were successful at first, but Venice made a truce with the Scala independently of the Florentines, and by the peace of 1339 they only obtained a part of Lucchese territory. At the same time they purchased from the Tarlati the protectorate over Arezzo for ten years. But misfortunes fell on the city: Edward III. of England repudiated the heavy debts contracted for his wars in France with the Florentine banking houses of Bardi and Peruzzi (1339), which eventually led to their failure and to that of many smaller firms, and shook Florentine credit all over the world; Philip VI. of France extorted large sums from the Florentine merchants and bankers in his dominions by accusing them of usury; in 1340 plague and famine wrought terrible havoc in Florence, and riots again broke out between the *grandi* and the *popolo*, partly on account of the late unsuccessful wars and the unsatisfactory state of the finances. To put an end to these disorders, Walter of Brienne, duke of Athens, was elected "conservator" and captain of the guard in 1342. An astute, dissolute and ambitious man, half French and half Levantine, he began his government by a policy of conciliation and impartial justice which won him great popularity. But as soon as he thought the ground was secure he succeeded in getting himself acclaimed by the populace lord of Florence for life, and on the 8th of September was carried in triumph to the Palazzo della Signoria. The *podestà* and the *capitano* assenting to this treachery, he

dismissed the *gonfaloniere*, reduced the *priori* to a position of impotence, disarmed the citizens, and soon afterwards accepted the lordship of Arezzo, Volterra, Colle, San Gimignano and Pistoia. He increased his bodyguard to 800 men, all Frenchmen, who behaved with the greatest licence and brutality; by his oppressive taxes, and his ferocious cruelty towards all who opposed him, and the unsatisfactory treaties he concluded with Pisa, he accumulated bitter hatred against his rule. The *grandi* were disappointed because he had not crushed the *popolo*, and the latter because he had destroyed their liberties and interfered with the organization of the *arti*. Many unsuccessful plots against him were hatched, and having discovered one that was conducted by Antonio degli Adimari, the duke summoned the latter to the palace and detained him a prisoner. He also summoned 300 leading citizens on the pretext of wishing to consult them, but fearing treachery they refused to come. On the 26th of July 1343, the citizens rose in arms, demanded the duke's abdication, and besieged him in the palace. Help came to the Florentines from neighbouring cities, the *podestà* was expelled, and a *balìa* or provisional government of 14 was elected. The duke was forced to set Adimari and his other prisoners free, and several of his men-at-arms were killed by the populace; three of his chief henchmen, whom he was obliged to surrender, were literally torn to pieces, and finally on the 1st of August he had to resign his lordship. He departed from Florence under a strong guard a few days later, and the Fourteen cancelled all his enactments.

The expulsion of the duke of Athens was followed by several measures to humble the *grandi* still further, while the *popolo minuto* or artisans began to show signs of discontent at the rule of the merchants, and the populace destroyed the houses of many nobles. As soon as order was restored a *balìa* was appointed to reform the government, in which task it was assisted by the Sienese and Perugian ambassadors and by Simone da Battifolle. The *priori* were reduced to 8 (2 *popolani grassi*, 3 *mediani* and 3 *artifici minuti*), while the *gonfaloniere* was to be chosen in turn from each of those classes; the *grandi* were excluded from the administration, but they were still admitted to the *consiglio del comune*, the *cinque di mercanzia*, and other offices pertaining to the commune; the *Ordinamenti* were maintained but in a somewhat attenuated form, and certain *grandi* as a favour were declared to be of the *popolo*. Florence was now a thoroughly democratic and commercial republic, and its whole policy was mainly dominated by commercial considerations: its rivalry with Pisa was due to an ambition to gain secure access to the sea; its strong Guelphism was the outcome of its determination to secure the bank-business of the papacy, and its desire to extend its territory in Tuscany to the necessity for keeping open the land trade routes. Florentine democracy, however, was limited to the walls of the city, for no one of the *contado* nor any citizen of the subject towns enjoyed political rights, which were reserved for the inhabitants of Florence alone and not by any means for all of them.

Florence was in the 14th century a city of about 100,000 inhabitants, of whom 25,000 could bear arms; there were 110 churches, 39 religious houses; the shops of the *arte della lana* numbered over 200, producing cloth worth 1,200,000 florins; Florentine bankers and merchants were found all over the world, often occupying responsible positions in the service of foreign governments; the revenues of the republic, derived chiefly from the city customs, amounted to some 300,000 florins, whereas its ordinary expenses, exclusive of military matters and public buildings, were barely 40,000. It was already a centre of art and letters and full of fine buildings, pictures and libraries. But now that the *grandi* were suppressed politically, the lowest classes came into prominence, "adventurers without sense or virtue and of no authority for the most part, who had usurped public offices by illicit and dishonest practices" (Matteo Villani, iv. 60); this paved the way for tyranny.

In 1347 Florence was again stricken with famine, followed the next year by the most terrible plague it had ever experienced, which carried off three-fifths of the population (according to

Ugucione della Fagginola and Castruccio Castracani.

Attempt to capture Lucca.

The duke of Athens (1342-43).

New constitution.

Statistics.

Villani). Yet in spite of these disasters the republic was by no means crushed; it soon regained the suzerainty of many cities which had broken off all connexion with it after the expulsion of the duke of Athens, and purchased the overlordship of Prato from Queen

The Great Plague (1348).

Joanna of Naples, who had inherited it from the duke of Calabria. In 1351 Giovanni Visconti, lord and archbishop of Milan, having purchased Bologna and allied himself with sundry Ghibelline houses of Tuscany with a view to dominating Florence, the city made war on him, and in violation of its Guelph traditions placed itself under the protection of the emperor Charles IV. (1355) for his life-

War with Milan (1351).

time. This move, however, was not popular, and it enabled the *grandi*, who, although excluded from the chief offices, still dominated the *parte Guelfa*, to reassert themselves. They had in 1347 succeeded in enacting a very stringent law against all who were in any way tainted with Ghibellinism, which, they themselves being above suspicion in that connexion, enabled them to drive from office many members of the *popolo minuto*. In 1358 the *parte Guelfa* made these enactments still more stringent, punishing with death or heavy fines all who being Ghibellines held office, and provided that if trustworthy witnesses were forthcoming condemnations might be passed for this offence without hearing the accused; even a non-proved charge or an *ammonizione* (warning not to accept office) might entail disfranchisement. Thus the *parte*, represented by its 6 (afterwards 9) captains, came to exercise a veritable reign of terror, and no one knew when an accusation might fall on him. The leader of the *parte* was Piero degli Albizzi, whose chief rivals were the Ricci family.

Italy at this time began to be overrun by bands of soldiers of fortune. The first of these bands with whom Florence came into contact was the Great Company, commanded by the count of Lando, which twice entered Tuscany but was expelled both times by the Florentine troops (1358-1359).

In 1362 we find Florence at war with Pisa on account of commercial differences, and because the former had acquired the lordship of Volterra. The Florentines were successful until Pisa enlisted Sir John Hawkwood's English company; the latter won several battles, but were at last defeated at Cascina, and peace was made in 1364, neither side having gained much advantage. A fresh danger threatened the republic in 1367 when Charles IV., who had allied himself with Pope Urban V., Queen Joanna of Naples, and various north Italian despots to humble the Visconti, demanded that the Florentines should join the league. This they refused to do and armed themselves for defence, but eventually satisfied the emperor with a money payment.

The tyranny of the *parte Guelfa* still continued unabated, and the *capitani* carried an enactment by which no measure affecting the *parte* should be even discussed by the signory unless previously approved of by them. This infamous law, however, aroused so much opposition that some of the very men who had proposed it assembled in secret to discuss its abolition, and a quarrel between the Albizzi and the Ricci having weakened the *parte*, a *balìa* of 56 was agreed upon. Several of the Albizzi and the Ricci were excluded from office for five years, and a council called the Ten of Liberty was created to defend the laws and protect the weak against the strong. The *parte Guelfa* and the Albizzi still remained very influential and the attempts to abolish admonitions failed.

In 1375 Florence became involved in a war which showed how the old party divisions of Italy had been obliterated. The papal legate at Bologna, Cardinal Guillaume de Noellet

War with the church (1375-78).

(d. 1394), although the church was then allied to Florence, was meditating the annexation of the city to the Holy See; he refused a request of the Florentines for grain from Romagna, and authorized Hawkwood to devastate their territory. Although a large part of the people disliked the idea of a conflict with the church, an alliance with Florence's old enemy Bernabò Visconti was made, war declared, and a *balìa* of 8, the *Otto della guerra* (afterwards called the "Eight

Saints" on account of their good management) was created to carry on the campaign. Treaties with Pisa, Siena, Arezzo and Cortona were concluded, and soon no less than 80 towns, including Bologna, had thrown off the papal yoke. Pope Gregory XI. placed Florence under an interdict, ordered the expulsion of all Florentines from foreign countries, and engaged a ferocious company of Bretons to invade the republic's territory. The Eight levied heavy toll on church property and ordered the priests to disregard the interdict. They turned the tables on the pope by engaging Hawkwood, and although the Bretons by order of Cardinal Robert of Geneva (afterwards the anti-pope Clement VII.) committed frightful atrocities in Romagna, their captains were bribed by the republic not to molest its territory. By 1378 peace was made, partly through the mediation of St Catherine of Siena, and the interdict was removed in consideration of the republic's paying a fine of 200,000 florins to the pope.

During the war the Eight had been practically rulers of the city, but now the *parte Guelfa*, led by Lapo da Castiglionchio and Piero degli Albizzi, attempted to reassert itself by illicit interference in the elections and by a liberal use of "admonitions" (*ammonizioni*). Salvestro de' Medici, who had always opposed the *parte*, having been elected *gonfaloniere* in spite of its intrigues, proposed a law for the abolition of the admonitions, which was eventually passed (June 18, 1378), but the people had been aroused, and desired to break the power of the *parte* for good. Rioting occurred on the 21st of June, and the houses of the Albizzi and other nobles were burnt. The signory meanwhile created a *balìa* of 80 which repealed some of the laws promoted by the *parte*, and partly enfranchised the *ammoniti*. The people were still unsatisfied, the *arti minori* demanded further privileges, and the workmen insisted that their grievances against the *arti maggiori*, especially the wool trade by whom they were employed, be redressed. A large body of *ciompi* (wool carders)

Salvestro de' Medici.

gathered outside the city and conspired to subvert the signory and establish a popular government. Although the plot, in which Salvestro does not seem to have played a part, was revealed, a good deal of mob violence occurred, and on the 21st of July the populace seized the *podestà's* palace, which they made their headquarters. They demanded a share in the government for the *popolo minuto*, but as soon as this was granted Tommaso Strozzi, as spokesman of the *ciompi*, obliged the signory to resign their powers to the Eight. Once the people were in possession of the palace, a *ciompo* named Michele di Lando took the lead and put a stop to disorder and pillage. He remained master of Florence for one day, during which he reformed the constitution, probably with the help of Salvestro de' Medici. Three new guilds were created, and nine priors appointed, three from the *arti maggiori*, three from the *minori*, and three from the new ones, while each of these classes in turn was to choose the *gonfaloniere* of justice; the first to hold the office was Michele di Lando. This did not satisfy the *ciompi*, and the disorders provoked by them resulted in a new government which reformed the two councils so as to exclude the lower orders. But to satisfy the people several of the *grandi*, including Piero degli Albizzi, were put to death, on charges of conspiracy, and many others were exiled. There was perpetual rioting and anarchy, and interference in the affairs of the government by the working men, while at the same time poverty and unemployment increased owing to the timidity of capital and the disorders, until at last in 1382 a reaction set in, and order was restored by the guild companies. Again a new constitution was decreed by which the *gonfaloniere* and half the *priori* were to be chosen from the *arti maggiori* and the other half from the *minori*; on several other boards the former were to be in the majority, and the three new guilds were abolished. The demagogues were executed or forced to fly, and Michele di Lando with great ingratitude was exiled. Several subsequent risings of the *ciompi*, largely of an economic character, were put down, and the Guelph families gradually regained much of their lost power, of which

The riot of the ciompi (1378).

they availed themselves to exile their opponents and revive the odious system of *ammonizioni*.

Meanwhile in foreign affairs the republic maintained its position, and in 1383 it regained Arezzo by purchase from the lieutenant of Charles of Durazzo. In 1390 Gian Galeazzo Visconti, having made himself master of a large part of northern Italy, intrigued to gain possession of Pisa and Siena. Florence, alone in resisting him, engaged Hawkwood, who with an army of 7000 men more than held his own against the powerful lord of Milan, and in 1392 a peace was concluded which the republic strengthened by an alliance with Pisa and several north Italian states. In 1393 Maso degli Albizzi was made *gonfaloniere*, and for many years remained almost master of Florence owing to his influential position in the *Arte della Lana*. A severe persecution was initiated against the Alberti and other families, who were disfranchised and exiled. Disorders and conspiracies against the merchant oligarchy continued, and although they were unsuccessful party passion was incredibly bitter, and the exiles caused the republic much trouble by intriguing against it in foreign states. In 1397-1398 Florence had two more wars with Gian Galeazzo Visconti, who, aspiring to the conquest of Tuscany, acquired the lordship of Pisa, Siena and Perugia. Hawkwood being dead, Florence purchased aid from the emperor Rupert. The Imperialists were beaten; but just as the Milanese were about to march on Florence, Visconti died. His territories were then divided between his sons and his *condottieri*, and Florence, ever keeping her eye on Pisa, now ruled by Gabriele Maria Visconti, made an alliance with Pope Boniface IX., who wished to regain Perugia and Bologna. War broke out once more, and the allies were successful, but as soon as Boniface had gained his ends he made peace, leaving the Florentines unsatisfied. In

1404 their attempt to capture Pisa single-handed failed, and Gabriele Maria placed himself under the protection of the French king. The Florentines then made overtures to France, who had supported the anti-popes all through the great schism, and suggested that they too would support the then anti-pope, Benedict XIII., in exchange for the sale of Pisa. This was agreed to, and in 1405 the city was sold to Florence for 260,000 florins; and Gino Capponi,¹ the Florentine commissioner, took possession of the citadel, but a few days later the citizens arose in arms and recaptured it from the mercenaries. There was great consternation in Florence at the news, and every man in the city "determined that he would go naked rather than not conquer Pisa" (G. Capponi). The next year that city, then ruled by Giovanni Gambacorti, was besieged by the Florentines, who blockaded the mouth of the Arno. After a six months' siege Pisa surrendered on terms (9th October 1406), and, although it was not sacked, many of the citizens were exiled and others forced to live in Florence, a depopulation from which it never recovered. Florence now acquired a great seaport and was at last able to develop a direct maritime trade.

Except in connexion with the Pisan question the republic had taken no definite side in the great schism which had divided the church since 1378, but in 1408 she appealed both to Pope Gregory XII. and the anti-pope Benedict XIII. as well as to various foreign governments in favour of a settlement, and suggested a council within her own territory. Gregory refused, but after consulting a committee of theologians who declared him to be a heretic, the council promoted by Cardinal Cossa and other independent prelates met at Pisa. This nearly led to war with King Ladislas of Naples, because he had seized Rome, which he could only hold so long as the church was divided. The council deposed both popes and elected Pietro Filargi as Alexander V. (26th of June). But Ladislas still occupied the papal states, and Florence, alarmed at his growing power and ambition, formed a league with Siena, Bologna and Louis of Anjou who laid claim to the Neapolitan throne, to drive Ladislas from Rome. Cortona, Orvieto, Viterbo and other cities were recovered for Alexander, and in

¹ The historian, not to be confounded with the modern historian and statesman of the same name (*q.v.*).

January 1410 Rome itself was captured by the Florentines under Malatesta dei Malatesti. Alexander having died in May before entering the Eternal City, Cardinal Cossa was elected as John XXIII.; Florence without offending him made peace with Ladislas, who had ceased to be dangerous, and purchased Cortona of the pope. In 1413 Ladislas attacked the papal states once more, driving John from Rome, and threatened Florence; but like Henry VII., Gian Galeazzo Visconti, and other enemies of the republic, he too died most opportunely (6th of August 1414). John having lost all authority after leaving Rome, a new council was held at Constance, which put an end to the schism in 1417 with the election of Martin V. The new pope came to Florence in 1419 as he had not yet regained Rome, which was held by Francesco Sforza for Queen Joanna II. of Naples, and remained there until the following year.

No important changes in the constitution took place during this period except the appointment of two new councils in 1411 to decide on questions of peace and war. The aristocratic faction headed by Maso degli Albizzi, a wise and popular statesman, had remained predominant, and at Maso's death in 1417 he was succeeded in the leadership of the party by Niccolò da Uzzano. In 1421 Giovanni de' Medici was elected *gonfaloniere* of justice, an event which marks the beginning of that wealthy family's power. The same year the republic purchased Leghorn from the Genoese for 100,000 florins, and established a body of "Consuls of the Sea" to superintend maritime trade. Although 11,000,000 florins had been spent on recent wars Florence continued prosperous and its trade increased.

In 1421 Filippo Maria Visconti, who had succeeded in reconquering most of Lombardy, seized Forlì; this induced the Florentines to declare war on him, as they regarded his approach as a menace to their territory in spite of the opposition of the peace party led by Giovanni de' Medici. The campaign was anything but successful, and the Florentines were defeated several times, with the result that their credit was shaken and several important firms failed. The pope too was against them, but when they induced the Venetians to intervene the tide of fortune changed, and Visconti was finally defeated and forced to accept peace on onerous terms (1427).

The old systems of raising revenue no longer corresponded to the needs of the republic, and as early as 1336 the various loans made to the state were consolidated into one national debt (*monte*). Subsequently all extraordinary expenditure was met by forced loans (*prestanze*), but the method of distribution aroused discontent among the lower classes, and in 1427 a general *catasto* or assessment of all the wealth of the citizens was formed, and measures were devised to distribute the obligations according to each man's capacity, so as to avoid pressing too hardly on the poor. The *catasto* was largely the work of Giovanni de' Medici, who greatly increased his popularity thereby. He died in 1429.

An attempt to capture Lucca led Florence, in alliance with Venice, into another costly war with Milan (1432-1433). The mismanagement of the campaign brought about a quarrel between the aristocratic party, led by Rinaldo degli Albizzi, and the popular party, led by Giovanni de' Medici's son Cosimo (1389-1464), although both had agreed to the war before it began. Rinaldo was determined to break the Medici party, and succeeded in getting Cosimo exiled. The Albizzi tried to strengthen their position by conferring exceptional powers on the *capitano del popolo* and by juggling with the election bags, but the Medici still had a great hold on the populace. Rinaldo's proposal for a *coup d'état* met with no response from his own party, and he failed to prevent the election of a pro-Medici signory in 1434. He and other leaders of the party were summoned to the palace to answer a charge of plotting against the state, to which he replied by collecting 800 armed followers. A revolution was only averted through the intervention of Pope Eugenius IV., who was then in Florence. A *parlamento* was summoned, and the *balìa* appointed decreed

New war with the Visconti (1421-27).

Fiscal reforms (1427).

Exile and return of Cosimo de' Medici (1433-34).

The council of Pisa (1408).

the return of Cosimo and the exile of Rinaldo degli Albizzi, Rodolfo Peruzzi, Niccolò Barbadori, and others, in spite of the feeble attempt of Eugenius to protect them. On the 6th of October 1434 Cosimo returned to Florence, and for the next three centuries the history of the city is identified with that of the house of Medici.¹

Cosimo succeeded in dominating the republic while remaining nominally a private citizen. He exiled those who opposed him, and governed by means of the *balie*, which, re-elected every five years, appointed all the magistrates and acted according to his orders. In 1437 Florence and Venice were again at war with the Visconti, whose chief captain, Niccolò Piccinino (*q.v.*), on entering Tuscany with many Florentine exiles in his train, was signally defeated at Anghiari by the Florentines under Francesco Sforza (1440); peace was made the following year. The system of the *catasto*, which led to abuses, was abolished, and a progressive income-tax (*decima scalata*) was introduced with the object of lightening the burdens of the poor, who were as a rule Medicean, at the expense of the rich; but as it was frequently increased the whole community came to be oppressed by it in the end. Cosimo increased his own authority and that of the republic by aiding Francesco Sforza to become duke of Milan (1450), and he sided with him in the war against Venice (1452-1454). In 1452 the emperor Frederick III. passed through Florence on his way to be crowned in Rome, and was received as a friend. During the last years of Cosimo's life, affairs were less under his control, and the *gonfaloniere* Luca Pitti, a vain and ambitious man, introduced many changes, such as the abasement of the authority of the *podestà* and of the *capitano*, which Cosimo desired but was glad to attribute to others.

In 1464 Cosimo died and was succeeded, not without some opposition, by his son Piero, who was very infirm and gouty. Various plots against him were hatched, the anti-Medicean faction being called the Del Poggio party because the house of its leader Luca Pitti was on a hill, while the Mediceans were called the Del Piano party because Piero's house was in the town below; the other opposition leaders were Dietisalvi Neroni and Agnolo Acciaiuoli. But Piero's unexpected energy upset the schemes of his enemies. The death of Sforza led to a war for the succession of Milan, and the Venetians, instigated by Florentine exiles, invaded Tuscany. The war ended, after many indecisive engagements, in 1468, through the intervention of Pope Paul II. Piero died in 1469, leaving two sons, Lorenzo (1449-1492) and Giuliano (1453-1478). The former at once assumed the reins of government and became ruler of Florence in a way neither Cosimo nor Piero had ever attempted; he established his domination by means of *balie* consisting of the signory, the *accoppiatori*, and 240 other members, all Mediceans, to be renewed every five years (1471). In 1472 a quarrel having arisen with Volterra on account of a dispute concerning the alum mines, Lorenzo sent an expedition against the city, which was sacked and many of the inhabitants massacred. Owing to a variety of causes an enmity arose between Lorenzo and Pope Sixtus IV., and the latter, if not an accomplice, at all events had knowledge of the Pazzi conspiracy against the Medici (1478). The result of the plot was that, although Giuliano was murdered, Lorenzo strengthened his position, and put to death or exiled numbers of his enemies. He was excommunicated by Sixtus, who, together with King Ferdinand of Naples, waged war against him; no great successes were registered on either side at first, but eventually the Florentines were defeated at Poggio Imperiale (near Poggibonsi) and the city itself was in danger. Lorenzo's position was critical, but by his boldness in going to Naples he succeeded in concluding a peace with the king, which led to a reconciliation with the pope (1479-1480). He was received with enthusiasm on returning to Florence and became absolute master

of the situation. In April 1480 a *balia* was formed, and its most important act was the creation at Lorenzo's instance of the Council of Seventy; it was constituted for five years, but it became permanent, and all its members were Lorenzo's friends. From that time until his death the city was free from party strife under a *de facto* despotism, but after the Rinuccini conspiracy of that year the Council of Seventy passed a law declaring attempts on Lorenzo's life to be high treason. Owing to his political activity Lorenzo had neglected the business interests of his firm, and in order to make good certain heavy losses he seems to have appropriated public funds. His foreign policy, which was magnificent but expensive, rendered further forced loans necessary, and he also laid hands on the Monte delle Doti, an insurance institution to provide dowries for girls.

¹ The history of Florence from 1434 to 1737 will be found in greater detail in the article MEDICI, save for the periods from 1494 to 1512 and from 1527 to 1530, during which the republic was restored. For the period from 1530 to 1860 see also under TUSCANY.

An attempt by the Venetians to seize Ferrara led to a general Italian war, in which Florence also took part on the side hostile to Venice, and when peace was made in 1484 the republic gained some advantages. The following year a revolt of the Neapolitan barons against King Ferdinand broke out, actively supported by Pope Innocent VIII.; Lorenzo remained neutral at first, but true to his policy of maintaining the balance of power and not wishing to see Ferdinand completely crushed, he ended by giving him assistance in spite of the king's unpopularity in Florence. Peace was made when the pope agreed to come to terms in 1486, and in 1487 Lorenzo regained Sarzana, which Genoa had taken from Florence nine years previously. The general disorders and ceaseless intrigues all over Italy required Lorenzo's constant attention, and he succeeded in making Florence "the needle of the balance of power in Italy." At this time the Dominican Fra Girolamo Savonarola (*q.v.*) was in Florence and aroused the whole city by his denunciations of ecclesiastical corruption and also of that of the Florentines. He opposed Lorenzo's government as the source of the immorality of the people, and to some extent influenced public opinion against him. Ill-health now gained on Lorenzo, and Savonarola, whom he had summoned to his bedside, refused to give absolution to the destroyer of Florentine liberties. Lorenzo, during whose rule Florence had become one of the greatest centres of art and literature in Europe, died in 1492.

He was succeeded by his son Piero, who had none of his father's capacity and made a number of political blunders. When Charles VIII. of France came to Italy to conquer Naples Piero decided to assist the latter kingdom, although the traditional sympathies of the people were for the French king, and when Charles entered Florentine territory and captured Sarzana, Piero went to his camp and asked pardon for opposing him. The king demanded the cession of Pisa, Leghorn and other towns, which Piero granted, but on returning to Florence on the 8th of November 1494 he found the opposition greatly strengthened and his popularity forfeited, especially when the news of his disgraceful cessions to Charles became known. He was refused admittance to the palace, and the people began to shout "Popolo e libertà!" in opposition to the Medicean cry of "Palle, Palle!" (from the Medici arms). With a small escort he fled from the city, followed soon after by his brother Giovanni. That same day Pisa rose in revolt against the Florentines, and was occupied by Charles. The expulsion of the Medici produced some disorder, but Piero Capponi (*q.v.*) and other prominent citizens succeeded in keeping the peace. Ambassadors, one of whom was Savonarola, were sent to treat with the French king, but no agreement was arrived at until Charles entered Florence on the 17th of November at the head of 12,000 men. In spite of their French sympathies the citizens were indignant at the seizure of Sarzana, and while they gave the king a splendid welcome, they did not like his attitude of conqueror. Charles was impressed with the wealth and refinement of the citizens, and above all with the solid fortress-like appearance of their palaces. The signory appointed Piero Capponi, a man of great ability and patriotism, and experienced in diplomacy, the *gonfaloniere* Francesco Valori, the Dominican Giorgio Vespucci, and the jurisconsult and diplomatist Domenico Bonsi,

Piero de' Medici (the Gouty).

Lorenzo the Magnificent.

Savonarola.

Piero de' Medici.

Expulsion of the Medici (1494).

Charles VIII. in Florence.

syndics to conduct the negotiations with the French king. Charles's demands by no means pleased the citizens, and the arrogance and violence of his soldiers led to riots in which they were assailed with stones in the narrow streets. When the king began to hint at the recall of Piero de' Medici, whose envoys had gained his ear, the signory ordered the citizens to be ready to fly to arms. The proposal was dropped, but Charles demanded an immense sum of money before he would leave the city; long discussions followed, and when at last he presented an insolent ultimatum the syndics refused to accept it. The king said in

a threatening tone, "Then we shall sound our trumpets," whereupon Capponi tore up the document in his face and replied, "And we shall ring our bells."

The king, realizing what street fighting in Florence would mean, at once came to terms; he contented himself with 120,000 florins, agreeing to assume the title of "Protector and Restorer of the liberty of Florence," and to give up the fortresses he had taken within two years, unless his expedition to Naples should be concluded sooner; the Medici were to remain banished, but the price on their heads was withdrawn. But Charles would not depart, a fact which caused perpetual disturbance in the city, and it was not until the 28th of November, after an exhortation by Savonarola whom he greatly respected, that he left Florence.

It was now intended to re-establish the government on the basis of the old republican institutions, but it was found that sixty years of Medici rule had reduced them to mere shadows, and the condition of the government, largely controlled by a *balìa* of 20 *accoppiatori* and frequently disturbed by the summoning of the *parlamento*, was utterly chaotic. Consequently men talked of nothing save of changing the constitution, but unfortunately there was no longer an upper class accustomed to public affairs, while the lower class was thoroughly demoralized. Many proposals were made, none

of them of practical value, until Savonarola, who had already made a reputation as a moral reformer, began his famous series of political sermons. In the prevailing confusion the people turned to him as their only hope, and gradually a new government was evolved, each law being enacted as the result of his exhortations. A Greater Council empowered to appoint magistrates and pass laws was formed, to which all citizens *netti di specchio* (who had paid their taxes) and *beneficiari* (*i.e.* who had sat in one of the higher magistracies or whose fathers, grandfathers, or great-grandfathers had done so) were eligible together with certain others. There were 3200 such citizens, and they sat one-third at a time for six months. The Greater Council was to elect another council of 80 citizens over forty years old, also to be changed every six months; this body, which the signory must consult once a week, together with the colleges and the signory itself, was to appoint ambassadors and commissaries of war, and deal with other confidential matters. The system of forced loans was abolished and a 10% tax on real property introduced in its stead, and a law of amnesty for political offenders enacted. Savonarola also proposed a court of appeal for criminal and political crimes tried by the *Otto di guardia e balìa*; this too was agreed to, but the right of appeal was to be, not to a court as Savonarola suggested, but to the Greater Council, a fact which led to grave abuses, as judicial appeals became subject to party passions. The *parlamenti* were abolished and a *monte di pietà* to advance money at reasonable interest was created. But in spite of Savonarola's popularity there was a party called the *Bigi* (greys) who intrigued secretly in favour of the return of the Medici, while the men of wealth, called the *Arrabbiati*, although they hated the Medici, were even more openly opposed to the actual régime and desired to set up an aristocratic oligarchy. The adherents of Savonarola were called the *Piagnoni*, or snivellers, while the *Neutrali* changed sides frequently.

A league between the pope, the emperor, Venice and Spain having been made against Charles VIII., the latter was forced to return to France. On his way back he passed through Florence, and, although the republic had refused to join the league, it believed itself in danger, as Piero de' Medici was in the

king's train. Savonarola was again sent to the French camp, and his eloquence turned the king from any idea he may have had of reinstating the Medici. At the same time Charles violated his promise by giving aid to the Pisans in their revolt against Florence, and did not restore the other fortresses. After the French had abandoned

*League
against
Charles
VIII.*

Italy, Piero de' Medici, encouraged by the league, enlisted a number of mercenaries and marched on Florence, but the citizens, fired by Savonarola's enthusiasm, flew to arms and prepared for an energetic resistance; owing to Piero's incapacity and the exhaustion of his funds the expedition came to nothing.

At the same time the conditions of the city were not prosperous; its resources were strained by the sums paid to Charles and by the war; its credit was shaken, its trade paralysed, famine and plague visited the city, and the war to subjugate Pisa was proceeding unsatisfactorily. Worse still was the death in 1496 of one of its ablest and most disinterested statesmen, Piero Capponi. The league now attacked Florence, for Pope Alexander VI. hated Savonarola and was determined to destroy

*Alexander
VI.
against
Florence.*

the republic, so as to reinstate the Medici temporarily and prepare the way for his own sons; the Venetians and Imperialists besieged Leghorn, and there was great misery in Florence. All this decreased Savonarola's popularity to some extent, but the enemy having been beaten at Leghorn and the league being apparently on the point of breaking up, the Florentines took courage and the friar's party was once more in the ascendant. Numerous processions were held, Savonarola's sermons against corruption and vice seemed to have temporarily transformed the citizens, and the carnival of 1497 remained famous for the burning of the "vanities" (*i.e.* indecent books and pictures and carnival masks and costumes). The friar's sermons against ecclesiastical corruption, and especially against the pope, resulted in his excommunication by the latter, in consequence of which he lost much of his influence and immorality spread once more. That same year Piero made another unsuccessful attempt on Florence. New Medici plots having been discovered, Bernardo del Nero and other prominent citizens were tried and put to death; but the party hostile to Savonarola gained ground and had the support of the Franciscans, who were hostile to the Dominican order. Pulpit warfare was waged between Savonarola and his opponents, and the matter ended in his being forbidden to preach and in a proposed ordeal by fire, which, however, never came off. The pope again and again demanded that the friar be surrendered to him, but without success, in spite of his threats of an interdict against the city. The Piagnoni were out of power, and a signory of Arrabbiati having been elected in 1498, a mob of Savonarola's opponents attacked the convent of St Mark where he resided, and he himself was arrested and imprisoned. The commission appointed to try him on charges of heresy and treason was composed of his enemies, including Doffo Spini, who had previously attempted to murder him; many irregularities were committed during the three trials, and the prisoner was repeatedly tortured. The outgoing signory secured the election of another which was of their way of thinking, and on the 22nd of May 1498 Savonarola was condemned to death and executed the following day.

*Trial and
execution
of Savon-
arola
(1498).*

The pope having been satisfied, the situation in Florence was less critical for the moment. The war against Pisa was renewed, and in 1499 the city might have been taken but for the dilatory tactics of the Florentine commander Paolo Vitelli, who was consequently arrested on a charge of treason and put to death. Louis XII. of France, who now sent an army into Italy to conquer the Milanese, obtained the support of the Florentines. Cesare Borgia, who had seized many cities in Romagna, suddenly demanded the reinstatement of the Medici in Florence, and the danger was only warded off by appointing him captain-general of the Florentine forces at a large salary (1501). The weakness of the government becoming every day more apparent, several constitutional changes were made, and many old institutions, such as that of the *podestà* and *capitano del popolo*, were abolished; finally in 1502, in order

to give more stability to the government, the office of *gonfaloniere*, with the right of proposing laws to the signory, was made a life appointment. The election fell on Piero Soderini (1448-1522),

Piero Soderini.

an honest public-spirited man of no particular party, but lacking in strength of character. One useful measure which he took was the institution of a national militia at the suggestion of Niccolò Machiavelli (1505). In the meanwhile the Pisan war dragged on without much headway being made. In 1503 both Piero de' Medici and Alexander VI. had died, eliminating two dangers to the republic. Spain, who was at war with France over the partition of Naples, helped the Pisans as the enemies of Florence, France's ally (1501-1504), but when the war was over the Florentines were able to lay siege to Pisa (1507), and in 1509 the city was driven by famine to surrender and became a dependency of Florence once more.

Pope Julius II., after having formed the league of Cambrai with France and Spain against Venice, retired from it in 1510, and raised the cry of "Fuori i Barbari" (out with the barbarians), with a view to expelling the French from Italy. King Louis thereupon proposed an oecumenical council so as to create a schism in the Church, and demanded that it be held in Florentine territory. After some hesitation the republic agreed to the demand, and the council was opened at Pisa, whereupon the pope immediately placed Florence under an interdict. At the request of the Florentines the council removed to Milan, but this did not save them from the pope's wrath. A Spanish army under Raymundo de Cardona and accompanied by Cardinal Giovanni de' Medici and his brother Giuliano entered the republic's territory and demanded 100,000 florins, the dismissal of Soderini, and the readmission of the Medici. Soderini offered to resign, but the Greater Council supported him and preparations for defence were made. In August the Spaniards took Prato by storm and committed hideous atrocities on the inhabitants; Florence was in a panic, a group of the *Ottimati*, or nobles, forced Soderini to resign and leave the city, and Cardona's new terms were accepted, viz. the readmission of the Medici, a fine of 150,000 florins, and an alliance with Spain. On the 1st of September 1512

Giuliano and Giovanni de' Medici, and their nephew Lorenzo, entered Florence with the Spanish troops; a *parlamento* was summoned, and a packed *balia* formed which abolished the Greater Council and created a constitution similar to that of Lorenzo the Magnificent. Giuliano became *de facto* head of the government, but he did not pursue the usual vindictive policy of his house, although he resorted to the Laurentian method of amusing the citizens with splendid festivities. In 1513, on the death of Julius II., Giovanni de' Medici was elected pope as Leo X., an event which greatly enhanced the importance of the house. In March 1514 Giuliano died, and was succeeded by Lorenzo, who was also created duke of Urbino. At his death in 1519 Cardinal Giulio de' Medici (son of the Giuliano murdered in the Pazzi conspiracy) took charge of the government; he met with some opposition and had to play off the *Ottimati* against the Piagnoni, but he did not rule badly and maintained at all events the outward forms of freedom. In 1523 he was created pope as Clement VII. and sent his relatives Ippolito and Alessandro, both minors and bastards, to Florence under the tutorship of Cardinal Silvio Passerini. Ippolito was styled the *Magnifico* and destined to be ruler of the republic, but Cardinal Passerini's regency proved most unpopular, and the city was soon seething with discontent. Revolts broke out and Passerini showed himself quite unequal to coping with the situation. The *Ottimati* were mostly anti-Medicean, and by 1527 the position was untenable. When Filippo Strozzi, and above

Return of the Medici (1512).

all his wife, threw their influence in the scales against the Medici, and the magistrates declared for their expulsion from power, Passerini, Ippolito and Alessandro left Florence (17th of May 1527). A *Consiglio degli Scelti* was summoned, and a constitution similar to that of Savonarola's time was established. The Greater Council was revived and Niccolò Capponi created *gonfaloniere* for a year. But Florence was torn by factions—the *Ottimati*

Second expulsion of the Medici (1527).

who desired an oligarchy, the Palleschi or Mediceans who generally supported them, the Adirati who opposed Capponi for his moderation, the Arrabbiati who were strongly anti-Medicean, and the Popolani who opposed the *Ottimati*. "It is almost impossible that a state so disorganized and corrupt as Florence then was should produce men of parts and character, but if by chance any such should arise they would be hated and persecuted, their dispositions would be soured by indignation, or they would be hunted from their country or die of grief" (Benedetto Varchi). Capponi did his best to reform the city and save the situation, and while adopting Savonarola's tone in internal affairs, he saw the dangers in the foreign situation, realizing that a reconciliation between the pope and the emperor Charles V. would prove disastrous for Florence, for Clement would certainly seize the opportunity to reinstate his family in power. Having been re-elected *gonfaloniere* in spite of much opposition in 1528, Capponi tried to make peace with the pope, but his correspondence with the Vatican resulted in a quite unjustified charge of high treason, and although acquitted he had to resign office and leave the city for six months. Francesco Carducci was elected *gonfaloniere* in his place, and on the 29th of June 1529 the pope and the emperor concluded a treaty by which the latter agreed to re-establish the Medici in Florence. Carducci made preparations for a siege, but a large part of the people were against him, either from Medicean sympathies or fear, although the Frateschi, as the believers in Savonarola's views were called, supported him strongly. A body called the *Nove della Milizia*, of whom Michelangelo Buonarroti was a member, was charged with the defence of the city, and Michelangelo (*q.v.*) himself superintended the strengthening of the fortifications. A most unfortunate choice for the chief command of the army was the appointment of Malatesta Baglioni. In August an imperial army under Philibert, prince of Orange, advanced on the city. In September Malatesta surrendered Perugia, and other cities fell before the Imperialists. All attempts to come to terms with the pope were unsuccessful, and by October the siege had begun. Although alone against papacy and empire, the citizens showed the greatest spirit and devotion, and were successful in many sorties. The finest figure produced by these events was that of Francesco Ferruccio (*q.v.*); by his defence of Empoli he showed himself a first-class soldier, and was appointed commissioner-general. He executed many rapid marches and counter-marches, assaulting isolated bodies of the enemy unexpectedly, and harassing them continually. But Malatesta was a traitor at heart and hindered the defence of the city in every way. Ferruccio, who had recaptured Volterra, marched to Gavinana above Pistoia to attack the Imperialists in the rear. A battle took place at that spot on the 3rd of August, but in spite of Ferruccio's heroism he was defeated and killed; the prince of Orange also fell in that desperate engagement. Malatesta contributed to the defeat by preventing a simultaneous attack by the besieged. The sufferings from famine within the city were now very great, and an increasingly large part of the people favoured surrender. The signory, at last realizing that Malatesta was a traitor, dismissed him; but it was too late, and he now behaved as though he were governor of Florence; when the troops attempted to enforce the dismissal he turned his guns on them. On the 9th of August the signory saw that all hope was lost and entered into negotiations with Don Ferrante Gonzaga, the new imperial commander. On the 12th the capitulation was signed: Florence was to pay an indemnity of 80,000 florins, the Medici were to be recalled, the emperor was to establish the new government, "it being understood that liberty is to be preserved." Baccio Valori, a Medicean who had been in the imperialist camp, now took charge, and the city was occupied by foreign troops. A *parlamento* was summoned, the usual packed *balia* created, and all opposition silenced. The city was given over to Pope Clement, who, disregarding the terms of the capitulation, had Carducci and Girolami (the last *gonfaloniere*) hanged, and established Alessandro de' Medici, the natural son of Lorenzo, duke of Urbino, as head of the republic on the 5th of July 1531. The next year

who desired an oligarchy, the Palleschi or Mediceans who generally supported them, the Adirati who opposed Capponi for his moderation, the Arrabbiati who were strongly anti-Medicean, and the Popolani who opposed the *Ottimati*. "It is almost impossible that a state so disorganized and corrupt as Florence then was should produce men of parts and character, but if by chance any such should arise they would be hated and persecuted, their dispositions would be soured by indignation, or they would be hunted from their country or die of grief" (Benedetto Varchi). Capponi did his best to reform the city and save the situation, and while adopting Savonarola's tone in internal affairs, he saw the dangers in the foreign situation, realizing that a reconciliation between the pope and the emperor Charles V. would prove disastrous for Florence, for Clement would certainly seize the opportunity to reinstate his family in power. Having been re-elected *gonfaloniere* in spite of much opposition in 1528, Capponi tried to make peace with the pope, but his correspondence with the Vatican resulted in a quite unjustified charge of high treason, and although acquitted he had to resign office and leave the city for six months. Francesco Carducci was elected *gonfaloniere* in his place, and on the 29th of June 1529 the pope and the emperor concluded a treaty by which the latter agreed to re-establish the Medici in Florence. Carducci made preparations for a siege, but a large part of the people were against him, either from Medicean sympathies or fear, although the Frateschi, as the believers in Savonarola's views were called, supported him strongly. A body called the *Nove della Milizia*, of whom Michelangelo Buonarroti was a member, was charged with the defence of the city, and Michelangelo (*q.v.*) himself superintended the strengthening of the fortifications. A most unfortunate choice for the chief command of the army was the appointment of Malatesta Baglioni. In August an imperial army under Philibert, prince of Orange, advanced on the city. In September Malatesta surrendered Perugia, and other cities fell before the Imperialists. All attempts to come to terms with the pope were unsuccessful, and by October the siege had begun.

Although alone against papacy and empire, the citizens showed the greatest spirit and devotion, and were successful in many sorties. The finest figure produced by these events was that of Francesco Ferruccio (*q.v.*); by his defence of Empoli he showed himself a first-class soldier, and was appointed commissioner-general. He executed many rapid marches and counter-marches, assaulting isolated bodies of the enemy unexpectedly, and harassing them continually. But Malatesta was a traitor at heart and hindered the defence of the city in every way. Ferruccio, who had recaptured Volterra, marched to Gavinana above Pistoia to attack the Imperialists in the rear. A battle took place at that spot on the 3rd of August, but in spite of Ferruccio's heroism he was defeated and killed; the prince of Orange also fell in that desperate engagement. Malatesta contributed to the defeat by preventing a simultaneous attack by the besieged. The sufferings from famine within the city were now very great, and an increasingly large part of the people favoured surrender. The signory, at last realizing that Malatesta was a traitor, dismissed him; but it was too late, and he now behaved as though he were governor of Florence; when the troops attempted to enforce the dismissal he turned his guns on them. On the 9th of August the signory saw that all hope was lost and entered into negotiations with Don Ferrante Gonzaga, the new imperial commander. On the 12th the capitulation was signed: Florence was to pay an indemnity of 80,000 florins, the Medici were to be recalled, the emperor was to establish the new government, "it being understood that liberty is to be preserved." Baccio Valori, a Medicean who had been in the imperialist camp, now took charge, and the city was occupied by foreign troops. A *parlamento* was summoned, the usual packed *balia* created, and all opposition silenced. The city was given over to Pope Clement, who, disregarding the terms of the capitulation, had Carducci and Girolami (the last *gonfaloniere*) hanged, and established Alessandro de' Medici, the natural son of Lorenzo, duke of Urbino, as head of the republic on the 5th of July 1531. The next year

The siege of Florence.

Surrender of Florence (1530).

the signory was abolished, Alessandro created *gonfaloniere* for life, and his lordship made hereditary in his family by imperial patent. Thus Florence lost her liberty, and came to be the capital of the duchy (afterwards grand-duchy) of Tuscany (see TUSCANY).

The Medici dynasty ruled in Tuscany until the death of Gian Gastone in 1737, when the grand-duchy was assigned to Francis, duke of Lorraine. But it was governed by a regency until 1753, when it was conferred by the empress Maria Theresa on his son Peter Leopold. During the Napoleonic wars the grand-duke Ferdinand III. of Habsburg-Lorraine was driven from the throne, and Tuscany was annexed to the French empire in 1808. In 1809 Florence was made capital of the kingdom of Etruria, but after the fall of Napoleon in 1814 Ferdinand was reinstated. He died in 1833, and was succeeded by Leopold II. In 1848 there was a liberal revolutionary movement in Florence, and Leopold granted a constitution. But civil disorders followed, and in 1849 the grand-duke returned under an Austrian escort. In 1859, after the Franco-Italian victories over the Austrians in Lombardy, by a bloodless revolution in Florence Leopold was expelled and Tuscany annexed to the Sardinian kingdom.

In 1865 Florence became the capital of the kingdom of Italy, but after the occupation of Rome in 1870 during the Franco-Prussian war, the capital was transferred to the Eternal City (1871).

BIBLIOGRAPHY.—The best complete history of Florence is Gino Capponi's *Storia della Repubblica di Firenze* (2 vols., Florence, 1875), which although defective as regards the earliest times is a standard work based on original authorities; also F. T. Perrons, *Histoire de Florence* (9 vols., Paris, 1877-1890). For the early period see Pasquale Villari's *I Primi Due Secoli della storia di Firenze* (Eng. ed., London, 1894), and R. Davidsohn's *Geschichte der Stadt Florenz* (Berlin, 1896); P. Villari's *Savonarola* (English ed., London, 1896) is invaluable for the period during which the friar's personality dominated Florence, and his *Machiavelli* (English ed., London, 1892) must be also consulted, especially for the development of political theories. Among the English histories of Florence, Napier's *Florentine History* (6 vols., London, 1846-1847) and A. Trollope's *History of the Commonwealth of Florence* (4 vols., London, 1865) are not without value although out of date. Francis Hyett's *Florence* (London, 1903) is more recent and compendious; the author is somewhat Medicean in his views, and frequently inaccurate. For the later history, A. von Reumont's *Geschichte von Toscana* (Gotha, 1876-1877) is one of the best works. There is a large number of small treatises and compendia of Florentine history of the guide-book description. See also the bibliographies in MEDICI, MACHIAVELLI, SAVONAROLA, TUSCANY, &c. (L. V.*)

FLORES, an island in the Atlantic Ocean, belonging to Portugal, and forming part of the Azores archipelago. Pop. (1900) 8137; area, 57 sq. m. Flores and the adjacent island of Corvo (pop. 806; area, 7 sq. m.) constitute the westernmost group of the Azores, and seem but imperfectly to belong to the archipelago, from the rest of which they are widely severed. They lie also out of the usual track of navigators; but to those who, missing their course, are led thither, Flores affords good shelter in its numerous bays. Its poultry is excellent; and the cattle are numerous, but small. It derives its name from the abundance of the flowers that find shelter in its deep ravines. Its capital is Santa Cruz das Flores (2247). In 1591 Flores was the station of the English fleet before the famous sea fight between Sir R. Grenville's ship "Revenge" and a Spanish fleet of 53 vessels. See AZORES.

FLORES, an island of the Dutch East Indies, a member of the chain extending east of Java. Its length is 224 m., its greatest breadth 37 m., and its area 5850 sq. m. The existence of slate, chalk, and sandstone, eruptive rock, volcanoes and heights stretching west and east, indicates a similar structure to that of the other islands of the chain. Several volcanoes are active. Among the loftier summits are, on the south coast, Gunong Rokka (7940 ft.) and Keo (6560 ft.); with the lesser but constantly active Gunong Api, forming a peninsula; and at the south-east, Lobetobi (7120 ft.). The thickly wooded interior is little explored. The coasts have deep bays and extensive rounded gulfs, where are situated the principal villages (*kampung*s). On the north coast are Bari, Reo, Maumer and Geliting; on the east, Larantuka; and on the south, Sikka and Endeh.

The rivers, known only at their mouths, seem to be unnavigable. The mean temperature is 77° to 80° F., and the yearly rainfall 43 to 47 in. For administrative purposes the island is divided into West Flores (Mangerai), attached to the government of Celebes, and Middle and East Flores (Larantuka and dependencies), attached to the residency of Timor. The population is estimated at 250,000. The people live by trade, fishing, salt-making, shipbuilding, and the cultivation of rice, maize, and palms in the plain, but there is little industry or commerce. Some edible birds' nests, rice, sandalwood and cinnamon are exported to Celebes and elsewhere. The inhabitants of the coast-districts are mainly of Malay origin. The aborigines, who occupy the interior, are of Papuan stock. They are tall and well-built, with dark or black skins. The hair is frizzly. They are pure savages; their only religion is a kind of nature-worship. They consider the earth holy and inviolable; thus in severe droughts they only dig the river-beds for water as a last resource. Portugal claimed certain portions of the island until 1859.

FLOREZ, ENRIQUE (1701-1773), Spanish historian, was born at Valladolid on the 14th of February 1701. In his fifteenth year he entered the order of St Augustine, was afterwards professor of theology at the university of Alcala, and published a *Cursus theologiae* in five volumes (1732-1738). He afterwards devoted himself to historical studies. Of these the first-fruit was his *Clave Historial*, a work of the same class as the French *Art de vérifier les dates*, and preceding it by several years. It appeared in 1743, and passed through many editions. In 1747 was published the first volume of *España Sagrada, teatro geografico-historico de la Iglesia de España*, a vast compilation of Spanish ecclesiastical history which obtained a European reputation, and of which twenty-nine volumes appeared in the author's lifetime. It was continued after his death by Manuel Risco and others, and further additions have been made at the expense of the Spanish government. The whole work in fifty-one volumes was published at Madrid (1747-1886). Its value is considerably increased by the insertion of ancient chronicles and documents not easily accessible elsewhere. Florez was a good numismatist, and published *Medallas de las Colonias* in 2 vols. (1757-1758), of which a third volume appeared in 1773. His last work was the *Memorias de las reynas Catolicas*, 2 vols. (1770). Florez led a retired, studious and unambitious life, and died at Madrid on the 20th of August 1773.

See F. Mendez, *Noticia de la vida y escritos de Henrique Florez* (Madrid, 1780).

FLORIAN, SAINT, a martyr honoured in Upper Austria. In the 8th century Pucche was mentioned as the place of his tomb, and on the site was built the celebrated monastery of canons regular, St Florian, which still exists. His *Acta* are of considerable antiquity, but devoid of historical value. Their substance is borrowed from the *Acta* of St Irenaeus of Sirmium. The cult of St Florian was introduced into Poland, together with the relics of the saint, which were brought thither in 1183 by Giles, bishop of Modena. Casimir, duke of Poland, dedicated a church at Cracow to him. He is represented in various ways, especially as a warrior holding in his hand a vessel from which he pours out flames. His protection is often sought against fire. His day in the calendar is the 4th of May.

See *Acta Sanctorum*, May, i. 461-467; B. Krusch, *Scribtores rerum Merovingicarum*, iii. 65-68; C. Cahier, *Caractéristiques des saints*, p. 490 (Paris, 1867). (H. DE.)

FLORIAN, JEAN PIERRE CLARIS DE (1755-1794), French poet and romance writer, was born on the 6th of March 1755 at the château of Florian, near Sauve, in the department of Gard. His mother, a Spanish lady named Gilette de Salgues, died when he was quite a child. His uncle and guardian, the marquis of Florian, who had married a niece of Voltaire, introduced him at Ferney and in 1768 he became page at Anet in the household of the duke of Penthièvre, who remained his friend throughout his life. Having studied for some time at the artillery school at Bapaume he obtained from his patron a captain's commission in a dragoon regiment, and in this capacity it is said he displayed

a boisterous behaviour quite incongruous with the gentle, meditative character of his works. On the outbreak of the French Revolution he retired to Sceaux, but he was soon discovered and imprisoned; and though his imprisonment was short he survived his release only a few months, dying on the 13th of September 1794.

Florian's first literary efforts were comedies; his verse epistle *Voltaire et le serf du Mont Jura* and an eclogue *Ruth* were crowned by the French Academy in 1782 and 1784 respectively. In 1782 also he produced a one-act prose comedy, *Le Bon Ménage*, and in the next year *Galatée*, a romantic tale in imitation of the *Galatea* of Cervantes. Other short tales and comedies followed, and in 1786 appeared *Numa Pompilius*, an undisguised imitation of Fénelon's *Télémaque*. In 1788 he became a member of the French Academy, and published *Estelle*, a pastoral of the same class as *Galatée*. Another romance, *Gonzalve de Cordoue*, preceded by an historical notice of the Moors, appeared in 1791, and his famous collection of *Fables* in 1792. Among his posthumous works are *La Jeunesse de Florian, ou Mémoires d'un jeune Espagnol* (1807), and an abridgment (1799) of *Don Quixote*, which, though far from being a correct representation of the original, had great and merited success.

Florian imitated Salomon Gessner, the Swiss idyllist, and his style has all the artificial delicacy and sentimentality of the Gessnerian school. Perhaps the nearest example of the class in English literature is afforded by John Wilson's (Christopher North's) *Lights and Shadows of Scottish Life*. Among the best of his fables are reckoned "The Monkey showing the Magic Lantern," "The Blind Man and the Paralytic," and "The Monkeys and the Leopard."

The best edition of Florian's *Ceuvres complètes* appeared in Paris in 16 volumes, 1820; his *Ceuvres inédites* in 4 volumes, 1824.

See "Vie de Florian," by L. F. Jauffret, prefixed to his *Ceuvres posthumes* (1802); A. J. N. de Rosny, *Vie de Florian* (Paris, An V.); Sainte-Beuve, *Causeries du lundi*, t. iii.; A. de Montvaillant, *Florian, sa vie, ses œuvres* (1879); and *Lettres de Florian à Mme de la Briche*, published, with a notice by the baron de Barante in *Mélanges* published (1903) by the Société des bibliophiles français.

FLORIANOPOLIS (formerly *Desterro, Nossa Senhora do Desterro* and *Santa Catharina*, and still popularly known under the last designation), a city and port of Brazil and the capital of the state of Santa Catharina, on the western or inside shore of a large island of the same name, 485 m. S.S.W. of Rio de Janeiro, in 27° 30' S., 48° 30' W. Pop. (1890) 11,400, including many Germans; (1902, estimate) 16,000; of the municipality, including a large rural district and several villages (1890), 30,687. The harbour is formed by the widening of the strait separating the island from the mainland, which is nearly 2 m. wide at this point. It is approached by narrow entrances from the N. and S., which are defended by small forts. The island is mountainous and wooded, and completely shelters the harbour from easterly storms. The surroundings are highly picturesque and tropical in character, but the town itself is poorly built and unattractive. Its public buildings include the president's official residence, arsenal, lyceum, hospital and some old churches. The climate is warm for the latitude, but the higher elevations of the vicinity are noted for their mild climate and healthfulness. There are some German colonies farther up the coast whose products find a market here, and a number of small settlements along the mainland coast add something to the trade of the town. The more distant inland towns are partly supplied from this point, but difficult mountain roads tend to restrict the trade greatly. There is a considerable trade in market produce with Rio de Janeiro, but the exports are inconsiderable. Santa Catharina was formerly one of the well-known whaling stations of the South Atlantic, and is now a secondary military and naval station.

The island of Santa Catharina was originally settled by the Spanish; Cabeza de Vaca landed here in 1542 and marched hence across country to Asuncion, Paraguay. The Spanish failed to establish a permanent colony, however, and the Portuguese took possession. The island was captured by a Spanish expedition under Viceroy Zeballos in 1777. A boundary treaty

of that same year restored it to Portugal. In 1894 Santa Catharina fell into the possession of revolutionists against the government of President Floriano Peixoto. With the collapse of the revolution the city was occupied by the government forces, and its name was then changed to Florianopolis in honour of the president of the republic.

FLORIDA, the most southern of the United States of America, situated between 24° 30' and 31° N. lat. and 79° 48' and 87° 38' W. long. It is bounded N. by Georgia and Alabama, E. by the Atlantic Ocean, S. by the Strait of Florida, which separates it from Cuba, and by the Gulf of Mexico, and W. by Alabama and the Gulf. The Florida Keys, a chain of islands extending in a general south-westerly direction from Biscayne Bay, are included in the state boundaries, and the city of Key West, on an island of the same name, is the seat of justice of Monroe county. The total area of the state is 58,666 sq. m., of which 3805 sq. m. are water surface. The coast line is greater than that of any other state, extending 472 m. on the Atlantic and 674 m. on the Gulf Coast.

The peculiar outline of Florida gives it the name of "Peninsula State." The average elevation of the surface of the state above the sea-level is less than that of any other state except Louisiana, but there is not the monotony of unbroken level which descriptions and maps often suggest. The N.W. portion of the state is, topographically, similar to south-eastern Alabama, being a rolling, hilly country; the eastern section is a part of the Atlantic coastal plain; the western coast line is less regular than the eastern, being indented by a number of bays and harbours, the largest of which are Charlotte Harbour, Tampa Bay and Pensacola Bay. Along much of the western coast and along nearly the whole of the eastern coast extends a line of sand reefs and narrow islands, enclosing shallow and narrow bodies of water, such as Indian river and Lake Worth—called rivers, lakes, lagoons, bays and harbours. In the central part of the state there is a ridge, extending N. and S. and forming a divide, separating the streams of the east coast from those of the west. Its highest elevation above sea-level is about 300 ft. The central region is remarkable for its large number of lakes, approximately 30,000 between Gainesville in Alachua county, and Lake Okeechobee. They are due largely to sinkholes or depressions caused by solution of the limestone of the region. Many of the lakes are connected by subterranean channels, and a change in the surface of one lake is often accompanied by a change in the surface of another. By far the largest of these lakes, nearly all of them shallow, is Lake Okeechobee, a body of water about 1250 sq. m. in area and almost uniformly shallow, its depth seldom being greater than 15 ft. Caloosahatchee river, flowing into the Gulf of Mexico near Charlotte Harbour, is its principal outlet. Among the other lakes are Orange, Crescent, George, Weir, Harris, Eustis, Apopka, Tohoekaliga, Kissimmee and Istokpoga. The chief feature of the southern portion of the state is the Everglades (*q.v.*), the term "Everglade State" being popularly applied to Florida. Within the state there are many swamps, the largest of which are the Big Cypress Swamp in the S. adjoining the Everglades on the W., and Okefinokee Swamp, extending from Georgia into the N.E. part of the state.

A peculiar feature of the drainage of the state is the large number of subterranean streams and of springs, always found to a greater or less extent in limestone regions. Some of them are of great size. Silver Spring and Blue Spring in Marion county, Blue Spring and Orange City Mineral Spring in Volusia county, Chipola Spring near Marianna in Jackson county, Espiritu Santo Spring near Tampa in Hillsboro county, Magnolia Springs in Clay county, Suwanee Springs in Suwanee county, White Sulphur Springs in Hamilton county, the Wekiva Springs in Orange county, and Wakulla Spring, Newport Sulphur Spring and Panacea Mineral Spring in Wakulla county are the most noteworthy. Many of the springs have curative properties, one of them, the Green Cove Spring in Clay county, discharging about 3000 gallons of sulphuretted water per minute. Not far from St Augustine a spring bursts through the sea itself with such force that the ocean breakers roll back from it as from a sunken reef. The springs often merge into lakes, and lake systems are usually the sources of the rivers, Lake George being the principal source of the St Johns, and Lake Kissimmee of the Kissimmec, while a number of smaller lakes are the source of the Oklawaha, one of the most beautiful of the Floridian rivers.

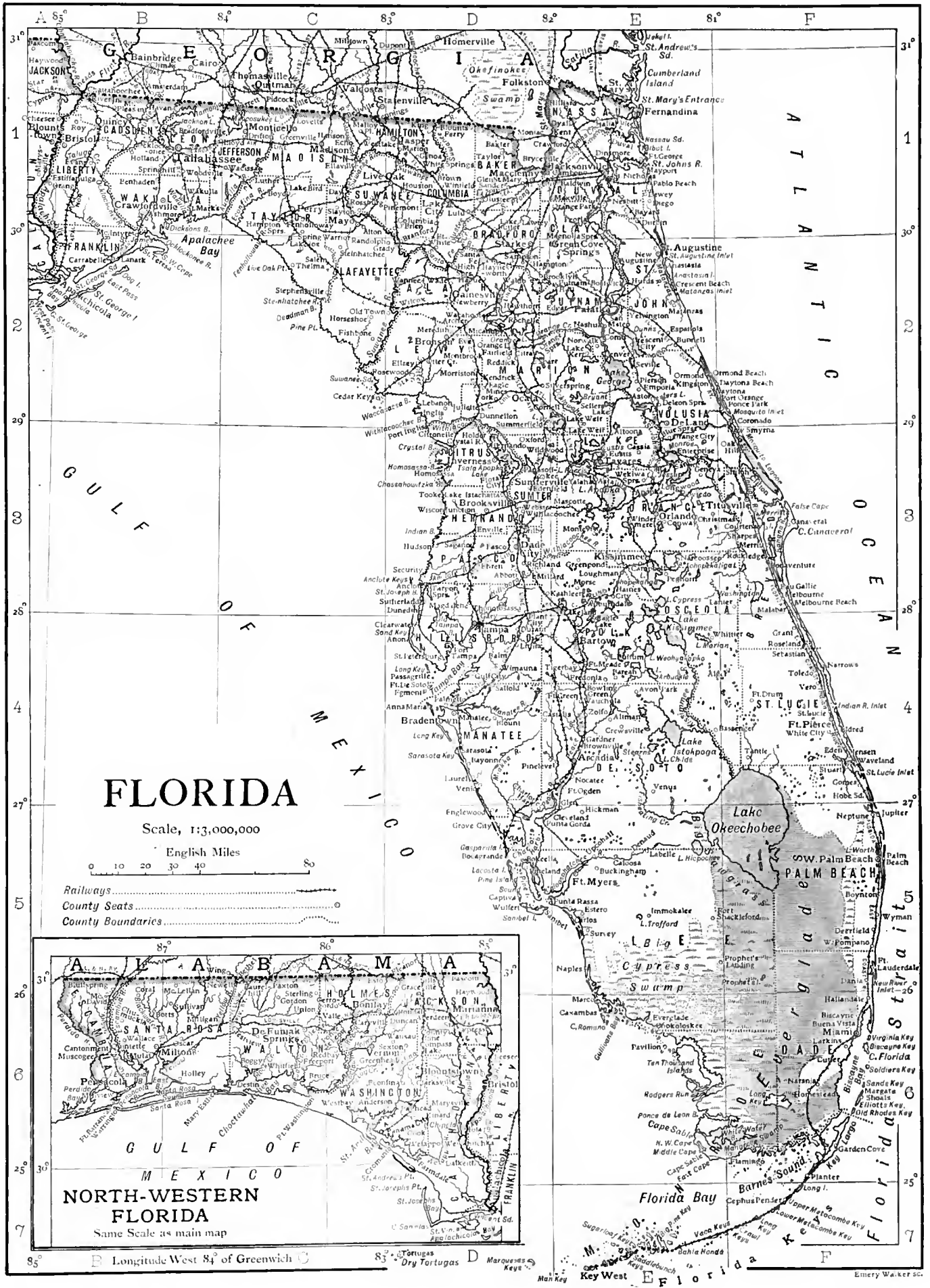

Of the rivers the most important are the St Johns, which flows N. from about the middle of the peninsula, empties into the Atlantic a short distance below Jacksonville, and is navigable for about 250 m. from its mouth, the Withlacoochee, flowing in a general north-westerly direction from its source in the N.E. part of Polk county, and forming near its entrance into the Gulf of Mexico the boundary between Levy and Citrus counties, and four rivers, the Escambia, the Choctawatchee, the Apalachicola, and the Suwanee, having their sources in other states and traversing the north-western part of Florida. On account of its sand reefs, the east coast has not so many harbours as the west coast. The most important harbours are at Fernandina, St Augustine, and Miami on the E. coast, and at Tampa, Key West and Pensacola on the W. coast.

The soils of Florida have sand as a common ingredient.¹ They may be divided into three classes: the pine lands, which often have a surface of dark vegetable mould, under which is a sandy loam resting on a substratum of clay, marl or limestone—areas of such soil are found throughout the state; the "hammocks," which have soil of similar ingredients and are interspersed with the pine lands—large areas of this soil occur in Levy, Alachua, Citrus, Hernando, Pasco, Gadsden, Leon, Madison, Jefferson and Jackson counties; and the alluvial swamp lands, chiefly in E. and S. Florida, the richest class, which require drainage to fit them for cultivation.

As regards climate Florida may be divided into three more or less distinct zones. North and west of a line passing through Cedar Keys and Fernandina the climate is distinctly "southern," similar to that of the Gulf states; from this line to another extending from the mouth of the Caloosahatchee to Indian river inlet the climate is semi-tropical, and is well suited to the cultivation of oranges; S. of this the climate is sub-tropical, well adapted to the cultivation of pineapples. Since the semi-tropical and sub-tropical zones are nearer the course of the Gulf Stream, and are swept by the trade winds, their temperatures are more uniform than those of the zones of southern climate; indeed, the extremes of heat (103° F.) and cold (13° F.) are felt in the region of southern climate. The mean annual temperature of the state is 70.8° F., greater in the sub-tropical than in the other climate zones, and the Atlantic coast is in general warmer than the Gulf Coast. The rainfall averages 52.09 in. per annum. On account of its warm climate, Florida has many resorts for health and pleasure, which are especially popular in the season from January to April; the more important are St Augustine, Ormond, Daytona, Palm Beach, Miami, Tampa, White Springs, Hampton Springs, Worthington Springs and Orange Springs.

No metals have ever been discovered in Florida. The principal minerals are rock phosphate and (recently more important) land and river pebble phosphate, found in scattered deposits in a belt on the "west coast" about 30 m. wide and extending from Tallahassee to Lake Okeechobee. The centre of the quarries is Dunnellon in Marion county, and pebble phosphate is found in Hillsboro, Polk, De Soto, Osceola, Citrus and Hernando counties. Although the economic value of the phosphate deposits was first realized about 1889, between 1894 and 1907 Florida produced, each year, more than half of all the phosphate rock produced in the whole United States, the yield of Florida (1,357,365 long tons) in 1907 being valued at \$6,577,757; that of the whole country at \$10,653,558. Florida is also the principal source in the United States for fuller's earth, a deposit of which, near Quincy, was first discovered in 1893; and clay (including kaolin) is also mined to some extent. Other minerals that have been discovered but have not been industrially developed are gypsum, lignite and cement rock. The lack of a thorough geological survey has perhaps prevented the discovery of other minerals—certainly it is responsible for a late recognition of the economic value of the known mineral resources.

The flora of N. Florida is similar to that of south-eastern North America; that of S. Florida seems to be a link between the vegetation of North America and that of South America and the West Indies, for out of 247 species of S. Florida that have been examined, 187 are common to the West Indies, Mexico and South America. The forests cover approximately 37,700 sq. m., chiefly in the northern part of the state, including about half of the peninsula, yellow pine being predominant, except in the coastal marsh lands, where cypress, found throughout the state, particularly abounds. About half of the varieties of forest trees in the United States are found, and

among the peculiar species are the red bay or "Florida Mahogany," satinwood and cachibou, and the Florida yew and savin, both almost extinct. The lumber industry is important: in 1905 the total factory product of lumber and timber was valued at \$10,901,650, and lumber and planing mill products were valued at \$1,690,455. In 1900 this was the most valuable industry in the state; in 1905 it was second to the manufacture of tobacco. The fauna is similar in general to that of the southern United States. Among the animals are the puma, manatee (sea cow), alligator and crocodile, but the number of these has been greatly diminished by hunting. Ducks, wild turkeys, bears and wild cats (lynx) are found, but in decreasing numbers.

The fisheries are very valuable; the total number of species of fish in Florida waters is about 600, and many species found on one coast are not found on the other. The king fish and tarpon are hunted for sport, while mullet, shad, reddsappers, pompano, trout, sheephead and Spanish mackerel are of great economic value. The sponge and oyster fisheries are also important. The total product of the fisheries in 1902 was valued at about \$2,000,000.

Industry and Commerce.—The principal occupation is agriculture, in which 44% of the labouring population was engaged in 1900, but only 12.6% of the total land surface was enclosed in farms, of which only 34.6% was improved, and the total agricultural product for 1899 was valued at \$18,309,104. As the number of farms increased faster than the cultivated area from 1850 to 1900, the average size of farms declined from 444 acres in 1860 to 140 in 1880 and to 106.9 in 1900, the largest class of farms being those with an acreage varying from 20 to 50 acres. Nearly three-fourths of the farms, in 1900, were cultivated by their owners, but the cash tenantry system showed an increase of 100% since 1890, being most extensively used in the cotton counties. One-third of the farms were operated by negroes, but one-half of these farms were rented, and the value of negro farm property was only one-eighth that of the entire farm property of the state. According to the state census of 1905 only 1,621,362 acres were improved; of 45,984 farms, 31,233 were worked by whites.

Fruits normally form the principal crop; the total value for 1907-8 of the fruit crops of the state (including oranges, lemons, limes, grape-fruit, bananas, guavas, pears, peaches, grapes, figs, pecans, &c.) was \$6,160,299, according to the report of the State Department of Agriculture. The discovery of Florida's adaptability to the culture of oranges about 1875 may be taken as the beginning of the state's modern industrial development. But the unusual severity of the winters of 1887, 1894 and 1899 (the report of the Twelfth Census which gives the figures for this year being therefore misleading) destroyed three-fourths of the orange trees, and caused an increased attention to stock-raising, and to various agricultural products. Orange culture has recovered much of its importance, but it is carried on in the more southern counties of the state. The cultivation of pineapples, in sub-tropical Florida, is proving successful, the product far surpassing that of California, the only other state in the Union in which pineapples are grown. Grape-fruit, guavas and lemons are also successfully produced in this part of the state. The cultivation of strawberries and vegetables (cabbage, cauliflower, beets, beans, tomatoes, egg-plant, cucumbers, water-melons, celery, &c.) for northern markets, and of orchard fruits, especially plums, pears and prunes, has likewise proved successful. In 1907-8, according to the State Department of Agriculture, the total value of vegetable and garden products was \$3,928,657. In 1903, according to the statistics of the United States Department of Agriculture, Indian corn ranked next to fruits (as given in the state reports), but its product as compared with that of various other states is unimportant—in 1907 it amounted to 7,017,000 bushels only; rice is the only other cereal whose yield in 1899 was greater than that of 1889, but the Florida product was surpassed (in 1899) by that of the Carolinas, Georgia, Louisiana and Texas; in 1907 the product of rice in Florida (69,000 bushels) was less than that of Texas, Louisiana, South Carolina, Arkansas and Georgia severally. Tobacco culture, which declined after 1860 on account of the competition of Cuba and Sumatra, has revived since 1885 through the introduction of Cuban and Sumatran seed; the product of 1907 (6,937,500 lb) was more than six times that of

¹ Almost everywhere limestone is the underlying rock, but siliceous sands, brought out by the Atlantic rivers to the N.E., are carried the whole length of the Florida coast by marine action.

1899, the product in 1899 (1,125,600 lb) being more than twice that of 1889 (470,443 lb), which in turn was more than twenty times that for 1880 (21,182 lb)—the smallest production recorded for many decades. In 1907 the average farm price of tobacco was 45 cents per lb higher than that of any other state. In 1899, 84% of the product was raised in Gadsden county. The sweet potato and pea-nut crops have also become very valuable; on the other hand the Census of 1900 showed a decline in acreage and production of cotton. In 1907 the acreage (265,000 acres) was less than in any cotton-growing state except Missouri and Virginia; the crop for 1907-1908 was 49,794 bales. Sea-island cotton of very high grade is grown in Alachua county. The production of sugar, begun by the early Spanish settlers, declined, but that of syrup increased. Pecan nuts are a promising crop, and many groves were planted after 1905. In 1900 there were more than 1,900,000 acres of land in the state unoccupied. The low lands of the South are being drained partly by the state and partly by private companies. Irrigation, introduced in 1888 by the orange growers, has been adopted by other farmers, especially the tobacco-growers of Gadsden county, and so the evil effects of the droughts, so common from February to June, are avoided. The value of farm property in the southern counties, which have been developed very recently, shows a steady increase, that of Hillsboro county surpassing the other counties of the state. In 1907-8, according to the state Department of Agriculture, the total value of all field crops (cotton, cereals, sugar-cane, hay and forage, sweet potatoes, &c.) was \$11,856,340, and the total value of all farm products (including live stock, \$20,817,804, poultry and products, \$1,688,433, and dairy products, \$1,728,642) was \$46,371,320.

The manufactures of Florida, as compared with those of other states, are unimportant. Their product in 1900 was more than twice the product in 1890, and the product in 1905 (from establishments under the factory system only) was \$50,298,290, *i.e.* 47.1% greater than in 1900. The most important industries were those that depended upon the forests, their product amounting to nearly 45% of the entire manufactured product of the state. The lumber and timber products were valued in 1905 at \$10,901,650, almost twice their valuation in 1890, and an increase of 1.2% over the product of 1900. The manufacture of turpentine and rosin, material for which is obtained from the pine forests, had increased greatly in importance between 1890 and 1900, the product in 1890 being valued at only \$191,859, that of 1900 at \$6,469,605, and from the latter sum it increased in 1905 to \$9,901,905, an increase of more than one-half. In 1900 the state ranked second and in 1905 first of all the states of the country in the value of this product; in 1905 the state's product amounted to 41.4% of that of the entire country. The manufacture of cigars and cigarettes (almost entirely of cigars, few cigarettes being manufactured), carried on chiefly by Cubans at Key West and Tampa, also increased in importance between 1890 and 1900, the products in the latter year being valued at \$10,735,826, or more than one-quarter more than in 1890, and in 1905 there was a further increase of 56.2%, the gross value being \$16,764,276, or nearly one-third of the total factory product of the state. In 1900 Florida ranked fourth in the manufacture of tobacco among the states of the Union, being surpassed by New York, Pennsylvania and Ohio; in 1905 it ranked third (after New York and Pennsylvania). Most of the tobacco used is imported from Cuba, though, as has been indicated, the production of the state has greatly increased since 1880. In the manufacture of fertilizers, the raw material for which is derived from the phosphate beds, Florida's aggregate product in 1900 was valued at \$500,239, and in 1905 at \$1,590,371, an increase of 217.9% in five years.

Florida's industrial progress has been mainly since the Civil War, for before that conflict a large part of the state was practically undeveloped. An important influence has been the railways. In 1880 the total railway mileage was 518 m.; in 1890 it was 2489 m.; in 1900, 3255 m., and in January 1909, 4,004.92 m. The largest system is the Atlantic Coast Line, the lines of which in Florida were built or consolidated by H. B. Plant (1819-1899) and once formed a part of the so-called "Plant System" of railways. The Florida East Coast Railway is also the product of one man's faith in the country, that of Henry M. Flagler (b. 1830). The Seaboard Air Line, the Louisville & Nashville, and the Georgia Southern & Florida are the other important railways. The Southern railway penetrates the state as far as Jacksonville, over the tracks of the Atlantic Coast Line. A state railway commission, whose members are elected by the people, has power

to enforce its schedule of freight rates except when such rates would not pay the operating expenses of the railway. In 1882 the Florida East Coast Line Canal and Transportation Co. was organized to develop a waterway from Jacksonville to Biscayne Bay by connecting with canals the St Johns, Matanzas, and Halifax rivers, Mosquito Lagoon, Indian river, Lake Worth, Hillsboro river, New river, and Snake Creek; in 1908 this vast undertaking was completed. The development of marine commerce has been retarded by unimproved harbours, but Fernandina and Pensacola harbours have always been good. Since 1890 much has been done by the national Government, aided in many cases by the local authorities and by private enterprise, to improve the harbours and to extend the limits of river navigation. With the increase of trade between the United States and the West Indies following the Spanish-American War (1898), the business of the principal ports, notably of Fernandina, Tampa and Pensacola, greatly increased.

Population.—The population of Florida in 1880 was 269,493; in 1890, 391,422, an increase of 45.2%; and in 1900, 528,542, or a further increase of 35%; and in 1905, by a state census, 614,845; and in 1910, 752,619. In 1900, 95.5% were native born, 43.7% were coloured (including 479 Chinese, Japanese and Indians), and in 1905 the percentages were little altered. The Seminole Indians, whose number is not definitely known, live in and near the Everglades. The urban population on the basis of places having a population of 4000 or more was 16.6% of the total in 1900 and 22.7% in 1905, the percentage for Florida, as for other Southern States, being small as compared with the percentage for most of the other states of the Union. In 1900 there were 92, and, in 1905, 125 incorporated cities, towns and villages; but only 14 (in 1905, 22) of these had a population of over 2000, and only 4 (in 1905, 8) a population of more than 5000. The four in 1900 were: Jacksonville (28,429); Pensacola (17,747); Key West (17,114); and Tampa (15,839). The eight in 1905 were Jacksonville (35,301), Tampa (22,823), Pensacola (21,505), Key West (20,498), Live Oak (7200), Lake City (6409), Gainesville (5413), and St Augustine (5121). Tallahassee is the capital of the state. In 1906 the Baptists were the strongest religious denomination; the Methodists ranked second, while the Roman Catholic, Presbyterian and Protestant Episcopal churches were of relatively minor importance.

Government.—The present constitution was framed in 1885 and was ratified by the people in 1886. Its most important feature, when compared with the previous constitution of 1868, is its provision for the choice of state officials other than the governor (who was previously chosen by election) by elections instead of by the governor's appointment, but the governor, who serves for four years and is not eligible for the next succeeding term, still appoints the circuit judges, the state attorneys for each judicial circuit and the county commissioners; he may fill certain vacancies and may suspend, and with the Senate remove officers not liable to impeachment. The governor is a member of the Board of Pardons, the other members being the attorney-general, the secretary of state, the comptroller and the commissioner of agriculture; he and the secretary of state, attorney-general, comptroller, treasurer, superintendent of public instruction, and commissioner of agriculture comprise a Board of Commissioners of State Institutions; he is also a member of the Board of Education. The office of lieutenant-governor was abolished by the present constitution. The legislature meets biennially, the senators being chosen for four, the representatives for two years. By an amendment of 1896 the Senate consists of not more than 32, and the House of Representatives of not more than 68 members; by a two-thirds vote of members present the legislature may pass a bill over the governor's veto. The three judges of the Supreme Court and the seven of the circuit court serve for six years, those of the county courts for four years, and justices of the peace (one for each justice district, of which the county commissioners must form at least two in each county) hold office for four years. The constitutional qualifications for suffrage are: the age of twenty-one years, citizenship in the United States or presentation of naturalization

certificates at registration centres, residence in the state one year and in the county six months, and registration. To these requirements the payment of a poll-tax has been added by legislative enactment, such an enactment having been authorized by the constitution. Insane persons and persons under guardianship are excluded by the constitution, and "all persons convicted of bribery, perjury, larceny or of infamous crime, or who shall make or become directly or indirectly interested in any bet or wager the result of which shall depend upon any election," or who shall participate as principal, second or challenger in any duel, are excluded by legislative enactment.

Amendments to the constitution may be made by a three-fifths vote of each house of the legislature, ratified by a majority vote of the people. A revision of the Constitution may be made upon a two-thirds vote of all members of both Houses of the legislature, if ratified by a majority vote of the people; a Constitutional Convention is then to be provided for by the legislature, such convention to meet within six months of the passage of the law therefor, and to consist of a number equal to the membership of the House of Representatives, apportioned among the counties, as are the members of this House.

A homestead of 160 acres, or of one-half of an acre in an incorporated town or city, owned by the head of a family residing in the state, with personal property to the value of \$1000 and the improvements on the real estate, is exempt from enforced sale except for delinquent taxes, purchase money, mortgage or improvements on the property. The wife holds in her own name property acquired before or after marriage; the intermarriage of whites and negroes (or persons of negro descent to the fourth generation) is prohibited. All these are constitutional provisions. By legislative enactment whites and blacks living in adultery are to be punished by imprisonment or fine; divorces may be secured only after two years' residence in the state and on the ground of physical incapacity, adultery, extreme cruelty, habitual indulgence in violent temper, habitual drunkenness, desertion for one year, previous marriage still existing, or such relationship of the parties as is within the degrees for which marriage is prohibited by law. Legitimacy of natural children can be established by subsequent marriage of the parents, and the age of consent is sixteen years.

The bonded debt was incurred during the Reconstruction Period (1865-1875). In 1871 7% 30 year bonds to the extent of \$350,000 were issued and in 1873 another issue of 6% 30 year bonds to the value of \$925,000 was made. Most of these were held by the Educational Fund at the time of their maturity. By 1901 all but \$267,700 of the issue of 1871 had been retired and this amount was then refunded with 3% 50 year bonds which were taken by the Educational Fund. In 1903 \$616,800 of the 1873 issue was held by the Educational Fund and \$148,000 by individuals. The first part of this claim was refunded by a new bond issue, also taken by the Educational Fund, the second was paid from an Indian war claim of \$692,946, received from the United States government in 1902, when \$132,000 bonds of 1857, held by the United States government, were also extinguished. The bonded debt was thus reduced to \$884,500; and on the 1st of January 1909 the debt, consisting of refunding bonds held as educational funds, amounted to \$601,567.

Penal System.—There is no penitentiary; the convicts are hired to the one highest bidder who contracts for their labour, and who undertakes, moreover, to lease all other persons convicted during the term of the lease, and sub-leases the prisoners. In 1889 the convicts were placed under the care of a supervisor of convicts, and in 1905 the law was amended so that one or more supervisors could be appointed at the will of the governors. In 1908 there were four supervisors and one state prison physician, and there are special laws designed to prevent abuses in the system. In 1908 the state received \$208,148 from the lease of convicts. Decrepit prisoners were formerly leased, but in 1906 the lease excluded such as were thought unfit by the state prison physician. Women convicts were still leased with the men in 1908; of the 446 convicts committed in that year, there were 15 negro females, 356 negro males and 75 white males. In the same year 54 escaped, and 27 were recaptured. The leased convicts are employed in the turpentine and lumber industries and in the phosphate works.

The 1232 convicts "on hand" at the close of 1908 were held in 38 camps, 4 being the minimum, and 160 the maximum number, at a camp. In 1908 two central hospitals for the prisoners were maintained by the lessee company. County prison camps are under the supervision of the governor and the supervisors of convicts. The state supervisors must inspect each state prison camp and each county prison camp every thirty days.

Education.—As early as 1831 an unsuccessful attempt was made to form an adequate public school fund; the first real effort to establish a common school system for the territory was made after 1835; in 1840 there were altogether 18 academies and 51 common schools, and in 1849 the state legislature made an appropriation in the interest of the public instruction of white pupils, and this was supplemented by the proceeds of land granted by the United States government for the same purpose. In 1852 Tallahassee established a public school; and in 1860 there were, according to a report of the United States census, 2032 pupils in the public schools of the state, and 4486 in "academies and other schools." The Civil War, however, interrupted the early progress, and the present system of common schools dates from the constitution of 1868 and the school law of 1869. The school revenue derived from the interest of a permanent school fund, special state and county taxes, and a poll-tax, in 1907-1908 amounted to \$1,716,161; the per capita cost for each child of school age was \$6.11 (white, \$9.08; negro, \$2.24), and the average school term was 108 days (112 for whites, 99 for negroes). The state constitution prescribes that "white and colored children shall not be taught in the same school, but impartial provision shall be made for both." The percentage of enrolment in 1907-1908 was 60 (whites, 66; negroes, 52). The percentage of attendance to enrolment was 70%—68% for white and 74% for negro schools. Before 1905 the state provided for higher education by the Florida State College, at Tallahassee, formerly the West Florida Seminary (founded in 1857); the University of Florida, at Lake City, which was organized in 1903 by enlarging the work of the Florida Agricultural College (founded in 1884); the East Florida Seminary, at Gainesville (founded 1848 at Ocala); the normal school (for whites) at De Funiak Springs; and the South Florida Military Institute at Bartow; but in 1905 the legislature passed the Buckman bill abolishing all these state institutions for higher education and establishing in their place the university of the state of Florida and a state Agricultural Experiment Station, both now at Gainesville, and the Florida Female College at Tallahassee, which has the same standards for entrance and for graduation as the state university for men. Private educational institutions in Florida are John B. Stetson University at De Land (Baptist); Rollins College (1885) at Winter Park (non-sectarian), with a collegiate department, an academy, a school of music, a school of expression, a school of fine arts, a school of domestic and industrial arts, and a business school; Southern College (1901), at Sutherland (Methodist Episcopal, South); the Presbyterian College of Florida (1905), at Eustis; Jasper Normal Institute (1890), at Jasper, and the Florida Normal Institute at Madison. The negroes have facilities for advanced instruction in the Florida Baptist Academy, and Cookman Institute (Methodist Episcopal, South), both at Jacksonville, and in the Normal and Manual Training School (Congregational), at Orange Park. There are a school for the Blind, Deaf, and Dumb (1885) at St. Augustine, a hospital for the insane at Chattahoochee and a reform school at Marianna, all wholly supported by the state, and a Confederate soldiers' and sailors' home at Tallahassee, which is partially supported by the state.

History.—The earliest explorations and attempts at colonization of Florida by Europeans were made by the Spanish. The Council of the Indies claimed that since 1510 fleets and ships had gone to Florida, and Florida is shown on the Cantino map of 1502. In 1513 Juan Ponce de Leon (c. 1460-1521), who had been with Christopher Columbus on his second voyage and had later been governor of Porto Rico, obtained a royal grant authorizing him to discover and settle "Bimini,"—a fabulous island believed to contain a marvellous fountain or spring

whose waters would restore to old men their youth or at least had wonderful curative powers. Soon after Easter Day he came in sight of the coast of Florida, probably near the mouth of the St Johns river. From the name of the day in the calendar, *Pascua Florida*, or from the fact that many flowers were found on the coast, the country was named Florida. De Leon seems to have explored the coast, to some degree, on both sides of the peninsula, and to have turned homeward fully convinced that he had discovered an immense island. He returned to Spain in 1514, and obtained from the king a grant to colonize "the island of Bimini and the island of Florida," of which he was appointed adelantado, and in 1521 he made another expedition, this one for colonization as well as for discovery. He seems to have touched at the island of Tortugas, so named on account of the large number of turtles found there, and to have landed at several places, but many of his men succumbed to disease and he himself was wounded in an Indian attack, dying soon afterward in Cuba. Meanwhile, in 1516, another Spaniard, Diego Miruelo, seems to have sailed for some distance along the west coast of the peninsula. The next important exploration of Florida was that of Panfilo de Narvaez. In 1527 he sailed from Cuba with about 600 men (soon reduced to less than 400), landed (early in 1528) probably at the present site of Pensacola, and for six months remained in the country, he and his men suffering terribly from exposure, hunger and fierce Indian attacks. In September, his ships being lost and his force greatly reduced in number, he hastily constructed a crazy fleet, re-embarked probably at Apalachee Bay, and lost his life in a storm probably near Pensacola Bay. Only four of his men, including Nuñez Cabeza de Vaca, succeeded after eight years of Indian captivity and of long and weary wanderings, in finding their way to Spanish settlements in Mexico. Florida was also partially explored by Ferdinando de Soto (*q.v.*) in 1539-1540. In the summer of 1559 another attempt at colonization was made by Tristan de Luna, who sailed from Vera Cruz, landed at Pensacola Bay, and explored a part of Florida and (possibly) Southern Alabama. Somewhere in that region he desired to make a permanent settlement, but he was abandoned by most of his followers and gave up his attempt in 1561.

In the following year, Jean Ribaut (1520-1565), with a band of French Huguenots, landed first near St Augustine and then at the mouth of the St Johns river, which he called the river of May, and on behalf of France claimed the country, which he described as "the fairest, fruitfulest and pleasantest of all the world"; but he made his settlement on an island near what is now Beaufort, South Carolina. In 1564 René de Laudonnière (? -c. 1586), with another party of Huguenots, established Fort Caroline at the mouth of the St Johns, but the colony did not prosper, and in 1565 Laudonnière was about to return to France when (on the 28th of August) he was reinforced by Ribaut and about 300 men from France. On the same day that Ribaut landed, a Spanish expedition arrived in the bay of St Augustine. It was commanded by Pedro Menéndez de Avilés (1523-1574), one of whose aims was to destroy the Huguenot settlement. This he did, putting to death almost the entire garrison at Fort Caroline "not as Frenchmen, but as Lutherans," on the 20th of September 1565. The ships of Ribaut were soon afterwards wrecked near Matanzas Inlet; he and most of his followers surrendered to Menéndez and were executed. Menéndez then turned his attention to the founding of a settlement which he named St Augustine (*q.v.*); he also explored the Atlantic coast from Cape Florida to St Helena, and established forts at San Mateo (Fort Caroline), Avista, Guale and St Helena. In 1567 he returned to Spain in the interest of his colony.

The news of the destruction of Fort Caroline, and the execution of Ribaut and his followers, was received with indifference at the French court; but Dominique de Gourgues (*c.* 1530-1593), a friend of Ribaut but probably a Catholic, organized an expedition of vengeance, not informing his men of his destination until his three ships were near the Florida coast. With the co-operation of the Indians under their chief Saturiba he captured Fort San Mateo in the spring of 1568, and on the spot where

the garrison of Fort Caroline had been executed, he hanged his Spanish prisoners, inscribing on a tablet of pine the words, "I do this not as unto Spaniards but as to traitors, robbers and murderers." Feeling unable to attack St Augustine, de Gourgues returned to France.

The Spanish settlements experienced many vicissitudes. The Indians were hostile and the missionary efforts among them failed. In 1586 St Augustine was almost destroyed by Sir Francis Drake and it also suffered severely by an attack of Captain John Davis in 1665. No until the last decade of the 17th century did the Spanish authorities attempt to extend the settlements beyond the east coast. Then, jealous of the French explorations along the Gulf of Mexico, they turned their attention to the west coast, and in 1696 founded Pensacola. When the English colonies of the Carolinas and Georgia were founded, there was constant friction with Florida. The Spanish were accused of inciting the Indians to make depredations on the English settlements and of interfering with English commerce and the Spanish were in constant fear of the encroachments of the British. In 1702, when Great Britain and Spain were contending in Europe, on opposite sides, in the war of the Spanish Succession, a force from South Carolina captured St Augustine and laid siege to the fort, but being unable to reduce it for lack of necessary artillery, burned the town and withdrew at the approach of Spanish reinforcements. In 1706 a Spanish and French expedition against Charleston, South Carolina, failed, and the Carolinians retaliated by invading middle Florida in 1708 and again in 1722. In 1740 General James Edward Oglethorpe, governor of Georgia, supported by a naval force, made an unsuccessful attack upon St Augustine; two years later a Spanish expedition against Savannah by way of St Simon's Island failed, and in 1745 Oglethorpe again appeared before the walls of St Augustine, but the treaty of Aix-la-Chapelle in 1748 prevented further hostilities. Pensacola, the other centre of Spanish settlement, though captured and occupied (1719-1723) by the French from Louisiana, had a more peaceful history.

By the treaty of Paris in 1763 Florida was ceded to England in return for Havana. The provinces of East Florida and West Florida were now formed, the boundaries of West Florida being 31° N. lat. (when civil government was organized in 1767, the N. line was made 32° 28'), the Chattahoochee, and the Apalachicola rivers, the Gulf of Mexico, Mississippi Sound, Lakes Borgne, Pontchartrain and Maurepas, and the Mississippi river. A period of prosperity now set in. Civil in place of military government was instituted; immigration began; and Andrew Turnbull, an Englishman, brought over a band of about 1500 Minorcans (1769), whom he engaged in the cultivation of indigo at New Smyrna. Roads were laid out, some of which yet remain; and in the last three years of English occupation the government spent \$580,000 on the two provinces. Consequently, the people of Florida were for the most part loyal to Great Britain during the War of American Independence. In 1776, the Minorcans of New Smyrna refused to work longer on the indigo plantations; and many of them removed to St Augustine, where they were protected by the authorities. Several plans were made to invade South Carolina and Georgia, but none matured until 1778, when an expedition was organized which co-operated with British forces from New York in the siege of Savannah, Georgia. In the following year, Spain having declared war against Great Britain, Don Bernardo de Galvez (1756-1794), the Spanish governor at New Orleans, seized most of the English forts in West Florida, and in 1781 captured Pensacola.

By the treaty of Paris (1783) Florida reverted to Spain, and, no religious liberty being promised, many of the English inhabitants left East and West Florida. A dispute with the United States concerning the northern boundary was settled by the treaty of 1795, the line 31° N. lat. being established.

The westward expansion of the United States made necessary American ports on the Gulf of Mexico; consequently the acquisition of West Florida as well as of New Orleans was one of the

aims of the negotiations which resulted in the Louisiana Purchase of 1803. After the cession of Louisiana to the United States, the people of West Florida feared that that province would be seized by Bonaparte. They, therefore, through a convention at Buhler's Plains (July 17, 1810), formulated plans for a more effective government. When it was found that the Spanish governor did not accept these plans in good faith, another convention was held on the 26th of September which declared West Florida to be an independent state, organized a government and petitioned for admission to the American Union. On the 27th of October President James Madison, acting on a theory of Robert R. Livingston that West Florida was ceded by Spain to France in 1800 along with Louisiana, and was therefore included by France in the sale of Louisiana to the United States in 1803, declared West Florida to be under the jurisdiction of the United States. Two years later the American Congress annexed the portion of West Florida between the Pearl and the Mississippi rivers to Louisiana (hence the so-called Florida parishes of Louisiana), and that between the Pearl and the Perdido to the Mississippi Territory.

In the meantime war between Great Britain and the United States was imminent. The American government asked the Spanish authorities of East Florida to permit an American occupation of the country in order that it might not be seized by Great Britain and made a base of military operations. When the request was refused, American forces seized Fernandina in the spring of 1812, an action that was repudiated by the American government after protest from Spain, although it was authorized in official instructions. About the same time an attempt to organize a government at St Mary's was made by American sympathizers, and a petty civil war began between the Americans, who called themselves "Patriots," and the Indians, who were encouraged by the Spanish. In 1814 British troops landed at Pensacola to begin operations against the United States. In retaliation General Andrew Jackson captured the place, but in a few days withdrew to New Orleans. The British then built a fort on the Apalachicola river, and there directed expeditions of Indians and runaway negroes against the American settlements, which continued long after peace was concluded in 1814. In 1818 General Jackson, believing that the Spanish were aiding the Seminole Indians and inciting them to attack the Americans, again captured Pensacola. By the treaty of 1819 Spain formally ceded East and West Florida to the United States; the treaty was ratified in 1821, when the United States took formal possession, but civil government was not established until 1822.

Indian affairs furnished the most serious problems of the new Territory of Florida. The aborigines, who seemed to have reached a stage of civilization somewhat similar to that of the Aztecs, were conquered and exterminated or absorbed by Creeks about the middle of the 18th century. There was a strong demand for the removal of these Creek Indians, known as Seminoles, and by treaties at Payne's Landing in 1832 and Fort Gibson in 1833 the Indian chiefs agreed to exchange their Florida lands for equal territory in the western part of the United States. But a strong sentiment against removal suddenly developed, and the efforts of the United States to enforce the treaty brought on the Seminole War (1836-42), which resulted in the removal of all but a few hundred Seminoles whose descendants still live in southern Florida.

In 1845 Florida became a state of the American Union. On the 10th of January 1861 an ordinance of secession, which declared Florida to be a "sovereign and independent nation," was adopted by a state convention, and Florida became one of the Confederate States of America. The important coast towns were readily captured by Union forces; Fernandina, Pensacola and St Augustine in 1862, and Jacksonville in 1863; but an invasion of the interior in 1864 failed, the Union forces being repulsed in a battle at Olustee (on the 20th of February 1864). In 1865 a provisional governor was appointed by President Andrew Johnson, and a new state government was organized. The legislature of 1866 rejected the Fourteenth Amendment

to the Federal Constitution, and soon afterwards Florida was made a part of the Third Military District, according to the Reconstruction Act of 1867. Negroes were now registered as voters by the military authorities, and another Constitutional Convention met in January and February 1868. A factional strife in the dominant party, the Republican, now began; fifteen delegates withdrew from the convention; the others framed a constitution, and then resolved themselves into a political convention. The seceding members with nine others then returned and organized; but the factions were reconciled by General George M. Meade. A new constitution was framed and was ratified by the electors, and Florida passed from under a quasi-military to a full civil government on the 4th of July 1868.

The factional strife in the Republican party continued, a number of efforts being made to impeach Governor Harrison Reed (1813-1899). The decisive year of the Reconstruction Period was 1876. The Canvassing Board, which published the election returns, cast out some votes, did not wait for the returns from Dade county, and declared the Republican ticket elected. George F. Drew (1827-1900), the Democratic candidate for governor, then secured a mandamus from the circuit court restraining the board from going behind the face of the election returns; this was not obeyed and a similar mandamus was therefore obtained from the supreme court of Florida, which declared that the board had no right to determine the legality of a particular vote. According to the new count thus ordered, the Democratic state ticket was elected. By a similar process the board's decision in favour of the election of Republican presidential electors was nullified, and the Democratic electors were declared the successful candidates; but the electoral commission, appointed by Congress, reversed this decision. (See ELECTORAL COMMISSION.)

Since 1876 Florida has been uniformly Democratic in politics.

AMERICAN GOVERNORS OF FLORIDA.

Territorial Governors.

Andrew Jackson	1821-1822
William P. Duval	1822-1834
John H. Eaton	1834-1835
Richard K. Call	1835-1840
Robert R. Reid	1840-1841
Richard K. Call	1841-1844
John Branch	1844-1845

State Governors.

William D. Moseley	1845-1849	Democrat
Thomas Brown	1849-1853	Whig
James E. Broome	1853-1857	Democrat
Madison S. Perry	1857-1861	"
John Milton	1861-1865	"
William Marvin	1865	Provisional
David S. Walker	1865-1868	Democrat
Harrison Reed	1868-1872	Republican
Ossian B. Hart	1873-1874	"
Marcellus L. Stearns	1874-1877	"
George F. Drew	1877-1881	Democrat
William D. Bloxham	1881-1885	"
Edward A. Perry	1885-1889	"
Francis P. Fleming	1889-1893	"
Henry L. Mitchell	1893-1897	"
William D. Bloxham	1897-1901	"
William S. Jennings	1901-1905	"
Napoleon B. Broward	1905-1909	"
Albert W. Gilchrist	1909-	"

BIBLIOGRAPHY.—Physical and economic conditions are discussed in a pamphlet (591 pp.) published by the State Department of Agriculture, *Florida, a Pamphlet Descriptive of its History, Topography, Climate, Soil, &c.* (Tallahassee, 1904); in *Climate, Soil and Resources of Florida* (United States Department of Agriculture, Washington, 1882); *A Preliminary Report on the Soils of Florida* (United States Department of Agriculture, Division of Soils, Bulletin 13, 1898); C. L. Norton's *Handbook of Florida* (2nd edition, New York, 1892); the volumes of the Twelfth Census of the United States (for 1900) which treat of Agriculture and Manufactures, and the Special Report on Mines and Quarries for 1902. J. N. MacGonigle's "Geography of Florida" (*National Geographic Magazine*, vol. 7), T. D. A. Cockerell's "West Indian Fauna in Florida" (*Nature*, vol. 46), L. F. Pourtales's "Flora and Fauna of the Florida Keys" (*American Naturalist*, vol. 11), and C. F. Millspaugh's *Flora of the Sand Keys of Florida* (Chicago, 1907), a Field Columbian Museum publication, are of value. To sportsmen, C. B. Cory's *Hunting and Fishing in Florida* (Boston, 1896) and A. W. and

J. A. Dimock's *Florida Enchantments* (New York, 1908) are of interest. For administration, see Wilbur F. Yocum's *Civil Government of Florida* (De Land, Florida, 1904); and the *Revised Statutes of Florida* (1892). The standard history is that by G. R. Fairbanks, *History of Florida* (Philadelphia, 1871). This should be supplemented by D. G. Brinton's *Notes on the Floridian Peninsula, its Literary History, Indian Tribes and Antiquities* (Philadelphia, 1859), which has an excellent descriptive bibliography of the early explorations: Woodbury Lowery, *The Spanish Settlements within the Present Limits of the United States* (New York, vol. i., 1901; vol. ii., sub-title *Florida*, 1905); R. L. Campbell's *Historical Sketches of Colonial Florida* (Cleveland, 1892), which treats at length of the history of Pensacola; H. E. Chambers's *West Florida and its Relation to the Historical Cartography of the United States* (Johns Hopkins Studies in Historical and Political Science, Series 16, No. 5); and Herbert B. Fuller's *The Purchase of Florida; its History and Diplomacy* (Cleveland, O., 1906). The only published collections of documents relating to the state are Buckingham Smith's *Collección de varios documentos para la historia de la Florida y tierras adyacentes* (London, 1857), and Benjamin F. French's *Historical Collections of Louisiana* (New York, 1846-1875).

FLORIDABLANCA, DON JOSE MOÑO Y REDONDO, COUNT OF (1728-1808), Spanish statesman, was born at Murcia in 1728. He was the son of a retired army officer, and received a good education, which he completed at the university of Salamanca, especially applying himself to the study of law. For a time he followed the profession of an advocate, and acquired a high reputation. A more public career was opened to him by the marquis of Esquilache, then chief minister of state, who sent him ambassador to Pope Clement XIV. Successful in his mission, he was soon after appointed by Charles III. successor to his patron, and his administration was one of the most brilliant Spain had ever seen. He regulated the police of Madrid, reformed many abuses, projected canals, established many societies of agriculture and economy and many philanthropic institutions, and gave encouragement to learning, science and the fine arts. Commerce flourished anew under his rule, and the long-standing disputes with Portugal about the South American colonies were settled. He sought to strengthen the alliance of Spain with Portugal by a double marriage between the members of the royal houses, designing by this arrangement to place ultimately a Spanish prince on the throne of Portugal. But in this he failed. Floridablanca was the right-hand man of King Charles III. in his policy of domestic reform, and was much under the influence of French *philosophes* and economic writers. Like other reformers of that school he was a strong supporter of the royal authority and a convinced partisan of benevolent despotism. The French Revolution frightened him into reaction, and he advocated the support of the first coalition against France. He retained his office for three years under Charles IV.; but in 1792, through the influence of the favourite Godoy, he was dismissed and imprisoned in the castle of Pampeluna. Here he was saved from starvation only by the intervention of his brother. He was afterwards allowed to retire to his estates, and remained in seclusion till the French invasion of 1808. He was then called by his countrymen to take the presidency of the central junta. But his strength failed him, and he died at Seville on the 20th of November of the same year. He left several short treatises on jurisprudence.

See *Obras originales del Conde de Floridablanca*, edited, with biographical introduction, by A. Ferrer del Rio; in the *Biblioteca de Rivadeneira*, vol. lix.

FLORIDOR [JOSIAS DE SOULAS, Sieur de Prinefosse] (d. c. 1671), French actor, was born in Brie early in the 17th century, the son of a gentleman of German family who had moved to France, married there, and become a Roman Catholic. The son entered the French army, but after being promoted ensign, quitted the army for the theatre, where he took the name of Floridor. His first Paris appearance was in 1640. Three years later he was called to the company at the Hôtel de Bourgogne, where he played all the leading parts in tragedy and comedy and became the head of his profession. He was a man of superb physique and excellent carriage, with a flexible and sonorous voice, and manners of rare distinction and elegance. He was much liked at court, and Louis XIV. held him in particular esteem. He died in 1671 or 1672.

FLORIN, the name applied to several coins of the continent of Europe and to two coins struck in England at different times. The word comes through the Fr. *florin* from the Ital. *florino*, flower, Lat. *flos, florem*. Fiorino was the Italian name of a gold coin issued at Florence in 1252, weighing about fifty-four grains. This coin bore on the obverse a lily, from which it took its name of "the flower," on the reverse the Latin name of the city *Florentia*, from which it was also known as a "florencia." "Florin" and "florencia" seem to have been used in English indiscriminately as the name of this coin. The Florentine florin was held in great commercial repute throughout Europe, and similar coins were struck in Germany, other parts of Italy, France, &c. The English gold florin was introduced by Edward III. in 1343, half and quarter florins being struck at the same time. This gold florin weighed 108 grains and was to be current for six shillings. It was found, however, to be overvalued in proportion to the silver currency and was demonetized the following year. The florin did not again appear in the English coinage until 1849, when silver coins with this name, having a nominal value of two shillings (one-tenth of a pound), were struck. When first issued the "Dei gratia" was omitted from the inscription, and they were frequently referred to as the "Godless" or "graceless" florins. The D.G. was added in 1852. In 1887 a double florin or four shilling piece was issued, but its coinage was discontinued in 1890. The total value of double florins issued during these years amounted to £533,125. (See also NUMISMATICS.)

FLORIO, GIOVANNI (1553?-1625), English writer, was born in London about 1553. He was of Tuscan origin, his parents being Waldenses who had fled from persecution in the Valtelline and taken refuge in England. His father, Michael Angelo Florio, was pastor of an Italian Protestant congregation in London in 1550. He was attached to the household of Sir William Cecil, but dismissed on a charge of immorality. He dedicated a book on the Italian language to Henry Herbert, and may have been a tutor in the family of William Herbert, earl of Pembroke. Anthony à Wood says that the Florios left England on the accession of Queen Mary, but returned after her death. The son resided for a time at Oxford, and was appointed, about 1576 tutor to the son of Richard Barnes, bishop of Durham, then studying at Magdalen College. In 1578 Florio published a work entitled *First Fruits, which yield Familiar Speech, Merry Proverbs, Witty Sentences, and Golden Sayings* (4to). This was accompanied by *A Perfect Induction to the Italian and English Tongues*. The work was dedicated to the earl of Leicester. Three years later Florio was admitted a member of Magdalen College, and became a teacher of French and Italian in the university. In 1591 appeared his *Second Fruits, to be gathered of Twelve Trees, of divers but delightful Tastes to the Tongues of Italian and English men*; to which was annexed the *Garden of Recreation, yielding six thousand Italian Proverbs* (4to). These manuals contained an outline of the grammar, a selection of dialogues in parallel columns of Italian and English, and longer extracts from classical Italian writers in prose and verse. Florio had many patrons; he says that he "lived some years" with the earl of Southampton, and the earl of Pembroke also befriended him. His Italian and English dictionary, entitled *A World of Words*, was published in folio in 1598. After the accession of James I., Florio was named French and Italian tutor to Prince Henry, and afterwards became a gentleman of the privy chamber and clerk of the closet to the queen, whom he also instructed in languages. His *magnum opus* is the admirable translation of the *Essays on Morall, Politike, and Millitarie Discourses of Lo. Michael de Montaigne*, published in folio in 1603 in three books, each dedicated to two noble ladies. A second edition in 1613 was dedicated to the queen. Special interest attaches to the first edition from the circumstance that of the several copies in the British Museum library one bears the autograph of Shakespeare—long received as genuine but now supposed to be by an 18th-century hand—and another that of Ben Jonson. It was suggested by Warburton that Florio is satirized by Shakespeare under the character of Holofernes, the

pompous pedant of *Love's Labour's Lost*, but it is much more likely, especially as he was one of the earl of Southampton's protégés, that he was among the personal friends of the dramatist, who may well have gained his knowledge of Italian and French from him. He had married the sister of the poet Daniel, and had friendly relations with many writers of his day. Ben Jonson sent him a copy of *Volpone* with the inscription, "To his loving father and worthy friend Master John Florio, Ben Jonson seals this testimony of his friendship and love." He is characterized by Wood, in *Athenae Oxonienses*, as a very useful man in his profession, zealous for his religion, and deeply attached to his adopted country. He died at Fulham, London, in the autumn of 1625.

FLORIS, FRANS, or more correctly FRANS DE VRIENDT, called FLORIS (1520-1570), Flemish painter, was one of a large family trained to the study of art in Flanders. Son of a stonemason, Cornelis de Vriendt, who died at Antwerp in 1538, he began life as a student of sculpture, but afterwards gave up carving for painting. At the age of twenty he went to Liège and took lessons from Lambert Lombard, a pupil of Mabuse, whose travels in Italy had transformed a style truly Flemish into that of a mongrel Leonardesque. Following in the footsteps of Mabuse, Lambert Lombard had visited Florence, and caught the manner of Salviati and other pupils of Michelangelo and Del Sarto. It was about the time when Schoreel, Coxcie and Heemskerck, after migrating to Rome and imitating the masterpieces of Raphael and Buonarroti, came home to execute Dutch-Italian works beneath the level of those produced in the peninsula itself by Leonardo da Pistoia, Nanaccio and Rinaldo of Mantua. Fired by these examples, Floris in his turn wandered across the Alps, and appropriated without assimilation the various mannerisms of the schools of Lombardy, Florence and Rome. Bold, quick and resolute, he saw how easy it would be to earn a livelihood and acquire a name by drawing for engravers and painting on a large scale after the fashion of Vasari. He came home, joined the guild of Antwerp in 1540, and quickly opened a school from which 120 disciples are stated to have issued. Floris painted strings of large pictures for the country houses of Spanish nobles and the villas of Antwerp patricians. He is known to have illustrated the fable of Hercules in ten compositions, and the liberal arts in seven, for Claes Jongeling, a merchant of Antwerp, and adorned the duke of Arschot's palace of Beaumont with fourteen colossal panels. Comparatively few of his works have descended to us, partly because they came to be condemned for their inherent defects, and so were suffered to perish, partly because they were soon judged by a different standard from that of the Flemings of the 16th century. The earliest extant canvas by Floris is the "Mars and Venus ensnared by Vulcan" in the Berlin Museum (1547), the latest a "Last Judgment" (1566) in the Brussels gallery. Neither these nor any of the intermediate works at Alost, Antwerp, Copenhagen, Dresden, Florence, Léau, Madrid, St Petersburg and Vienna display any charm of originality in composition or in form. Whatever boldness and force they may possess, or whatever principles they may embody, they are mere appropriations of Italian models spoiled in translation or adaptation. Their technical execution reveals a rapid hand, but none of the lustre of bright colouring; and Floris owed much of his repute to the cleverness with which his works were transferred to copper by Jerome Cock and Theodore de Galle. Whilst Floris was engaged on a Crucifixion of 27 ft., and a Resurrection of equal size, for the grand prior of Spain, he was seized with illness, and died on the 1st of October 1570 at Antwerp.

FLORUS, Roman historian, flourished in the time of Trajan and Hadrian. He compiled, chiefly from Livy, a brief sketch of the history of Rome from the foundation of the city to the closing of the temple of Janus by Augustus (25 B.C.). The work, which is called *Epitome de T. Livio Bellorum omnium annorum DCC Libri duo*, is written in a bombastic and rhetorical style, and is rather a panegyric of the greatness of Rome, whose life is divided into the four periods of infancy, youth, manhood and old age. It is often wrong in geographical and chronological

details; but, in spite of its faults, the book was much used in the middle ages. In the MSS. the writer is variously given as Julius Florus, Lucius Anneus Florus, or simply Annaeus Florus. From certain similarities of style he has been identified with Publius Annus Florus, poet, rhetorician and friend of Hadrian, author of a dialogue on the question whether Virgil was an orator or poet, of which the introduction has been preserved.

The best editions are by O. Jahn (1852), C. Halm (1854), which contain the fragments of the Virgilian dialogue. There is an English translation in Bohn's *Classical Library*.

FLORUS, JULIUS, poet, orator, and jurist of the Augustan age. His name has been immortalized by Horace, who dedicated to him two of his *Epistles* (i. 3; ii. 2), from which it would appear that he composed lyrics of a light, agreeable kind. The statement of Porphyryon, the old commentator on Horace, that Florus himself wrote satires, is probably erroneous, but he may have edited selections from the earlier satirists (Ennius, Lucilius, Varro). Nothing is definitely known of his personality, except that he was one of the young men who accompanied Tiberius on his mission to settle the affairs of Armenia. He has been variously identified with Julius Florus, a distinguished orator and uncle of Julius Secundus, an intimate friend of Quintilian (*Instit.* x. 3, 13); with the leader of an insurrection of the Treviri (Tacitus, *Ann.* iii. 40); with the Postumus of Horace (*Odes*, ii. 14) and even with the historian Florus.

FLORUS, PUBLIUS ANNIUS, Roman poet and rhetorician, identified by some authorities with the historian Florus (*q.v.*). The introduction to a dialogue called *Virgilius orator an poeta* is extant, in which the author (whose name is given as Publius Annus Florus) states that he was born in Africa, and at an early age took part in the literary contests on the Capitol instituted by Domitian. Having been refused a prize owing to the prejudice against African provincials, he left Rome in disgust, and after travelling for some time set up at Tarraco as a teacher of rhetoric. Here he was persuaded by an acquaintance to return to Rome, for it is generally agreed that he is the Florus who wrote the well-known lines quoted together with Hadrian's answer by Aelius Spartianus (*Hadrian* 16). Twenty-six trochaic tetrameters, *De qualitate vitae*, and five graceful hexameters, *De rosas*, are also attributed to him. Florus is important as being the first in order of a number of 2nd-century African writers who exercised a considerable influence on Latin literature, and also the first of the *poetae neoterici* or *novelli* (new-fashioned poets) of Hadrian's reign, whose special characteristic was the use of lighter and graceful metres (anapaestic and iambic dimeters), which had hitherto found little favour.

The little poems will be found in E. Bährens, *Poetae Latini minores* (1879-1883); for an unlikely identification of Florus with the author of the *Pervigilium Veneris* (*q.v.*) see E. H. O. Müller, *De P. Annio Floro poeta et de Pervigilio Veneris* (1855), and, for the poet's relations with Hadrian, F. Eyssenhardt, *Hadrian und Florus* (1882); see also F. Marx in Pauly-Wissowa's *Realencyclopädie*, i. pt. 2 (1894).

FLOTOW, FRIEDRICH FERDINAND ADOLF VON, FREIHERR (1812-1883), German composer, was born on his father's estate at Teutendorf, in Mecklenburg, on the 27th of April 1812. Destined originally for the diplomatic profession, his passion for music induced his father to send him to Paris to study under Reicha. But the outbreak of the revolution in 1830 caused his return home, where he busied himself writing chamber-music and operetta until he was able to return to Paris. There he produced *Pierre et Catherine*, *Rob Roy*, *La Duchesse de Guise*, but made his first real success with *Le Naufrage de la Méduse* at the Renaissance Théâtre in 1838. Greater, however, was the success which attended *Stradella* (1844) and *Mariha* (1847), which made the tour of the continent. In 1848 Flotow was again driven home by the Revolution, and in the course of a few years he produced *Die Grossfürstin* (1850), *Indra* (1853), *Rübezahl* (1854), *Hilda* (1855) and *Albin* (1856). From 1856 to 1863 he was director (Intendant) of the Schwerin opera, but in the latter year he returned to Paris, where in 1869 he produced *L'Ombré*. From that time to the date of his death he lived in Paris or on his estate near Vienna. He died on the 24th of

January 1883. Of his concert-music only the *Jubelouverture* is now ever heard. His strength lay in the facility of his melodies.

FLOTSAM, JETSAM and **LIGAN**, in English law, goods lost at sea, as distinguished from goods which come to land, which are technically designated *wreck*. Jetsam (the same word as *jettison*, from Lat. *jactare*, to throw) is when goods are cast into the sea, and there sink and remain under water; flotsam (*floatson*, from *float*, Lat. *flottare*) is where they continue floating on the surface of the waves; ligan (or *lagan*, from *lay* or *lie*) is where they are sunk in the sea, but tied to a cork or buoy in order to be found again. Flotsam, jetsam and ligan belong to the sovereign in the absence only of the true owner. Wreck, on the other hand (*i.e.* goods cast on shore), was by the common law adjudged to the sovereign in any case, because it was said by the loss of the ship all property was gone out of the original owner. This singular distinction which treated goods washed ashore as lost, and goods on and in the sea as not lost, is no doubt to be explained by the primitive practice of plundering wrecked ships. (See **WRECK**.)

FLOUNDER, a common term for flat-fish. The name is also more specially given to certain varieties, according to local usage. Thus the *Pleuronectes flesus* is the common flounder of English terminology, found along the coasts of northern Europe from the Bristol Channel to Iceland. It is particularly partial to fresh water, ascending the Rhine as far as Cologne. It rarely exceeds a length of 12 in. or a weight of 1½ lb. In American terminology the principal fish of the name are the "summer flounders" or "deep-sea flounders," also known in America as "plaice" (*Paralichthys dentatus*), as long as 3 ft. and as heavy as 15 lb; the "four-spotted flounders" (*Paralichthys oblongus*); the "common" or "winter" flounder (*Pseudopleuronectes americanus*); the "diamond flounder" (*Hysopsetta guttulata*); and the "pole flounder" (*Glyptocephalus cynoglossus*).

FLOUR and **FLOUR MANUFACTURE**. The term "flour" (Fr. *fleur*, flower, *i.e.* the best part) is usually applied to the triturated farinaceous constituents of the wheat berry (see **WHEAT**); it is, however, also used of other cereals and even of leguminoids when ground into a fine powder, and of many other substances in a pulverulent state, though in these cases it is usual to speak of rye flour, bean flour, &c. The flour obtained from oats is generally termed oatmeal. In Great Britain wheaten flour was commonly known in the 16th and 17th centuries as meal, and up to the beginning of the 19th century, or perhaps later, the term mealing trade was not infrequently used of the milling trade.

The ancestor of the millstone was apparently a rounded stone about the size of a man's fist, with which grain or nuts were pounded and crushed into a rude meal. These stones are generally of hard sandstone and were evidently used against another stone, which by dint of continual hammering was broken into hollows. Sometimes the crusher was used on the surface of rocks. St Bridget's stone, on the shore of Lough Macnean, is supposed to have been a primitive Irish mill; there are many depressions in the face of the table-like rock, and it is probable that round this stone several women (for in early civilization the preparation of flour was peculiarly the duty of the women) would stand and grind, or rather pound, meal. Many such stones, known as Bullan stones, still exist in Ireland. Similar remains are found in the Orkneys and Shetlands, and it is on record that some of these stones have been used for flour-making within historic times. Richard Bennett in his *History of Corn Milling* remarks that the Seneca Indians to this day boil maize and crush it into a paste between loose stones. In the same way the Omahas pound this cereal in holes in the rocks, while the Oregon Indians parch and pound the capsules of the yellow lily, much after the fashion described by Herodotus in his account of the ancient Egyptians. In California the Indian squaws make a sort of paste by crushing acorns between a round stone or "muller," and a cuplike hollow in the surface of a rock. Crushing stones are of different shapes, ranging

from the primitive ball-like implement to an elongated shape resembling the pestle of a mortar. Mullers of the latter type are not infrequent among prehistoric remains in America, while Dr Schliemann discovered several specimens of the globular form on the reputed site of the city of Troy, and also among the ruins of Mycenae. As a matter of fact stone mullers survived in highly civilized countries into modern days, if indeed they are now altogether extinct.

The saddle-stone is the connecting link between the primitive pounder, or muller, and the quern, which was itself the direct ancestor of the millstones still used to some extent in the manufacture of flour. The saddle-stone, the first true grinding implement, consisted of a stone with a more or less concave face on which the grain was spread, and in and along this hollow surface it was rubbed and ground into coarse meal. Saddle-stones have been discovered in the sand caves of Italy, among the lake dwellings of Switzerland, in the dolmens of France, in the pit dwellings of the British Isles, and among the remains of primitive folk all the world over. The Romans of the classical period seem to have distinguished the saddle-stone from the quern. We find allusions to the *mola trusatilis*, which may be translated "the thrusting mill"; this would fairly describe a backwards and forwards motion. The *mola versatilis* evidently referred to the revolving millstone or quern. In primitive parts of the world the saddle-stone is not yet extinct, as for instance in Mexico. It is known as the *metata*, and is used both for grinding maize and for making the maize cakes known as tortillas. The same implement is apparently still in use in some parts of South America, notably in Chile.

According to Richard Bennett, the quern, the first complete milling machine, originated in Italy and is in all probability not older than the 2nd century B.C. This is, however, a controverted point. Querns are still used in most primitive countries, nor is it certain that they have altogether disappeared from remoter districts of Scotland and Ireland. Whatever was their origin, they revolutionized flour milling. The rotary motion of millstones became the essential principle of the trituration of grain, and exists to-day in the rolls of the roller mill. The early quern appears to have differed from its descendants in that it was somewhat globular in shape, the lower stone being made conical, possibly with the idea that the ground flour should be provided with a downward flow to enable it to fall from the stones. This type did not, however, persist. Gradually the convexity disappeared and the surface of the two stones became flat or very nearly so. In the upper stone was a species of funnel, through which the grain passed as through a hopper, making its way thence, as the stone revolved, into the space between the running and the bed stone. The ground meal was discharged at the periphery. The runner, or upper stone, was provided with a wooden handle by which the stone was revolved. The typical Roman mill of the Augustan age may be seen at Pompeii. Here, in what is believed to have been a public *pistrinum* or mill, were found four pairs of millstones. The circular base of these mills is 5 ft. in diameter and 1 ft. high, and upon it was fastened the *meta*, a blunt cone about 2 ft. high, on which fitted the upper millstone or *catillus*, also conical. These mills were evidently rotated by slave labour, as there was no room for the perambulation of a horse or donkey, while the side-lugs in which the handle-bars were inserted are plainly visible. Slave labour was generally used up to the introduction of Christianity, but was finally abolished by the emperor Constantine, though even after his edict mills continued to be driven by criminals.

The Romans are credited by some authorities with having first applied power to the driving of millstones, which they connected with water-wheels by a horizontal spindle through the intervention of bevel gearing. But long after millstones had been harnessed to water power slave labour was largely employed as a motive force. The water-mill of the Romans was introduced at a relatively early period into Britain. Domesday Book shows that England was covered by mills of a kind at the time of the Norman conquest, and

Saddle-stone.

Quern.

Primitive grinding.

Use of power.

mentions some 500 mills in the counties of Norfolk and Suffolk alone. No doubt the *mola* of Domesday Book consisted of one pair of stones connected by rude gearing with a water-wheel. Windmills are said to have been introduced by the Crusaders, who brought them from the East. Steam power is believed to have been first used in a British flour mill towards the close of the 18th century, when Boulton & Watt installed a steam engine in the Albion Flour Mills in London, erected under the care of John Rennie. Another great engineer, Sir William Fairbairn, in the early days of the 19th century, left the impress of his genius on the mill and all its accessories. He was followed by other clever engineers, and in the days immediately preceding the roller period many improvements were introduced as regards the balancing and driving of millstones. The introduction of the blast and exhaust to keep the stones cool was a great step in advance, while the substitution of silk gauze for woollen or linen bolting cloth, about the middle of the 19th century, marked another era in British milling. Millstones, as used just before the introduction of roller milling, were from 4 to 4½ ft. in diameter by some 12 in. in thickness, and were usually made of a siliceous stone, known as buhr-stone, much of which came from the quarry of La Ferté-sous-Jouarre, in France.

Nine-tenths, or perhaps ninety-nine hundredths, of all the flour consumed in Great Britain is made in roller mills, that is, mills in which the wheat is broken and floured by means of rollers, some grooved in varying degrees of fineness, some smooth, their work being preceded and supplemented by a wide range of other machinery. All roller mills worthy of the name are completely automatic, that is to say, from the time the raw material enters the mill warehouse till it is sacked, either in the shape of finished flour or of offals, it is touched by no human hand.

The history of roller milling extends back to the first half of the 19th century. Roller mills, that is to say, machines fitted with rolls set either horizontally, or vertically, or obliquely, for the grinding of corn, are said to have been used as far back as the 17th century, but if this be so it is certain that they were only used in a tentative manner. Towards the middle of the 19th century the firm of E. R. & F. Turner, of Ipswich, began to build roller mills for breaking wheat as a preliminary to the conversion of the resultant middlings on millstones. The rolls were made of chilled iron and were provided with serrated edges, which must have exercised a tearing action on the integuments of the berry. These mills were built to the design of a German engineer, of the name of G. A. Buchholz, and were exhibited at the London exhibition of 1862, but they never came into general use. It has also been stated that as early as 1823 a French engineer, named Collier, of Paris, patented a roller mill, while five years later a certain Malar took out another French patent, the specification of which speaks of grooves and differential speeds. But the direct ancestors of the roller mills of the present day were brought out some time in the third decade of the 19th century by a Swiss engineer named Sulzberger. His apparatus was rather cumbrous, and the chilled iron rolls with which it was fitted consumed a large amount of power relatively to the work effected. But the Pester Walz-Mühle, founded in 1839 by Count Szechenyi, a Hungarian nobleman, which took its name from the roller mills with which it was equipped by Sulzberger, was for many years a great success; some of its roller mills are said to have been kept at work for upwards of forty years, and one at least is preserved in the museum at Budapest.

It may be noted that Hungarian wheat is hard and flinty and well adapted for treatment by rolls. Moreover, gradual reduction, as now understood, was more or less practised in Hungary, even before the introduction of roller milling. Though millstones, and not rolls, were used, yet the wheat was not floured at one operation, as in typical low or flat grinding, but was reduced to flour in several successive operations. In the first break the stones would be placed just wide enough apart to "end" the wheat, and in each succeeding operation the stones were brought closer together. But Hungarian milling was not then automatic in the sense in which

British millers understand the word. For a long time a great deal of hand labour was employed in the merchant mills of Budapest in carrying about products from one machine to another for further treatment. This practice may have been partly due to the cheap labour available, but it was also the deliberate policy of Hungarian millers to handle in this way the middlings and fine "dunst," because it was maintained that only thus could certain products be delivered to the machine by which they were to be treated in the perfection of condition. The results were good so far as the finished products were concerned, but in the light of modern automatic milling the system appears uneconomical. Not only did it postulate an inordinately large staff, but it further increased the labour bill by the demand it made on the number of sub-foremen who were occupied in classifying, largely by touch, the various products, and directing the labourers under them. Hungarian milling still differs widely from milling as practised in Great Britain in being a longer system. This is due to the more minute subdivision of products, a necessary consequence of the large number of grades of flour and offals made in Hungary, where there are many intermediate varieties of middlings and "dunst" for which no corresponding terms are available in an English miller's vocabulary.

It will be convenient here to explain the meaning of three terms constantly used by millers, namely, *semolina*, *middlings* and *dunst*. These three products of roller mills are practically identical in composition, but represent different stages in the process of reducing the endosperm of the wheat to flour. A wheat berry is covered by several layers of skin, while under these layers is the floury kernel or endosperm. This the break or grooved rolls tend to tear and break up. The largest of these more or less cubical particles are known as semolina, whilst the medium-sized are called middlings and the smallest sized termed dust. The last is a German word, with several meanings, but is used in this particular sense by German and Austrian millers, from whom it was doubtless borrowed by the pioneers of roller milling in England. If we were to lay a sample of fairly granular flour beside a sample of small dust the two would be easy to distinguish, but place a magnifying glass over the flour and it would look very like the dust. If we were to repeat this experiment on dust and fine middlings, the former would under the glass present a strong resemblance to the middlings. The same effect would be produced by the putting side by side of large middlings and small semolina. This is a broad description of semolina, middlings and dust. Semolina and middlings are more apt to vary in appearance than dust, because the latter is the product of the later stages of the milling process and represents small particles of the floury kernel tolerably free from such impurities as bran or fluff. The flour producing middlings must not be confounded with the variety of wheat offal which is also known to many English millers as middlings. This consists of husk or bran, more or less comminuted, and with a certain proportion of floury particles adherent. It is only fit for feeding beasts.

The spread of roller milling on the continent of Europe was undoubtedly accelerated by the invention of porcelain rolls, by Friedrich Wegmann, a Swiss miller, which were brought into general use in the seventh decade of the 19th century, and are still widely employed. They are admirably fitted for the reduction of semolina, middlings and dust into flour; and for reducing pure middlings, that is, middlings containing no bran or wheat husk, there is perhaps nothing that quite equals them. They were introduced into Great Britain in 1877, or thereabouts, and were used for several years, but ultimately they almost disappeared from British mills. This was partly due to the fact that as made at that date they were rather difficult to work, as it was not easy to keep the rolls perfectly parallel. Another drawback was their inadaptability to over-heavy feeds, to which the British, and perhaps still more the American, miller is frequently obliged to resort. However, since the beginning of the 20th century some of the most advanced flour mills in England have again

*Roller
milling.*

*Semolina,
middlings,
dunst.*

*Porcelain
rolls.*

*Hungarian
practice.*

taken to using porcelain rolls for some part of their reduction process.

The birth of roller milling in Great Britain may be said to date from 1872, when Oscar Oexle, a German milling engineer, erected a set of roller mills in the Tradeston Mills, in Glasgow. This was long before the introduction of automatic roller mills. But the foundations of the millstone system were not seriously disturbed till 1877, when a party of leading British and Irish millers visited Vienna and Budapest with the object of studying roller milling in its native home. In 1878 J. H. Carter installed in the mill of J. Boland, of Dublin, what was probably the first complete automatic roller plant erected in the United Kingdom, and in 1881 a milling exhibition held at the Royal Agricultural Hall, London, showed the automatic roller system in complete operation. From that time the roller system made great progress. By 1885 many of the leading British millers had installed full roller plants, and in the succeeding ten years small roller plants were installed in many country mills. For a time there was a transition stage in which there was in operation a number of so-called "combined" plants, that is to say, mills in which the wheat was broken on millstones or disk mills, while the middlings were reduced by smooth rolls; but these gradually dropped out of being.

Well-found British flour mills at the present time are probably the best fitted in the world, and as a whole have nothing to fear from comparison with their American competitors. It is true that American millers were rather quicker to copy Hungarian milling methods so far as gradual reduction was concerned. But from about 1880 the British miller was quite awake to his position and was straining every nerve to provide himself with a plant capable of dealing with every kind of wheat. It has often been said that he commands the wheat of the whole world. This is true in a sense, but it is not true that he can always command the exact kind of wheat he requires at the price required to meet foreign competition. Therein he is at a disadvantage. But engineers have done their best to meet this weak point, and by their assistance he is able to compete under almost all conditions with the millers of the whole world.

Processes of Milling.—Fully to appreciate the various processes of modern milling, it must be remembered not only that the wheat as delivered at the mill is dusty and mixed with sand and even more objectionable refuse, but also that it contains many light grains and seeds of other plants. It is not therefore sufficient for the miller to be able to reduce the grain to flour on the most approved principles; he must also have at command the means of freeing it from foreign substances, and further of "conditioning" it, should it be damp or over dry and harsh. Again, his operations must be conducted with reference to the structure of the wheat grain. The wheat berry is a fruit, not a seed, the actual seed being the germ or embryo, a kidney-shaped body which is found at the base of the berry and is connected with the plumule or root. The germ is tough in texture and is in roller milling easily separated from the rest of the berry, being flattened instead of crushed by the rolls and thus readily sifted from the stock. The germ contains a good deal of fatty matter, which, if allowed to remain, would not increase the keeping qualities of the flour. Botanists distinguish five skins on the berry—epidermis, epicarp, endicarp, episperm and embryonic membrane—but for practical purposes the number of integuments may be taken as three. The inner skin is often as thick as the outer and second skins together, which are largely composed of woody fibre; it contains the cereal or aleurone cells, but although these are made up of a certain proportion of proteids, on account of the discolouring and diastasic action of the cereal in flour they are best eliminated. The endosperm, or floury kernel, coming next to the inner skin, consists of starch granules which are caught as it were in the minute meshes of a net. This network is the gluten, and it may be noted that these meshes are not of equal consistency throughout the berry, but are usually finer and more dense near the husk than in the interior of the kernel. This glutinous portion is of great importance

to the baker because on its quantity and quality depends the "strength" or rising power of the flour, and the aim of modern roller milling is to retain it as completely as possible, a matter of some difficulty owing to its close adherence to the husk, especially in the richest wheats. Another organ of the wheat berry which has a most important bearing on the work of the miller is the placenta, which is in effect a cord connecting the berry with its stalk or straw. The placenta serves to filter the food which the plant sucks up from the ground; it passes up the crease of the berry, and is enfolded in the middle skin, being protected on the outer side by the first and having the third or inner skin on its other side. A good deal of the matters filtered by the placenta are mineral in their nature, and such portions as are not digested remain in the crease. This is the matter which millers call "crease dirt." It is highly discolouring to flour, and must be carefully eliminated. The fuzzy end of the berry known as the beard also has a distinct function; its hairs are in reality tubes which serve to carry off superfluous moisture. They have, in common with the bran, no nutritive value. (See also WHEAT.)

In the old "flat" or "low" milling the object was to grind as perfectly as possible, at one operation, the central substance of the grain, constituting the flour, and to separate it from the embryo and outer skins constituting the bran. In "high" milling, on the other hand, the grinding is effected in a series of operations, the aim being to get as much semolina and middlings as possible from the wheat, and to make as little flour as possible during the earlier or "breaking" part of the process. It is impossible altogether to avoid the production of flour at this stage, but properly set and worked break-rolls will make as little as 15% of "break-flour," which is of less value, being contaminated with crease dirt, and also because it is weak owing to the absence of the gluten cells which adhere more readily to the middlings. Whole wheaten flour, sometimes called Graham flour, consists of the entire grain ground up to a uniform mass.

Wheat cleaning has been well called the foundation of all good milling. In the screen house, as the wheat-cleaning department of the mill is termed, will be found an array of machinery almost equal in range and variety to that in the mill itself. The wheat, drawn by an elevator from the barge, or hoisted in sacks, is first treated by a machine known as a warehouse separator. This apparatus accomplishes its work by means of flat sieves, some of which will be of much coarser mesh than others, and of air currents, the adjustment of which is a more delicate task than might appear. The warehouse separator serves to free dirty wheat of such impurities as lumps of earth, stones, straws and sand, not to mention small seeds, also some maize, oats and barley. Great care has to be exercised in all operations of the screen house lest wheat should pass away with the screenings. Besides the warehouse separator, which is made in different types and sizes, grading and sorting cylinders, and what are known as cockle and barley cylinders, are much used in the screen house. These cylinders are provided with indents so shaped and of such size as to catch seeds which are smaller than wheat, and reject grains, as of barley or oats, which are longer than wheat. Sorting cylinders should be followed by machines known as scourers, the function of which is to free the wheat from adherent impurities. These machines are of different types, but all depend on percussive action. A vertical scourer consists of a number of steel or iron beaters attached to a vertical spindle which revolves inside a metallic woven or perforated casing, the whole being fitted with an effectual exhaust. Scourers with horizontal spindles are also in great favour. Not every wheat is suitable for scouring, but some wheats are so mingled with impurities that a severe action between the beaters and the perforated case is absolutely necessary. The most efficient scourer is that which frees the wheat from the greatest amount of impurity with a minimum of abrasion. The beaters should be adjustable to suit different kinds of wheat. Scourers are followed by brush machines which are similar to the last and are of three distinct types: solid, divided and cone brushes. In the solid variety the brush surface is continuous around the circumference of a revolving cylinder; in divided brushes there is often a set of beaters or bars covered with brush but leaving intermediate spaces; while the cone brush consists of beaters covered with fibre arranged like cones around a vertical spindle. The object of all these brushes, the cylinder containing them being fitted with an exhaust fan, is to polish the wheat and remove adhering impurities which the percussive action of the scourer may have failed to eliminate, also to remove the beard or fuzzy end and any loose portions of the outer husk. But the miller must be careful not to overdo the scouring action and unnecessarily abrade the berry, else he will have trouble with his flour, the triturated bran breaking under the rolls and producing powder which will discolour the break flour. To remove such metallic fragments as nails, pieces of wire, &c., magnets are used. These may either

be of horseshoe shape, in which case they are usually set at the head of the wheat spouts, or they may consist of magnetized plates set at angles over which the wheat will slide. It is not a bad plan to place the magnets just before the first set of break-rolls, where they should ensure the arrest of steel and iron particles, which might otherwise get between the rolls and spoil the edges of their grooves, and also do damage to the sifting machines. Mention must also be made of the automatic scales which are used to check the milling value of the wheat. In principle these machines are all the same, though details of construction may vary. Each weigher is set for a given weight of grain. As soon as the receiving hopper has poured through a valve into the recipient or skip, which is hung at one end of a beam scale, a load of grain sufficient to overcome the weight hung at the other end of the beam, the inlet of grain is automatically cut off and the skip is discharged, automatically returning to take another charge. Each weighing is automatically recorded on a dial. In this way a record can be kept of the gross weight of the uncleaned wheat entering the warehouse and of the net weight of the cleaned wheat. The difference between the two weightings will, of course, represent the loss by cleaning. The percentage of flour obtained from a given wheat can be ascertained in the mill itself. In practice the second weigher is placed just before the first break.

The cleansing of wheat by washing only became a fine art at the close of the 19th century, though it was practised in the north of

England some twenty years earlier. Briefly it may be said that certain wheats are washed to free them from extraneous matters such as adherent earth and similar impurities which could not be removed by dry cleaning without undue abrasion. Such wheats are Indians, Persians and hard Russians, and these require not only washing but also conditioning, by which is meant mellowing, before going to the rolls. With another class of wheats, such as the softer Russians and Indians, spring Americans and Canadians, hard American winters, Californians and the harder River Plates, washing and conditioning by heat is also desirable, though care must be exercised not to let the moisture penetrate into the endosperm or floury portion of the kernel. In a third and distinct class fall soft wheats, such as many kinds of Plates, soft Russians and English wheat. It is generally admitted that while wheat of the first two divisions will benefit from the application of both moisture and heat, wheat of the third class must be washed with great circumspection. The object of washing machines is to agitate the wheat in water till the adherent foreign matters are washed off and any dirt balls broken up and drained off in the waste water. To this end some washers are fitted with Archimedean worm conveyors set either at an inclined angle or horizontally or vertically; or the washer may consist of a barrel revolving in a tank partly filled with water. Another function of washing machines is to separate stones of the same size which are found in several varieties of wheat. This separation is effected by utilizing a current of water as a balance strong enough to carry wheat but not strong enough to carry stones or bodies of greater specific gravity than wheat. This current may be led up an inclined worm or may flow horizontally over a revolving tray. The washer is followed by a whizzer, which is an apparatus intended to free the berry by purely mechanical means from superfluous moisture. The typical whizzer is a vertical column fed at the bottom and delivering at the top. The wet wheat ascends by centrifugal force in a spiral direction round the column to the top, and by the time it is discharged from the spout at the top it has thrown off from its outer skin almost all its moisture, the water escaping through the perforated cover of the machine. But there still remains a certain amount of water which has penetrated the integuments more or less deeply, and to condition the berry it is treated by a combination of hot and cold air. The wheat is passed between perforated metal plates and subjected to a draught first of hot and then of cold air. The perforated plates are usually built in the shape of a column, or leg as it is often called, and this is provided with two air chambers, an upper one serving as a reservoir for hot, and the lower for cold air. The air from both chambers is discharged by pressure through the descending layers of wheat, which should not be more than an inch thick; the air is drawn in by a steel-plate fan, which is often provided with a divided casing, one side being used for cold, and the other for hot air. Coupled with the hot air side is a heater consisting of a series of circulating steam-heated pipes. The temperature of the heated air can be regulated by the supply of steam to the heater. This process of washing and conditioning, one of the most important in a flour mill, is characteristically British; millers have to deal with wheats of the most varied nature, and one object of conditioning is to bring hard and harsh, soft and weak wheats as nearly as possible to a common standard of condition before being milled. Wheat is sometimes washed to toughen the bran, an end which can also be attained by damping it from a spraying pipe as it passes along an inclined worm. Another way of toughening bran is to pass wheat through a heated cylinder, while again another process known as steaming consists of injecting steam into wheat as it passes through a metal hopper. Here the object is to cleanse to some extent, and to warm and soften (by the condensation of moisture on the grain), but these processes are imperfect substitutes for a full washing and conditioning plant. Hard wheats will not be injured by a fairly long im-

mersion in water, always provided the subsequent whizzing and drying are efficiently carried out. The second class of semi-hard wheats already mentioned must be run more quickly through the washer and freed from the water as rapidly as possible. Still more is this necessary with really soft wheats, such as soft River Plates and the softer English varieties. Here an immersion of only a few seconds is desirable, while the moisture left by the water must be immediately and energetically thrown off by the whizzer before the grain enters the drier. Treated thus, soft wheats may be improved by washing. It is claimed that hard wheats, like some varieties of Indians, are positively improved in flavour by conditioning, and this is probably true; certain it is that English country millers, in seasons when native wheat was scarce and dear, and Indian wheat was abundant and cheap, have found the latter, mellowed by conditioning, to be an excellent substitute.

Wheats which have been exposed to the action of water during harvest do not necessarily yield unsound flour; the matter is a question of the amount of moisture absorbed. But it must be remembered that it is not so much the water itself which degrades the constituents of the wheat (starch and gluten) as the chemical changes which the dampness produces. Hence perhaps the best remedy which can be found for damp wheat is to dry it as soon as it has been harvested, either by kiln or steam drier at a heat not exceeding 120° F., until the moisture has been reduced to 10% of the whole grain. The flour made from wheat so treated may be weak, but will not usually be unsound. The practice of drying damp flour has also good results. Long before the roller milling period it was found that only flour which had been dried (in a kiln) could safely be taken on long sea voyages, especially when the vessel had to navigate warm latitudes. It may be noted that in the days of millstone milling it was far more difficult to produce good keeping flour. The wheat berry being broken up and triturated in one operation, the flour necessarily contained a large proportion of branny particles in which cerealin, an active diastasic constituent, was present in very sensible proportions. Again, the elimination of the germ by the roller process is favourable to the production of a sounder flour, because the germ contains a large amount of oleaginous matter and has a strong diastasic action on imperfectly matured starches. The tendency of flours containing germ to become rancid is well marked. During the South African War of 1899-1902 the British army supply department had a practical proof of the diastasic action of branny particles in flour. Soldiers' bread is not usually of white colour, and the military authorities not unnaturally believed that comparatively low-grade flour, if sound, was eminently suitable for use in the field bakeries. But in the climate of South Africa flour of this description soon developed considerable acidity. Ultimately the supply department gave up buying any but the driest patent flours, and it is understood that the most suitable flour proved to be certain patents milled in Minneapolis, U.S.A., from hard spring wheat. Not only did they contain a minimum of branny and fibrous matters, but they were also the driest that could be found.

After being cleaned the wheat berry is split and broken up into increasingly fine pieces by fluted rolls or "breaks." In the earlier years of roller milling it was usual to employ more breaks than is now the case. The first pair of break-rolls used to be called the splitting rolls, because their function was supposed to be to split the berry longitudinally down its crease, so as to give the miller an opportunity of removing the dirt between the two lobes of the berry by means of a brush machine. The dirt was in many cases no more than the placenta already described, which shrivelling up took, like all vegetable fibre, a dark tint. The neat split along the crease was not, however, achieved in more than 10% of the berries so treated. Where such rolls are still in use they are really serving as a sort of adjunct to the wheat-cleaning system. Four or five breaks are now thought sufficient, but three breaks are not recommended, except in very short systems for small country mills. Rolls are now used up to 60 in. in length, though in one of the most approved systems they never exceed 40 in.; they are made of chilled iron, and for the breaking of wheat are provided with grooving cut at a slight twist, the spiral averaging $\frac{1}{4}$ in. to the foot length, though for the last set of break-rolls, which clean up the bran, the spiral is sometimes increased to $\frac{1}{2}$ in. per foot. The grooves should have sharp edges because they do better work than when blunt, giving larger semolina and middlings, with bran adherent in big flakes; small middlings, that is, little pieces of the endosperm torn away by blunt grooves, and comminuted bran, make the production of good class flour almost impossible; cut bran, moreover, brings less money. The break-rolls should never work by pressure, but nip the material fed between them at a given point; to cut or shear, not to flatten and crush, is their function. Rolls may be set either horizontally or vertically; an oblique setting has also come into favour. The feed is of the utmost importance to the correct working of a roller mill. The material should be fed in an even stream, not too thick, and leaving no part of the roll uncovered. The two rolls of each pair are run at unequal speeds, $2\frac{1}{2}$ to 1 being the usual ratio on the three first breaks, while the last break is often speeded at 3 to 1 or $3\frac{1}{2}$ to 1; in one of the oblique mills the difference is obtained by making the diameter of one roll 13 and of the other 10 in. and running them at equal speed. For break-rolls up to 36 in. in

Effect of damp.

Wet cleaning and conditioning.

Break-rolls.

length 9 in. is the usual diameter; for longer rolls 10 in. is the standard. To do good work rolls must run in perfect parallelism; otherwise some parts of the material will pass untouched, while others will be treated too severely.

The products of the break-rolls are treated by what are known as scalpers, which are simply machines for sorting out these products for further treatment. Scalpers may either be revolving reels or flat sieves. The sieve is the favourite form of scalper on account of its gentle action. Scalping requires a separating and sifting, not a scouring action. The break products are usually separated on a sieve covered with wire or perforated zinc plates. Generally speaking, two sieves are in one frame and are run at a slight incline. The throughs of the top sieve fall on the sieve below, while the rejections or overtails of the first sieve are fed to the next break. The "throughs," or what has passed this sieve, are graded by the next sieve, the tailings going to a purifier, while the throughs may be freed from what flour adheres to them by a centrifugal dressing machine and then treated by another purifier. A form of scalper which has come into general use on the continent of Europe, and to a lesser extent in Great Britain and America, is known as the plansifter. This machine, of Hungarian origin, is simply a collection of superimposed flat sieves in one box, and will scalp or sort out any kind of break stock very efficiently. A system of grading the tailings, that is, the rejections of the scalpers, introduced by James Harrison Carter (Carter-Zimmer patent), was known as pneumatic sorting. Its object was to supplement the work of the scalpers by classifying the tailings by means of air-currents. To this end each scalper was followed by a machine arranged somewhat like a gravity purifier; that is to say, a current of air drawn through the casing of the sorter allowed the heaviest and best material to drop down straight, while the lighter stuff was deposited in one or other of further compartments formed by obliquely placed adjustable cant boards. So searching was this grading, that from the first sorter of a four-break plant four separations would be obtained, the first going to the second break, the second joining the first separation from the second sorter and being fed to the third break, while the third went with the best separation of the third sorter to the fourth break, and the last separation from all the sorters went straight into the bran sack. The work of the break-rolls was greatly simplified and reduced by this sorting process, as each particle of broken wheat went exactly to that pair of break-rollers for which it was suitable, instead of all the material being run indiscriminately through all the break-rollers and thereby being cut up with the necessary result of increasing the production of small bran.

The object of the purifier, a machine on which milling engineers have lavished much thought and labour, is to get away from the semolina and middlings as much impure matter as possible, that those products may be pure, as millers say, for reduction to flour by the smooth rolls. The purifiers used in British mills take advantage of the fact that the more valuable portions of the wheat berry are heavier than the less valuable particles, such as bran and fibrous bodies, and a current of air is employed to weigh these fragments of the wheat berry as in a balance and to separate them while they pass over a silk-covered sieve. To this end the semolina or middlings are fed on a sieve vibrated by an eccentric and set at a slight downward angle. This sieve is installed in an air-tight longitudinal wooden chamber with glass windows on either side, through which the process of purifying can be watched. Upwards through this sieve a fan constantly draws a current of air, which, raising the stock upwards, allows the heavier and better material to remain below while the lighter particles are lifted off and fall on side platforms or channels, whence they are carried forward and delivered separately. The good material drops through the meshes of the silk, and is collected by a worm. It is usual to clothe the sieve in sections with several different meshes of silk so that stock of almost identical value, but differing size, may be treated with uniform accuracy. In good purifiers the strength of the current can be regulated at will in each section. The tailings of a purifier do not usually exceed 10 to 15% of the feed. The clothing of purifier sheets must be nicely graduated to the clothing of the preceding machines. Repurification and even tertiary purification may be necessary under certain conditions. In Hungary and other parts of Europe, gravity purifiers are much in use. Here the material is guided along an open sieve set at a slight angle, while an air-current is drawn up at an acute angle. Under the sieve may be arranged a series of inclined boards, the position of which can be varied as required. The heaviest and most valuable products resist the current and drop straight down, while lighter material is carried off to further divisions.

From the purifier all the stock except the tailings, which may require other treatment, should go to the smooth rollers to be made into flour, but here the rollerman will have to exercise great care and discretion. Many of the remarks already made in regard to break-rolls apply to smooth rolls, notably in respect of parallelism. But instead of a cutting action, the smooth rolls press the material fed to them into flour. This pressure, however, must be applied with great discrimination, large semolina with impurities attached requiring quite different treatment from that called for by small pure middlings. The pressure on

the stock must be just sufficient and no more. Reduction rolls are usually run at a differential speed of about 2 to 3. The feed must be carefully graded, because to pass stock of varying size through a pair of smooth rolls would be fatal to good work. Scratch rolls very finely grooved are used for cracking impure semolina or for reducing the tailings of purifiers. The latter often hold fragments of bran, which are best detached by rolls grooved about 36 to the inch and run at a differential of 3 to 1. The reduction requires even more roll surface than the break system. To do first-class work a mill should have at least 35 to 40 in. on the breaks and 50 in. on the reduction for each sack of 280 lb of flour per hour. Many engineers consider 100 to 110 in. on the break, scratch and smooth rolls not too much.

The dressing out of the flour from the stock reduced on smooth rolls is generally effected by centrifugal machines, which consist of a slowly revolving cylinder provided with an internal shaft on which are keyed a number of iron beaters that run at a speed of about 200 revolutions a minute, and fling the feed against the silk clothing of the cylinder. What goes through the silk is collected by a worm conveyor at the bottom of the machine. Most centrifugals have so-called "cut-off" sheets, with internal divisions in the tail end; these are intended to separate some intermediate products, which, having been freed from floury particles, are treated on some other machine, such as a pair of rolls either direct or after a purifier. The centrifugal is undoubtedly an efficient flour separator, but the plansifters already mentioned are also good flour-dressers, especially in dry climates. A plansifter mill will have no centrifugals, except one or two at the tail end where the material gets more sticky and requires more severe treatment.

The yield of flour obtained in a British roller mill averages 70 to 73% of the wheat berry. The residue, with the exception of a very small proportion of waste, is offal, which is divided into various grades and sold. Profitable markets for British-made bran have been found in Scandinavia, and especially in Denmark. In millstone milling the yield of flour probably averaged 75 to 80%, but a certain proportion of this was little more than offal. The length of the flour yield taken by British millers varies in different parts of the kingdom, because demand varies. In one locality high-class patents may be at a premium; in another the call is for a straight grade, *i.e.* a flour containing as much of the farinaceous substance as can be won from the wheat berry. In one district there is a sale for rich offals, that is, offals with plenty of flour adhering; in another there may be no demand for such offals. Hence, though the general principles of roller milling as given above hold good all over the country, yet in practice the work of each mill is varied more or less to suit the peculiarities of the local trade.

Early in the 19th century a French chemist, J. J. E. Poutet, discovered that nitrous acid and oxides of nitrogen act on some fluid and semi-fluid vegetable oils, removing their yellow tinge and converting a considerable portion of their substance into a white solid. The importance of this discovery, when the physical constitution of wheat is considered, is obvious, but it was years before any attempt was made to bleach flour. The first attempts at bleaching seem to have been made on the wheat itself rather than on the flour. In 1879 a process was patented for bleaching grain by means of chlorine gas, and about 1891 a suggestion was made for bleaching grain by means of electrolysed sea-water. In 1895 a scheme was put forward for treating grain with sulphurous acid, and about two years later it was proposed to subject both grain and flour to the influence of electric currents. In 1893 a patent was granted for the purification of flour by means of fresh air or oxygen, and three years later another inventor proposed to employ the Röntgen rays for the same purpose. In 1898 Emile Frichot took out a patent for using ozone and ozonized air for flour-bleaching. The patent (No. 1661 of 1901) taken out by J. & S. Andrews of Belfast recited that flour is known to improve greatly if kept for some time after grinding, and the purpose of the invention it covered was to bring about this improvement or conditioning not only immediately after grinding, but also to a greater extent than can be effected by keeping. The process consisted in subjecting the flour to the action of a suitable gaseous oxidizing medium; the inventors preferred air carrying a minute quantity of nitric acid or peroxide of nitrogen, but they did not confine themselves to those compounds, having found that chlorine, bromine and other substances capable of liberating oxygen were also more or less efficacious. They claimed that while exercising no deleterious action their treatment made the flour whiter, improved its baking qualities, and rendered it less liable to be attacked by mites or other organisms. Under the patent, No. 14006 of 1903, granted to J. N. Alsop of Kentucky the flour was treated with atmospheric air which had been subjected to the action of an arc or flaming discharge of electricity, with the purpose of purifying it and improving its nutritious properties. The Andrews and Alsop patents became the objects of extended litigation in the English courts, and it was held that the gaseous medium employed by Alsop was substantially the same as that employed by Andrews, though produced electrically instead of chemically, and therefore that the Alsop process was an infringement of the Andrews patent. Various other patents for more or less similar processes have also been taken out. (G. F. Z.)

FLOURENS, GUSTAVE (1838–1871), French revolutionist and writer, a son of J. P. Flourens (1794–1867), the physiologist, was born at Paris on the 4th of August 1838. In 1863 he undertook for his father a course of lectures at the Collège de France, the subject of which was the history of mankind. His theories as to the manifold origin of the human race, however, gave offence to the clergy, and he was precluded from delivering a second course. He then went to Brussels, where he published his lectures under the title of *Histoire de l'homme* (1863); he next visited Constantinople and Athens, took part in the Cretan insurrection of 1866, spent some time in Italy, where an article of his in the *Popolo d'Italia* caused his arrest and imprisonment, and finally, having returned to France, nearly lost his life in a duel with Paul de Cassagnac, editor of the *Pays*. In Paris he devoted his pen to the cause of republicanism, and at length, having failed in an attempt to organize a revolution at Belleville on the 7th of February 1870, found himself compelled to flee from France. Returning to Paris on the downfall of Napoleon, he soon placed himself at the head of a body of 500 tirailleurs. On account of his insurrectionary proceedings he was taken prisoner at Créteil, near Vincennes, by the provisional government, and confined at Mazas on the 7th of December 1870, but was released by his men on the night of January 21–22. On the 18th of March he joined the Communists. He was elected a member of the commune by the 20th arrondissement, and was named colonel. He was one of the most active leaders of the insurrection, and in a sortie against the Versailles troops in the morning of the 3rd of April was killed in a hand-to-hand conflict at Rueil, near Malmaison. Besides his *Science de l'homme* (Paris, 1869), Gustave Flourens was the author of numerous fugitive pamphlets.

See C. Prolès, *Les Hommes de la révolution de 1871* (Paris, 1898).

FLOURENS, MARIE JEAN PIERRE (1794–1867), French physiologist, was born at Maureilhan, near Béziers, in the department of Hérault, on the 15th of April 1794. At the age of fifteen he began the study of medicine at Montpellier, where in 1823 he received the degree of doctor. In the following year he repaired to Paris, provided with an introduction from A. P. de Candolle, the botanist, to Baron Cuvier, who received him kindly, and interested himself in his welfare. At Paris Flourens engaged in physiological research, occasionally contributing to literary publications; and in 1821, at the Athénée there, he gave a course of lectures on the physiological theory of the sensations, which attracted much attention amongst men of science. His paper entitled *Recherches expérimentales sur les propriétés et les fonctions du système nerveux dans les animaux vertébrés*, in which he, from experimental evidence, sought to assign their special functions to the cerebrum, corpora quadrigemina and cerebellum, was the subject of a highly commendatory report by Cuvier, adopted by the French Academy of Sciences in 1822. He was chosen by Cuvier in 1828 to deliver for him a course of lectures on natural history at the Collège de France, and in the same year became, in succession to L. A. G. Bosc, a member of the Institute, in the division "Économie rurale." In 1830 he became Cuvier's substitute as lecturer on human anatomy at the Jardin du Roi, and in 1832 was elected to the post of titular professor, which he vacated for the professorship of comparative anatomy created for him at the museum of the Jardin the same year. In 1833 Flourens, in accordance with the dying request of Cuvier, was appointed a perpetual secretary of the Academy of Sciences; and in 1838 he was returned as a deputy for the arrondissement of Béziers. In 1840 he was elected, in preference to Victor Hugo, to succeed J. F. Michaud at the French Academy; and in 1845 he was created a commander of the legion of honour, and in the next year a peer of France. In March 1847 Flourens directed the attention of the Academy of Sciences to the anaesthetic effect of chloroform on animals. On the revolution of 1848 he withdrew completely from political life; and in 1855 he accepted the professorship of natural history at the Collège de France. He died at Montgeron, near Paris, on the 6th of December 1867.

Besides numerous shorter scientific memoirs, Flourens published—*Essai sur quelques points de la doctrine de la révulsion et de la déri-*

vation (Montpellier, 1813); *Expériences sur le système nerveux* (Paris, 1825); *Cours sur la génération, l'ovologie, et l'embryologie* (1836); *Analyse raisonnée des travaux de G. Cuvier* (1841); *Recherches sur le développement des os et des dents* (1842); *Anatomie générale de la peau et des membranes muqueuses* (1843); *Buffon, histoire de ses travaux et de ses idées* (1844); *Fontenelle, ou de la philosophie moderne relativement aux sciences physiques* (1847); *Théorie expérimentale de la formation des os* (1847); *Œuvres complètes de Buffon* (1853); *De la longévité humaine et de la quantité de vie sur le globe* (1854), numerous editions; *Histoire de la découverte de la circulation du sang* (1854); *Cours de physiologie comparée* (1856); *Recueil des éloges historiques* (1856); *De la vie et de l'intelligence* (1858); *De la raison, du génie, et de la folie* (1861); *Ontologie naturelle* (1861); *Examen du livre de M. Darwin sur l'Origine des Espèces* (1864). For a list of his papers see the Royal Society's *Catalogue of Scientific Papers*.

FLOWER, SIR WILLIAM HENRY (1831–1899), English biologist, was born at Stratford-on-Avon on the 30th of November 1831. Choosing medicine as his profession, he began his studies at University College, London, where he showed special aptitude for physiology and comparative anatomy and took his M.B. degree in 1851. He then joined the Army Medical Service, and went out to the Crimea as assistant-surgeon, receiving the medal with four clasps. On his return to England he became a member of the surgical staff of the Middlesex hospital, London, and in 1861 succeeded J. T. Quekett as curator of the Hunterian Museum of the Royal College of Surgeons of England. In 1870 he also became Hunterian professor, and in 1884, on the death of Sir Richard Owen, was appointed to the directorship of the Natural History Museum at South Kensington. He died in London on the 1st of July 1899. He made valuable contributions to structural anthropology, publishing, for example, complete and accurate measurements of no less than 1300 human skulls, and as a comparative anatomist he ranked high, devoting himself especially to the study of the mammalia. He was also a leading authority on the arrangement of museums. The greater part of his life was spent in their administration, and in consequence he held very decided views as to the principles upon which their specimens should be set out. He insisted on the importance of distinguishing between collections intended for the use of specialists and those designed for the instruction of the general public, pointing out that it was as futile to present to the former a number of merely typical forms as to provide the latter with a long series of specimens differing only in the most minute details. His ideas, which were largely and successfully applied to the museums of which he had charge, gained wide approval, and their influence entitles him to be looked upon as a reformer who did much to improve the methods of museum arrangement and management. In addition to numerous original papers, he was the author of *An Introduction to the Osteology of the Mammalia* (1870); *Fashion in Deformity* (1881); *The Horse: a Study in Natural History* (1890); *Introduction to the Study of Mammals, Living and Extinct* (1891); *Essays on Museums and other Subjects* (1898). He also wrote many articles for the ninth edition of the *Encyclopaedia Britannica*.

FLOWER (Lat. *flos, floris*; Fr. *flour*), a term popularly used for the bloom or blossom of a plant, and so by analogy for the fairest, choicest or finest part or aspect of anything, and in various technical senses. Here we shall deal only with its botanical interest. It is impossible to give a rigid botanical definition of the term "flower." The flower is a characteristic feature of the highest group of the plant kingdom—the flowering plants (Phanerogams)—and is the name given to the association of organs, more or less leaf-like in form, which are concerned with the production of the fruit or seed. In modern botanical works the group is often known as the seed-plants (Spermatophyta). As the seed develops from the ovule which has been fertilized by the pollen, the essential structures for seed-production are two, viz. the pollen-bearer or *stamen* and the ovule-bearer or *carpel*. These are with few exceptions foliar structures, known in comparative morphology as sporophylls, because they bear the spores, namely, the microspores or pollen-grains which are developed in the microsporangia or pollen-sacs, and the megaspore, which is contained in the ovule or megasporangium.

In Gymnosperms (*q.v.*), which represent the more primitive

type of seed-plants, the micro- or macro-sporophylls are generally associated, often in large numbers, in separate cones, to which the term "flower" has been applied. But there is considerable difference of opinion as to the relation between these cones and the more definite and elaborate structure known as the flower in the higher group of seed-plants—the Angiosperms (*q.v.*)—and it is to this more definite structure that we generally refer in using the term "flower."

Flowers are produced from flower-buds, just as leaf-shoots arise from leaf-buds. These two kinds of buds have a resemblance to each other as regards the arrangement and the development of their parts; and it sometimes happens, from injury and other causes, that the part of the axis which, in ordinary cases, would produce a leaf-bud, gives origin to a flower-bud. A flower-bud has not in ordinary circumstances any power of extension by the continuous development of its apex. In this respect it differs from a leaf-bud. In some cases, however, of monstrosity, especially seen in the rose (fig. 1), the central part is prolonged, and bears leaves or flowers. In such cases the flowers, so far as their functional capabilities are concerned, are usually abortive. This phenomenon is known as proliferation of the floral axis.

Flower-buds, like leaf-buds, are produced in the axil of leaves, which are called *bracts*.

The term *bract* is properly applied to the leaf from which the primary floral axis, whether

Bracts. simple or branched, arises, while the leaves which arise on the axis between the bract and the outer envelope of the flower are *bracteoles* or *bractlets*. Bracts sometimes do not differ from the ordinary leaves, as in *Veronica hederifolia*, *Vinca*, *Anagallis* and *Ajuga*. In general as regards their form and appearance they differ from ordinary leaves, the difference being greater in the upper than in the lower branches of an inflorescence. They are distinguished by their position at the base of the flower or flower-stalk. Their arrangement is similar to that of

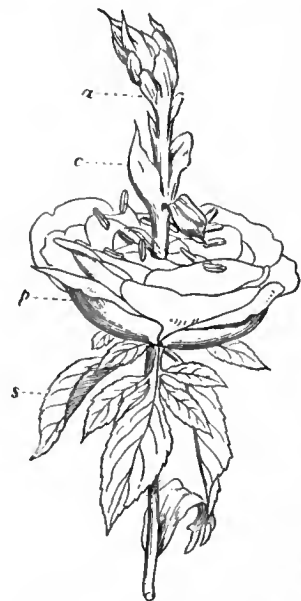

FIG. 1.—Proliferous Rose.
s, Sepals transformed into leaves.
p, Petals multiplied at the expense of the stamens, which are reduced in number.
c, Coloured leaves representing abortive carpels.
a, Axis prolonged, bearing an imperfect flower at its apex.

the leaves. When the flower is sessile the bracts are often applied closely to the calyx, and may thus be confounded with it, as in the order Malvaceae and species of *Dianthus* and winter aconite (*Eranthis*), where they have received the name of *epicalyx* or *calyculus*. In some Rosaceous plants an epicalyx is present, due to the formation of stipular structures by the sepals. In many cases bracts act as protective organs, within or beneath which the young flowers are concealed in their earliest stage of growth.

When bracts become coloured, as in *Amherstia nobilis*, *Euphorbia splendens*, *Erica elegans* and *Salvia splendens*, they may be mistaken for parts of the corolla. They are sometimes mere scales or threads, and at other times are undeveloped, giving rise to the *obraceate* inflorescence of Cruciferae and some Boraginaceae. Sometimes they are empty, no flower-buds being produced in their axil. A series of empty coloured bracts terminates the inflorescence of *Salvia Horminum*. The smaller bracts or bracteoles, which occur among the subdivisions of a branching inflorescence, often produce no flower-buds, and thus anomalies occur in the floral arrangements. Bracts are occasionally persistent, remaining long attached to the base of the peduncles, but more usually they are deciduous, falling off early

by an articulation. In some instances they form part of the fruit, becoming incorporated with other organs. Thus, the cones of firs and the stroboli of the hop are composed of a series of spirally arranged bracts covering fertile flowers; and the scales on the fruit of the pine-apple are of the same nature. At the base of the general umbel in umbelliferous plants a whorl of bracts often exists, called a *general involucre*, and at the base of the smaller umbels or umbellules there is a similar leafy whorl called an *involucel* or *partial involucre*. In some instances, as in fool's-parsley, there is no general involucre, but simply an involucel; while in other cases, as in fennel or dill (fig. 15), neither involucre nor involucel is developed. In Compositae the name involucre is applied to the bracts surrounding the head

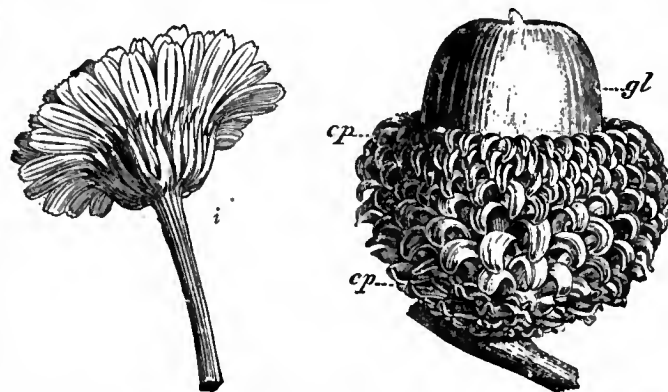

FIG. 2.—Head (capitulum) of Marigold (*Calendula*), showing a congeries of flowers, enclosed by rows of bracts, *i*, at the base, which are collectively called an involucre.
From Strasburger's *Lehrbuch der Botanik*, by permission of Gustav Fischer.
FIG. 3.—Cupule of *Quercus Aegilops*, by rows of bracts, *cp*, Cupule; *gl*, fruit. (After Duchartre.)

of flowers (fig. 2, *i*), as in marigold, dandelion, daisy, artichoke. This involucre is frequently composed of several rows of leaflets, which are either of the same or of different forms and lengths, and often lie over each other in an imbricated manner. The leaves of the involucre are spiny in thistles and in teazel (*Dipsacus*), and hooked in burdock. Such whorled or verticillate bracts generally remain separate (*polyphyllous*), but may be united by cohesion (*gamophyllous*), as in many species of *Bupleurum* and in *Lavatera*. In Compositae besides the involucre there are frequently chaffy and setose bracts at the base of each flower, and in Dipsacaceae a membranous tube surrounds each flower. These structures are of the nature of an epicalyx. In the acorn the *cupule* or cup (fig. 3) is formed by a growing upwards of the flower-stalk immediately beneath the flower, upon which scaly or spiny protuberances appear; it is of the nature of bracts. Bracts also compose the husky covering of the hazel-nut.

When bracts become united, and overlie each other in several rows, it often happens that the outer ones do not produce flowers, that is, are empty or sterile. In the artichoke the outer imbricated scales or bracts are in this condition, and it is from the membranous white scales or bracts (*paleae*) forming the choke attached to the edible receptacle that the flowers are produced. The sterile bracts of the daisy occasionally produce capitula, and give rise to the hen-and-chickens daisy. In place of developing flower-buds, bracts may, in certain circumstances, as in proliferous or viviparous plants, produce leaf-buds.

A sheathing bract enclosing one or several flowers is called a *spathe*. It is common among Monocotyledons, as *Narcissus* (fig. 4), snow-flake, *Arum* and palms. In some palms it is 20 ft. long, and encloses 200,000 flowers. It is often associated with that form of inflorescence termed the *spadix*, and may be coloured, as in *Anthurium*, or white, as in arum lily (*Richardia aethiopica*). When the spadix is compound or branching, as in palms, there are smaller spathes, surrounding separate parts of the inflorescence. The spathe protects the flowers in their young state, and often falls off after they are developed, or hangs down

in a withered form, as in some palms, *Typha* and *Pothos*. In grasses the outer scales or glumes of the spikelets are sterile bracts (fig. 5, *gl*); and in Cyperaceae bracts enclose the organs



FIG. 4.—Flowers of *Narcissus* (*Narcissus tazetta*) bursting from a sheathing bract *b*.

of reproduction. Bracts are frequently changed into complete leaves. This change is called *phylloidy* of bracts, and is seen in species of *Plantago*, especially in the variety of *Plantago media*, called the rose-plantain in gardens, where the bracts become leafy and form a rosette round the flowering axis. Similar changes occur in *Plantago major*, *P. lanceolata*, *Ajuga reptans*, dandelion, daisy, dahlia and in umbelliferous plants. The conversion of bracts into stamens (*staminody* of bracts) has been observed in the case of *Abies excelsa*. A lengthening of the axis of the female strobilus of Coniferae is not of infrequent occurrence in

Cryplomeria japonica, larch (*Larix europaea*), &c., and this is usually associated with a leaf-like condition of the bracts, and sometimes even with the development of leaf-bearing shoots in place of the scales.

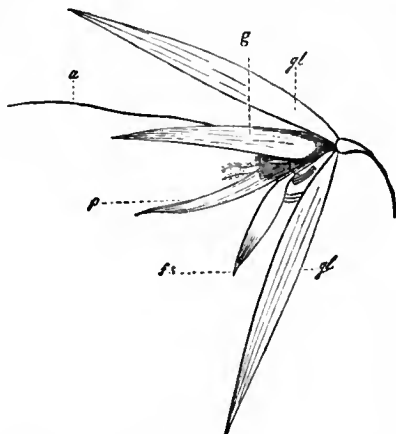

FIG. 5.—Spikelet of Oat (*Avena sativa*) laid open, showing the sterile bracts *gl*, *gl*, or empty glumes; *g*, the fertile or floral glume, with a dorsal awn *a*; *p*, the pale; *fs*, an abortive flower.

The arrangement of the flowers on the axis, or the ramification of the floral axis, is called the *inflorescence*. The primary axis of the inflorescence is sometimes called the *rachis*; its branches, whether terminal or lateral, which form the stalks supporting flowers or clusters of flowers, are *peduncles*, and if small branches are given off by it, they are called *pedicels*. A flower having a stalk is called *pedunculate* or *pedicellate*; one having no stalk is *sessile*. In describing a branching inflorescence, it is common to speak of the rachis as the *primary* floral axis, its branches as the *secondary* floral axes, their divisions as the *tertiary* floral axes, and so on; thus avoiding any confusion that might arise from the use of the terms *rachis*, *peduncle* and *pedicel*.

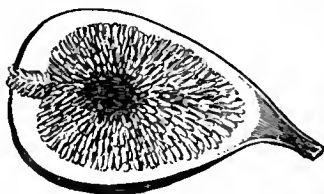

FIG. 6.—Peduncle of Fig (*Ficus carica*), ending in a hollow receptacle, enclosing numerous male and female flowers.

The *peduncle* is simple, bearing a single flower, as in primrose; or branched, as in London-pride. It is sometimes succulent, as in the cashew, in which it forms the large coloured expansion supporting the nut; spiral, as in *Cyclamen* and *Vallisneria*; or spiny, as in *Alyssum spinosum*. When the peduncle proceeds from radical leaves, that is, from an axis which is so shortened as to bring the leaves close together in the form of a cluster, as in the primrose, auricula or hyacinth, it is termed a *scape*. The floral axis may be shortened, assuming a flattened, convex or concave form, and bearing numerous flowers, as in the arti-

choke, daisy and fig (fig. 6). The floral axis sometimes appears as if formed by several peduncles united together, constituting a fasciated axis, as in the cockscomb, in which the flowers form a peculiar crest at the apex of the flattened peduncles. Adhesions occasionally take place between the peduncle and the bracts or leaves of the plant, as in the lime-tree (fig. 7). The adhesion of the peduncles to the stem accounts for the extra-axillary position of flowers, as in many Solanaceae. When this union extends for a considerable length along the stem, several leaves may be interposed between the part where the peduncle becomes free and the leaf whence it originated, and it may be difficult to trace the connexion. The peduncle occasionally becomes abortive, and in place of bearing a flower, is transformed into a tendril; at other times it is hollowed at the apex, so as apparently to form the lower part of the outer whorl of floral leaves as in *Eschscholtzia*.

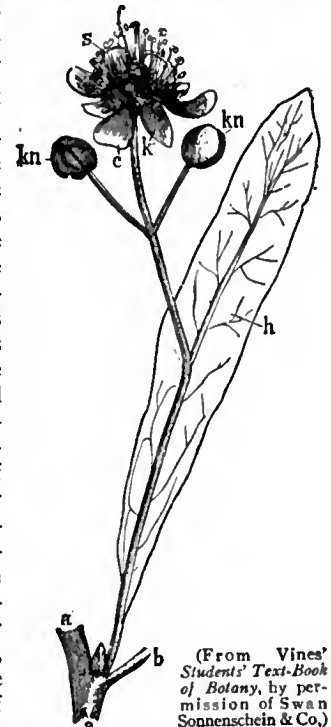

FIG. 7.—Inflorescence of the Lime (*Tilia platyphyllos*) (nat. size).

The termination of the peduncle, or the part on which the whorls of the flower are arranged, is called the *thalamus*, *lorus* or *receptacle*.

There are two distinct types of inflorescence—one in which the flowers arise as lateral shoots from a primary axis, which goes on elongating, and the lateral shoots never exceed in their development the length of the primary axis beyond their point of origin. The flowers are thus always *axillary*. Exceptions, such as in cruciferous plants, are due to the non-appearance of the bracts. In the other type the primary axis terminates

in a single flower, but lateral axes are given off from the axils of the bracts, which again repeat the primary axis; the development of each lateral axis is stronger than that of the primary axis beyond its point of origin. The flowers produced in this inflorescence are thus *terminal*. The first kind of inflorescence is *indeterminate*, *indefinite* or *axillary*. Here the axis is either elongated,



(From Strasburger's *Lehrbuch der Botanik*, by permission of Gustav Fischer.)
FIG. 8.—Raceme of *Linaria striata*. *d*, bract.



FIG. 9.—Head of flowers (capitulum) of *Scabiosa atropurpurea*. The inflorescence is simple and indeterminate, and the expansion of the flowers centripetal, those at the circumference opening first.

in a single flower, but lateral axes are given off from the axils of the bracts, which again repeat the primary axis; the development of each lateral axis is stronger than that of the primary axis beyond its point of origin. The flowers produced in this inflorescence are thus *terminal*. The first kind of inflorescence is *indeterminate*, *indefinite* or *axillary*. Here the axis is either elongated,

producing flower-buds as it grows, the lower expanding first (fig. 8), or it is shortened and depressed, and the outer flowers expand first (fig. 9). The expansion of the flowers is thus *centripetal*, that is, from base to apex, or from circumference to centre.

The second kind of inflorescence is *determinate*, *definite* or *terminal*. In this the axis is either elongated and ends in a solitary flower, which thus terminates the axis, and if other flowers are produced, they belong to secondary axes farther from the centre;

or the axis is shortened and flattened, producing a number of separate floral axes, the central one expanding first, while the others are developed in succession farther from the centre. The expansion of the flowers is in this case *centrifugal*, that is, from apex to base, or from centre to circumference. It is illustrated in fig. 10, *Ranunculus bulbosus*; *a'* is the primary axis swollen at the base in a bulb-like manner *b*, and with roots proceeding from it. From the leaves which are radical proceeds the axis ending in a solitary terminal flower *f'*. About the middle of this axis there is a leaf or bract, from which a secondary floral axis *a''* is produced, ending in a single flower *f''*, less advanced than the flower *f'*. This secondary axis bears a leaf also, from which a tertiary floral axis *a'''* is produced, bearing an unexpanded solitary flower *f'''*. From this tertiary axis a fourth is in progress of formation. Here *f'* is the termination of the primary axis, and this flower expands first, while the other flowers are developed centrifugally on separate axes.

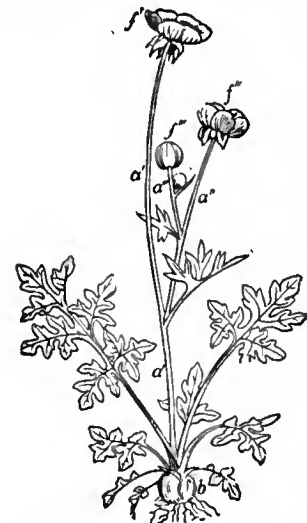

FIG. 10.—Plant of *Ranunculus bulbosus*, showing determinate inflorescence.

A third series of inflorescences, termed *mixed*, may be recognized. In them the primary axis has an arrangement belonging to the opposite type from that of the branches, or vice versa. According to the mode and degree of development of the lateral shoots and also of the bracts, various forms of both inflorescences result.

A third series of inflorescences, termed *mixed*, may be recognized. In them the primary axis has an arrangement belonging to the opposite type from that of the branches, or vice versa. According to the mode and degree of development of the lateral shoots and also of the bracts, various forms of both inflorescences result.

Amongst indefinite forms the simplest occurs when a lateral shoot produced in the axil of a large single foliage leaf of the plant ends in a single flower, the axis of the plant elongating beyond, as in *Veronica hederifolia*, *Vinca minor* and *Lysimachia nemorum*. The flower in this case is *solitary*, and the ordinary leaves become bracts by producing flower-buds in place of leaf-buds; their number, like that of the leaves of this main axis, is indefinite, varying with the vigour of the plant. Usually, however, the floral axis, arising from a more or less altered leaf or bract, instead of ending in a solitary flower, is prolonged, and bears numerous bracteoles, from which smaller peduncles are produced, and those again in their turn may be branched in a similar way. Thus the flowers are arranged in groups, and frequently very complicated forms of inflorescence result. When the primary peduncle or floral axis, as in fig. 8, is elongated, and gives off pedicels, ending in single flowers, a *raceme* is produced, as in currant, hyacinth and barberry. If the secondary floral axes give rise to tertiary ones, the raceme is branching, and forms a *panicle*, as in *Yucca gloriosa*. If in a raceme the lower flower-stalks are developed more strongly than the upper, and thus all the flowers are nearly on a level, a *corymb* is formed, which may be simple, as in fig. 11, where the primary axis *a'* gives off secondary axes *a''*, *a'''*, which end in single flowers; or branching, where the secondary axes again subdivide. If the pedicels are very short or wanting, so that the flowers are sessile, a *spike* is produced, as in *Plantago* and vervain (*Verbena officinalis*) (fig. 12). If the spike bears unisexual flowers, as in willow or hazel (fig. 13), it is an *amentum* or *catkin*, hence such trees are called *amentiferous*; at

other times it becomes succulent, bearing numerous flowers, surrounded by a sheathing bract or spathe, and then it constitutes a *spadix*, which may be simple, as in *Arum maculatum* (fig. 14), or branching as in palms. A spike bearing female flowers only, and covered with scales, is a *strobilus*, as in the hop. In grasses



FIG. 11.



FIG. 12.



FIG. 13.

FIG. 11.—Corymb of *Cerasus Mahaleb*, terminating an abortive branch, at the base of which are modified leaves in the form of scales, *e*. *a'*, Primary axis; *a''*, secondary axes bearing flowers; *b*, bract in the axils of which the secondary axes arise.

FIG. 12.—Spike of Vervain (*Verbena officinalis*), showing sessile flowers on a common rachis. The flowers at the lower part of the spike have passed into fruit, those towards the middle are in full bloom, and those at the top are only in bud.

FIG. 13.—Amentum or catkin of Hazel (*Corylus Avellana*), consisting of an axis or rachis covered with bracts in the form of scales, each of which covers a male flower, the stamens of which are seen projecting beyond the scale. The catkin falls off in a mass, separating from the branch by an articulation.

there are usually numerous sessile flowers arranged in small spikes, called *locustae* or *spikelets*, which are either set closely along a central axis, or produced on secondary axes formed by the branching of the central one; to the latter form the term *panicle* is applied.

If the primary axis, in place of being elongated, is contracted, it gives rise to other forms of indefinite inflorescence. When the axis is so shortened that the secondary axes arise from a common point, and spread out as *radii* of nearly equal length, each ending in a single flower or dividing again in a similar radiating manner,

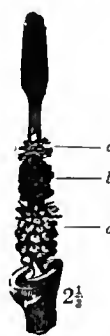

(From Strasburger's *Lehrbuch der Botanik*, by permission of Gustav Fischer.)

FIG. 14.—Spadix of *Arum maculatum*. (After Wossidlo.) *a*, Female flowers; *b*, male flowers; *c*, hairs representing sterile flowers.

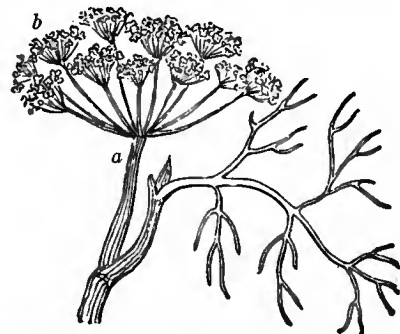

FIG. 15.—Compound umbel of Common Dill (*Anethum graveolens*), having a primary umbel *a*, and secondary umbels *b*, without either involucre or involucl.

an *umbel* is produced, as in fig. 15. From the primary floral axis *a* the secondary axes come off in a radiating or umbrella-like manner, and end in small umbels *b*, which are called *partial umbels* or *umbellules*. This inflorescence is seen in hemlock and other allied plants, which are hence called *umbelliferous*. If there are numerous flowers on a flattened, convex or slightly concave receptacle, having either very short pedicels or none, a

capitulum (head) is formed, as in dandelion, daisy and other composite plants (fig. 2), also in scabious (fig. 9) and teasel. In the American button-bush the heads are globular, in some species of teasel elliptical, while in scabious and in composite plants, as sunflower, dandelion, thistle, centaury and marigold, they are somewhat hemispherical, with a flattened, slightly hollowed, or convex disk. If the margins of such a receptacle be developed upwards, the centre not developing, a concave receptacle is formed, which may partially or completely enclose a number of flowers that are generally unisexual. This gives rise to the peculiar inflorescence of *Dorstenia*, or to that of the fig (fig. 6), where the flowers are placed on the inner surface of the hollow receptacle, and are provided with bracteoles. This inflorescence has been called a *hypanthodium*.

Lastly, we have what are called *compound indefinite* inflorescences. In these forms the lateral shoots, developed centripetally upon the primary axis, bear numerous bracteoles, from which floral shoots arise which may have a centripetal arrangement similar to that on the mother shoot, or it may be different. Thus we may have a group of racemes, arranged in a racemose manner on a common axis, forming a raceme of racemes or compound raceme, as in *Astilbe*. In the same way we may have compound umbels, as in hemlock and most Umbelliferae (fig. 15), a compound spike, as in rye-grass, a compound spadix, as in some palms, and a compound capitulum, as in the hen-and-chickens daisy. Again, there may be a raceme of capitula, that is, a group of capitula disposed in a racemose manner, as in *Petasites*, a raceme of umbels, as in ivy, and so on, all the forms of inflorescence being indefinite in disposition. In *Eryngium* the shortening of the pedicels changes an umbel into a capitulum.

The simplest form of the definite type of the inflorescence is seen in *Anemone nemorosa* and in gentianella (*Gentiana acaulis*), where the axis terminates in a single flower, no other flowers being produced upon the plant. This is a *solitary terminal* inflorescence. If other flowers were produced, they would arise as lateral shoots from the bracts below the first-formed flower. The general name of *cyme* is applied to the arrangement of a group of flowers in a definite inflorescence. A *cymose* inflorescence is an inflorescence where the primary floral axis before terminating in a flower gives off one or more lateral unifloral axes which repeat the process—the development being only limited by the vigour of the plant. The floral axes are thus centrifugally developed. The cyme, according to its development, has been characterized as *biparous* or *uniparous*. In fig. 16 the biparous cyme is represented in the flowering branch of *Cerastium*. Here the primary axis *l* ends in a flower, which has passed into the state of fruit. At its base two leaves are produced, in each of which arise secondary axes *l'* *l'*, ending in single flowers, and at the base of these axes a pair of opposite leaves is produced, giving rise to tertiary axes *l''* *l''*, ending in single flowers, and so on. The term *dichasium* has also been applied to this form of cyme.

In the natural order Carophyllaceae (pink family) the dichasial form of inflorescence is very general. In some members of the order, as *Dianthus barbatus*, *D. carthusianorum*, &c., in which the peduncles are short, and the flowers closely approximated, with a centrifugal expansion, the inflorescence has the form of a contracted dichasium, and receives the name of *fascicle*. When the axes become very much shortened, the arrangement is more complicated in appearance, and the nature of the inflorescence can only be recognized by the order of opening of the flowers. In Labiate plants, as the dead-nettle (*Lamium*), the flowers are produced in the axil of each of the foliage leaves of the plant, and they appear as if arranged in a simple whorl of flowers. But on examination it is found that there is a central flower expanding first, and from its axis two secondary axes spring bearing solitary flowers; the expansion is thus centrifugal. The inflorescence is therefore a contracted dichasium, the flowers being sessile, or nearly so, and the clusters are called *verticillasters* (fig. 17). Sometimes, especially towards the summit of a dichasium, owing to the exhaustion of the growing power of the plant, only one of the bracts gives origin to a new axis, the other

remaining empty; thus the inflorescence becomes unilateral, and further development is arrested. In addition to the dichasial form there are others where more than two lateral axes are produced from the primary floral axis, each of which in turn

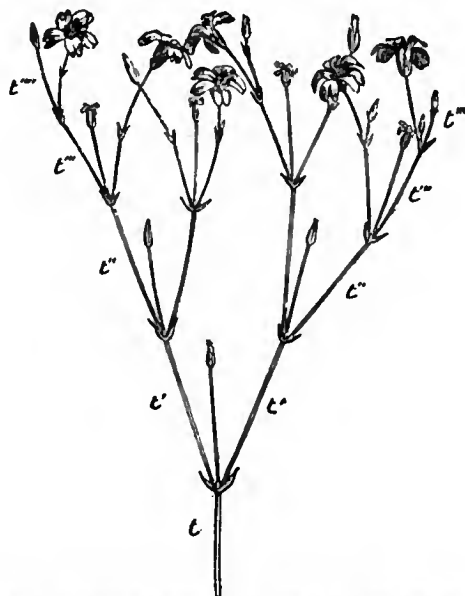

(From Strasburger's *Lehrbuch der Botanik*, by permission of Gustav Fischer.)

FIG. 16.—Cymose inflorescence (dichasium) of *Cerastium collinum*, *l* *l''*, successive axes. (After Duchartre.)

produces numerous axes. To this form the terms *trichasial* and *polychasial cyme* have been applied; but these are now usually designated *cymose umbels*. They are well seen in some species of *Euphorbia*. Another term, *anthela*, has been used to distinguish such forms as occur in several species of *Luzula* and

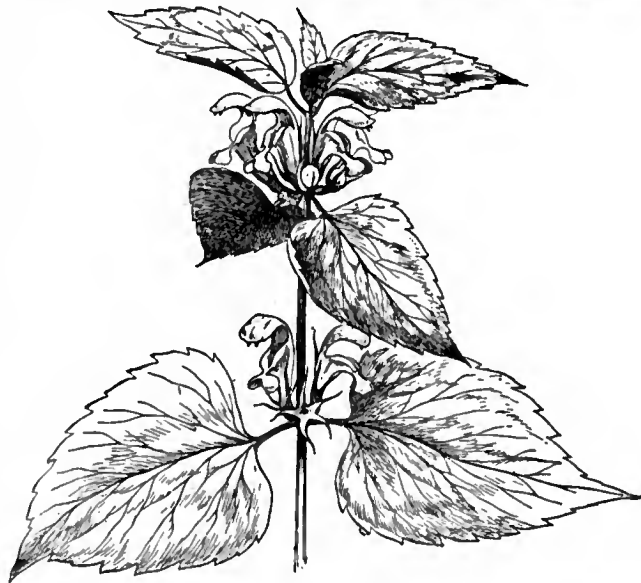

FIG. 17.—Flowering stalk of the White Dead-nettle (*Lamium album*). The bracts are like the ordinary leaves of the plant, and produce clusters of flowers in their axil. The clusters are called verticillasters, and consist of flowers which are produced in a centrifugal manner.

Juncus, where numerous lateral axes arising from the primary axis grow very strongly and develop in an irregular manner.

In the uniparous cyme a number of floral axes are successively developed one from the other, but the axis of each successive generation, instead of producing a pair of bracts, produces only one. The basal portion of the consecutive axes may become much thickened and arranged more or less in a straight line,

and thus collectively form an apparent or false axis or *sympodium*, and the inflorescence thus simulates a raceme. In the true raceme, however, we find only a single axis, producing in succession a series of bracts, from which the floral peduncles arise as lateral shoots, and thus each flower is on the same side of the floral axis as the bract in the axil of which it is developed; but in the uniparous cyme the flower of each of these axes, the basal portions of which unite to form the false axis, is situated on the opposite side of the axis to the bract from which it apparently arises (fig. 18). The bract is not, however, the one from which the axis terminating in the flower arises, but is a bract produced upon it, and gives origin in its axil to a new axis, the basal portion



FIG. 18.



FIG. 19.

FIG. 18.—Helicoid cyme of a species of *Alstroemeria*. a_1, a_2, a_3, a_4 , &c., separate axes successively developed in the axils of the corresponding bracts b_1, b_2, b_3, b_4 , &c., and ending in a flower f_1, f_2, f_3, f_4 , &c. The whole appears to form a simple raceme of which the axes form the internodes.

FIG. 19.—Scorpioidal or cical cyme of Forget-me-not (*Myosotis palustris*).

FIG. 20.—Diagram of definite floral axes a, b, c, d, e , &c.

FIG. 21.—Flowering stalk of Ragwort (*Senecio*). The flowers are in heads (capitula), and open from the circumference inwards in an indefinite centripetal manner. The heads of flowers, on the other hand, taken collectively, expand centrifugally—the central one a first.

of which, constituting the next part of the false axis, occupies the angle between this bract and its parent axis—the bract from which the axis really does arise being situated lower down upon the same side of the axis with itself. The uniparous cyme presents two forms, the *scorpioid* or *cical* and the *helicoid* or *bostrychoid*.

In the scorpioid cyme the flowers are arranged alternately in a double row along one side of the false axis (fig. 19), the bracts when developed forming a second double row on the opposite side; the whole inflorescence usually curves on itself like a scorpion's tail, hence its name. In fig. 20 is shown a diagrammatic sketch of this arrangement. The false axis, $a b c d$, is formed by successive generations of unifloral axes, the flowers being arranged along one side alternately and in a double row; had the bracts been developed they would have formed a similar double row on the opposite side of the false axis; the whole

inflorescence is represented as curved on itself. The inflorescence in the family Boraginaceae are usually regarded as true scorpioid cymes.

In the helicoid cyme there is also a false axis formed by the basal portion of the separate axes, but the flowers are not placed in a double row, but in a single row, and form a spiral or helix round the false axis. In *Alstroemeria*, as represented in fig. 18, the axis a_1 ends in a flower (cut off in the figure) and bears a leaf. From the axil of this leaf, that is, between it and the primary axis a_1 arises a secondary axis a_2 , ending in a flower f_2 , and producing a leaf about the middle. From the axil of this leaf a tertiary floral axis a_3 , ending in a flower f_3 , takes origin. In this case the axes are not arranged in two rows along one side of the false axis, but are placed at regular intervals, so as to form an elongated spiral round it.

Compound definite inflorescences are by no means common, but in *Streptocarpus polyanthus* and in several calceolarias we probably have examples. Here there are *scorpioid cymes* of pairs of flowers, each pair consisting of an older and a younger flower.

Forms of inflorescence occur, in which both the definite and indefinite types are represented—*mixed* inflorescences.

Thus in Composite plants, such as hawkweeds (*Hieracia*) and ragworts (*Senecio*, fig. 21), the heads of flowers, taken as a whole, are developed centrifugally, the terminal head first, while the florets, or small flowers on the receptacle, open centripetally, those at the circumference first. So also in Labiatae, such as dead-nettle (*Lamium*), the different whorls of inflorescence are developed centripetally, while the florets of the verticillaster are centrifugal. This mixed character presents difficulties in such cases as Labiatae, where the leaves, in place of retaining their ordinary form, become bracts, and thus might lead to the supposition of the whole series of flowers being one inflorescence. In such cases the cymes are described as spiked, racemose, or paniced, according to circumstances. In *Saxifraga umbrosa* (London-pride) and in the horse-chestnut we meet with a raceme of scorpioid cymes; in sea-pink, a capitulum of contracted scorpioid cymes (often called a glomerulus); in laurustinus, a compound umbel of dichasial cymes; a scorpioid cyme of capitula in *Vernonia scorpioides*. The so-called catkins of the birch are, in reality, spikes of contracted dichasial cymes. In the bell-flower (*Campanula*) there is a racemose uniparous cyme. In the privet (*Ligustrum vulgare*) there are numerous racemes of dichasia arranged in a racemose manner along an axis; the whole inflorescence thus has an appearance not unlike a bunch of grapes, and has been called a *thyrsus*.

Mixed
Inflores-
cence.

TABULAR VIEW OF INFLORESCENCES

- A. Indefinite Centripetal Inflorescence.
 - I. Flowers solitary, axillary. *Vinca*, *Veronica hederifolia*.
 - II. Flowers in groups, pedicellate.
 1. Elongated form (Raceme), *Hyacinth*, *Laburnum*, *Currant*. (Corymb), *Ornithogalum*.
 2. Contracted or shortened form (Umbel), *Cowslip*, *Astrantia*.
 - III. Flowers in groups, sessile.
 1. Elongated form (Spike), *Plantago*. (Spikelet), *Grasses*. (Amentum, Catkin), *Willow*, *Hazel*. (Spadix) *Arum*, some *Palms*. (Strobilus), *Hop*.
 2. Contracted or shortened form (Capitulum), *Daisy*, *Dandelion*, *Scabious*.
 - IV. Compound Indefinite Inflorescence.
 - a. Compound Spike, *Rye-grass*.
 - b. Compound Spadix, *Palms*.
 - c. Compound Raceme, *Astilbe*.
 - d. Compound Umbel, *Hemlock* and most *Umbelliferae*.
 - e. Raceme of Capitula, *Petasites*.
 - f. Raceme of Umbels, *Ivy*.
- B. Definite Centrifugal Inflorescence.
 - I. Flowers solitary, terminal. *Gentianella*, *Tulip*.
 - II. Flowers in Cymes.
 1. Uniparous Cyme.
 - a. Helicoid Cyme (axes forming a spiral). Elongated form, *Alstroemeria*. Contracted form, *Witsenia corymbosa*.

b. Scorpioid Cyme (axes unilateral, two rows).

Elongated form, *Forget-me-not*, *Symphytum*, *Henbane*.

Contracted form, *Erodium*, *Alchemilla arvensis*.

2. Biparous Cyme (Dichotomous), including 3-5-chotomous Cymes (Dichasium, Cymose Umbel, Anthela).

a. Elongated form, *Cerastium*, *Stellaria*.

b. Contracted form (Verticillaster), *Dead-nettle*, *Pelargonium*.

3. Compound Definite Inflorescence. *Streptocarpus polyanthus*, many *Calceolarias*.

C. Mixed Inflorescence.

Raceme of Scorpioid Cymes, *Horse-chestnut*.

Scorpioid Cyme of Capitula, *Vernonia scorpioides*.

Compound Umbel of Dichotomous Cymes, *Laurustinus*.

Capitulum of contracted Scorpioid Cymes (Glomerulus), *Sea-pink*.

The flower consists of the floral axis bearing the sporophylls (stamens and carpels), usually with certain protective envelopes.



FIG. 22.



FIG. 25.



FIG. 23.

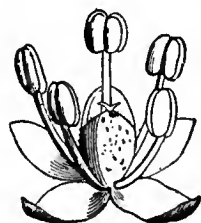

FIG. 24.

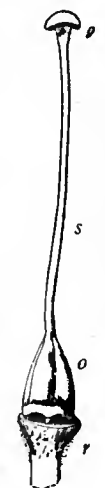

FIG. 26.

FIG. 22.—Flower of *Sedum rubens*. s, Sepals; p, petals; a, stamens; c, carpels.

FIG. 23.—Diagram of a completely symmetrical flower, consisting of four whorls, each of five parts. s, Sepals; p, petals; a, stamens; c, carpels.

FIG. 24.—Monochlamydeous (apetalous) flower of Goose-foot (*Chenopodium*), consisting of a single perianth (calyx) of five parts, enclosing five stamens, which are opposite the divisions of the perianth, owing to the absence of the petals.

FIG. 25.—Stamen, consisting of a filament (stalk) f and an anther a, containing the pollen p, which is discharged through slits in the two lobes of the anther.

FIG. 26.—The pistil of Tobacco (*Nicotiana Tabacum*), consisting of the ovary o, containing ovules, the style s, and the capitate stigma g. The pistil is placed on the receptacle r, at the extremity of the peduncle.

Thus, in the tulip, crocus, lily, hyacinth, we speak of the parts of the perianth, in place of calyx and corolla, although in these plants there is an outer

The axis is usually very much contracted, no internodes being developed, and the portion bearing the floral leaves, termed the *thalamus* or *torus*, frequently expands into a conical, flattened or hollowed expansion; at other times, though rarely, the internodes are developed and it is elongated. Upon this torus the parts of the flower are arranged in a crowded manner, usually forming a series of verticils, the parts of which alternate; but they are sometimes arranged spirally especially if the floral axis be elongated. In a typical flower, as in fig. 22, we recognize four distinct whorls of leaves: an outer whorl, the *calyx* of *sepals*; within it, another whorl, the parts alternating with those of the outer whorl, the *corolla* of *petals*; next a whorl of parts alternating with the parts of the corolla, the *androecium* of *stamens*; and in the centre the *gynoecium* of *carpels*. Fig. 23 is a diagrammatic representation of the arrangement of the parts of such a flower; it is known as a *floral diagram*. The flower is supposed to be cut transversely, and the parts of each whorl are distinguished by a different symbol. Of these whorls the two internal, forming the sporophylls, constitute the *essential* organs of reproduction; the two outer whorls are the protective coverings or floral *envelopes*. The sepals are generally of a greenish colour; their function is mainly protective, shielding the more delicate internal organs before the flower opens. The petals are usually showy, and normally alternate with the sepals. Sometimes, as usually in monocotyledons, the calyx and corolla are similar; in such cases the term *perianth*, or *perigone*, is applied.

whorl (calyx), of three parts, and an inner (corolla), of a similar number, alternating with them. When the parts of the calyx are in appearance like petals they are said to be *petaloid*, as in Liliaceae. In some cases the petals have the appearance of sepals, then they are *sepaloid*, as in Juncaceae. In plants, as *Nymphaea alba*, where a spiral arrangement of the floral leaves occurs, it is not easy to say where the calyx ends and the corolla begins, as these two whorls pass insensibly into each other. When both calyx and corolla are present, the plants are *dichlamydeous*; when one only is present, the flower is termed *monochlamydeous* or *apetalous*, having no petals (fig. 24). Sometimes both are absent, when the flower is *achlamydeous*, or naked, as in willow. The outermost series of the essential organs, collectively termed the *androecium*, is composed of the microsporophylls known as the staminal leaves or *stamens*. In their most differentiated form each consists of a stalk, the *filament* (fig. 25, f), supporting at its summit the anther (a), consisting of the pollen-sacs which contain the powdery pollen (p), the microspores, which is ultimately discharged therefrom. The *gynoecium* or *pistil* is the central portion of the flower, terminating the floral axis. It consists of one or more *carpels* (megasporophylls), either separate (fig. 22, c) or combined (fig. 24). The parts distinguished in the pistil are the *ovary* (fig. 26, o), which is the lower portion enclosing the *ovules* destined to become seeds, and the *stigma* (g), a portion of loose cellular tissue, the receptive surface on which the pollen is deposited, which is either sessile on the apex of the ovary, as in the poppy, or is separated from it by a prolonged portion called the *style* (s). The androecium and gynoecium are not present in all flowers. When both are present the flower is *hermaphrodite*; and in descriptive botany such a flower is indicated by the symbol ♀. When only one of those organs is present the flower is *unisexual* or *diclinous*, and is either male (*staminate*), ♂, or female (*pistillate*), ♀. A flower then normally consists of the four series of leaves—calyx, corolla, androecium and gynoecium—and when these are all present the flower is *complete*. These are usually densely crowded upon the thalamus, but in some instances, after apical growth has ceased in the axis, an elongation of portions of the receptacle by intercalary growth occurs, by which changes in the position of the parts may be brought about. Thus in *Lychnis* an elongation of the axis betwixt the calyx and the corolla takes place, and in this way they are separated by an interval. Again, in the passion-flower (*Passiflora*) the stamens are separated from the corolla by an elongated portion of the axis, which has consequently been termed the *androphore*, and in *Passiflora* also, fraxinella (fig. 27), Cappariaceae, and some other plants, the ovary is raised upon a distinct stalk termed the *gynophore*; it is thus separated from the stamens, and is said to be *stipitate*. Usually the successive whorls of the flower, disposed from below upwards or from without inwards upon the floral axis, are of the same number of parts, or are a multiple of the same number of parts, those of one whorl alternating with those of the whorls next it.



FIG. 27.—Calyx and pistil of Fraxinella (*Dictamnus Fraxinella*). The pistil consists of several carpels, which are elevated on a stalk or gynophore prolonged from the receptacle

In the more primitive types of flowers the torus is more or less convex, and the series of organs follow in regular succession, culminating in the carpels, in the formation of which the growth of the axis is closed (fig. 28). This arrangement is known as *hypogynous*, the other series (calyx, corolla and stamens) being beneath (*hypo-*) the gynoecium. In other cases, the apex of the growing point ceases to develop, and the parts below form a cup around it, from the rim of which the outer members of the flower are developed around (*peri-*) the carpels, which are formed from the apex of the growing-point at the bottom of the cup. This arrangement is known as *perigynous* (fig. 29). In many cases this is carried farther and a cavity is formed which is roofed over

by the carpels, so that the outer members of the flower spring from the edge of the receptacle which is immediately above the ovary (epigynous), hence the term epigyny (fig. 30).

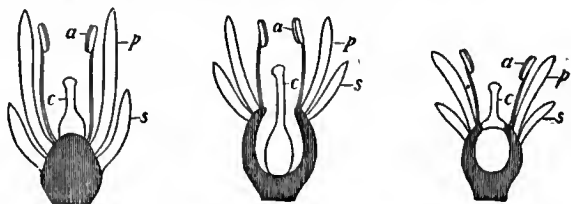

FIG. 28.

FIG. 29.

FIG. 30.

FIGS. 28, 29 and 30.—Diagrams illustrating hypogyny, perigyny and epigyny of the flower. *a*, Stamens; *c*, carpels; *p*, petals; *s*, sepals.

When a flower consists of parts arranged in whorls it is said to be *cyclic*, and if all the whorls have an equal number of parts and are alternate it is *eucyclic* (figs. 22, 23). In contrast to the cyclic flowers are those, as in Magnoliaceae, where the parts are in spirals (*acyclic*). Flowers which are cyclic at one portion and spiral at another, as in many Ranunculaceae, are termed *hemicyclic*. In spiral flowers the distinction into series is by no means easy, and usually there is a gradual passage from sepaloid through petaloid to staminal parts, as in the water-lily family, Nymphaeaceae (figs. 31, 32), although in some plants there is no such distinction, the

Symmetry of the flower.

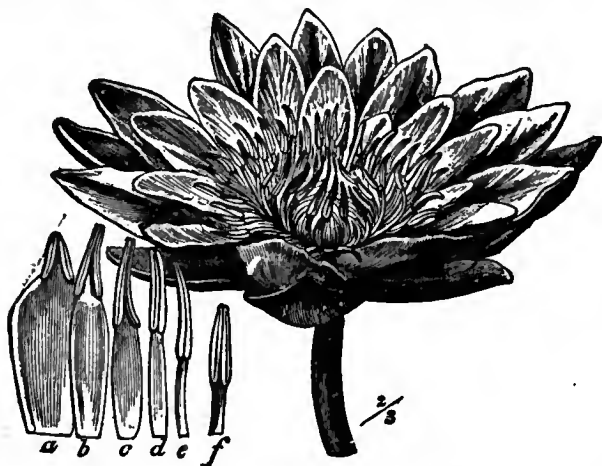

FIG. 3.

FIG. 31.

From Strasburger's *Text-Book of Botany*, by permission of Macmillan & Co., Ltd.

FIGS. 31 and 32.—White Water Lily. Fig. 31, flower; fig. 32, successive stages, *a-f*, in the transition from petals to stamens. (After Wossidlo.)

parts being all petaloid, as in *Trollius*. Normally, the parts of successive whorls alternate; but in some cases we find the parts of one whorl opposite or *superposed* to those of the next whorl. In some cases, as in the vine-family Ampelidaceae, this seems to be the ordinary mode of development, but the superposition of the stamens on the sepals in many plants, as in the pink family, Caryophyllaceae, is due to the suppression or abortion of the whorl of petals, and this idea is borne out by the development, in some plants of the order, of the suppressed whorl. As a rule, whenever we find the parts of one whorl superposed on those of another we may suspect some abnormality.

A flower is said to be *symmetrical* when each of its whorls consists of an equal number of parts, or when the parts of any one whorl are multiples of that preceding it. Thus, a symmetrical flower may have five sepals, five petals, five stamens and five carpels, or the number of any of these parts may be ten, twenty or some multiple of five. Fig. 23 is a diagram of a symmetrical flower, with five parts in each whorl, alternating with each other. Fig. 33 is a diagram of a symmetrical flower of stone-crop, with five sepals, five alternating petals, ten

stamens and five carpels. Here the number of parts in the staminal whorl is double that in the others, and in such a case the additional five parts form a second row alternating with the others. In the staminal whorl especially it is common to find additional rows. Fig. 34 shows a symmetrical flower, with five parts in the three outer rows, and ten divisions in the inner. In this case it is the gynoecium which has an additional number of parts. Fig. 35 shows a flower of heath, with four divisions of the calyx and corolla, eight stamens in two rows, and four divisions of the pistil. In fig.

36 there are three parts in each whorl; and in fig. 37 there are three divisions of the calyx, corolla and pistil, and six stamens in two rows. In all these cases the flower is symmetrical. In Monocotyledons it is usual for the staminal whorl to be double, it rarely having more than two rows, whilst amongst dicotyledons there are often very numerous rows of stamens. The floral envelopes are rarely multiplied. Flowers in which the number of parts in each whorl is the same, are *isomerous* (of equal number); when the number in some of the whorls is different, the flower is *anisomerous* (of unequal number). The pistillate whorl is very liable to changes. It frequently happens that when it is fully formed, the number of its parts is not in conformity with that of the other whorls. In such circumstances, however, a flower has been called symmetrical, provided the parts of the other whorls are normal,—the permanent state of the pistil not being taken into account in determining symmetry. Thus fig. 38 shows a pentamerous symmetrical flower, with dimerous pistil. Symmetry, then, in botanical language, has reference to a certain definite numerical relation of parts. A flower in which the parts are arranged in twos is called *dimerous*; when the parts of the whorls are three, four or five, the flower is *trimerous*, *tetramerous* or *pentamerous*, respectively. The symmetry which is most commonly met with is trimerous and pentamerous—the former occurring generally among monocotyledons, the latter among dicotyledons. Dimerous and tetramerous symmetry occur also among dicotyledons.

The various parts of the flower have a certain definite relation to the axis. Thus, in axillary tetramerous flowers (fig. 35), one sepal is next the axis, and is called *superior* or *posterior*; another is next the bract, and is *inferior* or *anterior*, and the other two are *lateral*; and certain terms are used to indicate that position. A plane passing through the anterior and posterior sepal and through the floral axis is termed the *median plane* of the flower; a plane cutting it at right angles, and passing through the lateral sepals, is the *lateral plane*; whilst the planes which bisect the

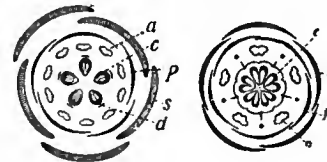

FIG. 33.

FIG. 34.

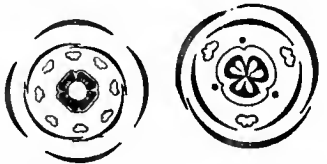

FIG. 35.

FIG. 36.

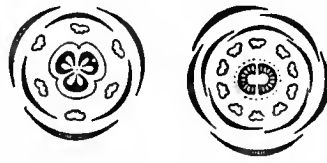

FIG. 37.

FIG. 38.

FIG. 33.—Diagrammatic section of a symmetrical pentamerous flower of Stone-crop (*Sedum*), consisting of five sepals (*s*), five petals (*p*) alternating with the sepals, ten stamens (*a*) in two rows, and five carpels (*c*) containing ovules. The dark lines (*d*) on the outside of the carpels are glands.

FIG. 34.—Diagram of the flower of Flax (*Linum*), consisting of five sepals (*s*), five petals (*p*), five stamens (*a*), and five carpels (*c*), each of which is partially divided into two. The dots represent a whorl of stamens which has disappeared. It is pentamerous, complete, symmetrical and regular.

FIG. 35.—Diagram of the flower of Heath (*Erica*), a regular tetramerous flower.

FIG. 36.—Diagram of the trimerous symmetrical flower of Iris.

FIG. 37.—Diagram of the symmetrical trimerous flower of Fritillary (*Fritillaria*).

FIG. 38.—Diagram of the flower of Saxifrage (*Saxifraga tridactylites*). The calyx and corolla consist of five parts, the stamens are ten in two rows, while the pistil has only two parts developed.

FIG. 38.—Diagram of the flower of Saxifrage (*Saxifraga tridactylites*). The calyx and corolla consist of five parts, the stamens are ten in two rows, while the pistil has only two parts developed.

angles formed by the lateral and median planes are the *diagonal planes*, and in these flowers the petals which alternate with the sepals are cut by the diagonal planes.

In a pentamerous flower one sepal may be superior, as in the calyx of Rosaceae and Labiatae; or it may be inferior, as in the calyx of Leguminosae (fig. 39)—the reverse, by the law of alternation, being the case with the petals. Thus, in the blossom of the pea (figs. 39, 40), the odd petal (vexillum) *st* is superior,

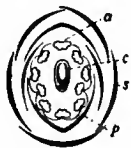

FIG. 39.—Diagram of flower of Sweet-pea (*Lathyrus*), showing five sepals (*s*), two superior, one inferior, and two lateral; five petals (*p*), one superior, two inferior, and two lateral; ten stamens in two rows (*a*); and one carpel (*c*).

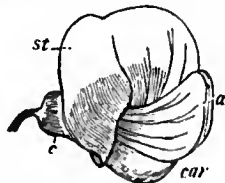

FIG. 40.—Flower of Pea (*Pisum sativum*), showing a papilionaceous corolla, with one petal superior (*st*) called the standard (vexillum), two inferior (*car*) called the keel (carina), and two lateral (*a*) called wings (alae). The calyx is marked *c*.

while the odd sepal is inferior. In the order Scrophulariaceae one of the two carpels is posterior and the other anterior, whilst in Convolvulaceae the carpels are arranged laterally. Sometimes the twisting of a part makes a change in the position of other parts, as in Orchids, where the twisting of the ovary changes the position of the labellum.

When the different members of each whorl are like in size and shape, the flower is said to be *regular*; while differences in the size and shape of the parts of a whorl make the flower *irregular*, as in the papilionaceous flower, represented in fig. 39. When a flower can be divided by a single plane into two exactly similar parts, then it is said to be *zygomorphic*. Such flowers as Papilionaceae, Labiatae, are examples. In contrast with this are *polysymmetrical* or actinomorphic flowers, which have a radial symmetry and can be divided by several planes into several exactly similar portions; such are all regular, symmetrical flowers. When the parts of any whorl are not equal to or some multiple of the others, then the flower is *asymmetrical*. This want of symmetry may be brought about in various ways. Alteration in the symmetrical arrangement as well as in the completeness and regularity of flowers has been traced to *suppression* or the *non-development* of parts, *degeneration* or imperfect formation, *cohesion* or union of parts of the same whorl, *adhesion* or union of the parts of different whorls, *multiplication* of parts, and *deduplication* (sometimes called *chorisis*) or splitting of parts.

By *suppression* or non-appearance of a part at the place where it ought to appear if the structure was normal, the symmetry or completeness of the flower is disturbed. This suppression when confined to the parts of certain verticils makes the flower asymmetrical. Thus, in many Caryophyllaceae, as *Polycarpon* and *Holosteum*, while the calyx and corolla are pentamerous, there are only three or four stamens and three carpels; in *Impatiens Noli-me-tangere* the calyx is composed of three parts, while the other verticils have five; in labiate flowers there are five parts of the calyx and corolla, and only four stamens; and in *Tropacolum pentaphyllum* there are five sepals, two petals, eight stamens and three carpels. In all these cases the want of symmetry is traced to the suppression of certain parts. In the last-mentioned plant the normal number is five, hence it is said that there are three petals suppressed, as shown by the position of the two remaining ones; there are two rows of stamens, in each of which one is wanting; and there are two carpels suppressed. In many instances the parts which are afterwards suppressed can be seen in the early stages of growth, and occasionally some vestiges of them remain in the fully developed flower. By the suppression of the verticil of the stamens, or of the carpels, flowers become *unisexual* or *diclinous*, and by the suppression of one or both of the floral envelopes, *monochlamydeous* and *achlamydeous* flowers are produced. The suppression

of parts of the flower may be carried so far that at last a flower consists of only one part of one whorl. In the Euphorbiaceae we have an excellent example of the gradual suppression of parts, where from an apetalous, trimerous, staminal flower we pass to one where one of the stamens is suppressed, and then to forms where two of them are wanting. We next have flowers in which the calyx is suppressed, and its place occupied by one, two or three bracts (so that the flower is, properly speaking, *achlamydeous*), and only one or two stamens are produced. And finally, we find flowers consisting of a single stamen with a bract. There is thus traced a *degradation*, as it is called, from a flower with three stamens and three divisions of the calyx, to one with a single bract and a single stamen.

Degeneration, or the transformation of parts, often gives rise either to an apparent want of symmetry or to irregularity in form. In unisexual flowers it is not uncommon to find vestiges of the undeveloped stamens in the form of filiform bodies or scales. In double flowers transformations of the stamens and pistils take place, so that they appear as petals. In *Canna*, what are called petals are in reality metamorphosed stamens. In the capitula of Compositae we sometimes find the florets converted into green leaves. The limb of the calyx may appear as a rim, as in some Umbelliferae; or as pappus, in Compositae and *Valeriana*. In *Scrophularia* the fifth stamen appears as a scale-like body; in other Scrophulariaceae, as in *Pentstemon*, it assumes the form of a filament, with hairs at its apex in place of an anther.

Cohesion, or the union of parts of the same whorl, and *adhesion*, or the growing together of parts of different whorls, are causes of change both as regards form and symmetry. Thus in *Cucurbita* the stamens are originally five in number, but subsequently some cohere, so that three stamens only are seen in the mature flower. Adhesion is well seen in the *gynostemium* of orchids, where the stamens and stigmas adhere. In Capparidaceae the calyx and petals occupy their usual position, but the axis is prolonged in the form of a gynophore, to which the stamens are united.

Multiplication, or an increase of the number of parts, gives rise to changes. We have already alluded to the interposition of new members in a whorl. This takes place chiefly in the staminal whorl, but usually the additional parts produced form a symmetrical whorl with the others. In some instances, however, this is not the case. Thus in the horse-chestnut there is an interposition of two stamens, and thus seven stamens are formed in the flower, which is asymmetrical.

Parts of the flower are often increased by a process of *deduplication*, or *chorisis*, *i.e.* the splitting of a part so that two or more parts are formed out of what was originally one. Thus in Cruciferous plants the staminal whorl consists of four long stamens and two short ones (*tetradynamous*). The symmetry in the flower is evidently dimerous, and the abnormality in the androecium, where the four long stamens are opposite the posterior sepals, takes place by a splitting, at a very early stage of development, of a single outgrowth into two. Many cases of what was considered *chorisis* are in reality due to the development of stipules from the staminal leaf. Thus in *Dicentra* and *Corydalis* there are six stamens in two bundles; the central one of each bundle alone is perfect, the lateral ones have each only half an anther, and are really stipules formed from the staminal leaf. Branching of stamens also produces apparent want of symmetry; thus, in the so-called polyadelphous stamens of Hypericaceae there are really only five stamens which give off numerous branches, but the basal portion remaining short, the branches have the appearance of separate stamens, and the flower thus seems asymmetrical.

Cultivation has a great effect in causing changes in the various parts of plants. Many alterations in form, size, number and adhesion of parts are due to the art of the horticulturist. The changes in the colour and forms of flowers thus produced are endless. In the dahlia the florets are rendered quilled, and are made to assume many glowing colours. In pelargonium the flowers have been rendered larger and more showy; and such is

also the case with the *Ranunculus*, the auricula and the carnation. Some flowers, with spurred petals in their usual state, as columbine, are changed so that the spurs disappear; and others, as *Linaria*, in which one petal only is usually spurred, are altered so as to have all the petals spurred, and to present what are called *pelorian* varieties.

As a convenient method of expressing the arrangement of the parts of the flower, *floral formulae* have been devised. Several modes of expression are employed. The following is a very simple mode which has been proposed:—The several whorls are represented by the letters S (sepals), P (petals), St (stamens), C (carpels), and a figure marked after each indicates the number of parts in that whorl. Thus the formula $S_5P_5St_5C_5$ means that



FIG. 41.

FIG. 42.

FIG. 43.

FIG. 41.—Tetramerous monochlamydeous male flower of the Nettle (*Urtica*).

FIG. 42.—Diagram to illustrate valvular or valvate aestivation, in which the parts are placed in a circle, without overlapping or folding.

FIG. 43.—Diagram to illustrate induplicative or induplicate aestivation, in which the parts of the verticil are slightly turned inwards at the edges.

the flower is perfect, and has pentamerous symmetry, the whorls being isomerous. Such a flower as that of *Sedum* (fig. 33) would be represented by the formula $S_5P_5St_{5+5}C_5$, where St_{5+5} indicates that the staminal whorl consists of two rows of five parts each. A flower such as the male flower of the nettle (fig. 41) would be expressed $S_4P_0St_4C_0$. When no other mark is appended the whorls are supposed to be alternate; but if it is desired to mark the position of the whorls special symbols are employed. Thus, to express the superposition of one whorl upon another, a line is drawn between them, e.g. the symbol $S_5P_5 | St_5C_5$ is the formula of the flower of *Primulaceae*.

The manner in which the parts are arranged in the flower-bud with respect to each other before opening is the *aestivation* or *praefloration*. The latter terms are applied to the flower-bud in the same way as vernation is to the leaf-bud, and distinctive names have been given to the different arrangements exhibited, both by the leaves individually and in their relations to each other. As regards each leaf of the flower, it is either spread out, as the sepals in the bud of the lime-tree, or folded upon itself (conduplicate), as in the petals of some species of *Lysimachia*, or slightly folded inwards or outwards at the edges, as in the



FIG. 44.

FIG. 45.

FIG. 46.

FIG. 44.—Diagram to illustrate reduplicate or reduplicate aestivation, in which the parts of the whorl are slightly turned outwards at the edges.

FIG. 45.—Diagram to illustrate contorted or twisted aestivation, in which the parts of the whorl are overlapped by each other in turn, and are twisted on their axis.

FIG. 46.—Diagram to illustrate the quincuncial aestivation, in which the parts of the flower are arranged in a spiral cycle, so that 1 and 2 are wholly external, 4 and 5 are internal, and 3 is partly external and partly overlapped by 1.

calyx of some species of clematis and of some herbaceous plants, or rolled up at the edges (involute or revolute), or folded transversely, becoming *crumpled* or *corrugated*, as in the poppy. When the parts of a whorl are placed in an exact circle, and are

applied to each other by their edges only, without overlapping or being folded, thus resembling the valves of a seed-vessel, the aestivation is *valvate* (fig. 42). The edges of each of the parts may be turned either inwards or outwards; in the former case the aestivation is *induplicate* (fig. 43), in the latter case *reduplicate* (fig. 44). When the parts of a single whorl are placed in a circle, each of them exhibiting a torsion of its axis, so that by one of its sides it overlaps its neighbour, whilst its side is overlapped in like manner by that standing next to it, the aestivation is *twisted* or *contorted* (fig. 45). This arrangement is characteristic of the flower-buds of Malvaceae and Apocynaceae, and it is also seen in Convolvulaceae and Caryophyllaceae. When the flower expands, the traces of twisting often disappear, but sometimes, as in Apocynaceae, they remain. Those forms of aestivation are such as occur in cyclic flowers, and they are included under *circular* aestivation. But in spiral flowers we have a different arrangement; thus the leaves of the calyx of *Camellia japonica* cover each other partially like tiles on a house. This aestivation is *imbricate*. At other times, as in the petals of *Camellia*, the parts envelop each other completely, so as to become *convolute*. This is also seen in a transverse section of the calyx of *Magnolia grandiflora*, where each of the three leaves embraces that within it. When the parts of a whorl are five, as occurs in many dicotyledons, and the imbrication is such that there are two parts external, two internal, and a fifth which partially covers

one of the internal parts by its margin, and is in its turn partially covered by one of the external parts, the aestivation is *quincuncial* (fig. 46). This quincunx is common in the corolla of Rosaceae. In fig. 47 a section is given of the bud of *Antirrhinum majus*, showing the imbricate spiral arrangement. In this case it will be seen that the part marked 5 has, by a slight change in position, become overlapped by 1. This variety of imbricate aestivation has been termed *cochlear*. In flowers such as those of the pea (fig. 40), one of the parts, the vexillum, is often large and folded over the others, giving rise to *vexillary* aestivation (fig. 48), or the

carina may perform a similar office, and then the aestivation is *carinal*, as in the Judas-tree (*Cercis Siliquastrum*). The parts of the several verticils often differ in their mode of aestivation. Thus, in Malvaceae the corolla is contorted and the calyx valvate, or reduplicate; in *St John's-wort* the calyx is imbricate, and the corolla contorted. In Convolvulaceae, while the corolla is twisted, and has its parts arranged in a circle, the calyx is imbricate, and exhibits a spiral arrangement. In *Guazuma* the calyx is valvate, and the corolla induplicate. The circular aestivation is generally associated with a regular calyx and corolla, while the spiral aestivations are connected with irregular as well as with regular forms.

The *sepals* are sometimes *free* or separate from each other, at other times they are united to a greater or less extent; in the former case, the calyx is *polysepalous*, in the latter *gamosepalous* or *monosepalous*. The divisions of the calyx present usually the characters of leaves, and in some cases of monstrosity they are converted into leaf-like organs, as not infrequently happens in primulas. They are usually entire, but occasionally they are cut in various ways, as in the rose; they are rarely stalked. Sepals are generally of a more or less oval, elliptical or oblong form, with their apices either blunt or

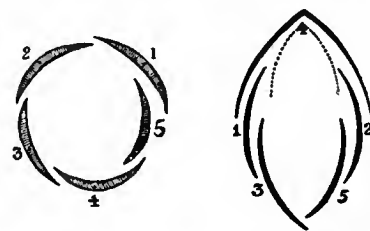

FIG. 47.

FIG. 48.

FIG. 47.—Diagram to illustrate imbricate aestivation, in which the parts are arranged in a spiral cycle, following the order indicated by the figures 1, 2, 3, 4, 5.

FIG. 48.—Diagram of a papilionaceous flower, showing vexillary aestivation.

- 1 and 2, The alae or wings.
 - 3, A part of the carina or keel.
 - 4, The vexillum or standard, which, in place of being internal, as marked by the dotted line, becomes external.
 - 5, The remaining part of the keel.
- The order of the cycle is indicated by the figures.

Calyx.

acute. In their direction they are erect or reflexed (with their apices downwards), spreading outwards (*divergent* or *patulous*), or arched inwards (*connivent*). They are usually of a greenish colour (*herbaceous*); but sometimes they are coloured or *petaloid*, as in the fuchsia, *tropæolum*, globe-flower and pomegranate. Whatever be its colour, the external envelope of the flower is considered as the calyx. The vascular bundles sometimes form a prominent rib, which indicates the middle of the sepal; at other times they form several ribs. The venation is useful as pointing out the number of leaves which constitute a gamosepalous calyx. In a polysepalous calyx the number of the parts is indicated by Greek numerals prefixed; thus, a calyx which has three sepals is *trisepalous*; one with five sepals is *pentasepalous*. The sepals occasionally are of different forms and sizes. In *Aconite* one of them is shaped like a helmet (*galeate*). In a gamosepalous calyx the sepals are united in various ways, sometimes very slightly, and their number is marked by the divisions at the apex. These divisions either are simple projections in the form of acute or obtuse teeth (fig. 49); or they extend down the calyx as fissures about halfway,

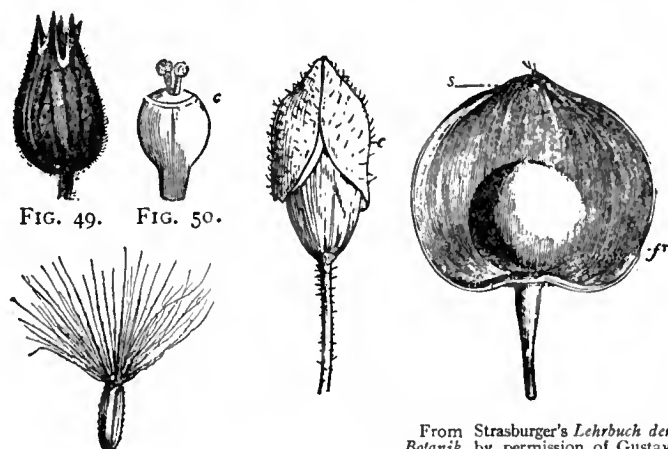

FIG. 49. FIG. 50.

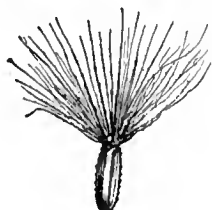

FIG. 51.

FIG. 52.

FIG. 53.

From Strasburger's *Lehrbuch der Botanik*, by permission of Gustav Fischer.

FIG. 49.—Gamosepalous five-toothed calyx of Campion (*Lychnis*).
FIG. 50.—Obsolete calyx (*c*) of Madder (*Rubia*) adherent to the pistil, in the form of a rim.

FIG. 51.—Feathery pappus attached to the fruit of Groundsel (*Senecio vulgaris*).

FIG. 52.—Caducous calyx (*c*) of Poppy. There are two sepals which fall off before the petals expand.

FIG. 53.—Fruit of *Physalis Alkekengi*, consisting of the persistent calyx (*s*), surrounding the berry (*fr*), derived from the ovary. (After Duchartre.)

the calyx being *trifid* (three-cleft), *quinquefid* (five-cleft), &c., according to their number; or they reach to near the base in the form of partitions, the calyx being *tripartite*, *quadripartite*, *quinquepartite*, &c. The union of the parts may be complete, and the calyx may be quite entire or *truncate*, as in some *Correas*, the venation being the chief indication of the different parts. The cohesion is sometimes irregular, some parts uniting to a greater extent than others; thus a two-lipped or *labiate* calyx is formed. The upper lip is often composed of three parts, which are thus posterior or next the axis, while the lower has two, which are anterior. The part formed by the union of the sepals is called the *tube* of the calyx; the portion where the sepals are free is the *limb*.

Occasionally, certain parts of the sepals undergo marked enlargement. In the violet the calycine segments are prolonged downwards beyond their insertions, and in the Indian cress (*Tropæolum*) this prolongation is in the form of a spur (*calcar*), formed by three sepals; in *Delphinium* it is formed by one. In *Pelargonium* the spur from one of the sepals is adherent to the flower-stalk. In *Potentilla* and allied genera an *epicalyx* is formed by the development of stipules from the sepals, which form an apparent outer calyx, the parts of which alternate with

the true sepals. In *Malvaceae* an epicalyx is formed by the bracteoles. Degenerations take place in the calyx, so that it becomes dry, staly and glumaceous (like the glumes of grasses), as in the rushes (*Juncaceae*); hairy, as in *Compositae*; or a mere rim, as in some *Umbelliferae* and *Acanthaceae*, and in *Madder* (*Rubia tinctorum*, fig. 50), when it is called *obsolete* or *marginate*. In *Compositae*, *Dipsacaceae* and *Valerianaceae* the calyx is attached to the pistil, and its limb is developed in the form of hairs called *pappus* (fig. 51). This pappus is either simple (*pilose*) or feathery (*plumose*). In *Valeriana* the superior calyx is at first an obsolete rim, but as the fruit ripens it is shown to consist of hairs rolled inwards, which expand so as to waft the fruit. The calyx sometimes falls off before the flower expands, as in poppies, and is *caducous* (fig. 52); or along with the corolla, as in *Ranunculus*, and is *deciduous*; or it remains after flowering (*persistent*) as in *Labiatae*, *Scrophulariaceae*, and *Boraginaceae*; or its base only is persistent, as in *Datura Stramonium*. In *Eschscholtzia* and *Eucalyptus* the sepals remain united at the upper part, and become disarticulated at the base or middle, so as to come off in the form of a lid or funnel. Such a calyx is *operculate* or *calyptrate*. The existence or non-existence of an articulation determines the deciduous or persistent nature of the calyx.

The receptacle bearing the calyx is sometimes united to the pistil, and enlarges so as to form a part of the fruit, as in the apple, pear, &c. In these fruits the withered calyx is seen at the apex. Sometimes a persistent calyx increases much after flowering, and encloses the fruit without being incorporated with it, becoming *accrescent*, as in various species of *Physalis* (fig. 53); at other times it remains in a withered or *marcescent* form, as in *Erica*; sometimes it becomes *inflated* or *vesicular*, as in sea campion (*Silene maritima*).

The corolla is the more or less coloured attractive inner floral envelope; generally the most conspicuous whorl. It is present in the greater number of Dicotyledons. Petals differ more from ordinary leaves than sepals do, and are much more nearly allied to the staminal whorl. In some cases, however, they are transformed into leaves, like the calyx, and occasionally leaf-buds are developed in their axil. They are seldom green, although occasionally that colour is met with, as in some species of *Cobaea*, *Hoya viridiflora*, *Gonolobus viridiflorus* and *Pentstemon spiralis*. As a rule they are highly coloured, the colouring matter being contained in the cell-sap, as in blue or red flowers, or in plastids (chromoplasts), as generally in yellow flowers, or in both forms, as in many orange-coloured or reddish flowers. The attractiveness of the petal is often due wholly or in part to surface markings; thus the cuticle of the petal of a pelargonium, when viewed with a $\frac{1}{4}$ or $\frac{1}{2}$ -in. object-glass, shows beautiful hexagons, the boundaries of which are ornamented with several inflected loops in the sides of the cells.

Petals are generally glabrous or smooth; but, in some instances, hairs are produced on their surface. Petaline hairs, though sparse and scattered, present occasionally the same arrangement as those which occur on the leaves; thus, in *Bombaceae* they are stellate. Coloured hairs are seen on the petals of *Menyanthes*, and on the segments of the perianth of *Iris*. They serve various purposes in the economy of the flower, often closing the way to the honey-secreting part of the flower to small insects, whose visits would be useless for purposes of pollination. Although petals are usually very thin and delicate in their texture, they occasionally become thick and fleshy, as in *Stapelia* and *Rafflesia*; or dry, as in heaths; or hard and stiff, as in *Xylopia*. A petal often consists of two portions—the lower narrow, resembling the petiole of a leaf, and called the *unguis* or *claw*; the upper broader, like the blade of a leaf, and called the *lamina* or *limb*. These parts are seen in the petals of the wallflower (fig. 54). The claw is often wanting, as in the crowfoot (fig. 55) and the poppy, and the petals are then *sessile*. According to the development of veins and the growth of cellular tissue, petals present varieties similar to those of leaves. Thus the margin is either entire or divided into lobes or teeth. These teeth sometimes form a regular fringe round the margin, and the

petal becomes *fimbriated*, as in the pink; or *lacinated*, as in *Lychnis Flos-cuculi*; or *crested*, as in *Polygala*. Sometimes the petal becomes pinnatifid, as in *Schizopetalum*. The median vein is occasionally prolonged beyond the summit of the petals in the form of a long process, as in *Strophanthus hispidus*, where it extends for 7 in.; or the prolonged extremity is folded downwards or inflexed, as in Umbelliferae, so that the apex approaches the base. The limb of the petal may be flat or concave, or hollowed like a boat. In Hellebore the petals become folded

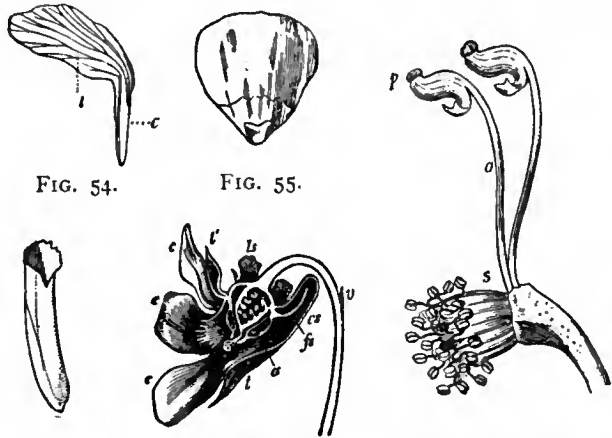

FIG. 54.

FIG. 55.

FIG. 56.

FIG. 57.

FIG. 58.

FIG. 54.—Unguiculate or clawed petal of Wallflower (*Cheiranthus Cheiri*). *c*, The claw or unguis; *l*, the blade or lamina.

FIG. 55.—Petal of Crowfoot (*Ranunculus*), without a claw, and thus resembling a sessile leaf. At the base of the petal a nectariferous scale is seen.

FIG. 56.—Tubular petal of Hellebore (*Helleborus*).

FIG. 57.—Pansy (*Viola tricolor*). Longitudinal section of flower; *v*, bracteole on the peduncle; *l*, sepals; *ls*, appendage of sepal; *c*, petals; *cs*, spur of the lower petals; *fs*, glandular appendage of the lower stamens; *a*, anthers. (After Sachs.)

(From Vines' *Students' Text-Book of Botany*, by permission of Swan Sonnenschein & Co.)

FIG. 58.—Part of the flower of Aconite (*Aconitum Napellus*), showing two irregular horn-like petals (*p*) supported on grooved stalks (*o*). These serve as nectaries. *s*, the whorl of stamens inserted on the thalamus and surrounding the pistil.

in a tubular form, resembling a horn (fig. 56); in aconite (fig. 58) some of the petals resemble a hollow-curved horn, supported on a grooved stalk; while in columbine, violet (fig. 57), snapdragon and *Centranthus*, one or all of them are prolonged in the form of a spur, and are *calcarate*. In *Valeriana*, *Antirrhinum* and *Corydalis*, the spur is very short, and the corolla or petal is said to be *gibbous*, or *saccate*, at the base. These spurs, tubes and sacs serve as receptacles for the secretion or containing of nectar.

A corolla is *dipetalous*, *tripetalous*, *tetrapetalous* or *pentapetalous* according as it has two, three, four or five separate petals. The general name of *polypetalous* is given to corollas having separate petals, while *monopetalous*, *gamopetalous* or *sympetalous* is applied to those in which the petals are united. This union generally takes place at the base, and extends more or less towards the apex; in *Phyteuma* the petals are united at their apices also. In some polypetalous corollas, as that of the vine, the petals are separate at the base and adhere by the apices. When the petals are equal as regards their development and size, the corolla is *regular*; when unequal, it is *irregular*. When a corolla is gamopetalous it usually happens that the lower portion forms a tube, while the upper parts are either free or partially united, so as to form a common limb, the point of union of the two portions being the *throat*, which often exhibits a distinct constriction or dilatation. The number of parts forming such a corolla can be determined by the divisions, whether existing as teeth, crenations, fissures or partitions, or if, as rarely happens, the corolla is entire, by the venation. The union may be equal among the parts, or some may unite more than others.

Amongst regular polypetalous corollas may be noticed the *rosaceous* corolla (fig. 59), in which there are five spreading petals, having no claws, and arranged as in the rose, strawberry and *Potentilla*; the *caryophyllaceous* corolla, in which there are five petals with long, narrow, tapering claws, as in many of the pink tribe; the *cruciform*, having four petals, often unguiculate, placed opposite in the form of a cross, as seen in wallflower, and in other plants called *cruciferous*. Of irregular polypetalous corollas the most marked is the *papilionaceous* (fig. 40), in which there are five petals:

—one superior (posterior), *st*, placed next to the axis, usually larger than the rest, called the *vexillum* or *standard*; two lateral, *a*, the *alae* or wings; two inferior (anterior), partially or completely covered by the alae, and often united slightly by their lower margins, so as to form a single keel-like piece, *car*, called *carina*, or keel, which embraces the essential organs. This form of corolla is characteristic of British leguminous plants.

Regular gamopetalous corollas are sometimes *campanulate* or *bell-shaped*, as in (*Campanula*) (fig. 60); *infundibuliform* or *funnel-shaped*, when the tube is like an inverted cone, and the limb becomes more expanded at the apex, as in tobacco; *hypocrateriform* or *salver-shaped*, when there is a straight tube surmounted by a flat spreading limb, as in primula (fig. 61); *tubular*, having a long cylindrical tube, appearing continuous with the limb, as in *Spigelia* and comfrey; *rotate* or *wheel-shaped*, when the tube is very short, and the limb flat and spreading, as in forget-me-not, *Myosotis* (when the divisions of the rotate corolla are very acute, as in *Galium*, it is sometimes called *stellate* or *star-like*); *urceolate* or *urn-shaped*, when there is scarcely any limb, and the tube is narrow at both ends, and expanded in the middle, as in bell-heath (*Erica cinerea*). Some of these forms may become irregular in consequence of certain parts being more developed than others. Thus, in *Veronica*, the rotate corolla has one division much smaller than the rest, and in foxglove (*Digitalis*) there is a slightly irregular campanulate corolla. Of irregular gamopetalous corollas there may be mentioned the *labiate* or *lipped* (fig. 62), having two divisions of the limb in the form of lips (the upper one, *u*, composed usually of two united petals, and the lower, *l*, of three), separated by a gap.

In such cases the tube varies in length, and the parts in their union follow the reverse order of what occurs in the calyx, where two sepals are united in the lower lip and three in the upper. When the upper lip of a labiate corolla is much arched, and the lips separated by a distinct gap, it is called *ringent* (fig. 62). The labiate corolla characterizes the natural order Labiatae. When the lower lip is pressed against the upper, so as to leave only a chink between them, the corolla is said to be *personate*, as in snapdragon, and some other Scrophulariaceae. In some corollas the two lips become hollowed out in a remarkable manner, as in calceolaria, assuming a slipper-like appearance, similar to what occurs in the labellum of some orchids, as *Cypripedium*. When a tubular corolla is split in such a way as to form a strap-like process on one side with several tooth-like projections at its apex, it becomes *ligulate* or *strap-shaped* (fig. 63). This corolla occurs in many composite plants, as in the florets of dandelion, daisy and chicory. The number of divisions at the apex indicates the number of united petals, some of which, however, may be



FIG. 59.—Rosaceous corolla (*c*) of the Strawberry (*Fragaria vesca*), composed of five petals without claws.



From Strasburger's *Lehrbuch der Botanik*, by permission of Gustav Fischer.

FIG. 60.—Flower of *Campanula medium*; *d*, bract; *v*, bracteoles.

abortive. Occasionally some of the petals become more united than others, and then the corolla assumes a *bilabiate* or *two-lipped* form, as seen in the division of Compositae called Labiatiflorae.

Petals are sometimes suppressed, and sometimes the whole corolla is absent. In *Amorpha* and *Azalia* the corolla is reduced to a single petal, and in some other Leguminous plants it is entirely wanting. In the natural order Ranunculaceae, some genera, such as *Ranunculus*, globe-flower and paony, have both calyx and corolla, while others, such as clematis, anemone and *Caltha*, have only a coloured calyx. Flowers become double by the multiplication of the parts of the corolline whorl; this arises in general from a metamorphosis of the stamens.

Certain structures occur on the petals of some flowers, which received in former days the name of *nectaries*. The term nectary

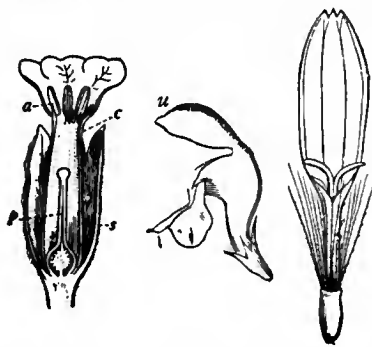

FIG. 61. FIG. 62. FIG. 63.

FIG. 61.—Flower of cowslip (*Primula veris*) cut vertically. *s*, Sepals joined to form a gamosepalous calyx; *c*, corolla consisting of tube and spreading limb; *a*, stamens springing from the mouth of the tube; *p*, pistil.

FIG. 62.—Irregular gamopetalous labiate corolla of the Dead-nettle (*Lamium album*). The upper lip *u* is composed of two petals united, the lower lip (*l*) of three. Between the two lips there is a gap. The throat is the part where the tube and the labiate limb join. From the arching of the upper lip this corolla is called ringent.

FIG. 63.—Irregular gamopetalous ligulate flower of Ragwort (*Senecio*). It is a tubular floret, split down on one side, with the united petals forming a straplike projection. The lines on the flat portion indicate the divisions of the five petals. From the tubular portion below, the bifid style projects slightly.

or *deduplication*. Of this nature are the scales on the petals in *Lychnis*, *Silene* and *Cynoglossum*, which are formed in the same way as the ligules of grasses. In other cases, as in *Samolus*, the scales are alternate with the petals, and may represent altered stamens. In *Narcissus* the appendages are united to form a crown, consisting of a membrane similar to that which unites the stamens in *Pancreatium*. It is sometimes difficult to say whether these structures are to be referred to the corolline or to the staminal row.

Petals are attached to the axis usually by a narrow base. When this attachment takes place by an articulation, the petals fall off either immediately after expansion (*caducous*) or after fertilization (*deciduous*). A corolla which is continuous with the axis and not articulated to it, as in campanula and heaths, may be persistent, and remain in a withered or marcescent state while the fruit is ripening. A gamopetalous corolla falls off in one piece; but sometimes the base of the corolla remains persistent, as in *Rhinanthus* and *Orobanche*.

The *stamens* and the *pistil* are sometimes spoken of as the essential organs of the flower, as the presence of both is required in order that perfect seed may be produced. As with few exceptions the stamen represents a leaf which has been specially developed to bear the pollen or microspores, it is spoken of in comparative morphology as a microsporophyll; similarly the

was very vaguely applied by Linnaeus to any part of the flower which presented an unusual aspect, as the crown (*corona*) of narcissus, the fringes of the Passion-flower, &c. If the name is retained it ought properly to include only those parts which secrete a honey-like substance, as the glandular depression at the base of the perianth of the fritillary, or on the petal of *Ranunculus* (fig. 55), or on the stamens of Rutaceae. The honey secreted by flowers attracts insects, which, by conveying the pollen to the stigma, effect fertilization. The horn-like nectaries under the galeate sepal of aconite (fig. 58) are modified petals, so also are the tubular nectaries of heliobore (fig. 56). Other modifications of some part of the flower, especially of the corolla and stamens, are produced either by degeneration or outgrowth, or by *chorisis*,

carpels which make up the pistil are the megasporophylls (see ANGIOSPERMS). *Hermaphrodite* or *bisexual* flowers are those in which both these organs are found; *unisexual* or *diclinous* are those in which only one of these organs appears,—those bearing stamens only, being *staminiferous* or “male”; those having the pistil only, *pistilliferous* or “female.” But even in plants with hermaphrodite flowers self-fertilization is often provided against by the structure of the parts or by the period of ripening of the organs. For instance, in *Primula* and *Linum* some flowers have long stamens and a pistil with a short style, the others having short stamens and a pistil with a long style. The former occur in the so-called thrum-eyed primroses (fig. 61), the latter in the “pin-eyed.” Such plants are called *dimorphic*. Other plants are *trimorphic*, as species of *Lythrum*, and proper fertilization is only effected by combination of parts of equal length. In some plants the stamens are perfected before the pistil; these are called *proterandrous*, as in *Ranunculus repens*, *Silene maritima*, *Zea Mays*. In other plants, but more rarely, the pistil is perfected before the stamens, as in *Potentilla argentea*, *Plantago major*, *Coix Lachryma*, and they are termed *proterogynous*. Plants in which proterandry or proterogyny occurs are called *dichogamous*. When in the same plant there are unisexual flowers, both male and female, the plant is said to be *monoecious*, as in the hazel and castor-oil plant. When the male and female flowers of a species are found on separate plants, the term *dioecious* is applied, as in *Mercurialis* and hemp; and when a species has male, female and hermaphrodite flowers on the same or different plants, as in *Parietaria*, it is *polygamous*.

The stamens arise from the thalamus or torus within the petals, with which they generally alternate, forming one or more whorls, which collectively constitute the *androecium*. *Stamens*. Their normal position is below the pistil, and when they are so placed (fig. 64, *a*) upon the thalamus they are *hypogynous*. Sometimes they become adherent to the petals, or are *epipetalous*, and the insertion of both is looked upon as similar, so that they are still hypogynous, provided they are independent of the calyx and the pistil. In other cases they are perigynous or epigynous (fig. 65). Numerous intermediate forms occur, especially amongst Saxifragaceae, where the parts are *half superior* or *half inferior*. Where the stamens become adherent to the pistil so as to form a column, the flowers are said to be *gynandrous*, as in *Aristolochia* (fig. 66). These arrangements of parts are of great importance in classification. The stamens vary in number from one to many hundreds. In acyclic flowers there is often a gradual transition from petals to stamens, as in the white water-lily (fig. 31). When flowers become double by cultivation, the stamens are converted into petals, as in the paony, camellia, rose, &c. When there is only one whorl the stamens are usually equal in number to the sepals or petals, and alternate with the latter. The flower is then *isostemonous*. When the stamens are not equal in number to the sepals or petals, the flower is *anisostemonous*. When there is more than one whorl of stamens, then the parts of each successive whorl alternate with those of the whorl preceding it. The staminal row is more liable to multiplication of parts than the outer whorls. A flower with a single row of stamens is *haplostemonous*. If the stamens are double the sepals or petals as regards number, the flower is *diplostemonous*; if more than double, *polystemonous*. The additional rows of



From Strasburger's *Lehrbuch der Botanik*, by permission of Gustav Fischer.

FIG. 64.—Flower of *Paeonia peregrina*, in longitudinal section. *k*, Sepal; *e*, petal; *a*, stamens; *g*, pistil. (½ nat. sizc.)

When there is only one whorl the stamens are usually equal in number to the sepals or petals, and alternate with the latter. The flower is then *isostemonous*. When the stamens are not equal in number to the sepals or petals, the flower is *anisostemonous*. When there is more than one whorl of stamens, then the parts of each successive whorl alternate with those of the whorl preceding it. The staminal row is more liable to multiplication of parts than the outer whorls. A flower with a single row of stamens is *haplostemonous*. If the stamens are double the sepals or petals as regards number, the flower is *diplostemonous*; if more than double, *polystemonous*. The additional rows of

stamens may be developed in the usual centripetal (acropetal) order, as in Rhamnaceae; or they may be interposed between the pre-existing ones or be placed outside them, *i.e.* develop centrifugally (basipetally), as in geranium and oxalis, when the flower is said to be *obdiplostemonous*. When the stamens are fewer than twenty they are said to be *definite*; when above twenty they are *indefinite*, and are represented by the symbol ∞ . The number of stamens is indicated by the Greek numerals prefixed to the term *androus*; thus a flower with one stamen is *monandrous*, with two, three, four, five, six or many stamens, di-, tri-, tet-, pent-, hex- or polyandrous, respectively.

The function of the stamen is the development and distribution of the pollen. The stamen usually consists of two parts, a contracted portion, often thread-like, termed the *filament* (fig. 25 *f*), and a broader portion, usually of two lobes, termed the *anther* (*a*), containing the powdery *pollen* (*p*), and supported upon the end of the filament. That portion of the filament in contact with the anther-lobes is termed the *connective*. If the

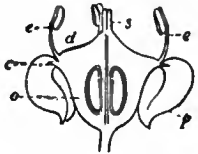

FIG. 65.—Flower of *Aralia* in vertical section. *c*, Calyx; *p*, petal; *e*, stamen; *s*, stigmas. The calyx, petals and stamens spring from above the ovary (*o*) in which two chambers are shown each with a pendulous ovule; *d*, disc between the stamens and stigmas.

anther is absent the stamen is abortive, and cannot perform its functions. The anther is developed before the filament, and when the latter is not produced, the anther is sessile, as in the mistletoe.

The filament is usually, as its name imports, filiform or thread-like, and cylindrical, or slightly tapering towards its summit. It is often, however, thickened, compressed and flattened in various ways, becoming *petaloid* in *Canna*, *Marantia*, water-lily (fig. 32); *subulate* or slightly broadened at the base and drawn out into a point like an awl, as in *Butomus umbellatus*; or *clavate*, that is, narrow below and broad above, as in *Thalictrum*. In some instances, as in *Tamarix gallica*, *Peganum Harmala*, and *Campanula*, the base of the filament is much dilated, and ends suddenly in a narrow thread-like portion. In these cases the base may give off lateral stipulary processes, as in *Allium* and *Alyssum calycinum*. The filament varies much in length and in firmness. The length sometimes bears a relation to that of the pistil, and to the position of the flower, whether erect or drooping. The filament is usually of sufficient solidity to support the anther in an erect position; but sometimes, as in grasses, and other wind-pollinated flowers, it is very delicate and hair-like, so that the anther is pendulous (fig. 105). The filament is generally continuous from one end to the other, but in some cases it is bent or jointed, becoming *geniculate*; at other times, as in the pellitory, it is spiral. It is colourless, or of different colours. Thus in fuchsia and *Poinciana*, it is red; in *Adamia* and *Tradescantia virginica*, blue; in *Oenothera* and *Ranunculus acris*, yellow.

Hairs, scales, teeth or processes of different kinds are some-

times developed on the filament. In spiderwort (*Tradescantia virginica*) the hairs are beautifully coloured, moniliform or necklace-like, and afford good objects for studying rotation of the protoplasm. Filaments are usually articulated to the thalamus or torus, and the stamens fall off after fertilization; but in *Campanula* and some other plants they are continuous with the torus, and the stamens remain persistent, although in a withered state. Changes are produced in the whorl of stamens by cohesion of the filaments to a greater or less extent, while the anthers remain free; thus, all the filaments of the androecium may unite, forming a tube round the pistil, or a central bundle when the pistil is abortive, the stamens becoming *monadelphous*, as occurs in plants of the Mallow tribe; or they may be arranged in two bundles, the stamens being *diadelphous*, as in *Polygala*, *Fumaria* and Pea; in this case the bundles may be equal or unequal. It frequently happens, especially in Papilionaceous flowers, that out of ten stamens nine are united by their filaments, while one (the posterior one) is free (fig. 68). When there are three or more bundles

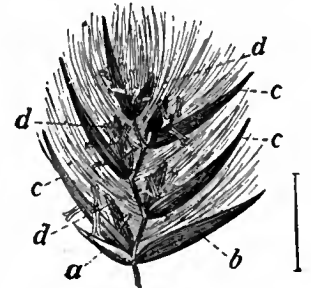
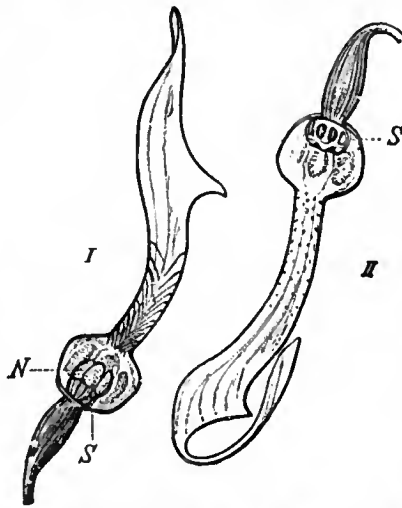

FIG. 67.—Spikelet of Reed (*Phragmites communis*) opened out. *a*, *b*, Barren glumes; *c*, fertile glumes, each enclosing one flower with its pale; *d*, the zig-zag axis (*rachilla*) bears long silky hairs.

the stamens are *triadelphous*, as in *Hypericum aegyptiacum*, or *polyadelphous*, as in *Ricinus communis* (castor-oil). In some cases, as in papilionaceous flowers, the stamens cohere, having been originally separate, but in most cases each bundle is produced by the branching of a single stamen. When there are three stamens in a bundle we may conceive the lateral ones as of a stipulary nature. In Lauraceae there are perfect stamens, each having at the base of the filament two abortive stamens or staminodes, which may be analogous to stipules. Filaments sometimes are adherent to the pistil, forming a column (*gynostemium*), as in *Stylidium*, Asclepiadaceae, *Rafflesia*, and Aristolochiaceae (fig. 66); the flowers are then termed *gynandrous*.



From Strasburger's *Lehrbuch der Botanik*, by permission of Gustav Fischer.

FIG. 66.—Flowers of *Aristolochia Clematidis* cut through longitudinally. I. Young flower in which the stigma (*N*) is receptive and the stamens (*S*) have not yet opened; II. Older flower with the stamens (*S*) opened, the stigma withered, and the hairs on the corolla dried up. (X2.)

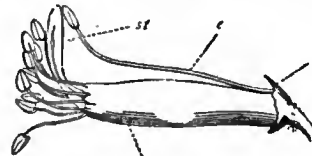

FIG. 68.

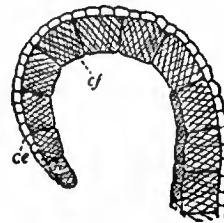

FIG. 69.

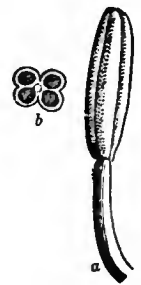

FIG. 70.

FIG. 68.—Stamens and pistil of Sweet Pea (*Lathyrus*). The stamens are diadelphous, nine of them being united by their filaments (*f*), while one of them (*e*) is free; *st*, stigma; *c*, calyx.

FIG. 69.—Portion of wall of anther of Wallflower (*Cheiranthus*). *ce*, Exothecium; *cf*, endothecium; highly magnified.

FIG. 70.—Quadrilocular or tetralothecal anther of the flowering Rush (*Butomus umbellatus*). The anther entire (*a*) with its filament; section of anther (*b*) showing the four loculi.

The *anther* consists of lobes containing the minute powdery pollen grains, which, when mature, are discharged by a fissure or opening of some sort. There is a double covering of the anther—the outer, or *exothecium*, resembles the epidermis, and often presents stomata and projections of different kinds (fig. 69); the inner, or *endothecium*, is formed by a layer or layers of cellular tissue (fig. 69, *cf*), the cells of which

The anther.

have a spiral, annular, or reticulated thickening of the wall. The endothecium varies in thickness, generally becoming thinner towards the part where the anther opens, and there disappears entirely. The walls of the cells are frequently absorbed, so that when the anther attains maturity the fibres are alone left, and these by their elasticity assist in discharging the pollen. The anther is developed before the filament, and is always sessile in the first instance, and sometimes continues so. It appears at first as a simple cellular papilla of meristem, upon which an indication of two lobes soon appears. Upon these projections the rudiments of the pollen-sacs are then seen, usually four in number, two on each lobe. In each a differentiation takes place in the layers beneath the epidermis, by which an outer layer of small-celled tissue surrounds an inner portion of large cells. Those central cells are the mother-cells of the pollen, whilst the small-celled layer of tissue external to them becomes the endothecium, the exothecium being formed from the epidermal layer.

In the young state there are usually four pollen-sacs, two for each anther-lobe, and when these remain permanently complete it is a *quadrilocular* or *tetralothecal* anther (fig. 70). Sometimes, however, only two cavities remain in the anther, by union of the sacs in each lobe, in which case the anther is said to be *bilocular* or *dithecal*. Sometimes the anther has a single cavity, and becomes *unilocular*, or *monothecal*, or *dimidiate*, either by the disappearance of the partition between the two lobes, or by the abortion of one of its lobes, as in *Styphelia laeta* and *Althaea officinalis* (hollyhock). Occasionally there are numerous cavities in the anther, as in *Viscum* and *Rafflesia*. The form of the anther-lobes varies. They are generally of a more or less oval or elliptical form, or they may be globular, as in *Mercurialis annua*; at other times linear or clavate, curved, flexuose, or sinuose, as in bryony and gourd. According to the amount of union of the lobes and the unequal development of different parts of their surface an infinite variety of forms is produced. That part of the anther to which the filament is attached is the *back*, the opposite being the *face*. The division between the lobes is marked on the face of the anther by a groove or *furrow*, and there is usually on the face a *suture*, indicating the line of dehiscence. The suture is often towards one side in consequence of the valves being unequal. The stamens may cohere by their anthers, and become *syngenesious*, as in composite flowers, and in lobelia, jasione, &c.

The anther-lobes are united to the *connective*, which is either continuous with the filament or articulated with it. When the filament is continuous with the connective, and is prolonged so that the anther-lobes appear to be united to it throughout their whole length, and lie in apposition to it and on both sides of it, the anther is said to be *adnate* or *adherent*; when the filament ends at the base of the anther, then the latter is *innate* or *erect*. In these cases the anther is to a greater or less degree fixed. When, however, the attachment is very narrow, and an articulation exists, the anthers are movable (*versatile*) and are easily turned by the wind, as in *Tritonia*, grasses (fig. 105), &c., where the filament is attached only to the middle of the connective. The connective may unite the anther-lobes completely or only partially. It is sometimes very short and is reduced to a mere point, so that the lobes are separate or free. At other times it is prolonged upwards beyond the lobes, assuming various forms, as in *Acalypha* and oleander; or it is extended backwards and downwards, as in violet (fig. 71), forming a nectar-secreting spur. In *Salvia officinalis* the connective is attached to the filament in a horizontal manner, so as to separate the two anther-lobes (fig. 72), one only of which contains pollen, the other being imperfectly developed and sterile. The connective is joined to the filament by a movable joint forming a lever which plays an important part in the pollination-mechanism. In *Stachys* the connective is expanded laterally, so as to unite the bases of the anther-lobes and bring them into a horizontal line.

The opening or *dehiscence* of the anthers to discharge their contents takes place either by clefts, by valves, or by pores. When the anther-lobes are erect, the cleft is lengthwise along the

line of the suture—*longitudinal dehiscence* (fig. 25). At other times the slit is horizontal, from the connective to the side, as in *Alchemilla arvensis* (fig. 73) and in *Lemna*; ^{Anther-} ~~dehiscence.~~ the dehiscence is then *transverse*. When the anther-lobes are rendered horizontal by the enlargement of the connective, then what is really longitudinal dehiscence may appear to be transverse. The cleft does not always proceed the whole

length of the anther-lobe at once, but often for a time it extends only partially. In other instances the opening is confined to the base or apex, each loculation opening by a single pore, as in *Pyrola*, *Tetralotheca juncea*, *Rhododendron*, *Vaccinium* and *Solanum* (fig. 74), where there are two, and *Poranthera*, where there are four; whilst in the mistletoe the anther has numerous pores for the discharge of the pollen. Another mode of dehiscence is the valvular, as in the barberry (fig. 75), where each lobe opens by a valve on the outer side of the suture, separately rolling up from base to apex; in some of the laurel tribe there are two such valves for each lobe, or four in all. In some Guttiferae, as *Hebradendron cambogioides* (the Ceylon gamboge plant), the anther opens by a lid separating from the apex (*circumscissile* dehiscence).

The anthers dehiscence at different periods during the process of flowering; sometimes in the bud, but more commonly when the pistil is fully developed and the flower is expanded. They either dehiscence simultaneously or in succession. In the latter case individual stamens may move in succession towards the pistil and discharge their contents, as in *Parnassia palustris*, or the outer or the inner stamens may first dehiscence, following thus a centripetal or centrifugal order. These variations are intimately connected with the arrangements for transference of pollen. The anthers are called *introrse* when they dehiscence by the surface next to the centre of the flower; they are *extrorse* when they dehiscence by the outer surface; when they dehiscence by the sides, as in *Iris* and some grasses, they are *laterally* dehiscence. Sometimes, from their versatile nature, anthers originally introrse become extrorse, as in the Passion-flower and *Oxalis*.

The usual colour of anthers is yellow, but they present a great variety in this respect. They are red in the peach, dark purple in the poppy and tulip, orange in *Eschscholtzia*, &c. The colour and appearance of the anthers often change after they have discharged their functions.

Stamens occasionally become sterile by the degeneration or non-development of the anthers, when they are known as *staminodia*, or rudimentary stamens. In *Scrophularia* the fifth stamen appears in the form of a scale; and in many Pentstemons it is reduced to a filament with hairs or a shrivelled membrane at the apex. In other cases, as in double flowers, the stamens are converted into petals; this is also probably the case with such

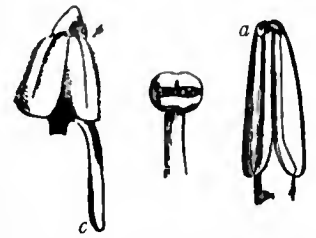

FIG. 71. FIG. 73. FIG. 74.



FIG. 72. FIG. 75.

FIG. 71.—Two stamens of Pansy (*Viola tricolor*), with their two anther-lobes and the connectives (*b*) extending beyond them. One of the stamens has been deprived of its spur, the other shows its spur *c*.

FIG. 72.—Anther of *Salvia officinalis*. *lf*, fertile lobe full of pollen; *ls*, barren lobe without pollen; *c*, connective; *f*, filament.

FIG. 73.—Stamen of Lady's Mantle (*Alchemilla*), with the anther opening transversely.

FIG. 74.—Stamen of a species of Nightshade (*Solanum*), showing the divergence of the anther-lobes at the base, and the dehiscence by pores at the apex.

FIG. 75.—The stamen of the Barberry (*Berberis vulgaris*), showing one of the valves of the anther (*v*) curved upwards, bearing the pollen on its inner surface.

plants as *Mesembryanthemum*, where there is a multiplication of petals in several rows. Sometimes, as in *Canna*, one of the anther-lobes becomes abortive, and a petaloid appendage is produced. Stamens vary in length as regards the corolla. Some are enclosed within the tube of the flower, as in *Cinchona* (included); others are *exserted*, or extend beyond the flower, as in *Littorella* or *Plantago*. Sometimes the stamens in the early state of the flower project beyond the petals, and in the progress of growth become included, as in *Geranium striatum*. Stamens also vary in their relative lengths. When there is more than one row or whorl in a flower, those on the outside are sometimes longest, as in many Rosaceae; at other times those in the interior are longest, as in *Luhea*. When the stamens are in two rows, those opposite the petals are usually shorter than those which alternate with the petals. It sometimes happens that a single

stamen is longer than all the rest. A definite relation, as regards number, sometimes exists between the long and the short stamens. Thus, in some flowers the stamens are *didynamous*, having only four out of five stamens developed, and the two corresponding to the upper part of the flower longer than the two lateral ones. This occurs in Labiatae and Scrophulariaceae (fig. 76). Again, in other cases there are six stamens, whereof four long ones are arranged in pairs opposite to each other, and alternate

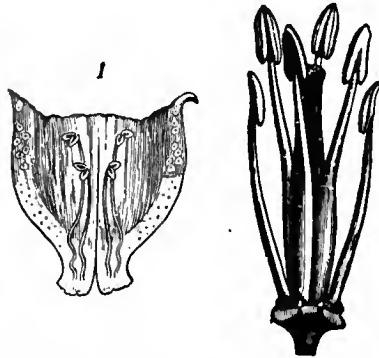

FIG. 76.—Corolla of foxglove (*Digitalis purpurea*), cut in order to show the didynamous stamens (two long and two short) which are attached to it.

From Strasburger's *Lehrbuch der Botanik*, by permission of Gustav Fischer.

FIG. 77.—Tetradynamous stamens (four long and two short) of wallflower (*Cheiranthus Cheiri*).

with two isolated short ones (fig. 77), giving rise to *tetradynamous* flowers, as in Cruciferae. Stamens, as regards their direction, may be erect, turned inwards, outwards, or to one side. In the last-mentioned case they are called *declinate*, as in amaryllis, horse-chestnut and fraxinella.

The pollen-grains or microspores contained in the anther consist of small cells, which are developed in the large thick-walled mother-cells formed in the interior of the pollen-sacs (microsporangia) of the young anther. These mother-cells are either separated from one another and float in the granular fluid which fills up the cavity of the pollen-sac, or are not so isolated. A division takes place, by which four cells are formed in each, the exact mode of division differing in dicotyledons and monocotyledons. These cells are the pollen-grains. They increase in size and acquire a cell-wall, which becomes differentiated into an outer cuticular layer, or *exine*, and an inner layer, or *intine*. Then the walls of the mother-cells are absorbed, and the pollen-grains float freely in the fluid of the pollen-sacs, which gradually disappears, and the mature grains form a powdery mass within the anther. They then either remain united in fours, or multiples of four, as in some acacias, *Periploca graeca* and *Inga anomala*, or separate into individual grains, which by degrees become mature pollen. Occasionally the membrane of the mother-cell is not completely absorbed, and traces of it are detected in a viscid matter surrounding the pollen-grains, as in Onagraceae. In orchidaceous plants the pollen-grains are united into masses, or *pollinia* (fig. 78), by means of viscid matter. In orchids each of the pollen-masses has a prolongation or stalk (*caudicle*) which adheres to a prolongation at the base of the anther (*rostellum*) by means of a viscid gland (*retinaculum*) which is either naked or covered. The term *clinandrium* is sometimes applied to the part of the column in orchids where the stamens are situated. In some orchids, as *Cypripedium*, the pollen has its ordinary character of separate grains. The number of pollinia varies;

thus, in *Orchis* there are usually two, in *Calleya* four, and in *Laelia* eight. The two pollinia in *Orchis Morio* contain each about 200 secondary smaller masses. These small masses, when bruised, divide into grains which are united in fours. In Asclepiadaceae the pollinia are usually united in pairs (fig. 79), belonging to two contiguous anther-lobes—each pollen-mass having a

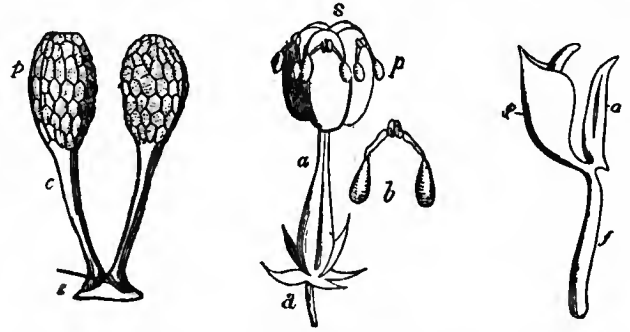

FIG. 78.

FIG. 79.

FIG. 80.

FIG. 78.—Pollinia, or pollen-masses, with their retinacula (g) or viscid matter attaching them at the base. The pollen masses (p) are supported on stalks or caudicles (c). These masses are easily detached by the agency of insects. Much enlarged.

FIG. 79.—Pistil of *Asclepias* (a) with pollen-masses (p) adhering to the stigma (s). b, pollen-masses, removed from the stigma, united by a gland-like body. Enlarged.

FIG. 80.—Stamen of *Asclepias*, showing filament f, anther a, and appendages p. Enlarged.

caudicular appendage, ending in a common gland, by means of which they are attached to a process of the stigma. The pollinia are also provided with an appendicular staminal covering (fig. 80). The extine is a firm membrane, which defines the figure of the pollen-grain, and gives colour to it. It is either smooth, or covered with numerous projections (fig. 81), granules, points or crested reticulations. The colour is generally yellow, and the surface is often covered with a viscid or oily matter. The intine is uniform in different kinds of pollen, thin and transparent, and possesses great power of extension. In some aquatics, as *Zostera*, *Zannichellia*, *Naias*, &c., only one covering exists.



FIG. 81.—Pollen of Hollyhock (*Althaea rosea*), highly magnified.

Pollen-grains vary from $\frac{3}{100}$ to $\frac{7}{100}$ of an inch or less in diameter. Their forms are various. The most common form of grain is ellipsoidal, more or less narrow at the extremities, which are called its *poles*, in contradistinction to a line equidistant from the extremities, which is its equator. Pollen-grains are also spherical; cylindrical and curved, as in *Tradescantia virginica*;

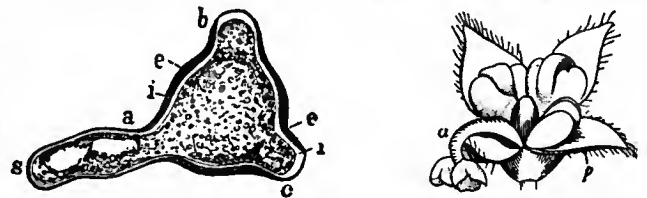

From Vines' *Students' Text-Book of Botany*, by permission of Swan Sonnenschein & Co.

FIG. 82.—Germinating pollen-grain of *Epilobium* (highly mag.) bearing a pollen-tube s; e, exine; i, intine; abc, the three spots where the exine is thicker in anticipation of the formation of the pollen-tube developed in this case at a.

FIG. 83.—Male flower of *Parietaria officinalis*, having four stamens with incurved elastic filaments, and an abortive pistil in the centre. When the perianth (p) expands, the filaments are thrown out with force as at a, so as to scatter the pollen.

polyhedral in Dipsacaceae and Compositae; nearly triangular in section in Proteaceae and Onagraceae (fig. 82). The surface of the pollen-grain is either uniform and homogeneous, or it is marked by folds formed by thinnings of the membrane. There are also rounded portions of the membrane or pores visible in the pollen-grain; these vary in number from one to fifty, and through one

or more of them the pollen-tube is extended in germination of the spore. In Monocotyledons, as in grasses, there is often only one, while in Dicotyledons they number from three upwards; when numerous, the pores are either scattered irregularly, or in a regular order, frequently forming a circle round the equatorial surface. Sometimes at the place where they exist, the outer membrane, in place of being thin and transparent, is separated in the form of a lid, thus becoming *operculate*, as in the passion-flower and gourd. Within the pollen-grain is the granular protoplasm with some oily particles, and occasionally starch. Before leaving the pollen-sac a division takes place in the pollen-grain into a vegetative cell or cells, from which the tube is developed, and a generative cell, which ultimately divides to form the male cells (see ANGIOSPERMS and GYMNASPERMS).

When the pollen-grains are ripe, the anther dehisces and the pollen is shed. In order that fertilization may be effected the pollen must be conveyed to the stigma of the pistil.

Pollination. This process, termed *pollination* (see POLLINATION), is promoted in various ways,—the whole form and structure of the flower having relation to the process. In some plants, as *Kalmia* and *Pellitory* (fig. 83), the mere elasticity of the filaments is sufficient to effect this; in other plants pollination is effected by the wind, as in most of our forest trees, grasses, &c., and in such cases enormous quantities of pollen are produced. These plants are *anemophilous*. But the common agents for pollination are insects. To allure and attract them to visit the flower the odoriferous secretions and gay colours are developed, and the position and complicated structure of the parts of the flower are adapted to the perfect performance of the process. It is comparatively rare in hermaphrodite flowers for self-fertilization to occur, and the various forms of dichogamy, dimorphism and trimorphism are fitted to prevent this.

Under the term *disk* is included every structure intervening between the stamens and the pistil. It was to such structures that the name of *nectary* was applied by old authors.

Disk. It presents great varieties of form, such as a ring, scales, glands, hairs, petaloid appendages, &c., and in the progress of growth it often contains saccharine matter, thus becoming truly nectariferous. The disk is frequently formed by degeneration or transformation of the staminal row. It may consist of processes rising from the torus, alternating with the stamens, and thus representing an abortive whorl; or its parts may be opposite to the stamens. In some flowers, as *Jatropha Curcas*, in which the stamens are not developed, their place is occupied by glandular bodies forming the disk. In Gesneriaceae and Cruciferae the disk consists of tooth-like scales at the base of the stamens. The parts composing the disk sometimes unite and form a glandular ring, as in the orange; or they form a dark-red lamina covering the pistil, as in *Paeonia Moutan* (fig. 84); or a waxy lining of the hollow receptacle, as in the rose; or a swelling at the top of the ovary, as in Umbelliferae, in which the disk is said to be epigynous. The enlarged torus covering the ovary in *Nymphaea*

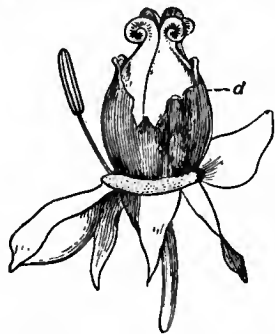

FIG. 84.—Flower of Tree Paeony (*Paeonia Moutan*), as in the rose; or a swelling at the top of the ovary, as in Umbelliferae, in which the disk is said to be epigynous. The enlarged torus covering the ovary in *Nymphaea* (*Castalia*) and *Nelumbium* may be regarded as a form of disk.

The pistil or *gynoecium* occupies the centre or apex of the flower, and is surrounded by the stamens and floral envelopes

The pistil. when these are present. It constitutes the innermost whorl, which after flowering is changed into the fruit and contains the seeds. It consists essentially of two parts, a basal portion forming a chamber, the *ovary*, containing the ovules attached to a part called the *placenta*, and an upper receptive portion, the *stigma*, which is either seated on the ovary (*sessile*), as in the tulip and poppy, or is elevated on a stalk called the *style*, interposed between the ovary and stigma. The pistil

consists of one or more modified leaves, the *carpels* (or *megasporophylls*). When a pistil consists of a single carpel it is *simple* or *monocarpellary* (fig. 85). When it is composed of several carpels, more or less united, it is *compound* or *polycarpellary* (fig. 86). In the first-mentioned case the terms *carpel* and *pistil* are synonymous. Each carpel has its own ovary, style (when present), and stigma, and may be regarded as formed by a folded leaf, the upper surface of which is turned inwards towards the axis, and the lower outwards, while from its margins are developed one or more *ovules*. This comparison is borne out by an examination of the flower of the double-flowering cherry. In it no fruit is produced, and the pistil consists merely of sessile leaves, the limb of each being green and folded, with a narrow prolongation upwards, as if from the midrib, and ending in a thickened portion. In *Cycas* the carpels are ordinary leaves, with ovules upon their margin.

A pistil is usually formed by more than one carpel. The carpels may be arranged either at the same or nearly the same height

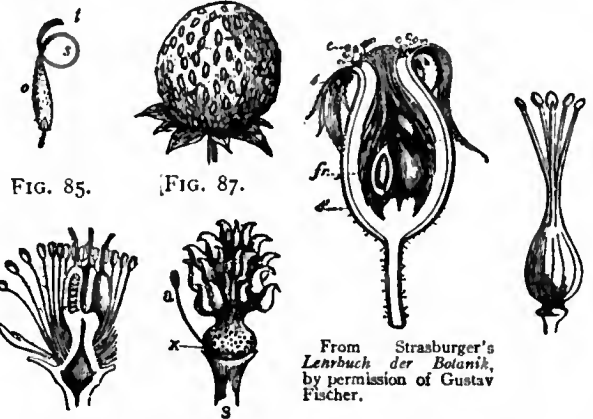

FIG. 85.—Pistil of Broom (*Cytisus*) consisting of ovary *o*, style *s*, and stigma *t*. It is formed by a single carpel.

FIG. 86.—Vertical section of the flower of Black Hellebore (*Helleborus niger*). The pistil is apocarpous, consisting of several distinct carpels, each with ovary, style and stigma. The stamens are indefinite, and are inserted below the pistil (hypogynous).

FIG. 87.—Fruit of the Strawberry (*Fragaria vesca*), consisting of an enlarged succulent receptacle, bearing on its surface the small dry seed-like fruits (achenes).

FIG. 88.—Fruit of *Rosa alba*, consisting of the fleshy hollowed axis *s'*, the persistent sepals *s*, and the carpels *fr*. The stamens (*c*) have withered. (After Duchartre.)

FIG. 89.—Pistil of *Ranunculus*. *x*, Receptacle with the points of insertion of the stamens *a*, most of which have been removed.

FIG. 90.—Syncarpous Pistil of Flax (*Linum*), consisting of five carpels, united by their ovaries, while their styles and stigmas are separate.

in a verticil, or at different heights in a spiral cycle. When they remain separate and distinct, thus showing at once the composition of the pistil, as in *Caltha*, *Ranunculus*, hellebore (fig. 86), and *Spiraea*, the term *apocarpous* is applied. Thus, in *Sedum* (fig. 22) the pistil consists of five verticillate carpels *o*, alternating with the stamens *e*. In magnolia and *Ranunculus* (fig. 89) the separate carpels are numerous and are arranged in a spiral cycle upon an elongated axis or receptacle. In the raspberry the carpels are on a conical receptacle; in the strawberry, on a swollen succulent one (fig. 87); and in the rose (fig. 88), on a hollow one. When the carpels are united, as in the pear, arbutus and chickweed, the pistil becomes *syncarpous*. The number of carpels in a pistil is indicated by the Greek numeral. A flower with a simple pistil is *monogynous*; with two carpels, *digynous*; with three carpels, *trigynous*, &c.

The union in a syncarpous pistil is not always complete; it may take place by the ovaries alone, while the styles and stigmas remain free (fig. 90), and in this case, when the ovaries form apparently a single body, the organ receives the name of *compound ovary*; or the union may take place by the ovaries and styles while the stigmas are disunited; or by the stigmas

and the summit of the style only. Various intermediate states exist, such as partial union of the ovaries, as in the rue, where they coalesce at their base; and partial union of the styles, as in Malvaceae. The union is usually most complete at the base; but in Labiatae the styles are united throughout their length, and in Apocynaceae and Asclepiadaceae the stigmas only. When the union is incomplete, the number of the parts of a compound pistil may be determined by the number of styles and stigmas; when complete, the external venation, the grooves on the surface, and the internal divisions of the ovary indicate the number.

The ovules are attached to the *placenta*, which consists of a mass of cellular tissue, through which the nourishing vessels pass to the ovule. The placenta is usually formed on the edges of the carpellary leaf (fig. 91)—*marginal*.

In many cases, however, the placentas are formations from the axis (*axile*), and are not connected with the carpellary leaves. In marginal placentation the part of the carpel bearing

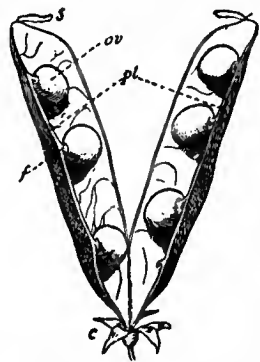

FIG. 91.—Pistil of Pea after fertilization of the ovules, developing to form the fruit. *f*, Funicle or stalk of ovule (*ov*); *pl*, placenta; *s*, withered style and stigma; *c*, persistent calyx.

the placenta is the *inner* or *ventral suture*, corresponding to the margin of the folded carpellary leaf, while the *outer* or *dorsal suture* corresponds to the midrib of the carpellary leaf. As the placenta is formed on each margin of the carpel it is essentially double. This is seen in cases where the margins of the carpel do not unite, but remain separate, and consequently two placentas are formed in place of one. When the pistil is formed by one carpel the inner margins unite and form usually a common marginal placenta, which may extend along the whole margin of the ovary as far as the base of the style (fig. 91), or may be confined to the base or apex only. When the pistil consists of several separate carpels, or is apocarpous, there are generally separate placentas at each of their margins. In a syncarpous pistil, on the other hand, the carpels are so united that the edges of each of the contiguous ones, by their union, form a *septum* or *dissepiment*, and the number of these septa consequently indicates the number of carpels in the compound pistil (fig. 92). When the

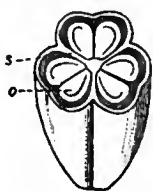

FIG. 92.

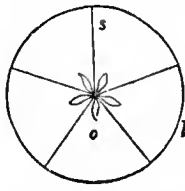

FIG. 93.



FIG. 94.

FIG. 92.—Trilobed ovary of the Lily (*Lilium*), cut transversely. *s*, Septum; *o*, ovules, which form a double row in the inner angle of each chamber. Enlarged.

FIG. 93.—Diagrammatic section of a quinquelocular ovary, composed of five carpels, the edges of which are folded inwards, and meet in the centre forming the septa, *s*. The ovules (*o*) are attached to a central placenta, formed by the union of the five ventral sutures. Dorsal suture, *l*.

FIG. 94.—Diagrammatic section of a five-carpellary ovary, in which the edges of the carpels, bearing the placentas and ovules *o*, are not folded inwards. The placentas are parietal, and the ovules appear sessile on the walls of the ovary. The ovary is unilocular.

dissepiments extend to the centre or axis, the ovary is divided into cavities or *cells*, and it may be *bilocular*, *trilocular* (fig. 92), *quadrilocular*, *quinquelocular*, or *multilocular*, according as it is formed by two, three, four, five or many carpels; each carpel corresponding to a single cell. In these cases the marginal placentas meet in the axis, and unite so as to form a single *central* one (figs. 92, 93), and the ovules appear in the central angle of the loculi. When the carpels in a syncarpous pistil do not fold inwards so that the placentas appear as projections on the walls

of the ovary, then the ovary is *unilocular* (fig. 95) and the placentas are *parietal*, as in *Viola* (fig. 96). In these instances the placentas may be formed at the margin of the united contiguous leaves, so as to appear single, or the margins may not be united, each developing a placenta. Frequently the margins of the carpels, which fold in to the centre, split there into two lamellae, each of which is curved outwards and projects into the

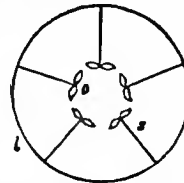

FIG. 95.

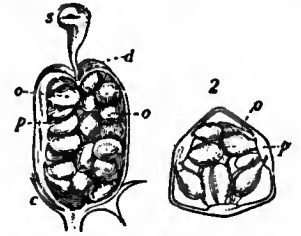

FIG. 96.

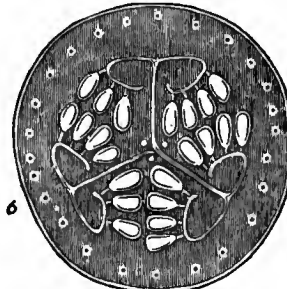

FIG. 97.

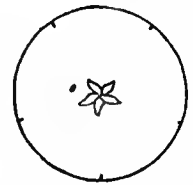

FIG. 98.

FIG. 95.—Diagrammatic section of a five-carpellary ovary, in which the septa (*s*) proceed inwards for a certain length, bearing the placentas and ovules (*o*). In this case the ovary is unilocular, and the placentas are parietal. Dorsal suture, *l*.

FIG. 96.—Pistil of Pansy (*Viola tricolor*), enlarged. 1, Vertical; 2, horizontal section; *c*, calyx; *d*, wall of ovary; *o*, ovules; *p*, placenta; *s*, stigma.

FIG. 97.—Transverse section of the fruit of the Melon (*Cucumis Melo*), showing the placentas with the seeds attached to them. The three carpels forming the pepo are separated by partitions. From the centre, processes go to circumference, ending in curved placentas bearing the ovules.

FIG. 98.—Diagrammatic section of a compound unilocular ovary, in which there are no indications of partitions. The ovules (*o*) are attached to a free central placenta, which has no connexion with the walls of the ovary.

loculament, dilating at the end into a placenta. This is well seen in Cucurbitaceae (fig. 97), *Pyrola*, &c. The carpellary leaves may fold inwards very slightly, or they may be applied in a valvate manner, merely touching at their margins, the placentas then being parietal (fig. 94), and appearing as lines or thickenings along the walls. Cases occur, however, in which the placentas are not connected with the walls of the ovary, and form what is called a *free central placenta* (fig. 98). This is seen in many of the Caryophyllaceae and Primulaceae (figs. 99, 100). In Caryophyllaceae, however, while the placenta is free in the centre, there are often traces found at the base of the ovary of the remains of septa, as if rupture had taken place, and, in rare instances, ovules are found on the margins of the carpels. But in Primulaceae no vestiges of septa or marginal ovules can be perceived at any period of growth; the placenta is always free, and rises in the centre of the ovary. Free central placentation, therefore, has been accounted for in two ways: either by supposing that the placentas in the early state were formed on the margins of



FIG. 99.

FIG. 99.—Pistil of *Cerastium hirsutum* cut vertically. *o*, Ovary; *p*, free central placenta; *g*, ovules; *s*, styles.



FIG. 100.

FIG. 100.—The same cut horizontally, and the halves separated so as to show the interior of the cavity of the ovary *o*, with the free central placenta *p*, covered with ovules *g*.

that the placentas in the early state were formed on the margins of

carpellary leaves, and that in the progress of development these leaves separated from them, leaving the placentas and ovules free in the centre; or by supposing that the placentas are not *marginal* but *axile* formations, produced by an elongation of the axis, and the carpels verticillate leaves, united together around the axis. The first of these views applies to Caryophyllaceae, the second to Primulaceae.

Occasionally, divisions take place in ovaries which are not formed by the edges of contiguous carpels. These are called *spurious dissepiments*. They are often horizontal, as in *Cathartocarpus Fistula*, where they consist of transverse cellular prolongations from the walls of the ovary, only developed after fertilization, and therefore more properly noticed under fruit. At other times they are vertical, as in *Datura*, where the ovary, in place of being two-celled, becomes four-celled; in Cruciferae, where the prolongation of the placentas forms a vertical partition; in *Astragalus* and *Thespesia*, where the dorsal suture is folded inwards; and in *Oxytropis*, where the ventral suture is folded inwards.

The ovary is usually of a more or less spherical or curved form, sometimes smooth and uniform on its surface, at other times hairy and grooved. The grooves usually indicate the divisions between the carpels and correspond to the dissepiments. The dorsal suture may be marked by a slight projection or by a superficial groove. When the ovary is situated on the centre of the receptacle, free from the other whorls, so that its base is above the insertion of the stamens, it is termed *superior*, as in *Lychnis*, *Primula* (fig. 61) and Peony (fig. 64) (see also fig. 28). When the margin of the receptacle is prolonged upwards, carrying with it the floral envelopes and staminal leaves, the basal portion of the ovary being formed by the receptacle, and the carpellary leaves alone closing in the apex, the ovary is *inferior*, as in pomegranate, aralia (fig. 65), gooseberry and fuchsia (see

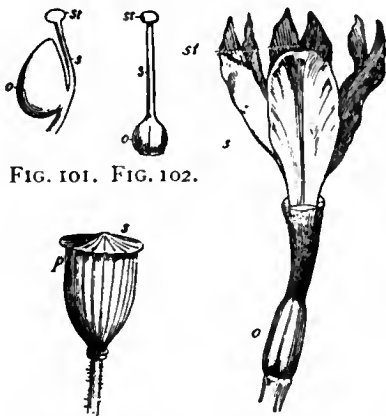

FIG. 101.—Carpel of Lady's-mantle (*Alchemilla*) with lateral style *s*; *o*, ovary, *st*, stigma. Enlarged.
 FIG. 102.—Pistil of Primrose (*Primula*) composed of five carpels which are completely united; *o*, ovary; *s*, style; *st*, stigma. Enlarged.
 FIG. 103.—Gynoecium of the Flower-de-Luce (*Iris*), consisting of an inferior ovary (*o*) and a style which divides into three petaloid segments (*s*), each bearing a stigma (*st*).
 FIG. 104.—Capsule of Poppy, opening by pores (*p*), under the radiating peltate stigma (*s*).

strawberry, or from the base, as in *Chrysobalanus Icaco*, when it is called *basilar*. In all these cases the style still indicates the organic apex of the ovary, although it may not be the apparent apex. When in a compound pistil the style of each carpel is thus displaced, it appears as if the ovary were depressed in the centre, and the style rising from the depression in the midst of the carpels seems to come from the torus. Such a style is *gynobasic*, and is well seen in Boraginaceae.

The form of the style is usually cylindrical, more or less filiform and simple; sometimes it is grooved on one side, at other times it is flat, thick, angular, compressed and even petaloid, as in *Iris* (fig. 103) and *Canna*. In Goodeniaceae it ends in a cup-like expansion, enclosing the stigma. It sometimes bears hairs, which aid in the application of the pollen to the stigma, and are called *collecting hairs*, as in *Campanula*, and also in *Aster* and other Compositae. These hairs, during the upward growth of the style, come into contact with the already ripened pollen, and carry it up along with them, ready to be applied by insects to the mature stigma of other flowers. In *Vicia* and *Lobelia* the hairs frequently form a tuft below the stigma. The styles of a syncarpous pistil are either separate or united; when separate, they alternate with the septa; when united completely, the style is said to be *simple* (fig. 102). The style of a single carpel, or of each carpel of a compound pistil, may also be divided. Each division of the tricarpellary ovary of *Jatropha Curcas* has a *bifurcate* or forked style, and the ovary of *Emblia officinalis* has three styles, each of which is twice forked. The length of the style is determined by the relation which should subsist between the position of the stigma and that of the anthers, so as to allow the proper application of the pollen. The style is deciduous or persists after fertilization.

The *stigma* is the termination of the conducting tissue of the style, and is usually in direct communication with the placenta. It consists of loose cellular tissue, and secretes a viscid matter which detains the pollen, and causes it to germinate. This secreting portion is, strictly speaking, the true stigma, but the name is generally applied to all the divisions of the style on which the stigmatic apparatus is situated. The stigma alternates with the dissepiments of a syncarpous pistil, or, in other words, corresponds with the back of the loculaments; but in some cases it would appear that half the stigma of one carpel unites with half that of the contiguous carpel, and thus the stigma is opposite the dissepiments, that is, alternates with the loculaments, as in the poppy.

The divisions of the stigma mark the number of carpels which compose the pistil. Thus in *Campanula* a five-cleft stigma indicates five carpels; in Bignoniaceae, Scrophulariaceae and Acanthaceae, the two-lobed or bilamellar stigma indicates a bilocular ovary. Sometimes, however, as in Gramineae, the stigma of a single carpel divides. Its position may be terminal or lateral. In *Iris* it is situated on a cleft on the back of the petaloid divisions of the style (fig. 103). Some stigmas, as those of *Mimulus*, present sensitive flattened laminae, which close when touched. The stigma presents various forms. It may be globular, as in *Mirabilis Jalapa*; orbicular, as in *Arbutus Andrachne*; umbrella-like, as in *Sarracenia*, where, however, the proper stigmatic surface is beneath the angles of the large expansion of the apex of the style; ovoid, as in fuchsia; hemispherical; polyhedral; radiating, as in the poppy (fig. 104), where the true stigmatic rays are attached to a sort of *peltate* or shield-like body, which may represent depressed or flattened styles; *cucullate*, i.e. covered by a hood, in calabar bean. The lobes of a stigma are flat and pointed as in *Mimulus* and *Bignonia*, fleshy and blunt, smooth or granular, or they are feathery, as in many grasses (fig. 105) and other wind-pollinated flowers. In Orchidaceae

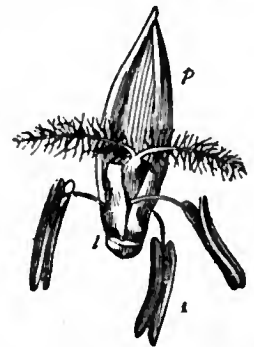

FIG. 105.—Flower of a grass with glumes removed, showing three stamens and two feathery styles. *p*, Pale; *l*, lodicules. Enlarged.

the stigma is situated on the anterior surface of the column beneath the anther. In Asclepiadaceae the stigmas are united to the face of the anthers, and along with them form a solid mass.

The ovule is attached to the placenta, and destined to become the seed. Ovules are most usually produced on the margins of

the carpellary leaves, but are also formed over the whole surface of the leaf, as in *Butomus*. In other instances they rise from the floral axis itself, either terminal, as in Polygonaceae and Piperaceae, or lateral, as in Primulaceae and Compositae. The ovule is usually contained in an ovary, and all plants in which the ovule is so enclosed are termed *angiospermous*; but in Coniferae and Cycadaceae it has no proper ovarian covering, and is called naked, these orders being denominated *gymnospermous*. In *Cycas* the altered leaf, upon the margin of which the ovule is produced, and the peltate scales, from which they are pendulous in *Zamia*, are regarded by all botanists as carpellary leaves. As for the Coniferae great discussion has arisen regarding the morphology of parts in many genera. The carpellary leaves are sometimes united in such a way as to leave an opening at the apex of the pistil, so that the ovules are exposed, as in mignonette. In *Leontice thalictroides* (Blue Cohosh), species of *Ophiopogon*, *Peliosanthes* and *Stateria*, the ovary ruptures immediately after flowering, and the ovules are exposed; and in species of *Cuphea* the placenta ultimately bursts through the ovary and corolla, and becomes erect, bearing the exposed ovules. The ovule is attached to the placenta either directly, when it is *sessile*, or by means of a prolongation *funicle* (fig. 110, *f*). This cord sometimes becomes much elongated after fertilization. The part by which the ovule is attached to the placenta or cord is its *base* or *hilum*, the opposite extremity being its *apex*. The latter is frequently turned round in such a way as to approach the base. The ovule is sometimes embedded in the placenta, as in *Hydnora*.

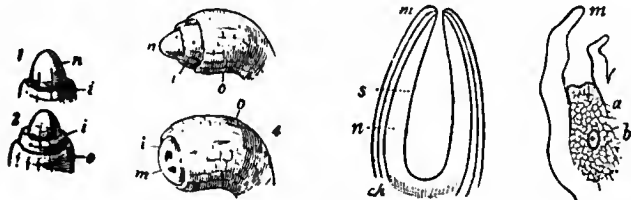

FIG. 106.

FIG. 107.

FIG. 108.

FIG. 109.

FIGS. 106 and 107.—Successive stages in the development of an ovule. *n*, Nucellus; *i*, inner; *o*, outer integument in section; *m*, micropyle.

FIG. 108.—Orthotropous ovule of *Polygonum* in section, showing the embryo-sac *s*, in the nucellus *n*, the different ovular coverings, the base of the nucellus or chalaza *ch*, and the apex of the ovule with its micropyle *m*.

FIG. 109.—Vertical section of the ovule of the Austrian Pine (*Pinus austriaca*), showing the nucellus *a*, consisting of delicate cellular tissue containing deep in its substance an embryo-sac *b*. The micropyle *m* is very wide.

The ovule appears at first as a small cellular projection from the placenta. The cells multiply until they assume a more or less enlarged ovate form constituting what has been called the *nucellus* (fig. 106, *n*), or central cellular mass of the ovule. This nucellus may remain naked, and alone form the ovule, as in some orders of parasitic plants such as Balanophoraceae, Santalaceae, &c.; but in most plants it becomes surrounded by certain coverings or integuments during its development. These appear first in the form of cellular rings at the base of the nucellus, which gradually spread over its surface (figs. 106, 107). In some cases only one covering is formed, especially amongst gamopetalous dicotyledons, as in Compositae, Campanulaceae, also in walnut, &c. But usually besides the single covering another is developed subsequently (fig. 106, *o*), which gradually extends over that first formed, and ultimately covers it completely, except at the apex. There are thus two integuments to the nucellus, an outer and an inner. The integuments do not completely invest the apex of the nucellus, but an opening termed the *micropyle* is left. The micropyle indicates the organic apex of the ovule. A single cell of the nucellus enlarges greatly to form the *embryo-sac* or megaspore (fig. 108, *s*). This embryo-sac increases in size, gradually supplanting the cellular tissue of the nucellus until it is surrounded only by a thin layer of it; or it

may actually extend at the apex beyond it, as in *Phaseolus* and *Alsine media*; or it may pass into the micropyle, as in *Santalum*. In Gymnosperms it usually remains deep in the nucellus and surrounded by a thick mass of cellular tissue (fig. 109). For an account of the further development of the megaspore, and the formation of the egg-cell, from which after fertilization is formed the embryo, see GYMNOSPERMS and ANGIOSPERMS.

The point where the integuments are united to the base of the nucellus is called the *chalaza* (figs. 111, 112). This is often coloured, is of a denser texture than the surrounding tissue, and is traversed by fibrovascular bundles, which pass from the placenta to nourish the ovule.

When the ovule is so developed that the chalaza is at the hilum (next the placenta), and the micropyle is at the opposite extremity, there being a short funicle, the ovule is *orthotropous*. This form is well seen in Polygonaceae (fig. 112), Cistaceae, and most gymnosperms. In such an ovule a straight line drawn from the hilum to the micropyle passes along the axis of the ovule.

Where, by more rapid growth on one side than on the other, the nucellus, together with the integuments, is curved upon itself, so that the micropyle approaches the hilum, and ultimately is placed close to it, while the chalaza is at the hilum, the ovule is *campylotropous* (fig. 110). Curved ovules are found in Cruciferae, and Caryophyllaceae. The inverted or *anatropous* ovule (fig. 111) is the commonest form amongst angiosperms. In this ovule the apex with the micropyle is turned towards the point of attachment of the funicle to the placenta, the chalaza being situated at the opposite extremity; and the funicle, which runs along the side usually next the placenta, coalesces with the ovule and constitutes the *raphe* (*r*), which often forms a ridge. The anatropous ovule arises from the placenta as a straight or only slightly curved cellular process, and as it grows, gradually becomes inverted, curving from the point of origin of the integuments (cf. figs. 106, 107). As the first integument grows round it, the amount of inversion increases, and the funicle becomes adherent to the side of the nucellus. Then if a second integument be formed it covers all the free part of the ovule, but does not form on the side to which the raphe is adherent. These may be taken as the three types of ovule; but there are various intermediate forms, such as *semi-anatropous* and others.

The position of the ovule relative to the ovary varies. When there is a single ovule, with its axis vertical, it may be attached to the placenta at the base of the ovary (*basal placenta*), and is then *erect*, as in Polygonaceae and Compositae; or it may be inserted a little above the base, on a parietal placenta, with its apex upwards, and then is *ascending*, as in *Pariclaria*. It may hang from an apical placenta at the summit of the ovary, its apex being directed downwards, and is *inverted* or *pendulous*, as in *Hippuris vulgaris*; or from a parietal placenta near the summit, and then is *suspended*, as in *Daphne Mezereum*, Polygalaceae and Euphorbiaceae. Sometimes a long funicle arises from a basal placenta, reaches the summit of the ovary, and there bending over suspends the ovule, as in *Armeria* (sea-pink); at other times the hilum appears to be in the middle, and the ovule becomes *horizontal*. When there are two ovules in the same cell, they may be either *collateral*, that is, placed side by

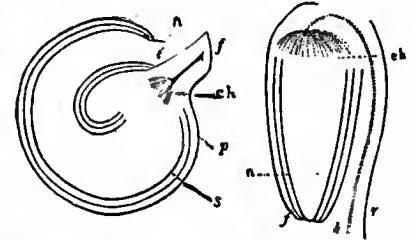

FIG. 110.

FIG. 111.

FIG. 110.—Campylotropous ovule of wall-flower (*Cheiranthus*), showing the funicle *f*, which attaches the ovule to the placenta; *p*, the outer, *s*, the inner coat, *n*, the nucellus, *ch*, the chalaza. The ovule is curved upon itself, so that the micropyle is near the funicle.

FIG. 111.—Anatropous ovule of Dandelion (*Taraxacum*), *n*, nucellus, which is inverted, so that the chalaza *ch*, is removed from the base or hilum *h*, while the micropyle *f* is near the base. The connexion between the base of the ovule and the base of the nucellus is kept up by means of the raphe *r*.

side (fig. 92), or the one may be erect and the other inverted, as in some species of *Spiraea* and *Aesculus*; or they may be placed one above another, each directed similarly, as is the case in ovaries containing a moderate or definite number of ovules. Thus, in the ovary of Leguminous plants (fig. 91), the ovules, *o*, are attached to the extended marginal placenta, one above the other, forming usually two parallel rows corresponding to each margin of the carpel. When the ovules are *definite* (*i.e.* are uniform, and can be counted), it is usual to find their attachment so constant as to afford good characters for classification. When the ovules are very numerous (*indefinite*), while at the same time the placenta is not much developed, their position exhibits great variation, some being directed upwards, others downwards, others transversely; and their form is altered by pressure into various polyhedral shapes. In such cases it frequently happens that some of the ovules are arrested in their development and become abortive.

When the pistil has reached a certain stage in growth it becomes ready for fertilization. Pollination having been effected, and the pollen-grain having reached the stigma in angiosperms, or the summit of the nucellus in gymnosperms, it is detained there, and the viscid secretion from the glands of the stigma in the former case, or from the nucellus in the latter, induce the protrusion of the intine as a pollen-tube

Fertilization.

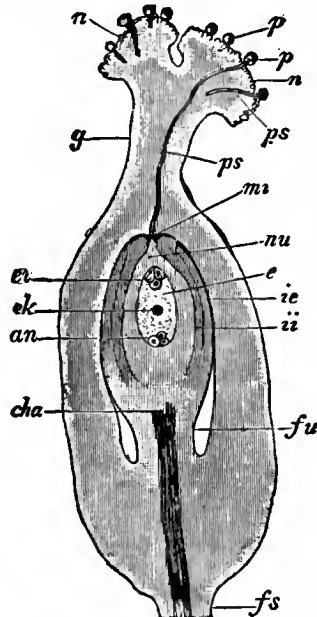

From Strasburger's *Lehrbuch der Botanik*, by permission of Gustav Fischer.

FIG. 112.—Ovary of *Polygonum convolvulus* in longitudinal section during fertilization. (X 48.)

- fs*, Stalk-like base of ovary.
- fu*, Funicle.
- cha*, Chalaza.
- nu*, Nucellus.
- mi*, Micropyle.
- ii*, inner, *ie*, outer integument.
- e*, Embryo-sac.
- ek*, Nucleus of embryo-sac.
- ei*, Egg-apparatus.
- an*, Antipodal cells.
- g*, Style.
- n*, Stigma.
- p*, Pollen-grains.
- ps*, Pollen-tubes.

passes down into the canal, and this portion of it increases considerably in size. Ultimately the apex of the tube comes in contact with the tip of the embryo-sac and perforates it. The male cells in the end of the pollen-tube are then transmitted to the embryo-sac and fertilization is effected. Consequent upon this, after a longer or shorter period, those changes commence in the embryo-sac which result in the formation of the embryo

through the pores of the grain. The pollen-tube or tubes pass down the canal (fig. 112), through the conducting tissue of the style when present, and reach the interior of the ovary in angiosperms, and then pass to the micropyle of the ovule, one pollen-tube going to each

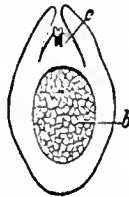

FIG. 113.—Vertical section of the ovule of the Scotch Fir (*Pinus sylvestris*) in May of the second year, showing the enlarged embryo-sac *b*, full of endosperm cells, and pollen-tubes *c*, penetrating the summit of the nucellus after the pollen has entered the large micropyle.

ovule. Sometimes the micropyle lies close to the base of the style, and then the pollen-tube enters it at once, but frequently it has to pass some distance into the ovary, being guided in its direction by various contrivances, as hairs, grooves, &c. In gymnosperms the pollen-grain resting on the apex of the nucellus sends out its pollen-tubes, which at once penetrate the nucellus (fig. 113). In angiosperms when the pollen-tube reaches the micropyle it

plant, the ovule also undergoing changes which convert it into the seed, and fit it for a protective covering, and a store of nutriment for the embryo. Nor are the effects of fertilization confined to the ovule; they extend to other parts of the plant. The ovary enlarges, and, with the seeds enclosed, constitutes the fruit, frequently incorporated with which are other parts of the flower, as receptacle, calyx, &c. In gymnosperms the pollen-tubes, having penetrated a certain distance down the tissue of the nucellus, are usually arrested in growth for a longer or shorter period, sometimes nearly a year. Fruit and seed are discussed in a separate article—FRUIT. (A. B. R.)

FLOWERS, ARTIFICIAL. Imitations of natural flowers are sometimes made for scientific purposes (as the collection of glass flowers at Harvard University, which illustrates the flora of the United States), but more often as articles of decoration and ornament. A large variety of materials have been used in their manufacture by different peoples at different times—painted linen and shavings of stained horn by the Egyptians, gold and silver by the Romans, rice-paper by the Chinese, silkworm cocoons in Italy, the plumage of highly coloured birds in South America, wax, small tinted shells, &c. At the beginning of the 18th century the French, who originally learnt the art from the Italians, made great advances in the accuracy of their reproductions, and towards the end of that century the Paris manufacturers enjoyed a world-wide reputation. About the same time the art was introduced into England by French refugees, and soon afterwards it spread also to America. The industry is now a highly specialized one and comprises a large number of operations performed by separate hands. Four main processes may be distinguished. The first consists of cutting up the various fabrics and materials employed into shapes suitable for forming the leaves, petals, &c.; this may be done by scissors, but more often stamps are employed which will cut through a dozen or more thicknesses at one blow. The veins of the leaves are next impressed by means of a die, and the petals are given their natural rounded forms by goffering irons of various shapes. The next step is to assemble the petals and other parts of the flower, which is built up from the centre outwards; and the fourth is to mount the flower on a stalk formed of brass or iron wire wrapped round with suitably coloured material, and to fasten on the leaves required to complete the spray.

FLOYD, JOHN (1572–1649), English Jesuit, was born in Cambridgeshire in 1572. He entered the Society of Jesus when at Rome in 1592 and is also known as Daniel à Jesu, Hermannus Loemelius, and George White, the names under which he published a score of controversial treatises. He had considerable fame both as a preacher and teacher, and was frequently arrested in England. His last years were spent at Louvain and he died at St Omer on the 15th of September 1649. His brother Edward Floyd was impeached and sentenced by the Commons in 1621 for speaking disparagingly of the elector palatine.

FLOYD, JOHN BUCHANAN (1807–1863), American politician, was born at Blacksburg, Virginia, on the 1st of June 1807. He was the son of John Floyd (1770–1837), a representative in Congress from 1817 to 1829 and governor of Virginia from 1830 to 1834. After graduating at South Carolina College in 1826, the son practised law in his native state and at Helena, Arkansas, and in 1839 settled in Washington county, Virginia, which in 1847–1849 and again in 1853 he represented in the state legislature. Meanwhile, from 1849 to 1852, he was governor of Virginia, in which position he recommended to the legislature the enactment of a law laying an import tax on the products of such states as refused to surrender fugitive slaves owned by Virginia masters. In March 1857 he became secretary of war in President Buchanan's cabinet, where his lack of administrative ability was soon apparent. In December 1860, on ascertaining that Floyd had honoured heavy drafts made by government contractors in anticipation of their earnings, the president requested his resignation. Several days later Floyd was indicted for malversation in office, but the indictment was overruled on technical grounds. There is no proof that he profited by these irregular transactions; in fact he went out of the office

financially embarrassed. Though he had openly opposed secession before the election of Lincoln, his conduct after that event, especially after his breach with Buchanan, fell under suspicion, and he was accused of having sent large stores of government arms to Southern arsenals in anticipation of the Civil War. In the last days of his term he apparently had such an intention, but during the year 1860 the Southern States actually received less than their full quota of arms. After the secession of Virginia he was commissioned a brigadier-general in the Confederate service. He was first employed in some unsuccessful operations in western Virginia, and in February 1862 became commander of the Confederate forces at Fort Donelson, from which he fled with his second in command, General Gideon J. Pillow, on the night of February 18, leaving General Simon B. Buckner to surrender to General Grant. A fortnight later President Davis relieved him of his command. He died at Abingdon, Virginia, on the 26th of August 1863.

FLOYER, SIR JOHN (1649–1734), English physician and author, was born at Hinters in Staffordshire, and was educated at Oxford. He practised in Lichfield, and it was by his advice that Dr Johnson, when a child, was taken by his mother to be touched by Queen Anne for the king's evil on the 30th of March 1714. He died on the 1st of February 1734. Floyer was an advocate of cold bathing, introduced the practice of counting the rate of the pulse-beats, and gave an early account of the pathological changes in the lungs associated with emphysema.

His writings include:—*Φαρμακο-Βάσανος; or the Touchstone of Medicines, discovering the virtues of Vegetables, Minerals and Animals, by their Tastes and Smells* (2 vols., 1687); *The praeternatural State of animal Humours described by their sensible Qualities* (1696); *An Enquiry into the right Use and Abuses of the hot, cold and temperate Baths in England* (1697); *A Treatise of the Asthma* (1st ed., 1698); *The ancient Ψυχρολουσία revived, or an Essay to prove cold Bathing both safe and useful* (London, 1702; several editions 8vo; abridged, Manchester, 1844, 12mo); *The Physician's Pulse-watch* (1707–1710); *The Sibylline Oracles, translated from the best Greek copies, and compared with the sacred Prophecies* (1st ed., 1713); *Two Essays: the first Essay concerning the Creation, Aethereal Bodies, and Offices of good and bad Angels; the second Essay concerning the Mosaic System of the World* (Nottingham, 1717); *An Exposition of the Revelations* (1719); *An Essay to restore the Dipping of Infants in their Baptism* (1722); *Medicina Gerocomica, or the Galenic Art of preserving old Men's Healths* (1st ed., 1724); *A Comment on forty-two Histories described by Hippocrates* (1726).

FLUDD, or FLUD, ROBERT [ROBERTUS DE FLUCTIBUS] (1574–1637), English physician and mystical philosopher, the son of Sir Thomas Fludd, treasurer of war to Queen Elizabeth in France and the Low Countries, was born at Milgate, Kent. After studying at St John's College, Oxford, he travelled in Europe for six years, and became acquainted with the writings of Paracelsus. He subsequently returned to Oxford, became a member of Christ Church, took his medical degrees, and ultimately became a fellow of the College of Physicians. He practised in London with success, though it is said that he combined with purely medical treatment a good deal of faith-healing. Following Paracelsus, he endeavoured to form a system of philosophy founded on the identity of physical and spiritual truth. The universe and all created things proceed from God, who is the beginning, the end and the sum of all things, and to him they will return. The act of creation is the separation of the active principle (light) from the passive (darkness) in the bosom of the divine unity (God). The universe consists of three worlds; the archetypal (God), the macrocosm (the world), the microcosm (man). Man is the world in miniature, all the parts of both sympathetically correspond and act upon each other. It is possible for man (and even for the mineral and the plant) to undergo transformation and to win immortality. Fludd's system may be described as a materialistic pantheism, which, allegorically interpreted, he put forward as containing the real meaning of Christianity, revealed to Adam by God himself, handed down by tradition to Moses and the patriarchs, and revealed a second time by Christ. The opinions of Fludd had the honour of being refuted by Kepler, Gassendi and Mersenne. Though rapt in mystical speculation, Fludd was a man of varied attainments. He did not disdain scientific experiments, and is

thought by some to be the original inventor of the barometer. He was an ardent defender of the Rosicrucians, and De Quincey considers him to have been the immediate, as J. V. Andréa was the remote, father of freemasonry. Fludd died on the 8th of September 1637.

See J. B. Craven, *Robert Fludd, the English Rosicrucian* (1902), where a list of his works is given; A. E. Waite, *The Real History of the Rosicrucians* (1887); De Quincey, *The Rosicrucians and Freemasons*; J. Hunt, *Religious Thought in England* (1870), i. 240 seq. His works were published in 6 vols., Oppenheim and Gouda, 1638.

FLÜGEL, GUSTAV LEBERECHE (1802–1870), German orientalist, was born at Bautzen on the 18th of February 1802. He received his early education at the gymnasium of his native town, and studied theology and philology at Leipzig. Gradually he devoted his attention chiefly to Oriental languages, which he studied in Vienna and Paris. In 1832 he became professor at the *Fürstenschule* of St Afra in Meissen, but ill-health compelled him to resign that office in 1850, and in 1851 he went to Vienna, where he was employed in cataloguing the Arabic, Turkish and Persian manuscripts of the court library. He died at Dresden on the 5th of July 1870.

Flügel's chief work is an edition of the bibliographical and encyclopaedic lexicon of Haji Khalfa, with Latin translation (7 vols., London and Leipzig, 1835–1858). He also brought out an edition of the Koran (Leipzig, 1834 and again 1893); then followed *Concordantiae Corani arabicae* (Leipzig, 1842 and again 1898); *Mani, seine Lehren und seine Schriften* (Leipzig, 1862); *Die grammatischen Schulen der Araber* (Leipzig, 1862); and *Ibn Kullūbugas Krone der Lebensbeschreibungen* (Leipzig, 1862). An edition of *Kitāb-al-Fihrist*, prepared by him, was published after his death.

FLÜGEL, JOHANN GOTTFRIED (1788–1855), German lexicographer, was born at Barby near Magdeburg, on the 22nd of November 1788. He was originally a merchant's clerk, but emigrating to the United States in 1810, he made a special study of the English language, and returning to Germany in 1819, was in 1824 appointed lector of the English language in the university of Leipzig. In 1838 he became American consul, and subsequently representative and correspondent of the Smithsonian Institution at Washington and several other leading American literary and scientific institutions. He died at Leipzig on the 24th of June 1855.

The fame of Flügel rests chiefly on the *Vollständige englisch-deutsche und deutsch-englische Wörterbuch*, first published in 2 vols. (Leipzig) in 1830, which has had an extensive circulation not only in Germany but in England and America. In this work he was assisted by J. Sporschil, and a new and enlarged edition; edited by his son Felix Flügel (1820–1904), was published at Brunswick (1890–1892). Another edition, in two volumes, edited by Prof. Immanuel Schmidt and S. Tanger appeared (Brunswick, London & New York) in 1906. Among his other works are—*Vollständige engl. Sprachlehre* (1824–1826); *Triglote, oder kaufmännisches Wörterbuch in drei Sprachen, Deutsch, Englisch und Französisch* (1836–1840); *Kleines Kaufmännisches Handwörterbuch in drei Sprachen* (1840); and *Praktisches Handbuch der engl. Handelscorrespondenz* (1827, 9th ed. 1873). All these have passed through several editions. In addition, Flügel also published in the English language: *A series of Commercial Letters* (Leipzig, 1822), a 9th edition of which appeared in 1874 under the title *Practical Mercantile Correspondence* and a *Practical Dictionary of the English and German Languages* (2 vols., Hamburg and Leipzig, 1847–1852; 15th ed., Leipzig, 1891). The last was continued and re-edited by his son Felix.

FLUKE (probably connected with the Ger. *flach*, flat), a name given to several kinds of fish, flat in shape, especially to the common flounder; also the name of a trematoid worm, resembling a flounder in shape, which as a parasite infects the liver and neighbouring organs of certain animals, especially sheep, and causes liver-rot. The most common is the *Fasciola hepatica* (see TREMATODES). It is also the name of a species of kidney potato. Probably from a resemblance to the shape of the fish, "fluke" is the name given to the holding-plates, triangular in shape, at the end of the arms of an anchor, and to the triangular extremities of the tail of a whale. The use of the word as a slang expression for a lucky accident appears to have been first applied in billiards to an unintentional scoring shot.

FLUME (through an O. Fr. word *flum*, from the Lat. *flumen*, a river), a word formerly used for a stream, and particularly for the tail of a mill-race. It is used in America for a very narrow gorge running between precipitous rocks, with a stream

at the bottom, but more frequently is applied to an artificial channel of wood or other material for the diversion of a stream of water from a river for purposes of irrigation, for running a saw-mill, or for various processes in the hydraulic method of gold-mining (see *AQUEDUCT*).

FLUMINI MAGGIORE, a town of the province of Cagliari, Sardinia, 10 m. by road N. of Iglesias, and 5 m. from the W. coast. Pop. (1901) town 3908; commune 9647. It is the centre of a considerable lead and zinc mining district. Three miles to the S. are the ruins of a temple erected probably in the time of Commodus (*Corpus inscr. Lat.* x., Berlin, 1883, No. 7539). They seem to mark the site of Metalla (mines), a station on the coast road from Sulci to Tharros, and the centre of the mining district in Roman times. At Flumini Maggiore itself were found two ingots of lead, one bearing a stamp with Hadrian's name.

FLUORANTHENE, $C_{15}H_{10}$, also known as idryl, a hydrocarbon occurring with phenanthrene, pyrene, diphenyl, and other substances in "Stupp" fat (the fat obtained in working up the mercury ores in Idria), and also in the higher boiling fractions of the coal tar distillate. It was discovered by R. Fittigin 1878, who, with Gebhard and H. Liepmann, elucidated its constitution (see *Ann.*, 1879, 200, p. 1). The hydrocarbons are separated from the "Stupp" by means of alcohol, the soluble portion on distillation giving first phenanthrene and then a mixture of pyrene and fluoranthene. From the tar distillate, the chrysene can be fractionally precipitated, and the fluoranthene can be separated from most of the pyrene by fractional distillation in a partial vacuum. In either case the two hydrocarbons are finally separated by fractional crystallization of their picrates, which are then decomposed by ammonia. Fluoranthene crystallizes in large slender needles or monoclinic tables, melting at $109-110^{\circ}C.$ and boiling at $250-251^{\circ}C.$ (60 mm.). It is easily soluble in hot alcohol, ether and carbon bisulphide. On oxidation with chromic acid it forms a quinone, $C_{15}H_8O_2$, and an α -diphenylene keto-carboxylic acid $\begin{matrix} C_6H_4 \\ \searrow \\ C_6H_4 \end{matrix} \begin{matrix} \searrow \\ \searrow \\ \searrow \\ \searrow \end{matrix} \begin{matrix} CO \\ CO_2H \end{matrix}$. The picrate melts at $182-183^{\circ}C.$

FLUORENE (α -diphenylene methane), $C_{18}H_{10}$ or $(C_6H_4)_2CH_2$, a hydrocarbon found in coal-tar. It is obtained from the higher boiling fractions, after separation of naphthalene and anthracene, by fractional distillation, the portion boiling between $290-340^{\circ}C.$ being taken. The fluorene is separated from this by placing it in a freezing mixture, and is then redistilled or crystallized from glacial acetic acid, or purified by means of its picrate. It may be prepared by distilling diphenylene ketone over zinc dust, or by heating it with hydriodic acid and phosphorus to $150-160^{\circ}C.$; and also by passing the vapour of diphenyl methane through a red hot tube. It crystallizes in colourless plates, possessing a violet fluorescence, melting at $112-113^{\circ}$ and boiling at $293-295^{\circ}C.$ By oxidation with chromic acid in glacial acetic acid solution, it is converted into diphenylene ketone $(C_6H_4)_2CO$; whilst on heating with hydriodic acid and phosphorus to $250-260^{\circ}C.$ it gives a hydro derivative of composition $C_{18}H_{22}$.

FLUORESCIN, or **RESORCIN-PHTHALEIN**, $C_{20}H_{12}O_6$, in chemistry, a compound discovered in 1876 by A. v. Bayer by the condensation of phthalic anhydride with resorcin at $195-200^{\circ}C.$ (*Ann.*, 1876, 183, p. 1). The two reacting substances are either heated alone or with zinc chloride for some hours, and the melt obtained is boiled out with water, washed by dilute alcohol, extracted by means of sodium hydrate, and the solution so obtained is precipitated by an acid. The precipitate is well washed with water and then dried. By repeating this process two or three times, the fluorescein may be obtained in a very pure condition. It forms a yellow amorphous powder, insoluble in water but soluble in alcohol, and crystallizing from the alcoholic solution in small dark red nodules. It is readily soluble in solutions of the caustic alkalis, the solution being of a dark red colour and showing (especially when largely diluted with water) a brilliant green fluorescence. It was so named on account of this last character. By brominating fluorescein in glacial acetic acid solution, eosin (tetrabromfluorescein) is obtained, the same compound being formed by heating 3.5-dibrom-2.4-dioxybenzoylbenzoic acid above its melting point (R. Meyer, *Ber.*,

1895, 28, p. 1576). It crystallizes from alcohol in yellowish red needles, and dyes silk, wool, and mordanted cotton a fine pink colour. When heated with caustic alkalis it yields dibrom-resorcin and dibrommonoresorcin-phthalein. The corresponding iodo compound is known as *erythrosin*. Fluorescein is readily nitrated, yielding a di- or tetra-nitro compound according to conditions. The entrance of the negative nitro group into the molecule weakens the central pyrone ring in the fluorescein nucleus and the di- and tetra-nitro compounds readily yield hydrates (see J. T. Hewitt and B. W. Perkins, *Jour. Chem. Soc.*, 1900, p. 1326). By the action of ammonia or amines the di-nitro fluoresceins are converted into yellow dyestuffs (F. Reverdin, *Ber.*, 1897, 30, p. 332). Other dyestuffs obtained from fluorescein are safrosine or eosin scarlet (dibromdinitrofluorescein) and rose Bengal (tetraiodotetrachlorfluorescein).

On fusion with caustic alkali, fluorescein yields resorcin, $C_6H_4(OH)_2$, and monoresorcin phthalein (dioxymethylbenzoic acid), $(HO)_2C_6H_3-CO-C_6H_4-COOH$. With zinc dust and caustic soda it yields fluorescein. By warming fluorescein with excess of phosphorus pentachloride it yields fluorescein chloride, $C_{20}H_{10}O_3Cl_2$ (A. Bayer), which crystallizes from alcohol in small prisms, melting at $252^{\circ}C.$ When heated with aniline and aniline hydrochloride, fluorescein yields a colourless anilide (O. Fischer and E. Hepp, *Ber.*, 1893, 26, p. 2236), which is readily methylated by methyl iodide and potash to a fluoresceinanilidedimethyl ether, which when heated for six hours to $150^{\circ}C.$ with acetic and hydrochloric acids, is hydrolysed and yields a colourless fluoresceindimethyl ether, which melts at $198^{\circ}C.$ On the other hand, by heating fluorescein with caustic potash, methyl iodide and methyl alcohol, a coloured (yellow) dimethyl ether, melting at $208^{\circ}C.$ is obtained (Fischer and Hepp). By heating the coloured dimethyl ether with caustic soda, the monomethyl ether is obtained (O. Fischer and E. Hepp, *Ber.*, 1895, 28, p. 397); this crystallizes in triclinic tables, and melts at $262^{\circ}C.$ It is to be noted that the colourless monomethyl ether fluoresces strongly in alkaline solution, the dimethyl ether of melting point 208° fluoresces only in neutral solution (e.g., in alcoholic solution), and the dimethyl ether of melting point $198^{\circ}C.$ only in concentrated hydrochloric or sulphuric acid solution (Fischer and Hepp). Considerable discussion has taken place as to the position held by the hydroxyl groups in the fluorescein molecule, C. Graebe (*Ber.*, 1895, 28, p. 28) asserting that they were in the ortho position to the linking carbon atom of the phthalic anhydride residue. G. Heller (*Ber.*, 1895, 28, p. 312), however, showed that monoresorcin-phthalein when brominated in glacial acetic acid gives a dibrom derivative which, with fuming sulphuric acid, yields dibromxanthopurpurin (1.3-dioxy-2.4-dibromanthraquinone), a reaction which is only possible if the fluorescein (from which the monoresorcin-phthalein is derived) contains free hydroxyl groups in the para position to the linking carbon atom of the phthalic anhydride residue.

FLUORESCENCE. In a paper read before the Royal Society of Edinburgh in 1833, Sir David Brewster described a remarkable phenomenon he had discovered to which he gave the name of "internal dispersion." On admitting a beam of sunlight, condensed by a lens, into a solution of chlorophyll, the green colouring matter of leaves (see fig. 1), he was surprised to find that the path of the rays within the fluid was marked by a bright light of a blood-red colour, strangely contrasting with the beautiful green of the fluid when seen in moderate thickness. Brewster afterwards observed the same phenomenon in various vegetable solutions and essential oils, and in some solids, amongst which was fluor-spar. He believed this effect to be due to coloured particles held in suspension. A few years later, Sir John Herschel independently discovered that if a solution of quinine sulphate, which, viewed by transmitted light, appears colourless and transparent like water, were illuminated by a beam of ordinary daylight, a peculiar blue colour was seen in a thin stratum of the fluid adjacent to the surface by which the light entered. The blue light was unpolarized and passed freely through many inches of the fluid. The incident beam, after having passed through the stratum from which the blue light came, was not sensibly enfeebled or coloured, but yet it had lost the power of

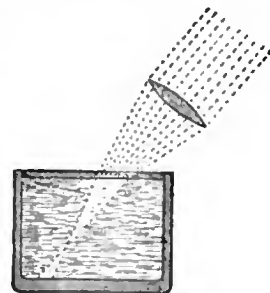

FIG. 1.

producing the characteristic blue colour when admitted into a second solution of quinine sulphate. A beam of light modified in this mysterious manner was called by Herschel "epipolized." Brewster showed that epipolized was merely a particular case of internal dispersion, peculiar only in this respect, that the rays capable of dispersion were dispersed with unusual rapidity.

The investigation of this phenomenon was afterwards taken up by Sir G. G. Stokes, to whom the greater part of our present knowledge of the subject is due. Stokes's first paper "On the Change of the Refrangibility of Light" appeared in 1852. He repeated the experiments of Brewster and Herschel, and considerably extended them. These experiments soon led him to the conclusion that the effect could not be due, as Brewster had imagined, to the scattering of light by suspended particles, but that the dispersed beam actually differed in refrangibility from the light which excited it. He therefore termed it "true internal dispersion" to distinguish it from the scattering of light, which he called "false internal dispersion." As this name, however, is apt to suggest Brewster's view of the phenomenon, he afterwards abandoned it as unsatisfactory, and substituted the word "fluorescence." This term, derived from fluor-spar after the analogy of opalescence from opal, does not presuppose any theory. To examine the nature of the fluorescence produced by quinine, Stokes formed a pure spectrum of the sun's rays in the usual manner. A test-tube, filled with a dilute solution of quinine sulphate, was placed just outside the red end of the spectrum and then gradually moved along the spectrum to the other extremity. No fluorescence was observed as long as the tube remained in the more luminous portion, but as soon as the violet was reached, a ghost-like gleam of blue light shot right across the tube. On continuing to move the tube, the blue light at first increased in intensity and afterwards died away, but not until the tube had been moved a considerable distance into the ultra-violet part of the spectrum. When the blue gleam first appeared it extended right across the tube, but just before disappearing it was confined to a very thin stratum on the side at which the exciting rays entered. Stokes varied this experiment by placing a vessel filled with the dilute solution in a spectrum formed by a train of prisms. The appearance is illustrated diagrammatically in fig. 2.

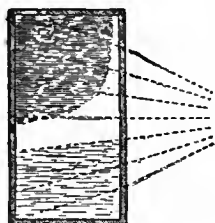

FIG. 2.

The greater part of the light passed freely as if through water, but from about half-way between the Fraunhofer lines G and H to far beyond the extreme violet, the incident rays gave rise to light of a sky-blue colour, which emanated in all directions from the portion of the fluid (represented white in fig. 2) which was under the influence of the incident rays. The anterior surface of the blue space coincided, of course, with the inner surface of the glass vessel. The posterior surface marked the distance to which the incident rays were able to penetrate before they were absorbed. This distance was at first considerable, greater than the diameter of the vessel, but decreased with great rapidity as the refrangibility of the incident light increased, so that from a little beyond the extreme violet to the end, the blue space was reduced to an excessively thin stratum. This shows that the fluid is very opaque to the ultra-violet rays. The fixed lines in the violet and invisible part of the solar spectrum were represented by dark lines, or rather planes, intersecting the blue region. Stokes found that the fluorescent light is not homogeneous, for on reducing the incident rays to a narrow band of homogeneous light, and examining the dispersed beam through a prism, he found that the blue light consisted of rays extending over a wide range of refrangibility, but not into the ultra-violet.

Another method, which Stokes found especially useful in examining different substances for fluorescence, was as follows. Two coloured media were prepared, one of which transmitted the upper portion of the spectrum and was opaque to the lower portion, while the second was opaque to the upper and trans-

parent to the lower part of the spectrum. These were called by Stokes "complementary absorbents." No pair could be found which were exactly complementary, of course, but the condition was approximately fulfilled by several sets of coloured glasses or solutions. One such combination consisted of a deep-blue solution of ammoniacal copper sulphate and a yellow glass coloured with silver. The two media together were almost opaque. The light of the sun being admitted through a hole in the window-shutter, a white porcelain tablet was laid on a shelf fastened in front of the hole. If the vessel containing the blue solution was placed so as to cover the hole, and the tablet was viewed through the yellow glass, scarcely any light entered the eye, but if a paper washed with some fluorescent liquid were laid on the tablet it appeared brilliantly luminous. Different pairs of complementary absorbents were required according to the colour of the fluorescent light. This experiment shows clearly that the light which passed through the first absorbent and which would have been stopped by the second gave rise in the fluorescent substance to rays of a different wave-length which were transmitted by the second absorbent. Scattered light, with which the true fluorescent light was often associated, was eliminated by this method, being stopped by the second absorbent.

Stokes also used a method, analogous to Newton's method of crossed prisms, for the purpose of analysing the fluorescent light. A spectrum was produced by means of a slit and a prism, the slit being horizontal instead of vertical. The resulting very narrow spectrum was projected on a white paper moistened with a fluorescent solution, and viewed through a second prism with its refracting edge perpendicular to that of the first prism. In addition to the sloping spectrum seen under ordinary circumstances, another spectrum due to the fluorescent light alone, made its appearance, as seen in figs. 3 and 4.

In this spectrum the colours do not run from left to right, but in horizontal lines. Thus the dark lines of the solar spectrum lie across the colours. The spectra in figs. 3 and 4 were obtained by V. Pierre with an improved arrangement of Stokes's method. It will be seen that, in the case of chlorophyll, the whole spectrum, far into the ultra-violet, gives rise to a short range of red fluorescent light, while the effective part of the exciting light in the case of aesculin (a glucoside occurring in horse-chestnut bark) begins a little above the fixed line G and the fluorescent light covers a wide range extending from orange to blue.

Besides the substances already mentioned, a large number of vegetable extracts and some inorganic bodies are strongly fluorescent. Stokes found that most organic substances show signs of fluorescence. Green fluor-spar from Alston Moor exhibits a violet, uranium glass a yellowish-green fluorescence. Tincture of turmeric gives rise to a greenish light, and the extract of seeds of *Datura stramonium* a pale green light. Ordinary paraffin oil fluoresces blue. Barium platinocyanide, which is much used in the fluorescent screens employed in work with the Röntgen rays, shows a brilliant green fluorescence with ordinary light. Crystals of magnesium platinocyanide possess the remarkable property of emitting a polarized fluorescent light,

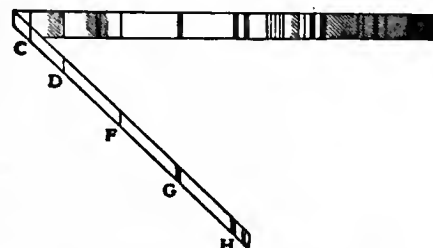

FIG. 3.—Spectrum of Chlorophyll.

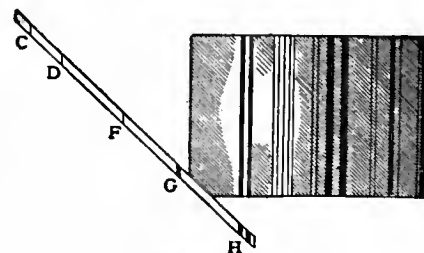

FIG. 4.—Spectrum of Aesculin.

the colour and plane of polarization depending on the position of the crystal with respect to the incident beam, and, if polarized light is used, on the plane of polarization of the latter.

Stokes's Law.—In all the substances examined by Stokes, the fluorescent light appeared to be of lower refrangibility than the light which excited it. Stokes considered it probable that this lowering of the refrangibility of the light was a general law which held for all substances. This is known as Stokes's law. It has been shown, however, by E. Lommel and others, that this law does not hold generally. Lommel distinguishes two kinds of fluorescence. The bodies which exhibit the first kind are those which possess strong absorption bands, of which only one remains appreciable after great dilution. These bodies are always strongly coloured and show anomalous dispersion and (in solids) surface colour. In such cases, the maximum of intensity in the fluorescent spectrum corresponds to the maximum of absorption. Stokes's law is not obeyed, for a fluorescent spectrum can be produced by means of homogeneous light of lower refrangibility than a great part of the fluorescent light. The second kind of fluorescence is the most common, and is exhibited by bodies which show absorption only in the upper part of the spectrum, *i.e.* they are usually yellow or brown or (if the absorption is in the ultra-violet) colourless. The absorption bands also are different from those of substances of the first kind, for they readily disappear on dilution. A third class of bodies is formed by those substances which exhibit both kinds of fluorescence.

Nature of Fluorescence.—No complete theory of fluorescence has yet been given, though various attempts have been made to explain the phenomenon. Fluorescence is closely allied to phosphorescence (*q.v.*), the difference consisting in the duration of the effect after the exciting cause is removed. Liquids which fluoresce only do so while the exciting light is falling on them, ceasing immediately the exciting light is cut off. In the case of solids, on the other hand, such as fluor-spar or uranium glass, the effect, though very brief, does not die away quite instantaneously, so that it is really a very brief phosphorescence. The property of phosphorescence has been generally attributed to some molecular change taking place in the bodies possessing it. That some such change takes place during fluorescence is rendered probable by the fact that the property depends upon the state of the sensitive substance; some bodies, such as barium platino-cyanide, fluorescing in the solid state but not in solution, while others, such as fluorescein, only fluoresce in solution. Fluorescence is always associated with absorption, but many bodies are absorbent without showing fluorescence. A satisfactory theory would have to account for these facts as well as for the production of waves of one period by those of another, and the non-homogeneous character of the fluorescent light. Quite recently W. Voigt has sought to give a theory of fluorescence depending on the theory of electrons. Briefly, this theory assumes that the electrons which constitute the molecule of the sensitive body can exist in two or more different configurations simultaneously, and that these are in dynamical equilibrium, like the molecule in a partially dissociated gas. If the electrons have different periods of vibration in the different configurations, then it would happen that the electrons whose period nearly corresponded with that of the incident light would absorb the energy of the latter, and if they then underwent a transformation into a different configuration with a different period, this absorbed energy would be given out in waves of a period corresponding to that of the new configuration.

Applications of Fluorescence.—The phenomenon of fluorescence can be utilized for the purpose of illustrating the laws of reflection and refraction in lecture experiments since the path of a ray of light through a very dilute solution of a sensitive substance is rendered visible. The existence of the dark lines in the ultra-violet portion of the solar spectrum can also be demonstrated in a simple manner. In addition to the foregoing applications, Stokes made use of this property for studying the character of the ultra-violet spectrum of different sources of illumination and flames. He suggested also that the property would in some cases furnish a simple test for the presence of a

small quantity of a sensitive substance in an organic mixture. Fluorescent screens are largely used in work with Röntgen rays. There appears to be some prospect of light being thrown on the question of molecular structure by experiments on the fluorescence of vapours. Some very interesting experiments in this direction have been performed by R. W. Wood on the fluorescence of sodium vapour.

REFERENCES.—Sir G. G. Stokes, *Mathematical and Physical Papers*, vols. iii. and iv.; Müller-Pouillet, *Lehrbuch der Physik*, Bd. ii. (1897); A. Wüllner, *Lehrbuch der Experimentalphysik*, Bd. iv. (1899); A. A. Winkelmann, *Handbuch der Physik*, Bd. vi. (1906); R. W. Wood, *Physical Optics* (1905). (J. R. C.)

FLUORINE (symbol F, atomic weight 19), a chemical element of the halogen group. It is never found in the uncombined condition, but in combination with calcium as fluor-spar CaF_2 it is widely distributed; it is also found in cryolite Na_3AlF_6 , in fluor-apatite, $\text{CaF}_2 \cdot 3\text{Ca}_3\text{P}_2\text{O}_8$, and in minute traces in sea-water, in some mineral springs, and as a constituent of the enamel of the teeth. It was first isolated by H. Moissan in 1886 by the electrolysis of pure anhydrous hydrofluoric acid containing dissolved potassium fluoride. The U-shaped electrolytic vessel and the electrodes are made of an alloy of platinum-iridium, the limbs of the tube being closed by stoppers made of fluor-spar, and fitted with two lateral exit tubes for carrying off the gases evolved. Whilst the electrolysis is proceeding, the apparatus is kept at a constant temperature of -23°C . by means of liquid methyl chloride. The fluorine, which is liberated as a gas at the anode, is passed through a well cooled platinum vessel, in order to free it from any acid fumes that may be carried over, and finally through two platinum tubes containing sodium fluoride to remove the last traces of hydrofluoric acid; it is then collected in a platinum tube closed with fluor-spar plates. B. Brauner (*Jour. Chem. Soc.*, 1894, 65, p. 393) obtained fluorine by heating potassium fluorplumbate $3\text{KF} \cdot \text{HF} \cdot \text{PbF}_4$. At 200°C . this salt decomposes, giving off hydrofluoric acid, and between 230 – 250°C . fluorine is liberated.

Fluorine is a pale greenish-yellow gas with a very sharp smell; its specific gravity is 1.265 (H. Moissan); it has been liquefied, the liquid also being of a yellow colour and boiling at -187°C . It is the most active of all the chemical elements; in contact with hydrogen combination takes place between the two gases with explosive violence, even in the dark, and at as low a temperature as -210°C .; finely divided carbon burns in the gas, forming carbon tetrafluoride; water is decomposed even at ordinary temperatures, with the formation of hydrofluoric acid and "ozonised" oxygen; iodine, sulphur and phosphorus melt and then inflame in the gas; it liberates chlorine from chlorides, and combines with most metals instantaneously to form fluorides; it does not, however, combine with oxygen. Organic compounds are rapidly attacked by the gas.

Only one compound of hydrogen and fluorine is known, namely *hydrofluoric acid*, HF or H_2F_2 , which was first obtained by C. Scheele in 1771 by decomposing fluor-spar with concentrated sulphuric acid, a method still used for the commercial preparation of the aqueous solution of the acid, the mixture being distilled from leaden retorts and the acid stored in leaden or gutta-percha bottles. The perfectly anhydrous acid is a very volatile colourless liquid and is best obtained, according to G. Gore (*Phil. Trans.*, 1869, p. 173) by decomposing the double fluoride of hydrogen and potassium, at a red heat in a platinum retort fitted with a platinum condenser surrounded by a freezing mixture, and having a platinum receiver luted on. It can also be prepared in the anhydrous condition by passing a current of hydrogen over dry silver fluoride. The pure acid thus obtained is a most dangerous substance to handle, its vapour even when highly diluted with air **having an exceedingly injurious action** on the respiratory organs, whilst inhalation of the pure vapour is followed by death. The anhydrous acid boils at $19^\circ.5\text{C}$. (H. Moissan), and on cooling, sets to a solid mass at $-102^\circ.5\text{C}$., which melts at $-92^\circ.3\text{C}$. (K. Olszewski, *Monats. für Chemie*, 1886, 7, p. 371). Potassium and sodium readily dissolve in the anhydrous acid with evolution of hydrogen and formation of

fluorides. The aqueous solution is strongly acid to litmus and dissolves most metals directly. Its most important property is that it rapidly attacks glass, reacting with the silica of the glass to form gaseous silicon fluoride, and consequently it is used for etching. T. E. Thorpe (*Jour. Chem. Soc.*, 1889, 55, p. 163) determined the vapour density of hydrofluoric acid at different temperatures, and showed that there is no approach to a definite value below about 88° C. where it reaches the value 10.29 corresponding to the molecular formula HF; at temperatures below 88° C. the value increases rapidly, showing that the molecule is more complex in its structure. (For references see J. N. Friend, *The Theory of Valency* (1909), p. 111.) The aqueous solution behaves on concentration similarly to the other halogen acids; E. Deussen (*Zeit. anorg. Chem.*, 1905, 44, pp. 300, 408; 1906, 49, p. 297) found the solution of constant boiling point to contain 43.2% HF and to boil at 110° (750 mm.).

The salts of hydrofluoric acid are known as *fluorides* and are easily obtained by the action of the acid on metals or their oxides, hydroxides or carbonates. The fluorides of the alkali metals, of silver, and of most of the heavy metals are soluble in water; those of the alkaline earths are insoluble. A characteristic property of the alkaline fluorides is their power of combining with a molecule of hydrofluoric acid and with the fluorides of the more electro-negative elements to form double fluorides, a behaviour not shown by other metallic halides. Fluorides can be readily detected by their power of etching glass when warmed with sulphuric acid; or by warming them in a glass tube with concentrated sulphuric acid and holding a moistened glass rod in the mouth of the tube, the water apparently gelatinizes owing to the decomposition of the silicon fluoride formed. The atomic weight of fluorine has been determined by the conversion of calcium, sodium and potassium fluorides into the corresponding sulphates. J. Berzelius, by converting silver fluoride into silver chloride, obtained the value 19.44, and by analysing calcium fluoride the value 19.16; the more recent work of H. Moissan gives the value 19.05.

See H. Moissan, *Le Fluor et ses composés* (Paris, 1900).

FLUOR-SPAR, native calcium fluoride (CaF_2), known also as **FLUORITE** or simply **FLUOR**. In France it is called *fluorine*, whilst the term *fluor* is applied to the element (F). All these terms, from the Lat. *fluere*, "to flow," recall the fact that the spar is useful as a flux in certain metallurgical operations. (Cf. its Ger. name *Flussspat* or *Fluss*.)

Fluor-spar crystallizes in the cubic system, commonly in cubes, either alone or combined with the octahedron, rhombic dodecahedron, four-faced cube, &c. The four-faced cube has been called the fluoroid. In fig. 1, *a* is the cube (100), *d* the

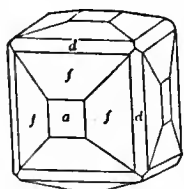

FIG. 1.

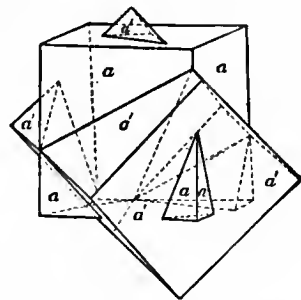

FIG. 2.

rhombic dodecahedron (110), and *f* the four-faced cube (310). Fig. 2 shows a characteristic twin of interpenetrant cubes. The crystals are sometimes polysynthetic, a large octahedron, e.g., being built up of small cubes. The faces are often etched or corroded. Cleavage is nearly always perfect, parallel to the octahedron.

Fluor-spar has a hardness of 4, so that it is scratched by a knife, though not so readily as calcite. Its specific gravity is about 3.2. The colour is very variable, and often beautiful, but the mineral is too soft for personal decoration, though it forms a handsome material for vases, &c. In some fluor-spar the colour is disposed in bands, regularly following the contour of the crystal. As the colour is usually expelled, or much altered, by heat, it is believed to be due to an organic pigment, and the presence of hydrocarbons has been detected in many specimens by G. Wyruboff, and other observers. H. W. Morse (*Proc. Amer. Acad.*, 1906, p. 587)

obtained carbon monoxide and dioxide, hydrogen and nitrogen and small quantities of oxygen from Weardale specimens by heating. He concluded that the gases are due to the decomposition of an organic colouring matter, which has, however, no connexion with the fluorescence or thermo-luminescence of the mineral. Certain crystals from Cumberland are beautifully fluorescent, appearing purple with a bluish internal haziness by reflected light, and greenish by transmitted light. Fluor-spar, though cubic, sometimes exhibits weak double refraction, probably due to internal tension. Many kinds of fluor-spar are thermo-luminescent, i.e. they glow on exposure to a moderate heat, and the name of chlorophane has been given to a variety which exhibits a green glow. The mineral also phosphoresces under the Röntgen rays. Cavities containing liquid occasionally occur in crystals of fluor-spar, notably in the greasy green cubes of Weardale in Durham. A dark violet fluor-spar from Wölsendorf in Bavaria, evolves an odour of ozone when struck, and has been called antozonite. Ozone is also emitted by a violet fluor-spar from Quincié, dep. Rhône, France. In both cases the spar evolves free fluorine, which ozonizes the air.

Fluor-spar is largely employed by the metallurgist, especially in lead-smelting, and in the production of ferro-silicon and ferro-manganese. It is also used in iron and brass foundries, and has been found useful as a flux for certain gold-ores and in the reduction of aluminium. It is used as a source of hydrofluoric acid, which it evolves when heated with sulphuric acid. The mineral is also used in the production of opal glass and enamel ware. In consequence of its low refractive and dispersive power, colourless pellucid fluor-spar is valuable in the construction of apochromatic lenses, but this variety is rare. The dark violet fluor-spar of Derbyshire, known locally as "Blue John," is prized for ornamental purposes. It occurs almost exclusively at Tray Cliff, near Castleton. The dark purple spar, called by the workmen "bull beef," may be changed, by heat, to a rich amethystine tint. Being very brittle, the spar is rather difficult to work on the lathe, and is often toughened by means of resin. F. Corsi, the eminent Italian antiquary, held that fluor-spar was the material of the famous murrhine vases.

Fluor-spar is a mineral of very wide distribution. Some of the finest crystals occur in the lead-veins of the Carboniferous Limestone series in the north of England, especially at Weardale, Allendale and Alston Moor. It is also found in the lead and copper-mines of Cornwall and S. Devon, notably near Liskeard, where fine crystals have been found, with faces of the six-faced octahedron replacing the corners of the cube. In Cornwall fluor-spar is known to the miners as "cann." Fine yellow fluor-spar occurs in some of the Saxon mines, and beautiful rose-red octahedra are found in the Alps, near Göschenen. Many localities in the United States yield fluor-spar, and it is worked commercially in a few places, notably at Rosiclare in southern Illinois.

FLUSHING, formerly a township and a village of Queens county, New York, U.S.A., on Long Island, at the head of Flushing Bay, since the 1st of January 1898 a part of the borough of Queens, New York City. Flushing is served by the Long Island railroad and by electric lines. It was settled in 1644 by a company of English non-conformists who had probably been residents of Flushing in Holland, from which the new place took its name. Subsequently a large number of Quakers settled here, and in 1672 George Fox spent some time in the township. Before the War of Independence Flushing was the country-seat of many rich New Yorkers and colonial officials.

FLUSHING (Dutch *Vlissingen*), a fortified seaport in the province of Zeeland, Holland, on the south side of the island of Walcheren, at the mouth of the estuary of the western Scheldt, 4 m. by rail S. by W. of Middelburg, with which it is also connected by steam tramway and by a ship canal. There is a steam ferry to Breskens and Ter Neuzen on the coast of Zeeland-Flandres. Pop. (1900) 18,893. An important naval station and fortress up to 1867, Flushing has since aspired, under the care of the Dutch government, to become a great commercial port. In 1872 the railway was opened which, in conjunction

with the regular day and night service of steamers to Queenborough in the county of Kent, forms one of the main routes between England and the east of Europe. In 1873 the great harbour, docks and canal works were completed. Yet the navigation of the port remains far behind that of Rotterdam or Antwerp, the tonnage being in 1899 about 7.9% of that of the kingdom. As a summer resort, however, Flushing has acquired considerable popularity, sea-baths and a large modern hotel being situated on the fine beach about three-quarters of a mile north-west of the town. It possesses a town hall, containing a collection of local antiquities, a theatre, an exchange, an academy of sciences and a school of navigation. The Jakobskerk, or Jacob's church, founded in 1328, contains monuments to Admiral de Ruyter (1607-1676) and the poet Jacob Bellamy (1757-1786), who were natives of Flushing. The chief industries of the town are connected with the considerable manufacture of machinery, the state railway-workshops, shipbuilding yards, Krupp iron and steel works' depot, brewing, and oil and soap manufacture. The chief imports are colonial produce and wine, wood and coal. The exports include agricultural produce (wheat and beans), shrimps and meat.

FLUTE, a word adapted from O. Fr. *flûte*, modern *flûte*; from O. Fr. have come the Span. *flauta*, Ital. *flauto* and Ger. *Flöte*. The *New English Dictionary* dismisses the derivations suggested from Lat. *flutare* or *flavitare*; ultimately the word must be referred to the root seen in "blow," Lat. *flare*, Ger. *blasen*, &c.

1. In music "flute" is a general term applied to wood-wind instruments consisting of a pipe pierced with lateral holes and blown directly through the mouthpiece without the intervention of a reed. The flute family is classified according to the mouthpiece used to set in vibration the column of air within the tube: *i.e.* (1) the simple lateral mouth-hole or embouchure which necessitates holding the instrument in a transverse position; (2) the whistle or fipple mouthpiece which allows the performer to hold the instrument vertically in front of him. There is a third class of pipes included among the flutes, having no mouthpiece of any sort, in which the column of air is set in vibration by blowing obliquely across the open end of the pipe, as in the ancient Egyptian nay, and the pan-pipe or syrinx (*q.v.*). The transverse flute has entirely superseded the whistle flute, which has survived only in the so-called penny whistle, in the "flute-work" of the organ (*q.v.*), and in the French flageolet.

The *Transverse Flute* or *German Flute* (Fr. *flûte traversière*, *flûte allemande*; Ger. *Flöte*, *Querflöte*, *Zwerchpfeiff*, *Schweitzerpfeiff*; Ital. *flauto traverso*) includes the *concert flute* known both as flute in C and as flute in D, the piccolo (*q.v.*) or octave flute, and the fife (*q.v.*). The modern flute consists of a tube open at one end and nominally closed at the other by means of a plug or cork stopper: virtually, however, the tube is an open one giving the consecutive harmonic series of the open pipe or of a stretched string. The primitive flute was made in one piece, but the modern instrument is composed of three adjustable joints. (1) The head-joint, plugged at the upper end and containing at about one-third of the length the mouth-hole or embouchure. This embouchure, always open when the instrument is being played, converts the closed tube into an open one, in an acoustical sense. (2) The body, containing the holes and keys necessary to produce the scale which gave the flute its original designation of D flute, the head and body together, when the holes are closed, giving the fundamental note D. Before the invention of keys, this fundamental note and the notes obtained by the successive opening of the six holes produced the diatonic scale of D major. All other semitones were obtained by what is known as cross fingering (Fr. *doigté fourchu*; Ger. *Gabelgriffe*). It became usual to consider this the typical fingering nomenclature, whatever the fundamental note given out by the flute, and to indicate the tonality by the note given out when the six lateral holes are covered by the fingers. The result is that the tonality is always a tone lower than the name of the instrument indicates. Thus the D flute is really in C, the F flute is E♭, &c. (3) The foot-joint or tail-joint containing the two additional keys for C♯ and C which extend the

compass downwards, completing the chromatic scale of C in the fundamental octave.

The compass of the modern flute is three octaves with

chromatic semitones from . The sound is pro-

duced by holding the flute transversely with the embouchure turned slightly outwards, the lower lip resting on the nearer edge of the embouchure, and blowing obliquely across, not into, the orifice. The flat stream of air from the lips, known as the air-reed, breaks against the sharp outer edge of the embouchure. The current of air, thus set in a flutter, produces in the stationary column of air within the tube a series of pulsations or vibrations caused by the alternate compression and rarefaction of the air and generating sounds of a pitch proportional to the length of the stationary column, which is practically somewhat longer than the length of the tube.¹ The length of this column is varied by opening the lateral finger-holes. The current or air-reed thus acts upon the air column within the flute, without passing through the tube, as a plectrum upon a string, setting it in vibration. The air column of the flute is the sound-producer, whereas in instruments with reed mouthpieces the vibrating reed is more properly the sound-producer, while the air column, acting as a resonating medium, reinforces the note of the reed by vibrating synchronously with it. If the angle² at which the current of air is directed against the outer edge of the embouchure be made less acute and the pressure of the breath be at the same time increased, the frequency of the alternate pulses of compression and rarefaction within the tube will be increased two, three or fourfold, forming a corresponding number of nodes and loops which results in harmonics or upper partials, respectively the octave, the twelfth, the double octave. By this means sounds of higher pitch are produced without actually shortening the length of the column of air by means of lateral holes. The acoustic theory of sound-production in the flute is one on which there is great diversity of opinion. The subject is too vast to be treated here, but readers who wish to pursue it may consult the works of Rockstro,³ Helmholtz,⁴ and others.⁵ The effect of boring lateral holes in pipes is to shorten the vibrating length of the air column, which may be regarded as being effective only between the hole in question and the mouthpiece. In order to obtain this result the diameter of the hole should be equal to that of the bore; as long as the holes were covered by the fingers, this was obviously impossible. The holes, therefore, being smaller than the laws of acoustics demand, have to be placed proportionally nearer the mouthpiece in order to avoid deepening the pitch and deadening the tone. This principle was understood by wind-instrument makers of classic Greece (see *AULOS* and *CLARINET*), and has been explained by Chladni⁶ and Gottfried Weber.⁷

The bore of the early flute with six finger-holes was invariably cylindrical throughout, but towards the end of the 17th century a modification took place, the head joint alone remaining cylindrical while the rest of the bore assumed the form of a cone having its smallest diameter at the open end of the tube. The

¹ See E. F. F. Chladni, *Die Akustik* (Leipzig, 1802), p. 87.

² See Sonreck, "Über die Schwingungserregung und die Bewegung der Luftsäule in offenen und gedeckten Röhren," *Pogg. Ann.*, 1876, vol. 158.

³ *The Flute* (London, 1890), § 90-105, pp. 34-40.

⁴ *Theorie der Luftschwingungen in Röhren mit offenen Enden* (Berlin, 1896). Ostwald's *Klassiker der exacten Wissenschaften*, No. 80.

⁵ V. C. Mahillon, *Experimental Studies on the Resonance of Trunc-Conical and Cylindrical Air Columns*, translated by F. A. Mahan (London, 1901); D. J. Blaikley, *Acoustics in Relation to Wind Instruments* (London, 1890); Friedrich Zammer, *Die Musik und die musikalischen Instrumente, &c.* (Giessen, 1855); *idem*. "Sur le mouvement vibratoire de l'air dans les tuyaux," *Comptes rendus*, 1855, vol. 41, &c.

⁶ *Op. cit.*, § 73, pp. 87-88, note 1.

⁷ "Akustik der Blasinstrumente," *Allgem. musikal. Zeit.* (Leipzig, 1816), Bd. xviii. No. 5, p. 65 et seq. See also Ernst Euting, *Zur Geschichte der Blasinstrumente im 16. und 17. Jahrhundert*. Inaugural Dissertation, Friedrich-Wilhelms Universität. (Berlin, 15th of March 1899), p. 9.

conoidal bore greatly improved the quality of tone and the production of the higher harmonics of the third octave. Once the conical bore had been adopted, the term flute was exclusively applied to the new instruments, the smaller flutes, then cylindrical, used in the army being designated *fife* (*q.v.*). At



From Captain Day's *Catalogue, &c.*, by permission of Messrs. Eyre & Spottiswoode.

FIG. 1.—Eight-keyed Cone Flute by Richard Potter. 18th century.



Messrs. Rudall, Carte & Co.

FIG. 2.—Boehm Cylinder Flute. Rockstro Model.

the present day in England, France and America, the favourite mode of construction is that introduced by Theobald Boehm, and known as the "cylinder flute with the parabolic head," of which more will be said further on. The successive opening of the holes and keys on the flute produces the chromatic scale of the first or fundamental octave. By increasing the pressure of the breath and slightly altering the position of the lips over the mouth-hole, the same fingering produces the notes of the fundamental octave in the next octave higher. The third octave of the compass is obtained by the production of the higher harmonics (Fr. *sons harmoniques*; Ger. *Flageolettöne*), of the fundamental scale, facilitated by the opening of certain of the finger-holes as "vent holes." The quality of tone depends somewhat on the material of which the flute is made; silver and gold produce a liquid tone of exquisite delicacy suitable for solo music, cocus-wood and chonite a rich mellow tone of considerable power suitable for orchestral music. The tone differs further in the three registers, the lowest being slightly rough, the medium sweet and elegiac, and the third bird-like and brilliant. The proportions, position and form of the stopper and of the air chamber situated between it and the embouchure are mainly influential in giving the flute its peculiar slightly hollow timbre, due to the paucity of the upper partials of which according to Helmholtz¹ only the octave and twelfth are heard. Mr Blaikley² states, however, that when the fundamental D is played, he can discern the seventh partial. The technical capabilities of the flute are practically unlimited to a good player who can obtain sustained notes diminuendo and crescendo, diatonic and chromatic scales and arpeggios both legato and staccato, leaps, turns, shakes, &c. By the articulation with the tongue of the syllables *te-ke* or *ti-ke* repeated quickly for groups of double notes, or of *te-ke-li* for triplets, an easy effective staccato is produced, known respectively as *double* or *triple tonguing*, a device understood early in the 16th century and mentioned by Martin Agricola,³ who gives the syllables as *de* for sustained notes, *di-ri* for shorter notes, and *lel-lel-lel* for staccato passages in quick tempo.⁴

Musical instruments, such as flutes, in which a column of air is set in vibration by regular pulsations derived from a current of air directed by the lips of the executant against the side of the orifice serving as embouchure, appear to be of very ancient origin. The Hindus, Chinese and Japanese claim to have used these modes of blowing from time immemorial. The ancient Egyptians had a long pipe held obliquely and blown across the end of the pipe itself at its upper extremity; it was known as *Saib-it*⁵ and was frequently figured on the monuments. The same instrument, called "nay," is still used in Mahomedan countries. The oblique aulos of the

Greeks, *plagiaulos*,⁶ was of Egyptian origin and was perhaps at first blown from the end as described above,⁷ since we know that the Greeks were familiar with that method of blowing in the syrinx or pan-pipe. The instruments preserved at the British Museum⁸ having lateral embouchures show, however, that they were also acquainted—probably through the Hindus—with the transverse flute, although in the case of these specimens a reed must have been inserted into the mouth-hole or no sound would have been obtained.

The high antiquity of a lateral embouchure in Europe is generally admitted; the flute evidently penetrated from the East at some period not yet determined. A transverse flute is seen on Indian sculptures of the Gandhara school showing Greek influence, and dating from the beginning of our era (fig. 3). But although the transverse flute was evidently known to the Greeks and Romans, it did not find the same favour as the reed instruments known as *auloi*. We have no evidence of the survival of the transverse flute after the fall of the Roman empire until it filtered through from Byzantine sources



FIG. 3.—Transverse Flute. 1st or 2nd century A.D. From the Tope at Amarabati, British Museum.

during the early middle ages. Instances of the flute occur on a group of caskets⁹ of Italo-Byzantine work of the 9th or 10th century, while of purely Byzantine origin we find examples of flutes in Greek

⁶ See Albert A. Howard, "The Aulos or Tibia," *Harvard Studies*, iv. (Boston, 1893), pp. 16-17.

⁷ Representations of flutes as here described have been found in Europe. See *Comptes rendus de la commission impériale archéologique* (St Petersburg, 1867), p. 45, and atlas for the same date, pl. vi. Pompeian painting given by Helbig, *Wandgemälde*, No. 7607; Zahn, vol. iii. pl. 31; Museo Borbonico, pl. xv. No. 18; Clarac, pl. 130, 131, 139; Heuzey, *Les Figurines*, p. 136.

⁸ There are two flutes at the British Museum (Catal. No. 84, 4-9 and 5 and 6), belonging to the Castellani collection, made of wood encased in bronze in which the mouthpiece, consisting of the head of a maenad, has a lateral hole bored obliquely into the main tube. This hole was probably intended for the reception of a reed. The pipe is stopped at the end beyond the mouthpiece as in the modern flute. There are six holes. See also the *plagiaulos* from Halicarnassus in the British Museum described by C. T. Newton in *History of Discoveries at Halicarnassus* (London), vol. ii. p. 339. The Louvre has two ancient statues (from the villa Borghese) representing satyrs playing upon transverse flutes. Unfortunately these marbles have been restored, especially in the details affecting our present subject, and are therefore examples of no value to us. Another statue representing a flute-player occurs in the British Museum. The instrument has been supposed to be a transverse flute, but erroneously, for the insufflation of the lateral tube against which the instrumentalist presses his lips, could not, without the intervention of a reed, excite the vibratory movement of the column of air.

⁹ Florence, Carrand Collection. See Museo Nazionale Firenze, *Catalogo* (1898), p. 205, No. 26 (description only). Illustration in *Gallerie nazionali italiane*, A. Venturi, vol. iii. (1897), p. 263, *L'Arte* (Rome, 1894), vol. i. p. 24. Hans Graeven, "Antike Vorlagen byzantinischer Elfenbeinreliefs," in *Jahrb. d. K. Preuss. Kunst-Sammlungen* (Berlin, 1897), Bd. xviii. p. 11; Hans Graeven, "Ein Reliquienkästchen aus Pirano," *id.*, 1899, Bd. xx. fig. 2 and pl. iii.

¹ *Lehre von der Tonempfindung* (Braunschweig, 1877).

² See additions by D. J. B. to article "Flute" in *Grove's Dictionary of Music and Musicians* (London, 1904).

³ *Musica instrumentalis deutsch* (Wittenberg, 1528).

⁴ See also L'Artusi, *Delle imperfettioni della musica moderna* (Venice, 1600), p. 4; Gottfried Weber in *Cäcilia*, Bd. ix. p. 99.

⁵ See "Les Anciennes Flûtes égyptiennes," by Victor Loret in *Journal asiatique* (Paris, 1889), vol. xiv. p. 133 et seq., two careful articles based on the ancient Egyptian instruments still extant. See also Lauth, "Über die ägyptische Instrumente," *Sitzungs. der philos., philolog. und histor. Klasse. der Kgl. bayer. Akad. zu München* (1873).

MSS.¹ preserved in Paris, at the British Museum and elsewhere. There is moreover in the cathedral of St Sophia at Kiev² an orchestra depicted on frescoes said to date from the 11th century; among the musicians is a flautist.

The first essentially western European trace of the transverse flute occurs in a German MS. of the 12th century, the celebrated *Hortus deliciarum* of the abbess Herrad von Landsberg.³ Fol. 221 shows a syren playing upon the transverse flute, which Herrad explains in a legend as *tibia*; in the vocabulary the latter is translated *swegel*. In the 13th century it occurs among the miniatures of the fifty-one musicians in the beautiful MS. *Las Cantigas de Santa Maria* in the Escorial, Madrid.⁴ Eustache Deschamps, a French poet of the 14th century, in one of his ballads, makes mention of the "flute traversaine," and we are justified in supposing that he refers to the transverse flute. It had certainly acquired some vogue in the 15th century, being figured in an engraving in Sebastian Virdung's celebrated work⁵, where it is called "Zwerchpfeiff," and, with the drums, it already constituted the principal element of the military music. Agricola (*op. cit.*) alludes to it as the "Querhpfeiff" or "Schweizerpfeiff," the latter designation dating, it is said, from the battle of Marignan (1515), when the Swiss troops used it for the first time in war.

From Agricola onwards transverse flutes formed a complete family, said to comprise the discant, the alto and tenor, and the bass—

respectively. Praetorius⁶ designates the transverse flute as "Flauta traversa" Querhpfeiff" and "Querflöt," and gives the

pitch of the bass in the tenor and the alto in the discant and the alto in use. A flute concert at that time included two discants, four altos or tenors, and two basses. The same author distinguishes between the "Traversa" and the "Schweizerpfeiff" or fife (which he also calls "Feldpfeiff," i.e. military flute), although the construction was the same. There were two kinds of "Feldpfeiff," in

Mersenne's⁷ account of the transverse flute, then designated "flûte d'Allemagne" or "flûte allemande" in France, and an "Air de Cour" for four flutes in his work lead us to believe that there were then in use in France the soprano flute in the tenor and the alto flute in the bass

The museum of the Conservatoire Royal of Brussels possesses specimens of all these varieties except the last. All of them are laterally pierced with six finger-holes; they have a cylindrical bore, and are fashioned out of a single piece of wood. Their compass consists of two octaves and a fifth. Mersenne's tablature for fingering the flute differs but little from those of Hotteterre-le-Romain⁸ and Eisel⁹ for the diatonic scale; he does not give the chromatic semitones and the flute had as yet no keys.

The largest bass flute in the Brussels museum is in the French normal pitch A 435 double vibrations per second. It measures 0.95 m. from the centre of the blow orifice to

the lower extremity of the tube. The disposition of the lateral holes is such that it is impossible to cover them with the fingers if the flute is held in the ordinary way. The instrument must be placed against the mouth in an almost vertical direction, inclining the extremity of the tube either to the right or the left. This inconvenient position makes it necessary that the instrument should be divided into two parts, enabling the player to turn the head joint that the embouchure may be most commodiously approached by the lips, which is not at all easy. The first and fourth of the six lateral holes are double in order to accommodate both right- and left-handed players, the holes not in use being stopped up with wax. The bass flute shown in fig. 4 is the facsimile of an instrument in the Museo Civico of Verona. The original, unfortunately no longer fit for use, is nevertheless sufficiently well preserved to allow of all its proportionate measurements being given. The lowest note, Eb, is obtained with a remarkable amplitude of sound, thus upsetting a very prevalent opinion that it is impossible to produce by lateral insufflation sounds which go a little lower than the ordinary limit downwards of the modern orchestral flute.¹⁰

The bass flute cited by Mersenne should not differ much from that of the Museo Civico at Verona. We suppose it to have been in use, and that it was furnished with an open key like that which was applied to the recorders (*flûtes douces*) of the same epoch, the function of the key being to augment by another note the compass of the instrument in the lower part. A bass flute in G similar to the one in fig. 5 is figured and described in Diderot and D'Alembert's encyclopaedia¹¹ (1751). According to Quantz,¹² it was in France and about the middle of the 17th century that the first modifications were introduced in the manufacture of the flute. The improvements at this period consisted of the abandonment of the cylindrical bore in favour of a conical one, with the base of the cone forming the head of the instrument. At the same time the flute was made of three separate pieces called head, body, and tail or foot, which were ultimately further subdivided. The body or middle joint was divided into two pieces, so that the instrument could be tuned to the different pitches then in use by a replacement with longer or shorter pieces. It was probably about 1677, when Lully introduced the German flute into the opera, that recourse was had for the first time to keys, and that the key of D# was applied to the lower part of the instrument.¹³ The engraving of B. Picart, dated 1707, given in Hotteterre's book, represents the flute as having reached the stage of improvement of which we have just spoken. In 1726 Quantz,¹⁴ finding himself in Paris, had a second key applied to the flute, placed nearly at the same height as the first, that of the Eb, intended to differentiate the D# and the Eb.¹⁵ This innovation was generally well received in Germany, but does not appear to have met with corresponding success in other countries. In France and England manufacturers adopted it but rarely; in Italy it was declared useless.¹⁶ About the same

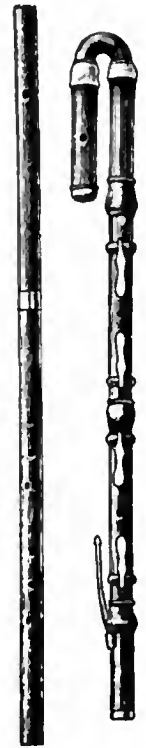

FIG. 4.—Bass Flute. From Museo Civico, Verona (facsimile). FIG. 5.—Bass Flute. Brussels Museum.

¹ Greek MS. 510, Grégoir de Nazance 10th century, Bibliothèque Nationale, Paris; illustration in Gustave L. Schlumberger, *L'Épopée byzantine à la fin du dixième siècle* (Paris, 1896 and 1900), vol. i. p. 503. British Museum, Greek Psalter, add. MS. 19352, fol. 189b. written and illuminated *cir.* 1066 by Theodorus of Caesarea. A cylindrical flute is shown turned to the right, the left hand being uppermost. Smyrna, Library of the Evaggelike Schole B. 18, fol. 72a, A.D. 1100, illustration by Strzygowski, "Der Bilderkreis des griechischen Physiologus," in *Byzantinisches Archiv* (Leipzig, 1899), Heft 2, Taf. xi.; N. P. Kondakoff, *Histoire de l'art byzantin* (Paris, 1886 and 1891), pl. xii. 5; "Kuseyr' Amra," issued by K. Akad. d. Wissenschaften (Vienna, 1907), vol. ii. pl. xxxiv.

² A fine volume containing coloured drawings of these frescoes has been published in St Petersburg (British Museum library catalogue, sect. "Academies," St Petersburg, 1874-1887, vol. iv. Tab. 1325a).

³ This manuscript, written towards the end of the 12th century, was preserved in the Strassburg library until 1870, when it was burnt during the bombardment of the city. See the fine reproduction in facsimile published by the *Soc. pour la conservation des monuments historiques d'Alsace*. Texte explicatif de A. Straub and G. Keller (Strassburg, 1901), pl. lviii., also C. M. Engelhardt, *Herrad von Landsberg und ihr Werk* (Stuttgart and Tübingen, 1818), twelve plates.

⁴ MS. j. b. 2. Illustrated in *Critical and Bibliographical Notes on Early Spanish Music* (London, 1887), p. 119.

⁵ *Musica getutsch und ausgezogen* (Basel, 1511).

⁶ *Organographia* (Wolfenbüttel, 1618), pp. 24, 25, 40.

⁷ *Harmonie universelle* (Paris, 1636), Livre v. p. 241.

⁸ *Principes de la flûte traversière ou flûte d'Allemagne, de la flûte à bec et du hautbois* (Paris, 1722), p. 38.

⁹ *Musicus airodōdaxrōs oder der sich selbst informierende Musicus* (Erfurt, 1738), p. 85.

¹⁰ Féris, *Rapport sur la fabrication des instruments de musique à l'Exposition Universelle de Paris, en 1855*.

¹¹ See *Recueil de planches*, vol. iv., and article "Basse de flûte traversière," vol. ii. (Paris, 1751). See also *The Flute*, by R. S. Rockstro (London, 1890), p. 238, where the wood cut is reproduced together with a translation of the article. The Museum of the Conservatoire in Paris also possesses a bass flute by the noted French maker Delusse.

¹² *Versuch einer Anweisung die Flöte traversière zu spielen* (Berlin, 1752).

¹³ Unless the contrary is stated, we have always in view, in describing the successive improvements of the flute, the treble flute in D, which is considered to be typical of the family.

¹⁴ "Herrn Johann Joachim Quantzens-Lebenslauf, von ihm selbst entworfen," in the *Historisch-Kritische Beyträge zur Aufnahme der Musik*, by Marpurg (Berlin, 1754), p. 239. Quantz was professor of the flute to Frederick the Great.

¹⁵ See Johann Georg Tromlitz, *Ausführlicher und gründlicher Unterricht die Flöte zu spielen* (Leipzig, 1791), 1, § 7, and *Über Flöten mit mehrern Klappen* (Leipzig, 1800), cap. vii. § 21.

¹⁶ Antonio Lorenzoni, *Saggio per ben sonare il flauto traverso* (Vicenza, 1779).

time flutes were constructed with the lower extremity lengthened sufficiently to produce the fundamental C, and furnished with a supplementary key to produce the C#. This innovation, spoken of by Quantz¹ did not meet with a very favourable reception, and was shortly afterwards abandoned. Passing mention may be made of the drawing of a flute with a C key in the *Music-Saal* of J. F. B. Majer (Nuremberg, 1741), p. 45.

The tuning of the instrument to different pitches was effected by changes in the length, and notably by substituting a longer or shorter upper piece in the middle joint. So wide were the differences in the pitches then in use that seven such pieces for the upper portion of it were deemed necessary. The relative proportions between the different parts of the instrument being altered by these modifications in the length, it was conceived that the just relation could be re-established by dividing the foot into two pieces, below the key. These two pieces were adjusted by means of a tenon, and it was asserted that, in this way, the foot could be lengthened proportionately to the length of the middle joint. Flutes thus improved took the name of "flûtes à registre." The register system was, about 1752, applied by Quantz to the head joint² and, the embouchure section being thus capable of elongation, it was allowable to the performer, according to the opinion of this professor, to lower the pitch of the flute a semitone, without having recourse to other lengthening pieces, and without disturbing the accuracy of intonation.

The upper extremity of the flute, beyond the embouchure orifice, is closed by means of a cork stopper. On the position of this cork depends, in a great measure, the accurate tuning of the flute. It is in its right place when the accompanying octaves are true. Quantz, in speaking of this accessory, mentions the use of a nut-screw to give the required position to the cork.³ He does not name the inventor of this appliance, but, according to Tromlitz,⁴ the improvement was due to Quantz himself. The invention goes back to 1726.

When the *Method* of Quantz appeared there were still in use, besides the orchestral flute in D, the little fourth flute in G, the low fourth flute in A, and the flûte d'amour a note higher; in France they had, moreover, the little octave flute in D (octave). A bass flute in D had also been attempted (see fig. 5). When Ribock published his *Bemerkungen über die Flöte*⁵ the flute had already the five keys here shown.

This author states that the inventor of these new keys is not known to him, but that either Kusder, a musical instrument-maker in London, or Johann Georg Tromlitz of Leipzig was the originator, since he has not been able to trace those keys on the flutes of any other maker. Although Tromlitz does not claim for himself the invention of the keys for F, G# and Bb, he states that "he had occupied himself for several years in applying these keys so as not to augment the difficulty of playing, but on the contrary to render the handling of them as easy as possible."⁶ In the later work published in 1800,⁷ however, he seems to attribute the invention of these keys to Richard Potter of London; he says that he has never yet been fortunate enough to come across a good flute by that maker—"the flute has certainly gained by the addition of the keys for F, G# and Bb, but this is not everything, for on such a flute much must perforce be left unattempted. . . . Only a flute with eight keys according to my invention is capable of everything." It would seem, moreover, from circumstantial evidence stated clearly and on good authority by Rockstro⁸ that the keys for F, G# and Bb must have been used first in England and made by Richard Potter before 1774. The higher key of C adopted from 1786 by Tromlitz, we believe to have been first recommended by Ribock (1782).⁹ Tromlitz in *Über Flöten* describes at length what may be termed the first systematic effort to overcome the difficulties created by the combination of open holes and closed keys. He attempted to solve the question by determining the positions of the holes according to the exigencies of fingering instead of subordinating them to the more arbitrary theories connected with the musical scale.

In 1785 Richard Potter improved Quantz's slide applied to the head joint as well as to the register of the foot by a double system of tubes forming double sliding air-tight joints. In the document¹⁰ describing this improvement Potter patented the idea of lining the holes with silver tubes and of adapting metal conical valves to the keys. Potter's patent conical valves were an adaptation of the contrivance first invented by J. F. Boie or Boye of Göttingen,¹¹

who used pewter for the plugs, and silver for lining the holes. The keys mentioned in the patent were four—D#, F, G#, A#. The idea of extending the compass of the flute downwards was taken up again about the same time by two players of the flute in London named Tacet and Florio. They devised a new disposition of the keys C and C#, and confided the execution of their invention to Potter. In Dr Arnold's *New Instructions for the German Flute* occurs a tablature, the engraving of which goes back to the end of the 18th century, and bears the following title, "A Complete Drawing and Concise Scale and Description of Tacet and Florio's new invented German Flute, with all the additional keys explained." It explains the use of six keys—C, C#, D#, F, G#, A#—that are not always figured, because the employment of so many keys was at once admitted. Tromlitz himself, who, however, made flutes with nine keys—adding Eb, another F, and C#, declared that he was not in favour of so great a complication, and that he preferred the flute with only two keys, D# and Eb, with a register foot joint and a cork nut-screw at the head joint. This instrument met all requirements. He was always much opposed to the use of the old keys for C# and C#, because they altered the recognised quality of tone of the instrument. When Tromlitz published his method, the family of flutes had become modified. It comprehended only the typical flute in D, the flûte d'amour a minor third lower, a "third" flute a minor third higher, and, finally, the little octave flute.

While Tromlitz was struggling in Germany with the idea of augmenting the compass of the flute downwards by employing open keys for C# and C#, an Italian, Giovanni Batista Orazi,¹² increased the scale of the instrument downwards by the application of five new keys, viz. B, Bb, A, Ab, and G. At the same time that he produced this invention¹³ he conceived the plugging of the lateral holes by the valve keys then recently invented by Potter. But it was hardly possible to obtain a perfect plugging of seven lateral holes with the aid of as many keys, for the control of which there were only the two little fingers, and therefore this invention of Orazi proved a failure.

In 1808 the Rev. Frederick Nolan,¹⁴ of Stratford, near London, conceived an open key, the lever of which, terminating by a ring, permitted the closing of a lateral hole at the same time the key was being acted upon. The combination in this double action is the embryo of the mechanism that a little later was to transform the system of the flute. Two years later Macgregor,¹⁵ a musical-instrument maker in London, constructed a bass flute an octave lower than the ordinary flute. The idea was not new, as is proved by the existence of the bass flute mentioned above. The difference between the two instruments lies in the mechanism of the keys. That employed by Macgregor consisted of a double lever, a contrivance dating from before the middle of the 18th century, of which the application is seen in an oboe of large dimensions preserved in the National Museum at Munich.¹⁶

In 1811 Johann Nepomuk Capeller invented the extra D# hole and key, which is still in constant use on every flute of modern construction.¹⁷

About 1830 the celebrated French flautist Tulou added two more keys, those of F# and C#, and a key, called "de cadence," to facilitate the accompanying shakes.

To increase the number of keys, to improve their system of plugging, and to extend the scale of the instrument in the lower region, —these had hitherto been the principal problems dealt with in the improvement of the flute. No maker, no inventor to whose labours we have called attention, had as yet devoted his attention to the rational division of the column of air by means of the lateral holes. In 1831 Theobald Boehm, a Bavarian, happening to be in London, was struck with the power of tone the celebrated English performer Charles Nicholson drew from his instrument. Boehm learned, and not without astonishment, that his English colleague obtained this result by giving the lateral holes a much greater diameter than was then usually admitted. About the same time Boehm made the acquaintance of an amateur player named Gordon, who had effected certain improvements; he had bored the lateral hole for the lower E, and had covered it with a key, while he had replaced the key for F with a ring. These innovations set Boehm about attempting a complete reform of the

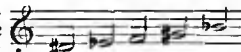
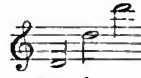

¹ See *Anweisung*, i. § 15.

² See *Lebenslauf*, loc. cit. p. 248, where Quantz states that he invented the adjustable head for the flute.

³ See *Anweisung*, i. §§ 10-13 and iv. § 26.

⁴ *Ausführlicher und gründlicher Unterricht die Flöte zu spielen* (Leipzig, 1791), i. cap. § 20. Compare Schilling, *Univ.-Lexikon* (Leipzig, 1835).

⁵ Stendal, 1782 (published under his initials only, J. J. H. R., see p. 2).

⁶ *Kurze Abhandlung von Flötenspielen* (Leipzig, 1786), p. 27.

⁷ *Über Flöten*, &c., pp. 133 and 134.

⁸ See *The Flute*, pp. 242-244 and 561 and 562.

⁹ See *op. cit.* pp. 51 and 62.

¹⁰ English patent, No. 1499. ¹¹ See Rockstro, *op. cit.* p. 197.

¹² *Saggio per costruire e suonare un flauto traverso enarmonico che ha i suoni bassi del violino* (Rome, 1797).

¹³ The idea of this large flute was taken up again in 1819 by Trexler of Vienna, who called it the "panaulon."

¹⁴ Patent, No. 3183. Part of the specification together with a diagram is reproduced by Rockstro, *op. cit.* pp. 273-274.

¹⁵ Patent, No. 3349. Part of the specification together with a diagram is reproduced by Rockstro, *op. cit.* pp. 273-274.

¹⁶ Another specimen, almost the same, constructed about 1775, and called "Basse de Musette," may be seen in the Museum of the Paris Conservatoire.

¹⁷ See account of Capeller's inventions by Carl Maria von Weber in *Allgem. musikal. Zeit.* (Leipzig, 1811), pp. 377-379, a translation of which is given by Rockstro, *op. cit.* pp. 279 and 280.

instrument.¹ He went resolutely to work, and during the year 1832 he produced the new flute which bears his name. This instrument is distinguished by a new mechanism of keys, as well as by larger holes disposed along the tube in geometrical progression.

Boehm's system had preserved the key of G \sharp open; Coche,² a professor in the Paris Conservatoire, assisted by Auguste Buffet the younger, a musical-instrument maker in that city, modified Boehm's flute by closing the G \sharp with a key, wishing thus to render the new fingering more conformable to the old. He thus added a key, facilitating the shake upon C \sharp with D \sharp , and brought about some other changes in the instrument of less importance.

Boehm had not, however, altered the bore of the flute, which had been conical from the end of the 17th century. In 1846, however, he made further experiments, and the results obtained were put in practice by the construction of a new instrument, of which the body was given a cylindrical bore, while the diameter of the head was modified at the embouchure, the head-joint becoming parabolic (see fig. 2). The inventor thus obtained a remarkable equality in the tones of the lower octave, a greater sonorousness, and a perfect accuracy of intonation, by establishing the more exact proportions which a column of air of cylindrical form permitted.

The priority of Boehm's invention was long contested, his detractors maintaining that the honour of having reconstructed the flute was due to Gordon. But an impartial investigation vindicates the claim of the former to the invention of the large lateral holes.³ His greatest title to fame is the invention of the mechanism which allows the production of the eleven chromatic semitones intermediate between the fundamental note and its first harmonic by means of eleven holes so disposed that in opening them successively they shorten the column of air in exact proportional quantities.⁴ Boehm (*Essays, &c.*) published a diagram or scheme to be adopted in determining the position of the note-holes of wind instruments for every given pitch. This diagram gives the position of the intermediate holes which he had been enabled to establish by a rule of proportion based on the law of the lengths of strings.

The Boehm flute, notwithstanding the high degree of perfection it has reached, has not secured unanimous favour; even now there are players who prefer the ordinary flute. The change of fingering required for some notes, the great delicacy and liability to derangement of the mechanism, have something to do with this. In England especially, the ordinary flute retains many partisans, thanks to the improvements introduced by a clever player, Abel Siccamo, in 1845 (Patent No. 10,553). He bored the lateral holes of E and A lower, and covered them with open keys. He added some keys, and made a better disposition of the other lateral holes, of which he increased the diameter, producing thus a sonorousness almost equal to that of the Boehm flute, while yet preserving the old fingering for the notes of the first two octaves. But in spite of these improvements the old flute will not bear an impartial comparison with that of Boehm.

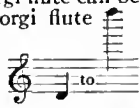
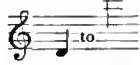
A flute constructed on a radically new system by Signor Carlo Tommaso Georgi and introduced in 1896 places the technique of the instrument on an entirely new and simple basis. The principal features of this flute consist in an embouchure placed at the upper extremity of the tube instead of at the side, which allows the instrument to be held in a perpendicular position; no tuning cork is required. There are eleven holes mathematically placed in the tube which give the semitones of the scale; there are no keys. The eleven holes are fingered by the fingers and thumbs, the C \sharp hole being closed by the side of the left fore-finger. All the notes are obtained by means of simple fingering as far as G \sharp of the third octave, the remaining notes of which are produced by cross-fingering. For the convenience of players with short fingers keys can be added, and the head of the Georgi flute can be used with any cylinder flute. The compass of the Georgi flute  is almost the same as that of the concert flute; viz.  If the lower C and C \sharp are required, extra holes and keys can be added. Everything that is possible on the Boehm flute is and more, owing to the simplicity of the fingering; each finger having but one duty to perform, all trills are equally easy. The tone is the true flute tone, brilliant and sympathetic.⁵

¹ See *Über den Flötenbau und die neuesten Verbesserungen desselben* (Mainz, 1847); and W. S. Broadwood, *An Essay on the Construction of Flutes originally written by Theobald Boehm, published with the addition of Correspondence and other Documents* (London, 1882).

² *Examen critique de la flûte ordinaire comparée à la flûte Boehm* (Paris, 1838).

³ They existed long before, however, in the Chinese *Ty* and the Japanese *Fuye*.

⁴ The reader may consult with advantage Mr C. Welch's *History of the Boehm Flute* (London, 1883), wherein all the documents relating to this interesting discussion have been collected with great impartiality.

⁵ For further details see Kathleen Schlesinger, *The Instruments of the Orchestra*, part i. pp. 192-194, where an illustration is given, and Paul Wetzger, *Die Flöte* (Heilbronn, 1906), pp. 23-24, and Tafel iv. No. 20.

The old English *fipple flute*, or *flûte à bec*, is described under the headings RECORDER and FLAGEOLET. (V. M.; K. S.)

2. In architecture the name "flute" is given to the vertical channels (segmental, semicircular or elliptical in horizontal section) employed on the shafts of columns in the classic styles. The flutes are separated one from the other by an "arris" in the Doric order and by a "fillet" in the Ionic and Corinthian orders. The earliest fluted columns are those in Egypt, at first with plain faces without any sinking, subsequently at Karnac (1400 B.C.) with a segmental sinking equal in depth to about one-seventh of the width of the flute. The columns flanking one of the "beehive" tombs at Mycenae have segmental flutes and are the earliest Greek examples. In two of the earliest Doric temples at Metapontum and Syracuse (temple of Apollo) the flutes are also segmental, but in later examples in order to emphasize the arris they were formed of three arcs and are known as "false ellipses," and this applies to nearly all the fluting in Greek examples whether belonging to the Doric, Ionic or Corinthian orders. The number of flutes varies, there being 52 in the archaic temple of Diana at Ephesus and from 30 to 52 flutes in the Persian columns according to the diameter of the column. In the Greek Doric column 20 is the usual number, but there are 16 only in the temples of Sunium, Assos, Segesta and the temple of Apollo at Syracuse; 18 in one of the temples of Selinus and the temple of Diana at Syracuse, and 24 in the temple of Neptune at Paestum. The depth of the flute also varies; in the Propylaea at Athens the radius is equal to the width of the flute and the flute is segmental. In the Parthenon the radius of the central part of the flute is greater than the width, but the smaller arcs on either side accentuate better the arris. A similar accentuation is found in the Ionic and Corinthian orders, where the flutes are separated by fillets, and their section is always elliptical in Greek work, the depth of the flute, however, being always greater than in the Doric order. Thus, in the temple of Ilissus and the Ionic column in the cella of the temple at Bassae, the depth is about one-quarter of the width, in the Propylaea at Priene it is about one-third, and in the Erechtheum and other examples of the Greek Ionic order it is little more than one-half. The width of the fillet also varies, being as a rule one quarter of the width of the flute; and the same applies to the Greek Corinthian order. In the Roman Doric, Ionic and Corinthian orders, the flute is either segmental or semicircular, its depth being about one-third of the width in the Doric column, and in all Ionic, Corinthian and Composite columns half the width of the flute. The fillet also is much broader in Roman examples, being about one-third of the width of the flute. In Roman columns sometimes the flutes of the lower part of the shaft, about one-third of the height, are partly filled with a convex moulding, "cabling" being the usual term applied to this treatment. The French architects of the 16th and 17th centuries carried this decorative feature much farther, and in the Tuileries and the Louvre carved a series of leaves in the flutes. In a few Italian buildings, instead of the fluting of the column being vertical, it twines round the column and is known as spiral fluting; a fine example is found in the Bevilacqua palace at Verona by San Michele. Fluting is sometimes introduced into capitals, as in the tomb of Mylasa, and in friezes, as in the theatre at Cnidos, the Incantada at Salonica, and a doorway at Patara. In one of the museums at Rome is a fine sarcophagus, the sides of which are sculptured with flutes in waved lines. The coronas of many of the Roman temples were carved with flutes. In mediæval buildings, fluting was occasionally introduced in imitation of Roman work, as in the churches of central Syria and of Autun and Langres in France, but in the south of Italy and Sicily it would seem to have been brought in as a variety of treatment in the decoration of the shafts carrying the arches of cloisters, as at Monreale in Sicily and in those of St John Lateran and St Paul-outside-the-Walls at Rome. (R. P. S.)

FLUX (Lat. *fluxus*, a flowing; this being also the meaning of the English term in medicine, &c.), in metallurgy, a substance introduced in the smelting of ores to promote fluidity, and to remove objectionable impurities in the form of a slag. The

substances in commonest use are:—lime or limestone, to slag off silica and silicates, fluor-spar for lead, calcium and barium sulphates and calcium phosphate, and silica for removing basic substances such as limestone. Other substances are also used, but more commonly in assaying than in metallurgy. Sodium and potassium carbonates are valuable for fluxing off silica; mixed with potassium nitrate sodium carbonate forms a valuable oxidizing fusion mixture; "black flux" is a reducing flux composed of finely divided carbon and potassium carbonate, and formed by deflagrating a mixture of argol with $\frac{1}{4}$ to $\frac{1}{2}$ its weight of nitre. Borax is very frequently employed; it melts to a clear liquid and dissolves silica and many metallic oxides. Potassium bisulphate is useful in the preliminary treatment of refractory aluminous ores. Litharge and red lead are used in silver and gold assays, acting as solvents for silica and any metallic oxides present.

FLY (formed on the root of the supposed original Teut. *fleugan*, to fly), a designation applied to the winged or perfect state of many insects belonging to various orders, as in butterfly (see LEPIDOPTERA), dragon-fly (*q.v.*), may-fly (*q.v.*), caddis-fly (*q.v.*), &c.; also specially employed by entomologists to mean any species of the two-winged flies, or DIPTERA (*q.v.*). In ordinary parlance *fly* is often used in the sense of the common house-fly (*Musca domestica*); and by English colonists and sportsmen in South Africa in that of a species of tsetse-fly (*Glossina*), or a tract of country ("belt") in which these insects abound (see TSETSE-FLY).

Apart from the house-fly proper (*Musca domestica*), which in England is the usual one, several species of flies are commonly found in houses; e.g. the *Stomoxys calcitrans*, or stable-fly; *Pollenia rudis*, or cluster-fly; *Muscina stabulans*, another stable-fly; *Calliphora erythrocephala*, blue-bottle fly, blow-fly or meat-fly, with smaller sorts of blue-bottle, *Phormia terraenovae* and *Lucilia caesar*; *Homalomyia canicularis* and *brevis*, the small house-fly; *Scenopinus fenestralis*, the black window-fly, &c. But *Musca domestica* is far the most numerous, and in many places, especially in hot weather and in hot climates, is a regular pest. Mr L. O. Howard (Circular 71 of the Bureau of Entomology U.S. Dept. of Agriculture, Washington, 1906) says that in 1900 he made a collection of the flies in dining-rooms in different parts of the United States, and out of a total of 23,087 flies, 22,808 were the common house-fly. Its geographical distribution is of the widest, and its rapidity of breeding, in manure and doorway filth, so great that, as a carrier of germs of disease, especially cholera and typhoid, the house-fly is now recognized as a potent source of danger; and various sanitary regulations have been made, or precautions suggested, for getting rid of it. These are discussed by Mr Howard in the paper referred to, but in brief they all amount to measures of general hygiene, and the isolation, prompt removal, or proper sterilization of the animal or human excrement in which these flies breed.

FLYCATCHER, a name introduced in ornithology by Ray, being a translation of the *Muscicapa* of older authors, and applied by Pennant to an extremely common English bird, the *M. grisola* of Linnaeus. It has since been used in a general and very vague way for a great many small birds from all parts of the world, which have the habit of catching flies on the wing. Ornithologists who have trusted too much to this characteristic and to certain merely superficial correlations of structure, especially those exhibited by a broad and rather flat bill and a gape beset by strong hairs or bristles, have associated under the title of *Muscicapidae* an exceedingly heterogeneous assemblage of forms much reduced in number by later systematists. Great advance has been made in establishing as independent families the *Todidae* and *Eurylaemidae*, as well as in excluding from it various members of the *Ampelidae*, *Cotingidae*, *Tyrannidae*, *Vireonidae*, *Mniotiltidae*, and perhaps others, which had been placed within its limits. These steps have left the *Muscicapidae* a purely Old-World family of the order *Passeres*, and the chief difficulty now seems to lie in separating it from the *Campephagidae* and the *Laniidae*. Only a very few of the forms of flycatchers (which, after all the deductions above mentioned, may be

reckoned to include some 60 genera or subgenera, and perhaps 250 species) can here be even named.¹

The best-known bird of this family is that which also happens to be the type of the Linnaean genus *Muscicapa*—the spotted or grey flycatcher (*M. grisola*). It is a common summer visitant to nearly the whole of Europe, and is found throughout Great Britain, though less abundant in Scotland than in England, as well as in many parts of Ireland, where, however, it seems to be but locally and sparingly distributed. It is one of the latest migrants to arrive, and seldom reaches the British Islands till the latter part of May, when it may be seen, a small dust-coloured bird, sitting on the posts or railings of gardens and fields, ever and anon springing into the air, seizing with an audible snap of its bill some passing insect as it flies, and returning to the spot it has quitted, or taking up some similar station to keep watch as before. It has no song, but merely a plaintive or peevish call-note, uttered from time to time with a jerking gesture of the wings and tail. It makes a neat nest, built among the small twigs which sprout from the bole of a large tree, fixed in the branches of some plant trained against a wall, or placed in any hole of the wall itself that may be left by the falling of a brick or stone. The eggs are from four to six in number, of a pale greenish-blue, closely blotched or freckled with rust-colour. Silent and inconspicuous as is this bird, its constant pursuit of flies in the closest vicinity of houses makes it a familiar object to almost everybody. A second British species is the pied flycatcher (*M. atricapilla*), a much rarer bird, and in England not often seen except in the hilly country extending from the Peak of Derbyshire to Cumberland, and more numerous in the Lake District than elsewhere. It is not common in Scotland, and has only once been observed in Ireland. More of a woodland bird than the former, the brightly-contrasted black and white plumage of the cock, together with his agreeable song, readily attracts attention where it occurs. It is a summer visitant to all western Europe, but farther eastward its place is taken by a nearly allied species (*M. collaris*) in which the white of the throat and breast extends like a collar round the neck. A fourth European species (*M. parva*), distinguished by its very small size and red breast, has also strayed some three or four times to the extreme south-west of England. This last belongs to a group of more eastern range, which has received generic recognition under the name of *Erythrosterina*, and it has several relations in Asia and particularly in India, while the allies of the pied flycatchers (*Ficedula* of Brisson) are chiefly of African origin, and those of the grey or spotted flycatcher (*Muscicapa* proper²) are common to the two continents.

One of the most remarkable groups of *Muscicapidae* is that known as the paradise flycatchers, forming the genus *Tchitrea* of Lesson. In nearly all the species the males are distinguished by the growth of exceedingly long feathers in their tail, and by their putting on, for some part of the year at least, a plumage generally white, but almost always quite different from that worn by the females, which is of a more or less deep chestnut or bay colour, though in both sexes the crown is of a glossy steel-blue. They are found pretty well throughout Africa and tropical Asia to Japan, and seem to affect the deep shade of forests rather than the open country. The best-known species is perhaps the Indian *T. paradisi*; but the Chinese *T. incii*, and the Japanese *T. princeps*, from being very commonly represented by the artists of those nations on screens, fans and the like, are hardly less so; and the cock of the last named, with his bill of a pale greenish-blue and

¹ Of the 30 genera or subgenera which Swainson included in his *Natural Arrangement and Relations of the Family of Flycatchers* (published in 1838), at least 19 do not belong to the *Muscicapidae* at all, and one of them, *Todus*, not even to the order *Passeres*. It is perhaps impossible to name any ornithological work whose substance so fully belies its title as does this treatise. Swainson wrote it filled with faith in the so-called "Quinary System"—that fanciful theory, invented by W. S. Macleay, which misled and kept back so many of the best English zoologists of his generation from the truth,—and, unconsciously swayed by his bias, his judgment was warped to fit his hypothesis.

² By some writers this section is distinguished as *Butalis* of Boie, but to do so seems contrary to rule.

eyes surrounded by bare skin of the same colour—though these are characters possessed in some degree by all the species—seems to be the most beautiful of the genus. *T. bourbonnensis*, which is peculiar to the islands of Mauritius and Réunion, appears to be the only species in which the outward difference of the sexes is but slight. In *T. corvina* of the Seychelles, the adult male is wholly black, and his middle tail-feathers are not only very long but very broad. In *T. mutata* of Madagascar, some of the males are found in a blackish plumage, though with the elongated median rectrices white, while in others white predominates over the whole body; but whether this sex is here actually dimorphic, or whether the one dress is a passing phase of the other, is at present undetermined. Some of the African species, of which many have been described, seem always to retain the rufous plumage, but the long tail-feathers serve to mark the males.

A few other groups are distinguished by the brilliant blue they exhibit, as *Myiagra azurea*, and others as *Monarcha* (or *Arses*) *chrysomela* by their golden yellow. The Australian forms assigned to the *Muscicapidae* are very varied. *Sisura inquieta* has some of the habits of a water-wagtail (*Motacilla*), and hence has received the name of "dishwasher," bestowed in many parts of England on its analogue; and the many species of *Rhipidura* or fantailed flycatchers, which occur in various parts of the Australian Region, have manners still more singular—turning over in the air, it is said, like a tumbler pigeon, as they catch their prey; but concerning the mode of life of the majority of the *Muscicapidae*, and especially of the numerous African forms, hardly anything is known. (A. N.)

FLYGARE-CARLÉN, EMILIE (1807–1892), Swedish novelist, was born in Strömstad on the 8th of August 1807. Her father, Rutger Smith, was a retired sea-captain who had settled down as a small merchant, and she often accompanied him on the voyages he made along the coast. She married in 1827 a doctor named Axel Flygare, and went with him to live in the province of Småland. After his death in 1833 she returned to her old home and published in 1838 her first novel, *Waldemar Klein*. In the next year she removed to Stockholm, and married, in 1841, the jurist and poet, Johan Gabriel Carlén (1814–1875). Her house became a meeting-place for Stockholm men of letters, and for the next twelve years she produced one or two novels annually. The premature death of her son Edvard Flygare (1829–1853), who had already published three books, showing great promise, was followed by six years of silence, after which she resumed her writing until 1884. The most famous of her tales are *Rosen på Tistelön* (1842; Eng. trans. *The Rose of Tistelön*, 1842); *Enslingen på Johanneskäret* (1846; Eng. trans. *The Hermit*, 4 vols., 1853); and *En Köpemenshus i skärgården* (1859; *The Merchant's House on the Cliffs*). Fru Carlén published in 1878 *Minnen af svenskt författarlif 1840–1860*, and in 1887–1888 three volumes of *Efterskörd från en 50-årigs författarbana*, containing her last tales. She died at Stockholm on the 5th of February 1892. Her daughter, Rosa Carlén (1836–1883), was also a popular novelist.

Emilie Flygare-Carlén's novels were collected in thirty-one volumes (Stockholm, 1869–1875).

FLYING BUTTRESS, in architecture, the term given to a structural feature employed to transmit the thrust of a vault across an intervening space, such as an aisle, chapel or cloister, to a buttress built outside the latter. This was done by throwing a semi-arch across to the vertical buttress. Though employed by the Romans and in early Romanesque work, it was generally masked by other constructions or hidden under a roof, but in the 12th century it was recognized as rational construction and emphasized by the decorative accentuation of its features, as in the cathedrals of Chartres, Le Mans, Paris, Beauvais, Reims, &c. Sometimes, owing to the great height of the vaults, two semi-arches were thrown one above the other, and there are cases where the thrust was transmitted to two or even three buttresses across intervening spaces. As a vertical buttress, placed at a distance, possesses greater power of resistance to thrust than if attached to the wall carrying the vault, vertical

buttresses as at Lincoln and Westminster Abbey were built outside the chapterhouse to receive the thrust. All vertical buttresses are, as a rule, in addition weighted with pinnacles to give them greater power of resistance.

FLYING COLUMN, in military organization, an independent corps of troops usually composed of all arms, to which a particular task is assigned. It is almost always composed in the course of operations, out of the troops immediately available. Mobility being its *raison d'être*, a flying column is when possible composed of picked men and horses accompanied with the barest minimum of baggage. The term is usually, though not necessarily, applied to forces under the strength of a brigade. The "mobile columns" employed by the British in the South African War of 1899–1902, were usually of the strength of two battalions of infantry, a battery of artillery, and a squadron of cavalry—almost exactly half that of a mixed brigade. Flying columns are mostly used in savage or guerrilla warfare.

"**FLYING DUTCHMAN**," a spectre-ship popularly believed to haunt the waters around the Cape of Good Hope. The legend has several variants, but the commonest is that which declares that the captain of the vessel, Vanderdecken, was condemned for his blasphemy to sail round the cape for ever, unable to "make" a port. In the Dutch version the skipper is the ghost of the Dutch seaman Van Straaten. The appearance of the "Flying Dutchman" is considered by sailors as ominous of disaster. The German legend makes one Herr Von Falkenberg the hero, and alleges that he is condemned to sail for ever around the North Sea, on a ship without helm or steersman, playing at dice for his soul with the devil. Sir Walter Scott says the "Flying Dutchman" was originally a vessel laden with bullion. A murder was committed on board, and thereafter the plague broke out among the crew, which closed all ports to the ill-fated craft. The legend has been used by Wagner in his opera *Der fliegende Holländer*.

FLYING-FISH, the name given to two different kinds of fish. The one (*Dactylopterus*) belongs to the gurnard family (*Triglidae*), and is more properly called flying gurnard; the other (*Exocoetus*) has been called flying herring, though more nearly allied to the gar-pike than to the herring. Some other fishes with long pectoral fins (*Pterois*) have been stated to be able to fly, but this has been proved to be incorrect.

The flying gurnards are much less numerous than the *Exocoeti* with regard to individuals as well as species, there being only three or four species known of the former, whilst more than fifty have been described of the latter, which, besides, are found in numerous shoals of thousands. The *Dactylopteri* may be readily

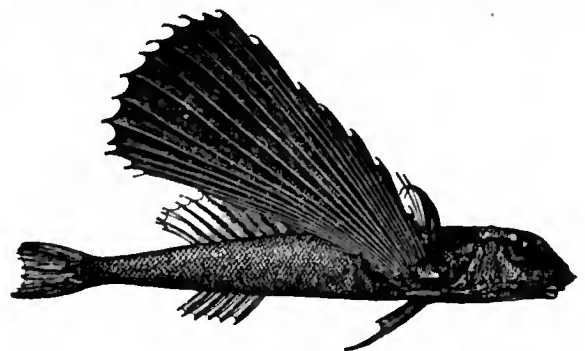

FIG. 1.—*Dactylopterus volitans*.

distinguished by a large bony head armed with spines, hard keeled scales, two dorsal fins, &c. The *Exocoeti* have thin, deciduous scales, only one dorsal fin, and the ventrals placed far backwards, below the middle of the body; some have long barbels at the chin. In both kinds the pectoral fins are greatly prolonged and enlarged, modified into an organ of flight, and in many species of *Exocoetus* the ventral fins are similarly enlarged, and evidently assist in the aerial evolutions of these fishes. Flying-fishes are found in the tropical and subtropical seas only, and it is a singular fact that the geographical distribution of the two kinds is nearly identical. Flying-fish are more frequently

observed in rough weather and in a disturbed sea than during calms; they dart out of the water when pursued by their enemies or frightened by an approaching vessel, but frequently also without any apparent cause, as is also observed in many other fishes; and they rise without regard to the direction of the wind or waves. The fins are kept quietly distended, without any motion, except an occasional vibration caused by the air whenever the surface of the wing is parallel with the current of the wind. Their flight is rapid, greatly exceeding that of a ship going 10 m. an hour, but gradually decreasing in velocity and not extending beyond a distance of 500 ft. Generally it is longer when the fishes fly against, than with or at an angle to, the wind. Any vertical or horizontal deviation from a straight line is not caused at the will of the fish, but by currents of the air; thus they

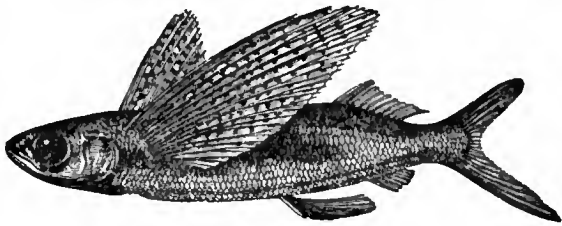

FIG. 2.—*Exocoetus callopterus*.

retain a horizontally straight course when flying with or against the wind, but are carried towards the right or left whenever the direction of the wind is at an angle with that of their flight. However, it sometimes happens that the fish during its flight immerses its caudal fin in the water, and by a stroke of its tail turns towards the right or left. In a calm the line of their flight is always also vertically straight or rather parabolic, like the course of a projectile, but it may become undulated in a rough sea, when they are flying against the course of the waves; they then frequently overtop each wave, being carried over it by the pressure of the disturbed air. Flying-fish often fall on board of vessels, but this never happens during a calm or from the lee side, but during a breeze only and from the weather side. In day time they avoid a ship, flying away from it, but during the night when they are unable to see, they frequently fly against the weather board, where they are caught by the current of the air, and carried upwards to a height of 20 ft. above the surface of the water, whilst under ordinary circumstances they keep close to it. All these observations point clearly to the fact that any deflection from a straight course is due to external circumstances, and not to voluntary action on the part of the fish.

A little Malacopterygian fish about 4 in. long has recently been discovered in West Africa which has the habits of a fresh-water flying-fish. It has been named *Pantodon buchholzi*. It has very large pectoral fins with a remarkable muscular process attached to the inner ray. It lives in fresh-water lakes and rivers in the Congo region, and has been caught in its flight above the water in a butterfly-net.

FLYING-FOX, or, more correctly, **FOX-BAT**. The first name is applied by Europeans in India to the fruit-eating bats of the genus *Pteropus*, which contains more than half the family (*Pteropidae*). This genus is confined to the tropical regions of the Eastern hemisphere and Australia. It comprises numerous species, a considerable proportion of which occur in the islands of the Malay Archipelago. The flying-foxes are the largest of the bats, the kalong of Java (*Pteropus edulis*) measuring about a foot in length, and having an expanse of wing-membrane measuring 5 ft. across. Flying-foxes are gregarious, nocturnal bats, suspending themselves during the day head-downwards by thousands from the branches of trees, where with their wings gathered about them, they bear some resemblance to huge shrivelled-up leaves or to clusters of some peculiar fruit. In Batching, according to Wallace, they suspend themselves chiefly from the branches of dead trees, where they are easily caught or knocked down by sticks, the natives carrying them home in basketfuls. They are then cooked with abundance of spices, and "are really very good eating, something like hare." Towards

evening these bats bestir themselves, and fly off in companies to the village plantations, where they feed on all kinds of fruit, and so numerous and voracious are they that no garden crop has much chance of being gathered which is not specially protected from their attacks. The flying-fox of India (*Pteropus medius*) is a smaller species, but is found in great numbers wherever fruit is to be had in the Indian peninsula.

FLYING-SQUIRREL, properly the name of such members of the squirrel-group of rodent mammals as have a parachute-like expansion of the skin of the flanks, with attachments to the limbs, by means of which they are able to take long flying-leaps from tree to tree. The parachute is supported by a cartilage attached to the wrist or carpus; in addition to the lateral membrane, there is a narrow one from the cheek along the front of each shoulder to the wrist, and in the larger species a third (interfemoral) connecting the hind-limbs with the base of the long tail. Of the two widely distributed genera, *Pteromys* includes the larger and *Sciuropterus* the smaller species. The two differ in certain details of dentition, and in the greater development in the former of the parachute, especially the interfemoral portion, which in the latter is almost absent. In *Pteromys* the tail is cylindrical and comparatively thin, while in *Sciuropterus* it is broad, flat and laterally expanded, so as to compensate for the absence of the interfemoral membrane by acting as a supplementary parachute.

In general appearance flying-squirrels resemble ordinary squirrels, although they are even more beautifully coloured. Their habits, food, &c., are also very similar to those of the true squirrels, except that they are more nocturnal, and are therefore less often seen. The Indian flying-squirrel (*P. oral*) leaps with its parachute extended from the higher branches of a tree, and descends first directly and then more and more obliquely, until the flight, gradually becoming slower, assumes a horizontal direction, and finally terminates in an ascent to the branch or trunk of the tree to which it was directed. The presence of these rodents at night is made known by their screaming cries. *Sciuropterus* is represented by *S. volucella* in eastern Europe and northern Asia, and by a second species in North America, but the other species of this genus and all those of *Pteromys* are Indo-Malayan. A third genus, *Eupetaurus*, typified by a very large, long-haired, dark-grey species from the mountains to the north-west of Kashmir (*Eu. cinereus*), differs from all other members of the squirrel-family by its tall-crowned molar teeth. It has a total length of 37 in., of which 22 are taken up by the tail.

In Africa the name of flying-squirrel is applied to the members of a very different family of rodents, the *Anomaluridae*, which are provided with a parachute. Since, however, this parachute is absent in some members of the family, the most distinctive character is the presence of a double row of spiny scales on the under surface of the tail, which apparently aid in climbing. The flying species are also distinguished from ordinary flying-squirrels by the circumstance that the additional bone serving for the support of the fore part of the flying-membrane rises



Pigmy African Flying-Squirrel
(*Idiurus zenkeri*).

from the elbow-joint instead of from the wrist. The family is represented by two flying genera, *Anomalurus* and *Idiurus*; the latter containing only one very minute species (shown in the cut) characterized by its small ears and elongated tail. Most of the species are West African. In habits these rodents appear to be very similar to the true flying-squirrels. The species without a parachute constitutes the genus *Zenkerella*, and looks very like an ordinary squirrel (see RODENTIA).

In Australia and Papua the name flying-squirrel is applied to such marsupials as are provided with parachutes; animals which naturalists prefer to designate flying-phalangers (see MARSUPIALIA).

FLYSCH, in geology, a remarkable formation, composed mainly of sandstones, soft marls and sandy shales found extending from S.W. Switzerland eastward along the northern Alpine zone to the Vienna basin, whence it may be followed round the northern flanks of the Carpathians into the Balkan peninsula. It is represented in the Pyrenees, the Apennines, the Caucasus and extends into Asia; similar flysch-like deposits are related to the Himalayas as the European formations are to the Alps. The Flysch is not of the same age in every place; thus in the western parts of Switzerland the oldest portions probably belong to the Eocene period, but the principal development is of Oligocene age; as it is traced eastward we find in the east Alps that it descends into the upper Cretaceous, and in the Vienna region and the Carpathians it contains intercalations which clearly indicate a lower Cretaceous horizon for the lower parts. It appears indeed that this type of formation was in progress of deposition at one point or another in the regions enumerated above from Jurassic to late Tertiary times. The absence of fossils from enormous thicknesses of Flysch makes the correlation with other formations difficult; often the only indications of organisms are the abundant markings supposed to represent Algae (Chondrites, &c.), which have given rise to the term "Hieroglyphic-sandstone." The most noteworthy exceptions are perhaps the Oligocene fish-bed of Glarus, the Eocene nummulitic beds in Calabria, and the *Aptychus* beds of Waidhofen. Local phases of the Flysch have received special names; it is the "Vienna" or "Carpathian" sandstone of those regions; the "macigno" (a soft sandstone with calcareous cement) of the Maritime Alps and Apennines; the "scagliose" (scaly clays) and "alberese" (limestones) of the same places are portions of this formation. The *gris de Menton*, the *gris d'Annot* of the Basses Alps, and the *gris d'Embrun* of Chaillot appear in Switzerland as the *gris de Tavayannaz*. At several places the upper layers of the Flysch are iron-stained, as in the region of Léman and at the foot of the Dent du Midi; it is then styled the "Red-Flysch." Lenticular intercalations of gabbro, diabase, &c., occur in the Flysch in Calabria on the Pyrenees. Large exotic blocks of granite, gneiss and other crystalline rocks in coarse conglomerates are found near Vienna, near Sonthofen in Bavaria, near Lake Thun (Wild Flysch) and at other points, which have been variously regarded as indications of glaciation or of coastal conditions.

FOČA (pronounced *Făwtcha*), a town of Bosnia, situated at the confluence of the Drina and Čhotina rivers, and encircled by wooded mountains. Pop. (1895) 4217. The town is the headquarters of a thriving industry in silver filigree-work and inlaid weapons, for which it was famous. With its territories enclosed by the frontiers of Montenegro and Novi Bazar, Foča, then known as *Chocha*, was the scene of almost incessant border warfare during the middle ages. No monuments of this period are left except the Bogomil cemeteries, and the beautiful mosques, which are the most ancient in Bosnia. The three adjoining towns of Foča, Goražda and Ustikolina were trading-stations of the Ragusans in the 14th century, if not earlier. In the 16th century, Benedetto Ramberti, ambassador from Venice to the Porte, described the town, in his *Libri Tre delle Cose dei Turchi*, as *Cozza*, "a large settlement, with good houses in Turkish style, and many shops and merchants. Here dwells the governor of Herzegovina, whose authority extends over the whole of Servia. Through this place all goods must pass, both going and returning, between Ragusa and Constantinople."

FOCHABERS, a burgh of barony and village of Elginshire, Scotland. Pop. (1901) 981. It is delightfully situated on the Spey, about 9 m. E. by S. of Elgin, the terminus of a branch of the Highland railway connecting at Orbliston Junction with the main line from Elgin to Keith. The town was rebuilt in its present situation at the end of the 18th century, when its earlier site was required for alterations in the grounds of Gordon Castle, in which the old town cross still stands. The streets all lead at right angles to the central square, where fairs and markets are held. The public buildings include a library and reading-room, the court-house and the Milne school, named after Alexander Milne, who endowed it with a legacy of £20,000. Adjoining the town, surrounded by a park containing many magnificent old trees, stands Gordon Castle, the chief seat of the duke of Richmond and Gordon, erected in the 18th century. The antiquary George Chalmers (1742-1825) and the composer William Marshall (1748-1833) were natives of the burgh.

FOCSHANI (Rumanian *Focșani*, sometimes incorrectly written *Fokshani* or *Fokshan*), the capital of the department of Putna, Rumania; on the river Milcov, which formed the ancient frontier of the former principalities of Moldavia and Walachia. Pop. (1900) 23,783; of whom 6000 were Jews. The chief buildings are the prefecture, schools, synagogues, and many churches, including those of the Armenians and Protestants. Focshani is a commercial centre of some importance, the chief industries being oil and soap manufacture and tannery. A large wine trade is also carried on, and corn is shipped in lighters to Galatz. The annual fair is held on the 29th of April. Government explorations in the vicinity of this town show it to be rich in minerals, such as iron, copper, coal and petroleum. The line Focshani-Galatz is covered by a very strong line of fortifications, known as the Sereth Line. A congress between Russian and Turkish diplomatists was held near the town in 1772. In the neighbourhood the Turks suffered a severe defeat from the Austrians and Russians in 1789.

FOCUS (Latin for "hearth" or "fireplace"), a point at which converging rays meet, toward which they are directed, or from which diverging rays are directed; in the latter case called the virtual focus (see MICROSCOPE; TELESCOPE; LENS). In geometry the word is used to denote certain points (see GEOMETRY; CONIC SECTION; and PERSPECTIVE).

FOG, the name given to any distribution of solid or liquid particles in the surface layers of the atmosphere which renders surrounding objects notably indistinct or altogether invisible according to their distance. In its more intense forms it hinders and delays travellers of all kinds, by sea or land, by railway, road or river, or by the mountain path. It is sometimes so thick as to paralyse traffic altogether. According to the *New English Dictionary* the word "appears to be" a back formation from the adjective "foggy," a derivative of "fog" used with its old meaning of aftermath or coarse grass, or, in the north of Britain, of "moss." Such a formation would be reasonable, because wreaths of fog in the atmospheric sense are specially characteristic of meadows and marshes where fog, in the more ancient sense, grows.

Two other words, *mist* and *haze*, are also in common use with reference to the deterioration of transparency of the surface layers of the atmosphere caused by solid or liquid particles, and in ordinary literature the three words are used almost according to the fancy of the writer. It seems possible to draw a distinction between mist and haze that would be fairly well supported by usage. Mist may be defined as a cloud of water particles at the surface of land or sea, and would only occur when the air is nearly or actually saturated, that is, when there is little or no difference between the readings of the dry and wet bulbs; the word haze, on the other hand, may be reserved for the obscuration of the surface layers of the atmosphere when the air is dry.

It would not be difficult to quote instances in which even this distinction is disregarded in practice. Indeed, the telegraphic code of the British Meteorological Office uses the same figure for mist and haze, and formerly the Beaufort weather notation had no separate letter for haze (now indicated by z), though it

Description of Effects.

Name.	No.	On Land.	On Sea.	On River.
Slight Fog or Mist	1	Objects indistinct, but traffic by rail or road unimpeded	Horizon invisible, but lights and landmarks visible at working distances	Objects indistinct, but navigation unimpeded
Moderate Fog	2	Traffic by rail requires additional caution	Lights, passing vessels and landmarks generally indistinct under a mile. Fog signals are sounded	Navigation impeded, additional caution required
	3	Traffic by rail or road impeded		
Thick Fog	4	Traffic by rail or road impeded	Ships' lights and vessels invisible at $\frac{1}{4}$ mile or less	Navigation suspended
	5	Traffic by rail or road totally disorganized		

distinguished between *f*, fog, and *m*, mist. It is possible, however, that these practices may arise, not from confusion of idea, but from economy of symbols, when the meaning can be made out from a knowledge of the associated observations.

As regards the distinction between mist and fog, careful consideration of a number

of examples leads to the conclusion that the word "fog" is used to indicate not so much the origin or meteorological nature of the obscurity as its effect upon traffic and travellers whether on land or sea. It is, generally speaking, "in a fog" that a traveller loses himself, and indeed the phrase has become proverbial in that sense. A "fog-bell" or "fog-horn" is sounded when the atmosphere is so thick that the aid of sound is required for navigation. A vessel is "fog-logged" or "fog-bound" when it is stopped or detained on account of thick atmosphere. A "fog-signal" is employed on railways when the ordinary signals are obliterated within working distances. A "fog-bow" is the accompaniment of conditions when a mountain traveller is apt to lose his way.

These words are used quite irrespective of the nature of the cloud which interferes with effective vision and necessitates the special provision; the word "mist" is seldom used in similar connexion. We may thus define a fog as a surface cloud sufficiently thick to cause hindrance to traffic. It will be a *thick mist* if the cloud consists of water particles, a *thick haze* if it consists of smoke or dust particles which would be persistent even in a dry atmosphere.

It is probable that sailors would be inclined to restrict the use of the word to the surface clouds met with in comparatively calm weather, and that the obscurity of the atmosphere when it is blowing hard and perhaps raining hard as well should be indicated by the terms "thick weather" or "very thick weather" and not by "fog"; but the term "fog" would be quite correctly used on such occasions from the point of view of cautious navigation. If cloud, drizzling rain, or heavy rain cause such obscurity that passing ships are not visible within working distances the sounding of a fog-horn becomes a duty.

The number of occasions upon which fog and mist may be noted as occurring with winds of different strengths may be exemplified by the following results of thirty years for St Mary's, Scilly Isles, where the observations have always been made by men of nautical experience.

Wind Force.	0 & 1	2	3	4	5	6	7	8-12	All Winds.
Number of occasions of fog per 1000 observations .	8	7	9	14	6	3	<1	<1	47
Number of occasions of mist per 1000 observations .	5	6	11	22	20	12	6	2	84

The use of the word "fog" in the connexion "high fog," to describe the almost total darkness in the daytime occasionally noted in London and other large cities due to the persistent opaque cloud in the upper air without serious obscuration of the surface layers, is convenient but incorrect.

Regarding "fog" as a word used to indicate the state of the atmosphere as regards transparency considered with reference to its effect upon traffic, a scale of fog intensity has been introduced for use on land or at sea, whereby the intensity of obscurity is indicated by the numbers 1 to 5 in the table following. At sea or in the country a fog, as a rule, is white and consists of

a cloud of minute water globules, of no great vertical thickness, which disperses the sunlight by repeated reflection but is fully translucent. In dust-storms and sand-storms dark or coloured fog clouds are produced such as those which are met with in the Harmattan winds off the west coast of Africa. In large towns the fog cloud is darkened and intensified by smoke, and in some cases may be regarded as due entirely to the smoke.

The physical processes which produce fogs of water particles are complicated and difficult to unravel. We have to account for the formation and maintenance of a cloud at the earth's surface; and the process of cloud-formation which is probably most usual in nature, namely, the cooling of air by rarefaction due to the reduction of pressure on ascent, cannot be invoked, except in the case of the fogs forming the cloud-caps of hills, which are perhaps not fairly included. We have to fall back upon the only other process hitherto recognized as causing cloudy condensation in the atmosphere, that is to say, the mixing of masses of mist air of different temperatures. The mixing is brought about by the slow motion of air masses, and this slow motion is probably essential to the phenomenon.

Over the sea fog is most frequently due to the cooling of a surface layer of warm air by the underlying cold water. The amount of motion of the air must be sufficient to prevent the

TABLE I.—Air travelling from Northern Africa to Northern Russia, round by the Azores.

Successive Temperatures of sea .	68°	68°	67°	59°	54°F.
" " " " " air .	68°	70°	67°	60°	56°F.
" " States of the atmosphere .	clear	clear	clear	shower	mist

TABLE II.—Air travelling from N.W. Africa to Scotland.

Successive Temperatures of sea .	67°	63°	54° F.
" " " " " air .	66°	64°	53° F.
" " State of atmosphere .	fair	shower	mist with shower

condensation taking place at the sea surface without showing itself as a cloud. In a research on the Life History of Surface Air Currents the changes incidental to the movement of the air over the north Atlantic Ocean were traced with great care, and the above examples (Tables I, II) taken from page 72 of the work referred to are typical of the formation of sea fog by the cooling of a relatively warm current passing over cold water.

In conformity with this suggestion we find that fog is most liable to occur over the open ocean in those regions where, as off the Newfoundland banks, cold-water currents underlie warm air, and that it is most frequent at the season of the year when the air temperature is increasing faster than the water temperature. But it is difficult to bring this hypothesis always to bear upon actual practice, because the fog is representative of a temperature difference which has ceased to exist. One cannot therefore observe under ordinary circumstances both the temperature difference and the fog. Doubtless one requires not only the initial temperature difference but also the slow drift of air which favours cooling of the lower layers without too much mixing and consequently a layer of fog close to the surface. Such a fog, the characteristic sea fog, may be called a cold surface fog. From

the conditions of its formation it is likely to be less dense at the mast-head than it is on deck.

One would expect that a cold-air current passing over a warm sea surface would give rise to an ascending current of warmed air and hence cause cumulus cloud and possibly thunder showers rather than surface fog, but one cannot resist the conclusion that sea fog is sometimes formed by slow transference of cold air over relatively warm water, giving rise to what may be called a "steaming-pot" fog. In such a case the actual surface layer in contact with the warm water would be clear, and the fog would be thicker aloft where the mixing of cold air and water vapour is more complete. Such fogs are, however, probably rare in comparison with the cold-water fogs. If the existence of a cold current over warm water were a sufficient cause of fog, as a current of warm air over cold water appears to be, the geographical distribution of notable fog would be much more widespread than it actually is, and the seasonal distribution of fog would also be other than it is.

The formation of fog over land seems to be an even more complicated process than over the sea. Certainly in some cases mistiness amounting to fog arises from the replacement of cold surface air which has chilled the earth and the objects thereon by a warm current. But this process can hardly give rise to detached masses or banks of fog. The ordinary land or valley fog of the autumn evening or winter morning is due to the combination of three causes, first the cooling of the surface layer of air at or after sunset by the radiation of the earth, or more particularly of blades of grass, secondly the slow downward flow (in the absence of wind) of the air thus cooled towards lower levels following roughly the course of the natural water drainage of the land, and thirdly the supply of moisture by evaporation from warm moist soil or from the relatively warm water surface of river or lake. In this way steaming-pot fog gradually forms and is carried downward by the natural though slow descent of the cooled air. It thus forms in wreaths and banks in the lowest parts, until perhaps the whole valley becomes filled with a cloud of mist or fog. A case of this kind in the Lake District is minutely described by J. B. Cohen (*Q. J. Roy. Met. Soc.* vol. 30, p. 211, 1904).

It will be noticed that upon this hypothesis the circumstances favourable for fog formation are (1) a site near the bottom level of the drainage area, (2) cold surface air and no wind, (3) an evening or night of vigorous radiation, (4) warm soil, and (5) abundant moisture in the surface-soil. These conditions define with reasonable accuracy the circumstances in which fog is actually observed.

The persistence of these fog wreaths is always remarkable when one considers that the particles of a fog cloud, however small they may be, must be continually sinking through the air which holds them, and that unless some upward motion of the air keeps at least a balance against this downward fall, the particles of the cloud must reach the earth or water and to that extent the cloud must disappear. In sheltered valleys it is easy to suppose that the constant downward drainage of fresh and colder fog-laden material at the surface supplies to the layers displaced from the bottom the necessary upward motion, and the result of the gradual falling of drops is only that the surface cloud gets thicker; but there are occasions when the extent and persistence of land fog seems too great to be accounted for by persistent radiation cooling. For example, in the week before Christmas of 1904 the whole of England south of the Humber was covered with fog for several days. It is of course possible that so much fog-laden air was poured down from the sides of mountains and hills that did project above the surface of the fog, as to keep the lower reaches supplied for the whole time, but without more particulars such a statement seems almost incredible. Moreover, the drifting of fog banks over the sea seems capricious and unrelated to any known circumstances of fog-formation, so that one is tempted to invoke the aid of electrification of the particles or some other abnormal condition to account for the persistence of fog. The observations at Kew observatory show that the electrical potential is abnormally high during fog,

but whether that is the cause or the result of the presence of the water particles, we are not yet in a position to say. It must be remembered that a fog cloud ought to be regarded as being, generally speaking, *in process of formation* by mixing. Observations upon clouds formed experimentally in globes tend to show that if a mass of fog-bearing air could be enclosed and kept still for only a short while the fog would settle and leave the air clear. The apparently capricious behaviour of fog banks may be due to the fact that mixing is still going on in the persistent ones, but is completed in the disappearing ones.

One remarkable characteristic of a persistent fog is the coldness of the foggy air at the surface in spite of the heat of the sun's rays falling upon the upper surface of the fog. A remarkable example may be quoted from the case of London, which was under fog all day on 28th January 1909. The maximum temperature only reached 31° F., whereas at Warlingham in Surrey from which the fog lifted it was as high as 46° F.

A priori we might suppose that the formation of fog would arrest cooling by radiation, and that fog would thus act as a protection of plants against frost. The condensation of water evaporated from wet ground, which affords the material for making fog, does apparently act as a protection, and heavy watering is sometimes used to protect plants from frost, but the same cannot be said of fog itself—cooling appears to go on in spite of the formation of fog.

A third process of fog-formation, namely, the descent of a cloud from above in the form of light drizzling rain, hardly calls for remark. In so far as it is subject to rules, they are the rules of clouds and rain and are therefore independent of surface conditions.

These various causes of fog-formation may be considered with advantage in relation to the geographical distribution of fog. Statistics on this subject are not very satisfactory on account of the uncertainty of the distinction between fog and mist, but a good deal may be learned from the distribution of fog over the north Atlantic Ocean and its various coasts as shown in the Monthly Meteorological Charts of the north Atlantic issued by the Meteorological Office, and the Pilot charts of the North Atlantic of the United States Hydrographic Office. Coast fog, which is probably of the same nature as land fog, is most frequent in the winter months, whereas sea fog and ocean fog is most extensive and frequent in the spring and summer. By June the fog area has extended from the Great Banks over the ocean to the British Isles, in July it is most intense, and by August it has notably diminished, while in November, which is proverbially a foggy month on land, there is hardly any fog shown over the ocean.

The various meteorological aspects of fog and its incidence in London were the subject of reports to the Meteorological Council by Captain A. Carpenter and Mr R. G. K. Lempfert, based upon special observations made in the winters of 1901-1902 and 1902-1903 in order to examine the possibility of more precise forecasts of fog.

The study of the properties and behaviour of fog is especially important for large towns in consequence of the economic and hygienic results which follow the incidence of dense fogs. The fogs of London in particular have long been a subject of inquiry. It is difficult to get trustworthy statistics on the subject in consequence of the vagueness of the practice as regards the classification of fog. For large towns there is great advantage in using a fog scale such as that given above, in which one deals only with the practical range of vision irrespective of the meteorological cause.

Accepting the classification which distinguishes between fog and haze or mist, but not between the two latter terms, as equivalent to specifying fog when the thickness amounts to the figure 2 or more on the fog scale, we are enabled to compare the frequency of fog in London by the comparison of the results at the London observing stations. The comparison was made by Mr Brodie in a paper read before the Royal Meteorological Society (*Quarterly Journal*, vol. 31, p. 15), and it appears therefrom that in recent years there has been a notable diminution of fog

frequency, as indicated in the following table of the total number of days of fog in the years from 1871:—

1871.	1872.	1873.	1874.	1875.	1876.	1877.	1878.	1879.	1880.	1881.	1882.	1883.	1884.	1885.	1886.	1887.	1888.	1889.
42	35	75	53	49	40	46	63	69	74	59	69	61	53	69	86	83	62	75
1890.	1891.	1892.	1893.	1894.	1895.	1896.	1897.	1898.	1899.	1900.	1901.	1902.	1903.	1904.	1905.	1906.	1907.	1908.
65	69	68	31	51	48	43	48	47	56	13	45	42	26	44	19	16	37	19

But from any statistics of the frequency occurrence of fog it must not be understood that the atmosphere of London is approaching that of the surrounding districts as regards transparency. Judged by the autographic records it is still almost opaque to sunshine strong enough to burn the card of the recorder during the winter months.

The bibliography of fog is very extensive. The titles referring to fog, mist and haze in the *Bibliography of Meteorology* (part ii.) of the U. S. Signal Office, published in 1889, number 306. Among more recent authors on the subject, besides those referred to in the text, may be mentioned:—Köppen, "Bodennebel," *Met. Zeit.* (1885); Trabert, *Met. Zeit.* (1901), p. 522; Elias in *Ergebnisse des äronautischen Observatoriums bei Berlin*, ii. (Berlin, 1904); Scott, *Q.J.R. Met. Soc.* xix. p. 229; A. G. McAdie, "Fog Studies," *Amer. Inv.* ix. (Washington, D.C., 1902), p. 209; Buchan, "Fogs on the Coasts of Scotland," *Journ. Scot. Met. Soc.* xii. p. 3. (W. N. S.)

FOGAZZARO, ANTONIO (1842—), Italian novelist and poet, was born at Vicenza in 1842. He was a pupil of the Abate Zanella, one of the best of the modern Italian poets, whose tender, thoughtful and deeply religious spirit continued to animate his literary productions. He began his literary career with *Miranda*, a poetical romance (1874), followed in 1876 by *Valsolda*, which, republished in 1886 with considerable additions, constitutes perhaps his principal claim as a poet, which is not inconsiderable. To the classic grandeur of Carducci and D'Annunzio's impetuous torrent of melody Fogazzaro opposes a Wordsworthian simplicity and pathos, contributing to modern Italian literature wholesome elements of which it would otherwise be nearly destitute. His novels, *Malombra* (1882), *Daniele Cortis* (1887), *Misterio del Poeta* (1888), obtained considerable literary success upon their first publication, but did not gain universal popularity until they were discovered and taken up by French critics in 1896. The demand then became prodigious, and a new work, *Piccolo Mondo antico* (1896), which critics far from friendly to Fogazzaro's religious and philosophical ideas pronounced the best Italian novel since *I Promessi Sposi*, went through numerous editions. Even greater sensation was caused by his novel *Il Santo* (*The Saint*, 1906), on account of its being treated as unorthodox by the Vatican; and Fogazzaro's sympathy with the Liberal Catholic movement—his own Catholicism being well known—made this novel a centre of discussion in the Roman Catholic world.

See the biography by Molmenti (1900).

FOGELBERG, BENEDICT (OR BENG T) **ERLAND** (1786—1854), Swedish sculptor, was born at Gothenburg on the 8th of August 1786. His father, a copper-founder, encouraging an early-exhibited taste for design, sent him in 1801 to Stockholm, where he studied at the school of art. There he came much under the influence of the sculptor Sergell, who communicated to him his own enthusiasm for antique art and natural grace. Fogelberg worked hard at Stockholm for many years, although his instinct for severe beauty rebelled against the somewhat rococo quality of the art then prevalent in the city. In 1818 the grant of a government pension enabled him to travel. He studied from one to two years in Paris, first under Pierre Guérin, and afterwards under the sculptor Bosio, for the technical practice of sculpture. In 1820 Fogelberg realized a dream of his life in visiting Rome, where the greater part of his remaining years were spent in the assiduous practice of his art, and the careful study and analysis of the works of the past. Visiting his native country by royal command in 1854, he was received with great enthusiasm, but nothing could compensate him for the absence of those remains of antiquity and surroundings of free natural beauty to which he had been so long accustomed. Returning

to Italy, he died suddenly of apoplexy at Trieste on the 22nd of December 1854. The subjects of Fogelberg's earlier works

are mostly taken from classic mythology. Of these, "Cupid and Psyche," "Venus entering the Bath," "A Bather" (1838), "Apollo Citharede," "Venus and Cupid" (1830) and "Psyche" (1854) may be mentioned. In his representations of Scandinavian mythology Fogelberg showed, perhaps for the first time, that he had powers above those of intelligent assimilation and imitation. His "Odin" (1831), "Thor" (1842), and "Balder" (1842), though influenced by Greek art, display considerable power of independent imagination. His portraits and historical figures, as those of Gustavus Adolphus (1849), of Charles XII. (1851), of Charles XIII. (1852), and of Birger Jarl, the founder of Stockholm (1853), are faithful and dignified works.

See Casimir Leconte, *L'Œuvre de Fogelberg* (Paris, 1856).

FOGGIA, a town and episcopal see (since 1855) of Apulia, Italy, the capital of the province of Foggia, situated 243 ft. above sea-level, in the centre of the great Apulian plain, 201 m. by rail S.E. of Ancona and 123 m. N.E. by E. of Naples. Pop. (1901) town, 49,031; commune, 53,134. The name is probably derived from the pits or cellars (*foveae*) in which the inhabitants store their grain. The town is the medieval successor of the ancient Arpi, 3 m. to the N.; the Normans, after conquering the district from the Eastern empire, gave it its first importance. The date of the erection of the cathedral is probably about 1179; it retains some traces of Norman architecture, and the façade has a fine figured cornice by Bartolommeo da Foggia; the crypt has capitals of the 11th (?) century. The whole church was, however, much altered after the earthquake of 1731. A gateway of the palace of the emperor Frederick II. (1223, by Bartolommeo da Foggia) is also preserved. Here died his third wife, Isabella, daughter of King John of England. Charles of Anjou died here in 1284. After his son's death, it was a prey to internal dissensions and finally came under Alphonso I. of Aragon, who converted the pastures of the Apulian plain into a royal domain in 1445, and made Foggia the place at which the tax on the sheep was to be paid and the wool to be sold. The other buildings of the town are modern. Foggia is a commercial centre of some importance for the produce of the surrounding country, and is also a considerable railway centre, being situated on the main line from Bologna to Brindisi, at the point where this is joined by the line from Benevento and Caserta. There are also branches to Rocchetta S. Antonio (and thence to either Avellino, Potenza, or Gioia del Colle), to Manfredonia, and to Lucera.

FÖHN (Ger., probably derived through Romansch *favongn*, *favoign*, from Lat. *favonius*), a warm dry wind blowing down the valleys of the Alps from high central regions, most frequently in winter. The Föhn wind often blows with great violence. It is caused by the indraft of air from the elevated region to areas of low barometric pressure in the neighbourhood, and the warmth and dryness are due to dynamical compression of the air as it descends to lower levels. Similar local winds occur in many parts of the world, as Greenland, and on the slopes of the Rocky Mountains. In the southern Alpine valleys the Föhn wind is often called sirocco, but its nature and cause are different from the true sirocco. The belief that the warm dry wind comes from the Sahara dies hard; and still finds expression in some textbooks.

For a full account of these winds see Hann, *Lehrbuch der Meteorologie*, p. 594.

FÖHR, a German island in the North Sea, belonging to the province of Schleswig-Holstein, and situated off its coast. Pop. 4500. It comprises an area of 32 sq. m., and is reached by a regular steamboat service from Husum and Dagebüll on the mainland to Wyk, the principal bathing resort on the E. coast of the island. The chief attraction of Wyk is the Sandwall, a

promenade which is shaded by trees and skirts the beach. Föhr, the most fertile of the North Frisian islands, is principally marshland, and comparatively well wooded. There are numerous pleasantly-situated villages and hamlets scattered over it, of which the most frequented are Boldixum, Nieblum and Alkersum. The inhabitants are mainly engaged in the fishing industry, and are known as excellent sailors.

FOIL. 1. (Through O. Fr. from Lat. *folium*, a leaf, modern Fr. *feuille*), a leaf, and so used in heraldry and in plant names, such as the "trefoil" clover; and hence applied to anything resembling a leaf. In architecture, the word appears for the small leaf-like spaces formed by the cusps of tracery in windows or panels, and known, according to the number of such spaces, as "quatrefoil," "cinquefoil," &c. The word is also found in "counterfoil," a leaf of a receipt or cheque book, containing memoranda or a duplicate of the receipt or draft, kept by the receiver or drawer as a "counter" or check. "Foil" is particularly used of thin plates of metal, resembling a leaf, not in shape as much as in thinness. In thickness foil comes between "leaf" and "sheet" metal. In jewelry, a foil of silvered sheet copper, sometimes known as Dutch foil, is used as a backing for paste gems, or stones of inferior lustre or colour. This is coated with a mixture of isinglass and translucent colour, varying with the stones to be backed, or, if only brilliancy is required, left uncoloured, but highly polished. From this use of "foil," the word comes to mean, in a figurative sense, something which by contrast, or by its own brightness, serves to heighten the attractive qualities of something else placed in juxtaposition. The commonest "foil" is that generally known as "tin-foil." The ordinary commercial "tin-foil" usually consists chiefly of lead, and is used for the wrapping of chocolate or other sweetmeats, tobacco or cigarettes. A Japanese variegated foil gives the effect of "damaskeening." A large number of thin plates of various metals, gold, silver, copper, together with alloys of different metals are soldered together in a particular order, a pattern is hammered into the soldered edges, and the whole is hammered or rolled into a single thin plate, the pattern then appearing in the order in which the various metals were placed.

2. (From an O. Fr. *fuler* or *foler*, modern *fouler*, to tread or trample, to "full" cloth, Lat. *fullo*, a fuller), an old hunting term, used of the running back of an animal over its own tracks, to confuse the scent and baffle the hounds. It is also used in wrestling, of a "throw." Thus comes the common use of the word, in a figurative sense, with reference to both these meanings, of baffling or defeating an adversary, or of parrying an attack.

3. As the name of the weapon used in fencing (see FOIL-FENCING) the word is of doubtful origin. One suggestion, based on a supposed similar use of Fr. *fleur*, literally a "little flower," for the weapon, is that foil means a leaf, and must be referred in origin to Lat. *folium*. A second suggestion is that it means "blunted," and is the same as (2). A third is that it is an adaptation of an expression "at foils," i.e. "parrying." Of these suggestions, according to the *New English Dictionary*, the first has nothing to support it, the second is not supported by any evidence that in sense (2) the word ever meant to blunt. The third has some support. Finally a suggestion is made that the word is an alteration of an old word "foin," meaning a thrust with a pointed weapon. The origin of this word is probably an O. Fr. *foisne*, from the Lat. *fuscina*, a three-pronged fork.

FOIL-FENCING, the art of attack and defence with the fencing-foil. The word is used in several spellings (foyle, file, &c.) by the English writers of the last half of the 16th century, but less in the sense of a weapon of defence than merely as an imitation of a real weapon. Blunt swords for practice in fencing have been used in all ages. For the most part these were of wood and flat in general form, but when, towards the close of the 17th century, all cutting action with the small-sword was discarded (see FENCING), foil-blades were usually made of steel, and either round, three-cornered or four-cornered in form, with a button covering the point. The foil is called in French *fleur*, and in Italian *fioretto* (literally "bud") from this button. The classic small-

sword play of the 17th and 18th centuries is represented at the present time by fencing with the *épée de combat* (fighting-rapier), which is merely the modern duelling-sword furnished with a button (see *ÉPÉE-DE-COMBAT*), and by foil-fencing. Foil-fencing is a conventional art, its characteristic limitation lying in the rule that no hits except those on the body shall be considered good, and not even those unless they be given in strict accordance with certain standard precepts. In *épée*-fencing on the contrary, a touch on any part of the person, however given, is valid. Foil-fencing is considered the basis, so far as practice is concerned, of all sword-play, whether with foil, *épée* or sabre.

There are two recognized schools of foil-fencing, the French and the Italian. The French method, which is now generally adopted everywhere except in Italy, is described in this article, reference being made to the important differences between the two schools.

The Foil.—The foil consists of the "blade" and the "handle." The blade, which is of steel and has a quadrangular section, consists of two parts: the blade proper, extending from the guard to the button, and the "tongue," which runs through the handle and is joined to the pommel. The blade proper is divided into the "forte," or thicker half (next the handle), and the "foible" or thinner half. Some authorities divide the blade proper into three parts, the "forte," "middle" and "foible." The handle is comprised of the "guard," the "grip" and the "pommel." The guard is a light piece of metal shaped like the figure 8 (Fr. *lunettes*, spectacles) and backed with a piece of stiff leather of the same shape. The grip, which is grasped by the hand, is a hollow piece of wood, usually wound with twine, through which the tongue of the blade passes. The pommel is a piece of metal, usually pear-shaped, to which the end of the tongue is joined and which forms the extremity of the handle. The blade from guard to button is about 33 in. long (No. 5), though a somewhat shorter and lighter blade is generally used by ladies. The handle is about 8 in. long and slightly curved downwards.

The genuine Italian foil differs from the French in having the blade a trifle longer and more whippy, and in the form of the handle, which consists of a thin, solid, bell-shaped guard from 4 to 5 in. in diameter, a straight grip and a light metal bar joining the grip with the guard, beyond the edge of which it extends slightly on each side. Of late years many Italian masters use French blades and even discard the cross-bar, retaining, however, the bell-guard.

In holding the foil, the thumb is placed on the top or convex surface of the grip (the sides of which are a trifle narrower than the top and bottom), while the palm and fingers grasp the other three sides. This is the position of "supination," or thumb-up. "Pronation" is the reverse position, with the knuckles up. The French lay stress upon holding the foil lightly, the necessary pressure being exerted mostly by the thumb and forefinger, the other fingers being used more to guide the direction of the executed movements. This is in order to give free scope to the *doigté* (fingering), or the faculty of directing the point of the foil by the action of the fingers alone, and includes the possibility of changing the position of the hand on the grip. Thus, in parrying, the end of the thumb is placed within half an inch, or even less, of the guard, while in making a lunge, the foil is held as near the pommel as possible, in order to gain additional length. It will be seen that *doigté* is impossible with the Italian foil, in holding which the forefinger is firmly interlaced with the cross-bar, preventing any movement of the hand. The lightness of grasp inculcated by the French is illustrated by the rule of the celebrated master Lafaugère: "Hold your sword as if you had a little bird in your hand, firmly enough to prevent its escape, yet not so firmly as to crush it." This lightness has for a consequence that a disarmament is not considered of any value in the French school.

To Come on Guard.—The position of "on guard" is that in which the fencer is best prepared both for attack and defence. It is taken from the position of "attention"; the feet together and at right angles with each other, head and body erect, facing forward in the same direction as the right foot, left arm and hand hanging in touch with the body, and the right arm and foil

forming a straight line so that the button is about 1 yd. in front of the feet and 4 in. from the floor. From this position the movements to come "on guard" are seven in number:—

1. Raise the arm and foil and extend them towards the adversary (or master) in a straight line, the hand being opposite the eye.
2. Drop the arm and foil again until the point is about 4 in. from the floor.
3. Swing the button round so that it shall point horizontally backwards, and hold the hilt against the left thigh, the open fingers of the left hand being held, knuckles down, against the guard and along the blade.
4. Carry the foil, without altering the position of the hands, above the head until the arms are fully extended, the foil being kept horizontal and close to the body as it is lifted.
5. Let the left arm fall back behind the head to a curved position, the hand being opposite the top of the head; at the same time bring the right hand down opposite the right breast and about 8 in. from it; keeping the elbow well in and the point of the foil directed towards the opponent's eye.
6. Bend the legs by separating them at the knees but without moving the feet.
7. Shift the weight of the body on to the left leg and advance the right foot a short distance (from 14 to 18 in., according to the height of the fencer).

In the Italian school the fencer stands on guard with the right arm fully extended, the body more effaced, *i.e.* the left shoulder thrown farther back, and the feet somewhat farther apart. At the present time, however, many of the best Italian fencers have adopted the guard with crooked sword-arm, owing to their abandonment of the old long-foil blade.

The Recover (at the close of the lesson or assault).—To recover "in advance": extend the right arm at right angles with the body, drop the left arm and straighten the legs by drawing the rear foot up to the one in advance. To recover "to the rear": extend the right arm and drop the left as before, and straighten the legs by drawing the forward foot back to that in the rear.

The Salute always follows the recover, the two really forming one manoeuvre. Having recovered, carry the right hand to a position just in front of the throat, knuckles out, foil vertical with point upwards; then lower and extend the arm with nails up until the point is 4 in. from the floor and slightly to the right.

To Advance.—Being on guard, take a short step forward with the right foot and let the left foot follow immediately the same distance, the position of the body not being changed. However the step, or series of steps, is made, the right foot should always move first.

To Retreat.—This is the reverse of the advance, the left foot always moving first.

The Calls (deux appels).—Being on guard, tap the floor twice with the right foot without altering the position of any other part of the person. The object of the calls is to test the equilibrium of the body, and they are usually executed as a preliminary to the recover.

The Lunge is the chief means of attack. It is immediately preceded by the movement of "extension," in fact the two really form one combined movement. Extension is executed by quickly extending the right arm, so that point, hand and shoulder shall have the same elevation; no other part of the person is moved. The "lunge" is then carried out by straightening the left leg and throwing forward the right foot, so that it shall be planted as far forward as possible without losing the equilibrium or preventing a quick recovery to the position of guard. The left foot remains firmly in its position, the right shoulder is advanced, and the left arm is thrown down and back (with hand open and thumb up), to balance the body. The recovery to the position of guard is accomplished by smartly throwing the body back by the exertion of the right leg, until its weight rests again on the left leg, the right foot and arms resuming their on-guard positions. The point upon which the French school lays most stress is, that the movement of extension shall, if only by a fraction of a second, actually precede the advance of the right foot. The object of this is to ensure the accuracy of the lunge, *i.e.* the direction of the point.

The Gain.—This consists in bringing up the left foot towards the right (the balance being shifted), keeping the knees bent. In

this manner a step is gained and an exceptionally long lunge can be made without the knowledge of the adversary. It is a common stratagem of fencers whose reach is short.

Defence.—For the purpose of nomenclature the space on the fencer's jacket within which hits count is divided into quarters, the two upper ones being called the "high lines," and the two lower ones the "low lines." Thus a thrust directed at the upper part of the breast is called an attack in the high lines. In like manner the parries are named from the different quarters they are designed to protect. There are four traditional parries executed with the hand in supination, and four others, practically identical in execution, made with the hand held in pronation. Thus the parries defending the upper right-hand quarter of the jacket are "sixte" (sixth; with the hand in supination) and "tierce" (third; hand in pronation). Those defending the upper left-hand quarter are "quarte" (fourth; in supination) and "quinte" (fifth; in pronation). Those defending the lower right-hand quarter are "octave" (eighth; in supination) and "seconde" (second; in pronation). Those defending the lower left-hand quarter are "septime" (seventh; in supination), more generally called "demicircle," or "half-circle"; and "prime" (first; in pronation).

The Parries.—The tendency of the French school has always been towards simplicity, especially of defence, and at the present day the parries made with the knuckles up (pronation), although recognized and taught, are seldom if ever used against a strong adversary in foil-fencing, owing principally to the time lost in turning the hand. The theory of parrying is to turn aside the opponent's foil with the least possible expenditure of time and exertion, using the arm as little as possible while letting the hand and wrist do the work, and opposing the "forte" of the foil to the "foible" of the adversary's. The foil is kept pointed as directly as possible towards the adversary, and the parries are made rather with the corners than the sides of the blade. The slightest movement that will turn aside the opponent's blade is the most perfect parry. There are two kinds of parries, "simple," in which the attack is warded off by a single movement, and "counter," in which a narrow circle is described by the point of the foil round that of the opponent, which is thus enveloped and thrown aside. There are also complex parries, composed of combinations of two or more parries, which are used to meet complicated attacks, but they are all resolvable into simple parries. In parrying, the arm is bent about at right angles.

Simple Parries.—The origin of the numerical nomenclature of the parries is a matter of dispute, but it is generally believed that they received their names from the positions assumed in the process of drawing the sword and falling on guard. Thus the position of the hand and blade, the moment it is drawn from the scabbard on the left side, is practically that of the first, or "prime," parry. To go from "prime" to "seconde" it is only necessary to drop the hand and carry it across the body to the left side; thence to "tierce" is only a matter of raising the point of the sword, &c.

Parry of Prime (to ward off attacks on the—usually lower—left-hand side of the body). Hold the hand, knuckles up, opposite the left eye and the point directed towards the opponent's knee. This parry is now regarded more as an elegant evolution than a sound means of defence, and is little employed.

Parry of Seconde (against thrusts at the lower right-hand side). This is executed by a quick, not too wide movement of the hand downwards and slightly to the right, knuckles up.

Parry of Tierce (against thrusts at the upper right-hand side). A quick, dry beat on the adversary's "foible" is given, forcing it to the right, the hand, in pronation, being held opposite the middle of the right breast. This parry has been practically discarded in favour of "sixte."

Parry of Quarte (against thrusts at the upper left-hand side). This parry, perhaps the most used of all, is executed by forcing the adversary's blade to the left by a dry beat, the hand being in supination, opposite the left breast.

Parry of Quinte (against thrusts at the left-hand side, like "quarte"). This is practically a low "quarte," and is little used.

Parry of Sixte (against thrusts at the upper right-hand side). This parry is, together with "quarte," the most important of all. It is executed with the hand held in supination opposite the right breast, a quick, narrow movement throwing the adversary's blade to the right.

Parry of Septime or Half-Circle (against thrusts at the lower left-hand side) is executed by describing with the point of the foil a small semicircle downward and towards the left, the hand moving a few inches in the same direction, but kept thumb up.

Parry of Octave (against thrusts at the lower right-hand side) is executed by describing with the point of the foil a small semicircle downward and towards the right, the hand moving a few inches in the same direction, but kept thumb up.

Counter Parries (Fr. *contre*).—Although the simple parries are theoretically sufficient for defence, they are so easily deceived by feints that they are supplemented by counter parries, in which the blade describes narrow circles, following that of the adversary and meeting and turning it aside; thus the point describes a complete circle while the hand remains practically stationary. Each simple parry has its counter, made with the hand in the same position and on the same side as in the simple parry. The two most important are the "counter of quarte" and the "counter of sixte," while the counters of "septime" and "octave" are less used, and the other four at the present time practically never.

Counter of Quarte.—Being on guard in quarte (with your adversary's blade on the left of yours), if he drops his point under and thrusts in sixte, in other words at your right breast, describe a narrow circle with your point round his blade, downward to the right and then up over to the left, bringing hand and foil back to their previous positions and catching and turning aside his blade on the way. The "Counter of Sixte" is executed in a similar manner, but the circle is described in the opposite direction, throwing off the adverse blade to the right. The "Counters of Septime and Octave" are similar to the other two but are executed in the low lines.

Complex or Combined Parries are such as are composed of two or more parries executed in immediate succession, and are made in answer to feint attacks by the adversary (see below); e.g. being on guard in quarte, should the adversary drop his point under and feint at the right breast but deflect the point again and really thrust on the left, it is evident that the simple parry of sixte would cover the right breast but would leave the real point of attack, the left, entirely uncovered. The sixte parry is therefore followed, as a continuation of the movement, by the parry of quarte, or a counter parry. The complex parries are numerous and depend upon the attack to be met.

Engagement is the junction of the blades, the different engagements being named from the parries. Thus, if both fencers are in the position of quarte, they are said to be engaged in quarte. To engage in another line (Change of Engagement) e.g. from quarte to sixte, the point is lowered and passed under the adversary's blade, which is pressed slightly outward, so as to be well covered (called "opposition"). "Double Engagement" is composed of two engagements executed rapidly in succession in the high lines, the last with opposition.

Attack.—The attack in fencing comprises all movements the object of which is to place the point of the foil upon the adversary's breast, body, sides or back, between collar and belt. The space upon which hits count is called the "target" and differs according to the rules prevailing in the several countries, but is usually as above stated. In Great Britain no hits above the collar-bones count, while in America the target is only the left breast between the median line and a line running from the armpit to the belt. The reason for this limitation is to encourage accuracy.

Attacks are either "primary" or "secondary." *Primary Attacks* are those initiated by a fencer before his adversary has made any offensive movement, and are divided into "Simple," "Feint" and "Force" attacks.

Simple Attacks, the characteristic of which is pace, are those made with one simple movement only and are four in number, viz. the "Straight Lunge," the "Disengagement," the

"Counter-disengagement" and the "Cut-over." The *Straight-Lunge* (*coup droit*), used when the adversary is not properly covered when on guard, is described above under "Lunge." The Disengagement is made by dropping the point of the foil under the opponent's blade and executing a straight lunge on the other side. It is often used to take an opponent unawares or when he presses unduly hard on your blade. The Counter-disengagement is used when the adversary moves his blade, i.e. changes the line of engagement, upon which you execute a narrow circle, avoiding his blade, and thrust in your original line. The Cut-over (*coupé*) is a disengagement executed by passing the point of the foil over that of the adversary and lunging in the opposite line. The preliminary movement of raising the point is made by the action of the hand only, the arm not being drawn back.

Feint Attacks, deceptive in character, are those which are preceded by one or more feints, or false thrusts made to lure the adversary into thinking them real ones. A feint is a simple extension, often with a slight movement of the body, threatening the adversary in a certain line, for the purpose of inducing him to parry on that side and thus leave the other open for the real thrust. At the same time any movement of the blade or any part of the body tending to deceive the adversary in regard to the nature of the attack about to follow, must also be considered a species of feint. The principal feint attacks are the "One-Two," the "One-Two-Three" and the "Double."

The "One-Two" is a feint in one line, followed (as the adversary parries) by a thrust in the original line of engagement. Thus, being engaged in quarte, you drop your point under the adversary's blade and extend your arm as if to thrust at his left breast, but instead of doing this, the instant he parries you move your point back again and lunge in quarte, i.e. on the side on which you were originally engaged. In feinting it is necessary that the extension of the arm and blade be so complete as really to compel the adversary to believe it a part of a real thrust in that line.

The "One-Two-Three" consists of two feints, one at each side, followed by a thrust in the line opposite to that of the original engagement. Thrusts preceded by three feints are also sometimes used. It is evident that the above attacks are useless if the adversary parries by a counter (circular parry), which must be met by a "Double." This is executed by feinting and, upon perceiving that the adversary opposes with a circular parry, by following the circle described by his point with a similar circle, deceiving (i.e. avoiding contact with) his blade and thrusting home.

The "Double," which is a favourite manœuvre in fencing, is a combination of a disengagement and a counter-disengagement.

Force-Attacks, the object of which is to disconcert the opponent by assaulting his blade, are various in character, the principal ones being the "Beat," the "Press," the "Glide" and the "Bind." The "Beat" is a quick, sharp blow of the forte of the foil upon the foible of the adversary's, for the purpose of opening a way for a straight lunge which follows instantly. The blow is made with the hand only. A "false beat" is a lighter blow made for the purpose of drawing out or disconcerting the opponent, and is often followed by a disengagement. The "Press" is similar in character to the beat, but, instead of striking the adverse blade, a sudden pressure is brought to bear upon it, sufficiently heavy to force it aside and allow one's own blade to be thrust home. A "false press" may be used to entice the adversary into a too heavy responsive pressure, which may then be taken advantage of by a disengagement. The "Traverse" (Fr. *froissé*, Ital. *striscio*) is a prolonged press carried sharply down the adverse blade towards the handle. The "Glide" ("Graze," Fr. *coulé*) is a stealthy sliding of one's blade down that of the adversary, without his notice, until a straight thrust can be made inside his guard. It is also used as a feint before a disengage. The "Bind" (*liement*) consists in gaining possession of the adversary's foible with one's forte, and pressing it down and across into the opposite low line, when one's own point is thrust home, the adversary's blade being still held by one's hilt. It may be

also carried out from a low line into a high one. The bind is less used in the French school than in the Italian. The "Flanconnade" is a bind made by capturing the adversary's blade in high quarte, carrying it down and thrusting in the outside line with strong opposition. Another attack carried out by means of a twist and thrust is the "Cross" (*croisé*), which is executed when the adversary's blade is held low by passing one's point over his wrist and forcing down both blades into seconde with a full extension of the arm. The result is to create a sudden and wide opening, and often disarms the adversary.

Secondary Attacks are those made (1) just as your adversary himself starts to attack; (2) during his attack; and (3) on the completion of his attack if it fails.

1. "Attacks on the Preparation" are a matter of judgment and quickness. They are usually attempted when the adversary is evidently preparing a complicated attack, such as the "one-two-three" or some other manoeuvre, involving one or more preliminary movements. At such a time a quick thrust will often catch him unawares and score. Opportunities for preparation attacks are often given when the adversary attempts a beat preliminary to his thrust; the beat is frustrated by an "absence of the blade," *i.e.* your blade is made to avoid contact with his by a narrow movement, and your point thrust home into the space left unguarded by the force of his unresisted beat. Or the adversary himself may create an "absence" by suddenly interrupting the contact of the blades, in the hope that, by the removal of the pressure, your blade will fly off to one side, leaving an opening; if, however, you are prepared for his "absence" a straight thrust will score.

2. The chief "Attacks on the Development," or "Counter Attacks," are the "Stop Thrust" and the "Time Thrust," both made while the adversary is carrying out his own attack. The "Stop Thrust" (*coup d'arrêt*) is one made after the adversary has actually begun an attack involving two or more movements, and is only justified when it can be brought off without your being hit by the attacking adversary's point on any part of the person. The reason for this is, that the rules of fencing decree that the fencer attacked must parry, and that, if he disregards this and attempts a simultaneous counter attack, he must touch his opponent while totally avoiding the latter's point. Should he, however, be touched, even on the foot or mask, by the adversary, his touch, however good, is invalid. If both touches are good, that of the original attacker only counts. Stop thrusts are employed mostly against fencers who attack wildly or without being properly covered. The "Time Thrust" is delivered with opposition upon the adversary's composite attack (one involving several movements), and, if successful, generally parries the original attack at the same time. It is not valid if the fencer employing it is touched on any part of the person.

3. "Attacks on the Completion" (*i.e.* of the adversary's attack) are "Ripostes," "Counter-ripostes," "Remises" and "Renewals of Attack."

The *Riposte* (literally, response) is an attack made, immediately after parrying successfully, by merely straightening the arm, the body remaining immovable. The "counter-riposte" is a riposte made after parrying the adversary's riposte, and generally from the position of the lunge, or while recovering from it, since one must have attacked with a full lunge if the adversary has had an opportunity to deliver a riposte. There are three kinds of ripostes: direct, with feints and after a pause.

The "direct riposte" may be made instantly after parrying the adversary's thrust by quitting his blade and straightening the arm, so that the point will touch his body on the nearest and most exposed part; or by not quitting his blade but running yours quickly down his and at the same time keeping a strong opposition ("riposte d'opposition"). The quickest direct riposte is that delivered after parrying quarte (for a right-hand fencer), and is called by the French the riposte of "*tac-au-tac*," imitative of the sudden succession of the click of the parry and the tap of the riposting fencer's point on his adversary's breast. In making "ripostes with a feint" the point is not jabbed on to the opponent's breast immediately after the parry, but one or more

preliminary movements precede the actual riposte, such as a disengagement, a cut-over or a double.

Ripostes with a pause (*à temps perdu*, with lost time) are made after a second's hesitation, and are resorted to when the fencers are too near for an accurate direct riposte, or to give the adversary time to make a quick parry, which is then deceived.

The *remise* is a thrust made after one's first thrust has been parried and in the same line; it must be made in such a way that the adversary's justified riposte is at the same time parried by opposition or completely avoided. It is really a renewal of the attack in the original line, while the so-called "renewal of attack" ("*redoublement d'attaque*") is a second thrust which ignores the adversary's riposte, but made in a different line. Both the remise and the renewal are valid only when the adversary's riposte does not hit.

"False Attacks" are broad movements made for the purpose of drawing the adversary out or of disconcerting him. They may consist of an advance, an extension, a change of engagement, an intentional uncovering by taking a wide guard (called "invitation guard"), or any movement or combination of movements tending to make the adversary believe that a real attack is under way.

"The Assault" is a formal fencing bout or series of bouts in public, while formal fencing in private is called "loose play" or a "friendly bout." Bouts between fencers take place on a platform about 24 ft. long and 6 ft. wide (in the United States 20 X 3 ft.). Formal bouts are usually for a number of touches, or for a certain number of minutes, the fencer who touches oftenest winning. The judges (usually three or five) are sometimes empowered to score one or more points against a competitor for breaches of good form, or for overstepping the space limits. In the United States bouts are for four minutes, with a change of places after two minutes, and the competitors are not interrupted, the winner being indicated by a vote of the judges, who take into account touches and style. In all countries contestants are required to wear jackets of a light colour, so that hits may be easily seen. Audible acknowledgment of all touches, whether on the target or not, is universally considered to be a fencer's duty. Fencing competitions are held in Great Britain under the rules of the Amateur Fencing Association, and in the United States under those of the Amateur Fencers' League of America.

Fencing Terms (not mentioned above): "*Cavazione*," Ital. for disengagement. "Contraction, Parries of," those which do not parry in the simplest manner, but drag the adverse blade into another line, *e.g.* to parry a thrust in high sixte by counter of quarte. "*Controtempo*," Ital. for time-thrust. "Coronation," an attack preceded by a circular movement from high sixte to high quarte (and vice versa) made famous by Lafaugère. "*Corps-à-corps*" (body to body), the position of two fencers who are at such close quarters that their persons touch; when this occurs the fencers must again come on guard. "*Coulé*," Fr. for glide. "Disarm," to knock the foil out of the adversary's hand; it is of no value in the French school. "Double Hit," when both fencers attack and hit at the same time; neither hit counts. "*Filo*," Ital. for glide (graze). "Flying Cut-over," a cut-over executed as a continuation of a parry, the hand being drawn back towards the body. "*Incontro*," Ital. for double attack. "Give the blade," to allow the adversary easy contact with the foil; it is often resorted to in order to tempt the adversary into a beat or bind. "Menace," to threaten the adversary by an extension and forward movement of the trunk. "*Mur*," see "Salute." "Passage of arms," a series of attacks and parries, ending in a successful hit. "Phrase of arms," a series of attacks and parries ending in a hit or invalidation. "Invalidation," a hit on some part of the person outside the target, made by the fencer whose right it is at that moment to attack or riposte; such a hit invalidates one made simultaneously or subsequently by his opponent, however good. "Rebeat," two beats, executed as quickly as possible together, one on each side of the adversary's blade. "*Reprises d'attaque*," Fr. for renewed attacks. "Salute," the courteous salutation of the public and the adversary before and after a bout. A more elaborate salute, called by the French the *Mur*, consists of a series of parries, lunges and other evolutions carried out by both fencers at the same time. Important exhibition assaults are usually preceded by the *Mur*, which is called in English the Grand Salute. "*Septime enveloppée*," a riposte by means of a twist and thrust after a parry in septime. It envelops and masters the adverse blade, whence the name. "Secret thrusts," the French "*bottes secrètes*," pretended infallible attacks of which the user is supposed alone to

know the method of execution; they have no real existence. "Sforza," Ital. for disarmament. "Scandaglio," Ital. for examination, studying the form of an opponent at the beginning of a bout. "Toccatol" Ital. for "Touched!"; Fr. "Touché."

BIBLIOGRAPHY.—The literature of foil-fencing is practically identical with that of the art in general (see FENCING). The following modern works are among the best. French School: *Fencing*, in the Badminton library (1897); *Foil and Sabre*, by L. Rondelle (Boston, 1892); "Fencing," by C. Prevost in the *Encyclopaedia of Sport* (1901); *Fencing*, by Edward Breck (New York, 1906). Italian school: *Istruzione per la scherma, &c.*, by S. de Frae (Milan, 1885); *La Scherma italiana di spada e di sciabola*, by F. Masiello (Florence, 1887). (E. B.)

FOIX, PAUL DE (1528–1584), French prelate and diplomatist. He studied Greek and Roman literature at Paris, and jurisprudence at Toulouse, where shortly after finishing his curriculum he delivered a course of lectures on civil law, which gained him great reputation. At the age of nineteen he was named councillor of the parlement of Paris. Having in this capacity expressed himself favourable to the adoption of mild measures in regard to certain persons accused of Lutheranism, he was arrested, but escaped punishment, and subsequently regained the favour of the French court. At the end of 1561 he was sent ambassador to England, where he remained four years. He was then sent to Venice, and returned a short time afterwards to England to negotiate a marriage between Queen Elizabeth and the duke of Anjou. He again fulfilled several important missions during the reign of Henry III. of France. In 1577 he was made archbishop of Toulouse, and in 1579 was appointed ambassador to Rome, where he remained till his death in 1584.

Les Lettres de Messire de Paul de Foix, archevesque de Toloze et ambassadeur pour le roy auprès du pape Grégoire XIII, au roi Henry III, were published in 1628, but there are some doubts as to their authenticity. See *Gallia Christiana* (1715 seq.); M. A. Muret, *Oraison funèbre de Paul de Foix* (Paris, 1584); "Lettres de Catherine de Médicis," edited by Hector de la Ferrière (Paris, 1880 seq.) in the *Collection de documents inédits sur l'histoire de France*.

FOIX, a town of south-western France, in the middle ages capital of the counts of Foix, and now capital of the department of Ariège, 51 m. S. of Toulouse, on the Southern railway from that city to Ax. Pop. (1906) town, 4498; commune, 6750. It is situated between the Ariège and the Arget at their confluence. The old part of the town, with its ill-paved winding streets and old houses, is dominated on the west by an isolated rock crowned by the three towers of the castle (12th, 14th and 15th centuries), while to the south it is limited by the shady Promenade de Villotte. The chief church is that of St Volusien, a Gothic building of the 14th century. The town is the seat of a prefecture, a court of assizes and a tribunal of first instance, and has a lycée, training colleges, a chamber of commerce and a branch of the Bank of France. Flour-milling and iron-working are carried on. Foix probably owes its origin to an oratory founded by Charlemagne. This afterwards became an abbey, in which were laid the remains of St Volusien, archbishop of Tours in the 5th century.

The county of Foix included roughly the eastern part of the modern department of Ariège, a region watered chiefly by the Ariège and its affluents. During the later middle ages it consisted of an agglomeration of small holdings ruled by lords, who, though subordinate to the counts of Foix, had some voice in the government of the district. Protestantism obtained an early entrance into the county, and the religious struggles of the 16th and 17th centuries were carried on with much implacability therein. The estates of the county, which can be traced back to the 14th century, consisted of three orders and possessed considerable power and virility. In the 17th and 18th centuries Foix formed one of the thirty-three governments of France, and in 1790 it was incorporated in the department of Ariège.

Counts of Foix.—The counts of Foix were an old and distinguished French family which flourished from the 11th to the 15th century. They were at first feudatories of the counts of Toulouse, but chafing under this yoke they soon succeeded in throwing it off, and during the 13th and 14th centuries were among the most powerful of the French feudal nobles. Living on the borders of France, having constant intercourse with

Navarre, and in frequent communication with England, they were in a position peculiarly favourable to an assertion of independence, and acted rather as the equals than as the dependents of the kings of France.

The title of count of Foix was first assumed by Roger, son of Bernard Roger, who was a younger son of Roger I., count of Carcassonne (d. 1012), when he inherited the town of Foix and the adjoining lands, which had hitherto formed part of the county of Carcassonne. Dying about 1064, Roger was succeeded by his brother Peter, who died six years later, and was succeeded in turn by his son, Roger II. This count took part in the crusade of 1095, and was afterwards excommunicated by Pope Paschal II. for seizing ecclesiastical property; but subsequently he appeased the anger of the church by rich donations, and when he died in 1125 he was succeeded by his son, Roger III. The death of Roger III. about 1149, and of his son, Roger Bernard I., in 1188, brought the county to Roger Bernard's only son, Raymond Roger, who, in 1190, accompanied the French king, Philip Augustus, to Palestine and distinguished himself at the capture of Acre. He was afterwards engaged in the wars of the Albigenses, and on being accused of heresy his lands were given to Simon IV., count of Montfort. Raymond Roger, who came to terms with the church and recovered his estates before his death in 1223, was a patron of the Provençal poets, and counted himself among their number. He was succeeded by his son, Roger Bernard II., called the Great, who assisted Raymond VII., count of Toulouse, and the Albigenses in their resistance to the French kings, Louis VIII. and Louis IX., was excommunicated on two occasions and died in 1241. His son, Roger IV., who followed, died in 1265, and was succeeded by his son, Roger Bernard III., who, more famous as a poet than as a warrior, was taken prisoner both by Philip III. of France and by Peter III. of Aragon. This count married Marguerite, daughter and heiress of Gaston VII., viscount of Béarn (d. 1290), and this union led to the outbreak of a long feud between the houses of Foix and Armagnac; a quarrel which was continued by Roger Bernard's son and successor, Gaston I., who became count in 1302, inheriting both Foix and Béarn. Becoming embroiled with the French king, Philip IV., in consequence of the struggle with the count of Armagnac, Gaston was imprisoned in Paris; but quickly regaining his freedom he accompanied King Louis X. on an expedition into Flanders in 1315, and died on his return to France in the same year. His eldest son, Gaston II., was the next count. Having become reconciled with the house of Armagnac, Gaston took part in various wars both in France and Spain, dying at Seville in 1343, when he was succeeded by his son, Gaston III. (1331–1391). Gaston III., who was surnamed Phoebus on account of his beauty, was the most famous member of the old Foix family. Like his father he assisted France in her struggle against England, being entrusted with the defence of the frontiers of Gascony; but when the French king, John II., showed a marked preference for the count of Armagnac, Gaston left his service and went to fight against the heathen in Prussia. Returning to France about 1357 he delivered some noble ladies from the attacks of the adherents of the *Jacquerie* at Meaux, and was soon at war with the count of Armagnac. During this struggle he also attacked the count of Poitiers, the royal representative in Languedoc, but owing to the intervention of Pope Innocent VI. he made peace with the count in 1360. Gaston, however, continued to fight against the count of Armagnac, who, in 1362, was defeated and compelled to pay a ransom; and this war lasted until 1377, when peace was made. Early in 1380 the count was appointed governor of Languedoc, but when Charles VI. succeeded Charles V. as king later in the same year, this appointment was cancelled. Refusing, however, to heed the royal command, and supported by the communes of Languedoc, Gaston fought for about two years against John, duke of Berry, who had been chosen as his successor, until, worsted in the combat, he abandoned the struggle and retired to his estates, remaining neutral and independent. In 1348 the count had married Agnes, daughter of Philip, count of Evreux (d. 1343), by his wife Jeanne II., queen of Navarre. By Agnes, whom he

divorced in 1373, he had an only son, Gaston, who is said to have been incited by his uncle, Charles II., king of Navarre, to poison his father, and who met his death in 1381. It is probable, as Froissart says, that he was killed by his father. Left without legitimate sons, Gaston was easily persuaded to bequeath his lands to King Charles VI., who thus obtained Foix and Béarn when the count died at Orthes in 1391. Gaston was very fond of hunting, but was not without a taste for art and literature. Several beautiful manuscripts are in existence which were executed by his orders, and he himself wrote *Déduits de la chasse des bestes sauvaiges et des oiseaulx de proyc*. Froissart, who gives a graphic description of his court and his manner of life, speaks enthusiastically of Gaston, saying: "I never saw none like him of personage, nor of so fair form, nor so well made," and again, "in everything he was so perfect that he cannot be praised too much."

Almost immediately after Gaston's death King Charles VI. granted the county of Foix to Matthew, viscount of Castelbon, a descendant of Count Gaston I. Dying without issue in 1398, Matthew's lands were seized by Archambault, count of Grailly and captal de Buch, the husband of his sister Isabella (d. 1426), who became count of Foix in 1401. Archambault's eldest son, John (c. 1382-1436), who succeeded to his father's lands and titles in 1412, had married in 1402 Jeanne, daughter of Charles III., king of Navarre. Having served the king of France in Guienne and the king of Aragon in Sardinia, John became the royal representative in Languedoc, when the old quarrel between Foix and Armagnac broke out again. During the struggle between the Burgundians and the Armagnacs, he intrigued with both parties, and consequently was distrusted by the dauphin, afterwards King Charles VII. Deserting the cause of France, he then allied himself with Henry V. of England; but when Charles VII. became king in 1422, he returned to his former allegiance and became the king's representative in Languedoc and Guienne. He then assisted to suppress the marauding bands which were devastating France; fought for Aragon against Castile; and aided his brother, the cardinal of Foix, to crush some insurgents in Aragon. Peter, cardinal of Foix (1386-1464), was the fifth son of Archambault of Grailly, and was made archbishop of Arles in 1450. He took a prominent part in the struggle between the rival popes, and founded and endowed the Collège de Foix at Toulouse. The next count was John's son, Gaston IV., who married Leonora (d. 1479), a daughter of John, king of Aragon and Navarre. In 1447 he bought the viscounty of Narbonne, and having assisted King Charles VII. in Guienne, he was made a peer of France in 1458. In 1455 his father-in-law designated him as his successor in Navarre, and Louis XI. of France gave him the counties of Rousillon and Cerdagne, and made him his representative in Languedoc and Guienne; but these marks of favour did not prevent him from joining a league against Louis in 1471. His eldest son, Gaston, the husband of Madeleine, a daughter of Charles VII. of France, died in 1470, and when Gaston IV. died two years later, his lands descended to his grandson, Francis Phoebus (d. 1483), who became king of Navarre in 1479, and was succeeded by his sister Catherine (d. 1517), the wife of Jean d'Albret (d. 1516). Thus the house of Foix-Grailly was merged in that of Albret and subsequently in that of Bourbon; and when Henry of Navarre became king of France in 1589 the lands of the counts of Foix-Grailly became part of the French royal domain. A younger son of Count Gaston IV. was John (d. 1500), who received the viscounty of Narbonne from his father and married Marie, a sister of the French king Louis XII. He was on good terms both with Louis XI. and Louis XII., and on the death of his nephew Francis Phoebus, in 1483, he claimed the kingdom of Navarre against Jean d'Albret and his wife, Catherine de Foix. The ensuing struggle lasted until 1497, when John renounced his claim. He left a son, Gaston de Foix (1489-1512), the distinguished French general, and a daughter, Germaine, who became the second wife of Ferdinand I., king of Spain. In 1507 Gaston exchanged his viscounty of Narbonne with King Louis XII. for the duchy of Nemours, and as duke of

Nemours he took command of the French troops in Italy. Having delivered Bologna and taken Brescia, Gaston encountered the troops of the Holy League at Ravenna in April 1512, and after putting the enemy to flight was killed during the pursuit. From the younger branch of the house of Foix-Grailly have also sprung the viscounts of Lautrec and of Meilles, the counts of Bénanges and Candale, and of Gurson and Fleix.

See D. J. Vaissète, *Histoire générale de Languedoc*, tome iv. (Paris, 1876); L. Flourac, *Jean I^{er}, comte de Foix, vicomte souverain de Béarn* (Paris, 1884); Le Père Anselme, *Histoire généalogique*, tome iii. (Paris, 1726-1733); Castillon, *Histoire du comte de Foix* (Toulouse, 1852); Madaune, *Gaston Phébus, comte de Foix et souverain de Béarn* (Pau, 1865); and Froissart's *Chroniques*, edited by S. Luce and G. Raynaud (Paris, 1869-1897).

FOLARD, JEAN CHARLES, CHEVALIER DE (1669-1752), French soldier and military author, was born at Avignon on the 13th of February 1669. His military ardour was first awakened by reading Caesar's *Commentaries*, and he ran away from home and joined the army. He soon saw active service, and, young as he was, wrote a manual on partisan warfare, the manuscript of which passed with Folard's other papers to Marshal Belleisle on the author's death. In 1702 he became a captain, and aide-de-camp to the duke of Vendôme, then in command of the French forces in Italy. In 1705, while serving under Vendôme's brother, the Grand Prior, Folard won the cross of St Louis for a gallant feat of arms, and in the same year he distinguished himself at the battle of Cassano, where he was severely wounded. It was during his tedious recovery from his wounds that he conceived the tactical theories to the elucidation of which he devoted most of his life. In 1706 he again rendered good service in Italy, and in 1708 distinguished himself greatly in the operations attempted by Vendôme and the duke of Burgundy for the relief of Lille, the failure of which was due in part to the disagreement of the French commanders; and it is no small testimony to the ability and tact of Folard that he retained the friendship of both. Folard was wounded at Malplaquet in 1709, and in 1711 his services were rewarded with the governorship of Bourbourg. He saw further active service in 1714 in Malta, under Charles XII. of Sweden in the north, and under the duke of Berwick in the short Spanish War of 1719. Charles XII. he regarded as the first captain of all time, and it was at Stockholm that Folard began to formulate his tactical ideas in a commentary on Polybius. On his way back to France he was shipwrecked and lost all his papers, but he set to work at once to write his essays afresh, and in 1724 appeared his *Nouvelles Découvertes sur la guerre dans une dissertation de Polybe*, followed (1727-1730) by *Histoire de Polybe traduite par . . . de Thuillier avec un commentaire . . . de M. de Folard, Chevalier de l'Ordre de St Louis*. Folard spent the remainder of his life in answering the criticisms provoked by the novelty of his theories. He died friendless and in obscurity at Avignon in 1752.

An analysis of Folard's military writings brings to light not a connected theory of war as a whole, but a great number of independent ideas, sometimes valuable and suggestive, but far more often extravagant. The central point of his tactics was his proposed column formation for infantry. Struck by the apparent weakness of the thin line of battle of the time, and arguing from the *εμβολον* or *cuneus* of ancient warfare, he desired to substitute the shock of a deep mass of troops for former methods of attack, and further considered that in defence a solid column gave an unshakable stability to the line of battle. Controversy at once centred itself upon the column. Whilst some famous commanders, such as Marshal Saxe and Guido Starhemberg, approved it and put it in practice, the weight of military opinion throughout Europe was opposed to it, and eventually history justified this opposition. Amongst the most discriminating of his critics was Frederick the Great, who is said to have invited Folard to Berlin. The Prussian king certainly caused a *précis* to be made by Colonel von Seers, and wrote a preface thereto expressing his views. The work (like others by Frederick) fell into unauthorized hands, and, on its publication (Paris, 1760) under the title *Esprit du Chev. Folard*, created a great impression. "Thus kept within bounds," said

the prince de Ligne, "Folard was the best author of the time." Frederick himself said tersely that "Folard had buried diamonds in a rubbish-heap." Thus began the controversy between line and column formations, which long continued and influenced the development of tactics up to the most modern times. Folard's principal adherents in the 18th century were Joly de Maizeroy and Menil Durand.

See *Mémoires pour servir à l'histoire de M. le Chevalier de Folard* (Paris and Regensburg, 1753), and for a detailed account of Folard's works and those of his critics and supporters, Max Jähns, *Geschichte der Kriegswissenschaften*, vol. ii. pp. 1478-1493 (Munich and Leipzig, 1890).

FOLD, a pleat or bend in a flexible material, or a curve in any surface, whence its particular application in geology with which this article deals. The verb "to fold" (O. Eng. *fealdan*) meant originally to double back a piece of cloth or other material so as to form a pleat, whence has evolved its various senses of to roll up, to enclose, enfold or embrace as with the arms, to clasp the hands or arms together, &c. The word is common to Teutonic languages, cf. Ger. *fallen*, Dutch *vouwen* (for *vouden*), &c., and the ultimate Indo-European root is found in Gr. *πλέκειν*, Lat. *plicare*, *plectere*, to plait, pleat, weave, and in the suffixes of such words as *διπλάσιος*, *duplex*, double, *simplex*, &c. Similarly the termination "-fold" is added to numbers implying "so many," e.g. twofold, hundredfold, cf. "manifold." The similar word for an enclosure or pen for animals, especially for sheep, and hence applied in a spiritual sense to a community of worshippers, or to the whole body of Christians regarded as Christ's flock, must be distinguished. In O. Eng. it is *falæd*, and cognate forms are found in Dutch *vaalt*, &c. It apparently meant a planked or boarded enclosure, cf. Dan. *fjael*, Swed. *fjöl*, plank.

In geology, a fold is a bend or curvature in the stratified rocks of the earth's crust, whereby they have been made to take up less horizontal space. The French equivalents are *pli*, *plissement*, *ridement*; in Germany, *Falte*, *Faltung*, *Sattlung* are the terms usually employed. It is comparatively rarely that bedded rocks are observed in the position in which they were first deposited, a certain amount of buckling up or sagging down of the crust being continually in progress in one region or another. In every instance therefore where, in walking over the surface, we traverse a series of strata which gradually, and without dislocations, increase or diminish in inclination, we cross part of a great curvature in the strata of the earth's crust.

Such foldings, however, can often be distinctly seen, either on some cliff or coast-line, or in the traverse of a piece of hilly or mountainous ground. The observer cannot long continue his researches in the field without discovering that the rocks of the earth's crust have been almost everywhere thrown into curves, usually so broad and gentle as to escape observation except when specially looked for. The outcrop of beds at the surface is commonly the truncation of these curves. The strata must once have risen above the present surface, and in many cases may be found descending to the surface again with a contrary dip, the intervening portion of the undulation having been worn away.

The curvature occasionally shows itself among horizontal or gently inclined strata in the form of an abrupt inclination, and then an immediate resumption of the previous flat or sloping character. The strata are thus bent up and continue on the other side of the tilt at a higher level. Such bends are called *mono-*



FIG. 1.—Section of the Isle of Wight—a Monocline Curve. *a*, Chalk; *b*, Woolwich and Reading beds; *c*, London clay; *d*, Bagshot series; *e*, Headon series; *f*, *g*, Osborne and Bembridge series.

clines, *monocline folds* or *flexures*, because they present only one fold, or one half of a fold, instead of the two which we see in an arch or trough. The most notable instance of this structure in Britain is that of the Isle of Wight, of which a section is given in fig. 1. The Cretaceous rocks on the south side of the island rapidly rise in inclination till they become nearly vertical.

The Lower Tertiary strata follow with a similar steep dip, but rapidly flatten down towards the north coast. Some remarkable cases of the same structure have been brought to light by J. W. Powell in his survey of the Colorado region.

It much more frequently happens that the strata have been bent into arches and troughs, so that they can be seen dipping under the surface on one side of the axis of a fold, and rising up again on the other side. Where they dip away from the axis of movement the structure is termed an *anticline* or *anticlinal fold*; where they dip towards the axis, it is a *syncline* or *synclinal fold*. The diagram in fig. 2 may be taken to represent a series of strata

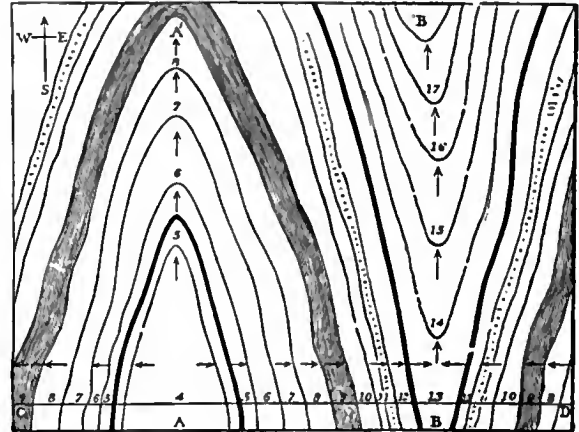
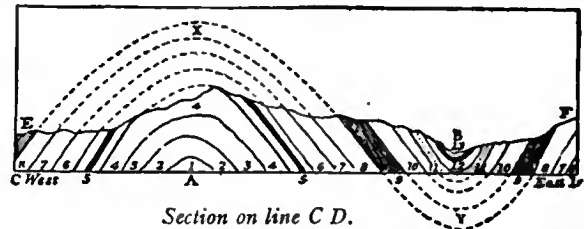

FIG. 2.—Plan of Anticlinal and Synclinal Folds.

(1-17) thrown into an anticline (AA') and syncline (BB'). A section drawn across these folds in the line CD would show the structure given in fig. 3. Here we see that, at the part of the



Section on line C D.

FIG. 3.—Section of Anticlinal and Synclinal Folds on the line CD (fig. 2).

anticlinal axis (A) where the section crosses, bed No. 4 forms the crown of the arch, Nos. 1, 2 and 3 being concealed beneath it. On the east side of the axis the strata follow each other in regular succession as far as No. 13, which, instead of passing here under the next in order, turns up with a contrary dip and forms the centre of a trough or syncline (B). From underneath No. 13 on the east side the same beds rise to the surface which passed beneath it on the west side. The particular bed marked EF has been entirely removed by denudation from the top of the anticline, and is buried deep beneath the centre of the syncline.

Such foldings of strata must always die out unless they are abruptly terminated by dislocations. In the cases given in fig. 2, both the arch and trough are represented as diminishing, the former towards the north, the latter towards the south. The observer in passing northwards along the axis of that anticline finds himself getting into progressively higher strata as the fold sinks down. On the other hand, in advancing southwards along the synclinal axis, he loses stratum after stratum and gets into lower portions of the series. When a fold diminishes in this way it is said to "nose out." In fig. 2 there is obviously a general inclination of the beds towards the north, besides the outward dip from the anticline and the inward dip from the syncline. Hence the anticline noses out to the north and the syncline to the south.

Simple Folds.—In describing rock-folds special terms have been assigned to certain portions of the fold; thus, the sloping

sides of an anticline or syncline are known as the "limbs," "slopes," "flanks" or "members" of the fold; in an anticline, the part X, fig. 3, the angle of the bend, is the "crest" or "crown" (Ger. *Gewölbbiegung*, Fr. *charnière anticlinale*), the corresponding part of a syncline being the "trough-core" or "base," Y, fig. 3 (Ger. *Muldenbiegung*, Fr. *charnière synclinale*). The portion of an anticline which has been removed by denudation is the "aerial arch," dotted in fig. 3. The innermost strata in a fold constitute the "core," arch-core A, fig. 3, or trough-core B, in the same figure. In the majority of folds the bending of the strata has taken place about an "axial plane" (often called the "axis"), which in the examples illustrated in fig. 3 would pass through the points A and B, perpendicularly to the horizontal line CD. In powerfully folded regions the axial planes of the folds are no longer upright; they may be moderately inclined, producing an "inversion," "inverted fold" or "overfold." When the inclination of the axial plane is great a "recumbent overfold" is produced (Fr. *pli couché*, Ger. *liegende Falte*). In a fold of this kind (fig. 4) we have an "arch limb" (a), a middle limb (b) and a floor or "trough limb" (c). X and Y are the upper and lower bends respectively. One of the important functions of a fold is its direction; this of course depends upon the orientation of the

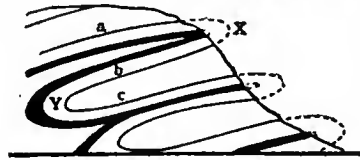

FIG. 4.

axial plane. The crest-line of an anticline or trough-line of a syncline is rarely horizontal for any great distance; its departure from horizontality is designated the "pitch," and the fold is said to pitch (or dip) towards the north, &c. Most simple folds—with the exception of very shallow curvatures of wide area,—when considered in their entirety, are seen to be somewhat canoe-shaped in form. There are three variations of the simple fold dependent upon the position of the limbs, (1) the limbs may tend to diverge as they recede from the crest (fig. 3), sometimes styled an "open anticline"; (2) the limbs may be parallel in "closed" folds (commonly known as isoclinal folding); (3) the limbs may make an open angle or widen out towards the crest (fig. 4). This is known as a fan-shaped fold (Fr. *pli en éventail*, Ger. *Fächerfalte*); another variant of the same form is the mushroom fold (Fr. *pli en champignon*). The axial plane is not always extended: it may be so abbreviated that the folding appears to have taken place about a point; anticlines of this type are variously designated "short-anticlines," "brachyantidinaux" or "domes"; similarly, there are "short-synclines," "brachysynclinaux" or "cuvettes." The dip in cases of this kind has been described as "qua-qua versal" or "periclinal."

Complex Folding.—Sometimes a simple fold has been itself subjected to further folding repeated more than once, it is then termed a "refolded fold" (Fr. *pli replié*); fine examples may be observed in the Alps and in other mountain chains. A great regional major fold containing within itself a number of minor "special" or subsidiary folds is described as a "geanticline" (Fr. *structure en éventail composé*), or as a "geosyncline" (Fr. *structure en éventail renversé*). Even folds of lesser magnitude may be highly complex in regions of extreme crustal movement, and may contain smaller folds of the first, second, third or higher order (Fr. *couches gaufrées* [fig. 5]). In its smaller manifestation, this class of folding passes into "crumpling" or "puckering," where quite a large number of folds may be crowded into a single hand specimen. In "frilling" or "frilled structure" the folds have still smaller amplitude, and in many highly corrugated rocks minute folds are observable with the microscope that do not appear to the unaided eye. When a series of adjacent isoclinal overfolds has passed into a series of thrusts (see FAULT), the so-called "imbricated" structure (Fr. *structure imbriquée*, Ger. *Schuppenstruktur*) is generated. Occasionally crust-blocks resembling "graben" and "horsts" are circumscribed by folds instead of faults; when this is so they have been called respectively "infolded graben" or "overfolded horsts."

The heterogeneous character of great masses of strata has always had a marked influence on the nature of the folding; some beds have yielded much more readily than others, certain beds will be found to be faulted, while those above and below have folded without fracture. In many examples of apparent plasticity it can be shown that this effect has been produced by an infinite number of minute slippings within the rock substance.

The larger rock folds have produced important economic

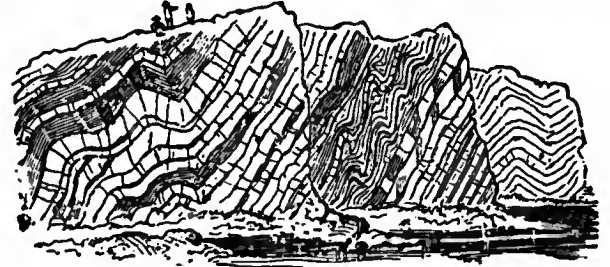

FIG. 5.—Curved and Contorted Rocks, near Old Head of Kinsale. (Du Noyer.)

results. For example, in many coal regions the deposits have been conserved in some districts in the synclines or "basins," while they have been removed by denudation from the uplifted anticlines in others. Near the crest of anticlines is commonly an enriched portion of the ground in mineralized districts; and, in the case of water supply, the tilt of the strata determines the direction of the underground flowage. Again, the most convenient site for oil wells is the crest of an anticline or "dome," where an impervious stratum imprisons the gas and oil in a subjacent saturated layer under pressure.

For a discussion of the question of the distribution and arrangement of the great folded regions of the earth's crust, see E. Suess, *Das Antlitz der Erde*, English translation, *The Face of the Earth*, vols. i., ii., iii., iv. (Oxford). See also E. de Margerie and A. Heim, *Les Dislocations de l'écorce terrestre* (Zurich, 1888); A. Rothpletz, *Geotektonische Probleme* (Stuttgart, 1894).

FOLENGO, TEOFILO (1491-1544), otherwise known as Merlino Coccajo or Cocajo, one of the principal Italian macaronic poets, was born of noble parentage at Cipada near Mantua on the 8th of November 1491. From his infancy he showed great vivacity of mind, and a remarkable cleverness in making verses. At the age of sixteen he entered the monastery of Monte Casino near Brescia, and eighteen months afterwards he became a professed member of the Benedictine order. For a few years his life as a monk seems to have been tolerably regular, and he is said to have produced a considerable quantity of Latin verse, written, not unsuccessfully, in the Virgilian style. About the year 1516 he forsook the monastic life for the society of a well-born young woman named Girolama Dieda, with whom he wandered about the country for several years, often suffering great poverty, having no other means of support than his talent for versification. His first publication was the *Merlini Coccaii macaronicon*, which relates the adventures of a fictitious hero named Baldus. The coarse buffoonery of this work is often relieved by touches of genuine poetry, as well as by graphic descriptions and acute criticisms of men and manners. Its macaronic style is rendered peculiarly perplexing to the foreigner by the frequent introduction of words and phrases from the Mantuan patois. Though frequently censured for its occasional grossness of idea and expression, it soon attained a wide popularity, and within a very few years passed through several editions. Folengo's next production was the *Orlandino*, an Italian poem of eight cantos, written in rhymed octaves. It appeared in 1526, and bore on the title-page the new pseudonym of Limerno Pitocco (Merlin the Beggar) da Mantova. In the same year, wearied with a life of dissipation, Folengo returned to his ecclesiastical obedience; and shortly afterwards wrote his *Chaos del tri per uno*, in which, partly in prose, partly in verse, sometimes in Latin, sometimes in Italian, and sometimes in macaronic, he gives a veiled account of the vicissitudes of the life he had lived under his various names.

We next find him about the year 1533 writing in rhymed octaves a life of Christ entitled *L'Umanità del Figliuolo di Dio*; and he is known to have composed, still later, another religious poem upon the creation, fall and restoration of man, besides a few tragedies. These, however, have never been published. Some of his later years were spent in Sicily under the patronage of Don Fernando de Gonzaga, the viceroy; he even appears for a short time to have had charge of a monastery there. In 1543 he retired to Santa Croce de Campesio, near Bassano; and there he died on the 9th of December 1544.

Folengo is frequently quoted and still more frequently copied by Rabelais. The earlier editions of his *Opus macaronicum* are now extremely rare. The often reprinted edition of 1530 exhibits the text as revised by the author after he had begun to amend his life.

FOLEY, JOHN HENRY (1818–1874), Irish sculptor, was born at Dublin on the 24th of May 1818. At thirteen he began to study drawing and modelling at the schools of the Royal Dublin Society, where he took several first-class prizes. In 1835 he was admitted a student in the schools of the Royal Academy, London. He first appeared as an exhibitor in 1839 with his "Death of Abel and Innocence." "Ino and Bacchus," exhibited in 1840, gave him immediate reputation, and the work itself was afterwards commissioned to be done in marble for the earl of Ellesmere. "Lear and Cordelia" and "Death of Lear" were exhibited in 1841. "Venus rescuing Aeneas" and "The Houseless Wanderer" in 1842, "Prospero and Miranda" in 1843. In 1844 Foley sent to the exhibition at Westminster Hall his "Youth at a Stream," and was, with Calder Marshall and John Bell, chosen by the commissioners to do work in sculpture for the decoration of the Houses of Parliament. Statues of John Hampden and Selden were executed for this purpose, and received liberal praise for the propriety, dignity and proportion of their treatment. Commissions of all kinds now began to come rapidly. Fanciful works, busts, bas-reliefs, tablets and monumental statues were in great numbers undertaken and executed by him with a steady equality of worthy treatment. In 1849 he was made an associate and in 1858 a member of the Royal Academy. Among his numerous works the following may be noticed, besides those mentioned above:—"The Mother"; "Egeria," for the Mansion House; "The Elder Brother in Comus," his diploma work; "The Muse of Painting," the monument of James Ward, R.A.; "Caractacus," for the Mansion House; "Helen Faucit"; "Goldsmith" and "Burke," for Trinity College, Dublin; "Faraday"; "Reynolds"; "Barry," for Westminster Palace Yard; "John Stuart Mill," for the Thames embankment; "O'Connell" and "Gough," for Dublin; "Clyde," for Glasgow; "Clive," for Shrewsbury; "Hardinge," "Canning" and "Outram," for Calcutta; "Hon. James Stewart," for Ceylon; the symbolical group "Asia," as well as the statue of the prince himself, for the Albert Memorial in Hyde Park; and "Stonewall Jackson," in Richmond, Va. The statue of Sir James Outram is probably his masterpiece. Foley's early fanciful works have some charming qualities; but he will probably always be best remembered for the workmanlike and manly style of his monumental portraits. He died at Hampstead on the 27th of August 1874, and on the 4th of September was buried in St Paul's cathedral. He left his models to the Royal Dublin Society, his early school, and a great part of his property to the Artists' Benevolent Fund.

See W. Cosmo Monkhouse, *The Works of J. H. Foley* (1875).

FOLEY, SIR THOMAS (1757–1833), British admiral, entered the navy in 1770, and, during his time as midshipman, saw a good deal of active service in the West Indies against American privateers. Promoted lieutenant in 1778, he served under Admiral (afterwards Viscount) Keppel and Sir Charles Hardy in the Channel, and with Rodney's squadron was present at the defeat of De Lángara off Cape St Vincent in 1780, and at the relief of Gibraltar. Still under Rodney's command, he went out to the West Indies, and took his part in the operations which culminated in the victory of the 12th of April 1782. In the Revolutionary War he was engaged from the first. As flag-captain to Admiral John Gell, and afterwards to Sir Hyde

Parker, Foley took part in the siege of Toulon in 1793, the action of Golfe Jouan in 1794, and the two fights off Toulon on the 13th of April and the 13th of July 1795. At St Vincent he was flag-captain to the second in command, and in the following year was sent out in command of the "Goliath" (74), to reinforce Nelson's fleet in the Mediterranean. The part played by the "Goliath" in the battle of the Nile was brilliant. She led the squadron round the French van, and this manœuvre contributed not a little to the result of the day. Whether this was done by Foley's own initiative, or intended by Nelson, has been a matter of controversy (see *Journal of the Royal United Service Institution*, 1885, p. 916). His next important service was with Nelson in the Baltic. The "Elephant" carried Nelson's flag at the battle of Copenhagen, and her captain acted as his chief-of-staff. Ill-health obliged Foley to decline Nelson's offer (made when on the point of starting for the battle of Trafalgar) of the post of Captain of the Fleet. From 1808 to 1815 he commanded in the Downs and at the peace was made K.C.B. Sir Thomas Foley rose to be full admiral and G. C. B. He died while commanding in chief at Portsmouth in 1833.

See J. B. Herbert, *Life and Services of Sir Thomas Foley* (Cardiff, 1884).

FOLI (FOLEY), ALLAN JAMES (1837–1899), Irish bass singer, was born at Cahir, Tipperary, on the 7th of August 1837; originally a carpenter, he studied under Bisaccia at Naples, and made his first appearance at Catania in 1862. From the opera in Paris he was engaged by Mapleson for the season of 1865, and appeared with much success in various parts. He sang in the first performance of *The Flying Dutchman* (Daland) in England in 1870, and in the first performance of Gounod's *Redemption* in 1882. He was distinguished in opera and oratorio alike for his vigorous, straightforward way of singing, and was in great request at ballad concerts. He died on the 20th of October 1899.

FOLIGNO (anc. *Fulginiae, q.v.*), a town and episcopal see of Umbria, Italy, 771 ft. above sea-level, in the province of Perugia, from which it is 25 m. S.E. by rail. Pop. (1901) 9532 (town), 26,278 (commune). It lies in a fertile plain, on the Topino, a tributary of the Tiber; it is almost square in shape and is surrounded by walls. It is a picturesque and interesting town; several of its churches contain paintings by Umbrian masters, notably works by Niccolò di Liberatore (or Niccolò Alunno, 1430–1502), and among them his chief work, a large altar-piece (the predella of which is in the Louvre) in S. Niccolò. The cathedral has a romanesque S. façade of 1133, restored in 1903; the interior was modernized in the 18th century. To the left of the choir is an octagonal chapel by Antonio da Sangallo the younger (1527). In the same piazza as the S. façade is the Palazzo del Governo, erected in 1350, which has a chapel with frescoes by Ottaviano Nelli of Gubbio (1424). S. Maria infra Portas is said to date from the 7th century, but from this period only the columns of the portico remain. Raphael's "Madonna di Foligno," now in the Vatican, was originally painted for the church of S. Anna. The Palazzo Orfini and the Palazzo Deli are two good Renaissance buildings.

Foligno seems to have been founded about the middle of the 8th century A.D. It changed hands often during the wars of the 13th century, and was destroyed by Perugia in 1281. From 1305 to 1439 it was governed by the family of the Trinci as deputies of the Holy See, until in the latter year one of its members went against the church. Pope Eugene IV. sent a force against Foligno, to which the inhabitants opened their gates, and the last of the Trinci, Corrado II., was beheaded. Henceforth Foligno belonged to the states of the church until 1860. It suffered from a severe earthquake in 1832. Foligno is a station on the main line from Rome (via Orte) to Ancona, and is the junction for Perugia. Three miles to the E. is the abbey of Sassovivo with cloisters of 1229, very like those of S. Paolo fuori le Mura at Rome, with pairs of small columns supporting arches, and decorations in coloured mosaic ("Cosmatesque" work). The church has been modernized.

FOLIO (properly the ablative case of the Lat. *folium*, leaf, but also frequently an adaptation of the Ital. *foglio*), a term in

bibliography and printing, with reference either to the size of paper employed, or of the book, or to the pagination. In the phrase "in folio" it means a sheet of paper folded once, and thus a book bound up in sheets thus folded is a book of the largest size and is known as a "folio" (see BIBLIOGRAPHY). Similarly, "folio" is one of the sizes of paper adapted to be thus folded (see PAPER). In book-keeping the word is used for a page in a ledger on which the credit and debtor account is written; in law-writing, for a fixed number of words in a legal document, used for measurement of the length and for the addition of costs. In Great Britain, a "folio" is taken to contain 72 words, except in parliamentary and chancery documents, when the number is 90. In the U.S.A. 100 words form a "folio."

FOLIUM, in mathematics, a curve invented and discussed by René Descartes. Its cartesian equation is $x^3 + y^3 = 3axy$. The curve is symmetrical about the line $x = y$, and consists of two infinite branches asymptotic to the line $x + y + a = 0$ and a loop in the first quadrant. It may be traced by giving m various values in the equations $x = 3am / (1 + m^3)$, $y = 3am^2 / (1 + m^3)$, since by eliminating m between these relations the equation to the curve is obtained. Hence it is *unicursal* (see CURVE). The area of the loop, which equals the area between the curve

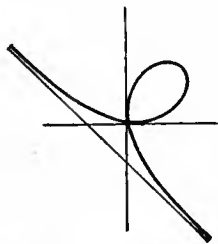

and its asymptote, is $3a^2/2$.

FOLKES, MARTIN (1690–1754), English antiquary, was born in London on the 29th of October 1690. He was educated at Saumur University and Clare College, Cambridge, where he so distinguished himself in mathematics that when only twenty-three years of age he was chosen a fellow of the Royal Society. He was elected one of the council in 1716, and in 1723 Sir Isaac Newton, president of the society, appointed him one of the vice-presidents. On the death of Newton he became a candidate for the presidency, but was defeated by Sir Hans Sloane, whom, however, he succeeded in 1741; in 1742 he was made a member of the French Academy; in 1746 he received honorary degrees from Oxford and Cambridge. In 1733 he set out on a tour through Italy, in the course of which he composed his *Dissertations on the Weights and Values of Ancient Coins*. Before the Society of Antiquaries, of which he was president from 1749 to 1754, he read in 1736 his *Observations on the Trajan and Antonine Pillars at Rome* and his *Table of English Gold Coins from the 18th Year of King Edward III*. In 1745 he printed the latter with another on the history of silver coinage. He also contributed both to the Society of Antiquaries and to the Royal Society other papers, chiefly on Roman antiquities. He married in 1714 Lucretia Bradshaw, an actress who had appeared at the Haymarket and Drury Lane (see Nichols's *Lit. Anecdot.* ii. 578–598).

For Sir John Hill's attack on Folkes (*Review of the Works of the Royal Soc.*, 1751), see D'Israeli, *Calamities and Quarrels of Authors* (1860), pp. 364–366.

FOLKESTONE, a municipal borough, seaport and watering-place of Kent, England, within the parliamentary borough of Hythe, 71 m. S.E. by E. of London by the South-Eastern & Chatham railway. Pop. (1891) 23,905; (1901) 30,650. This is one of the principal ports in cross-Channel communications, the steamers serving Boulogne, 30 m. distant. The older part of Folkestone lies in a small valley which here opens upon the shore between steep hills. The more modern portions extend up the hills on either hand. To the north the town is sheltered by hills rising sharply to heights of 400 to 500 ft., on several of which, such as Sugarloaf and Castle Hills, are ancient earthworks. Above the cliff west of the old town is a broad promenade called the Lees, commanding a notable view of the channel and connected by lifts with the shore below. On this cliff also stands the parish church of St Mary and St Eanswith, a cruciform building of much interest, with central tower. It is mainly Early English, but the original church, attached to a Benedictine priory, was founded in 1095 on the site of a convent established

by Eanswith, daughter of Eadbald, king of Kent in 630. The site of this foundation, however, became endangered by encroachments of the sea. The monastery was destroyed at the dissolution of religious houses by Henry VIII. Folkestone inner harbour is dry at low water, but there is a deep water pier for use at low tide by the Channel steamers, by which not only the passenger traffic, but also a large general trade are carried on. The fisheries are important. Among institutions may be mentioned the grammar school, founded in 1674, the public library and museum, and a number of hospitals and sanatoria. The discontinued Harveian Institution for young men was named after William Harvey, discoverer of the circulation of the blood, a native of Folkestone (1578), who is also commemorated by a tercentenary memorial on the Lees. Folkestone is a member of the Cinque Port of Dover. It is governed by a mayor, 7 aldermen and 21 councillors. Area, 2522 acres. To the west of Folkestone, close to Shorncliffe camp, is the populous suburb of Cheriton (an urban district, pop. 7091).

Folkestone (Folcestan) was among the possessions of Earl Godwine and was called upon to supply him with ships when he was exiled from England; at the time of the Domesday Survey it belonged to Odo, bishop of Bayeux. From early times it was a member of the Cinque Port of Dover, and had to find one out of the twenty-one ships furnished by that port for the royal service. It shared the privileges of the Cinque Ports, whose liberties were exemplified at the request of the barons of Folkestone by Edward III. in 1330. The corporation, which was prescriptive, was entitled the mayor, jurats and commonalty of Folkestone. The history of Folkestone is a record of its struggle against the sea, which was constantly encroaching upon the town. In 1629 the inhabitants, impoverished by their losses, obtained licence to erect a port. By the end of the 18th century the town had become prosperous by the increase of its fishing and shipping trades, and by the middle of the 19th century one of the chief health and pleasure resorts of the south coast.

FOLKLAND (*folcland*). This term occurs three times in Anglo-Saxon documents. In a law of Edward the Elder (c. i. 2) it is contrasted with bookland in a way which shows that these two kinds of tenure formed the two main subdivisions of landownership: no one is to deny right to another in respect of folkland or bookland. By a charter of 863 (Cod. Dipl. 281), King Æthelberht exchanges five hides of folkland for five hides of bookland which had formerly belonged to a thane, granting the latter for the newly-acquired estates exemption from all fiscal exactions except the threefold public obligation of attending the fyrd and joining in the repair of fortresses and bridges. Evidently folkland was not free from the payment of *gafol* (land tax) and providing quarters for the king's men. In ealdorman Alfred's will the testator disposes freely of his bookland estates in favour of his sons and his daughter, but to a son who is not considered as rightful offspring five hides of folkland are left, provided the king consents. It is probable that folkland is meant in two or three cases when Latin documents speak of *terra rei publicae jure possessa*.

Two principal explanations have been given to this term. Allen thought that folkland was similar to the Roman *ager publicus*: it was the common property of the nation (*folc*), and the king had to dispose of it by carving out dependent tenures for his followers more or less after the fashion of continental *beneficia*. These estates remained subject to the superior ownership of the folk and of the king: they could eventually be taken back by the latter and, in any case, the heir of a holder of folkland had to be confirmed in possession by the king. A letter of Bede to the archbishop Ecgbert of York may be interpreted to apply to this kind of tenure. Kemble, K. Maurer, H. C. Lodge, Stubbs and others followed Allen's lead.

Another theory was started by Professor Vinogradoff in an article on folkland in the *English Hist. Review* for 1893. It considers folkland as landownership by folkright—at common law, as might be said in modern legal speech. In opposition to it bookland appears as landownership derived from royal privilege. The incidents recorded in the charters characterize folkland as

subject to ordinary fiscal burdens and to limitations in respect of testamentary succession. Thane Wallaf has to be relieved from fiscal exactions when his estate is converted from folkland into bookland (C.D. 281). Ealdorman Alfred's son, not being recognized as legitimate, has to claim folkland not by direct succession or devise, but by the consent of the king. These incidents and limitations are thrown into relief by copious illustrations as to the fundamental features of bookland contained in the numberless "books." These are exemptions from fiscal dues and freedom of disposition of the owner. This view of the matter has been accepted by the chief modern authorities.

BIBLIOGRAPHY.—J. Allen, *Inquiry into the Rise and Growth of Royal Prerogative in England* (London, 1849); K. Maurer, *Kritische Überschau* (1853), Band i. 102 ff.; F. W. Maitland, *Domesday Book and Beyond*, 244 ff. (Cambridge, 1897); P. Vinogradoff, "Folcland," in the *Eng. Hist. Rev.* (1893), p. 1 ff.; Sir F. Pollock, *Land Laws* (London, 1896); H. Brunner, *Deutsche Rechtsgeschichte*, Band i. (2nd ed., 293, Leipzig, 1887-1892). (P. VI.)

FOLKLORE, a term invented in 1846 by Mr W. J. Thoms as a designation for the traditional learning of the uncultured classes of civilized nations. The word has been adopted in this sense into many foreign languages; it is sometimes regarded as the equivalent of the Ger. *Volkskunde*. But folklore is, properly speaking, the "lore of the folk," while *Volkskunde* is lore or learning about the folk, and includes not only the mental life of a people, but also their arts and crafts. The term folklore is also used to designate the science which deals with folklore; the study of survivals involves the investigation of the similar customs, beliefs, &c., of races on lower planes of culture; consequently folklore, as interpreted by the English and American societies, concerns itself as much or more with savage races as with the popular superstitions of the white races.

History.—The scientific study of folklore dates back to the first quarter of the 19th century, but folklore was collected long before that date. The organized study of folklore is a thing of recent growth. The first Folklore Society was founded in London in 1878; similar bodies now exist in the United States, France, Italy, Switzerland and especially in Germany and Austria. The folk-tale makes its appearance in literature at a very early period; Egyptian examples have come down to us from the 28th century B.C. In Greece the Homeric poems contain many folk-tale incidents; for India we have the *Jatakas* and *Panchatantra*; and for the Arabs the great collection of the *Thousand and One Nights*. Another type of folk-narrative is represented by Aesop's *Fables*. Not unnaturally beliefs and customs received less attention; our knowledge of them among the ancients is as a rule pieced together. Among the oldest professed collections are J. B. Thiers (1606-1703), *Traité des superstitions* (1679), Aubrey's *Miscellanies* (1686) and H. Bourne's (1696-1733) *Antiquitates vulgares* (1725); but they belong to the antiquarian, non-scientific period.

The pioneers of the modern scientific treatment of folklore were the brothers Grimm, by the publication of their *Kinder- und Hausmärchen* (1812-1815) and *Deutsche Mythologie* (1835). They were the first to present the folk-tale in its genuine unadulterated form. They differed from their predecessors in regarding the myth, not as the result of conscious speculation, but of a mythopoeic impulse. They were, however, disposed to press modern linguistic evidence too far and make the figures of the folk-tale the lineal representatives of ancient gods, as the folk-tales themselves were of the myths. This tendency was exaggerated by their successors, J. W. Wolf, W. Rochholz and others. At the outset of his career, W. Mannhardt (1831-1880), the forerunner of the anthropological school of folklore, shared in this mistake. Breaking away eventually from the philological schools, which interpreted myths and their supposed descendants, the folk-tales, as relating to the storm, the sun, the dawn, &c. (see MYTHOLOGY), Mannhardt made folk-custom and belief his basis. To this end he set himself to collect and compare the superstitions of the peasantry; but his health was always feeble and he never completed his scheme. For a time Mannhardt's researches bore fruit neither in his own country nor abroad. In 1878 the foundation of the Folklore Society marked

a new era in England, where the philological school had had few adherents; and the anthropological school soon produced evidence of its vitality in the works of Mr Andrew Lang, Dr J. G. Frazer and Professor Robertson Smith.

With the growth of our knowledge of European folk-custom and belief on the one hand, and of rites and religions of people in the lower stages of culture on the other hand, it has become abundantly clear that there is no line of demarcation between the two. Each throws light upon the other, and the superstitions of Europe are the lineal descendants of savage creeds which have their parallels all over the world in the culture of primitive peoples.

Subdivisions.—The folklore of civilized peoples may be conveniently classified under three main heads: (1) belief and custom; (2) narratives and sayings; (3) art. These again may be subdivided. The first division, *Belief and Custom*, includes (A) Superstitious beliefs and practices, including (a) those connected with natural phenomena or inanimate nature, (b) tree and plant superstitions, (c) animal superstitions, (d) ghosts and goblins, (e) witchcraft, (f) leechcraft, (g) magic in general and divination, (h) eschatology, and (i) miscellaneous superstitions and practices; and (B) Traditional customs, including (a) festival customs for which are set aside certain days and seasons, (b) ceremonial customs on the occasion of events such as birth, death or marriage, (c) games, (d) miscellaneous local customs, such as agricultural rites connected with the corn-spirit (see DEMONOLOGY), and (e) dances. The second head of *Narratives and Sayings* may be subdivided (A) into (a) sagas or tales told as true, (b) Märchen or nursery tales, (c) fables, (d) drolls, apologues, cumulative tales, &c., (e) myths (see MYTHOLOGY), and (f) place legends; (B) into ballads and songs (in so far as they do not come under art); and (C) into nursery rhymes, riddles, jingles, proverbs, nicknames, place rhymes, &c. The third head, *Art*, subdivides into (a) folk music with ballads and songs, (b) folk drama. Any classification, however, labours under the disadvantage of separating items which properly belong together. Thus, myths are obviously the form in which some superstitions are expressed. They may also be aetiological in their nature and form an elaborate record of a custom. Eschatological beliefs naturally take the form of myths. Traditional narratives can also be classified under art, and so on.

Literature.—The literature of the subject falls into two sharply defined classes—synthetic works and collections of folklore—of which the latter are immensely more numerous. Of the former class the most important is Dr J. G. Frazer's *Golden Bough*, which sets out from the study of a survival in Roman religion and covers a wide field of savage and civilized beliefs and customs. Especially important are the chapters on agricultural rites, in which are set forth the results of Mannhardt's researches. Other important lines of folklore research in the *Golden Bough* are those dealing with spring ceremonies, with the primitive view of the soul, with animal cults, and with sun and rain charms. Mr E. S. Hartland's *Legend of Perseus* is primarily concerned with the origin of a folk-tale, and this problem in the end is dismissed as insoluble. A large part of the book is taken up with a discussion of sympathetic magic, and especially with the "life index," an object so bound up with the life of a human being that it acts as an indication of his well-being or otherwise. The importance of children's games in the study of folklore has been recognized of recent years. An admirable collection of the games of England has been published by Mrs G. L. Gomme. With the more minute study of uncivilized peoples the problem of the diffusion of games has also come to the fore. In particular it is found that the string-game called "cat's cradle" in various forms is of very wide diffusion, being found even in Australia. The question of folk-music has recently received much attention (see SONG).

BIBLIOGRAPHY.—**Introductory works:** M. R. Cox, *Introduction to Folklore*; Kaindl, *Die Volkskunde*; Marillier in *Revue de l'histoire des religions*, xliii. 166, and other works mentioned by Kaindl.

General works: J. G. Frazer, *The Golden Bough*; E. S. Hartland, *The Legend of Perseus*; A. Lang, *Custom and Myth, Myth, Ritual and Religion*; Tylor, *Primitive Culture*; Liebrecht, *Zur Volkskunde*.

British Isles. England: Burne, *Shropshire Folklore*; *Denham Tracts* (F. L. S.); Harland and Wilkinson, *Lancashire Folklore*; Henderson, *Folklore of Northern Counties*; *County Folklore Series* (Printed Extracts) of the F.L.S. Wales: Elias Owen, *Welsh Folklore*; Rhys, *Celtic Folklore*. Scotland: Dalyell, *Darker Superstitions*; Gregor, *Folklore of N.E. of Scotland*; and the works of J. G. Campbell, &c.

Germany: Grimm, *Deutsche Mythologie*, English translation by Stallybrass; Wuttke, *Der deutsche Volksaberglaube*; Meyer, *Deutsche Volkskunde*; Tetzner, *Die Slaven in Deutschland*; Mogk in Paul's *Grundriss der germanischen Philologie*, and the works cited by Kaindl (see above).

France: Sebillot's works; Rolland, *Faune populaire*; Laisnel de la Salle, *Croyances et légendes*.

On the Slavs see the works of Krauss and v. Wilslochi; for Bohemia, Grohmann, *Aberglaube*; for Greece, Abbott, *Macedonian Folklore*, and Rennell Rodd, *Folklore of Greece*; for Italy, Pitré's bibliography; for India, Crooke's works, and the *Indian Antiquary*. For questionnaires see *Handbook of Folklore* (Folklore Soc.); Sebillot, *Essai de questionnaires*; *Journal of American Folklore* (1890, &c.); and Kaindl's *Volkskunde*. For a bibliography of folk-tales see Hartland, *Mythology and Folk-tales*; to his list may be added Petitot's *Légendes indiennes*; Rand, *Legends of the Micmacs*; Lummit, *The Man who Married the Moon*; and the publications of the American Folklore Society. For other works see bibliographies in *Folklore* and other periodicals. On special points may be mentioned Miss Cox's *Cinderella* (Folklore Society); Kohler's works, &c. (see also bibliography to the article TALE). For games see Gomme, *English Games*; Culin, *Korean Games*; Rochholz, *Alemannisches Kinderlied*; Böhme, *Deutsches Kinderlied*; Handermann, *Volks- und Kinderspiele*; Jayne, *String Figures*, &c.; and the bibliography to DOLL. See also Sonnenschein's *Best Books*.

The following is a list of the more important Societies and publications:—

England: Folklore Society; Folksong Society; Gipsy-lore Society. U.S.A.: American Folklore Society.

France: *Société des traditions populaires*.

Germany: *Verein für Volkskunde*; *Hessische Vereinigung für Volkskunde*; and minor societies in Saxony, Silesia and other provinces.

Austria: *Verein für österreichische Volkskunde*.

Switzerland: *Schweizerische Gesellschaft für Volkskunde*.

Italy: *Società per lo studio delle tradizioni popolari*.

In addition to these, the anthropological societies devote more or less attention to folklore. Besides the publications of the societies mentioned above, minor societies or individuals are responsible for the following among others: Belgium, *Wallonia*; Poland, *Wisla*; France, *Melusine* (1878, 1883-1901); Bohemia, *Cesky Lid*; Denmark, *Dania*, &c.; Germany, *Zeitschrift für Völkerpsychologie* (1859-1890); *Am Urquell* (1890-1898). (N. W. T.)

FOLLEN, AUGUST (or, as he afterwards called himself, ADOLF) LUDWIG (1794-1855), German poet, was born at Giessen on the 21st of January 1794, the son of a district judge. He studied theology at Giessen and law at Heidelberg, and after leaving the university edited the Elberfeld *Allgemeine Zeitung*. Suspected of being connected with some radical plots, he was imprisoned for two years in Berlin. When released in 1821 he went to Switzerland, where he taught in the canton school at Aarau, farmed from 1847-1854 the estate of Liebenfels in Thurgau, and then retired to Bern, where he lived till his death on the 26th of December 1855. Besides a number of minor poems he wrote *Harfengrüsse aus Deutschland und der Schweiz* (1823) and *Malegys und Vivian* (1829), a knightly romance after the fashion of the romantic school. Of his many translations, mention may be made of the Homeric Hymns in collaboration with R. Schwenck (1814), Tasso's *Jerusalem Delivered* (1818) and *Siegfrieds Tod* from the *Nibelungenlied* (1842); he also collected and translated Latin hymns and sacred poetry (1819). In 1846 he published a brief collection of sonnets entitled *An die göttlosen Nichtswürdiche*. This was aimed at the liberal philosopher Arnold Ruge, and was the occasion of a literary duel between the two authors. Follen's posthumous poem *Tristans Eltern* (1857) may also be mentioned, but his best-known work is a collection of German poetry entitled *Bildersaal deutscher Dichtung* (1827).

FOLLEN, KARL (1795-1840), German poet and patriot, brother of A. L. Follen, was born at Romrod in Hesse-Darmstadt, on the 5th of September 1795. He first studied theology at Giessen, but after the campaign of 1814, in which, like his brother August, he took part as a Hessian volunteer, began the study of jurisprudence, and in 1818 established himself as *Privatdocent*

of civil law at Giessen. Owing to being suspected of political intrigues, he removed to Jena, and thence, after the assassination of Kotzebue, fled to France. Here again the political murder of the duc de Berry, on the 14th of January 1820, led to Follen being regarded as a suspect, and he accordingly took refuge in Switzerland, where he taught for a while at the cantonal school at Coire and at the university of Basel; but the Prussian authorities imperatively demanding his surrender, he sought in 1824 the hospitality of the United States of America. Here he became an instructor in German at Harvard in 1825, and in 1830 obtained an appointment as professor of German language and literature there; but his anti-slavery agitation having given umbrage to the authorities, he forfeited his post in 1835, and was ordained Unitarian minister of a chapel at Lexington in Massachusetts in 1836. He perished at sea on board a steamboat which was totally consumed by fire while on a voyage from New York to Boston, on the night of the 13th-14th of January 1840. Follen was the author of several celebrated patriotic songs written in the interests of liberty. The best is perhaps *Horch auf, ihr Fürsten! Du Volk, horch auf!* of which Johannes Wit, called von Dörring (1800-1863), was long, though erroneously, considered the author. It was published in A. L. Follen's collection of patriotic songs, *Freie Stimmen frischer Jugend*.

His wife Elisa Lee (1787-1860), an American authoress of some reputation, published after his death his lectures and sermons, with a biography written by herself (5 vols., Boston, 1846).

FOLLETT, SIR WILLIAM WEBB (1798-1845), English lawyer, was born at Topsham in Devonshire on the 2nd of December 1798. He was the son of Captain Benjamin Follett, who had retired from the army in 1790, and engaged in business at Topsham. He received his education at Exeter grammar school and Trinity College, Cambridge, graduating in 1818. He had entered the Inner Temple in 1816 and began to practise as a pleader below the bar in 1821, but was called to the bar in 1824, and joined the western circuit in 1825. At the very outset his great qualifications were universally recognized. He was thoroughly master of his profession, and his rapid rise in it was due not only to his quick perception and sound judgment, but to his singular courtesy, kindness and sweetness of temper. In 1830 he married the eldest daughter of Sir Ambrose Harding Gifford, chief justice of Ceylon. In 1835 he was returned to parliament for Exeter. In parliament he early distinguished himself, and under the first administration of Sir Robert Peel was appointed solicitor-general (November 1834); but resigned with the ministry in April 1835. In the course of this year he was knighted. On the return of Peel to power in 1841 Sir William was again appointed solicitor-general, and in April 1844 he succeeded Sir Frederick Pollock as attorney-general. But his health, which had begun to fail him in 1838, and had been permanently injured by a severe illness in 1841, now broke down, and he was compelled to relinquish practice and to visit the south of Europe. He returned to England in March 1845; but the disease, consumption, reasserted itself, and he died in London on the 28th of June following. A statue of Follett, executed by Behnes, was erected by subscription in Westminster Abbey.

FONBLANQUE, ALBANY WILLIAM (1793-1872), English journalist, descended from a noble French Huguenot family, the Greniers of Languedoc, was born in London in 1793. John Grenier, a banker, became naturalized in England under the name of Fonblanque; and his son John Samuel Martin Fonblanque (1760-1838), a distinguished equity lawyer, and the author of a standard legal work, a *Treatise on Equity*, was the father of Albany Fonblanque; he represented the borough of Camelford in parliament; and was one of the Whig friends of George IV. when prince of Wales. At fourteen young Fonblanque was sent to Woolwich to prepare for the Royal Engineers. His health, however, failed, and for two years his studies had to be suspended. Upon his recovery he studied for some time with a view to being called to the bar. At the age of nineteen (1812) he commenced writing for the newspapers, and very soon attracted notice both by the boldness and liberality of his opinions, and by

the superiority of his style to what Macaulay, when speaking of him, justly called the "rant and twaddle of the daily and weekly press" of the time. While he was eagerly taking his share in all the political struggles of this eventful period, he was also continuing his studies, devoting no less than six hours a day to the study of classics and political philosophy. Under this severe mental training his health once more broke down. His energy, however, was not impaired. He became a regular contributor to the newspapers and reviews, realizing a fair income which, as his habits were simple and temperate, secured him against pecuniary anxieties.

From 1820 to 1830 Albany Fonblanque was successively employed upon the staff of *The Times* and the *Morning Chronicle*, whilst he contributed to the *Examiner*, to the *London Magazine* and to the *Westminster Review*. In 1828 the *Examiner* newspaper, which had been purchased by the Rev. Dr Fellowes, author of the *Religion of the Universe*, &c., was given over to Fonblanque's complete control; and for a period of seventeen years (1830 to 1847) he not only sustained the high character for political independence and literary ability which the *Examiner* had gained under the direction of Leigh Hunt and his brother, John Hunt, but even compelled his political opponents to acknowledge a certain delight in the boldness and brightness of the wit directed against themselves. When it was proposed that the admirers and supporters of the paper should facilitate a reduction in its price by the payment of their subscription ten years in advance, not only did Mr Edward Bulwer (Lord Lytton) volunteer his aid, but also Mr Disraeli, who was then coquetting with radicalism. During his connexion with the *Examiner*, Fonblanque had many advantageous offers of further literary employment; but he devoted his energies and talents almost exclusively to the service of the paper he had resolved to make a standard of literary excellence in the world of journalism. Fonblanque was offered the governorship of Nova Scotia; but although he took great interest in colonial matters, and had used every effort to advocate the more generous political system which had colonial self-government for its goal, he decided not to abandon his beloved *Examiner* even for so sympathetic an employment. In 1847, however, domestic reasons induced him to accept the post of statistical secretary of the Board of Trade. This of course compelled him to resign the editorship of the *Examiner*, but he still continued to contribute largely to the paper, which, under the control of John Forster, continued to sustain its influential position. During the later years of his life Fonblanque took no prominent part in public affairs; and when he died at the age of seventy-nine (1872) he seemed, as his nephew, Edward Fonblanque, rightly observes, "a man who had lived and toiled in an age gone by and in a cause long since established."

The character of Albany Fonblanque's political activity may be judged of by a study of his *England under Seven Administrations* (1837), in comparison with the course of social and political events in England from 1826 to 1837. As a journalist, he must be regarded in the light of a reformer. Journalism before his day was regarded as a somewhat discreditable profession; men of true culture were shy of entering the hot and dusty arena lest they should be confounded with the ruder combatants who fought there before the public for hire. But the fact that Fonblanque, a man not only of strong and earnest political convictions but also of exceptional literary ability, did not hesitate to choose this field as a worthy one in which both a politician and a man of letters might usefully as well as honourably put forth his best gifts, must have helped, in no small degree, to correct the old prejudice.

See the *Life and Labours of Albany Fonblanque*, edited by his nephew, Edward Barrington de Fonblanque (London, 1874); a collection of his articles with a brief biographical notice.

FOND DU LAC, a city and the county-seat of Fond du Lac county, Wisconsin, U.S.A., about 60 m. N. of Milwaukee, at the S. end of Lake Winnebago, and at the mouth of the Fond du Lac river, which is navigable for only a short distance. Pop. (1890) 12,024; (1900) 15,110, of whom 2952 were foreign-born; (1910) 18,797. The city is a railway centre of some importance,

and is served by the Chicago, Milwaukee & St Paul, the Minneapolis, St Paul & Sault St Marie, and the Chicago & North-Western railways, by interurban electric lines, and by steamboat lines connecting through the Fox river with vessels on the Great Lakes. At North Fond du Lac, just beyond the city limits, are car-shops of the two last-mentioned railways, and in the city are manufactories of machinery, automobiles, wagons and carriages, awnings, leather, beer, flour, refrigerators, agricultural implements, toys and furniture. The total value of the city's factory products in 1905 was \$5,599,606, an increase of 95.7% since 1900. The city has a Protestant Episcopal cathedral, the Grafton Hall school for girls, and St Agnes hospital and convent, and a public library with about 25,000 volumes in 1908. The first settlers on the site of Fond du Lac arrived about 1835. Subsequently a village was laid out which was incorporated in 1847; a city charter was secured in 1852.

FONDI (anc. *Fundi*), a town of Campania, Italy, in the province of Caserta, 12 m. N.W. of Formia, and 11 m. E.N.E. of Terracina by road. Pop. (1901) 9930. It lies 25 ft. above sea-level, at the N. end of a plain surrounded by mountains, which extend to the sea. It occupies the site of the ancient Fundi, a Volscian town, belonging later to *Latium adjectum*, on the Via Appia, still represented by the modern high-road which passes through the centre of the town. It is rectangular in plan, and portions of its walls, partly in fine polygonal work and partly in *opus incertum*, are preserved. Both plan and walls date, no doubt, from the Roman period. The gate on the north-east still exists, and bears the inscription of three aediles who erected the gate, the towers and the wall. A similar inscription of three different aediles from the N.W. gate still exists, but not *in situ*. In the neighbourhood are the remains of several ancient villas, and along the Via Appia still stands an ancient wall of *opus reticulatum*, with an inscription, in large letters, of one Varronianus, the letters being at intervals of 25 ft. The engineering of the ancient Via Appia between Fondi and Formia, where it passes through the mountains near Itri, is remarkable.

The modern town is still enclosed by the ancient walls. The castle on the S.E. side has some 15th-century windows with beautiful tracery. Close by is the Gothic church of S. Pietro (formerly S. Maria), which was the cathedral until the see was suppressed in 1818 and united with that of Gaeta; it contains a fine pulpit with "cosmatesque" work and the fine tomb of Cristoforo Caetani (1439), two interesting 15th-century triptychs and an episcopal throne, which served for the coronation of the antipope Clement VII. in 1378. In the Dominican monastery the cell which St Thomas Aquinas sometimes occupied is shown.

The ancient city of Fundi in 338 B.C. (or 332) received (with Formiae) the *civitas sine suffragio*, because it had always secured the Romans safe passage through its territory; the people as a whole did not join Privernum in its war against Rome three years later, though Vitruvius Vacca, the leader, was a native of Fundi. It acquired the full citizenship in 188 B.C., and was partly under the control of a *praefectus*. The inscription upon some waterpipes which have been discovered shows that later it became a *municipium*. It was governed by three aediles: Horace's jest against the officious praetor (*sic*) is due to the exigencies of metre (Th. Mommsen in *Hermes*, xiii. p. 113). The family of Livia, the consort of Augustus, belonged to Fundi. During the Lombard invasions in 592 Fundi was temporarily abandoned, but it seems to have come under the rule of the papacy by A.D. 754 at any rate. Pope John VIII. ceded it with its territory to Docibile, duke of Gaeta, but its history is somewhat intricate after this period. Sometimes it appears as an independent countship, though held by members of the Caetani family, who about 1297 returned to it. In 1504 it was given to Prospero Colonna. In 1534 Khair-ed-Din Barbarossa tried to carry off Giulia Gonzaga, countess of Fondi, and sacked the city. After this Fondi was much neglected; in 1721 it was sold to the Di Sangro family, in which it still remains. Its position as a frontier town between the papal states and the kingdom of Naples, just in the territory of the latter—the Via Appia can easily be blocked either N.W. at the actual frontier called

Portella¹ or S.E. of it—affected it a good deal during the French Revolution and the events which led up to the unification of Italy.

The Lago di Fondi, which lies in the middle of the plain, and the partially drained marshes surrounding it, compelled the ancient Via Appia, followed by the modern road, to make a considerable détour. The lake was also known in classical times as *lacus Amyclanus*, from the town of Amyclae or Amunclae, which was founded, according to legend, by Spartan colonists, and probably destroyed by the Oscans in the 5th century B.C. (E. Pais in *Rendiconti dei Lincei*, 1906, 611 seq.); the bay was also known as *mare Amunclanum*.

The ancient Spelunca (mod. *Spurlonga*) on the coast also belonged to the territory of Fundi. Here was the imperial villa in which Sejanus saved the life of Tiberius, who was almost crushed by a fall of rock. Considerable remains of it, and of the caves from which it took its name, still exist 1 m. S.E. of the modern village. For modern discoveries see P. di Tucci in *Notizie degli scavi* (1880), 480; G. Patroni, *ibid.* (1898), 493. The wine of Fundi is spoken of by ancient writers, though the *ager Caecubus*, the coast plain round the Lago di Fundi, was even more renowned, and Horace frequently praises its wine; and though Pliny the Elder speaks as if its production had almost entirely ceased in his day (attributing this to neglect, but even more to the excavation works of Nero's projected canal from the lacus Avernus to Ostia), Martial mentions it often, and it is spoken of in the inscription of a wine-dealer of the time of Hadrian, together with Falernian and Setian wines (*Corpus inscript. Lat.* vi. Berlin, 1882, 9797). The plain of Fondi is the northernmost point in Italy where the cultivation of oranges and lemons is regularly carried on in modern times.

See G. Conte Colino, *Storia di Fondi* (Naples, 1902); B. Amante and R. Bianchi, *Memorie storiche e statutarie di Fondi in Campania* (Rome, 1903); T. Ashby, in *English Historical Review*, xix. (1904) 557 seq. (T. As.)

FONNI, a town of Sardinia, in the province of Sassari, 3280 ft. above sea-level, to the N.W. of Monte Gennargentu, 21 m. S. of Nuoro by road. Pop. (1901) 4323. It is the highest village in Sardinia, and situated among fine scenery with some chestnut woods. The church of the Franciscans, built in 1708, contains some curious paintings by local artists. The costumes are extremely picturesque, and are well seen on the day of St John the Baptist, the patron saint. The men's costume is similar to that worn in the district generally; the linen trousers are long and black gaiters are worn. The women wear a white chemise; over that a very small corselet, and over that a red jacket with blue and black velvet facings. The skirt is brown above and red below, with a blue band between the two colours; it is accordion-pleated. Two identical skirts are often worn, one above the other. The unmarried girls wear white kerchiefs, the married women black. A little to the N. of Fonni, by the high-road, stood the Roman station of Sorabile, mentioned in the *Antonine Itinerary* as situated 87 m. from Carales on the road to Olbia. Excavations made in 1879 and 1880 led to the discovery of the remains of this station, arranged round three sides of a courtyard some 100 ft. square, including traces of baths and other buildings, and a massive embanking wall above them, some 150 ft. in length, to protect them from landslips (F. Vivianet, in *Notizie degli scavi*, 1879, 350; 1881, 31), while a discharge certificate (*tabula honestae missionis*) of sailors who had served in the *classis Ravennas* was found in some ruins here or hereabouts (*id. ib.*, 1882, 440; T. Mommsen, *Corp. inscr. Lat.* x. 8325). Near Fonni, too, are several "menhirs" (called *pietre celtiche* in the district) and other prehistoric remains. (T. As.)

FONSAGRADA, a town of north-western Spain, in the province of Lugo; 25 m. E.N.E. of Lugo by road. Pop. (1900) 17,302. Fonsagrada is situated 3166 ft. above the sea, on the watershed between the rivers Rodil and Suarna. It is an important market for all kinds of agricultural produce, and manufactures linen and frieze; but its trade is mainly local, owing to the mountainous

¹ For the pass of Ad Lautulas see TERRACINA.

character of the neighbourhood, and the lack of a railway or navigable waterway, which prevent the development of any considerable export trade.

FONSECA, MANOEL DEODORO DA (1827-1892), first president of the united states of Brazil, was born at Alagoas on the 5th of August 1827, being the third son of Lieut.-Colonel Manoel Mendes da Fonseca (d. 1859). He was educated at the military school of Rio de Janeiro, and had attained the rank of captain in the Brazilian army when war broke out in 1864 against Montevideo, and afterwards against Solano Lopez, dictator of Paraguay. His courage gained him distinction, and before the close of the war in 1870 he reached the rank of colonel, and some years later that of general of division. After holding several military commands, he was appointed in 1886 governor of the province of Rio Grande do Sul. In this position he threw himself heartily into politics, espoused the republican opinions then becoming prevalent, and sheltered their exponents with his authority. After a fruitless remonstrance, the government at the close of the year removed him from his post, and recalled him to the capital as director of the service of army material. Finding that even in that post he still continued to encourage insubordination, the minister of war, Alfredo Chaves, dismissed him from office. On 14th of May 1887, in conjunction with the viscount de Pelotas, Fonseca issued a manifesto in defence of the military officers' political rights. From that time his influence was supreme in the army. In December 1888, when the Conservative Correa d'Oliveira became prime minister, Fonseca was appointed to command an army corps on the frontier of Matto Grosso. In June 1889 the ministry was overthrown, and on a dissolution an overwhelming Liberal majority was returned to the chamber of deputies. Fonseca returned to the capital in September. Divisions of opinion soon arose within the Liberal party on the question of provincial autonomy. The more extreme desired the inauguration of a complete federal system. Amongst the most vehement was Ruy Barbosa, the journalist and orator, and after some difficulty he persuaded Fonseca to head an armed movement against the government. The insurrection broke out on the 15th of November 1889. The government commander, Almeida Barreto, hastened to place himself under Fonseca's orders, and the soldiers and sailors made common cause with the insurgents. The affair was almost bloodless, the minister of marine, baron de Ladario, being the only person wounded. Fonseca had only intended to overturn the ministry, but he yielded to the insistency of the republican leaders and proclaimed a republic. A provisional government was constituted by the army and navy in the name of the nation, with Fonseca at its head. The council was abolished, and both the senate and the chamber of deputies were dissolved. The emperor was requested to leave the territory of Brazil within twenty-four hours, and on the 17th of November was embarked on a cruiser for Lisbon. On the 20th of December a decree of banishment was pronounced against the imperial family. So universal was the republican sentiment that there was no attempt at armed resistance. The provisional government exercised dictatorial powers for a year, and on the 25th of February 1891 Fonseca was elected president of the republic. He was, however, no politician, and possessed indeed little ability beyond the art of acquiring popularity. His tenure of office was short. In May he became involved in an altercation with congress, and in November pronounced its dissolution, a measure beyond his constitutional power. After a few days of arbitrary rule insurrection broke out in Rio Grande do Sul, and before the close of November Fonseca, finding himself forsaken, resigned his office. From that time he lived in retirement. He died at Rio de Janeiro on the 23rd of August 1892.

FONSECA, AMAPALA or CONCHAGUA, BAY OF, an inlet of the Pacific Ocean in the volcanic region between the Central American republics of Honduras, Salvador and Nicaragua. The bay is unsurpassed in extent and security by any other harbour on the Pacific. It is upwards of 50 m. in greatest length, by about 30 m. in average width, with an entrance from the sea about 18 m. wide, between the great volcanoes of Conchagua (3800 ft.)

and Coseguina (3000 ft.). The lofty islands of Conchaguita and Mianguiri, with a collection of rocks called "Los Farellones," divide the entrance into four distinct channels, each of sufficient depth for the largest vessels. A channel called "El Estero Real" extends from the extreme southern point of the bay into Nicaragua for about 50 m., reaching within 20 or 25 m. of Lake Managua. The principal islands in the bay are Sacate Grande, Tigre, Gueguensi and Esposescion belonging to Honduras, and Martin Perez, Punta Sacate, Conchaguita and Mianguiri belonging to Salvador. Of these Sacate Grande is the largest, being about 7 m. long by 4 broad. The island of Tigre from its position is the most important in the bay, being about 20 m. in circumference, and rising in a cone to the height of 2500 ft. On the southern and eastern shores of the island the lava forms black rocky barriers to the waves, varying in height from 10 to 80 ft.; but on the northward and eastward are a number of *playas* or smooth, sandy beaches. Facing one of the most considerable of these is the port of Amapala (*q.v.*). Fonseca Bay was discovered in 1522 by Gil Gonzalez de Avila, and named by him after his patron, Archbishop Juan Fonseca, the implacable enemy of Columbus.

FONT (Lat. *fons*, "fountain" or "spring," Ital. *fonte*, Fr. *les fonts*), the vessel used in churches to hold the water for Christian baptism. In the apostolic period baptism was administered at rivers or natural springs (cf. Acts viii. 36), and no doubt the primitive form of the rite was by *immersion* in the water. *Infusion*—pouring water on the head of the neophyte—was early introduced into the west and north of Europe on account of the inconvenience of immersion, as well as its occasional danger; this form has never been countenanced in the Oriental churches. *Aspersio*, or sprinkling, was also admitted as valid, but recorded early examples of its use are rare (see BAPTISM). These different modes of administering baptism have caused corresponding changes in the receptacles for the water. After the cessation of persecution, when ritual and ornament began to develop openly, special buildings were erected for administering the rite of baptism. This was obviously necessary, for a large *piscina* (basin or tank) in which candidates could be immersed would occupy too much space of the church floor itself. These baptisteries consisted of tanks entered by steps (an ascent of three, and descent of four, to the water was the normal but not the invariable number) and covered with a domed chamber (see BAPTISTERY).

By the 9th century, however, the use of separate baptisteries had generally given place to that of fonts. The material of which these were made was stone, often decorative marble; as early as 524, however, the council of Lerida enacted that if a stone font were not procurable the presbyter was to provide a suitable vessel, to be used for the sacrament exclusively, which might be of any material. In the Eastern Church the font never became an important decorative article of church furniture: "The font, *κολυμβήθρα* (says Neale, *Eastern Church*, i. 214), in the Eastern Church is a far less conspicuous object than it is in the West. Baptism by immersion has been retained; but the font seldom or never possesses any beauty. The material is usually either metal or wood. In Russia the *columbethra* is movable and only brought out when wanted."

One of the most elaborate of early fonts is that described by Anastasius in the Lateran church at Rome, and said to have been presented thereto by Constantine the Great. It was of porphyry, overlaid with silver inside and out. In the middle were two porphyry pillars carrying a golden dish, on which burnt the Paschal lamp (having an asbestos wick and fed with balsam). On the rim of the bowl was a golden lamb, with silver statues of Christ and St. John the Baptist. Seven silver stags poured out water. This elaborate vessel was of course exceptional; the majority of early fonts were certainly much simpler. A fine early Byzantine stone example exists, or till recently existed, at Beer-Sheba.

Few if any fonts survive older than the 11th century. These are all of stone, except a few of lead; much less common are fonts of cast bronze (a fine example, dated 1112, exists at the

Church of St Barthélemy, Liège). The most ancient are plain cylindrical bowls, with a circular—sometimes cruciform or quatrefoil—outline to the basin, either without support or with a single central pillar; occasionally there is more than one pillar. The basins are usually lined with lead to prevent absorption by the stone. The church of Efenectyd, Denbigh, possesses an ancient font made of a single block of oak. Though the circular form is the commonest, early Romanesque fonts are not infrequently square; and sometimes an inverted truncated cone is found. Octagonal fonts are also known, though uncommon; hexagons are even less common, and pentagons very rare. There is a pentagonal font of this period at Cabourg, dept. Calvados, N. France.

Fonts early began to be decorated with sculpture and relief. Arcading and interlacing work are common; so are symbol and pictorial representation. A very remarkable leaden font is preserved at Strassburg, bearing reliefs representing scenes in the life of Christ. At Pont-à-Mousson on the Moselle are bas-reliefs of St John the Baptist preaching, and baptizing Christ. Caryatides sometimes take the place of the pillars, and sculptured animals and grotesques of strange design not infrequently form the base. More remarkable is the occasional persistence of pagan symbolism; an interesting example is the very ancient font from Ottrava, Sweden, which, among a series of Christian symbols and figures on its panels, bears a representation of Thor (see G. Stephens' brochure, *Thunor the Thunderer*).

In the 13th century octagonal fonts became commoner. A very remarkable example exists at the cathedral of Hildesheim in Hanover, resting on four kneeling figures, each bearing a vase from which water is running (typical of the rivers of Paradise). Above is an inscription explaining the connexion of these rivers with the virtues of temperance, courage, justice and prudence. On the sides of the cup are representations of the passage of the Jordan, of the Red Sea, the Baptism of Christ, and the Virgin and Child. The font has a conical lid, also ornamented with bas-reliefs. A cast of this font is to be seen in the Victoria and Albert Museum at South Kensington. A leaden font, with figures of Our Lord, the Virgin Mary, St Martin, and the twelve Apostles, exists at Mainz; it is dated 1328 by a set of four leonine hexameters inscribed upon it. In the 14th and succeeding centuries octagonal fonts became the rule. They are delicately ornamented with mouldings and similar decorations, in the contemporary style of Gothic architectural art. Though the basin is usually circular in 15th-century fonts, examples are not infrequently found in which the outline of the basin follows the octagonal shape of the outer surface of the vessel. Examples of this type are to be found at Strassburg, Freiburg and Basel.

In England no fonts can certainly be said to date before the Norman conquest, although it is possible that a few very rude examples, such as those of Washaway, Cornwall, and Denton, Sussex, are actually of Saxon times; of course we cannot count as "Saxon fonts" those adapted from pre-Norman sculptured stones originally designed for other purposes, such as that at Dolton, Devonshire. On the other hand, Norman fonts are very common, and are often the sole surviving relics of the Norman parish church. They are circular or square, sometimes plain, but generally covered with carving of arcades, figures, foliage, &c. Among good examples that might be instanced of this period are Alphington, Devon (inverted cone, without foot); Stoke Cannon, Devon (supported on caryatides); Ilam, Staffs (cup-shaped); Fincham, Burnham Deepdale, Sculthorpe, Toftrees, and Sherborne in Norfolk (all, especially the last, remarkable for elaborate carving); Youlgrave, Derby (with a projecting stoup in the side for the chris— a unique detail); besides others in Lincoln cathedral; Ilfley, Oxon; Newenden, Kent; Coleshill, Warwick; East Meon, Hants; Castle Frome, Herefordshire. Some of the best examples of "Norman" fonts in England (such as the notable specimen in Winchester cathedral) were probably imported from Belgium. In the Transitional period we may mention a remarkable octagonal font at Belton, Lincolnshire; in this period fall most of the leaden fonts that remain in England, of which thirty are known (7 in

Gloucestershire, 4 in Berkshire and Kent, 3 in Norfolk, Oxford and Sussex, 1 in Derby, Dorset, Lincoln, Somerset, Surrey and Wiltshire); perhaps the finest examples are at Ashover, Derbyshire, and Walton, Surrey. Early English fonts are comparatively rare. They bear the moulding, foliage and tooth ornament in the usual style of the period. A good example of an Early English font is at All Saints, Leicester; others may be seen at St Giles', Oxford, and at Lackford, Suffolk. Fonts of the Decorated period are commoner, but not so frequent as those of the preceding Norman or subsequent Perpendicular periods. Fonts of the Perpendicular period are very common, and are generally raised upon steps and a lofty stem, which, together with the body of the font, are frequently richly ornamented with panelling. It was also the custom during this period to ornament the font with shields and coats of arms and other heraldic insignia, as at Herne, Kent. The fonts of this period, however, are as a rule devoid of interest, and, like most Perpendicular work, are stiff and monotonous. There is, however, a remarkable font, with sculptured figures, belonging to the late 14th century, at West Drayton in Middlesex.

In Holyrood chapel there was a brazen font in which the royal children of Scotland were baptized. It was carried off in 1544 by Sir R. Lea, and given by him to the church at St Albans, but was afterwards destroyed by the Puritans. A silver font existed at Canterbury, which was sometimes brought to Westminster on the occasion of a royal baptism. At Chobham, Surrey, there is a leaden font covered with oaken panels of the 16th century. The only existing structure at all recalling the ancient baptisteries in English churches is found at Luton in Bedfordshire. The font at Luton belongs to the Decorated style, and is enclosed in an octagonal structure of freestone, consisting of eight pillars about 25 ft. in height, supporting a canopy. The space around the font is large enough to hold twelve adults comfortably. At the top of the canopy is a vessel for containing the consecrated water, which when required was let down into the font by means of a pipe.

In 1236 it was ordered by Edmund, archbishop of Canterbury, that baptismal fonts should be kept under lock and key, as a precaution against sorcery:—"Fontes baptismales sub sera clausi teneantur propter sortilegia." The lids appear at first to have been quite simple and flat. They gradually, however, partook of the ornamentation of the font itself, and are often of pyramidal and conical forms, highly decorated with finials, crockets, mouldings and grotesques. Sometimes these covers are very heavy and are suspended by chains to enable them to be raised at will. Very rich font covers may be seen at Ewelme, Oxon; St Gregory, Sudbury; North Walsingham, Norfolk; Worlingworth, Suffolk. The ordinary position of the font in the church was and is near the entrance, usually to the left of the south door.

See Arceise de Caumont, *Cours d'antiquités monumentales* (Paris, 1830-1843); Francis Simpson, *A Series of Ancient Baptismal Fonts* (London, 1828); Paley, *Ancient Fonts*; E. E. Viollet-le-Duc, *Dict. raisonné de l'architecture* (1858-1868), vol. v.; J. H. Parker's *Glossary of Architecture*; Francis Bond, *Fonts and Font-Covers* (London, 1908). A large number of fine illustrations of fonts, principally of the earlier periods, will be found in the volumes of the *Reliquary and Illustrated Archaeologist*. (R. A. S. M.)

FONTAINE, PIERRE FRANÇOIS LÉONARD (1762-1853), French architect, was born at Pontoise on the 20th of September 1762. He came of a family several of whose members had distinguished themselves as architects. Leaving the college of Pontoise at the age of sixteen he was sent to L'Isle-Adam to assist in hydraulic works undertaken by the architect André. To facilitate his improvement André allowed him to have access to his plans and to copy his designs. In October 1779 he was sent to Paris to study in the school of Peyre the younger, and there began his acquaintance with Percier, which ripened into a life-long friendship. After six years of study he competed for a prize at the Academy, and, winning the second for the plan of an underground chapel, he received a pension and was sent to Rome (1785). Percier accompanied him. The Revolution breaking out soon after his return to France, he took refuge in

England; but after the establishment of the consulate he was employed by Bonaparte, to whom he had been introduced by the painter, David, to restore the palace of Malmaison. Henceforth he was fully engaged in the principal architectural works executed in Paris as architect successively to Napoleon I., Louis XVIII. and Louis Philippe. In conjunction with Percier (till his death) he was employed on the arch of the Carrousel, the restoration of the Palais-Royal, the grand staircase of the Louvre, and the works projected for the union of the Louvre and the Tuileries. In 1812 he was admitted a member of the Academy of Fine Arts, and in 1813 was named first architect to the emperor. With Percier he published the following works—*Palais, maisons, et autres édifices de Rome moderne* (1802); *Descriptions de cérémonies et de fêtes* (1807 and 1810); *Recueil de décorations intérieures* (1812); *Choix des plus célèbres maisons de plaisance de Rome et des environs* (1809-1813); *Résidences des souverains, Parallèle* (1833). *L'histoire du Palais-Royal* was published by Fontaine alone, who lost Percier, his friend and associate, in 1838, and himself died in Paris on the 10th of October 1853.

FONTAINEBLEAU, a town of northern France, capital of an arrondissement in the department of Seine-et-Marne, 37 m. S.E. of Paris on the railway to Lyons. Pop. (1906) 11,108. Fontainebleau, a town of clean, wide and well-built streets, stands in the midst of the forest of Fontainebleau, nearly 2 m. from the left bank of the Seine. Of its old houses, the Tambour mansion, and a portion of that which belonged to the cardinal of Ferrara, both of the 16th century, are still preserved; apart from the palace, the public buildings are without interest. A statue of General Damesme (d. 1848) stands in the principal square, and a monument to President Carnot was erected in 1895. Fontainebleau is the seat of a subprefect and has a tribunal of first instance and a communal college. The school of practical artillery and engineering was transferred to Fontainebleau from Metz by a decree of 1871, and now occupies the part of the palace surrounding the cour des offices.

Fontainebleau has quarries of sand and sandstone, saw-mills, and manufactories of porcelain and gloves. Fine grapes are grown in the vicinity. The town is a fashionable summer resort, and during the season the president of the Republic frequently resides in the palace. This famous building, one of the largest, and in the interior one of the most sumptuous, of the royal residences of France, lies immediately to the south-east of the town. It consists of a series of courts surrounded by buildings, extending from W. to E.N.E.; they comprise the Cour du Cheval Blanc or des Adieux (thus named in memory of the parting scene between Napoleon and the Old Guard in 1814), the Cour de la Fontaine, the Cour Ovale, built on the site of a more ancient château, and the Cour d' Henri IV.: the smaller Cour des Princes adjoins the northern wing of the Cour Ovale. The exact origin of the palace and of its name (Lat. *Fons Bleaudi*) are equally unknown, but the older château was used in the latter part of the 12th century by Louis VII., who caused Thomas Becket to consecrate the Chapelle St Saturnin, and it continued a favourite residence of Philip Augustus and Louis IX. The creator of the present edifice was Francis I., under whom the architect Gilles le Breton erected most of the buildings of the Cour Ovale, including the Porte Dorée, its southern entrance, and the Salle des Fêtes, which, in the reign of Henry II., was decorated by the Italians, Francesco Primaticcio and Nicolo dell' Abbate, and is perhaps the finest Renaissance chamber in France. The Galerie de François I. and the lower storey of the left wing of the Cour de la Fontaine are the work of the same architect, who also rebuilt the two-storeyed Chapelle St Saturnin. In the same reign the Cour du Cheval Blanc, including the Chapelle de la Ste Trinité and the Galerie d'Ulysse, destroyed and rebuilt under Louis XV., was constructed by Pierre Chambiges. After Francis I., Fontainebleau owes most to Henry IV., to whom are due the Cour d' Henri IV., the Cour des Princes, with the adjoining Galerie de Diane, and Galerie des Cerfs, used as a library. Louis XIII. built the graceful horseshoe staircase in the Cour du Cheval Blanc; Napoleon I. spent 12,000,000 francs

on works of restoration, and Louis XVIII., Louis Philippe and Napoleon III. devoted considerable sums to the same end. The palace is surrounded by gardens and ornamental waters—to the north the Jardin de l'Orangerie, to the south the Jardin Anglais and the Parterre, between which extends the lake known as the Bassin des Carpes, containing carp in large numbers. A space of over 200 acres to the east of the palace is covered by the park, which is traversed by a canal dating from the reign of Henry IV. On the north the park is bordered by a vineyard producing fine white grapes.

Forest of Fontainebleau.—The forest of Fontainebleau is one of the most beautiful wooded tracts in France, and for generations it has been the chosen haunt of French landscape painters. Among the most celebrated spots are the Vallée de la Solle, the Gorge aux Loups, the Gorges de Franchard and d'Apremont, and the Fort l'Empereur. The whole area extends to 42,200 acres, with a circumference of 56 m. Nearly a quarter of this area is of a rocky nature, and the quarries of sandstone supplied a large part of the paving of Paris. The oak, pine, beech, hornbeam and birch are the chief varieties of trees.

It is impossible to do more than mention a few of the historical events which have taken place at Fontainebleau. Philip the Fair, Henry III. and Louis XIII. were all born in the palace, and the first of these kings died there. James V. of Scotland was there received by his intended bride; and Charles V. of Germany was entertained there in 1539. Christina of Sweden lived there for years, and the gallery is still to be seen where in 1657 she caused her secretary Monaldeschi to be put to death. In 1685 Fontainebleau saw the signing of the revocation of the edict of Nantes, and in the following year the death of the great Condé. In the 18th century it had two illustrious guests in Peter the Great of Russia and Christian VII. of Denmark; and in the early part of the 19th century it was twice the residence of Pius VII.,—in 1804 when he came to consecrate the emperor Napoleon, and in 1812–1814, when he was his prisoner.

See Pfnor, *Monographie de Fontainebleau*, with text by Champollion Figéac (Paris, 1866); *Guide artistique et historique au palais de Fontainebleau* (Paris, 1889); E. Bourges, *Recherches sur Fontainebleau* (Fontainebleau, 1896).

FONTAN, LOUIS MARIE (1801–1839), French man of letters, was born at Lorient on the 4th of November 1801. He began his career as a clerk in a government office, but was dismissed for taking part in a political banquet. At the age of nineteen he went to Paris and began to contribute to the *Tablettes* and the *Album*. He was brought to trial for political articles written for the latter paper, but defended himself so energetically that he secured the indefinite postponement of his case. The offending paper was suppressed for a time, and Fontan produced a collection of political poems, *Odes et épitres*, and a number of plays, of which *Perkins Warbec* (1828), written in collaboration with MM. Halévy and Drouineau, was the most successful. In 1828 the *Album* was revived, and in it Fontan published a virulent but witty attack on Charles X., entitled *Le Mouton enragé* (20th June 1829). To escape the inevitable prosecution Fontan fled over the frontier, but, finding no safe asylum, he returned to Paris to give himself up to the authorities, and was sentenced to five years' imprisonment and a heavy fine. He was liberated by the revolution of 1830, and his *Jeanne la folle*, performed in the same year, gained a success due perhaps more to sympathy with the author's political principles than to the merits of the piece itself, a somewhat crude and violent picture of Breton history. A drama representing the trial of Marshal Ney, which he wrote in collaboration with Charles Dupenty, *Le Procès d'un maréchal de France* (printed 1831), was suppressed on the night of its production. Fontan died in Paris on the 10th of October 1839.

A sympathetic portrait of Fontan as a prisoner, and an analysis of his principal works, are to be found in Jules Janin's *Histoire de la littérature dramatique*, vol. i.

FONTANA, DOMENICO (1543–1607), Italian architect and mechanician, was born at Mili, a village on the Lake of Como, in 1543. After a good training in mathematics, he went in 1563 to join his elder brother, then studying architecture at Rome.

He made rapid progress, and was taken into the service of Cardinal Montalto, for whom he erected a chapel in the church of Santa Maria Maggiore and the villa Negroni. When the cardinal's pension was stopped by the pope, Gregory XIII., Fontana volunteered to complete the works in hand at his own expense. The cardinal being soon after elected pope, under the name of Sixtus V., he immediately appointed Fontana his chief architect. Amongst the works executed by him were the Lateran palace, the palace of Monte Cavallo (the Quirinal), the Vatican library, &c. But the undertaking which brought Fontana the highest repute was the removal of the great Egyptian obelisk, which had been brought to Rome in the reign of Caligula, from the place where it lay in the circus of the Vatican. Its erection in front of St Peter's he accomplished in 1586. After the death of Sixtus V., charges were brought against Fontana of misappropriation of public moneys, and Clement VIII. dismissed him from his post (1592). This appears to have been just in time to save the Colosseum from being converted by Fontana into a huge cloth factory, according to a project of Sixtus V. Fontana was then called to Naples, and accepted the appointment of architect to the viceroy, the count of Miranda. At Naples he built the royal palace, constructed several canals and projected a new harbour and bridge, which he did not live to execute. The only literary work left by him is his account of the removal of the obelisk (Rome, 1590). He died at Naples in 1607, and was honoured with a public funeral in the church of Santa Anna. His plan for a new harbour at Naples was carried out only after his death. His son Giulio Cesare succeeded him as royal architect in Naples, the university of that town being his best-known building.

FONTANA, LAVINIA (1552–1614), Italian portrait-painter, was the daughter of Prospero Fontana (*q.v.*). She was greatly employed by the ladies of Bologna, and, going thence to Rome, painted the likenesses of many illustrious personages, being under the particular patronage of the family (Buoncampagni) of Pope Gregory XIII., who died in 1585. The Roman ladies, from the days of this pontiff to those of Paul V., elected in 1605, showed no less favour to Lavinia than their Bolognese sisters had done; and Paul V. was himself among her sitters. Some of her portraits, often lavishly paid for, have been attributed to Guido. In works of a different kind also she united care and delicacy with boldness. Among the chief of these are a Venus in the Berlin museum; the "Virgin lifting a veil from the sleeping infant Christ," in the Escorial; and the "Queen of Sheba visiting Solomon." Her own portrait in youth—she was accounted very beautiful—was perhaps her masterpiece; it belongs to the counts Zappi of Imola, the family into which Lavinia married. Her husband, whose name is given as Paolo Zappi or Paolo Foppa, painted the draperies in many of Lavinia's pictures. She is deemed on the whole a better painter than her father; from him naturally came her first instruction, but she gradually adopted the Caraccesque style, with strong quasi-Venetian colouring. She was elected into the Academy of Rome, and died in that city in 1614.

FONTANA, PROSPERO (1512–1597), Italian painter, was born in Bologna, and became a pupil of Innocenzo da Imola. He afterwards worked for Vasari and Perino del Vaga. It was probably from Vasari that Fontana acquired a practice of off-hand, self-displaying work. He undertook a multitude of commissions, and was so rapid, that he painted, it is said, in a few weeks an entire hall in the Vitelli palace at Città di Castello. Along with daring, he had fertility of combination, and in works of parade he attained a certain measure of success, although his drawing was incorrect and his mannerism palpable. He belongs to the degenerate period of the Bolognese school, under the influence chiefly of the imitators of Raphael—Sabbatini, Sammachini and Passerotti being three of his principal colleagues. His soundest successes were in portraiture, in which branch of art he stood so high that towards 1550 Michelangelo introduced him to Pope Julius III. as a portrait-painter; and he was pensioned by this pope, and remained at the pontifical court with the three successors of Julius. Here he lived on a grand scale, and figured as a sort of arbiter and oracle among his

professional brethren. Returning to Bologna, after doing some work in Fontainebleau and in Genoa, he opened a school of art, in which he became the preceptor of Lodovico and Agostino Caracci; but these pupils, standing forth as reformers and innovators, finally extinguished the academy and the vogue of Fontana. His subjects were in the way of sacred and profane history and of fable. He has left a large quantity of work in Bologna,—the picture of the “Adoration of the Magi,” in the church of S. Maria delle Grazie, being considered his masterpiece—not unlike the style of Paul Veronese. He died in Rome in 1597.

FONTANE, THEODOR (1819–1898), German poet and novelist, was born at Neu-Ruppin on the 30th of December 1819. At the age of sixteen he was apprenticed to a chemist, and after qualifying as an apothecary, he found employment in Leipzig and Dresden. In 1844 he travelled in England, and settling in Berlin devoted himself from 1849 to literature. He made repeated journeys to England, interesting himself in old English ballads, and as the firstfruits of his tours published *Ein Sommer in London* (1854); *Aus England, Studien und Briefe* (1860) and *Jenseit des Tweed, Bilder und Briefe aus Schottland* (1860). Fontane was particularly attached to the Mark of Brandenburg, in which his home lay; he was proud of its past achievements, and delighted in the growth of the capital city, Berlin. The fascination which the country of his birth had for him may be seen in his delightfully picturesque *Wanderungen durch die Mark Brandenburg* (1862–1882, 4 vols.). He also described the wars of Prussia in *Der schleswig-holsteinische Krieg im Jahre 1864* (1866) and *Der deutsche Krieg von 1866* (1869). He proceeded to the theatre of war in 1870, and, being taken prisoner at Vaucouleurs, remained three months in captivity. His experiences he narrates in *Kriegsgefangen. Erlebtes 1870* (1871), and he published the result of his observations of the campaign in *Der Krieg gegen Frankreich 1870–71* (1874–1876). Like most of his contemporaries, he at first sought inspiration for his poetry in the heroes of other countries. His *Gedichte* (1851) and ballads *Männer und Helden* (1860) tell of England's glories in bygone days. Then the achievements of his own countrymen entered into rivalry, and these, as an ardent patriot, he immortalized in poem and narrative. It is, however, as a novelist that Fontane is best known. His fine historical romance *Vor dem Sturm* (1878) was followed by a series of novels of modern life: *L'Adultera* (1882); *Schach von Wulkenow* (1883); *Irrungen, Wirrungen* (1888); *Stine* (1890); *Unwiederbringlich* (1891); *Effi Briest* (1895); *Der Stechlin* (1899), in which with fine literary tact Fontane adapted the realistic methods and social criticism of contemporary French fiction to the conditions of Prussian life. He died on the 20th of September 1898 at Berlin.

Fontane's *Gesammelte Romane und Erzählungen* were published in 12 vols. (1890–1891; 2nd ed., 1905). For his life see the autobiographical works *Meine Kinderjahre* (1894) and *Von zwanzig bis dreissig* (1898), also *Briefe an seine Familie* (1905); also F. Servaes, *Theodor Fontane* (1900).

FONTANES, LOUIS, MARQUIS DE (1757–1821), French poet and politician, was born at Niort (Deux Sèvres) on the 6th of March 1757. He belonged to a noble Protestant family of Languedoc which had been reduced to poverty by the revocation of the edict of Nantes. His father and grandfather remained Protestant, but he was himself brought up as a Catholic. His parents died in 1774–1775, and in 1777 Fontanes went to Paris, where he found a friend in the dramatist J. F. Ducis. His first published poems, some of which were inspired by English models, appeared in the *Almanach des Muses*; “Le Cri de mon cœur,” describing his own sad childhood, in 1778; and “La Forêt de Navarre” in 1780. His translation from Alexander Pope, *L'Essai sur l'homme*, was published with an elaborate preface in 1783, and *La Chartreuse* and *Le Jour des morts* in the same year, *Le Verger* in 1788 and his *Épître sur l'édit en faveur des non-catholiques*, and the *Essai sur l'astronomie* in 1789. Fontanes was a moderate reformer, and in 1790 he became joint-editor of the *Moderateur*. He married at Lyons in 1792, and his wife's first child was born during their flight from the

siege of that town. Fontanes was in hiding in Paris when the four citizens of Lyons were sent to the Convention to protest against the cruelties of Collot d'Herbois. The petition was drawn up by Fontanes, and the authorship being discovered, he fled from Paris and found shelter at Sevran, near Livry, and afterwards at Andelys. On the fall of Robespierre he was made professor of literature in the École Centrale des Quatre-Nations, and he was one of the original members of the Institute. In the *Mémorial*, a journal edited by La Harpe, he discreetly advocated reaction to the monarchical principle. He was exiled by the Directory and made his way to London, where he was closely associated with Chateaubriand. He soon returned to France, and his admiration for Napoleon, who commissioned him to write an *éloge* on Washington, secured his return to the Institute and his political promotion. In 1802 he was elected to the legislative chamber, of which he was president from 1804 to 1810. Other honours and titles followed. He has been accused of servility to Napoleon, but he had the courage to remonstrate with him on the judicial murder of the duc d'Enghien, and as grand master of the university of Paris (1808–1815) he consistently supported religious and monarchical principles. He acquiesced in the Bourbon restoration, and was made a marquis in 1817. He died on the 17th of March 1821 in Paris, leaving eight cantos of an unfinished epic poem entitled *La Grèce sauvée*.

The verse of Fontanes is polished and musical in the style of the 18th century. It was not collected until 1839, when Sainte-Beuve edited the *Œuvres* (2 vols.) of Fontanes, with a sympathetic critical study of the author and his career. But by that time the Romantic movement was in the ascendant and Fontanes met with small appreciation.

FONTENAY-LE-COMTE, a town of western France, capital of an arrondissement in the department of Vendée 30 m. N.E. of La Rochelle on the State railway between that town and Saumur. Pop. (1906) town, 7639; commune, 10,326. Fontenay, an ancient and straggling town, is situated a few miles south of the forest of Vouvant and on both banks of the Vendée, at the point where it becomes navigable. The church of Notre-Dame (15th to 18th centuries), which has a fine spire and a richly sculptured western entrance, and the church of St Jean (16th and 17th centuries) are the chief religious buildings. The town has several houses of the 16th and 17th centuries. The most remarkable of these is the Hôtel de Terre Neuve (1595–1600), which contains much rich decoration together with collections of furniture and tapestry. Fontenay was the birthplace of many prominent men during the 15th and 16th centuries, and the Fontaine des Quatre-Tias, a fountain in the Renaissance style, given to the town by King Francis I., commemorates the fact. The chief square is named after François Viète, the great mathematician, who was born at Fontenay in 1540. The public institutions of the town include a tribunal of first instance and a communal college. Among its industries are the manufacture of felt hats, oil and soap and timber-sawing, flour-milling and tanning. There is trade in horses, mules, timber, grain, fruit, &c.

Fontenay was in existence as early as the time of the Gauls. The affix of “comte” is said to have been applied to it when it was taken by King Louis IX. from the family of Lusignan and given to his brother Alphonse, count of Poitou, under whom it became capital of Bas-Poitou. Ceded to the English by the treaty of Brétigny in 1360 it was retaken in 1372 by Duguesclin. It suffered repeated capture during the Religious Wars of the 16th century, was dismantled in 1621 and was occupied both by the republicans and the Vendéans in the war of 1793. From 1790 to 1806 it was capital of the department of Vendée.

FONTENELLE, BERNARD LE BOVIER DE (1657–1757), French author, was born at Rouen, on the 11th of February 1657. He died in Paris, on the 9th of January 1757, having thus very nearly attained the age of 100 years. His father was an advocate settled in Rouen, his mother a sister of the two Corneille. He was educated at the college of the Jesuits in his native city, and distinguished himself by the extraordinary precocity and versatility of his talents. His teachers, who readily appreciated these, were anxious for him to join their

order, but his father had designed him for the bar, and an advocate accordingly he became; but, having lost the first cause which was entrusted to him, he soon abandoned law and gave himself wholly to literary pursuits. His attention was first directed to poetry; and more than once he competed for prizes of the French Academy, but never with success. He visited Paris from time to time and established intimate relations with the abbé de Saint Pierre, the abbé Vertot and the mathematician Pierre Varignon. He witnessed, in 1680, the total failure of his tragedy *Aspar*. Fontenelle afterwards acknowledged the justice of the public verdict by burning his unfortunate drama. His opera of *Thétis et Pélée*, 1689, though highly praised by Voltaire, cannot be said to rise much above the others; and it may be regarded as significant that of all his dramatic works not one has kept the stage. His *Poésies pastorales* (1688) have no greater claim to permanent repute, being characterized by stiffness and affectation; and the utmost that can be said for his poetry in general is that it displays much of the *limae labor*, great purity of diction and occasional felicity of expression.

His *Lettres galantes du chevalier d'Her* . . ., published anonymously in 1685, was an amusing collection of stories that immediately made its mark. In 1686 his famous allegory of Rome and Geneva, slightly disguised as the rival princesses Mreo and Eeneu, in the *Relation de l'île de Bornéo*, gave proof of his daring in religious matters. But it was by his *Nouveaux Dialogues des morts* (1683) that Fontenelle established a genuine claim to high literary rank; and that claim was enhanced three years later by the appearance of the *Entretiens sur la pluralité des mondes* (1686), a work which was among the very first to illustrate the possibility of being scientific without being either uninteresting or unintelligible to the ordinary reader. His object was to popularize among his countrymen the astronomical theories of Descartes; and it may well be doubted if that philosopher ever ranked a more ingenious or successful expositor among his disciples.

Hitherto Fontenelle had made his home in Rouen, but in 1687 he removed to Paris; and in the same year he published his *Histoire des oracles*, a book which made a considerable stir in theological and philosophical circles. It consisted of two essays, the first of which was designed to prove that oracles were not given by the supernatural agency of demons, and the second that they did not cease with the birth of Christ. It excited the suspicion of the Church, and a Jesuit, by name Baltus, published a ponderous refutation of it; but the peace-loving disposition of its author impelled him to leave his opponent unanswered. To the following year (1688) belongs his *Digression sur les anciens et les modernes*, in which he took the modern side in the controversy then raging; his *Doutes sur le système physique des causes occasionnelles* (against Malebranche) appeared shortly afterwards.

In 1691 he was received into the French Academy in spite of the determined efforts of the partisans of the ancients in this quarrel, especially of Racine and Boileau, who on four previous occasions had secured his rejection. He consequently was admitted a member both of the Academy of Inscriptions and of the Academy of Sciences; and in 1697 he became perpetual secretary to the latter body. This office he actually held for the long period of forty-two years; and it was in this official capacity that he wrote the *Histoire du renouvellement de l'Académie des Sciences* (Paris, 3 vols., 1708, 1717, 1722) containing extracts and analyses of the proceedings, and also the *éloges* of the members, written with great simplicity and delicacy. Perhaps the best known of his *éloges*, of which there are sixty-nine in all, is that of his uncle Pierre Corneille. This was first printed in the *Nouvelles de la république des lettres* (January 1685) and, as *Vie de Corneille*, was included in all the editions of Fontenelle's *Œuvres*. The other important works of Fontenelle are his *Éléments de la géométrie de l'infini* (1727) and his *Apologie des tourbillons* (1752). Fontenelle forms a link between two very widely different periods of French literature, that of Corneille, Racine and Boileau on the one hand, and that of Voltaire,

D'Alembert and Diderot on the other. It is not in virtue of his great age alone that this can be said of him; he actually had much in common with the *beaux esprits* of the 17th century, as well as with the *philosophes* of the 18th. But it is to the latter rather than to the former period that he properly belongs.

He has no claim to be regarded as a genius; but, as Sainte-Beuve has said, he well deserves a place "*dans la classe des esprits infiniment distingués*"—distinguished, however, it ought to be added by intelligence rather than by intellect, and less by the power of saying much than by the power of saying a little well. In personal character he has sometimes been described as having been revoltingly heartless; and it is abundantly plain that he was singularly incapable of feeling strongly the more generous emotions—a misfortune, or a fault, which revealed itself in many ways. "*Il faut avoir de l'âme pour avoir du goût.*" But the cynical expressions of such a man are not to be taken too literally; and the mere fact that he lived and died in the esteem of many friends suffices to show that the theoretical selfishness which he sometimes professed cannot have been consistently and at all times carried into practice.

There have been several collective editions of Fontenelle's works, the first being printed in 3 vols. at the Hague in 1728-1729. The best is that of Paris, in 8 vols. 8vo, 1790. Some of his separate works have been very frequently reprinted and also translated. The *Pluralité des mondes* was translated into modern Greek in 1794. Sainte-Beuve has an interesting essay on Fontenelle, with several useful references, in the *Causeries du lundi*, vol. iii. See also Villemain, *Tableau de la littérature française au XVIII^e siècle*; the abbé Trublet, *Mémoires pour servir à l'histoire de la vie et des ouvrages de M. de Fontenelle* (1759); A. Laborde-Milàà, *Fontenelle* (1905), in the "Grands écrivains français" series; and L. Maigrin, *Fontenelle, l'homme, l'œuvre, l'influence* (Paris, 1906).

FONTENOY, a village of Belgium, in the province of Hennegau, about 4 m. S.E. of Tournai, famous as the scene of the battle of Fontenoy, in which on the 11th of May 1745 the French army under Marshal Saxe defeated the Anglo-Allied army under the duke of Cumberland. The object of the French (see also AUSTRIAN SUCCESSION, WAR OF THE) was to cover the siege of the then important fortress of Tournai, that of the Allies, who slowly advanced from the east, to relieve it. Informed of the impending attack, Louis XV., with the dauphin, came with all speed to witness the operations, and by his presence to give Saxe, who was in bad health and beset with private enemies, the support necessary to enable him to command effectively. Under Cumberland served the Austrian field-marshal Königsegg, and, at the head of the Dutch contingent, the prince of Waldeck.

The right of the French position (see map) rested on the river at Antoing, which village was fortified and garrisoned, between Antoing and Fontenoy three square redoubts were constructed, and Fontenoy itself was put in a complete state of defence. On the left rear of this line, and separated from Fontenoy by some furlongs of open ground, another redoubt was made at the corner of the wood of Barry and a fifth towards Gavrain. The infantry was arrayed in deployed lines behind the Antoing-Fontenoy redoubts and the low ridge between Fontenoy and the wood; behind them was the cavalry. The approaches to Gavrain were guarded by a mounted volunteer corps called *Grassins*. At Calonne the marshal had constructed three military bridges against the contingency of a forced retreat. The force of the French was about 60,000 of all arms, not including 22,000 left in the lines before Tournai. Marshal Saxe himself, who was suffering from dropsy to such an extent that he was unable to mount his horse, slept in a wicker chariot in the midst of the troops. At early dawn of the 11th of May, the Anglo-Hanoverian army with the Austrian contingent formed up in front of Vézon, facing towards Fontenoy and the wood, while the Dutch on their left extended the general line to Péronne. The total force was 46,000, against about 52,000 whom Saxe could actually put into the line of battle.

The plan of attack arranged by Cumberland, Königsegg and Waldeck on the 10th grew out of circumstances. A preliminary skirmish had cleared the broken ground immediately about Vézon and revealed a part of the defender's dispositions. It was resolved that the Dutch should attack the front Antoing-

Fontenoy, while Cumberland should deliver a flank attack against Fontenoy and all in rear of it, by way of the open ground between Fontenoy and the wood. A great cavalry attack round the wood was projected but had to be given up, as in the late evening of the 10th the Allies' light cavalry drew fire from its southern edge. Cumberland then ordered his cavalry commander to form a screen facing Fontenoy, so as to cover the formation of the infantry. On the morning of the 11th another and most important modification had to be made. The advance was beginning when the redoubt at the corner of the wood became visible. Cumberland hastily told off Brigadier James Ingoldsby (major and brevet-colonel 1st Guards), with four regiments and an artillery detachment, to storm this redoubt which, crossing its fire with that of Fontenoy, seemed absolutely to inhibit the development of the flank attack. At 6 A.M. the brigade moved off, but it was irresolutely handled and halted time after time; and after waiting as long as possible, the British and Hanoverian cavalry under Sir James Campbell rode forward and extended

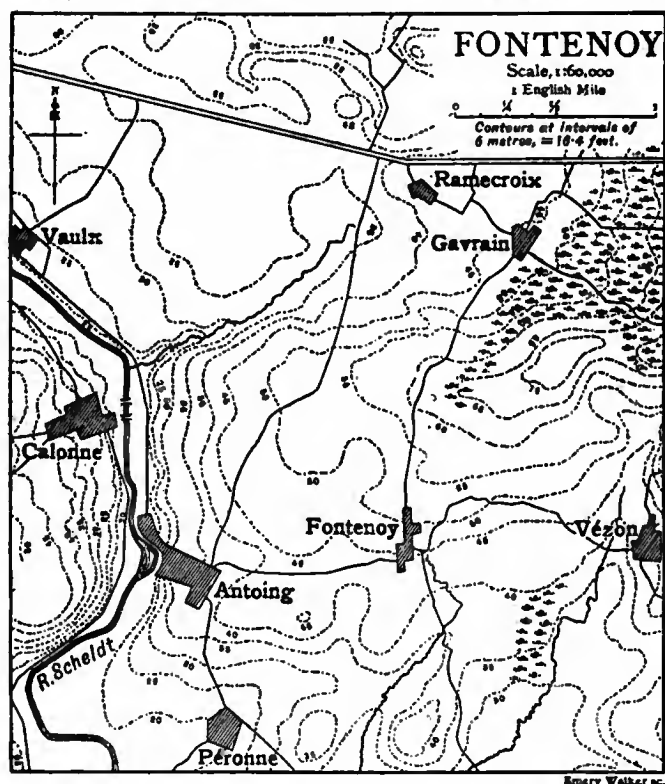

in the plain, becoming at once the target for a furious cannonade which killed their leader and drove them back. Thereupon Sir John (Lord) Ligonier, whose deployment the squadrons were to have covered, let them pass to the rear, and, hearing the guns of the Dutch towards Antoing, pushed the British infantry forward through the lanes, each unit on reaching open ground covering the exit and deployment of the one in rear, all under the French cannonade. This went on for two hours, and save that it showed the magnificent discipline of the British and Hanoverian regiments, was a bad prelude to the real attack. Cumberland's own exertions brought a few small guns to the front of the Guards' Brigade, and one of the first shots from these killed Antoine Louis, duc de Gramont, colonel of the Gardes Françaises, and another Henri du Barailon du Brocard, Saxe's artillery commander.

It was now 9 A.M., and while the guns from the wood redoubt battered the upright ranks of the Allies, Ingoldsby's brigade was huddled together, motionless, on the right. Cumberland himself galloped thither, and under his reproaches Ingoldsby lost the last remnants of self-possession. To Sir John Ligonier's aide-de-camp, who delivered soon afterwards a bitterly formal order to advance, Ingoldsby sullenly replied that the duke's orders were for him to advance in line with Ligonier's main body.

By now, too, the Dutch advance against Antoing-Fontenoy had collapsed.

But on the right the cannonade and the blunders together had roused a stern and almost blind anger in the leaders and the men they led. Ingoldsby was wounded, and his successor, the Hanoverian general Zastrow, gave up the right attack and brought his battalions into the main body. A second half-hearted attack on Fontenoy itself, delivered by some Dutch troops, was almost made successful by the valour of two of these battalions (one of them being the then newly raised Highland regiment, the Black Watch) which came thither of their own accord. Meantime the young duke and the old Austrian field-marshal had agreed to take all risks and to storm through between Fontenoy and the wood redoubt, and had launched the great attack, one of the most celebrated in the history of war. The English infantry was in two lines. The Hanoverians on their left, owing to want of space, were compelled to file into third line behind the redcoats, and on their outer flanks were the battalions that had been with Ingoldsby. A few guns, man-drawn, accompanied the assaulting mass, and the cavalry followed. The column may have numbered 14,000 infantry. All the infantry battalions closed on their centre, the normal three ranks becoming six. If the proper distances between lines were preserved, the mass must have formed an oblong about 500 yds × 600 yds (excluding the cavalry).

The duke of Cumberland placed himself at the head of the front line and gave the signal to advance. Slowly and in parade order, drums beating and colours flying, the mass advanced, straight up the gentle slope, which was swept everywhere by the flanking artillery of the defence. Then, when the first line reached the low crest on the ends of which stood the French artillery, the fire, hitherto convergent, became a full enfilade from both sides, and at the same moment the enemy's horse and foot became visible beyond. A brief pause ensued, and the front gradually contracted as regiments shouldered inwards to avoid the fire. Then the French advanced, and the Guards Brigade and the Gardes Françaises met face to face. Captain Lord Charles Hay (d. 1760), lieutenant of the First (Grenadier) Guards, suddenly ran in front of the line, took off his hat to the enemy and drank to them from a pocket flask, shouting a taunt, "We hope you will stand till we come up to you, and not swim the river as you did at Dettingen," then, turning to his own men, he called for three cheers. The astonished French officers returned the salute and gave a ragged counter-cheer. Whether or not the French, as legend states, were asked and refused to fire first, the whole British line fired one tremendous series of volleys by companies. 50 officers and 760 men of the three foremost French regiments fell at once, and at so appalling a loss the remnant broke and fled. Three hundred paces farther on stood the second line of the French, and slowly the mass advanced, firing regular volleys. It was now well inside the French position, and no longer felt the enfilade fire that swept the crest it had passed over. By now, as the rear lines closed up, the assailants were practically in square and repelled various partial attacks coming from all sides. The Régiment du Roi lost 33 officers and 345 men at the hands of the Second (Coldstream) Guards. But these counter-attacks gained a few precious minutes for the French. It was the crisis of the battle. The king, though the court meditated flight, stood steady with the dauphin at his side,—Fontenoy was the one great day of Louis XV.'s life,—and Saxe, ill as he was, mounted his horse to collect his cavalry for a charge. The British and Hanoverians were now at a standstill. More and heavier counter-strokes were repulsed, but no progress was made; their cavalry was unable to get to the front, and Saxe was by now thinking of victory. Captain Inard of the Touraine regiment suggested artillery to batter the face of the square, preparatory to a final charge. General Löwendahl galloped up to Saxe, crying, "This is a great day for the king; they will never escape!" The nearest guns were planted in front of the assailants, and used with effect. The infantry, led by Löwendahl, fastened itself on the sides of the square, the regiments of Normandy and Vaisseaux and the

Irish Brigade conspicuous above the rest. On the front, waiting for the cannon to do its work, were the Maison du Roi, the Gendarmerie and all the light cavalry, under Saxe himself, the duke of Richelieu and count d'Estrées. The left wing of the Allies was still inactive, and troops were brought up from Antoing and Fontenoy to support the final blow. About 2 P.M. it was delivered, and in eight minutes the square was broken. As the infantry retired across the plain in small stubborn groups the French fire still made havoc in their ranks, but all attempts to close with them were repulsed by the terrible volleys, and they regained the broken ground about Vézon, whence they had come. Cumberland himself and all the senior generals remained with the rearguard.

The losses at Fontenoy were, as might be expected, somewhat less than normally heavy when distributed over the whole of both armies, but exceedingly severe in the units really engaged. Eight out of nineteen regiments of British infantry lost over 200 men, two of these more than 300. A tribute to the loyalty and discipline of the British, as compared with the generality of armies in those days, may be found in the fact that the three Guards' regiments had no "missing" men whatever. The 23rd (Royal Welsh Fusiliers) had 322 casualties. Böschlanger's Hanoverian regiment suffered even more heavily, and four others of that nation had 200 or more casualties. The total loss was about 7500, that of the French 7200. The French "Royal" regiment lost 30 officers and 645 men; some other regimental casualties have been mentioned above. The Dutch lost a bare 7% of their strength.

Fontenoy was in the 18th century what the attack of the Prussian Guards at St Privat is to-day, a *locus classicus* for military theorists. But the technical features of the battle are completely overshadowed by its epic interest, and above all it illustrates the permanent and unchangeable military characteristics of the British and French nations.

FONTEVRAULT, or FONTEVRAUD (Lat. *Fons Ebraldi*), a town of western France, in the department of Maine-et-Loire, 10 m. S.E. of Saumur by road and 2½ m. from the confluence of the Loire and Vienne. Pop. (1906) 1279. It is situated in the midst of the forest of Fontevrault. The interest of the place centres in its abbey, which since 1804 has been utilized and abused as a central house of detention for convicts. The church (12th century), of which only the choir and apse are appropriated to divine service, has a beautiful nave formerly covered by four cupolas destroyed in 1816. There is a fifth cupola above the crossing. In a chapel in the south transept are the effigies of Henry II. of England, of his wife Eleanor of Guienne, of Richard I. of England and of Isabella of Angoulême, wife of John of England—Eleanor's being of oak and the rest of stone. The cloister, refectory and chapter-house date from the 16th century. The second court of the abbey contains a remarkable building, the Tour d'Évrault (12th century), which long went under the misnomer of *chapelle funéraire*, but was in reality the old kitchen. Details and diagrams will be found in Viollet-le-Duc's *Dictionnaire de l'architecture*. There are three stories, the whole being surmounted by a pyramidal structure.

The *Order of Fontevrault* was founded about 1100 by Robert of Arbrissel, who was born in the village of Arbrissel or Arbresec, in the diocese of Rennes, and attained great fame as a preacher and ascetic. The establishment was a double monastery, containing a nunnery of 300 nuns and a monastery of 200 monks, separated completely so that no communication was allowed except in the church, where the services were carried on in common; there were, moreover, a hospital for 120 lepers and other sick, and a penitentiary for fallen women, both worked by the nuns. The basis of the life was the Benedictine rule, but the observance of abstinence and silence went beyond it in stringency. The special feature of the institute was that the abbess ruled the monks as well as the nuns. At the beginning the order had a great vogue, and at the time of Robert's death, 1117, there were several monasteries and 3000 nuns; afterwards the number of monasteries reached 57, all organized on the same plan. The institute never thrived out of France; there were attempts to

introduce it into Spain and England: in England there were three houses—at Ambresbury (Amesbury in Wiltshire), Nuneaton, and Westwood in Worcestershire. The nuns in England as in France were recruited from the highest families, and the abbess of Fontevrault, who was the superior-general of the whole order, was usually of the royal family of France.

See P. Hélyot, *Hist. des ordres religieux* (1718), vi. cc. 12, 13; Max Heimbucher, *Orden und Kongregationen* (1907), i. 46; the arts. "Fontevrauld" in Wetzer and Welte, *Kirchenlexicon* (ed. 2), and in Herzog-Hauck, *Realencyklopädie* (ed. 3), supply full references to the literature. The most recent monograph is Édouard, *Fontevrauld et ses monuments* (1875); for the later history see art. by Edmund Bishop in *Downside Review* (1886). (E. C. B.)

FOOD (like the verb "to feed," from a Teutonic root, whence O. Eng. *foda*; cf. "fodder"; connected with Gr. *παρέσθαι*, to feed), the general term for what is eaten by man and other creatures for the sustenance of life. The scientific aspect of human food is dealt with under NUTRITION and DIETETICS.

Infancy.—The influence of a normal diet upon the health of man (we exclude here the question of diet in illness, which must depend on the abnormal conditions existing) begins at the earliest stage of his life. No food has as yet been found so suitable for the young of all animals as their mother's milk. This, however, has not been from want of seeking. Dr Brouzet (*Sur l'éducation médicale des enfants*, i. p. 165) had such a bad opinion of human mothers, that he expressed a wish for the state to interfere and prevent them from suckling their children, lest they should communicate immorality and disease! A still more determined pessimist was the famous chemist Van Helmont, who thought life had been reduced to its present shortness by our inborn propensities, and proposed to substitute bread boiled in beer and honey for milk, which latter he calls "brute's food." Baron Justus von Liebig, as the result of his chemical researches, introduced a "food for infants," which in more modern days has been followed by a multiplication of patent foods. A close imitation of human milk may also be made by the addition to fresh cow's milk of half its bulk of soft water, in each pint of which has been mixed a heaped-up teaspoonful of powdered "sugar of milk" and a pinch of phosphate of lime. These artificial substitutes for the natural nutriment have their value where for any reason it is not available. The wholesomest food, however, for the first six months is certainly mother's milk alone. A vigorous baby can indeed bear with impunity much rough usage, and often appears none the worse for a certain quantity of farinaceous food; but the majority do not get habituated to it without an exhibition of dislike which indicates rebellion of the bowels. It is only when the teeth are on their way to the front, as shown by dribbling, that the parotid glands secrete an active saliva capable of digesting bread stuffs. Till then anything but milk must be given tentatively, and considered in the light of a means of education for its future mode of nutrition.

The time for weaning should be fixed partly by the child's age, partly by the growth of the teeth. The first group of teeth nine times out of ten consists of the lower central front teeth, which may appear any time during the sixth and seventh month. The mother may then begin to diminish the number of suckling times; and by a month she can have reduced them to twice a day, so as to be ready when the second group makes its way through the upper front gums to cut off the supply altogether. The third group, the lateral incisors and first grinders, usually after the first anniversary of birth, give notice that solid food can be chewed. But it is prudent to let dairy milk form a considerable portion of the fare till the eye-teeth are cut, which seldom happens till the eighteenth or twentieth month.

Childhood and Youth.—At this stage of life the diet must obviously be the best which is a transition from that of infancy to that of adult age. Growth is not completed, but yet entire surrender of every consideration to the claim of growth is not possible, nor indeed desirable. Moreover, that abundance of adipose tissue, or reserve new growth, which a baby can bear is an impediment to the due education of the muscles of the boy or girl. The supply of nutriment need not be so continuous as before, but at the same time should be more frequent than for

the adult. Up to at least fourteen or fifteen years of age the rule should be four meals a day, varied indeed, but nearly equal in nutritive power and in quantity, that is to say, all moderate, all sufficient. The maturity the body then reaches involves a hardening and enlargement of the bones and cartilages, and a strengthening of the digestive organs, which in healthy young persons enables us to dispense with some of the watchful care bestowed upon their diet. Three full meals a day are generally sufficient, and the requirements of mental training may be allowed to a certain extent to modify the attention to nutrition which has hitherto been paramount.

Adults.—It is only necessary here to refer to the article on DIETETICS (see also VEGETARIANISM) for a discussion of the food of normal adults; and to such headings as DIETARY (for fixed allowances) or COOKERY. Different staple articles of food are dealt with under their own headings. For animals other than man see the respective articles on them.

Among numerous books on the subject, in addition to those enumerated under DIETETICS, see Sir Henry Thompson's *Foods and Feeding* (1894); Hart's *Diet in Sickness and Health* (1896); Knight, *Food and its Functions* (1895).

FOOD PRESERVATION. The preservation of food material beyond the short term during which it naturally keeps sound and eatable has engaged human thought from the earliest dawn of civilization. Necessity compelled man to store the plenitude of one season or place against the need of another. The hunter dried, smoked and salted meat and fish, pastoral man preserved milk in the form of cheese and butter, or fermented grape-juice into wine. With the separation of country from town, the development of manufacturing nation as distinct from agricultural and food-producing people, the spreading of civilized man from torrid to arctic zones, the needs of travellers on land and sea and of armies on the march, the problem of the prevention of the natural decomposition to which nearly all food substances are liable became increasingly urgent, and forms to-day, next to the production of food, the most important problem in connexion with the feeding and the trade of nations. As long as the reasons of decomposition were unknown, all attempts at preservation were necessarily empirical, and of the numberless processes which have during modern times been proposed and attempted comparatively few have stood the test of experience. In the light of modern knowledge, however, the guiding principles appear to be very simple.

Very few organic materials undergo decomposition, as it were, of their own accord. They may lose water by evaporation, and fatty substances may alter by the absorption of oxygen from the air. They are otherwise quite stable and unchangeable while not attacked and eaten up by living organisms, or while the life with which they may be endowed is in a state of suspense. An apple is alive and in breathing undergoes its ripening change; a grain of wheat is dormant and does not alter. A substance, in order to be a food material, must be decomposable under the attack of a living organism; the energy stored in it must be available to that stream of energy which we call life, whether the life be in the form of the human consumer or of any lower organism. All decomposition of food is due to the development within the food of living organisms. Under conditions under which living organisms cannot enter or cannot develop food keeps undecomposed for an indefinite length of time. The problem of food preservation resolves itself, therefore, into that of keeping out or killing off all living things that might feed upon and thus alter the food, and as these organisms mainly belong to the family of moulds, yeasts and bacteria, modern food preservation is strictly a subject for the bacteriologist.

The changes which food undergoes on keeping are easily intelligible when once their biological origin is recognized. Yeasts cause the decomposition of saccharine substances into alcohol and carbon dioxide, acetic and lactic ferments produce from sugar or from alcohol the organic acids causing the souring of food, moulds as a rule cause oxidation and complete destruction of organic matter, nitrogenous or saccharine, while most bacteria act mainly upon the nitrogenous constituents, producing

albumoses and peptones and breaking up the complex albumen-molecule into numerous smaller molecules often allied to alkalis, generally with the production of evil-smelling gases. These processes may go on simultaneously, but more frequently take place successively in the decomposition of food, one set of organisms taking up the work of destruction as the conditions become favourable to its development and unfavourable to its predecessor. The organisms may come from the air, the soil or from animal sources. The air teems with organisms which settle and may develop when brought upon a favourable nidus; the organic matter of the soil largely consists of fungoid life; while the intestinal canal and other mucous membranes of all animals harbour bacteria, sarcinae and other organisms in countless millions. Whenever, therefore, food material is exposed to the air, or touched by the soil or by animals or man, it becomes infected with living cells, which by their development lead to its decomposition and destruction.

Fungoid organisms may be killed by heat or by chemicals; or their development may be arrested by cold, removal of water, or by the presence of agents inhibiting their growth though not destroying their life. All successful processes of food preservation depend upon one or other of these circumstances.

Preservation by Heat.—At the boiling-point of water all living cells perish, but some spores of bacteria may survive for about three hours. Few adult bacteria can live beyond 75° C. (167° F.) in the presence of water, though dry heat only kills with certainty at 140° C. (284° F.). Destruction of life takes place more rapidly in solutions showing an acid than a feebly alkaline reaction; hence acid fruit is more easily preserved than milk, which, when quite fresh, is alkaline. By cooking, therefore, food becomes temporarily sterile, until a fresh crop of organisms finds access from the air. By repeated cooking all food can be indefinitely preserved. One of the most important functions of cookery is sterilization. Civilized man unwittingly revolts against the consumption of non-sterile food, and the use of certain fungus-infected material is an inheritance from barbarous ages; few materials of animal origin are eaten raw, and in vegetables some sort of sterilizing process is attempted by washing (of salads) or removal of the outer skin (of fruits). All preparation of food for the table, cooking being the most important, tends towards preservation, but is effectual only for a few hours or days at most, unless special means are adopted to prevent reinfection. The housewife covering the jam with a thin paper soaked in brandy, or the potted meat with a thin layer of lard, attempts unconsciously to bar the road to bacteria and other minute organisms. To preserve food in a permanent manner and on a commercial scale it has to be cooked in a receptacle which must be sufficiently strong for transport, cheap, light and unattacked by the material in contact with it. None of the receptacles at present in use quite fulfils the whole of these conditions: glass and china are heavy and fragile, and their carriage is expensive; tinned iron, so-called tin-plate, is rarely quite unaffected by food materials, but owing to its strength, tenacity and cheapness, it is used on an ever-increasing scale. The sheet iron, which formerly was made of soft wrought iron, now generally consists of steel containing but very little carbon; it is cleaned by immersion in acid and covered with a very thin layer of pure tin, all excess of tin being removed by hot rollers and brushes. The layer of tin, which formerly constituted from 3 to 5% of the total weight of the plate, has, owing to the increased price of tin and the improvement in machinery, gradually become so thin that its weight is only from 1 to 3%. Not rarely, therefore, the tin-surface is imperfect, perforated or pin-holed. Tin itself is slightly attacked by all acid juices of vegetable or animal substances. With the exception of milk, all human food is slightly acid, and consequently all food that has been preserved in tin canisters contains variable traces of dissolved tin. Happily, salts of tin have but little physiological action. Nevertheless, the employment of tin-plate for very acid materials, like tomatoes, peaches, &c., is very objectionable.

The process of preservation in canisters is carried out as

follows:—The canister, which has been made either by the use of solder or by folding machinery only, is packed with the material to be preserved, and a little water having been added to fill the interstices the lid is secured by soldering or folding, generally the former. Sterilization is effected by placing the tins in pressure chambers, which are heated by steam to 120° C. or more. The tins are exposed to that temperature for such time as experience has shown to be necessary to heat the contents throughout to at least 100° C. The temperature is then allowed to fall slowly to below the boiling-point of water, when the tins can be taken out of the pressure chamber, or they are placed in pans filled with water or a solution of calcium chloride and are therein heated till thoroughly cooked. Sometimes a small aperture is pierced through the lid, to allow of the escape of the expanding air, such holes before cooling closed by means of a drop of solder. This process, which was originally introduced by François Appert early in the 19th century, is employed on an enormous scale, especially in America. The use of lacquered tins, having the inner surface of the tin covered with a heat-resisting varnish, is gradually extending. Imperfect sterilization shows itself in many cases by gas development within the tin, which causes the ends to become convex and drummy. More frequently than not the contents of the larger tins, containing meat or other animal products, are not absolutely sterile, but the conditions are mostly such that the organisms which have survived the cooking process cannot develop. When they can develop without formation of gas dangerous products of decomposition may be produced without showing themselves to taste or smell. Numerous cases of so-called ptomaine poisoning have thus occurred; these are more frequently associated with preserved fish and lobster than with meats, although no class of preserved animal food is free from liability of ptomaine formation. The formation of poisonous substances has never been traced to preserved fruit or other material poor in nitrogen. The mode of preserving food in china or glass is quite similar, but the losses by breakage are not inconsiderable. Food which has been preserved in tins is sometimes transferred to glass and re-sterilized, the feeling against “tinned” food caused by the “Chicago scandals” not having entirely subsided. Were it not for the facts that sterilization is rarely quite perfect, and that the food attacks the tin, the contents of tin canisters ought to keep for an indefinite length of time. Under existing circumstances, however, there is a distinct limit to the age of soundness of canned food.

Preservation by Chemicals.—Salt is the oldest chemical preservative and, either alone or in conjunction with saltpetre and with wood-smoke, has been used for many centuries, mainly as a meat preservative. It is used either dry in layers strewn on the surface of the meat or fish to be preserved, or in the form of brine in which the meat is submerged or which is injected into the carcasses. The preserving power of salt is but moderate. It has the great advantage that in ordinary doses it is non-injurious, that an excess at once betrays itself in the taste, and that it can be readily removed by soaking in water. When aided by wood-smoke, which depends for its preservative power upon traces of creosote and formaldehyde, it is, however, quite efficient. The addition of saltpetre is principally for the purpose of giving to the meat a bright pink tint. The strongly saline taste of pickled meat or salted butter appears gradually to have become repugnant to a large part of mankind, and other preservatives have come into use, possessing greater bactericidal power and less taste. The serious objection attaching to them is discussed in the article ADULTERATION. At the present time the use of borax or boracic acid is almost universal in England. Meat which has been exposed to the vapours of formaldehyde, and has thus been superficially sterilized, is also coming into commerce in increasing quantities. Formaldehyde in itself is distinctly poisonous, and has the property of combining with albuminoids and rendering them completely insoluble in the digestive secretions. Salicylic and benzoic acids are not infrequently used to stop fermentation of saccharine beverages or deterioration of so-called “potted meats,” which are supposed

to last fresh and sweet on the consumer's table for a considerable length of time. Sulphurous acid and sulphites are chiefly used in the preservation of thin ales, wine and fruit, and sodium fluoride has been found in butter. The whole of these substances possess decided and injurious physiological properties. Alcohol now rarely forms a preservative of food material, its employment being confined to small fruit. The use of sugar as a preservative depends upon the fact that, although in a dilute solution it is highly prone to fermentation and other decomposition, it possesses bactericidal properties when in the form of a concentrated syrup. A sugar solution containing 30% of water or less does not undergo any biological change; in the presence of organic acids, like those contained in fruit, growth of organisms is inhibited when the percentage of water is somewhat greater. Upon this fact depends the use of sugar in the manufacture of jams, marmalades and jellies. Moulds may grow on the surface of such saccharine preparations, but the interior remains unaffected and unaltered.

Preservation by Drying.—Food materials in which the percentage of moisture is small (not exceeding about 8%) are but little liable to bacterial growths, at most to the attacks of innocent *Penicillium*. Nature preserves the germs in seeds and nuts, which are laden with otherwise decomposable food material, by the simple expedient of water removal. The life of cereal grains and many seeds appears to be unlimited. By the removal of water the most perishable materials, like meat or eggs, can be rendered unchangeable, except so far as the inevitable oxidation of the fatty substances contained in them is concerned and which is independent of life-action. The drying of meat, upon which a generation ago inventors bestowed a great deal of attention, has become almost obsolete, excepting for comparatively small articles or animals, like ox tongues or tails and fish. It has been superseded even among less civilized communities by the spread of canned food. Fruit, however, is very largely preserved in the dried state. Grapes are sun-dried and thus form currants, raisins and sultanas, the last variety being often bleached by the addition of sulphites. Plums, apples and pears are artificially dried in ovens on wooden battens or on wire sieves; from the latter they are apt to become contaminated with notable quantities of zinc. Excellent preparations of dried vegetables, including potatoes, carrots, onions, French beans and cabbages, are also manufactured.

The utilization of meat in the form of meat extract belongs to some extent to this class of preserved foods. Its origin is due to J. von Liebig and Max von Pettenkofer, and dates from the middle of the 19th century. The soluble material is extracted mainly from beef, in Australia to some extent from mutton, by means of warm water; the albumen is coagulated by heat and removed, and the broths thus obtained are evaporated *in vacuo* until the extract contains no more than about 20% of water. One pound of extract is obtained from about 25 lb of lean beef.

Preservation by Refrigeration.—At or below the freezing-point of water fungoid organisms are incapable of growth and multiplication. Although it has been asserted that many of them perish when kept for some time in the frozen condition, it is certain that the vast majority of bacteria and their germs remain merely dormant. Even so highly organized structures as cereal seeds do not suffer in vitality on being kept for a considerable length of time at the far lower temperature of liquid air. Biological change is, therefore, arrested at freezing-point, and as long as that temperature is maintained food material remains unaltered, except for physical changes depending upon the evaporation of water and of volatile flavouring matters, or chemical alterations due to oxidation.

Refrigeration, therefore, affords the means of keeping for a reasonably long time, and without the addition of any preservative substance, food in a raw condition. It is the only process of preservation which from a sanitary point of view is entirely unobjectionable as ordinarily and properly employed. Its introduction on a commercial scale has more powerfully affected the economic conditions of England and, to a less degree,

of the United States than any other scientific advance since the establishment of railways and steamboats. Enormous quantities of frozen carcasses, butter, fruit, vegetables and fish are introduced in the fresh condition into Great Britain and stored until required. Extreme fluctuations of supply or of price have become almost impossible, and the abundance of Australian and New Zealand ranches, and of West Indian orchards, has been made readily accessible to the British consumer. For household purposes cooling in ice-chests or ice-chambers suffices to preserve food on a comparatively small scale. The ice used for the purpose comes, to a small extent, from natural sources, stored from the winter or imported from northern countries; a far larger quantity is artificially produced by the methods described in the article on REFRIGERATING, which also contains an account of the means by which low temperatures are produced for industrial purposes of importation and storage. Fleets of steamships fitted with refrigerating machinery and insulated cold-rooms are employed in carrying the food materials, which are deposited in cold-stores at docks, warehouses, markets and hotels. The first cargo of frozen meat was shipped in July 1873 from Melbourne, but arrived in October in an unsatisfactory state. In 1875-1876 sound frozen meat came from America. The first cargo of frozen meat was successfully brought to the United Kingdom in 1880 from Australia in the "Strathleven," fitted with a Bell-Coleman air machine. The temperature in the cold-storage rooms is generally kept near 34° F., whilst in the chilling chambers a somewhat lower, and in the freezing room or chambers a much lower temperature (between 0° and 10° F.) is maintained. The carcasses to be frozen should be cooled slowly at first to ensure even freezing throughout and to prevent damage by the unequal expansion of the outer layer of ice. The carcasses when freezing must be hung separated from each other, but for storage or transportation they are packed tightly together. Fish such as salmon is washed, thoroughly cleansed, and frozen on trays. Butter should be cooled as rapidly as possible to about 10° F.; its composition as regards proportion of volatile fatty-acids, &c., remains absolutely unaltered for years. Cheese should only be cold-stored when nearly ripe and should not be frozen. Eggs must be carefully selected, each one being inspected by candle-light. They are placed in cases holding about three hundred, which are taken first to a room in which they are slowly cooled to about 33° F., and are then kept in store just below freezing-point. Particular attention must be paid to the relative humidity of the air in egg stores. Fruit should be quite fresh; grapes may be chilled to 26° F., while lemons cannot safely be kept at a lower temperature than 36°. The time during which soft fruit can be kept even in cold-store is limited, and does not exceed about six weeks.

In the early days of the chilled-meat trade considerable prejudice existed against stored meat. While in many cases the flavour of fresh meat is rather superior, the food value is in no way altered by cold-storage.¹

Preservation by Pickling other than Salt.—For the preservation of vegetables, vinegar or other solution of acetic acid is used to a limited extent. Eggs are submerged in lime-water or a dilute solution of sodium silicate (soluble glass). During the storage of eggs the more aqueous white of egg yields by endosmosis a portion of its water to the more concentrated yolk, which thereby expands and renders its thin containing-membrane liable to rupture. Fish, such as sardines, sprats and salmon, is preserved by packing in olive or other oil.

The preservation of the most important dairy product, namely, milk, deserves a separate notice. It has already been stated that alkaline liquids, like milk, are more difficult to sterilize by heat than acid materials. In consequence of the alteration in flavour which milk undergoes by long continued boiling, and of the fact

¹ *Per contra*, see the article by Mary E. Pennington in the *Year-book for 1907* (1908) of the U.S. Dept. of Agriculture, pp. 197-206, with illustrations of chickens kept in cold storage for two and three years. The results there shown cast considerable doubt on the efficiency of even refrigeration so far as an "indefinite" period is concerned; and it is suggested that the consumption of frozen meat may really account for various modern diseases.

that milk forms perhaps the best medium for the growth and propagation of bacterial organisms, there is exceptional difficulty in its sterilization. As secreted by a healthy cow it is a perfectly sterile fluid, and, as shown by Sir J. Lister, when drawn under aseptic conditions and kept under such, it remains definitely fresh and sweet. Bacterial and other pollution at the time of milking arises from the animal, the stable, the milker and the vessels. In animals suffering from tuberculosis and other bacterial affections the milk may be infected within the udder. Milk as it reaches the consumer rarely contains less than 50,000 bacteria and often many millions per cubic centimetre. In fresh country cream 100 millions per cubic centimetre are not unusual. These bacteria are of many kinds, some of them spore-bearing. The spores are more difficult to kill than the adult organism. The first step towards preservation is the removal of the dirt unavoidably present, to the particles of which a considerable proportion of the bacteria adhere. Filtration through cloths or, better, the passing of the milk through centrifugals effects that removal. Subsequent treatment is preferably preceded by a breaking-up of the larger fat-globules by the projection of a jet of the milk under high pressures against a steel or agate plate, a process known as homogenizing. From homogenized milk the cream separates slowly, and does not form the coherent layer thrown up by ordinary milk. Heating is then effected either after bottling or by passing the milk continuously through pipes in which it is heated to from 160° to 170° F. By a repetition of the heating process on two or more succeeding days, complete sterilization may be effected, although a single treatment is sufficient to render the milk stable for a few days. Many forms of pasteurizing apparatus for milk are in use. Since the general introduction of pasteurization of the skim-milk used in Denmark for the feeding of calves and pigs, tuberculosis in these animals has practically disappeared. On the continent of Europe the use of sterilized milk is now very general. In England it has found little favour in households, but is making rapid progress on board ship.

Milk which has been condensed has for many years found a most extensive sale. The first efforts to condense and thus preserve milk date from 1835, when an English patent was granted to Newton. In 1849 C. N. Horsford prepared condensed milk with the addition of lactose. Commercially successful milk condensation began in 1856. The milk is heated to about 180° F. and filled into large copper vacuum pans, after having been mixed with from 10 to 12 parts of sugar per 100 parts of milk. Evaporation takes place in the pans at about 122° F., and is carried on till the milk is boiled down to such concentration that 100 parts of the condensed milk, including the sugar, contain the solids of 300 parts of milk. Sweetened condensed milk, although rarely quite sterile, keeps indefinitely, and is invariably brought into commerce in tin canisters. The preparation of sweetened condensed milk forms one of the most important branches of manufacture in Switzerland and is steadily increasing in England. Although milk can quite well be preserved in the form of condensed unsweetened milk, which dietetically possesses immense advantages over the sweetened milk in which the balance between carbohydrates and albuminoids is very unfavourable, such unsweetened milk has found little or no favour. Milk powder is manufactured under various patents, the most successful of which depends upon the addition of sodium bicarbonate and the subsequent rapid evaporation of the milk on steam-heated revolving iron cylinders. Milk powder made from skim-milk keeps well for considerable periods; but full-cream milk develops rancid or tallowy flavours by the oxidation of the finely divided butter-fat. It is largely employed in the preparation of so-called milk chocolates. (O. H.*)

FOOL (O. Fr. *fol*, modern *fou*, foolish, from a Late Latin use of *folis*, bellows, a ball filled with air, for a stupid person, a jester, a wind-bag), a buffoon or jester.

The class of professional fools or jesters, which reached its culminating point of influence and recognized place and function in the social organism during the middle ages, appears to have existed in all times and countries. Not only have there always

been individuals naturally inclined and endowed to amuse others; there has been besides in most communities a definite class, the members of which have used their powers or weaknesses in this direction as a regular means of getting a livelihood. Savage jugglers, medicine-men, and even priests, have certainly much in common with the jester by profession. There existed in ancient Greece a distinct class of professed fools whose habits were not essentially different from those of the jesters of the middle ages. Of the behaviour of one of these, named Philip, Xenophon has given a picturesque account in the *Banquet*. Philip of Macedon is said to have possessed a court fool, and certainly these (as well as court poets and court philosophers, with whom they have sometimes been not unreasonably confounded) were common in a number of the petty courts at that era of civilization. *Scurrae* and *moriones* were the Roman parallels of the medieval witty fool; and during the empire the manufacture of human monstrosities was a regular practice, slaves of this kind being much in request to relieve the languid hours. The jester again has from time immemorial existed at eastern courts. Witty stories are told of Bahalul (see D'Herbelot, *s.v.*) the jester of Harun al-Reshid, which have long had a place in Western fiction. On the conquest of Mexico court fools and deformed human creatures of all kinds were found at the court of Montezuma. But that monarch no doubt hit upon one great cause of the favour of monarchs for this class when he said that "more instruction was to be gathered from them than from wiser men, for they dared to tell the truth." Douce, in his essay *On the Clowns and Fools of Shakespeare*, has made a ninefold division of English fools, according to quality and place of employment, as the domestic fool, the city or corporation fool, the tavern fool, the fool of the mysteries and moralities. The last is generally called the "vice," and is the original of the stage clowns so common among the dramatists of the time of Elizabeth, and who embody so much of the wit of Shakespeare. A very palpable classification is that which distinguishes between such creatures as were chosen to excite to laughter from some deformity of mind or body, and such as were so chosen for a certain (to all appearance generally very shallow) alertness of mind and power of repartee,—or briefly, butts and wits. The dress of the regular court fool of the middle ages was not altogether a rigid uniform. To judge from the prints and illuminations which are the sources of our knowledge on this matter, it seems to have changed considerably from time to time. The head was shaved, the coat was motley, and the breeches tight, with generally one leg different in colour from the other. The head was covered with a garment resembling a monk's cowl, which fell over the breast and shoulders, and often bore asses' ears, and was crested with a cockscomb, while bells hung from various parts of the attire. The fool's bauble was a short staff bearing a ridiculous head, to which was sometimes attached an inflated bladder, by means of which sham castigations were effected. A long petticoat was also occasionally worn, but seems to have belonged rather to the idiots than to the wits.

The fool's business was to amuse his master, to excite him to laughter by sharp contrast, to prevent the over-oppression of state affairs, and, in harmony with a well-known physiological precept, by his liveliness at meals to assist his lord's digestion. The names and the witticisms of many of the official jesters at the courts of Europe have been preserved by popular or state records. In England the list is long between Hitard, the fool of Edmund Ironside, and Muckle John, the fool of Charles I., and probably the last official royal fool of England. Many are remembered from some connexion with general or literary history. Scogan was attached to Edward IV., and later was published a collection of poor jests ascribed to him, to which Andrew Boorde's name was attached, but without authority.

Will Sommers, of the time of Henry VIII., seems to have been a kind-hearted as well as a witty man, and occasionally used his influence with the king for good and charitable purposes. Armin, who, in his *Nest of Ninnies*, gives a full description of Sommers, and introduces many popular fools, says of him—

"Only this much, he was a poor man's friend,
And helpt the widow often in her end.
The king would ever grant what he would crave,
For well he knew Will no exacting knave."

The literature of the period immediately succeeding his death is full of allusions to Will Sommers.

Richard Tarleton, famous as a comic actor, cannot be omitted from any list of jesters. A book of Tarleton's *Jests* was published in 1611, and, together with his *News out of Purgatory*, was reprinted by Halliwell Phillips for the Shakespeare Society in 1844. Archie Armstrong, for a too free use of wit and tongue against Laud, lost his office and was banished the court. The conduct of the archbishop against the poor fool is not the least item of the evidence which convicts him of a certain narrow-mindedness and pettiness. In French history, too, the figure of the court-jester flits across the gay or sombre scene at times with fantastic effect. Caillette and Triboulet are well-known characters of the times of Francis I. Triboulet appears in Rabelais's romance, and is the hero of Victor Hugo's *Le Roi s'amuse*, and, with some changes, of Verdi's opera *Rigoletto*; while Chicot, the lithe and acute Gascon, who was so close a friend of Henry III., is portrayed with considerable justness by Dumas in his *Dame de Monsoreau*. In Germany Rudolph of Habsburg had his Pfaff Cappadox, Maximilian I. his Kunz von der Rosen (whose features, as well as those of Will Sommers, have been preserved by the pencil of Holbein), and many a petty court its jester after jester.

Late in the 16th century appeared *Le Sottilissime Astuzie di Bertoldo*, which is one of the most remarkable books ever written about a jester. It is by Giulio Cesare Croce, a street musician of Bologna, and is a comic romance giving an account of the appearance at the court of Alboin king of the Lombards of a peasant wonderful in ugliness, good sense and wit. The book was for a time the most popular in Italy. A great number of editions and translations appeared, and it was even versified. Though fiction, both the character and the career of Bertoldo are typical of the jester. That the private fool existed as late as the 18th century is proved by Swift's epitaph on Dicky Pearce, the earl of Suffolk's jester.

See Flögel, *Geschichte der Hofnarren* (Leipzig, 1789); Doran, *The History of Court Fools* (1858). (W. HE.)

FOOLS, FEAST OF (Lat. *festum stultorum, fatuorum, follorum*, Fr. *fête des fous*), the name for certain burlesque quasi-religious festivals which, during the middle ages, were the ecclesiastical counterpart of the secular revelries of the Lord of Misrule. The celebrations are directly traceable to the pagan Saturnalia of ancient Rome, which in spite of the conversion of the Empire to Christianity, and of the denunciation of bishops and ecclesiastical councils, continued to be celebrated by the people on the Kalends of January with all their old licence. The custom, indeed, so far from dying out, was adopted by the barbarian conquerors and spread among the Christian Goths in Spain, Franks in Gaul, Alemanni in Germany, and Anglo-Saxons in Britain. So late as the 11th century Bishop Burchard of Worms thought it necessary to fulminate against the excesses connected with it (*Decretum*, xix. c. 5, Migne, *Patrologia lat.* 140, p. 965). Then, just as it appears to have been sinking into oblivion among the people, the clergy themselves gave it the character of a specific religious festival. Certain days seem early to have been set apart as special festivals for different orders of the clergy: the feast of St Stephen (December 26) for the deacons, St John's day (December 27) for the priests, Holy Innocents' Day for the boys, and for the sub-deacons Circumcision, the Epiphany, or the 11th of January. The Feast of Holy Innocents became a regular festival of children, in which a boy, elected by his fellows of the choir school, functioned solemnly as bishop or archbishop, surrounded by the elder choir-boys as his clergy, while the canons and other clergy took the humbler seats. At first there is no evidence to prove that these celebrations were characterized by any specially indecorous behaviour; but in the 12th century such behaviour had become the rule. In 1180 Jean Belet, of the diocese of Amiens, calls the festival of the sub-deacons *festum stultorum* (Migne, *Patrol. lat.* 202, p. 79).

The burlesque ritual which characterized the Feast of Fools throughout the middle ages was now at its height. A young sub-deacon was elected bishop, vested in the episcopal *insignia* (except the mitre) and conducted by his fellows to the sanctuary. A mock mass was begun, during which the lections were read *cum farsia*, obscene songs were sung and dances performed, cakes and sausages eaten at the altar, and cards and dice played upon it.

This burlesquing of things universally held sacred, though condemned by serious-minded theologians, conveyed to the child-like popular mind of the middle ages no suggestion of contempt, though when belief in the doctrines and rites of the medieval Church was shaken it became a ready instrument in the hands of those who sought to destroy them. Of this kind of retribution Scott in *The Abbot* gives a vivid picture, the Protestants interrupting the mass celebrated by the trembling remnant of the monks in the ruined abbey church, and insisting on substituting the traditional Feast of Fools.

This naive temper of the middle ages is nowhere more conspicuously displayed than in the Feast of the Ass, which under various forms was celebrated in a large number of churches throughout the West. The ass had been introduced into the ritual of the church in the 9th century, representing either Balaam's ass, that which stood with the ox beside the manger at Bethlehem, that which carried the Holy Family into Egypt, or that on which Christ rode in triumph into Jerusalem. Often the ass was a mere incident in the Feast of Fools; but sometimes he was the occasion of a special festival, ridiculous enough to modern notions, but by no means intended in an irreverent spirit. The three most notable celebrations of the Feast of the Ass were at Rouen, Beauvais and Sens. At Rouen the feast was celebrated on Christmas Day, and was intended to represent the times before the coming of Christ. The service opened with a procession of Old Testament characters, prophets, patriarchs and kings, together with heathen prophets, including Virgil, the chief figure being Balaam on his ass. The ass was a hollow wooden effigy, within which a priest capered and uttered prophecies. The procession was followed, inside the church, by a curious combination of ritual office and mystery play, the text of which, according to the *Ordo processionis asinorum secundum Rothomagensis usum*, is given in Du Cange.

Far more singular was the celebration at Beauvais, which was held on the 14th of January, and represented the flight into Egypt. A richly caparisoned ass, on which was seated the prettiest girl in the town holding in her arms a baby or a large doll, was escorted with much pomp from the cathedral to the church of St Étienne. There the procession was received by the priests, who led the ass and its burden to the sanctuary. Mass was then sung; but instead of the ordinary responses to the *Introit*, *Kyrie*, *Gloria*, &c., the congregation chanted "Hinhaw" (Hee-haw) three times. The rubric of the mass for this feast actually runs: *In fine Missae Sacerdos versus ad populum vice, Ite missa est, Hinhannabit: populus vero vice, Deo Gratias, ter respondebit Hinhaw, Hinhaw, Hinhaw* (At the close of the mass the priest turning to the people instead of saying, *Ite missa est*, shall bray thrice: the people, instead of *Deo gratias*, shall thrice respond Hee-haw, Hee-haw, Hee-haw).

At Sens the Feast of the Ass was associated with the Feast of Fools, celebrated at Vespers on the Feast of Circumcision. The clergy went in procession to the west door of the church, where two canons received the ass, amid joyous chants, and led it to the precentor's table. Bizarre vespers followed, sung falsetto and consisting of a medley of extracts from all the vespers of the year. Between the lessons the ass was solemnly fed, and at the conclusion of the service was led by the precentor out into the square before the church (*conductus ad ludos*); water was poured on the precentor's head, and the ass became the centre of burlesque ceremonies, dancing and buffoonery being carried on far into the night, while the clergy and the serious-minded retired to matins and bed.

Various efforts were made during the middle ages to abolish the Feast of Fools. Thus in 1198 the chapter of Paris suppressed

its more obvious indecencies; in 1210 Pope Innocent III. forbade the feasts of priests, deacons and sub-deacons altogether; and in 1246 Innocent IV. threatened those who disobeyed this prohibition with excommunication. How little effect this had, however, is shown by the fact that in 1265 Odo, archbishop of Sens, could do no more than prohibit the obscene excesses of the feast, without abolishing the feast itself; that in 1444 the university of Paris, at the request of certain bishops, addressed a letter condemning it to all cathedral chapters; and that King Charles VII. found it necessary to order all masters in theology to forbid it in collegiate churches. The festival was, in fact, too popular to succumb to these efforts, and it survived throughout Europe till the Reformation, and even later in France; for in 1645 Mathurin de Neuré complains in a letter to Pierre Gassendi of the monstrous fooleries which yearly on Innocent's Day took place in the monastery of the Cordeliers at Antibes. "Never did pagans," he writes, "solemnize with such extravagance their superstitious festivals as do they . . . The lay-brothers, the cabbage-cutters, those who work in the kitchen . . . occupy the places of the clergy in the church. They don the sacerdotal garments, reverse side out. They hold in their hands books turned upside down, and pretend to read through spectacles in which for glass have been substituted bits of orange-peel."

See B. Picart, *Cérémonies et coutumes religieuses de tous les peuples* (1723); du Tilliot, *Mémoires pour servir à l'histoire de la fête des Fous* (Lausanne, 1741); Aimé Cherest, *Nouvelles recherches sur la fête des Innocents et la fête des Fous dans plusieurs églises et notamment dans celle de Sens* (Paris, 1853); Schneegans in Müller's *Zeitschrift für deutsche Kulturgeschichte* (1858); H. Böhmer, art. "Narrenfest" in Herzog-Hauck, *Realencyklop.* (ed. 1903); Du Cange, *Glossarium* (ed. 1884), s.v. "Festum Asinorum."

FOOLSCAP, the cap, usually of conical shape, with a cockscomb running up the centre of the back, and with bells attached, worn by jesters and fools (see FOOL); also a conical cap worn by dunces. The name is given to a size of writing or printing paper, varying in size from 12×15 in. to 17×13½ in. (see PAPER). The name is derived from the use of a "fool's cap" as a watermark. A German example of the watermark dating from 1479 was exhibited in the Caxton Exhibition (1877). The *New English Dictionary* finds no trustworthy evidence for the introduction of the watermark by a German, Sir John Spielmann, at his paper-mill at Dartford in 1580, and states that there is no truth in the familiar story that the Rump Parliament substituted a fool's cap for the royal arms as a watermark on the paper used for the journals of parliament.

FOOL'S PARSLEY, in botany, the popular name for *Aethusa Cynapium*, a member of the family *Umbelliferae*, and a common weed in cultivated ground. It is an annual herb, with a fusiform root and a smooth hollow branched stem 1 to 2 ft. high, with much divided (ternately pinnate) smooth leaves and small compound umbels of small irregular white flowers. The plant has a nauseous smell, and, like other members of the order (e.g. hemlock, water-dropwort), is poisonous.

FOOT, the lower part of the leg, in vertebrate animals consisting of tarsus, metatarsus and phalanges, on which the body rests when in an upright position, standing or moving (see ANATOMY: *Superficial and Artistic*; and SKELETON: *Appendicular*). The word is also applied to such parts of invertebrate animals as serve as a foot, either for movement or attachment to a surface. "Foot" is a word common in various forms to Indo-European languages, Dutch, *voet*, Ger. *Fuss*, Dan. *fod*, &c. The Aryan root is *pod-*, which appears in Sans. *pād*, Gr. *ποῦς*, *ποδός*, and Lat. *pes*, *pedis*. From the resemblance to the foot, in regard to its position, as the base of anything, or as the lowest member of the body, or in regard to its function of movement, the word is applied to the lowest part of a hill or mountain, the plate of a sewing-machine which holds the material in position, to the part of an organ pipe below the mouth, and the like. In printing the bottom of a type is divided by a groove into two portions known as "feet." Probably referring to the beating of the rhythm with the foot in dancing, the Gr. *ποῦς* and Lat. *pes* were applied in prosody to a grouping of syllables, one of which is stressed, forming the division of a verse. "Foot," i.e. foot-soldier, was

formerly, with an ordinal number prefixed, the name of the infantry regiments of the British army. It is now superseded by territorial designations, but it still is used in the four regiments of the infantry of the Household, the Foot Guards. As a lineal measure of length the "foot" is of great antiquity, estimated originally by the length of a man's foot (see WEIGHTS AND MEASURES). For the ceremonial washing of feet, see MAUNDY THURSDAY.

FOOT-AND-MOUTH DISEASE (Apthous Fever, Epizootic Aphtha, Eczema Epizootica), a virulent contagious and inoculable malady of animals, characterized by initial fever, followed by the formation of vesicles or blisters on the tongue, palate and lips, sometimes in the nostrils, fourth stomach and intestine of cattle, and on parts of the body where the skin is thin, as on the udder and teats, between the claws, on the heels, coronet and pastern. The disease begins suddenly and spreads very rapidly. A rise of temperature precedes the vesicular eruption, which is accompanied by salivation and a peculiar "smacking" of the lips. The vesicles gradually enlarge and eventually break, exposing a red raw patch, which is very sensitive. The animal cannot feed so well as usual, suffers much pain and inconvenience, loses condition, and, if a milk-yielding creature, gives less milk, or, if pregnant, may abort. More or less lameness is a constant symptom, and sometimes the feet become very much diseased and the animal is so crippled that it has to be destroyed. It is often fatal to young animals. It is transmitted by the saliva and the discharges from the vesicles, though all the secretions and excretions are doubtless infective, as well as all articles and places soiled by them. This disease can be produced by injecting the saliva, or the lymph of the vesicles, into the blood or the peritoneal cavity.

If we were to judge by the somewhat vague descriptions of different disorders by Greek and Roman writers, this disease has been a European malady for more than 2000 years. But no reliance can be placed on this evidence, and it is not until we reach the 17th and 18th centuries that we find trustworthy proof of its presence, when it was reported as frequently prevailing extensively in Germany, Italy and France. During the 19th century, owing to the vastly extended commercial relations between civilized countries, it has, like the lung-plague, become widely diffused. In the Old World its effects are now experienced from the Caspian Sea to the Atlantic Ocean. Hungary, Lower Austria, Bohemia, Saxony and Prussia were invaded in 1834. Cattle in the Vosges and in Switzerland were attacked in 1837, and the disease extending to France, Belgium and Holland, reached England in 1839, and quickly spread over the three kingdoms (see also under AGRICULTURE). At this time the importation of foreign animals into England was prohibited, and it was supposed that the infection must have been introduced by surplus ships' stores, probably sheep, which had not been consumed during the voyage. This invasion was followed at intervals by eleven distinct outbreaks, and since 1902 Great Britain has been free of foot-and-mouth disease. From the observations of the best authorities it would appear to be an altogether exotic malady in the west of Europe, always invading it from the east; at least, this has been the course noted in all the principal invasions. It was introduced into Denmark in 1841; and into the United States of America in 1870, from Canada, where it had been carried by diseased cattle from England. It rapidly extended through cattle traffic from the state first invaded to adjoining states, but was eventually extinguished, and does not now appear to be known in North America. It was twice introduced into Australia in 1872, but was stamped out on each occasion. It appears to be well known in India, Ceylon, Burma and the Straits Settlements. In 1870 it was introduced into the Andaman Islands by cattle imported from Calcutta, where it was then prevailing, and in the same year it appeared in South America. In South Africa it is frequently epizootic, causing great inconvenience, owing to the bullocks used for draught purposes becoming unfit for work. These cattle also spread the contagion. It is not improbable that it also prevails in central Africa, as Schweinfurth alludes to the cattle of the Dinkas suffering from a disease of the kind.

Though not usually a fatal malady, except in very young animals, or when malignant, yet it is a most serious scourge. In one year (1892) in Germany, it attacked 150,929 farms, with an estimated loss to the owners of £7,500,000 sterling. It is transmissible to nearly all the domestic animals, but its ravages are most severe among cattle, sheep, goats and swine. Human beings are also liable to infection.

The treatment of affected animals comprises a laxative diet, with salines, and the application of antiseptics and astringents to the sores. The preventive measures recommended are, isolation of the diseased animals, boiling the milk before use, and thorough disinfection of all places and substances which are capable of conveying the infection.

FOOTBALL, a game between two opposing sides played with a large inflated ball, which is propelled either by the feet alone or by both feet and hands.

Pastimes of the kind were known to many nations of antiquity, and their existence among savage tribes, such as the Maoris, Faroe Islanders, Philippine Islanders, Polynesians and Eskimos, points to their primitive nature. In Greece the *ἐπίσκυρος* seems to have borne a resemblance to the modern game. Of this we read in Smith's *Dictionary of Antiquities*—"It was the game at football, played in much the same way as with us, by a great number of persons divided into two parties opposed to one another." Amongst the Romans the *harpastum*, derived from the Greek verb *ἀρπάζω*, I seize, thus showing that carrying the ball was permissible, bore a certain resemblance. Basil Kennett, in his *Romae antiquae notitia*, terms this missile a "larger kind of ball, which they played with, dividing into two companies and striving to throw it into one another's goals, which was the conquering cast." The *harpastum* was a gymnastic game and probably played for the most part indoors. The real Roman football was played with the inflated *foliis*, which was kicked from side to side over boundaries, and thus must have closely resembled the modern Association game. Tradition ascribes its introduction in northern Europe to the Roman legions. It has been played in Tuscany under the name of *Calcio* from the middle ages down to modern times.

Regarding the origin of the game in Great Britain the Roman tradition has been generally accepted, although Irish antiquarians assert that a variety of football has been played in Ireland for over 2000 years. In early times the great football festival of the year was Shrove Tuesday, though the connexion of the game with this particular date is lost in obscurity. William Fitzstephen, in his *History of London* (about 1175), speaks of the young men of the city annually going into the fields after dinner to play at the well-known game of ball on the day *quae dicitur Carnilevaria*. As far as is known this is the first distinct mention of football in England. It was forbidden by Edward II. (1314) in consequence of "the great noise in the city caused by hustling over large balls (*rageries de grosses pelotes*)." A clear reference is made "ad pilam . . . pedinam" in the *Rotuli Clausarum*, 39 Edward III. (1365), memb. 23, as one of the pastimes to be prohibited on account of the decadence of archery, and the same thing occurs in 12 Richard II. c. 6 (1388). Both Henry VIII. and Elizabeth enacted laws against football, which, both then and under the Stuarts and the Georges, seems to have been violent to the point of brutality, a fact often referred to by prominent writers. Thus Sir Thomas Elyot, in his *Boke named the Governour* (1531), speaks of football as being "nothyng but beastely fury and extreme violence, whereof procedeth hurte and consequently rancour and malice to remayne with thym that be wounded, wherefore it is to be put in perpetual silence." In Stubbes' *Anatomie of Abuses* (1583) it is referred to as "a develishe pastime . . . and hereof groweth envy, rancour and malice, and sometimes brawling, murder, homicide, and great effusion of blood, as experience daily teacheth." Fifty years later (1634) Davenant is quoted (in Hone's *Table-Book*) as remarking, "I would now make a safe retreat, but methinks I am stopped by one of your heroic games called football; which I conceive (under your favour) not very conveniently civil in the streets, especially in such irregular and narrow roads as Crooked

Lane. Yet it argues your courage, much like your military pastime of throwing at cocks, since you have long allowed these two valiant exercises in the streets."

An evidence of its old popularity in Ireland is that the statutes of Galway in 1527 forbade every other sport save archery, excepting "onely the great foot balle." In the time of Charles II. football was popular at Cambridge, particularly at Magdalene College, as is evidenced by the following extract from the register book of that institution under the date 1679:—

"That no schollers give or receive at any time any treat or collation upon account of ye football play, on or about Michaelmas Day, further than Colledge beere or ale in ye open halle to quench their thirsts. And particularly that that most vile custom of drinking and spending money—Sophisters and Freshmen together—upon ye account of making or not making a speech at that football time be utterly left off and extinguished."

It nevertheless remained for the most part a game for the masses, and never took root, except in educational institutions, among the upper classes until the 19th century. No clubs or code of rules had been formed, and the sole aim seems to have been to drive the ball through the opposing side's goal by fair means or foul. So rough did the game become that James I. forbade the heir apparent to play it, and describes the exercise in his *Basilikon Doron* as "meeter for laming than making able the users thereof." Both sexes and all ages seem to have taken part in it on Shrove Tuesday; shutters had to be put up and houses closed in order to prevent damage; and it is not to be wondered that the game fell into bad repute. Accidents, sometimes fatal, occurred; and Shrove Tuesday "football-day" gradually died out about 1830, though a relic of the custom still remained in a few places. For some thirty years football was only practised at the great English public schools, many of which possessed special games, which in practically all cases arose from the nature of the individual ground. Thus the rough, open game, with its charging, tackling and throwing, which were features of football when it was taken up by the great public schools, would have been extremely dangerous if played in the flagged and walled courts of some schools, as, for example, the old Charterhouse. Hence at such institutions the dribbling style of play, in which Mr Montague Shearman (*Football*, in the "Badminton Library") sees the origin of the Association game, came into existence. Only at Rugby (later at some other schools), which from the first possessed an extensive grass field, was the old game preserved and developed, including even its roughness, for actual "hacking" (*i.e.* intentional kicking of an opponent's legs) was not expressly abolished at Rugby until 1877. The description of the old school game at Rugby contained in *Tom Brown's School Days* has become classic.

1. *Rugby Union*.—We have seen that from early times a rudimentary game of football had been a popular form of sport in many parts of Great Britain, and that in the old-established schools football had been a regular game among the boys. In different schools there arose various developments of the original game; or rather, what, at first, must have been a somewhat rough form of horse-play with a ball began to take shape as a definite game, with a definite object and definite rules. Rugby school had developed such a game, and from football played according to Rugby rules has arisen Rugby football. It was about the middle of the 19th century that football—up till that time a regular game only among schoolboys—took its place as a regular sport among men. To begin with, men who had played the game as schoolboys formed clubs to enable them to continue playing their favourite school game, and others were induced to join them; while in other cases, clubs were formed by men who had not had the experience of playing the game at school, but who had the energy and the will to follow the example of those who had had this experience. In this way football was established as a regular game, no longer confined to schoolboys. When football was thus first started, the game was little developed or organized. Rules were very few, and often there was great doubt as to what the rules were. But, almost from the first, clubs were formed to play football according to Rugby rules—that is, according to the rules of the game as played at Rugby school. But even the

Rugby rules of that date were few and vague, and indeed almost unintelligible to those who had not been at Rugby school. Still, the fact that play was according to Rugby rules produced a certain uniformity; but it was not till the establishment of the English Union, and the commencement of international matches, that a really definite code of rules was drawn up.

It is an interesting question to ask why it was that the game of Rugby school became so popular in preference to the games of other schools, such as Eton, Winchester or Harrow. It was probably very largely due to the reputation and success of Rugby school under Dr Arnold, and this also led most probably to its adoption by other schools; for in 1860 many schools besides Rugby played football according to Rugby rules. The rapidity with which the game spread after the middle of the 19th century was remarkable. The Blackheath club, the senior club of the London district, was established in 1860, and Richmond, its great rival, shortly afterwards. Before 1870, football clubs had been started in Lancashire and Yorkshire; indeed the Sheffield football club dates back to 1855. Likewise, in the universities of Oxford and Cambridge, Rugby football clubs had been formed before 1870, and by that date the game had been implanted both in Ireland and South Wales; while in Scotland, before 1860, football had taken a hold. Thus by 1870 the game had been established throughout the United Kingdom, and in many districts had been regularly played for a number of years. Rapid as, in some ways, had been the spread of the game between the years 1850 and 1870, it was as nothing to what happened in the following twenty years; for by 1890 Rugby football, together with Association football, had become the great winter amusement of the people, and roused universal interest; while to-day on any fine Saturday afternoon in winter there are tens of thousands of people playing football, while those who watch the game can be counted by the hundred thousand. The causes that led to this great increase in the game and interest taken in it were, undoubtedly, the establishment of the various national Unions and the international matches; and, of course, the local rivalry of various clubs, together with cup or other competitions prevalent in certain districts, was a leading factor. The establishment of the English Union led to a codification of the rules without which development was impossible.

In the year 1871 the English Rugby Union was founded in London. This Union was an association of some clubs and schools which joined together and appointed a committee and officials to draw up a code of rules of the game. From this beginning the English Rugby Union has become the governing body of Rugby football in England, and has been joined by practically all the Rugby clubs in England, and deals with all matters connected with Rugby football, notably the choosing of the international teams. In 1873 the Scottish Football Union was founded in Edinburgh on the same lines, and with the same objects, while in 1880 the Welsh Football Union, and in 1881 the Irish Rugby Football Union, were established as the national Unions of Wales and Ireland, though in both countries there had been previously Unions not thoroughly representative of the country. All these Unions became the chief governing body within their own country, and one of their functions was to make the rules and laws of the game; but as this had been done to start with by the English Union, the others adopted the English rules, with amendments to them from time to time. This state of affairs had one element of weakness—*viz.* that since all the Unions made their own rules, if ever a dispute should arise between any of them, a dead-lock was almost certain to ensue. Such a dispute did occur in 1884 between the English and Scottish Unions. This dispute eventually turned on the question of the right of the English Union to make and interpret the rules of the game, and to be the paramount authority in the game, and superior to the other Unions. Scotland, Ireland and Wales resisted this claim, and finally, in 1889, Lord Kingsburgh and Major Marindin were appointed as a commission to settle the dispute. The result was the establishment of the International Board, which consists of representatives from each Union—six from England, two from each of the others—whose duties were to settle any

question that might arise between the different Unions, and to settle the rules under which international matches were to be played, these rules being invariably adopted by the various Unions as the rules of the game.

With the establishment of the International Board the organization of the game was complete. Still harmony did not prevail, and in 1895 occurred a definite disruption. A number of leading clubs in Yorkshire and Lancashire broke off from the English Union and formed the Northern Union, which since that date has had many accessions, and has become the leading body in the north of England. The question in dispute was the payment of players. Football was originally played by men for the sheer love of the game, and by men who were comparatively well-to-do, and who could give the time to play it; but with the increasing popularity of the game it became the pastime of all classes of the people, and clubs began to grow rich by "drawing big gates,"—that is, large numbers of spectators, frequently many thousands in number, paid for the privilege of witnessing the match. In these circumstances the temptation arose to reimburse the player for any out-of-pocket expenses he might be put to for playing the game, and thus it became universally recognized as legitimate to pay a player's expenses to and from a match. But in the case of working men it often meant that they lost part of their weekly wage when they had to go a distance to play a match, or to go on tour with their club—that is, go off for a few days and play one or two matches in different parts of the country—and consequently the claim was made on their behalf to recoup them for their loss of wage; while at the same time rich clubs began to be willing to offer inducements to good players to join their club, and these inducements were generally most acceptable in the form of money. In Association football (see below) professionalism—*i.e.* the hiring and paying of a player for his services—had been openly recognized. A large section of the English Union—the amateur party—would not tolerate anything that savoured of professionalism, and regarded payments made to a player for broken time as illegitimate. The result was the formation of the Northern Union, which allowed such payments, and has practically recognized professionalism. This body has also somewhat altered the laws of the game, and reduced the number of players constituting a team from fifteen to thirteen. In Scotland and Ireland Rugby footballers are strongly amateur; but wherever Rugby football is the popular game of the artisan the professional element is strong.

Besides legislation, one of the functions of the Unions is to select international teams. On the 27th of March 1871 the first international match was played between England and Scotland in Edinburgh. This was a match between teams picked from English and Scottish players. These matches from the first roused widespread interest, and were a great stimulus to the development of the game. With the exception of a few years, when there were disputes between their respective Unions, all the countries of the United Kingdom have annually played one another—England having played Scotland since 1871, Ireland since 1875 and Wales since 1880. Scotland commenced playing Ireland in 1877 and Wales in 1883, while Ireland and Wales met first in 1882 and then in 1884, and since 1887 have played annually. The qualifications of a player for any country were at first vaguely considered to be birth; but they were never definitely settled, and there has been a case of a player playing for two countries. In 1894, however, the International Board decided that no player was to play for more than one country, and this has been the only pronouncement on the question; and though birth is still looked upon as the main qualification, it is not essential. Though international matches excite interest throughout the United Kingdom, the matches between two rival clubs arouse just as much excitement in their district, particularly when the clubs may be taken as representatives of two neighbouring rival towns. But when to this rivalry there is added the inducement to play for a cup, or prize, the excitement is much more intense. Among Rugby players cup competitions have never been so popular as among Association, but the competition for the Yorkshire Cup was very keen in the days before

the establishment of the Northern Union, and this undoubtedly was the main cause of the popularity of the game in that county. Similarly the competition for the South Wales Cup from 1878 to 1887 did a great deal to establish the game in that country. The method of carrying on these competitions is, that all the clubs entered are drawn by lot, in pairs, to play together in the first round; the winners of these ties are then similarly drawn in pairs for the next round, until for the final round there is only one pair left, the winner of which takes the cup. An elaboration of this competition is the "League system" of the Association game. This, likewise, has not been popular with Rugby players. Still it exists in some districts, especially where clubs are anxious to draw big gates. In the League system a certain number of clubs form a league to play one another twice each season; two points are counted for a win and one for a draw. The club which at the end of the season comes out with most points wins the competition. The advantage of this system over a cup competition is, that interest is kept up during the whole season, and one defeat does not debar a club from eventually coming out first.

It is said that wherever Britons go they take their games with them, and this has certainly been the case with Rugby football, especially in New Zealand, South Africa and Australia. An interchange of football visits between these colonies and the motherland is now an important feature in the game. These tours date from 1888, when an English team visited Australia and New Zealand. In the following season, 1889, a team of New Zealanders, some of whom were native Maories, came over to England, and by their play even then indicated how well the grammar of the game had been studied in that colony. Subsequently several British teams visited at intervals New Zealand and Australia, and in 1905 New Zealand sent home a team which eclipsed anything previously accomplished. They played altogether thirty-three matches, including fixtures with England, Ireland, Scotland and Wales, and only sustained one defeat, *viz.* by a try in their match with Wales, a record which speaks for itself. In 1908 a combined team of English and Welsh players toured in New Zealand and Australia, and also visited Canada on their way home. The team was not so strong as could have been wished, and though they did fairly well in Australia, they lost all three "test matches" against New Zealand. In South Africa the game is followed with equal enthusiasm, and the play is hardly inferior, if at all, to that of the New Zealanders. The first British team to visit the Cape went in 1891 through the generosity of Cecil Rhodes, who guaranteed the undertaking against loss. Teams were also sent out in 1896 and 1903; the result of matches played in each visit showing the steady improvement of the colonists. In 1906 the South Africans paid their first visit to England, and the result of their tour proved them to be equally formidable with the New Zealanders. England managed to draw with them, but Scotland was the only one of the home Unions to gain a victory. The success of these colonial visits, more especially financially, created a development very foreign to the intentions of their organizers. The Northern Union as a professional body had drifted into a somewhat parlous state, through suffering on the one hand from a lack of international matches, and on the other from the competition of Association professional teams. The great financial success resulting from the New Zealand tour of 1905 roused the attention of the Northern Union authorities, and they quickly entered into negotiations with New Zealand players to collect a team who would come over and play the Northern Union clubs, the visiting players themselves taking a share of the gate-money. For this purpose a team of New Zealanders toured the north of England in 1907, and their action caused the introduction of professional or Northern Union football in both New Zealand and Australia.

The spread of the game has not, however, been confined to English-speaking races. In France it has found fruitful soil, and numerous clubs exist in that country. Since 1906 international matches have been played between France and England, and the energy of French players, coupled with their national

elan, makes them formidable opponents. The Rugby code has also obtained a firm footing in Canada, India, Ceylon and the Argentine.

The game itself is essentially a winter pastime, as two requisite conditions for its enjoyment are a cool atmosphere and a soft though firm turf. The field of play is an oblong, not more than 110 yds. long nor more than 75 yds. broad, and it usually approximates to these dimensions. The boundaries are marked by lines, called touch-lines, down the sides, and goal-lines along the ends. The touch-lines are continued beyond the goal-lines for a distance of not more than 25 yds.; and parallel to the goal-line and behind it, at a distance of not more than 25 yds., is drawn a line called the dead-ball line, joining the ends of the touch-lines produced. On each goal-line, at an equal distance from the touch-lines, are erected two posts, termed goal-posts, exceeding 11 ft. in height, and generally much more—averaging perhaps from 20 to 30 ft. from the ground, and placed 18 ft. 6 in. apart. At a height of 10 ft. from the ground they are joined by a cross-bar; and the object of the game is to kick the ball over the cross-bar between the upright posts, and so obtain a goal. The ball is egg-shaped (strictly an oblate spheroid), and the official dimensions are—length, 11 to 11½ in.; length circumference, 30 to 31 in.; width circumference, 25½ to 26 in.; weight, 13 to 14½ oz. It is made of indiarubber inflated, and covered with a leather case. Halfway between the two goal-lines there is generally drawn the half-way line, but sometimes it is marked by flags on the touch-line; and 25 yds. from each goal-line there is similarly marked the 25-yds. line. In the original game the side that had gained the majority of goals won the match, and if no goal had been scored, or an equal number, the game was said to be left drawn; but a modification was adopted before long. A goal can be kicked from the field in the ordinary course of play; but from the very first a try goal could be obtained by that side one of whose players either carried the ball across his opponents' goal-line and then touched it down (*i.e.* on the ground), or touched it down after it had been kicked across the goal-line, before any of his opponents. The "try" is then proceeded with as follows: the ball is taken out by a member of the side obtaining the try in a straight line from the spot where it was "touched down," and is deposited in a selected position on the ground in the field of play, the defending side being all confined behind their own goal-line until the moment the ball is so placed on the ground, when another member of the attacking side endeavours to kick it from the ground (a "place kick") over the bar and between the goal-posts. Frequently a goal is kicked; very often not. The modification first allowed was to count that side the winner which had gained the majority of tries, provided no goal or an equal number of goals had been scored; but a majority of one goal took precedence of any number of tries. But this, too, was afterwards abolished, and a system of points instituted by which the side with the majority of points wins. The numerical value, however, of goals and tries has undergone several changes, the system in 1908 being as follows:—A try counts 3 points. A goal from a try (in which case the try shall not count) 5 points. A dropped goal (except from a mark or a penalty kick) 4 points; a dropped goal being a goal obtained by a player who drops the ball from his hands and kicks it the moment it rises off the ground, as in the "half-volley" at cricket or tennis. A goal from a mark or penalty kick 3 points. Under the Northern Union code any sort of goal counts 2 points, a try 3 points; but if a try be converted into a goal, both try and goal count, *i.e.* 5 points are scored.

In the game itself not only may the ball be kicked in the direction of the opponents' goal, but it may also be carried; but it must not be thrown forward or knocked on—that is, in the direction of the opponents' goal—though it may be thrown back. Thus the game is really a combination of football and handball. The main principle is that any one who is not "offside" is in play. A player is offside if he gets in front of the ball—that is, on the opponents' side of the ball, nearer than a colleague in possession of the ball to the opponents' goal-line; when in this position he must not interfere with an opponent or touch the

ball under penalty. The leading feature of the game is the "scrummage." In old days at Rugbyschool there was practically no limit to the numbers of players on each side, and not infrequently there would be a hundred or more players on one side. This was never prevalent in club football; twenty a-side was the usual number to start with, reduced in 1877 to fifteen a-side, the number still maintained. In the old Rugby big sides the ball got settled amidst a mass of players, and each side attempted to drive it through this mass by shoving, kicking, and otherwise forcing their way through with the ball in front of them. This was the origin of the scrummage.

The game is played usually for one hour, or one hour and ten minutes, sometimes for one hour and a half. Each side defends each goal in turn for half the time of play. Of the fifteen players who compose a side, the usual arrangement is that eight are called "forwards," and form the scrummage; two "half-backs" are posted outside the scrummage; and four "three-quarter-backs," a little behind the halves, stretch in a line across the field, their duties being mainly to run and kick and pass the ball to other members of their own side, and to prevent their opponents from doing the same. In recent years, owing to the development of "passing," the field position of the half-backs has undergone a change. One stands fairly close to the scrummage and is known as the "scrum-half," the other takes a position between the latter and the three-quarters, and is termed the "stand-off-half." Behind the three-quarters comes the "full-back" or "back," a single individual to maintain the last line of defence; his duties are entirely defensive, either to "tackle" an opponent who has managed to get through, or, more usually, to catch and return long kicks. Play is started by one side kicking the ball off from the centre of the field in the direction of the opponents' goal. The ball is then caught by one of the other side, who either kicks it or runs with it. In running he goes on until he is "tackled," or caught, by one of his opponents, unless he should choose to "pass" or throw it to another of his own side, who, provided he be not offside, may either kick, or run, or pass as he chooses. The ball in this way is kept moving until it crosses the touch-line, or goal-line, or is tackled. If the ball crosses the touch-line both sides line up at right angles to the point where it crossed the line, and the ball is thrown in straight either by one of the same side whose player carried the ball across the touch-line, or, if the ball was kicked or thrown out, by one of the opposite side. If the ball crosses the goal-line either a try is gained, as explained above, or if the defending side touch it down first, the other side retire to the line 25 yds. from the goal-line, and the defending side kick it up the field. If the ball is tackled the player carrying the ball gets up from the ground as soon as possible, and the forwards at once form the scrummage by putting down their heads and getting ready to shove against one another. They shove as soon as the ball is put down between the two front rows. In the scrummage the object is, by shoving the opponents back or otherwise breaking away with the ball in front, to carry the ball in the direction of the opponents' goal-line by a series of short kicks in which the players run after the ball as fast as possible, while their opponents lie in wait to get the ball, and either by a kick or other device stop the rush. Instead, however, of the forwards breaking away with the ball, sometimes they let the ball come out of the scrummage to their half-backs, who either kick or run with it, or pass it to the three-quarter-backs, and so the game proceeds until the ball is once more "dead"—that is, brought to a standstill. The scrummage appears to be an uninteresting manœuvre, and a strange relic of bygone times; but it is not merely a manœuvre in which weight and strength alone tell—it also needs a lot of dexterity in moving the ball with the feet, applying the weight to best advantage, and also in outflanking the opposing side, as it were—usually termed wheeling—directing all the force to one side of the scrummage and thus breaking away. As a rule the game is a lively one, for the players are rarely at rest; if there is much scrummaging it is called a slow game, but, if much running and passing, a fast or an open game. The spectator, unless he be an expert, prefers the open

game; but in any case the game is always a hard and exciting struggle, frequently with the balance of fortune swaying very rapidly from one side to the other, so that it is a matter of no surprise to find the British public so ardently attached to it.

(C. J. N. F.; C. J. B. M.)

2. *Association*.—It is generally supposed that the English game of Association football is the outcome of the game of football as played at Cambridge University about the middle of the 19th century. In October 1863 a committee, consisting of representatives of the schools of Eton, Harrow, Rugby, Marlborough, Shrewsbury and Westminster, drew up a code of laws which settled the fundamental principle of the "Association" game, as distinguished from other forms of the game which permitted of handling and carrying the ball. In Association football the use of the hands or arms, either for the purpose of playing the ball or impeding or holding an opponent, is absolutely prohibited; "dribbling" or kicking the ball with the feet, and propelling it by the head or body, are the methods to be adopted. The Cambridge laws specially provided for "kicking" the ball. Laws 13 and 14 provided that "the ball, when in play, may be stopped by any part of the body, but may not be held or hit by the hands, arms or shoulders. All charging is fair, but holding, pushing with the hands, tripping up and shinning are forbidden."

The laws of Association football first took practical shape as the outcome of a meeting held on the 26th of October 1863 at the Freemasons' Tavern, London. The clubs which sent delegates were representative of all classes of football then played. The meeting was a momentous one, for not only was the foundation laid of the Football Association, the national association which has since then controlled the game in England, but as the outcome of the differences of opinion which existed as to "hacking" being permissible under the laws, the representatives who favoured the inclusion of the practice, which is now so roundly condemned in both the Association and Rugby games, withdrew and formed the Rugby Union.

The Cambridge laws were considered by the committee of the Football Association at their meeting on the 24th of November 1863. They took the view that those laws "embraced the true principles of the game with the greatest simplicity"; the laws were "officially" passed on the 1st of December 1863, and the first publication was made in *Bell's Life* four days later. These laws have from time to time been modified, but the principles as laid down in 1863 have been adhered to; and the Association game itself has altered very little since 1880. The usual dimensions for a ground are 120 yds. long by 80 yds. wide, and the goals are 8 yds. in width with a cross-bar from post to post 8 ft. from the ground. The ball is about 14 oz. in weight, and must be a perfect sphere from 27 to 28 in. in circumference, as distinguished from the elliptical or egg-shaped Rugby ball. A rectangular space extending to 18 yds. in front of the goals, and marked with lines on the ground, constitutes the "penalty area"; within which, at a distance of 12 yds. opposite the centre of the goal, is the "penalty kick mark." The boundary lines at the sides of the field are called the "touch-lines"; those at the ends (in the centre of which are the goals) being the "goal-lines." The game is started by a place kick from the centre of the field of play, and none of the opposite side is allowed to approach within 10 yds. of the ball when it is kicked off. When the ball passes over the touch line it has to be thrown in by one of the opposite side, and can be returned into the field of play in any direction. If it passes over the goal-line at any time without touching one of the defending side, it has to be kicked out by the goalkeeper or one of the backs from a line marked in front of goal, the spot selected being in front of the post nearest the point where the ball left the field of play. But should it touch one of the defending side in its transit over the goal-line the attacking side has the privilege of a free kick from the corner flag (a "corner kick"). This is often a great advantage, but such free kick does not produce a goal unless the ball touches one of the other players on its way to the post. Ordinarily a goal is scored when the ball goes between the goal-posts and under the cross-bar, not being thrown, knocked on or carried. The regula-

tion duration of a game is an hour and a half, and ends are changed at forty-five minutes. The side winning the toss has the choice of ends or kick-off, and the one obtaining the majority of goals wins. A goal cannot be scored from a free kick except when the free kick has been allowed by the referee as a penalty for certain infringements of the rules by the opposite side; and if such infringement take place within the penalty area on the part of a player on the side then defending the goal, and in the judgment of the referee be intentional, a "penalty kick" is awarded to the attacking side. The penalty kick is a free kick from the penalty kick mark, all the players of the defending side being excluded from the penalty area, except the goalkeeper, who is confined to the goal-line; the result, therefore, being an almost certain goal.

A player is always in play as long as there are three of the opposite side between him and the opposite goal *at the time the ball is kicked*. This "offside" rule gives much trouble to the young player, though why it should do so it is not easy to say. The rule is simple if the words in italics are remembered. The ball must not be carried, knocked or wilfully handled under any pretence whatever, save by the goalkeeper, who is allowed to use his hands in defence of his goal, either by knocking on or throwing, within his own half of the field of play. Thus far he is entitled to go in maintaining his goal, but if he carry the ball the penalty is a free kick. There are other infringements of the rules which also involve the penalty of a free kick, among them the serious offences of tripping, hacking and jumping at a player. Players are not allowed to wear nails in their boots (except such as have their heads driven in flush with the leather), or metal plates or gutta-percha, and any player discovered infringing this rule is liable to be prohibited from taking further part in a match.

In the early 'sixties of the 19th century there were probably not more than twenty-five organized clubs playing Association football in the United Kingdom, and these were chiefly confined in the south of England to the universities and public schools. But whilst the game was being established in the south it was making steady progress in the north, particularly in Yorkshire, where the Sheffield Club had been formed as early as 1854. In 1867 the game had become so well established that it was decided to play an inter-county match. The match, which was played "in the wilds of Battersea Park," terminated in a draw, neither side having obtained a goal; and it did much to stimulate the growing popularity of the game. During the season 1870-1871, only three years later, two matches of an international character were played between Englishmen and Scotsmen in membership with the Football Association; they were not, however, recognized as "international" matches. The first real international match, England *v.* Scotland, was played on the 30th of November 1872 at Partick, Glasgow; the first international match between England and Wales was played at Kennington Oval in 1879; and that between England and Ireland at Belfast in 1882. In 1896 amateur international matches were inaugurated with Germany, Austria and Bohemia; and games are now annually played with Scotland, Wales, Ireland, France, Belgium, Germany, Holland, Austria and other continental countries. As the outcome of the international relations with Scotland, Wales and Ireland, an International Football Association Board was formed in 1882, when a universal code of laws was agreed upon. Two representatives from each of the four national associations constitute the board, whose laws are accepted and observed not only by the clubs and players of the United Kingdom but in all countries where the Association game is played. At a meeting held at Paris on the 21st of May 1904 the "International Federation of Association Football" was instituted. It consists of the recognized national associations in the respective countries; and its objects are to develop and control Association international football. The countries in federation are: Austria, Belgium, Denmark, England, Finland, France, Germany, Hungary, Italy, Netherlands, Norway, Sweden and Switzerland.

The small number of clubs taking part in the game in the early days becomes of interest when compared with the magnitude of

the game in the 20th century. Association football has become one of the most popular of all national sports in the United Kingdom. It is slowly but surely taking a similar position on the continent of Europe and is making progress even in the Far East, Japan being one of its latest adherents. In the season of 1871-1872 the Football Association inaugurated its popular challenge cup competition which is now competed for by both amateur and professional clubs. In the first year fifteen clubs entered, all of which were from the south of England. The first winners of the cup were the Wanderers, who defeated the Royal Engineers in the final tie by one goal to nothing. For the first ten years the competition was mostly limited to the southern clubs, but in the season of 1881-1882 the Blackburn Rovers were only defeated in the final tie by the Old Etonians by one goal to nothing. Professionalism was then unknown in the game, and comparatively little interest was taken in it except by the players themselves. In the following season of 1882-1883 the cup was for the first time taken north by the Blackburn Olympic Club, and it remained in the north for the next nineteen years, until in the season of 1900-1901 it was again brought south by the Tottenham Hotspur Club, who defeated the Sheffield United Club at Bolton by three goals to one. In the following season the cup was again taken north by the Bury Club. In the early days of the competition a few hundred people only attended the final tie, which for many years was played at Kennington Oval in London. In the course of time, however, the interest of the public so largely increased that it became necessary to seek a ground of greater capacity; accordingly in 1893 the final was played at Fallowfield, Manchester, where it was watched by forty thousand people; in 1894 it was played at Everton and in 1895 at the Crystal Palace. The attendance during the following ten years averaged 80,000 people. The record attendance was in the season of 1900-1901, when the south were contesting with the north, the spectators then being upwards of 113,000. In the season of 1908-1909 356 clubs entered the competition; in 1910-11 the number had increased to 404.

The great development of the game necessitated many changes in the system of control. About the year 1880 (although contrary to the rules) a practice of making payment to players crept into the game in the north of England and slowly developed. After some years of debate as to the best method of dealing with this development the Football Association decided in 1885 to legalize and control the payment of players. The rules define a professional player as one who receives remuneration of any sort above his necessary hotel and travelling expenses actually paid, or is registered as a professional. They further provide that training expenses not paid by the players themselves will be considered as remuneration beyond necessary travelling and hotel expenses. Players competing for any money prizes in football contests are also considered professionals.

In 1888 the Football League, a combination of professional clubs of the north and midlands of England, was formed; and a new scheme was inaugurated for the playing of matches on what is known as the "League" principle, the essential advantage of which is that the clubs in membership of a league agree to play with each other "home and home" matches each season, and also bind themselves under certain penalties to play their best team in all league matches. Six years later the Southern League came into existence, primarily with the object of increasing the interest in the game in the south and west of England. The Football League and the Southern League very soon had their imitators, and in 1909 there were upwards of six hundred league competitions playing under the sanction and control of the Football Association. The league system also found favour in Scotland, Wales and Ireland, and has extended to most of the colonies where Association football is played. In the season of 1893-1894 the Amateur Cup Competition, restricted to amateur clubs in membership with the Football Association, was inaugurated. In the first season 32 clubs entered, and the growing popularity of the competition is shown by the fact that in the season of 1908-1909 there were 229 entries.

The Football Association, founded in 1863 with its eleven clubs,

had in 1909 under its jurisdiction upwards of 10,000 amateur clubs and a quarter of a million of amateur players, and 400 professional clubs with 7000 professional players. It has also directly affiliated 52 county, district and colonial associations, and indirectly in membership a large number of minor associations which are affiliated through the county and district associations. The Army Association includes 316 army clubs in Great Britain and Ireland, together with clubs formed by the various battalions in India, South Africa, Gibraltar and other army stations; and the Royal Navy Football Association comprises all ships afloat having Association football clubs.

The regulations of the Football Association, which is the recognized administrative and legislative body for the game in England, make provision for the sanction and control of leagues and competitions; and its rules, regulations, principles and practices very largely prevail in all national associations. The king is the patron, and the council consists of 56 members, a president, 6 vice-presidents, a treasurer, 10 representatives elected by the clubs in the ten divisions into which the country is subdivided, together with representatives of the army, the navy and of county associations in England which have upwards of 50 clubs in membership, each representative being directly appointed by his association. In 1905 the Football Association became incorporated under the Joint Stock Companies Acts, and as a consequence the word "Limited" appears in its title. It is not, however, a trading body; the shareholders are not entitled to any dividend, bonus or profit, nor may the members of the council, who are the directors, receive any payment for their services. The Scottish Football Association is also an incorporated body with similar powers. Many of the leading clubs of the United Kingdom have also become incorporated, but under the regulations of the Football Association they may not pay a larger dividend to their shareholders than 5%, nor may any of the directors receive payment for their services.

The whole policy of legislation in Association football of late years has been naturally to make the game faster by bringing every one into full play. The great aim accordingly has been to encourage combination and to discourage purely individual efforts. In the early days, though there was a certain amount of cohesion, a player had to rely mainly on himself. Even up to the middle of the 'seventies dribbling was looked upon as the great desideratum; it was the essential for a forward, just as long kicks were the main object of a back. The development of the game was of course bound to change all that. The introduction of passing, long or short, but long in particular, placed the dribbler pure and simple at a discount, and necessitated methods with which he was mostly unacquainted. Combined play gradually came to be regarded as the keynote to success. Instead of one full back, as was originally the case, and one half-back, the defence gradually developed by the addition first of a second half, then of a second full back, and still later of a third half-back, until it came to show, in addition to the goalkeeper of course, two full backs and three half-backs. The eight forwards who used to constitute the attack in the earliest days of the Association have been reduced by degrees, as the science of the game became understood, until they now number only five. The effect of the transition has been to put the attack and defence on a more equal footing, and as a natural consequence to make the game more open and thereby generally more interesting and attractive. Association football is indeed, from the standpoint of the spectator, a much brighter game than it was in its infancy, the result of the new methods bringing every one of the eleven players into full relief throughout the game. The players who, as a rule, make or mar the success of a side in modern football are the centre forward and the centre half-back. They are the pivot on which the attack and the defence respectively turn. Instead of close dribbling and following up, the new formation makes for accuracy of passing among the forwards, with intelligent support from the half-backs. The net result is practically the effective combination of the whole side. To do his part as it ought to be done every member of an eleven must work in harmony with the rest, and on a definite system, in all cases subordinating his own

methods and personal interests to promote the general well-being of the side.

(C. W. A.; F. J. W.)
 The literature of British football is very extensive, but the following works are among the best: *Football in the "Badminton Library"* (London, 1904), where the different games played at Eton, Harrow, Rugby, Winchester and other public schools are thoroughly described; Rev. F. Marshall, *Football; the Rugby Game* (London, Cassells); J. E. Vincent, *Football; its History for Five Centuries* (London, 1885); C. J. B. Marriott and C. W. Alcock, *Football ("Oval Series")*; "Football," in the *Encyclopaedia of Sport: The Rugby Football Union Handbook*, Richardson, Greenwich, Official Annual; and *The Football Annual*, Merritt and Hatcher (Association Game), London.

United States.—In America the game of football has been elaborated far more than elsewhere, and involves more complications than in England. From colonial times until 1871 a kind of football generally resembling the English Association game was played on the village greens and by the students of colleges and academies. There was no running with the ball, but dribbling, called "babying," was common. In 1871 a code of rules was drawn up, but they were unsatisfactory and not invariably observed. "Batting the ball," i.e. striking the ball forward with the fists, was allowed. There were two backs, sixteen rushers or forwards, and two rovers or "peanutters," who lurked near the opponents' goal. During this period the first international football game was played at Yale between the college team and one made up of old Etonians, the rules being a compromise between the American and the English.

English Rugby, introduced from Canada, was first played at Harvard University, and in 1875 a match under a compromise set of rules, taken partly from the Rugby Union and partly from the existing American game, was played with Yale. The following year Yale adopted the regular Rugby Union rules, and played Harvard under these. Later, several other colleges adopted these English rules. Absence of tradition necessitated expansion of these laws, and a convention of colleges was assembled. Thenceforward annual conventions were held, which from time to time altered and amplified the rules. A college association was formed, and the game grew in popularity. Public criticism of the roughness shown in the play early threatened its existence; indeed at one time the university authorities compelled Harvard to abstain from the annual game with Yale. Changes in the rules were introduced, and the game has been characterized by less roughness and by increased skill. It has become the most popular autumn game in the United States, the principal university matches often attracting crowds of 35,000 and even 40,000 spectators. The association subsequently disbanded, but a Rules Committee, invited by the University Athletic Club of New York, made the necessary changes in the rules from time to time, and these have been accepted by the country at large. In the West associations were formed; but the game in the East is played principally under separate agreements between the contesting universities, all using, however, one code of rules. Later this Rules Committee amalgamated with a new committee of wider representation. Amateur athletic clubs as well as public and private schools have also taken up the game. The American football season lasts from the middle of September to the first of December only, owing to the severity of the American winter. Professional football is not played in America.

The American Rugby game is played by teams of eleven men on a field of 330 ft. long and 160 ft. wide, divided by chalk lines into squares with sides 5 yds. long, leaving a strip 5 ft. wide on each side of the field. Until 1903 the field was divided by

latitudinal lines only and was therefore popularly called the "gridiron"; subsequently it was called the "checkerboard." The end lines are called "goal-lines," the side "touch-lines." The two lines 25 yds. from each goal-line, and the middle line, or 55 yard-line, are made broader than the rest. In the middle of each goal-line is a goal, consisting of two uprights exceeding 20 ft. in length, set 18 ft. 6 in. apart with a crossbar 10 ft. from the ground. The ball is in shape and material of the English Rugby type.

A match game consists of two periods (*halves*) of thirty-five minutes with an interval of fifteen minutes. Practice games usually have shorter halves. There are four officials: the *umpire*, whose duty it is to watch the conduct of the players and decide regarding fouls; the *referee*, who decides questions regarding the progress of the ball and of play; the *field judge* who assists the referee and keeps the time; and the *linesman*, who (with two

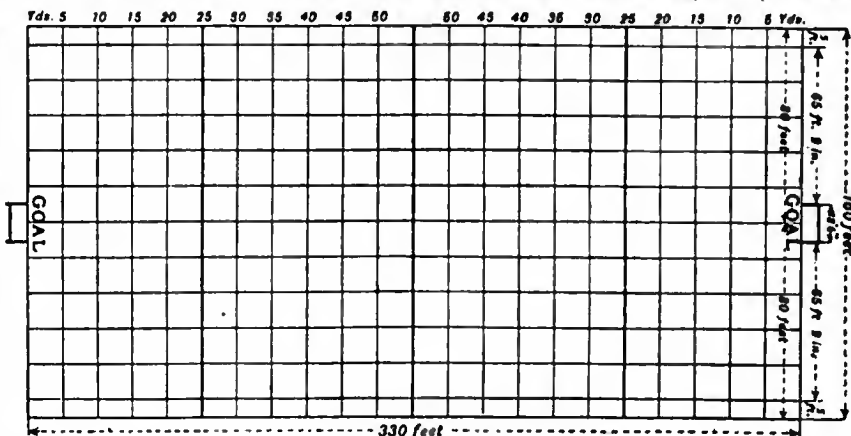

DIAGRAM OF FIELD

The football rules provide that when the ball is put in play in a scrimmage, the first man who receives the ball, commonly known as the quarter-back, may carry it forward beyond the line of scrimmage, provided in so doing he crosses such line at least 5 yds. from the point where the snapper-back put the ball in play, and furthermore, that a forward pass may be made provided the ball passes over the line of scrimmage at least 5 yds. from the point at which the ball is put in play. The field is marked off at intervals of 5 yds. with white lines parallel to the goal line, for convenience in penalizing fouls and for measuring the 10 yds. to be gained in three downs, and also at intervals of 5 yds. with white lines parallel to the side lines, in order to assist the referee in determining whether the quarter-back runs according to rule, or whether, in case of a forward pass, such pass is legally made. Thus the football field is changed from the gridiron as in 1902, to what now resembles a checkerboard, and the above diagram shows exactly how the field should be marked. As the width of the field does not divide evenly into 5 yd. spaces, it is wise to run the first line through the middle point of the field and then to mark off the 5 yds. on each side from that middle line. In order to save labour, it may be sufficient to omit the full completion of the longitudinal lines, as the object of these lines is accomplished if their points of intersection with the transverse lines are distinctly marked, for instance, by a line a foot long.

assistants, one representing each eleven) marks the distance gained or lost in each play.

In scoring, a "touchdown" (the English Rugby "try") counts 5 points, a goal from a touchdown 6 (or one added to the 5 for the touchdown), a "goal from the field," whether from placement or drop-kick, 4, and a "safety" (the English Rugby "touchdown") 2. *Mutatis mutandis*, these are made as in English Rugby. American Rugby differs from the English game, because in the scrimmage the men are lined up opposite each other, and, although separated by the length of the ball, are engaged in a constant man-to-man contest, and also in that a system of "interference" is allowed. Furthermore, a player in the American game is put "on side" when a kicked ball strikes the ground; and forward passing, i.e. throwing the ball toward the opponents' goal, is permissible under certain restrictions. The costume usually consists of a close-fitting jersey with shoulders and elbows padded and reinforced with leather; short trousers with padded thighs and knees, heavy stockings and shoes with leather cleats. In the early period of the game caps were worn, but, as they were impossible to keep on, they were discarded in favour of the wearing of long hair, and the "chrysanthemum head" became the distinguishing mark of the football player. This, however,

proved an inadequate protection, and some players now wear a "head harness" of soft padded leather. Substitutes are allowed in the places of injured players.

The object of the game is identical with that of English Rugby, and the rules in regard to fair catches, punting, drop-kicking, place-kicking, goal-kicking, passing and gentlemanly conduct are practically the same, except that, on a free kick after a fair catch, the opposing players in the American game may not come up to the mark but must keep 10 yds. in front of it. In the American game there is no scrummage in the English sense, nor is the ball thrown in at right angles after going into touch. The element of chance in both these methods of play was done away with by the enunciation of the principle of the "possession of the ball." In America, when the ball has gone out of bounds or a runner has been tackled and held and the ball downed, the ball is also put into play by an evolution called a scrummage, usually called "line-up," which beyond the name bears no resemblance to the English scrummage. The ball, at every moment of the game, belongs theoretically either to one side or to the other. It may be lost by a fumble, or by the side in possession not being able to make the required distance of 10 yds. in three successive attempts or by a voluntary kick. In the line-up the seven line-men (*i.e.* forwards) face each other on a line parallel to the goal-lines on the spot where it was ordered down by the referee. The ball is placed on the ground by the centre-rush, also called the snapper-back, who, upon the signal being given by his quarter-back, "snaps back" the ball to this player, or to the full-back, by a quick movement of the hand or foot. The moment the ball is snapped-back it is in play. In every scrummage it is a foul for the side having the ball (attacking side) to obstruct an opponent except with the body (no use may be made of hands or arms); or for the defending side to interfere with the snap-back. The defenders may use their hands and arms only to get their opponents out of the way in order to get at the man with the ball. Each member of the attacking side endeavours, of course, to prevent his opponents from breaking through and interfering with the quarter-back, who requires this protection from his line in order to have time to pass the ball to one of the backs, whom he has notified by a signal to be ready. In the United States a player may be obstructed by an off-side opponent so long as hands and arms are not used. In the line-up this is called "blocking-off" and "interference" when done to protect a friend running with the ball. Interference is one of the most important features of American football. As soon as the ball is passed to one of the half-backs for a run, for example, round one end of the line, his interference must form immediately. This means that one or more of his fellows must accompany and shield him as he runs, blocking off any opponent who tries to tackle him. The first duty of the defence against a hostile run is therefore to break up the interference, *i.e.* put these defenders out of the play, so that the runner may be reached and tackled.

The game begins by the captains tossing for choice of kick-off or goal. If the winner of the toss chooses the goal, on account of the direction of wind, the loser must kick off and send the ball at least 10 yds. into the opponents' territory from a place-kick from the 55 yds. line. The two ends of the kicking side, who are usually fast runners, get down the field after the ball as quickly as possible, in order to prevent the man who catches the kick-off from running back with the ball. When the kick-off is caught, the catcher with the aid of interference runs it back as far as possible, and as soon as he is tackled and held by his opponents the ball is down and a line-up takes place, the ball being in the possession of the catcher's side, which now attacks. In order to prevent the so-called "block game," once prevalent, in which neither side made any appreciable progress, the rules provide that the side in possession of the ball must make *at least 10 yds. in three successive attempts*, or, failing to do so, must surrender the ball to the enemy, or, as it is called, "lose the ball on downs." This is infrequent in actual play, because if, after two unsuccessful attempts, or partly successful, it becomes evident that the chances of completing the obligatory 10-yd. gain on the remaining attempt are unfavourable, a forward

pass or a kick is resorted to, rather than risk losing the ball on the spot. The kick, although resulting in the loss of the ball, nevertheless gives it to the enemy much nearer his goal. When the wind is strong the side favoured by it usually kicks often, as the other side, not being able to kick back on equal terms, is forced to play a rushing game, which is always exhausting. Again, the kicking game is often resorted to by the side that has the lead in the score, in order to save its men and yet retain the advantage. The only remaining way to advance the ball is on a free-kick after a fair catch, as in the English game. The free kick may be either a punt, a drop-kick or a kick from placement. Whenever the ball goes over the side line into touch it is brought back to the point where it crossed the line by the man who carried it over, or, if kicked or knocked over, by a man of the side which did not kick it out, and there put in play in one of two ways. Either it may be touched to the ground and then kicked at least 10 yds. towards the opponents' goal, or it may be taken into the field at right angles to the line a distance not less than 5 yds. nor more than 15, and there put down for a line-up, the player who takes it in first declaring how far he will go, so that the opposing team may not be caught napping.

Of the seven men in the line, the centre is chosen for his weight and ability to handle the ball cleanly in snapping back. He must also, in case the full-back is to make the next play, be able to throw the ball from between his legs accurately into the full-back's hands, thus saving the time that would be wasted if the quarter-back were used as an intermediary. The two "guards," who must also be heavy men, form with the centre the bulk of the line, protecting the backs in offence, and in defence blocking the enemy. The two "tackles" must be heavy yet active and aggressive men, as they must not only help the centre and guards in repelling assaults on the middle of the line, but also assist the ends in stopping runs round the line as well as those between tackle and end, a favourite point of attack. The "ends" are chosen for their activity, sure tackling, fast running and ability to follow up the ball after a kick. Of the four players behind the line, the full-back must be a sure catcher and tackler and a fast runner. The two half-backs must also be fast runners and good dodgers. One of them is often chosen for his ability to gain ground by "bucking the line," *i.e.* plunging through the opposing team's line. He must therefore be over the average weight, while the other half-back is called upon to gain by running round the opposing ends. The quarter-back is the commanding general and therefore the most important member of his side, as with him lies the choice of plays to be made when on the attack. Courage, coolness, promptness in decision and discrimination in the choice of plays are the qualities absolutely required for this position. As soon as his side obtains the ball, the quarter-back shouts out a signal, consisting of a series of numbers or letters, or both, which denotes a certain play that is to be carried through the moment the ball is snapped back. A good quarter-back thinks rapidly and shouts his signal for the next play as soon as a down has been called and while the scrummage is forming, so that the plays are run off rapidly and the enemy is given as little time as possible to concentrate. The signals, which are secret and often changed to guard them from being solved by the enemy, are formed by designating every position and every space in the line, as well as kicks and other open plays, by a number or letter. Some signals are called sequence-signals, and indicate a prearranged series of plays for use in certain emergencies. Every manœuvre of the attacking side is carried out by every member of the team, the ideal being "every man in every play every time." As soon as a signal is given each man should know what part of the ensuing move will fall to him, in carrying the ball, interfering for the runner, or getting down the field under a punt. Every team has its own code.

About 1890 the system of interference led to momentum and mass plays (wedge-formations, tandems, &c.), *i.e.* to the grouping of bodies of men behind the line, and starting them before the ball was snapped back, so that they struck the line with an acquired momentum that was extremely severe, particularly when met by men equally determined. These plays caused

frequent injuries and led to legislation against them, the most important law providing for a limitation to the number of men who could be dropped back of the line, and practically keeping seven men drawn up in the line.

Penalties are of three kinds: (1) forfeiture of the game, for refusing to play when directed to do so by the referee, and for repeated fouls made with the intention of delaying the game; (2) disqualification of players for unnecessary roughness or ungentlemanly conduct; and (3) for infringement of rules, for which certain distances are taken away from the previous gains of the side making the fouls.

The game resolves itself into a series of scrimmages interspersed with runs and kicks. The systematized development of plays places at the disposal of the quarter an infinite variety of attack, which he seeks to direct at the opposing line with bewildering rapidity and dash. During the preliminary games of the season "straight football" is generally played; that is, intricate attacks are avoided and kicks and simple plunges into the line are mainly relied upon. "Trick plays," which comprise all manœuvres of an intricate nature, are reserved for later and more important matches. Among these is the "fake (false) kick," in which the full-back takes position as if to receive the ball for a kick, but the ball is passed to a different player for a run. Another play of this kind is the "wing-shift," in which some or all of the players on one side of centre suddenly change to the other side, thus forming a mass and throwing the opponents' line out of balance. To this category belong also "double passes," "false passes," "delayed passes," "delayed runs" and "criss-crosses."

Training for football in America resembles that for other sports in regard to food and hygiene. The coaching systems at the universities differ, but there is generally a head coach, who is assisted by graduates, each of whom pays especial attention to one set of men, one to the men in the centre of the line, one to the backs, another to the ends, &c. Candidates for the teams are put through a severe course of practice in catching punts and hard-thrown passes, in quick starts, falling on the ball, tackling a mechanical dummy, in blocking, breaking through the line, and all kinds of kicking, although in matches the kicking is generally left to one or two men who have shown themselves particularly expert. Every player is taught to dive for the ball whenever he sees it on the ground, as possession is of cardinal importance in American football, and dribbling for this reason is unknown. When running with the ball the player is taught to take short steps, to follow his interference, that is, not isolate himself from his defenders, and neither to slow up nor shut his eyes when striking the opposing line. Tackling well below the waist is taught, but it is a foul to tackle below the knee. The general rule for defensive work of all kinds is "play low."

See Walter Camp, *How to play Football*, and the *Official Football Guide* (annual), both in Spalding's Athletic Library; his *Book of College Sports* (New York, 1893), his *American Football* (New York, 1894), and his *Football* (Boston, 1896)—the last in co-operation with L. F. Deland; R. H. Barbour, *The Book of School and College Sports* (New York, 1904); W. H. Lewis, *Primer of College Football* (Boston, 1896). (E. B.; W. Ca.)

FOOTE, ANDREW HULL (1806–1863), American admiral, was born at New Haven, Connecticut, on the 12th of September 1806, his father, Samuel Augustus Foote (1780–1846), being a prominent lawyer and Whig politician, who as U.S. senator moved in 1829 "Foote's resolutions" on public lands, in the discussion of which Daniel Webster made his "reply to Hayne." He entered the U.S. navy in 1822, and was commissioned lieutenant in 1830. After cruising round the world (1837–1840) in the "John Adams," he was assigned to the Philadelphia Naval Asylum, and later (1846–1848) to the Boston Navy Yard. In 1849 he was made commander of the "Perry," and engaged for two years in suppressing the slave trade on the African coast. In 1856, as commander of the "Portsmouth," he served on the East India station, under Com. James Armstrong, and he captured the Barrier Forts near Canton. From October 1858 to the outbreak of the Civil War, he was in charge of the Brooklyn Navy Yard,

becoming a full captain in 1861. In August 1861 he was assigned to the command "of the naval operations upon the Western waters." His exploit in capturing Fort Henry (on the right bank of the Tennessee river) from the Confederates, on the 6th of February 1862, without the co-operation of General Grant's land forces, who had not arrived in time, was a brilliant success; but their combined attack on Fort Donelson (12 m. off, on the left bank of the Cumberland river), whither most of the Fort Henry garrison had escaped, resulted, before its surrender (Feb. 16), in heavy losses to Foote's gunboats, Foote himself being severely wounded. In March-April he co-operated in the capture of New Madrid (*q.v.*) and Island No. 10. In June he retired from his command and in July was promoted rear-admiral, and became chief of the Bureau of Equipment and Recruiting. On the 26th of June 1863 he died at New York.

See the life (1874) by Professor James Mason Hoppin (1820–1906). **FOOTE, MARY HALLOCK** (1847–), American author and illustrator, was born in Milton, New York, on the 19th of November 1847, of English Quaker ancestry. She was educated at the Poughkeepsie (N.Y.) Female Collegiate Seminary and at the Cooper Institute School of Design for women, in New York. In 1876 she married Arthur De Wint Foote, a mining engineer, and subsequently lived in the mining regions of California, Idaho, Colorado and Mexico. She is best known for her stories, in which, as in her drawings, she portrays vividly the rough picturesque life, especially the mining life, of the West. Some of her best drawings appear in her own books. Among her publications are *The Led-Horse Claim* (1883), *John Bodewin's Testimony* (1886), *The Chosen Valley* (1892), *Cœur d'Alene* (1894); *The Prodigal* (1900), a novelette; *The Desert and the Sown* (1902); and several collections of short stories, including *A Touch of Sun and other Stories* (1903).

FOOTE, SAMUEL (1720–1777), English dramatist and actor, was baptized at Truro on the 27th of January 1720. Of his attachment to his native Cornwall he gives no better proofs as an author than by making the country booby Timothy (in *The Knights*) sound the praises of that county and of its manly pastimes; but towards his family he showed a loyal and enduring affection. His father was a man of good family and position. His mother, Eleanor Goodere, whom he is said in person as well as in disposition to have strongly resembled, he liberally supported in the days of his prosperity, and after her death indignantly vindicated her character from the imputations recklessly cast upon it by the revengeful spite of the duchess of Kingston. About the time when Foote came of age, he inherited his first fortune through the murder of his uncle, Sir John Dinely Goodere, Bart., by his brother, Captain Samuel Goodere. Foote was educated at the collegiate school at Worcester, and at Worcester College, Oxford, distinguishing himself in both places by mimicry and audacious pleasantries of all kinds, and, although he left Oxford without taking his degree, acquiring a classical training which afterwards enabled him neatly to turn a classical quotation or allusion, and helped to give to his prose style a certain fluency and elegance.

Foote was "designed" for the law, but certainly not by nature. In his chambers at the Temple, and in the Grecian Coffee-house hard by, he learned to know something of lawyers if not of law, and was afterwards able to jest at the jargon and to mimic the mannerisms of the bar, and to satirize the Latitats of the other branch of the profession with particular success. The famous argument in *Hobson v. Nobson*, in *The Lame Lovers*, is almost as good of its kind as that in *Bardell v. Pickwick*. But a stronger attraction drew him to the Bedford Coffee-house in Covent Garden, and to the theatrical world of which it was the social centre. After he had run through two fortunes (the second of which he appears to have inherited at his father's death), and had then passed through severe straits, he made his first appearance on the actual stage in 1744. It is said that he had married a young lady in Worcestershire; but the traces of his wife (he affirmed himself that he was married to his washer-woman) are mysterious, and probably apocryphal.

Foote's first appearance as an actor was made little more than

two years after that of Garrick, as to whose merits the critics, including Foote himself, were now fiercely at war. His own first venture, as Othello, was a failure; and though he was fairly successful in genteel comedy parts, and was, after a favourable reception at Dublin, enrolled as one of the regular company at Drury Lane in the winter of 1745-1746, he had not as yet made any palpable hit. Finding that his talent lay neither in tragedy nor in genteel comedy, he had begun to wonder "where the devil it *did* lie," when his successful performance of the part of Bayes in *The Rehearsal* at last suggested to him the true outlet for his extraordinary gift of mimicry. Following the example of Garrick, he had introduced into this famous part imitations of actors, and had added a variety of other satirical comment in the way of "gag." Engaging a small company of actors, he now boldly announced for the 22nd of April 1747, at the theatre in the Haymarket "*gratis*," "a new entertainment called the *Diversions of the Morning*," to which were to be added a farce adapted from Congreve, and an epilogue "spoken by the B-d-d Coffee-house." Foote's success in these *Diversions* obtained for him the name of "the English Aristophanes," an absurd compliment, declined by Foote himself (see his letter in *The Minor*). The *Diversions* consisted of a series of imitations of actors and other well-known persons, whose various peculiarities of voice, gesture, manner or dress were brought directly before the spectators, while the epilogue introduced the wits of the Bedford engaged in ludicrous disputation, and specially "took off" an eminent physician (probably the munificent Sir William Browne, whom he afterwards caricatured in *The Devil on Two Sticks*), and a notorious quack oculist of the day. The actors ridiculed in this entertainment having at once procured the aid of the constables for preventing its repetition, Foote immediately advertised an invitation to his friends to drink a dish of tea with him at the Haymarket on the following day at noon—"and 'tis hoped there will be a great deal of comedy and some joyous spirits; he will endeavour to make the morning as diverting as possible. Tickets for this entertainment to be had at St George's coffee-house, Temple-Bar, without which no person will be admitted. N.B.—*Sir Dilbury Diddle will be there, and Lady Betty Frisk has absolutely promised.*" The device succeeded to perfection; further resistance was abandoned as futile by the actors, whom Foote mercilessly ridiculed in the "instructions to his pupils" which the entertainer pretended to impart (typifying them under characters embodying their several chief peculiarities or defects—the massive and sonorous James Quin as a watchman, the shrill-voiced Lacy Ryan as a razor-grinder, the charming Peg Woffington, whose tones had an occasional squeak in them, as an orange-woman crying her wares and the bill of the play); and Mr Foote's *Chocolate*, which was afterwards converted into an evening *Tea*, became an established favourite with the town.

In spite of this success, he seems to have contrived to spend a third fortune, and to have found it necessary to eke out his means by a speculation in small-beer, as is recorded in an amusing anecdote told of him by Johnson. But he could now command a considerable income; and when money came he seems to have freely expended it in both hospitality and charity. During his engagements at Covent Garden and at Drury Lane, of which he was joint-manager, and in professional trips to Scotland, and more especially to Ireland, he appeared both in comedies of other authors and more especially in his own. He played Hartop in his *Knights* (1749, printed 1754). *Taste* (1752), in which parts of the *Diversions* were incorporated, was followed by some eighteen pieces, the majority of which were produced at the Haymarket, the favourite home of Foote's entertainments. In 1760 he succeeded in obtaining for this theatre a licence from the lord chamberlain, afterwards (in 1766) converted into a licence for summer performances for life. The entertainments were a succession of variations on the original idea of the *Diversions* and the *Tea*. Now, it was an *Auction of Pictures* (1748), of part of which an idea may be formed from the second act of the comedy *Taste*; now, a lecture on *Orators* (1754), suggested by some bombastic discourses given by Macklin in

his old age at the Piazza coffee-house in Covent Garden, where Foote had amused the audience and confounded the speaker by interposing his humorous comments. *The Orators* is preserved in the shape of a hybrid piece, which begins with a mock lecture on the art of oratory and its representatives in England, and ends with a diverting scene of a pot-house forum debate, to which Holberg's *Politician-Tinman* can hardly have been a stranger. At a later date (1773) a new device was introduced in a *Puppet-show*. The piece (unprinted) played in this by the puppets was called *Piety in Pattens*, and professed to show "by the moral how maidens of low degree might become rich from the mere effects of morality and virtue, and by the literature how thoughts of the most commonplace might be concealed under cover of words the most high flown." In other words, it was an attack upon sentimental comedy, which was still not altogether extinguished. An attack upon Garrick in connexion with the notorious Shakespeare jubilee was finally left out from the *Puppet-show*, and thus was avoided a recurrence of the quarrel which many years before had led to an interchange of epistolary thrusts, and an imitation by Woodward of the imitative Foote.

On the whole, the relations between the two public favourites became very friendly, and on Foote's part unmistakably affectionate, and they have not been always generously represented by Garrick's biographers. A comparison between the two as actors is of course out of the question; but, though Foote was a buffoon, and his tongue a scurrilous tongue, there is no authentic ground for the suggestion that his character was one of malicious heartlessness. Of Samuel Johnson's opinions of him many records remain in Boswell; when Johnson had at last found his way into Foote's company (he afterwards found it to Foote's own table) he was unable to "resist" him, and, on hearing of Foote's death, he thought the career just closed worthy of a lasting biographical record.

Meanwhile most of poor Foote's friendships in high life were probably those that are sworn across the table, and require "t'other bottle" to keep them up. It is not a pleasant picture—of Lord Mexborough and his royal guest the duke of York, and their companions, bantering Foote on his ignorance of horsemanship, and after he had weakly protested his skill, taking him out to hounds on a dangerous animal. He was thrown and broke his leg, which had to be amputated, the "patientee" (in which character he said he was now making his first appearance) consoling himself with the reflection that he would now be able to take off "old Faulkner" (a pompous Dublin alderman with a wooden leg, whom he had brought on the stage as Peter Paragraph in *The Orators*) "to the life." The duke of York made him the best reparation in his power by promising him a life-patent for the theatre in the Haymarket (1766); and Foote not only resumed his profession, as if, like Sir Luke Limp, he considered the leg he had lost "a redundancy, a mere nothing at all," but ingeniously turned his misfortune to account in two of his later pieces, *The Lame Lover* and *The Devil on Two Sticks*, while, with the true instinct of a public favourite, making constant reference to it in plays and prologues. Though the characters played by him in several of his later plays are comparatively short and light, he continued to retain his hold over the public, and about the year 1774 was beginning to think of withdrawing, at least for a time, to the continent, when he became involved in what proved a fatal personal quarrel. Neither in his entertainments nor in his comedies had he hitherto (except in Garrick's case, and it is said in Johnson's) put any visible restraint upon personal satire. *The Author*, in which, under the infinitely humorous character of Cadwallader, he had brought a Welsh gentleman of the name of Ap-Rice on the stage, had, indeed, been ultimately suppressed. But in general he had pursued his hazardous course, mercilessly exposing to public ridicule and contempt not only fribbles and pedants, quacks or supposed quacks in medicine (as in *The Devil on Two Sticks*), enthusiasts in religion, such as Dr Dodd (in *The Cozeners*) and George Whitefield and his connexion (in *The Minor*). He had not only dared the wrath of the whole Society of Antiquaries (in *The*

Nabob), and been rewarded by the withdrawal, from among the pundits who rationalized away Whittington's Cat, of Horace Walpole and other eminent members of the body, but had in the same play attacked a well-known representative of a very influential though detested element in English society,—the "Nabobs" themselves. But there was one species of cracked porcelain which he was not to try to hold up to contempt with impunity. The rumour of his intention to bring upon the stage, in the character of Lady Kitty Crocodile in *The Trip to Calais*, the notorious duchess of Kingston, whose trial for bigamy was then (1775) impending, roused his intended victim to the utmost fury; and the means and influence she had at her disposal enabled her, not only to prevail upon the lord chamberlain to prohibit the performance of the piece (in which there is no hint as to the charge of bigamy itself), but to hire agents to vilify Foote's character in every way that hatred and malice could suggest. After he had withdrawn the piece, and letters had been exchanged between the duchess and him equally characteristic of their respective writers, Foote took his revenge upon the chief of the duchess's instruments, a "Reverend Doctor" Jackson, who belonged to the "reptile" society of the journalists of the day, so admirably satirized by Foote in his comedy of *The Bankrupt*. This man he gibbeted in the character of Viper in *The Capuchin*, under which name the altered *Trip to Calais* was performed in 1776. But the resources of his enemies were not yet at an end; and a discharged servant of Foote's was suborned by Jackson to bring a charge of assault and apply for a warrant against him. Though the attempt utterly broke down, and Foote's character was thus completely cleared, his health and spirits had given way in the struggle—as to which, though he seems to have had the firm support of the better part of the public, including such men as Burke and Reynolds, the very audiences of his own theatre had been, or had seemed to be, divided in opinion. He thus resolved to withdraw, at least for a time, from the effects of the storm, let his theatre to Colman, and after making his last appearance there in May 1777, set forth in October on a journey to France. But at Dover he fell sick on the day after his arrival there, and after a few hours died (October 21st). His epitaph in St Mary's church at Dover (written by his faithful treasurer William Jewell) records that he had a hand "open as day for melting charity." His resting-place in Westminster Abbey is without any memorial.

Foote's chief power as an actor lay in his extraordinary gift of mimicry, which extended to the mental and moral, as well as the mere outward and physical peculiarities of the personages whose likeness he assumed. He must have possessed a wonderful flexibility of voice, though his tones are said to have been harsh when his voice was not disguised, and an incomparable readiness for rapidly assuming characters, both in his entertainments and in his comedies, where he occasionally "doubled" parts. The excellent "patter" of some of his plays, such as *The Liar* and *The Cozeners*, must have greatly depended for its effect upon rapidity of delivery. In person he was rather short and stout, and coarse-featured; but his overflowing humour is said to have found full expression in the irresistible sparkle of his eyes.

As a dramatic author he can only be assigned a subordinate rank. He regarded comedy as "an exact representation of the peculiar manners of that people among whom it happens to be performed; a faithful imitation of singular absurdities, particular follies, which are openly produced, as criminals are publicly punished, for the correction of individuals and as an example to the whole community." This he regarded as the *utile*, or useful purpose, of comedy; the *dulce* he conceived to be "the fable, the construction, machinery, conduct, plot, and incidents of the piece." For part at least of this view (advanced by him in the spirited and scholarly "Letter" in which he replied, "to the Reverend Author of the 'Remarks, Critical and Christian,' on *The Minor*"), he rather loftily appealed to classical authority. But he overlooked the indispensableness of the *dulce* to the comic drama under its primary aspect as a species of art. His comic genius was particularly happy in discovering and reproducing characters deserving of ridicule; and the fact that he not only took them from real life, but closely modelled them on well-known living men and women, was not in himself an artistic sin. Nor indeed was the novelty of this process absolute, though probably no other comic dramatist has ever gone so far in this course, or has pursued it so persistently. The public delighted in his "d—d fine originals," because it recognized them as copies; and he was himself proud that he had taken them from real persons, instead of their being "vamped from antiquated plays, pilfered from

the French farces, or the baseless beings of the poet's brain." But the real excellence of many of Foote's comic characters lies in the fact that, besides being incomparably ludicrous types of manners, they remain admirable comic types of general human nature. Sir Gregory Gazette, and his imbecile appetite for news; Lady Pentweazel, and her preposterous vanity in her superannuated charms; Mr Cadwallader, and his view of the advantages of public schools (where children may "make acquaintances that may hereafter be useful to them; for between you and I, as to what they learn there, does not signify twopence"); Major Sturgeon and Jerry Sneak; Sir Thomas Lofty, Sir Luke Limp, Mrs Mechlin, and a score or two of other characters, are excellent comic figures in themselves, whatever their origin; and many of the vices and weaknesses exposed by Foote's vigorous satire will remain the perennial subject of comic treatment so long as a stage exists. The real defect of his plays lies in the abnormal weakness of their construction, in the absolute contempt which the great majority of them show for the invention or conduct of a plot, and in the unwarrantable subordination of the interest of the action to the exhibition of particular characters. His characters are ready-made, and the action is only incidental to them. With the exception of *The Liar* (which Foote pretended to have taken from Lope de Vega, but which was really founded on Steele's adaptation of Corneille's *Le Menteur*), and perhaps of *The Bankrupt*, there is hardly one of Foote's "comedies" in which the conception and conduct of the action rise above the exigencies of the merest farce. Not that sentimental scenes and even sentimental characters are wanting, but these familiar ingredients are as incapable of exciting real interest as an ordinary farcical action is in itself unable to produce more than transitory amusement. In his earlier plays Foote constantly resorts to the most hackneyed device of farce—a disguise. Of course Foote must have been well aware of the shortcomings of his rapidly manufactured productions; he knew that if he might sneer at "genteel comedy" as suited to the dramatists of the servants' hall, and pronounce the arts of the drama at the great houses to be "directed by the genius of insipidity," he, like the little theatre where he held sway, was looked upon as "an eccentric, a mere summer fly."

At the same time, he was inexhaustible in the devising of comic scenes of genuine farce. An oration of "old masters," an election of a suburban mayor, an examination at the College of Physicians, a newspaper conclave where paragraphs are concocted and reputations massacred—all these and other equally happy situations are brought before the mere reader with unflinching vividness. And everywhere the comic dialogue is instinct with spirit and vigour, and the comic characters are true to themselves with a buoyancy which at once raises them above the level of mere theatrical conventionalism. Foote professed to despise the mere caricaturing of national peculiarities as such, and generally used dialect as a mere additional colouring; he was, however, too wide awake to the demands of his public not to treat France and Frenchmen as fair game, and coarsely to appeal to national prejudice. His satire against those everlasting victims of English comedy and farce, the Englishman in Paris and the Englishman returned from Paris, was doubtless well warranted; while at the same time he made fun of the fact that Englishmen are nowhere more addicted to the society of their countrymen than abroad. In general, the purposes of Foote's social satire are excellent, and the abuses against which it is directed are those which it required courage to attack. The tone of his morality is healthy, and his language, though not aiming at refinement, is remarkably free from intentional grossness. He made occasional mistakes; but he was on the right side in the warfare against the pretentiousness of Cant and the effrontery of Vice, the two master evils of the age and the society in which he lived.

The following is a list of Foote's farces or "comedies" as he calls them, mostly in three, some in two acts, which remain in print. The date of production, and the character originally performed by Foote, are added to the title of each:

The Knights (1748: Hartop, who assumes the character of Sir Penurious Trifle); *Taste* (1752), in which part of the *Diversions* is incorporated; *The Englishman in Paris* (1753: Young Buck); *The Englishman returned from Paris* (1756: Sir Charles Buck); *The Author* (1757: Cadwallader); *The Minor* (1760: Smirk and Mrs Cole); *The Liar* (1762); *The Orators* (1762: Lecturer); *The Mayor of Garratt* (1763: Major Sturgeon and Matthew Mug); *The Patron* (1764: Sir Thomas Lofty and Sir Peter Peppercorn); *The Commissary* (1765: Mr Zac. Fungus); *The Devil upon Two Sticks* (1768: Devil,—alias Dr Hercules Hellebore); *The Lame Lover* (1770: Sir Luke Limp); *The Maid of Bath* (1771: Mr Flint); *The Nabob* (1772: Sir Matthew Mite); *The Bankrupt* (1773: Sir Robert Riscounter); *The Cozeners* (1774: Mr Aircastle); *The Capuchin*, a second version of *The Trip to Calais*, forbidden by the censor (1776: O'Donovan). His dramatic works were collected in 1763–1768.

BIBLIOGRAPHY.—Foote's biography may be read in W. ("Conversation") Cooke's *Memoirs of Samuel Foote* (3 vols., 1805), which contain, amidst other matter, a large collection of his good things and of anecdotes concerning him, besides two of his previously unpublished occasional pieces (with the *Tragedy à la mode*, part of the *Diversions*, in which Foote appeared as Fustian). From this source seems to have been mainly taken the biographical information in the rather grandiloquent essay on Foote prefixed by "Jon Bee"

(John Badcock, fl. 1816–1830, also known as “John Hunds”) to his useful edition of Foote's Works (3 vols., 1830). Various particulars will be found in Tate Wilkinson's *Wandering Patentee* (York, 1795) and in other sources. There is an admirable essay on Foote, reprinted with additions, from the *Quarterly Review*, in John Forster's *Biographical Essays* (1858). A recent life of Foote is by Percy Fitzgerald (1910). (A. W. W.)

FOOTMAN, a name given among articles of furniture to a metal stand, usually of polished steel or brass, and either oblong or oval in shape, for keeping plates and dishes hot before a dining-room fire. In the days before the general use of hot-water dishes the footman possessed definite utility, but although it is still in occasional use, it is now chiefly regarded as an ornament. It was especially common in the hardware counties of England, where it is still frequently seen; the simple conventionality of its form is not inelegant.

FOOTSCRAY, a city of Bourke county, Victoria, Australia, on the Saltwater river, 4 m. W. of and suburban to Melbourne. Pop. (1901) 18,301. The city has large bluestone quarries from which most of the building stones in Melbourne and the neighbourhood is obtained; it is also an important manufacturing centre, with numerous sugar-mills, jute factories, soap works, woollen-mills, foundries, chemical works and many other minor industries.

FOOT-STALL, a word supposed to be a literal translation of *pièdestal*, or pedestal, the lower part of a pier in architecture (see **BASE**).

FOPPA, **VINCENZO**, Italian painter, was born near Brescia. The dates of his birth and death used to be given as 1400 and 1492; but there is now good reason for substituting 1427 and 1515. He settled in Pavia towards 1456, and was the head of a Lombard school of painting which subsisted up to the advent of Leonardo da Vinci. In 1489 he returned to Brescia. His contemporary reputation was very considerable, his merit in perspective and foreshortening being recognized especially. Among his noted works are a fresco in the Brera Gallery, Milan, the “Martyrdom of St Sebastian”; and a “Crucifixion” in the Carrara gallery, Bergamo, executed in 1455. He worked much in Milan and in Genoa, but many of his paintings are now lost.

See C. J. Ffoulkes and R. Maiocchi, *Vincenzo Foppa* (1910).

FORAGE, food for cattle or horses, chiefly the provender collected for the food of the horses of an army. In early usage the word was confined to the dried forage as opposed to grass. From this word comes “foray,” an expedition in search of “forage,” and hence a pillaging expedition, a raid. The word “forage,” directly derived from the Fr. *fouirage*, comes from a common Teutonic origin, and appears in “fodder,” food for cattle. The ultimate Indo-European root, *pat*, cf. Gr. *παρέσθαι*, Lat. *pascere*, to feed, gives “food,” “feed,” “foster”; and appears also in such Latin derivatives as “pastor,” “pasture.”

FORAIN, **J. L.** (1852–), French painter and illustrator, was born in 1852. He became one of the leading modern Parisian caricaturists, who in his merciless exposure of the weaknesses of the *bourgeoisie* continued the work which was begun by Daumier under the second Empire. The scathing bitterness of his satire is as clearly derived from Daumier as his pictorial style can be traced to Manet and Degas; but even in his painting he never suppresses the caustic spirit that drives him to caricature. He has, indeed, been rightly called “a Degas pushed on to caricature.” In his pen-and-ink work he combines extraordinary economy of means with the utmost power of expression and suggestion. Forain's popularity dates from the publication of his *Comédie parisienne*, a series of two hundred and fifty sketches republished in book form. He has contributed many admirable, if sometimes over-daring, pages to the *Figaro*, *Le Rire*, *L'Assiette au beurre*, *Le Courrier français*, and *L'In-discret*. His political drawings for the *Figaro* were republished in book form under the title of *Doux Pays*.

FORAKER, **JOSEPH BENSON** (1846–), American political leader, was born near Rainsboro, Highland county, Ohio, on the 5th of July 1846. He passed his early life on a farm, enlisted as a private in the 89th Ohio Volunteer Infantry in July 1862, served throughout the Civil War, for part of the

time as an aide on the staff of General H. W. Slocum, and in 1865 received a captain's brevet for “efficient services during the campaigns in North Carolina and Georgia.” After the war he spent two years at the Ohio Wesleyan University and two years at Cornell. In 1869 he was admitted to the Ohio bar and began practice in Cincinnati. He was a judge of the Cincinnati Superior Court from 1879 to 1882. In 1883 he was the Republican candidate for governor of Ohio, but was defeated; in 1885 and 1887, however, he was elected, but was again defeated in 1889. He then for eight years practised law with great success in Cincinnati. In 1896 he was elected United States senator to succeed Calvin S. Brice (1845–1898); in 1902 was re-elected and served until 1909. In the Senate he was one of the aggressive Republican leaders, strongly supporting the administration of President McKinley (whose name he presented to the Republican National Conventions of 1896 and 1900) in the debates preceding, during, and immediately following the Spanish-American War, and later, during the administration of President Roosevelt, was conspicuous among Republican leaders for his independence. He vigorously opposed various measures advocated by the president, and led the opposition to the president's summary discharge of certain negro troops after the Brownsville raid of the 13th of August 1906 (see **BROWNSVILLE**, Texas).

FORAMINIFERA, in zoology, a subdivision of Protozoa, the name selected for this enormous class being that given by A. D'Orbigny in 1826 to the shells characteristic of the majority of the species. He regarded them as minute Cephalopods, whose chambers communicated by pores (foramina). Later on their true nature was discovered by F. Dujardin, working on living forms, and he referred them to his Rhizopoda, characterized by pseudopodia given off from the sarcode (protoplasm) as organs of prehension and locomotion. W. B. Carpenter in 1862 differentiated the group nearly in its present limits as “Reticularia”; and since then it has been rendered more natural by the removal of a number of simple forms (mostly freshwater) with branching but not reticulate pseudopods, to Filosa, a distinct subclass, now united with Lobosa into the restricted class of Rhizopoda.

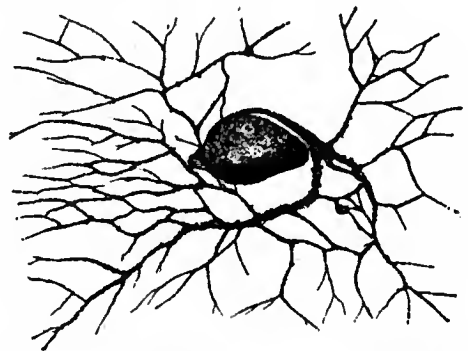

FIG. 1A.—*Lieberkühnia*, with reticulate pseudopodia.

Anatomy.—Protista Sarcodina, with simple protoplasmic bodies of granular surface, emitting processes which branch and anastomose freely, either from the whole surface or from one or more elongated processes (“stylopods”); nucleus one or more (not yet demonstrated in some little known simple forms), usually in genetic relation to granules or strands of matter of similar composition, the “chromidia” scattered through the protoplasm; body naked, or provided with a permanent investment (shell or test), membranous, gelatinous, arenaceous (of compacted or cemented granules), calcareous, or very rarely (in deep sea forms) siliceous, sometimes freely perforated, but never latticed; opening by one or more permanent apertures (“pylomes”) or crevices between compacted sand-granules, often very complex; reproduction by fission (only in simplest naked forms), or by brood formation; in the latter case one mode of brood formation (A) eventuates in amoebiform embryos, the other (B) in flagellate zoospores which are exogamous

gametes, pairing but not with those of their own brood; the coupled cell ("zygote") when mature in the shelled species gives rise to a very small primitive test-chamber or "microsphere." The adult microspheric animal gives rise to the amoebiform brood which have a larger primitive test ("megalosphere"); and megalospheric forms appear to reproduce by the A type a series of similar forms before a B brood of gametes is finally borne, to pair and reproduce the microspheric type, which is consequently rare.

The shells require special study. In the lowest forms they are membranous, sometimes encrusted with sand-grains, always very simple, the only complication being the doubling of the pylome in *Diplophrys* (fig. 2, 1), *Shepherdella* (fig. 2, 3-5), *Amphitrema* (fig. 2, 11), *Diaphorophodon* (fig. 2, 12). The marine shells are, as we have seen, of cemented particles, or calcareous, glassy, and regularly perforated, or again calcareous, but porcellanous and rarely perforate. These characters have been used

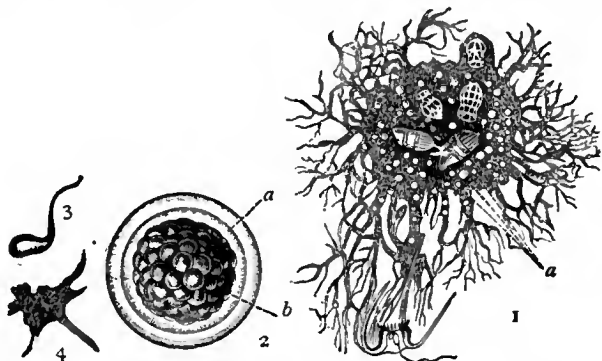

FIG. 1B.—*Protomyxa aurantiaca*, Haeck. (After Haeckel.)

- 1, Adult, containing two diatom frustules, and three Tintinnid ciliates, with a large Dinoflagellate just caught by the expanded reticulate pseudopodia.
- 2, Adult encysted and segmented.
- 3, Flagellate zoospore just freed from cyst.
- 4, Zoospore which has passed into the amoeboid state.

as a guide to classification; but some sandy forms have so large a proportion of calcareous cement that they might well be called encrusted calcareous genera, and are also not very constant in respect of the character of perforation. The porcellanous genera, however, form a compact group, the replacement of the shell by silica in forms dwelling in the red clay of the ocean abysses, where calcium carbonate is soluble, not really making any difficulty. Moreover, the shells of this group show a deflected process or neck of the embryonic chamber ("camptopyle") at least in the megalospheric forms, whereas when such a neck exists in other groups it is straight. The opening of the shell is called the pylome. This may be a mere hole where the lateral walls of the body end, or there may be a diaphragmatic ingrowth so as to narrow the entrance. It may be a simple rounded opening, oblong or tri-multi-radiate, or branching (fig. 4, 1); or replaced by a number of coarse pores ("ethmopyle") (fig. 3, 5a). Again, it may lie at the end of a narrowed tube ("stylopyle"), which in *Lagena* (fig. 3, 9) may project outwards ("ectoselenial"), or inwards ("entoselenial"). In most groups the stylopyle is straight; but in the majority of the porcellanous shells it is bent down on the side of the shell, and constitutes the "flexopyle" of A. Kemna, which being a hybrid term should be replaced by "camptopyle." The animal usually forms a simple shell only after it has attained a certain size, and this "embryonic chamber" cannot grow further. In *Spirillina* and *Ammodiscus* there is no pylomic end-wall, and the shell continues to grow as a spiral tube; in *Cornuspira* (fig. 3, 1) there is a slight constriction indicating the junction of a small embryonic chamber with a camptopyle, but the rest of the shell is a simple flat spiral of several turns. In the majority at least one chamber follows the first, with its own pylome at the distal end. This second chamber may rest on the first, so that the part on which it rests serves as a party-wall bounding the front of

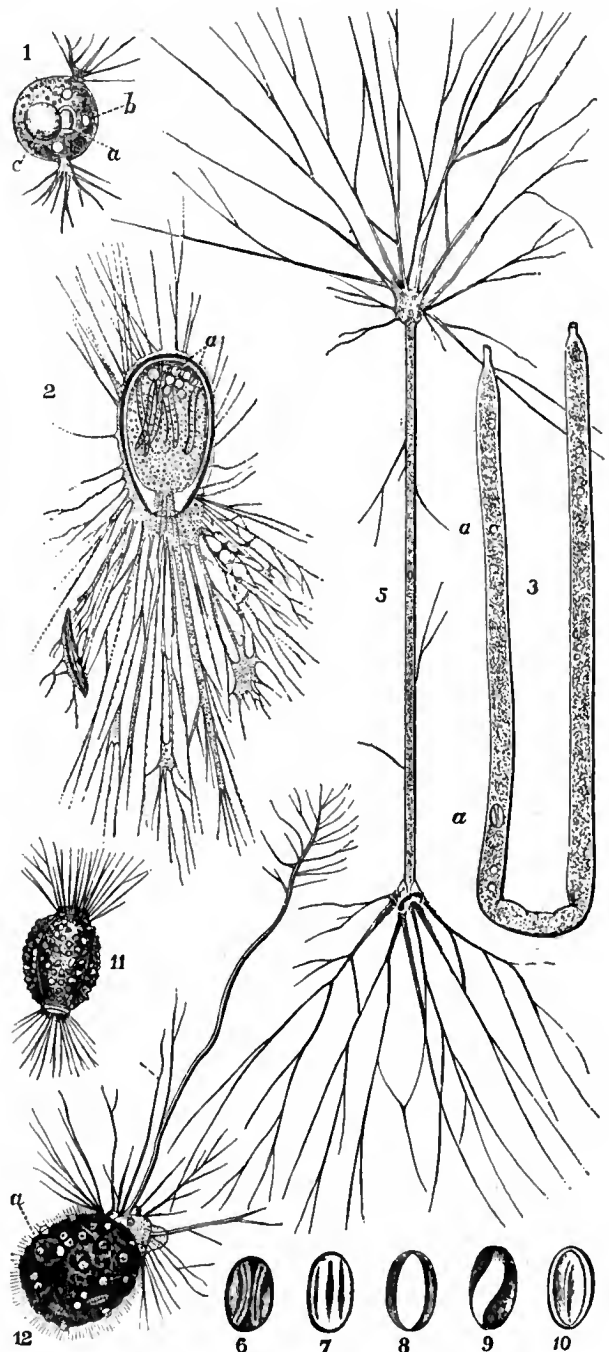

FIG. 2.—*Allogromiidea*.

- 1, *Diplophrys archeri*, Barker. Marine. The protoplasm is retracted at both ends into the tubular case.
 - a, Nucleus.
 - b, Contractile vacuoles.
 - c, The yellow oil-like body.
- 2, *Allogromia oviformis*, Duj. Moor pools, Ireland.
 - a, The numerous nuclei; near these the elongated bodies represent ingested diatoms.
- 3, *Shepherdella taeniiformis*, Siddall (*Quart. Jour. Micr. Sci.*, 1880); $\times 30$ diameters. Freshwater. Figs. 2, 3, 11, 12 belong to Rhizopoda Filosa, and are included here to show the characteristic filose pseudopodia in contrast with the reticulate spread of the others.
- 4, *Amphitrema wrightianum*, Archer, showing membranous shell encrusted with foreign particles. Moor pools, Ireland.
- 5, *Shepherdella taeniiformis*; $\times 15$; with pseudopodia fully expanded.
- 6-10, Varying appearance of the nucleus as it is carried along in the streaming protoplasm within the tube.
- 11, *Amphitrema wrightianum*, Archer, showing membranous shell encrusted with foreign particles. Moor pools, Ireland.
- 12, *Diaphorophodon mobile*, Archer. Moor pools, Ireland.
 - a, Nucleus.

the newer chamber as well as the back of the older; and this state prevails for all added chambers in such cases. In the

highest vitreous shells, however, each chamber has its complete "proper wall"; while a "supplementary skeleton," a deposit of shelly matter, binds the chambers together into a compact whole. In all cases the protoplasm from the pylome may deposit additional matter on the outside of the shell, so as to produce very characteristic sculpturing of the surface.

Compound or "polythalamic" shells derive their general form largely from the relations of successive chambers in size, shape and direction. This is well shown in the porcellanous *Miliolidae*. If we call the straight line uniting the two ends of a chamber the "polar axis," we find that successive chambers

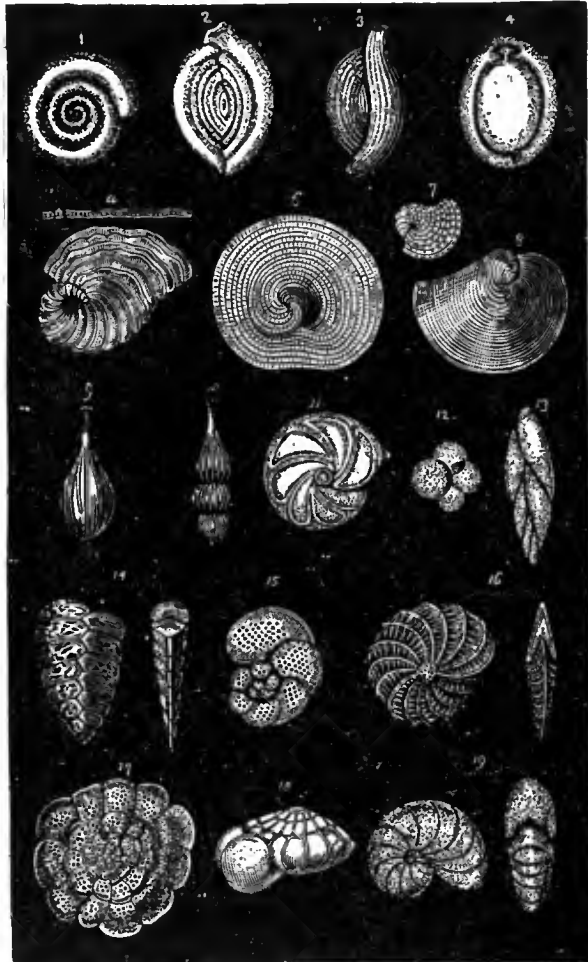

FIG. 3.—Various forms of Calcareous Foraminifera.

- | | | |
|----------------------------------|--------------------------------|---------------------------|
| 1, <i>Cornuspira</i> . | 8, <i>Orbiculina</i> (spiral). | 14, <i>Textularia</i> . |
| 2, <i>Spiroloculina</i> . | 9, <i>Lagena</i> . | 15, <i>Discorbina</i> . |
| 3, <i>Triloculina</i> . | 10, <i>Nodosaria</i> . | 16, <i>Polystomella</i> . |
| 4, <i>Biloculina</i> . | 11, <i>Cristellaria</i> . | 17, <i>Planorbulina</i> . |
| 5, <i>Peneroplis</i> . | 12, <i>Globigerina</i> . | 18, <i>Rotalia</i> . |
| 6, <i>Orbiculina</i> (cyclical). | 13, <i>Polymorphina</i> . | 19, <i>Nonionina</i> . |
| 7, <i>Orbiculina</i> (young). | | |

have their pylomes at alternate poles; but they lie on different meridians. In *Spiroloculina* (fig. 3, 2) the divergence between the meridians is 180° , and the chambers are strongly incurved, so that the whole shell forms a flat spiral, of nearly circular outline. In the majority, however, the chambers are crescentic in section, their transverse prolongations being termed "alary" outgrowths, so that successive chambers overlap; when under this condition the angle of successive meridians is still 180° we have the form *Biloculina* (fig. 3, 4), or with the alary extensions completely enveloping, *Uniloculina*; when the angle is 120° we have *Triloculina*, or 144° , *Quinqueloculina*. Again in *Peneroplis* (figs. 3, 5, and 4) the shell begins as a flattened shell which tends to straighten out with further growth and additional chambers. In some forms (*Spirolina*, fig. 22, 3) the chambers have a nearly circular transverse section, and the adult shell is

thus crozier-shaped. In others (which may have the same sculpture, and are scarcely distinguishable as species) the chambers are short and wide, drawn out at right angles to the axis, but in the plane of the spiral, and the growing shell becomes fan-shaped or "flabelliform" (figs. 3, 5, 4, 2).

This widening may go on till the outer chambers form the greater part of a circle, as in *Orbiculina* (fig. 3, 6-8) where, moreover, each large chamber is subdivided by incomplete vertical bulkheads into a tier of chamberlets; each chamberlet has a distinct pylomic pore opening to the outside or to those of the next outer zone. In *Orbitolites* (figs. 5, 6) we have a centre on a somewhat Milioline type; and after a few chambers in spiral

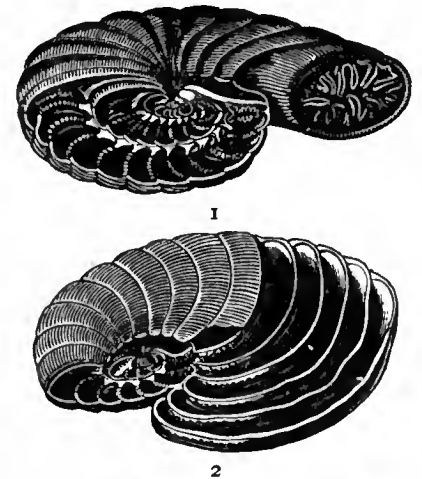

FIG. 4.—Modifications of *Peneroplis*.
1, *Dendritina*; 2, *Eu-Peneroplis*.

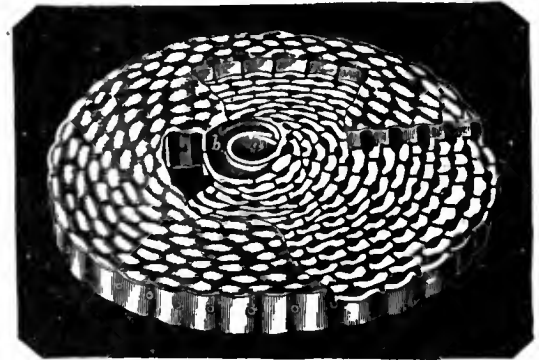

FIG. 5.—Shell of simple type of *Orbitolites*, showing primordial chamber *a*, and circumambient chamber *b*, surrounded by successive rings of chamberlets connected by circular galleries which open at the margin by pores.

succession, complete circles of chambers are formed. In the larger forms the new zones are of greater height, and horizontal bulkheads divide the chamberlets into vertical tiers, each with its own pylomic pore.

The *Cheilostomelidae* (fig. 3, 13) reproduce among perforate vitreous genera what we have already seen in the *Miliolida*: *Orbitoides* (fig. 10, 2) and *Cycloclypeus*, among the Nummulite group, with a very finely perforate wall, recall the porcellanous *Orbiculina* and *Orbitolites*.

In flat spiral forms (figs. 22, 1, 7; 3, 2, 16, 19, &c.) all the chambers may be freely exposed; or the successive chambers be wider transversely than their predecessors

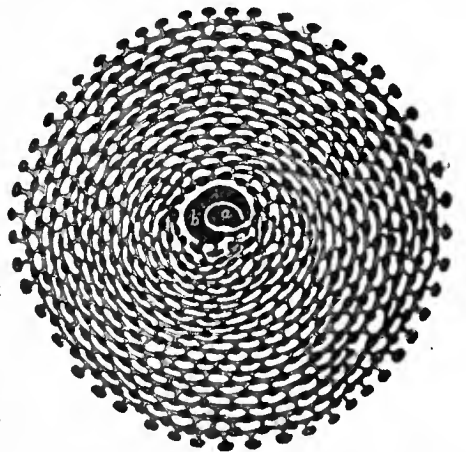

FIG. 6.—Animal of simple type of *Orbitolites*, showing primordial segment *a*, and circumambient segment *b*, surrounded by annuli of sub-segments connected by radial and circular stolon-processes.

and overlap by "alary extensions," becoming "nautiloid"; in

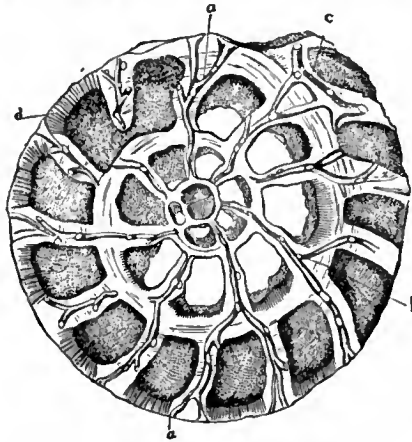

FIG. 7.—Section of *Rotalia beccarii*, showing the canal system, *a, b, c*, in the substance of the intermediate skeleton; *d*, tubulated chamber-wall.

extreme cases only the last turn or whorl is seen (fig. 11). When the spiral axis is conical the shell may be "rotaloid," the larger lower chambers partially concealing the upper smaller ones (fig. 3, 12, 15, 17, 18); or they may leave, as in *Patellina*, a wide central conical cavity—which, in this genus, is finally occupied by later formed "supplementary" chambers. When the successive chambers are disposed around a longitudinal central axis they may be said to "alternate" like the leaves of a plant. If the arrangement

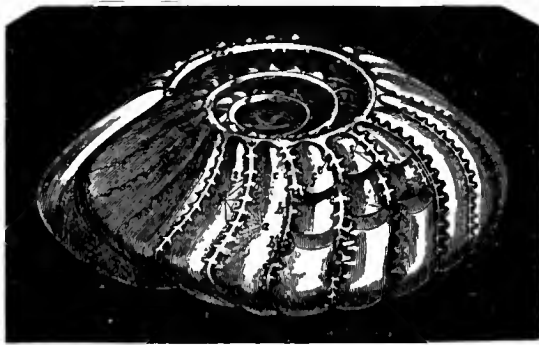

FIG. 8.—Internal cast of *Polystomella craticulata*.

a, Retral processes, proceeding from the posterior margin of one of the segments. *b, b'*, Smooth anterior margin of the same segment. *c, c'*, Stolons connecting successive segments and uniting themselves with the distichous we get such forms as *Polymorphina*, *Textularia* and *Fronicularia* (fig. 3, 13, 14), if tristichous, *Tritaxia*. Such

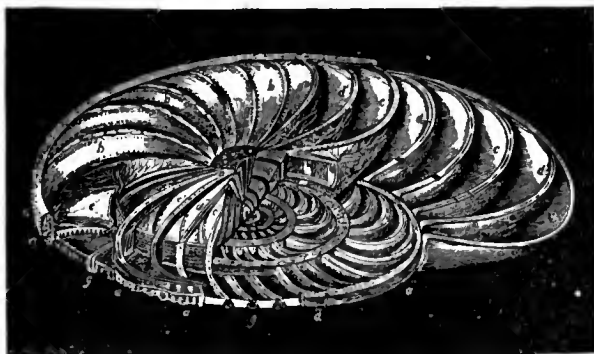

FIG. 9.—*Operculina* laid open, to show its internal structure.

a, Marginal cord seen in cross section at *a'*. [*a*, *a'*, Chambers. *b, b*, External walls of the *c, c*, Cavities of the chambers. *c', c'*, Their alary prolongations. *d, d*, Septa divided at *d', d'*, and at *d''*, so as to lay open the *d', d'*, Secondary pores. *e, e*, Non-tubular columns. *f, f*, Interseptal canals, the general distribution of which is seen in the septa *e, e*; the lines radiating from *e, e* point to the secondary pores. *g, g*, Marginal cord seen in cross section at *a'*. [*a*, *a'*, Chambers. *b, b*, External walls of the *c, c*, Cavities of the chambers. *c', c'*, Their alary prolongations. *d, d*, Septa divided at *d', d'*, and at *d''*, so as to lay open the *d', d'*, Secondary pores. *e, e*, Non-tubular columns. *f, f*, Interseptal canals, the general distribution of which is seen in the septa *e, e*; the lines radiating from *e, e* point to the secondary pores. *g, g*, Marginal cord seen in cross section at *a'*.]

Two phenomena interfere with the ready availability of the characters of form for classificatory ends—dimorphism and multiformity.

Dimorphism.—The majority of foraminiferal shells show two types, the rarer with a much smaller central chamber than that of the more frequent. The chambers are called microsphaere

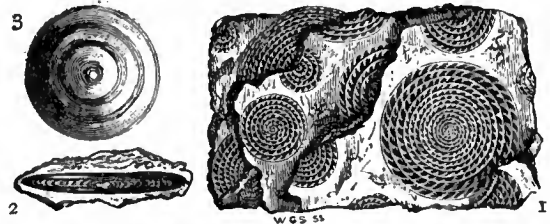

FIG. 10.—1, Piece of Nummulitic Limestone from the Pyrenees, showing Nummulites laid open by fracture through the median plane; 2, vertical section of Nummulite; 3, *Orbitoides*.

and megalosphere, the forms in which they occur microsphaeric and megalosphaeric forms, respectively. We shall study below their relation to the reproductive cycle.

Multiformity.—Many of the Polythalamia show different types of chamber-succession at different ages. We have noted

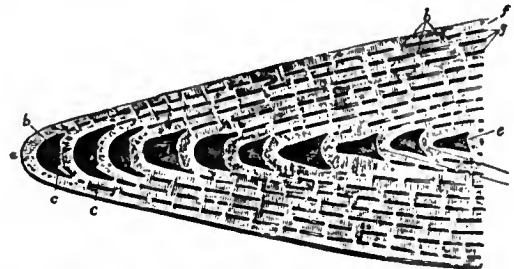
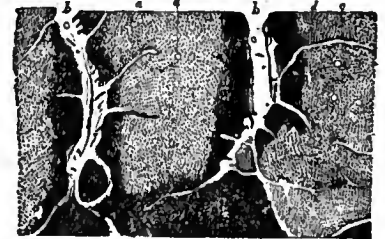

FIG. 11.—Vertical section of portion of *Nummulites*, showing the investment of the earlier whorls by the alar prolongations of the later.

a, Marginal cord. *b*, Chamber of outer whorl. *c, c*, Whorl invested by *a*. *d*, One of the chambers of the fourth whorl from the margin. [*c*, *c*, closed whorls. *e, e'*, Marginal portions of the en- *f*, Investing portion of the outer whorl. *g, g*, Spaces left between the investing portions of successive whorls. *h, h*, Sections of the partitions dividing these.

this phenomenon in such crozier forms as *Peneroplis*, as well as in discoid forms; it is very frequent. Thus the microspheric *Biloculina* form the first few chambers in quinqueloculine succession. The microspheric forms attain to a greater size when adult than the megalosphaeric; and in *Orbitolites* the microsphaere has a straight outlet, orthostyle, instead of the deflected camptostyle one, so general in porcellanous types; and the spiral succession is continued for more turns before reaching the fan-shaped and finally cyclic stage. *Globigerina*, whose chambers are nearly spherical, is sometimes seen to be enclosed in a spherical test, showing the orifices of its minute perforate, but without a tubuli.



b, b, The septa containing canals. *c, c*, Extensions of these canals in the intermediate skeleton. *d, d*, Larger pores.

attached at first inside the wall of the *Orbulina*, but ultimately disappears. The ultimate fate of the *Orbulina* shell is unknown; but it obviously marks a turning-point in the life-cycle.

Protoplasmic Body and Reproduction.—The protoplasm is not differentiated into ecto- and endosarc, although it is often denser

in the central part within the shell, and clearer in the pseudopodial ramifications and the layer (or stalk in the monothalamic forms) from which it is given off. In pelagic forms like *Globigerina* the external layer is almost if not quite identical in structure with the extracapsular protoplasm of Radiolaria (*q.v.*), being differentiated into granular strands traversing a clear jelly, rich in large vacuoles (alveoli), and uniting outside the jelly to form the basal layer of the pseudopods; these again are radiolarian in character. Even E. R. Lankester justly enough compares the shell here to the central capsule of the Radiolarian, though the comparison must not be pushed too far. The cytoplasm contains granules of various kinds, and the internal protoplasm is sometimes pigmented. The Chrysomonad Flagellate, *Zooxanthella*, so abundant in its resting state—the so-called "yellow cells"—in the extracapsular protoplasm of Radiolaria (*q.v.*) also occurs in the outer protoplasm of many Foraminifera, not only pelagic but also bottom-dwellers, such as *Orbitolites*.

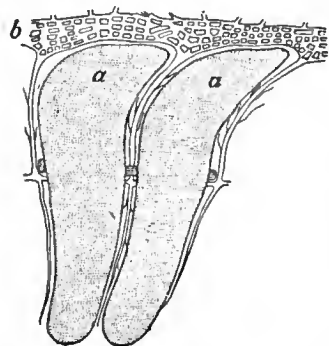

FIG. 13.—Internal cast of two chambers, *a, a*, of *Nummulites*, the radial canals between them passing into *b*, marginal plexus.

The nucleus is single in the Nuda and Allogromiada and in the megalospheric forms of higher Foraminifera; but microspheric forms when adult contain many simple similar nuclei. The nucleus in every case gives off granules and irregular masses ("chromidia") of similar reactions, which play an important part in reproduction. During the maturation of the microsphere the nuclei disappear; and the cytoplasm breaks up into a large number of zoospores, each of which is soon provided with a single nucleus, whether entirely derived from the parent-nucleus or from the coalescence of chromidia, or from both these sources is still uncertain. These zoospores are amoeboid; they soon secrete a shell and reveal themselves as megalospheres, the original state of the megalospheric forms. In the adult megalosphere the solitary nucleus disappears and is replaced by hosts of minute vesicular nuclei, formed by the concentration of chromidia. Each nucleus aggregates around it a proper zone of dense protoplasm; by two successive mitotic divisions each mass becomes quadri-nucleate, and splits up into four biflagellate, uninucleate zoospores. These are pairing-cells or gametes, though they will not pair with members of the same brood. In the zygote resulting from pairing two nuclei soon fuse into one; but this again divides into two; an embryonic shell is secreted, and this is the microspheric type, which is multinuclear from the first. F. Schaudinn compares the nuclei of the adult Foraminifera with the (vegetative) meganucleus of Infusora (*q.v.*) and the chromidial mass with the micronucleus, whose chief function is reproductive.

Since megalospheric forms are by far the most abundant, it seems probable that under most conditions they also give rise to megalospheric young like themselves; and that the production of zoospores,

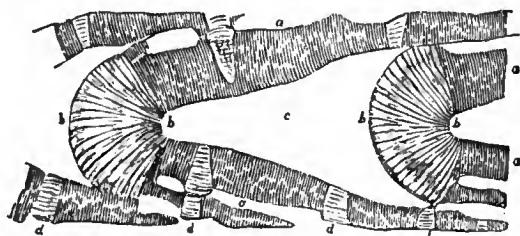

FIG. 14.—Vertical section of tubulated chamber-walls, *a, a*, of *Nummulites*. *b, b*, Marginal cord; *c*, cavity of chamber; *d, d*, non-tubulated columns.

pairing to pass into the microspheric form, is only occasional, and possibly seasonal. This life-history we owe to the researches of Schaudinn and J. J. Lister.

In several species (notably *Patellina*) plastogamy, the union of the cytoplasmic bodies without nuclear fusion, has been noted, as a prelude to the resolution of the conjoined protoplasm into uninucleate amoebulae.

Calcituba, a porcellanous type, which after forming the embryonic chamber with its deflected pylome grows into branching stems, may fall apart into sections, or the protoplasm may escape and break up into small amoebulae. Of the reproduction of the simplest forms we know little. In *Mikrogromia* the cell undergoes fission within the test, and on its completion the daughter-cells may emerge as biflagellate zoospores.

The sandy shells are a very interesting series. In *Astrorhiza* the sand grains are loosely agglutinated, without mineral cement; they leave numerous pores for the exit of the protoplasm, and there are no true pylomes. In other forms the union of the grains by a calcareous or ferruginous cement necessitates the existence of distinct pylomes. Many of the species reproduce the varieties of form found in calcareous tests; some are finely perforated, others not. Many of the larger ones have their walls thickened internally and traversed by complex passages; this structure is called *laby-*

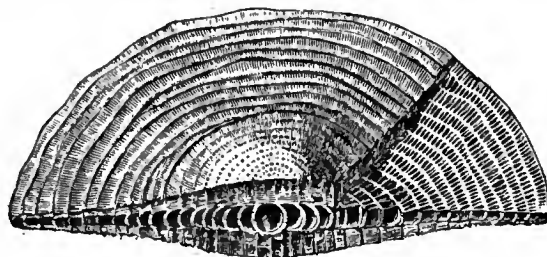

FIG. 15.—*Cycloclypeus*.

rinthic (fig. 19, *g, h*). The shell of *Endothyra*, a form only known to us by its abundance in Carboniferous and Triassic strata, is largely composed of calcite and is sometimes perforated.

It is noteworthy that though of similar habitat each species selects its own size or sort of sand, some utilizing the siliceous spicules of sponges. Despite the roughness of the materials, they are often so laid as to yield a perfectly smooth inner wall; and sometimes the outer wall may be as simple. As we can find no record of a deflected stylopyle to the primitive chamber of the polythalamous Arenacea, it is safe to conclude that they have no close alliance with the Porcellanea.

Classification.

- I. NUDA.—Protoplasmic body without any pellicle or shell save in the resting encysted condition, sometimes forming colonial aggregates by coalescence of pseudopods (*Myxodictyum*), or even plasmodia (*Protomyxa*). Brood cells at first uniflagellate or amoeboid from birth. Fresh-water and marine genera *Protogenes* (Haeckel), *Biomyxa* (Leidy), *Myxodictyum* (Haeckel), *Protomyxa* (Haeckel) (fig. 1B).

This group of very simple forms includes many of Haeckel's Monera, defined as "cytodes," masses of protoplasm without a nucleus. A nucleus (or nuclei) has, however, been demonstrated by improved methods of staining in so many that it is probable that this distinction will fall to the ground.

- II. ALLOGROMIDIACEAE (figs. 1A, 2).—Protoplasmic body protected in adult state by an imperforate test with one or two openings (pylomes) for the exit of the stylopod; test simple, gelatinous, membranous, sometimes incrustated with foreign bodies, never calcareous nor arenaceous; reproduction by fission alone known. Fresh-water or marine genera *Allogromia* (Rumb.), *Myxotheca* (Schaud.), *Lieberkühnia* (Cl. & L.) (fig. 1A), *Shepherdella* (Siddall) (fig. 2, 3-10), *Diplophrys* (Barker), *Amphitrema* (Arch.) (fig. 2, 11), *Diaphrophodon* (Arch.) (fig. 2, 12), are possibly Filosa. This group differs from the preceding in its simple test, but, like it, includes many fresh-water species, which possess contractile vacuoles.



FIG. 16.—*Heterostegina*.

- III. ASTRORHIZIDIACEAE.—Simple forms, rarely polythalamous (some *Rhabdamminidae*), but often branching or radiate; test arenaceous, loosely compacted and traversed by chinks for pseudopodia (*Astrorhizidae*), or dense, and opening by one or more terminal pylomes at ends of branches. Marine, 4 Fam. The test of some *Astrorhizidae* is so loose that it falls to pieces when taken out of water. *Haliphysema* is remarkable for its history in relation to the "gastraca theory." *Pilulina* has a neat globular shell of sponge-spicules and fine sand. Genera, *Astrorhiza* (Sandahl)

- (fig. 22), *Pitulina* (Carptr.) (fig. 19), *Saccamina* (Sars) (fig. 19), *Rhabdammina* (Sars), *Botellina* (Carptr.), *Hali-physema* (Bowerbank) (fig. 22).
- IV. LITUOLIDACEAE.—Shell arenaceous, usually fine-grained, definite and often polythalamic, recalling in structure calcareous forms. *Lituola* (Lamk.) (fig. 19), *Endothyra* (Phil.), *Anmodiscus* (Reuss), *Loflusia* (Brady), *Haplophragmium* (Reuss) (fig. 22), *Thuramina* (Brady) (fig. 22).
- V. MILIOLIDACEAE.—Shells porcellaneous imperforate, almost invariably with a camptostyle leading from the embryonic

VIII. LAGENIDACEAE.—Shells vitreous, often sculptured, mono- or polythalamic, finely perforate; chambers flask-shaped, with a protruding or an inturred stylopyle; *Lagena* (Walker & Boys) (fig. 4, 9); *Nodosaria* (Lamk.) (figs. 23, 4; 4, 10); *Polymorphina* (d'Orb.) (fig. 4, 13); *Cristellaria* (Lamk.) (fig. 4, 11); *Fronicularia* (Def.) (fig. 23, 3).

IX. GLOBIGERINIDACEAE.—Shells vitreous, coarsely perforated; chambers few spheroidal rapidly increasing in size; arranged in a trochoid or nautiloid spiral. *Globigerina* (Lamk.) (23, 6; 4, 12); *Hastigerina* (Wyville Thompson) (fig. 23, 5); *Orbulina* (d'Orb.) (fig. 23, 8).

X. ROTALIDACEAE.—Shells vitreous, finely perforate; walls thick, often double, but without an intermediate party-layer traversed by canals; form usually spiral or trochoid. *Discorbina* (Parker & Jones) (fig. 4, 15); *Planorbulina* (d'Orb.) (fig. 4, 17); *Rotalia* (Lamk.) (figs. 23, 1, 2; 7, 21); *Calcarina* (d'Orb.) (fig. 23, 10); *Polytrema* (Risso) (fig. 23, 9).

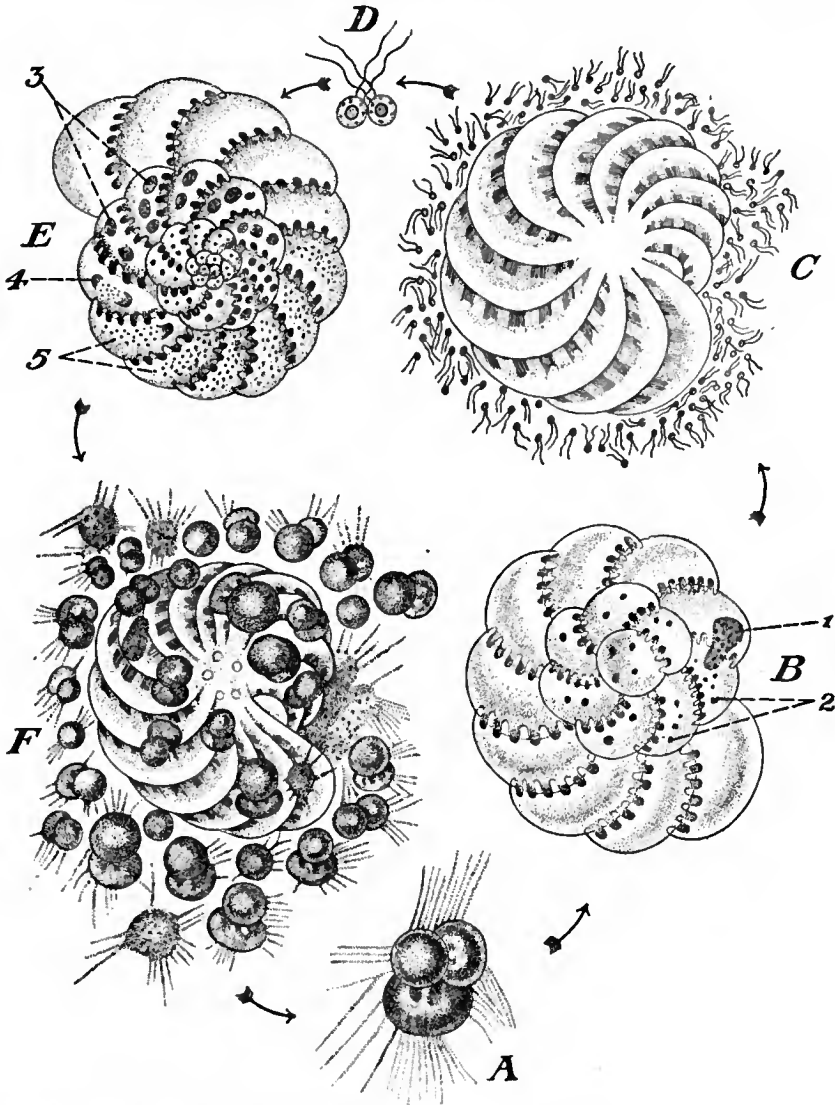

Modified from F. Schaudinn, in Lang's *Zoologie*.

FIG. 17.—Life Cycle of *Polystomella crispa*.

- A, Young megalospheric individual. podiospores which are growing into new megalospheric individuals.
- B, Adult decalcified.
- C, Later stage, resolving itself into two flagellate gametes. 1, Principal nucleus, and 2, subsidiary nuclei of megalospheric form.
- D, Conjugation. [zygote. 3, Nuclei.
- E, Microspheric individual produced from 4, Nuclei in multiple division.
- F, The same resolved itself into pseudo- 5, Chromidia derived from 4.

chamber; *Cornuspira* (Schultze) (fig. 3); *Miliola* (Lamk.), including as subgenera *Spiroloculina* (d'Orb.) (figs. 3 and 22); *Triloculina* (d'Orb.) (fig. 3); *Biloculina* (d'Orb.) (fig. 3); *Uniloculina* (d'Orb.); *Quinqueloculina* (d'Orb.); *Peneroplis* (Montfort) (figs. 22, 3; 3), with form *Dendritina* (fig. 4, 1); *Orbiculina* (Lamk.) (fig. 3, 6-8); *Orbitolites* (Lamk.) (figs. 5, 6); *Vertebralina* (d'Orb.) (fig. 22); *Squamulina* (Sch.) (fig. 22); *Calcituba* (Schaudinn).

VI. TEXTULARIADACEAE.—Shells perforate, vitreous or (in the larger forms) arenaceous, in two or three alternating ranks (distichous or tristichous). *Textularia* (DeFrance) (fig. 21).

VII. CHEILOSTOMELLACEAE.—Shells vitreous, thin, the chambers doubling forwards and backwards as in *Miliolidae*. *Cheilostomella* (Reuss).

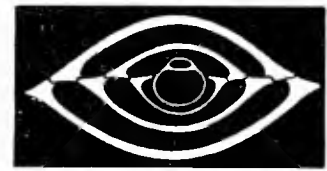

a

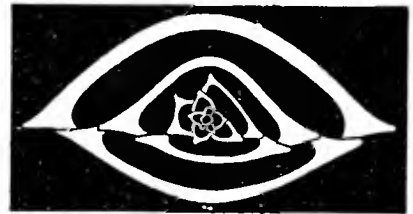

b

FIG. 18.—*Biloculina depressa* d'Orb., transverse sections showing dimorphism. (From Lister.) a, Megalospheric shell $\times 50$, showing uniform growth, biloculine throughout. b, Microspheric shell $\times 90$, showing multiform growth, quinqueloculine at first, and then multiform.

XI. NUMMULINIDACEAE.—As in Rotalidaceae, but with a thicker finely perforated shell, often well developed, and a supplementary skeleton traversed by branching canals as an additional party-wall between the proper chamber-walls. *Nonionina* (d'Orb.) (fig. 4, 19); *Fusulina* (Fischer) (fig. 20); *Polystomella* (Lamk.) (figs. 4, 16; 8); *Operculina* (d'Orb.) (fig. 9); *Heterostegina* (d'Orb.) (fig. 23, 16); *Cycloclypeus* (Carptr.) (fig. 15); *Nummulites* (Lamk.) (figs. 10, 11, 12, 13, 14).

"*Eozoon canadense*," described as a species of this order by J. W. Dawson and Carpenter, has been pronounced by a series of enquirers, most of whom started with a belief in its organic structure, to be merely a complex mineral concretion in opihcalcite, a rock composed of an admixture of silicates (mostly serpentine and pyroxene) and calcite.

Distribution in Vertical Space.—Owing to their lack of organs for active locomotion the Foraminifera are all crawling or attached, with the exception of a few genera (very rich in species, however) which float near the surface of the ocean, constituting part of the pelagic plankton (*q.v.*). Thus the majority are littoral or deep-sea, sometimes attached to other bodies or even burrowing in the tests of other Foraminifera; most of the fresh-water forms are sapropelic, inhabiting the layer of organic

débris at the surface of the bottom mud ditches of pools, ponds and lakes. The deep-sea species below a certain depth cannot possess a calcareous shell, for this would be dissolved; and it is in these that we find limesalts sometimes replaced by silica.

The pelagic floating genera are also specially modified. Their shell is either thin or extended many times by long slender tapering spines, and the protoplasm outside has the same character as that of the Radiolaria (*q.v.*), being differentiated into jelly containing enormous vacuoles and traversed by reticulate strands of granular protoplasm. These coalesce into a peripheral zone from which protrude the pseudo-

in glauconite (a green ferrous silicate, whose composition has not yet been accurately determined) are, however, frequently left. Glauconitic casts of perforate shells, notably *Globigerina*, have been found in Lower Cambrian (e.g. Hollybush Sandstone), and the shells themselves in Siberian limestones of that age. It is only when we pass into the Silurian Wenlock limestone that sandy shells make their appearance. Above this horizon Foraminifera are more abundant as constituents, partial or principal of calcareous rocks, the genus *Endothyra* being indeed almost confined to Carboniferous beds. The genus *Fusulina* (fig. 20) and *Saccamina* (fig. 19) give their names (from their

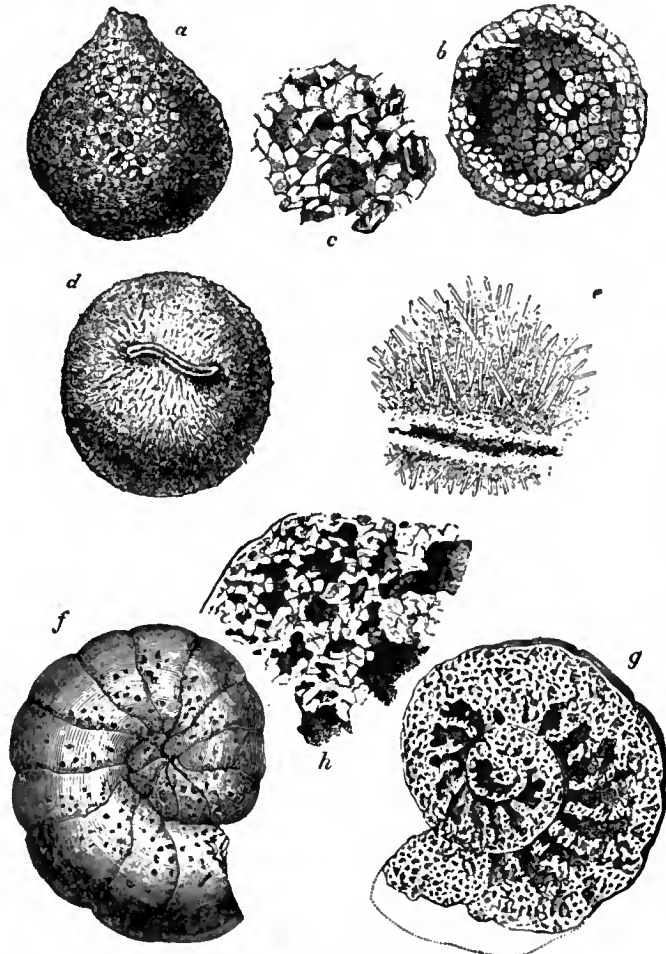

FIG. 19.—Arenaceous Foraminifera.

- a, Exterior of *Saccamina*. f, Nautiloid *Lituola*, exterior.
 b, The same laid open. g, Chambered interior.
 c, Portion of test more highly magnified. h, Portion of labyrinthine chamber wall, showing component sand-grains.
 d, *Pilulina*. [magnified].
 e, Portion of test more highly magnified.

Pods, here rather radiate than reticulate. Most genera and most species are cosmopolitan; but local differences are often marked. Foraminifera abound in the shore sands and the crevices of coral reefs. The membranous shelled forms decay without leaving traces. The sandy or calcareous shells of dead Foraminifera constitute a large proportion of littoral sand, both below and above tide marks; and, as shown in the boring on Funafuti, enter largely into the constituents of coral rock. They may accumulate in the mud of the bottom to constitute Foraminiferal ooze. The source of these shells in the latter case is double: (1) shells of bottom-dwellers accumulate on the spot; (2) shells of dead plankton forms sink down in a continuous shower, to form a layer at the bottom of the ocean, during which process the spines are dissolved by the sea-water. Thus is formed an ooze known as "*Globigerina*-ooze," being formed largely of that genus and its ally *Hastigerina*; below 3000 fathoms even the tests themselves are dissolved. Casts of their bodies

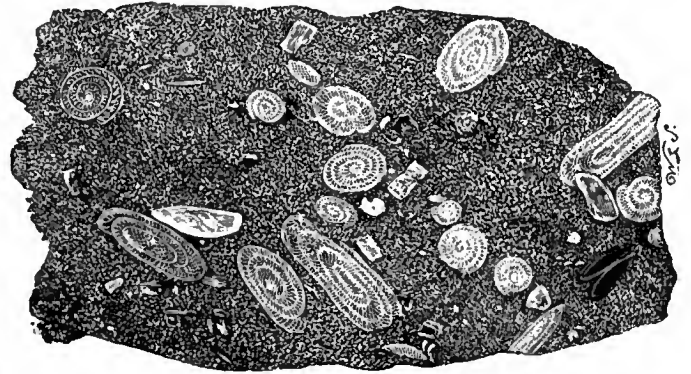

FIG. 20.—Section of *Fusulina* Limestone.

respective abundance) to two limestones of the Carboniferous series. Porcellanous shells become abundant only from the Lias upwards. The glauconitic grains of the Greensand formations are chiefly foraminiferal casts. Chalk is well known to consist largely of foraminiferal shells, mostly vitreous, like the north Atlantic globigerina ooze. In the Maestricht chalk more littoral conditions prevailed, and we find such large-sized



FIG. 21.—Microscopic Organisms in Chalk from Gravesend. a, b, c, d, *Textularia globulosa*; e, e, e, e, *Rotalia aspera*; f, *Textularia aculeata*; g, *Planularia hexas*; h, *Navicula*.

species as *Orbitoides* (vitreous) and *Orbitolites* (porcellanous; figs. 5, 6), &c. In the Eocene Tertiaries the Calcaire Grossier of the Paris basin is mainly composed of Miliolid forms. Nummulites occur in English beds and in the Paris basin; but the great beds of these, forming reef-like masses of limestone, occur farther south, extending from the Pyrenees through the southern and eastern Alps to Egypt, Sinai, and on to north India. The peculiar structure occurring in the Lower Laurentian limestone, as well as other limestones of Archean age described as a Nummulitaceous genus, "*Eozoon*," by Carpenter and Dawson, and abundantly illustrated in the 9th edition of his encyclopaedia, is now universally regarded as of inorganic origin. "Looking

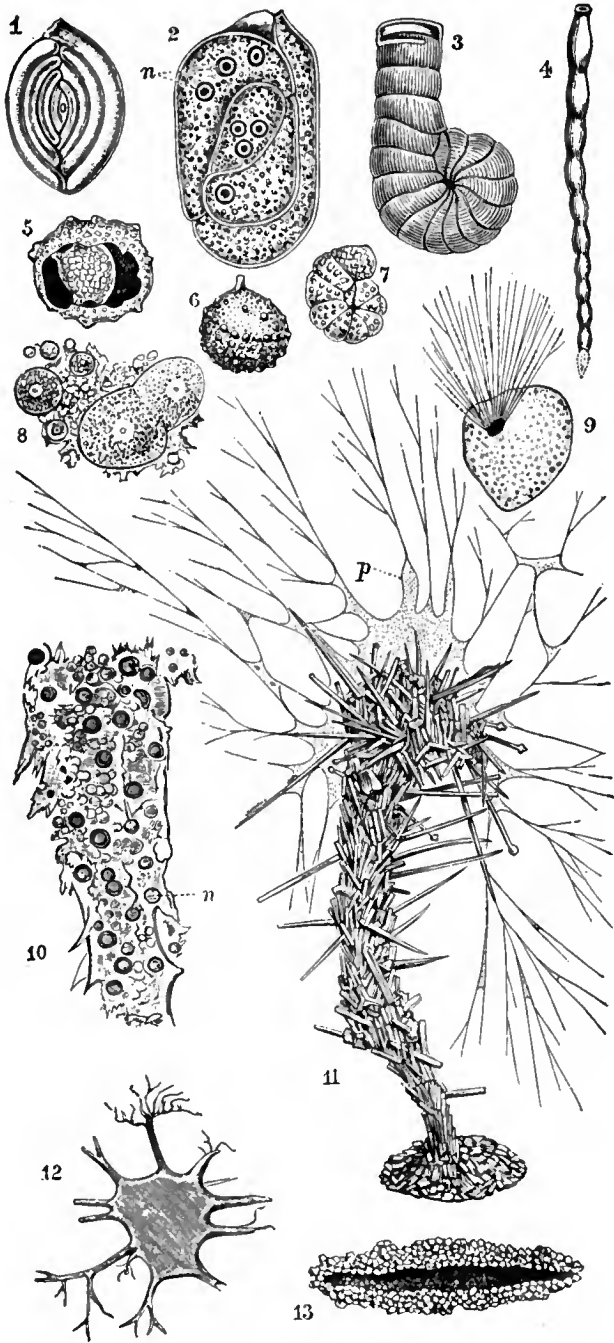

FIG. 22.—Imperforata.

- 1, *Spiroloculina planulata*, Lamarck, showing five "coils"; porcellanous.
- 2, Young ditto, with shell dissolved and protoplasm stained so as to show the seven nuclei *n*.
- 3, *Spirulina* (*Peneroplis*); a sculptured imperfectly coiled shell; porcellanous.
- 4, *Vertebralina*, a simple shell consisting of chambers succeeding one another in a straight line; porcellanous.
- 5, 6, *Thurammina papillata*, Brady, a sandy form. 5 is broken open so as to show an inner chamber; recent. $\times 25$.
- 7, *Haplophragmium canariensis*, a sandy form; recent.
- 8, Nucleated reproductive bodies (bud-spores) of *Haliphysema*.
- 9, *Squamulina laevis*, M. Schultze; $\times 40$; a simple porcellanous Miliolide.
- 10, Protoplasmic core removed after treatment with weak chromic acid from the shell of *Haliphysema tumanovitchii*, Bow. *n*, Vesicular nuclei, stained with haematoxylin. (After Lankester.)
- 11, *Haliphysema tumanovitchii*; $\times 25$ diam.; living specimen, showing the wine-glass-shaped shell built up of sand-grains and sponge-spicules, and the abundant protoplasm *p*, issuing from the mouth of the shell and spreading partly over its projecting constituents.
- 12, Shell of *Astrorhiza limicola*, Sand.; $\times 3$; showing the branching of the test on some of the rays usually broken away in preserved specimens (original).
- 13, Section of the shell of *Marsipella*, showing thick walls built of sand-grains.

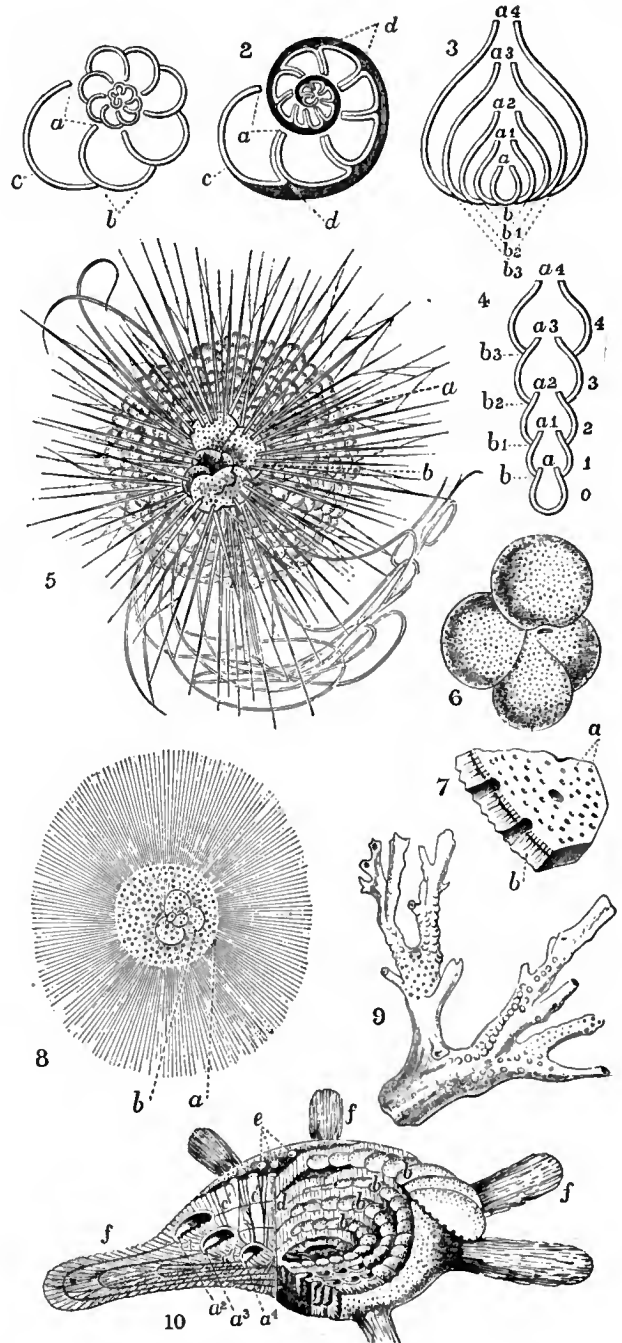

FIG. 23.—Perforata.

- 1, Spiral arrangement of simple chambers of a Reticularian shell, as in small *Rotalia*.
- 2, Ditto, with double septal walls, and supplemental shell-substance (shaded), as in large *Rotalia*.
- 3, Diagram to show the mode in which successively-formed chambers may completely embrace their predecessors, as in *Fronicularia*.
- 4, Diagram of a simple straight series of non-embracing chambers, as in *Nodosaria*.
- 5, *Hastigerina murrayi*, Wyv. Thomson. *a*, Bubbly (vacuolated) protoplasm, enclosing *b*, the perforated *Globigerina*-like shell (conf. central capsule of Radiolaria). From the peripheral protoplasm project, not only fine pseudopodia, but hollow spines of calcareous matter, which are set on the shell, and have an axis of active protoplasm. Pelagic; drawn in the living state.
- 6, *Globigerina bulloides*, d'Orb., showing the punctiform perforations of the shell and the main aperture.
- 7, Fragment of the shell of *Globigerina*, seen from within, and highly magnified. *a*, Fine perforations in the inner shell substances; *b*, outer (secondary) shell substance. Two coarser perforations are seen in section, and one lying among the smaller.
- 8, *Orbulina universa*, d'Orb. Pelagic example, with adherent radiating calcareous spines (hollow), and internally a small *Globigerina* shell. It is probably a developmental phase of *Globigerina*. *a*, *Orbulina* shell; *b*, *Globigerina* shell.
- 9, *Polytrema minaceum*, Lin.; $\times 12$. Mediterranean. Example of a branched adherent calcareous perforate Reticularian.
- 10, *Calcarina spengleri*, Gmel.; $\times 10$. Tertiary, Sicily. Shell dissected so as to show the spiral arrangement of the chambers, and the copious secondary shell substance. *a*², *a*³, *a*⁴, Chambers of three successive coils in section, showing the thin primary wall (finely tubulate) of each; *b*, *b*, *b*, perforate surfaces of the primary wall of four tiers of chambers, from which the secondary shell substance has been cleared away; *c*, *c*, secondary or intermediate shell substance in section, showing coarse canals; *d*, section of secondary shell substance at right angles to *c*'; *e*, tubercles of secondary shell substance on the surface; *f*, *f*, club-like processes of secondary shell substance.

at the almost universal diffusion of existing Foraminifera and the continuous accumulation of their shells over vast areas of the ocean-bottom, they are certainly doing more than any other group of organisms to separate carbonate of lime from its solution in sea-water, so as to restore to the solid crust of the earth what is being continuously withdrawn from it by solution of the calcareous materials of the land above sea-level." (E. R. Lankester, "Protozoa," *Ency. Brit.* 9th ed.)

Historical.—The Foraminifera were discovered as we have seen by A. d'Orbigny. C. E. Ehrenberg added a large number of species, but it was to F. Dujardin in 1835 that we owe the recognition of their true zoological position and the characters of the living animal. W. B. Carpenter and W. C. Williamson in England contributed largely to the study of the shell, the latter being the first to call attention to its multiform character in the development of a single species, and to utilize the method of thin sections, which has proved so fertile in results. W. K. Parker and H. B. Brady, separately, and in collaboration, described an enormous number of forms in a series of papers, as well as in the monograph by the latter of the Foraminifera of the "Challenger" expedition. Munier-Chalmas and Schlumberger brought out the fact of dimorphism in the group, which was later elucidated and incorporated in the full cytological study of the life-cycle of Foraminifera by J. J. Lister and F. Schaudinn, independently, but with concurrent results.

LITERATURE.—The chief recent books are: F. Chapman, *The Foraminifera* (1902), and J. J. Lister, "The Foraminifera," in E. R. Lankester's *Treatise on Zoology* (1903), in which full bibliographies will be found. For a final résumé of the long controversy on Eozoon, see George P. Merrill in *Report of the U.S. National Museum* (1906), p. 635. Other classifications of the Foraminifera will be found by G. H. Theodor Eimer and C. Fickert in *Zeitschr. für wissenschaftliche Zoologie*, l.v. (1899), p. 599, and L. Rhumbler in *Archiv für Protistenkunde*, iii. (1903–1904); the account of the reproduction is based on the researches of J. J. Lister, summarized in the above-cited work, and of F. Schaudinn, in *Arbeiten des kaiserlichen Gesundheitsamts*, xix. (1903). We must also cite W. B. Carpenter, W. K. Parker and T. Rymer Jones, *Introduction to the Study of the Foraminifera* (Ray Society) (1862); W. B. Carpenter, "Foraminifera," in *Ency. Brit.*, 9th ed.; W. C. Williamson, *On the Recent Foraminifera of Great Britain* (Ray Society), (1858); H. B. Brady, "The Foraminifera," in *Challenger Reports*, ix. (1884); A. Kemna, in *Ann. de la soc. royale zoologique et malacologique de Belgique*, xxxvii. (1902), p. 60; xxxix. (1904), p. 7.

Appendix.—The XENOPHYOPHORIDÆ are a small group of bottom-dwelling Sarcodina which show a certain resemblance to arenaceous Foraminifera, though observations in the living state show that the character of the pseudopodia is lacking. The multinucleate protoplasm is contained in branching tubes, aggregated into masses of definite form, bounded by a common wall of foreign bodies (sponge spicules, &c.) cemented into a membrane. The cytoplasm contains granules of BaSO₄ and pellets of faecal matter. All that is known of reproduction is the resolution of the pellets into uninucleate cells. (F. E. Schultze, *Wissenschaftliche Ergebnisse der deutschen Tiefsee-Expedition*, vol. xi., 1905, pt. i.) (M. HA.)

FORBACH, a town of Germany in the imperial province of Alsace-Lorraine, on an affluent of the Rossel, and on the railway from Metz to Saarbrücken, 5½ m. S.W. of the latter. Pop. (1905) 8193. It has a Protestant and a Roman Catholic (Gothic) church, a synagogue and a Progymnasium. Its industries include the manufacture of tiles, pasteboard wares and gardening implements, while there are coal mines in the vicinity. After the battle on the neighbouring heights of Spicheren (6th of August 1870), in which the French under General Frossard were defeated by the Germans under General von Glümer, the town was occupied by the German troops, and at the conclusion of the war annexed to Germany. On the Schlossberg near the town are the ruins of the castle of the counts of Forbach, a branch of the counts of Saarbrücken.

See Besler, *Geschichte des Schlosses, der Herrschaft und der Stadt Forbach* (1895).

FORBES, ALEXANDER PENROSE (1817–1875), Scottish divine, was born at Edinburgh on the 6th of June 1817. He was the second son of John Henry Forbes, Lord Medwyn, a judge of the court of session, and grandson of Sir William Forbes of Pittsligo. He studied first at the Edinburgh Academy, then for two years under the Rev. Thomas Dale, the poet, in Kent, passed one session at Glasgow University in 1833, and,

having chosen the career of the Indian civil service, completed his studies with distinction at Haileybury College. In 1836 he went to Madras and secured early promotion, but in consequence of ill-health he was obliged to return to England. He then entered Brasenose College, Oxford, where in 1841 he obtained the Boden Sanskrit scholarship, and graduated in 1844. He was at Oxford during the early years of the movement known as Puseyism, and was powerfully influenced by association with Newman, Pusey and Keble. This led him to resign his Indian appointment. In 1844 he was ordained deacon and priest in the English Church, and held curacies at Aston, Rowant and St Thomas's, Oxford; but being naturally attracted to the Episcopal Church of his native land, then recovering from long depression, he removed in 1846 to Stonehaven, the chief town of Kincardineshire. The same year, however, he was appointed to the vicarage of St Saviour's, Leeds, a church founded to preach and illustrate Tractarian principles. In 1848 Forbes was called to succeed Bishop Moir in the see of Brechin. He removed the episcopal residence to Dundee, where he resided till his death, combining the pastoral charge of the congregation with the duties of the see. When he came to Dundee the churchmen were accustomed owing to their small numbers to worship in a room over a bank. Through his energy several churches were built, and among them the pro-cathedral of St Paul's. He was prosecuted in the church courts for heresy, the accusation being founded on his primary charge, delivered and published in 1857, in which he set forth his views on the Eucharist. He made a powerful defence of the charge, and was acquitted with "a censure and an admonition." Keble wrote in his defence, and was present at his trial at Edinburgh. Forbes was a good scholar, a scientific theologian and a devoted worker, and was much beloved. He died at Dundee on the 8th of October 1875.

Principal works: *A Short Explanation of the Nicene Creed* (1852); *An Explanation of the Thirty-nine Articles* (2 vols., 1867 and 1868); *Commentary on the Seven Penitential Psalms* (1847); *Commentary on the Canticles* (1853). See Mackey's *Bishop Forbes, a Memoir*.

FORBES, ARCHIBALD (1838–1900), British war correspondent, the son of a Presbyterian minister in Morayshire, was born on the 17th of April 1838, and was educated at Aberdeen University. Entering the Royal Dragoons as a private, he gained, while in the service, considerable practical experience of military life and affairs. Being invalided from his regiment, he settled in London, and became a journalist. When the Franco-German War broke out in 1870, Forbes was sent to the front as war correspondent to the *Morning Advertiser*, and in this capacity he gained valuable information as to the plans of the Parisians for withstanding a siege. Transferring his services to the *Daily News*, his brilliant feats in the transmission of intelligence drew world-wide attention to his despatches. He was with the German army from the beginning of the campaign, and he afterwards witnessed the rise and fall of the Commune. Forbes afterwards proceeded to Spain, where he chronicled the outbreak of the second Carlist War; but his work here was interrupted by a visit to India, where he spent eight months upon a mission of investigation into the Bengal famine of 1874. Then he returned to Spain, and followed at various times the Carlist, the Republican and the Alfonsist forces. As representative of the *Daily News*, he accompanied the prince of Wales in his tour through India in 1875–1876. Forbes went through the Servian campaign of 1875, and was present at all the important engagements. In the Russo-Turkish campaign of 1877 he achieved striking journalistic successes at great personal risk. Attached to the Russian army, he witnessed most of the principal operations, and remained continuously in the field until attacked by fever. His letters, together with those of his colleagues, MacGahan and Millet, were republished by the *Daily News*. On recovering from his fever, Forbes proceeded to Cyprus, in order to witness the British occupation. The same year (1878) he went to India, and in the winter accompanied the Khyber Pass force to Jalalabad. He was present at the taking of Ali Musjid, and marched with several expeditions against the hill tribes. Burma was Forbes's next field of adventure, and at Mandalay, the capital, he had several interesting interviews with King Thibaw. He left Burma

hurriedly for South Africa, where, in consequence of the disaster of Isandlwana, a British force was collecting for the invasion of Zululand. He was present at the victory of Ulundi, and his famous ride of 120 m. in fifteen hours, by which he was enabled to convey the first news of the battle to England, remains one of the finest achievements in journalistic enterprise. Forbes subsequently delivered many lectures on his war experiences to large audiences. His closing years were spent in literary work. He had some years before published a military novel entitled *Drawn from Life*, and a volume on his experiences of the war between France and Germany. These were now followed by numerous publications, including *Glimpses through the Cannon Smoke* (1880); *Souvenirs of some Continents* (1885); *William I. of Germany: a Biography* (1888); *Havlock*, in the "English Men of Action" Series (1890); *Barracks, Bivouacs, and Battles* (1891); *The Afghan Wars, 1839-80* (1892); *Czar and Sultan* (1895); *Memories and Studies of War and Peace* (1895), in many respects autobiographic; and *Colin Campbell, Lord Clyde* (1896). He died on the 30th of March 1900.

FORBES, DAVID (1828-1876), British mineralogist, metallurgist and chemist, brother of Edward Forbes (*q.v.*), was born on the 6th of September 1828, at Douglas, Isle of Man, and received his early education there and at Brentwood in Essex. When a boy of fourteen he had already acquired a remarkable knowledge of chemistry. This subject he studied at the university of Edinburgh, and he was still young when he was appointed superintendent of the mining and metallurgical works at Espedal in Norway. Subsequently he became a partner in the firm of Evans & Askin, nickel-smelters, of Birmingham, and in that capacity during the years 1857-1860 he visited Chile, Bolivia and Peru. Besides reports for the Iron and Steel Institute, of which, during the last years of his life, he was foreign secretary, he wrote upwards of 50 papers on scientific subjects, among which are the following: "The Action of Sulphurets on Metallic Silicates at High Temperatures," *Rep. Brit. Assoc.*, 1855, pt. ii. p. 62; "The Relations of the Silurian and Metamorphic Rocks of the south of Norway," *ib.* p. 82; "The Causes producing Foliation in Rocks," *Journ. Geol. Soc.* xi., 1855; "The Chemical Composition of the Silurian and Cambrian Limestones," *Phil. Mag.* xiii. pp. 365-373, 1857; "The Geology of Bolivia and Southern Peru," *Journ. Geol. Soc.* xvii. pp. 7-62, 1861; "The Mineralogy of Chile," *Phil. Mag.*, 1865; "Researches in British Mineralogy," *Phil. Mag.*, 1867-1868. His observations on the geology of South America were given in a masterly essay, and these and subsequent researches threw much light on igneous and metamorphic phenomena and on the resulting changes in rock-formations. He also contributed important articles on chemical geology to the *Chemical News* and *Geological Magazine* (1867 and 1868). In England he was a pioneer in microscopic petrology. He was elected F.R.S. in 1858. He died in London on the 5th of December 1876.

See Obituary by P. M. Duncan in *Quart. Journ. Geol. Soc.*, vol. xxxiii., 1877, p. 41; and by J. Morris in *Geol. Mag.*, 1877, p. 45.

FORBES, DUNCAN, OF CULLODEN (1685-1747), Scottish statesman, was born at Bunchrew or at Culloden near Inverness on the 10th of November 1685. After he had completed his studies at the universities of Edinburgh and Leiden, he was admitted advocate at the Scottish bar in 1709. His own talents and the influence of the Argyll family secured his rapid advancement, which was still further helped by his loyalty to the Hanoverian cause at the period of the rebellion in 1715. In 1722 Forbes was returned member for Inverness, and in 1725 he succeeded Dundas of Arniston as lord advocate. He inherited the patrimonial estates on the death of his brother in 1734, and in 1737 he attained to the highest legal honours in Scotland, being made lord president of the court of session. As lord advocate, he had laboured to improve the legislation and revenue of the country, to extend trade and encourage manufactures, and no less to render the government popular and respected in Scotland. In the proceedings which followed the memorable Porteous mob, for example, when the government brought in a bill for disgracing the lord provost of Edinburgh, for fining

the corporation, and for abolishing the town-guard and city-gate, Forbes both spoke and voted against the measure as an unwarranted outrage on the national feeling. As lord president also he carried out some useful legal reforms; and his term of office was characterized by quick and impartial administration of the law.

The rebellion of 1745 found him at his post, and it tried all his patriotism. Some years before (1738) he had repeatedly and earnestly urged upon the government the expediency of embodying Highland regiments, putting them under the command of colonels whose loyalty could be relied upon, but officering them with the native chieftains and cadets of old families in the north. "If government," said he, "pre-engages the Highlanders in the manner I propose, they will not only serve well against the enemy abroad, but will be hostages for the good behaviour of their relations at home; and I am persuaded that it will be absolutely impossible to raise a rebellion in the Highlands." In 1739, with Sir Robert Walpole's approval, the original (1730) six companies (locally enlisted) of the Black Watch were formed into the famous "Forty-second" regiment of the line. The credit given to the earl of Chatham in some histories for this movement is an error; it rests really with Forbes and his friend Lord Islay, afterwards 3rd duke of Argyll (see the *Autobiography* of the 8th duke of Argyll, vol. i. p. 8 sq., 1906).

On the first rumour of the Jacobite rising Forbes hastened to Inverness, and through his personal influence with the chiefs of Macdonald and Macleod, those two powerful western clans were prevented from taking the field for Charles Edward; the town itself also he kept loyal and well protected at the commencement of the struggle, and many of the neighbouring proprietors were won over by his persuasions. His correspondence with Lord Lovat, published in the Culloden papers, affords a fine illustration of his character, in which the firmness of loyal principle and duty is found blended with neighbourly kindness and consideration. But at this critical juncture of affairs, the apathy of the government interfered considerably with the success of his negotiations. Advances of arms and money arrived too late, and though Forbes employed all his own means and what money he could borrow on his personal security, his resources were quite inadequate to the emergency. It is doubtful whether these advances were ever fully repaid. Part was doled out to him, after repeated solicitations that his credit might be maintained in the country; but it is evident he had fallen into disgrace in consequence of his humane exertions to mitigate the impolitic severities inflicted upon his countrymen after their disastrous defeat at Culloden. The ingratitude of the government, and the many distressing circumstances connected with the insurrection, sunk deep into the mind of Forbes. He never fairly rallied from the depression thus caused, and after a period of declining health he died on the 10th of December 1747.

Forbes was a patriot without ostentation or pretence, a true Scotsman with no narrow prejudice, an accomplished and even erudite scholar without pedantry, a man of genuine piety without asceticism or intolerance. His country long felt his influence through her reviving arts and institutions; and the example of such a character in that coarse and venal age, and among a people distracted by faction, political strife, and national antipathies, while it was invaluable to his contemporaries in a man of high position, is entitled to the lasting gratitude and veneration of his countrymen. In his intervals of leisure he cultivated with some success the study of philosophy, theology and biblical criticism. He is said to have been a diligent reader of the Hebrew Bible. His published writings, some of them of importance, include—*A Letter to a Bishop, concerning some Important Discoveries in Philosophy and Theology* (1732); *Some Thoughts concerning Religion, natural and revealed, and the Manner of Understanding Revelation* (1735); and *Reflections on Incredulity* (2nd ed., 1750).

His correspondence was collected and published in 1815, and a memoir of him (from the family papers) was written by Mr Hill Burton, and published along with a *Life of Lord Lovat*, in 1847. His statue by Roubillac stands in the Parliament House, Edinburgh.

FORBES, EDWARD (1815–1854), British naturalist, was born at Douglas, in the Isle of Man, on the 12th of February 1815. While still a child, when not engaged in reading, or in the writing of verses and drawing of caricatures, he occupied himself with the collecting of insects, shells, minerals, fossils, plants and other natural history objects. From his fifth to his eleventh year, delicacy of health precluded his attendance at any school, but in 1828 he became a day scholar at Athole House Academy in Douglas. In June 1831 he left the Isle of Man for London, where he studied drawing. In October, however, having given up all idea of making painting his profession, he returned home; and in the following month he matriculated as a student of medicine in the university of Edinburgh. His vacation in 1832 he spent in diligent work on the natural history of the Isle of Man. In 1833 he made a tour in Norway, the botanical results of which were published in Loudon's *Magazine of Natural History* for 1835–1836. In the summer of 1834 he devoted much time to dredging in the Irish Sea; and in the succeeding year he travelled in France, Switzerland and Germany.

Born a naturalist, and having no relish for the practical duties of a surgeon, Forbes in the spring of 1836 abandoned the idea of taking a medical degree, resolving to devote himself to science and literature. The winter of 1836–1837 found him at Paris, where he attended the lectures at the Jardin des Plantes on natural history, comparative anatomy, geology and mineralogy. Leaving Paris in April 1837, he went to Algiers, and there obtained materials for a paper on land and freshwater Mollusca, published in the *Annals of Natural History*, vol. ii. p. 250. In the autumn of the same year he registered at Edinburgh as a student of literature; and in 1838 appeared his first volume, *Malacologia Monensis*, a synopsis of the species of Manx Mollusca. During the summer of 1838 he visited Styria and Carniola, and made extensive botanical collections. In the following autumn he read before the British Association at Newcastle a paper on the distribution of terrestrial Pulmonifera in Europe, and was commissioned to prepare a similar report with reference to the British Isles. In 1841 was published his *History of British Star-fishes*, embodying extensive observations and containing 120 illustrations, inclusive of humorous tail-pieces, all designed by the author. On the 17th of April of the same year Forbes, accompanied by his friend William Thompson, joined at Malta H.M. surveying ship "Beacon," to which he had been appointed naturalist by her commander Captain Graves. From that date until October 1842 he was employed in investigating the botany, zoology and geology of the Mediterranean region. The results of these researches were made known in his "Report on the Mollusca and Radiata of the Aegean Sea, presented to the British Association in 1843," and in *Travels in Lycia*, published in conjunction with Lieut. (afterwards Admiral) T. A. B. Spratt in 1847. In the former treatise he discussed the influence of climate and of the nature and depth of the sea bottom upon marine life, and divided the Aegean into eight biological zones; his conclusions with respect to bathymetrical distribution, however, have naturally been modified to a considerable extent by the more recent explorations of the deep seas.

Towards the end of the year 1842 Forbes, whom family misfortunes had now thrown upon his own resources, sought and obtained the curatorship of the museum of the Geological Society of London. To the duties of that post he added in 1843 those of the professorship of botany at King's College. In November 1844 he resigned the curatorship of the Geological Society, and became palaeontologist to the Geological Survey of Great Britain. Two years later he published in the *Memoirs of the Geological Survey*, i. 336, his important essay "On the Connexion between the distribution of the existing Fauna and Flora of the British Isles, and the Geological Changes which have affected their Area, especially during the epoch of the Northern Drift." It is therein pointed out that, in accordance with the theory of their origin from various specific centres, the plants of Great Britain may be divided into five well-marked groups: the W. and S.W. Irish, represented in the N. of Spain, the S.E. Irish and S.W. English, related to the flora of the Channel

Isles and the neighbouring part of France; the S.E. English, characterized by species occurring on the opposite French coast; a group peculiar to mountain summits, Scandinavian in type; and, lastly, a general or Germanic flora. From a variety of arguments the conclusion is drawn that the greater part of the terrestrial animals and flowering plants of the British Islands migrated thitherward, over continuous land, at three distinct periods, before, during and after the glacial epoch. On this subject Forbes's brilliant generalizations are now regarded as only partially true (see C. Reid's *Origin of the British Flora*, 1899). In the autumn of 1848 Forbes married the daughter of General Sir C. Ashworth; and in the same year was published his *Monograph of the British Naked-eyed Medusae* (Ray Society). The year 1851 witnessed the removal of the collections of the Geological Survey from Craig's Court to the museum in Jermyn Street, and the appointment of Forbes as professor of natural history to the Royal School of Mines just established in conjunction therewith. In 1852 was published the fourth and concluding volume of Forbes and S. Hanley's *History of British Mollusca*; also his *Monograph of the Echinodermata of the British Tertiaries* (Palaeontographical Soc.).

In 1853 Forbes held the presidency of the Geological Society of London, and in the following year he obtained the fulfilment of a long-cherished wish in his appointment to the professorship of natural history in the university of Edinburgh, vacant by the death of R. Jameson, his former teacher. Since his return from the East in 1842, the determination and arrangement of fossils, frequent lectures, and incessant literary work, including the preparation of his palaeontological memoirs, had precluded Forbes from giving that attention to the natural history pursuits of his earlier life which he had earnestly desired. It seemed that at length he was to find leisure to reduce to order his stores of biological information. He lectured at Edinburgh, in the summer session of 1854, and in September of that year he occupied the post of president of the geological section at the Liverpool meeting of the British Association. But he was taken ill just after he had commenced his winter's course of lectures in Edinburgh, and after not many days' illness he died at Wardie, near Edinburgh, on the 18th of November 1854.

See *Literary Gazette* (November 25, 1854); *Edinburgh New Philosophical Journal* (New Ser.), (1855); *Quart. Journ. Geol. Soc.* (May 1855); G. Wilson and A. Geikie, *Memoir of Edward Forbes* (1861), in which, pp. 575–583, is given a list of Forbes's writings. See also *Literary Papers*, edited by Lovell Reeve (1855). The following works were issued posthumously: "On the Tertiary Fluvio-marine Formation of the Isle of Wight" (*Geol. Survey*), edited by R. A. C. Godwin-Austen (1856); "The Natural History of the European Seas," edited and continued by R. A. C. Godwin-Austen (1859).

FORBES, JAMES DAVID (1809–1868), Scottish physicist, was the fourth son of Sir William Forbes, 7th baronet of Pitsligo, and was born at Edinburgh on the 20th of April 1809. He entered the university of Edinburgh in 1825, and soon afterwards began to contribute papers to the *Edinburgh Philosophical Journal* anonymously under the signature "Δ." At the age of nineteen he became a fellow of the Royal Society of Edinburgh, and in 1832 he was elected to the Royal Society of London. A year later he was appointed professor of natural philosophy in Edinburgh University, in succession to Sir John Leslie and in competition with Sir David Brewster, and during his tenure of that office, which he did not give up till 1860, he not only proved himself an active and efficient teacher, but also did much to improve the internal conditions of the university. In 1859 he was appointed successor to Brewster in the principalship of the United College of St Andrews, a position which he held until his death at Clifton on the 31st of December 1868.

As a scientific investigator he is best known for his researches on heat and on glaciers. Between 1836 and 1844 he published in the *Trans. Roy. Soc. Ed.* four series of "Researches on Heat," in the course of which he described the polarization of heat by tourmaline, by transmission through a bundle of thin mica plates inclined to the transmitted ray, and by reflection from the multiplied surfaces of a pile of mica plates placed at the polarizing angle, and also its circular polarization by two internal

reflections in rhombs of rock-salt. His work won him the Rumford medal of the Royal Society in 1838, and in 1843 he received its Royal medal for a paper on the "Transparency of the Atmosphere and the Laws of Extinction of the Sun's Rays passing through it." In 1846 he began experiments on the temperature of the earth at different depths and in different soils near Edinburgh, which yielded determinations of the thermal conductivity of trap-tufa, sandstone and pure loose sand. Towards the end of his life he was occupied with experimental inquiries into the laws of the conduction of heat in bars, and his last piece of work was to show that the thermal conductivity of iron diminishes with increase of temperature. His attention was directed to the question of the flow of glaciers in 1840 when he met Louis Agassiz at the Glasgow meeting of the British Association, and in subsequent years he made several visits to Switzerland and also to Norway for the purpose of obtaining accurate data. His observations led him to the view that a glacier is an imperfect fluid or a viscous body which is urged down slopes of a certain inclination by the mutual pressure of its parts, and involved him in some controversy with Tyndall and others both as to priority and to scientific principle. Forbes was also interested in geology, and published memoirs on the thermal springs of the Pyrenees, on the extinct volcanoes of the Vivarais (Ardèche), on the geology of the Cuchullin and Eildon hills, &c. In addition to about 150 scientific papers, he wrote *Travels through the Alps of Savoy and Other Parts of the Pennine Chain, with Observations on the Phenomena of Glaciers* (1843); *Norway and its Glaciers* (1853); *Occasional Papers on the Theory of Glaciers* (1859); *A Tour of Mont Blanc and Monte Rosa* (1855). He was also the author (1852) of the "Dissertation on the Progress of Mathematical and Physical Science," published in the 8th edition of the *Encyclopaedia Britannica*.

See *Forbes's Life and Letters*, by Principal Shairp, Professor P. G. Tait and A. Adams-Reilly (1873); *Professor Forbes and his Biographers*, by J. Tyndall (1873).

FORBES, SIR JOHN (1787–1861), British physician, was born at Cuttlebrae, Banffshire, in 1787. He attended the grammar school at Aberdeen, and afterwards entered Marischal College. After serving for nine years as a surgeon in the navy, he graduated M.D. at Edinburgh in 1817, and then began to practise in Penzance, whence he removed to Chichester in 1822. He took up his residence in London in 1840, and in the following year was appointed physician to the royal household. He was knighted in 1853, and died on the 13th of November 1861 at Whitchurch in Berkshire. Sir John Forbes was better known as an author and editor than as a practical physician. His works include the following:—*Original Cases . . . illustrating the Use of the Stethoscope and Percussion in the Diagnosis of Diseases of the Chest* (1824); *Illustrations of Modern Mesmerism* (1845); *A Physician's Holiday* (1st ed., 1849); *Memorandums made in Ireland in the Autumn of 1852* (2 vols., 1853); *Sight-seeing in Germany and the Tyrol in the Autumn of 1855* (1856). He was joint editor with A. Tweedie and J. Conolly of *The Cyclopaedia of Practical Medicine* (4 vols., 1833–1835); and in 1836 he founded the *British and Foreign Medical Review*, which, after a period of prosperity, involved its editor in pecuniary loss, and was discontinued in 1847, partly in consequence of the advocacy in its later numbers of doctrines obnoxious to the profession.

FORBES, a municipal town of Ashburnham county, New South Wales, Australia, 289 m. W. by N. from Sydney, on the Lachlan river, and with a station on the Great Western railway. Pop. (1901) 4313. Its importance as a commercial centre is due to its advantageous position between the northern and southern markets. It has steam-sawing and flour-mills, breweries and wool-scouring establishments; while the surrounding country produces good quantities of cereals, lucerne, wine and fruit.

FORBES-ROBERTSON, JOHNSTON (1853–), English actor, was the son of John Forbes-Robertson of Aberdeen, an art critic. He was educated at Charterhouse, and studied at the Royal Academy schools with a view to becoming a painter. But though he kept up his interest in that art, in 1874 he turned

to the theatre, making his first appearance in London as Chastelard, in *Mary, Queen of Scots*. He studied under Samuel Phelps, from whom he learnt the traditions of the tragic stage. He played with the Bancrofts and with John Hare, supported Miss Mary Anderson in both England and America, and also acted at different times with Sir Henry Irving. His refined and artistic style, and beautiful voice and elocution made him a marked man on the English stage, and in Pinero's *The Profligate* at the Garrick theatre (1889), under Hare's management, he established his position as one of the most individual of London actors. In 1895 he started under his own management at the Lyceum with Mrs Patrick Campbell, producing *Romeo and Juliet*, *Hamlet*, *Macbeth* and also some modern plays; his impersonation as Hamlet was especially fine, and his capacity as a romantic actor was shown to great advantage also in John Davidson's *For the Crown* and in Maeterlinck's *Pelléas and Mélisande*. In 1900 he married the actress Gertrude Elliott, with whom, as his leading lady, he appeared at various theatres, producing in subsequent years *The Light that Failed*, *Madeleine Lucette Riley's Mice and Men*, and G. Bernard Shaw's *Caesar and Cleopatra*, Jerome K. Jerome's *Passing of the Third Floor Back*, &c. His brothers, Ian Robertson (b. 1858) and Norman Forbes (b. 1859), had also been well-known actors from about 1878 onwards.

FORBIN, CLAUDE DE (1656–1733), French naval commander, was born in Provence, of a family of high standing, in 1656. High-spirited and ungovernable in his boyhood, he ran away from his home, and through the influence of an uncle entered the navy, serving his first campaign in 1675. For a short time he quitted the navy and entered the army, but soon returned to his first choice. He made under D'Estrées the American campaign, and under Duquesne that of Algiers in 1683, on all occasions distinguishing himself by his impetuous courage. The most remarkable episode of his life was his mission to Siam. During the administration of the Greek adventurer Phaulcon in that country, the project was formed of introducing the Christian religion and European civilization, and the king sent an embassy to Louis XIV. In response a French embassy was sent out, Forbin accompanying the chevalier de Chaumont with the rank of major. When Chaumont returned to France, Forbin was induced to remain in the service of the Siamese king, and accepted, though with much reluctance, the posts of grand admiral, general of all the king's armies and governor of Bangkok. His position, however, was soon made untenable by the jealousy and intrigues of the minister Phaulcon; and at the end of two years he left Siam, reaching France in 1688. He was afterwards fully engaged in active service, first with Jean Bart in the war with England, when they were both captured and taken to Plymouth. They succeeded in making their escape and were soon serving their country again. Forbin was wounded at the battle of La Hogue, and greatly distinguished himself at the battle of Lagos. He served under D'Estrées at the taking of Barcelona, was sent ambassador to Algiers, and in 1702 took a brilliant part in the Mediterranean in the War of the Spanish Succession. In 1706 he took command of a squadron at Dunkirk, and captured many valuable prizes from the Dutch and the English. In 1708 he was entrusted with the command of the squadron which was to convey the Pretender to Scotland; but so effectually were the coasts guarded by Byng that the expedition failed, and returned to Dunkirk. Forbin was now beginning to be weighed down with the infirmities of age and the toils of service, and in 1710 he retired to a country house near Marseilles. There he spent part of his time in writing his memoirs, published in 1730, which are full of interest and are written in a graphic and attractive style. Forbin died on the 4th of March 1733.

FORCELLINI, EGIDIO (1688–1768), Italian philologist, was born at Fener in the district of Treviso and belonged to a very poor family. He went to the seminary at Padua in 1704, studied under Facciolati, and in due course attained to the priesthood. From 1724 to 1731 he held the office of rector of the seminary at Ceneda, and from 1731 to 1765 that of father confessor in the seminary of Padua. The remaining years of his life were

mainly spent in his native village. He died at Padua in 1768 before the completion of the great work on which he had long co-operated with Facciolati. This was the vast *Latin Lexicon* (see FACCIOLATI), which has formed the basis of all similar works that have since been published. He was engaged with his Herculean task for nearly 35 years, and the transcription of the manuscript by Luigi Violato occupied eight years more.

FORCHHAMMER, JOHANN GEORG (1794-1865), Danish mineralogist and geologist, was born at Husum, Schleswig, on the 24th of July 1794, and died at Copenhagen on the 14th of December 1865. After studying at Kiel and Copenhagen from 1815 to 1818, he joined Oersted and Lauritz Esmarch in their mineralogical exploration of Bornholm, and took a considerable share in the labours of the expedition. In 1820 he obtained his doctor's degree by a chemical treatise *De mangano*, and immediately after set out on a journey through England, Scotland and the Faeroe Islands. In 1823 he was appointed lecturer at Copenhagen University on chemistry and mineralogy; in 1829 he obtained a similar post in the newly established polytechnic school; and in 1831 he was appointed professor of mineralogy in the university, and in 1848 became curator of the geological museum. From 1835 to 1837 he made many contributions to the geological survey of Denmark. On the death of H. C. Oersted in 1851, he succeeded him as director of the polytechnic school and secretary of the Academy of Sciences. In 1850 he began with J. Steenstrup and Worsaae various anthropological publications which gained a high reputation. As a public instructor Forchhammer held a high place and contributed potently to the progress of his favourite studies in his native country. He interested himself in such practical questions as the introduction of gas into Copenhagen, the establishment of the fire-brigade at Rosenborg and the boring of artesian wells.

Among his more important works are—*Loerebog i de enkelte Radicalers Chemi* (1842); *Danmarks geognostiske Forhold* (1835); *Om de Bornholmske Kulfomationer* (1836); *Det myere Kridt i Danmark* (1847); *Bidrag til Skildringen af Danmarks geografiske Forhold* (1858). A list of his contributions to scientific periodicals, Danish, English and German, will be found in the *Catalogue of Scientific Papers* published by the Royal Society of London. One of the most interesting and most recent is "On the Constitution of Sea Water at Different Depths and in Different Latitudes," in the *Proceedings of the Roy. Soc.* xii. (1862-1863).

FORCHHAMMER, PETER WILHELM (1801-1894), German classical archaeologist, was born at Husum in Schleswig on the 23rd of October 1801. He was educated at the Lübeck gymnasium and the university of Kiel, with which he was connected for nearly 65 years. In 1830-1834 and 1838-1840 he travelled in Italy, Greece, Asia Minor and Egypt. In 1843 he was appointed professor of philology at Kiel and director of the archaeological museum founded by himself in co-operation with Otto Jahn. He died on the 8th of January 1894. Forchhammer was a democrat in the best sense of the word, and from 1871 to 1873 represented the progressive party of Schleswig-Holstein in the German Reichstag. His published works deal chiefly with topography and ancient mythology. His travels had convinced him that a full and comprehensive knowledge of classical antiquity could only be acquired by a thorough acquaintance with Greek and Roman monuments and works of art, and a detailed examination of the topographical and climatic conditions of the chief localities of the ancient world. These principles are illustrated in his *Hellenika. Griechenland. Im Neuen das Alte* (1837), which contains his theory of the origin and explanation of the Greek myths, which he never abandoned, in spite of the attacks to which it was subjected. According to him, the myths arose from definite local (especially atmospheric and aquatic) phenomena, and represented the annually recurring processes of nature as the acts of gods and heroes; thus, in *Achill* (1853), the Trojan War is the winter conflict of the elements in that district. Other similar short treatises are: *Die Gründung Roms* (1868); *Daduchos* (1875), on the language of the myths and mythical buildings; *Die Wanderungen der Inachostochter Io* (1880); *Prolegomena zur Mythologie als Wissenschaft und Lexikon der Mythensprache* (1891). Amongst his topographical works mention may be made of: *Topographie von Athen* (1841);

Beschreibung der Ebene von Troja (1850), a commentary on a map of the locality executed by T. A. Spratt (see *Journal of the Royal Geographical Society*, xii., 1842); *Topographia Thebarum Heptapylarum* (1854); *Erklärung der Ilias* (1884), on the basis of the topographical and physical peculiarities of the plain of Troy. His *Demokratenbüchlein* (1849), in the main a discussion of the Aristotelian theory of the state, and *Die Athener und Sokrates* (1837), in which, contrary to the almost universal opinion, he upheld the procedure of the Athenians as perfectly legal and their verdict as a perfectly just one, also deserve notice.

For a full list of his works see the obituary notice by E. Alberti in C. Bursian's *Biographisches Jahrbuch für Altertumskunde*, xx. (1897); also J. Süss in *Allgemeine deutsche Biographie*, and A. Hoeck and L. C. Pertsch, *P. W. Forchhammer* (1898).

FORCHHEIM, a town of Germany, in the kingdom of Bavaria, near the confluence of the Wiesent and the Regnitz, 16 m. S.S.E. of Bamberg. Pop. (1905) 8417. It has four Roman Catholic churches, including the Gothic Collegiate church and a Protestant church. Among the other public buildings are the progymnasium and an orphanage. The industries of the town include spinning and weaving, bleaching and dyeing, bone and glue works, brewing and paper-making. The spacious château occupies the site of the Carolingian palace which was destroyed in 1246.

Forchheim is of very early origin, having been the residence of the Carolingian sovereigns, including Charlemagne, in the 9th century. Consequently many diets were held here, and here also Conrad I. and Louis the Child were chosen German kings. The town was given by the emperor Henry II. in 1007 to the bishopric of Bamberg, and, except for a short period during the 11th century, it remained in the possession of the bishops until 1802, when it was ceded to Bavaria. In August 1796 a battle took place near Forchheim between the French and the Austrians. The fortifications of the town were dismantled in 1838.

See Hübsch, *Chronik der Stadt Forchheim* (Nürnberg, 1867).

FORD, EDWARD ONSLOW (1852-1901), English sculptor, was born in London. He received some education as a painter in Antwerp and as a sculptor in Munich under Professor Wagnmüller, but was mainly self-taught. His first contribution to the Royal Academy, in 1875, was a bust of his wife, and in portraiture he may be said to have achieved his greatest success. His busts are always extremely refined and show his sitters at their best. Those (in bronze) of his fellow-artists Arthur Hacker (1894), Briton Riviere and Sir W. Q. Orchardson (1895), Sir L. Alma Tadema (1896), Sir Hubert von Herkomer and Sir John Millais (1897), and of A. J. Balfour are all striking likenesses, and are equalled by that in marble of Sir Frederick Bramwell (for the Royal Institution) and by many more. He gained the open competition for the statue of Sir Rowland Hill, erected in 1882 outside the Royal Exchange, and followed it in 1883 with "Henry Irving as Hamlet," now in the Guildhall art gallery. This seated statue, good as it is, was soon surpassed by those of Dr Dale (1898, in the city museum, Birmingham) and Professor Huxley (1900), but the colossal memorial statue of Queen Victoria (1901), for Manchester, was less successful. The standing statue of W. E. Gladstone (1894, for the City Liberal Club, London) is to be regarded as one of Ford's better portrait works. The colossal "General Charles Gordon," eamel-mounted, for Chatham, "Lord Strathnairn," an equestrian group for Knightsbridge, and the "Maharajah of Mysore" (1900) comprise his larger works of the kind. A beautiful nude recumbent statue of Shelley (1892) upon a cleverly-designed base, which is not quite impeccable from the point of view of artistic taste, is at University College, Oxford, and a simplified version was presented by him to be set up on the shore of Viareggio, where the poet's body was washed up. Ford's ideal work has great charm and daintiness; his statue "Folly" (1886) was bought by the trustees of the Chantrey Fund, and was followed by other statues or statuettes of a similar order: "Peace" (1890), which secured his election as an associate of the Royal Academy, "Echo" (1895), on which he was elected full member, "The

Egyptian Singer" (1889), "Applause" (1893), "Glory to the Dead" (1901) and "Snowdrift" (1902). Ford's influence on the younger generation of sculptors was considerable and of good effect. His charming disposition rendered him extremely popular, and when he died a monument was erected to his memory (C. Lucchesi, sculptor, J. W. Simpson, architect) in St John's Wood, near to where he dwelt.

See SCULPTURE; also M. H. Spielmann, *British Sculpture and Sculptors of To-day* (London, 1901).

FORD, JOHN (1586-c.1640), English dramatist, was baptized on the 17th of April 1586 at Ilington in north Devon. He came of a good family; his father was in the commission of the peace and his mother was a sister of Sir John Popham, successively attorney-general and lord chief justice. The name of John Ford appears in the university register of Oxford as matriculating at Exeter College in 1601. Like a cousin and namesake (to whom, with other members of the society of Gray's Inn, he dedicated his play of *The Lover's Melancholy*), the future dramatist entered the profession of the law, being admitted of the Middle Temple in 1602; but he seems never to have been called to the bar. Four years afterwards he made his first appearance as an author with an elegy called *Fame's Memorial, or the Earl of Devonshire deceased*, and dedicated to the widow of the earl (Charles Blount, Lord Mountjoy, "coronized," to use Ford's expression, by King James in 1603 for his services in Ireland)—a lady who would have been no unfitting heroine for one of his own tragedies of lawless passion, the famous Penelope, formerly Lady Rich. This panegyric, which is accompanied by a series of epitaphs and is composed in a strain of fearless extravagance, was, as the author declares, written "unfee'd"; it shows that Ford sympathized, as Shakespeare himself is supposed to have done, with the "awkward fate" of the countess's brother, the earl of Essex. Who the "flint-hearted Lycia" may be, to whom the poet seems to allude as his own disdainful mistress, is unknown; indeed, the record of Ford's private life is little better than a blank. To judge, however, from the dedications, prologues and epilogues of his various plays, he seems to have enjoyed the patronage of the earl, afterwards duke, of Newcastle, "himself a muse" after a fashion, and Lord Craven, the supposed husband of the ex-queen of Bohemia. Ford's tract of *Honor Triumphant, or the Peeres Challenge* (printed 1606 and reprinted by the Shakespeare Society with the *Line of Life*, in 1843), and the simultaneously published verses *The Monarches Meeting, or the King of Denmarkes Welcome into England*, exhibit him as occasionally meeting the festive demands of court and nobility; and a kind of moral essay by him, entitled *A Line of Life* (printed 1620), which contains references to Raleigh, ends with a climax of fulsome praise to the address of King James I. Yet at least one of Ford's plays (*The Broken Heart*, iii. 4) contains an implied protest against the absolute system of government generally accepted by the dramatists of the early Stuart reigns. Of his relations with his brother-authors little is known; it was natural that he should exchange complimentary verses with James Shirley, and that he should join in the chorus of laments over the death of Ben Jonson. It is more interesting to notice an epigram in honour of Ford by Richard Crashaw, morbidly passionate in one direction as Ford was in another. The lines run:

"Thou cheat'st us, Ford; mak'st one seem two by art:
What is Love's Sacrifice but the Broken Heart?"

It has been concluded that in the latter part of his life he gratified the tendency to seclusion for which he was ridiculed in *The Time Poets (Choice Drollery, 1656)* by withdrawing from business and from literary life in London, to his native place; but nothing is known as to the date of his death. His career as a dramatist very probably began by collaboration with other authors. With Thomas Dekker he wrote *The Fairy Knight* and *The Bristowe Merchant* (licensed in 1624, but both unpublished), with John Webster *A late Murderer of the Sonne upon the Mother* (licensed in 1624). A play entitled *An ill Beginning has a good End*, brought on the stage as early as 1613 and attributed to Ford, was (if his) his earliest acted play; whether *Sir Thomas Overbury's Life and untimely Death* (1615) was a

play is extremely doubtful; some lines of indignant regret by Ford on the same subject are still preserved. He is also said to have written, at dates unknown, *The London Merchant* (which, however, was an earlier name for Beaumont and Fletcher's *Knight of the Burning Pestle*) and *The Royal Combat*; a tragedy by him, *Beauty in a Trance*, was entered in the Stationers' Register in 1653, but never printed. These three (or four) plays were among those destroyed by Warburton's cook. *The Queen, or the Excellency of the Sea*, a play of inverted passion, containing some fine sensuous lines, printed in 1653 by Alexander Singhe for private performance, has been recently edited by W. Bang (*Materialien zur Kunde d. älteren engl. Dramas*, 13, Louvain, 1906), and is by him on internal evidence confidently claimed as Ford's. Of the plays by Ford preserved to us the dates span little more than a decade—the earliest, *The Lover's Melancholy*, having been acted in 1628 and printed in 1629, the latest, *The Lady's Trial*, acted in 1638 and printed in 1639.

When writing *The Lover's Melancholy*, it would seem that Ford had not yet become fully aware of the bent of his own dramatic genius, although he was already master of his powers of poetic expression. He was attracted towards domestic tragedy by an irresistible desire to sound the depths of abnormal conflicts between passion and circumstances, to romantic comedy by a strong though not widely varied imaginative faculty, and by a delusion that he was possessed of abundant comic humour. In his next two works, undoubtedly those most characteristically expressive of his peculiar strength, *'Tis Pity she's a Whore* (acted c. 1626) and *The Broken Heart* (acted c. 1629), both printed in 1633 with the anagram of his name *Fide Honor*, he had found horrible situations which required dramatic explanation by intensely powerful motives. Ford by no means stood alone among English dramatists in his love of abnormal subjects; but few were so capable of treating them sympathetically, and yet without that reckless grossness or extravagance of expression which renders the morally repulsive aesthetically intolerable, or converts the horrible into the grotesque. For in Ford's genius there was real refinement, except when the "suprasensually sensual" impulse or the humbler self-delusion referred to came into play. In a third tragedy, *Love's Sacrifice* (acted c. 1630; printed in 1633), he again worked on similar materials; but this time he unfortunately essayed to base the interest of his plot upon an unendurably unnatural possibility—doing homage to virtue after a fashion which is in itself an insult. In *Perkin Warbeck* (printed 1634; probably acted a year later) he chose an historical subject of great dramatic promise and psychological interest, and sought to emulate the glory of the great series of Shakespeare's national histories. The effort is one of the most laudable, as it was by no means one of the least successful, in the dramatic literature of this period. *The Fancies Chaste and Noble* (acted before 1636, printed 1638), though it includes scenes of real force and feeling, is dramatically a failure, of which the main idea is almost provokingly slight and feeble; and *The Lady's Trial* (acted 1638, printed 1639) is only redeemed from utter wearisomeness by an unusually even pleasingness of form. There remain two other dramatic works, of very different kinds, in which Ford co-operated with other writers, the mask of *The Sun's Darling* (acted 1624, printed 1657), hardly to be placed in the first rank of early compositions, and *The Witch of Edmonton* (printed 1658, but probably acted about 1621), in which we see Ford as a joint writer with Dekker and Rowley of one of the most powerful domestic dramas of the English or any other stage.

A few notes may be added on some of the more remarkable of the plays enumerated. A wholly baseless anecdote, condensed into a stinging epigram by Endymion Porter, asserted that *The Lover's Melancholy* was stolen by Ford from Shakespeare's papers. Undoubtedly, the madness of the hero of this play of Ford's occasionally recalls Hamlet, while the heroine is one of the many, and at the same time one of the most pleasing, parallels to Viola. But neither of them is a copy, as Friar Bonaventura in Ford's second play may be said to be a copy of Friar Lawrence, whose kindly pliability he disagreeably exaggerates, or as D'Avolos in *Love's Sacrifice* is clearly modelled on Iago. The plot of *The Lover's Melancholy*, which is ineffective because it leaves no room for suspense in the mind of

the reader, seems original; in the dialogue, on the other hand, a justly famous passage in Act i. (the beautiful version of the story of the nightingale's death) is translated from Strada; while the scheme of the tedious interlude exhibiting the various forms of madness is avowedly taken, together with sundry comments, from Burton's *Anatomy of Melancholy*. Already in this play Ford exhibits the singular force of his pathos; the despondent misery of the aged Meleander, and the sweetness of the last scene, in which his daughter comes back to him, alike go to the heart. A situation—hazardous in spite of its comic substratum—between Thaumasta and the pretended Parthenophil is conducted, as Gifford points out, with real delicacy; but the comic scenes are merely stogy, notwithstanding, or by reason of, the effort expended on them by the author.

'*Tis Pity she's a Whore* has been justly recognized as a tragedy of extraordinary power. Mr Swinburne, in his eloquent essay on Ford, has rightly shown what is the meaning of this tragedy, and has at the same time indicated wherein consists its poison. He dwells with great force upon the different treatment applied by Ford to the characters of the two miserable lovers—brother and sister. "The sin once committed, there is no more wavering or flinching possible to him, who has fought so hard against the demoniac possession; while she who resigned body and soul to the tempter, almost at a word, remains liable to the influences of religion and remorse." This different treatment shows the feeling of the poet—the feeling for which he seeks to evoke our inmost sympathy—to oscillate between the belief that an awful crime brings with it its awful punishment (and it is sickening to observe how the argument by which the Friar persuades Annabella to forsake her evil courses mainly appeals to the physical terrors of retribution), and the notion that there is something fatal, something irresistible, and therefore in a sense self-justified, in so dominant a passion. The key-note to the conduct of Giovanni lies in his words at the close of the first scene—

"All this I'll do, to free me from the rod
Of vengeance; else I'll swear my fate's my god."

Thus there is no solution of the conflict between passion on the one side, and law, duty and religion on the other; and passion triumphs, in the dying words of "the student struck blind and mad by passion"—

"O, I bleed fast!
Death, thou'rt a guest long look'd for; I embrace
Thee and thy wounds: O, my last minute comes!
Where'er I go, let me enjoy this grace
Freely to view my Annabella's face."

It has been observed by J. A. Symonds that "English poets have given us the right key to the Italian temperament. . . . The love of Giovanni and Annabella is rightly depicted as more imaginative than sensual." It is difficult to allow the appositeness of this special illustration; on the other hand, Ford has even in this case shown his art of depicting sensual passion without grossness of expression; for the exception in Annabella's language to Soranzo seems to have a special intention, and is true to the pressure of the situation and the revulsion produced by it in a naturally weak and yielding mind. The entire atmosphere, so to speak, of the play is stifling, and is not rendered less so by the underplot with Hippolita.

'*Tis Pity she's a Whore* was translated into French by Maurice Maeterlinck under the title of *Annabella*, and represented at the Théâtre de l'Œuvre in 1894. The translator prefixes to the version an eloquent appreciation of Ford's genius, especially in his portraits of women, whose fate it is to live "dans les ténèbres, les craintes et les larmes."

Like this tragedy, *The Broken Heart* was probably founded upon some Italian or other novel of the day; but since in the latter instance there is nothing revolting in the main idea of the subject, the play commends itself as the most enjoyable, while, in respect of many excellences, an unsurpassed specimen of Ford's dramatic genius. The complicated plot is constructed with greater skill than is usual with this dramatist, and the pathos of particular situations, and of the entire character of Penthea—a woman doomed to hopeless misery, but capable of seeking to obtain for her brother a happiness which his cruelty has condemned her to forego—has an intensity and a depth which are all Ford's own. Even the lesser characters are more pleasing than usual, and some beautiful lyrics are interspersed in the play.

Of the other plays written by Ford alone, only *The Chronicle History of Perkin Warbeck*. A *Strange Truth*, appears to call for special attention. A repeated perusal of this drama suggests the judgment that it is overpraised when ranked at no great distance from Shakespeare's national dramas. Historical truth need not be taken into consideration in the matter; and if, notwithstanding James Gairdner's essay appended to his *Life and Reign of Richard III.*, there are still credulous persons left to think and assert that Perkin was not an impostor, they will derive little satisfaction from Ford's play, which with really surprising skill avoids the slightest indication as to the poet's own belief on the subject. That this tragedy should have been reprinted in 1714 and acted in 1745 only shows that the public, as is often the case, had an eye to the catastrophe rather

than to the development of the action. The dramatic capabilities of the subject are, however, great, and it afterwards attracted Schiller, who, however, seems to have abandoned it in favour of the similar theme of the Russian Demetrius. Had Shakespeare treated it, he would hardly have contented himself with investing the hero with the nobility given by Ford to this personage of his play,—for it is hardly possible to speak of a personage as a *character* when the clue to his conduct is intentionally withheld. Nor could Shakespeare have failed to bring out with greater variety and distinctness the dramatic features in Henry VII., whom Ford depicts with sufficient distinctness to give some degree of individuality to the figure, but still with a tenderness of touch which would have been much to the credit of the dramatist's skill had he been writing in the Tudor age. The play is, however, founded on Bacon's *Life*, of which the text is used by Ford with admirable discretion, and on Thomas Gainsford's *True and Wonderful History of Perkin Warbeck* (1618). The minor characters of the honest old Huntley, whom the Scottish king obliges to bestow his daughter's hand upon Warbeck, and of her lover the faithful "Dalyell," are most effectively drawn; even "the men of judgment," the adventurers who surround the chief adventurer, are spirited sketches, and the Irishman among them has actually some humour; while the style of the play is, as befits a "*Chronicle History*," so clear and straightforward as to make it easy as well as interesting to read.

The Witch of Edmonton was attributed by its publisher to William Rowley, Dekker, Ford, "&c.," but the body of the play has been generally held to be ascribable to Ford and Dekker only. The subject of the play was no doubt suggested by the case of the reported witch, Elizabeth Sawyer, who was executed in 1621. Swinburne agrees with Gifford in thinking Ford the author of the whole of the first act; and he is most assuredly right in considering that "there is no more admirable exposition of a play on the English stage." Supposing Dekker to be chiefly responsible for the scenes dealing with the unfortunate old woman whom persecution as a witch actually drives to become one, and Ford for the domestic tragedy of the bigamist murderer, it cannot be denied that both divisions of the subject are effectively treated, while the more important part of the task fell to the share of Ford. Yet it may be doubted whether any such division can be safely assumed; and it may suffice to repeat that no domestic tragedy has ever taught with more effective simplicity and thrilling truthfulness the homely double lesson of the folly of selfishness and the mad rashness of crime.

With Dekker Ford also wrote the mask of *The Sun's Darling*; or, as seems most probable, they founded this production upon *Phaeton*, an earlier mask, of which Dekker had been sole author. Gifford holds that Dekker's hand is perpetually traceable in the first three acts of *The Sun's Darling*, and through the whole of its comic part, but that the last two acts are mainly Ford's. If so, he is the author of the rather forced occasional tribute on the accession of King Charles I., of which the last act largely consists. This mask, which furnished abundant opportunities for the decorators, musicians and dancers, in showing forth how the seasons and their delights are successively exhausted by a "wanton darling," Ray-bright the grandchild of the Sun, is said to have been very popular. It is at the same time commonplace enough in conception; but there is much that is charming in the descriptions, Jonson and Lyly being respectively laid under contribution in the course of the dialogue, and in one of the incidental lyrics.

Ford owes his position among English dramatists to the intensity of his passion, in particular scenes and passages where the character, the author and the reader are alike lost in the situation and in the sentiment evoked by it; and this gift is a supreme dramatic gift. But his plays—with the exception of *The Witch of Edmonton*, in which he doubtless had a prominent share—too often disturb the mind like a bad dream which ends as an unsolved dissonance; and this defect is a supreme dramatic defect. It is not the rigid or the stolid who have the most reason to complain of the insufficiency of tragic poetry such as Ford's; nor is it that morality only which, as Ithocles says in *The Broken Heart*, "is formed of books and school-traditions," which has a right to protest against the final effect of the most powerful creations of his genius. There is a morality which both

"Keeps the soul in tune,
At whose sweet music all our actions dance,"
and is able to physic

"The sickness of a mind
Broken with griefs."

Of that morality—or of that deference to the binding power within man and the ruling power above him—tragedy is the truest expounder, even when it illustrates by contrasts; but the tragic poet who merely places the problem before us, and bids us stand aghast with him at its cruelty, is not to be reckoned among the great masters of a divine art.

BIBLIOGRAPHY.—The best edition of Ford is that by Gifford, with notes and introduction, revised with additions to both text and notes by Alexander Dyce (1869). An edition of the *Dramatic Works of Massinger and Ford* appeared in 1840, with an introduction by Hartley Coleridge. The *Best Plays of Ford* were edited for the "Mermaid Series" in 1888, with an introduction by W. H. Havelock Ellis, and reissued in 1903. A. C. Swinburne's "Essay on Ford" is reprinted among his *Essays and Studies* (1875). *Perkin Warbeck* and *'Tis Pity* were translated into German by F. Bodenstedt in 1860; and the latter again by F. Blei in 1904. The probable sources of the various plays are discussed in Emil Koeppel's *Quellenstudien zu den Dramen George Chapman's, Philip Massinger's und John Ford's* (1897). (A. W. W.)

FORD, RICHARD (1796–1858), English author of one of the earliest and best of travellers' *Handbooks*, was the eldest son of Sir Richard Ford, who in 1789 was member of parliament for East Grinstead, and for many years afterwards chief police magistrate of London. His mother was the daughter and heiress of Benjamin Booth, a distinguished connoisseur in art. He was called to the bar, but never practised, and in 1830–1833 he travelled in Spain, spending much of his time in the Alhambra and at Seville. His first literary work (other than contributions to the *Quarterly Review*) was a pamphlet, *An Historical Inquiry into the Unchangeable Character of a War in Spain* (Murray, 1837), in reply to one called the *Policy of England towards Spain*, issued under the patronage of Lord Palmerston. He spent the winter of 1839–1840 in Italy, where he added largely to his collection of majolica; and soon after his return he began, at John Murray's invitation, to write his *Handbook for Travellers in Spain*, with which his name is chiefly associated. He died on the 1st of September 1858, leaving a fine private collection of pictures to his widow (d. 1910), his third wife, a daughter of Sir A. Molesworth.

FORD, THOMAS (b. c. 1580), English musician, of whose life little more is known than that he was attached to the court of Prince Henry, son of James I. His works also are few, but they are sufficient to show the high stage of efficiency and musical knowledge which the English school had attained at the beginning of the 17th century. They consist of canons and other concerted pieces of vocal music, mostly with lute accompaniment. The chief collection of his works is entitled *Musike of Sundrie Kinds set forth in Two Books*, &c. (1607), and the histories of music by Burney and Hawkins give specimens of his art. Together with Dowland, immortalized in one of Shakespeare's sonnets, Ford is the chief representative of the school which preceded Henry Lawes.

FORDE, FRANCIS (d. 1770), British soldier, first appears in the army list as a captain in the 39th Foot in 1746. This regiment was the first of the king's service to serve in India (hence its motto *Primus in Indis*), and Forde was on duty there when in 1755 he became major, at the same time as Eyre Coote, soon to become his rival, was promoted captain. At the express invitation of Clive, Forde resigned his king's commission to take the post of second in command of the E.I. Company's troops in Bengal. Soon after Plassey, Forde was sent against the French of Masulipatam. Though feebly supported by the motley rabble of an army which Anandraz, the local ally, brought into the field, Forde pushed ahead through difficult country and came upon the enemy entrenched at Condore. For four days the two armies faced one another; on the fifth both commanders resolved on the offensive and an encounter ensued. In spite of the want of spirit shown by Anandraz and his men, Forde in the end succeeded in winning the battle, which was from first to last a brilliant piece of work. Nor did he content himself with this; on the same evening he stormed the French camp, and his pursuit was checked only by the guns of Masulipatam itself. The place was quickly invested on the land side, but difficulties crowded upon Forde and his handful of men. For fifty days little advance was made; then Forde, seeing the last avenues of escape closing behind him, ordered an assault at midnight on the 25th of January 1759. The Company's troops lost one-third of their number, but the storm was a brilliant and astounding success. Forde received less than no reward. The Company refused to confirm his lieutenant-colonel's commission,

and he found himself junior to Eyre Coote, his old subaltern in the 39th Foot. Nevertheless he continued to assist Clive, and on the 25th of November 1759 won a success comparable to Condore at Chinsurah (or Biderra) against the Dutch. A year later he at last received his commission, but was still opposed by a faction of the directors which supported Coote. Clive himself warmly supported Forde in these quarrels. In 1769, with Vansittart and Scrafton, Colonel Forde was sent out with full powers to investigate every detail of Indian administration. Their ship was never heard of after leaving the Cape of Good Hope on the 27th of December.

Monographs on Condore, Masulipatam and Chinsurah will be found in Malleson's *Decisive Battles of India*.

FORDHAM, formerly a village of Westchester county, New York, U.S.A., and now a part of New York City. It lies on the mainland, along the eastern bank of the Harlem river, E. of the northern end of Manhattan Island. It is the seat of Fordham University (Roman Catholic), founded in 1841 as St John's College, and since 1846 conducted by the Society of Jesus. In 1907 the institution was rechartered as Fordham University, and now includes St John's College high school and grammar school, St John's College, the Fordham University medical school (all in Fordham), and the Fordham University law school (42 Broadway, New York City). In 1907–1908 the university had 96 instructors and (exclusive of 364 students in the high school) 236 students, of whom 105 were in St John's College, 31 in the medical school, and 100 in the law school. In Fordham still stands the house in which Edgar Allan Poe lived from 1844 to 1849 and in which he wrote "Annabel Lee," "Ulalume," &c.

The hamlet of Fordham was established in 1669 by Jan Archer (a Dutchman, who called himself "John Archer" after coming to America), who in that year received permission from Francis Lovelace, colonial governor of New York, to settle sixteen families on the mainland close by a fording-place of the Spuyten Duyvil Creek, near where that stream enters the Harlem river. Between 1655 and 1671 Archer bought from the Indians the tract of land lying between Spuyten Duyvil Creek and the Harlem river on the east and the Bronx river on the west, and extending from the hamlet of Fordham to what is now High Bridge. In 1671 Governor Lovelace erected this tract into the manor of Fordham. In 1846 it was included with Morrisania in the township of West Farms; and in 1872 with part of the township of Yonkers was erected into the township of Kingsbridge, which in 1874 was annexed to the city of New York, and in 1898 became a part of the borough of the Bronx, New York City.

FORDUN, JOHN OF (d. c. 1384), Scottish chronicler. The statement generally made that the chronicler was born at Fordoun (Kincardineshire) has not been supported by any direct evidence. It is certain that he was a secular priest, and that he composed his history in the latter part of the 14th century; and it is probable that he was a chaplain in the cathedral of Aberdeen. The work of Fordun is the earliest attempt to write a continuous history of Scotland. We are informed that Fordun's patriotic zeal was roused by the removal or destruction of many national records by Edward III. and that he travelled in England and Ireland, collecting material for his history. This work is divided into five books. The first three are almost entirely fabulous, and form the groundwork on which Boece and Buchanan afterwards based their historical fictions, which were exposed by Thomas Innes in his *Critical Essay* (i. pp. 201–214). The 4th and 5th books, though still mixed with fable, contain much valuable information, and become more authentic the more nearly they approach the author's own time. The 5th book concludes with the death of King David I. in 1153. Besides these five books, Fordun wrote part of another book, and collected materials for bringing down the history to a later period. These materials were used by a continuator who wrote in the middle of the 15th century, and who is identified with Walter Bower (*q.v.*), abbot of the monastery of Inchcolm. The additions of Bower form eleven books, and bring down the narrative to the death of King James I. in 1437. According

to the custom of the time, the continuator did not hesitate to interpolate Fordun's portion of the work with additions of his own, and the whole history thus compiled is known as the *Scotichronicon*.

The first printed edition of Fordun's work was that of Thomas Gale in his *Scriptores quindecim* (vol. iii.), which was published in 1691. This was followed by Thomas Hearne's (5 vols.) edition in 1722. The whole work, including Bower's continuation, was published by Walter Goodall at Edinburgh in 1759. In 1871 and 1872 Fordun's chronicle, in the original Latin and in an English translation, was edited by William F. Skene in *The Historians of Scotland*. The preface to this edition collects all the biographical details and gives full bibliographical references to MSS. and editions.

FORECLOSURE, in the law of mortgage, the extinguishment by order of the court of a mortgagor's equity of redemption. In the law of equity the object of every mortgage transaction is eventually the repayment of a debt, the mortgaged property being incidental by way of security. Therefore, although the day named for repayment of the loan has passed and the mortgagor's estate is consequently forfeited, equity steps in to mitigate the harshness of the common law, and will decree a reconveyance of the mortgaged property on payment of the principal, interest and costs. This right of the mortgagor to relief is termed his "equity of redemption." But the right must be exercised within a reasonable time, otherwise he will be foreclosed his equity of redemption and the mortgagee's possession converted into an absolute ownership. Such foreclosure is enforced in equity by a foreclosure action. An action is brought by the mortgagee against the mortgagor in the chancery division of the High Court in England, claiming that an account may be taken of the principal and interest due to the mortgagee, and that the mortgagor may be directed to pay the same, with costs, by a day to be appointed by the court and that in default thereof he may be foreclosed his equity of redemption. English county courts have jurisdiction in foreclosure actions where the mortgage or charge does not exceed £500, or where the mortgage is for more than £500, but less than that sum has been actually advanced. In a Welsh mortgage there is no right to foreclosure. (See also MORTGAGE.)

FOREIGN OFFICE, that department of the executive of the United Kingdom which is concerned with foreign affairs. The head of the Foreign Office is termed principal secretary of state for foreign affairs and his office dates from 1782. Between that date and the Revolution there had been only two secretaries of state, whose duties were divided by a geographical division of the globe into northern and southern departments. The duties of the secretary of the northern department of Europe comprised dealings with the northern powers of Europe, while the secretary of the southern department of Europe communicated with France, Spain, Portugal, Switzerland, Italy, Turkey, and also looked after Irish and colonial business, and carried out the work of the Home Office. In 1782 the duties of these two secretaries were revised, the northern department becoming the Foreign Office. The secretary for foreign affairs is the official agent of the crown in all communications between Great Britain and foreign powers; his intercourse is carried on either through the representatives of foreign states in Great Britain or through representatives of Great Britain abroad. He negotiates all treaties or alliances with foreign states, protects British subjects residing abroad, and demands satisfaction for any injuries they may sustain at the hands of foreigners. He is assisted by two under-secretaries of state (one of them a politician, the other a permanent civil servant), three assistant under-secretaries (civil servants), a librarian, a head of the treaty department and a staff of clerks. The departments of the Foreign Office are the African, American, commercial and sanitary, consular, eastern (Europe), far eastern, western (Europe), parliamentary, financial, librarian and keeper of the papers, treaties and registry. In the case of important despatches and correspondence, these, with the drafts of answers, are sent first to the permanent under-secretary, then to the prime minister, then to the sovereign and, lastly, are circulated among the members of the cabinet. The salary of the secretary for foreign affairs is £5000 per annum,

that of the permanent under-secretary £2000, the parliamentary under-secretary and the first assistant under-secretary, £1500, and the other assistant under-secretaries £1200.

See Anson, *Law and Custom of the Constitution*, part ii.

FORELAND, NORTH and SOUTH, two chalk headlands on the Kent coast of England, overlooking the Strait of Dover, the North Foreland forming the eastern projection of the Isle of Thanet, and the South standing 3 m. N.E. of Dover. Both present bold cliffs to the sea, and command beautiful views over the strait. On the North Foreland (51° 22½' N., 1° 27' E.) there is a lighthouse, and on the South Foreland (51° 8½' N., 1° 23' E.) there are two. There is also a Foreland on the north coast of Devonshire, 2½ m. N.E. of Lynmouth, a fine projection of the highlands of Exmoor Forest, overlooking the Bristol Channel, and forming the most northerly point of the county.

FORESHORE, that part of the seashore which lies between high- and low-water mark at ordinary tides. In the United Kingdom it is ordinarily and prima facie vested in the crown, except where it may be vested in a subject by ancient grant or charter from the crown, or by prescription. Although numerous decisions, dating from 1795, have confirmed the prima facie title of the crown, S. A. Moore in his *History of the Foreshore* contends that the presumption is in favour of the subject rather than of the crown. But a subject can establish a title by proving an express grant from the crown or giving sufficient evidence of user from which a grant may be presumed. The chief acts showing title to foreshore are, taking wreck or royal fish, right of fishing, mining, digging and taking sand, seaweed, &c., embanking and enclosing. There is a public right of user in that part of the foreshore which belongs to the crown, for the purpose of navigation or fishery, but there is no right of passage over lands adjacent to the shore, except by a particular custom. So that, in order to make the right available, there must be a highway or other public land giving access to the foreshore. Thus it has been held that the public have no legal right to trespass on land above high-water mark for the purpose of bathing in the sea, though if they can get to it they may bathe there (*Blundell v. Catteral*, 1821, 5 B. & Ad. 268). There is no right in the public to take sand, shells or seaweed from the shore, nor, except in certain places by local custom, have fishermen the right to use the foreshore or the soil above it for drawing up their boats, or for drying their nets or similar purposes.

See S. A. Moore, *History of the Foreshore and the Law relating thereto* (1888); Coulson and Forbes, *Law of Waters* (1902).

FORESTALLING, in English criminal law, the offence of buying merchandise, victual, &c., coming to market, or making any bargain for buying the same, before they shall be in the market ready to be sold, or making any motion for enhancing the price, or dissuading any person from coming to market or forbearing to bring any of the things to market, &c. See ENGRESSING.

FOREST LAWS, the general term for the old English restriction laws, dealing with forests. One of the most cherished prerogatives of the king of England, at the time when his power was at the highest, was that of converting any portion of the country into a forest in which he might enjoy the pleasures of the chase. The earliest struggles between the king and the people testify to the extent to which this prerogative became a public grievance, and the charter by which its exercise was bounded (*Carta de Foresta*) was in substance part of the greatest constitutional code imposed by his barons upon King John. At common law it appears to have been the right of the king to make a forest where he pleased, provided that certain legal formalities were observed. The king having a continual care for the preservation of the realm, and for the peace and quiet of his subjects, he had therefore amongst many privileges this prerogative, viz. to have his place of recreation wheresoever he would appoint.¹ Land once afforested became subject to a peculiar system of laws, which, as well as the formalities required to constitute a valid afforestation, have been carefully ascertained by the Anglo-Norman lawyers. "A forest,"

¹ Coke, 4 *Inst.*, 300.

says Manwood, "is a certain territory of woody grounds and fruitful pastures, privileged for wild beasts and fowls of forest, chase, and warren to rest, and abide there in the safe protection of the king, for his delight and pleasure; which territory of ground so privileged is mered and bounded with unremovable marks, meres and boundaries, either known by matter of record or by prescription; and also replenished with wild beasts of venery or chase, and with great coverts of vert, for the succour of the said beasts there to abide: for the preservation and continuance of which said place, together with the vert and venison there are particular officers, laws, and privileges belonging to the same, requisite for that purpose, and proper only to a forest and to no other place."¹ And the same author distinguishes a forest, as "the highest franchise of princely pleasure," from the inferior franchises of chase, park and warren—named in the order of their importance. The forest embraces all these, and it is distinguished by having laws and courts of its own, according to which offenders are justiciable. An offender in a chase is to be punished by the common law; an offender in a forest by the forest law. A chase is much the same as a park, only the latter is enclosed, and all of them are distinguished according to the class of wild beasts to which the privilege extended. Thus beasts of forest (the "five wild beasts of venery") were the hart, the hind, the hare, the boar and the wolf. The beasts of chase were also five, viz. the buck, the doe, the fox, the marten and the roc. The beasts and fowls of warren were the hare, the coney, the pheasant and the partridge.

The courts of the forest were three in number, viz. the court of attachments, swainmote and justice-seat. The court of attachments (called also the wood-mote) is held every forty days for the foresters to bring in their attachments concerning any hurt done to vert or venison (*in viridi et venatione*) in the forest, and for the verderers to receive and mark the same, but no conviction takes place. The swainmote, held three times in the year, is the court to which all the freeholders within the forest owe suit and service, and of which the verderers are the judges. In this court all offences against the forest laws may be tried, but no judgment or punishment follows. This is reserved for the justice-seat, held every third year, to which the rolls of offences presented at the court of attachment, and tried at the swainmote, are presented by verderers. The justice-seat is the court of the chief justice in eyre, who, says Coke, "is commonly a man of greater dignity than knowledge of the laws of the forests; and therefore where justice-seats are to be held some other persons whom the king shall appoint are associated with him, who together are to determine *omnia placita forestae*." There were two chief justices for the forests *intra* and *ultra Trentam* respectively. The necessary officers of a forest are a steward, verderers, foresters, regards, agisters and woodwards. The verderer was a judicial officer chosen in full county by the freeholders in the same manner as the coroner. His office was to view and receive the attachments of the foresters, and to mark them on his rolls. A forester was "an officer sworn to preserve the vert and venison in the forest, and to attend upon the wild beasts within his bailiwick." The regards were of the nature of visitors: their duty was to make a regard (*visitatio nemorum*) every third year, to inquire of all offences, and of the concealment of such offences by any officer of the forest. The business of the agister was to look after the pasturage of the forest, and to receive the payments for the same by persons entitled to pasture their cattle in the forests. Both the pasturage and the payment were called "agistment." The woodward was the officer who had the care of the woods and vert and presented offences at the court of attachment.

The legal conception of a forest was thus that of a definite territory within which the code of the forest law prevailed to the exclusion of the common law. The ownership of the soil might be in any one, but the rights of the proprietor were limited by the laws made for the protection of the king's wild beasts. These laws, enforced by fines often arbitrary and excessive, were a great grievance to the unfortunate owners of land within or

in the neighbourhood of the forest. The offence of "purpresture" may be cited as an example. This was an encroachment on the forest rights, by building a house within the forest, and it made no difference whether the land belonged to the builder or not. In either case it was an offence punishable by fines at discretion. And if a man converted woodlands within the forest into arable land, he was guilty of the offence known as "assarting," whether the covert belonged to himself or not.

The hardships of the forest laws under the Norman kings, and their extension to private estates by the process of afforestation, were among the grievances which united the barons and people against the king in the reign of John. The Great Charter of King John contains clauses relating to the forest laws, but no separate charter of the forest. The first charter of the forest is that of Henry III., issued in 1217. "As an important piece of legislation," said Stubbs,² "it must be compared with the forest assize of 1184, and with 44th, 47th and 48th clauses of the charter of John. It is observable that most of the abuses which are remedied by it are regarded as having sprung up since the accession of Henry II.; but the most offensive afforestations have been made under Richard and John. These latter are at once disafforested; but those of Henry II. only so far as they had been carried out to the injury of the landowners and outside of the royal demesne." Land which had thus been once forest land and was afterwards disafforested was known as *purlieu*—derived by Manwood from the French *pur* and *lieu*, i.e. "a place exempt from the forest." The forest laws still applied in a modified manner to the purlieu. The benefit of the disafforestation existed only for the owner of the lands; as to all other persons the land was forest still, and the king's wild beasts were to "have free recourse therein and safe return to the forest, without any hurt or destruction other than by the owners of the lands in the purlieu where they shall be found, and that only to hunt and chase them back again towards the forest without any forestalling" (Manwood, *On the Forest Laws*—article "Purlieu").

The revival of the forest laws was one of the means resorted to by Charles I. for raising a revenue independently of parliament, and the royal forests in Essex were so enlarged that they were hyperbolically said to include the whole county. The 4th earl of Southampton was nearly ruined by a decision that stripped him of his estate near the New Forest. The boundaries of Rockingham Forest were increased from 6 m. to 60, and enormous fines imposed on the trespassers,—Lord Salisbury being assessed in £20,000, Lord Westmoreland in £19,000, Sir Christopher Hatton in £12,000 (Hallam's *Constitutional History of England*, c. viii.). By the statute 16 Charles I. c. 16 (1640) the royal forests were determined for ever according to their boundaries in the twentieth year of James, all subsequent enlargements being annulled.

The forest laws, since the Revolution, have fallen into complete disuse.

FORESTS AND FORESTRY. Although most people know what a forest (Lat. *foris*, "out of doors") is, a definition of it which suits all cases is by no means easy to give. Manwood, in his treatise of the *Laws of the Forest* (1598), defines a forest as "a certain territory of woody grounds, fruitful pastures, privileged for wild beasts and fowls of forest, chase and warren, to rest and abide in, in the safe protection of the king, for his princely delight and pleasure." This primitive definition has, in modern times, when the economic aspect of forests came more into the foreground, given place to others, so that forest may, in a general way, now be described as "an area which is for the most part set aside for the production of timber and other forest produce, or which is expected to exercise certain climatic effects, or to protect the locality against injurious influences."

As far as conclusions can now be drawn, it is probable that the greater part of the dry land of the earth was, at some time, covered with forest, which consisted of a variety of trees and shrubs grouped according to climate, soil and configuration of the several localities. When the old trees reached their limit

¹ Manwood's *Treatise of the Forest Laws* (4th edition, 1717).

² *Documents Illustrative of English History*, p. 338.

of life, they disappeared, and younger trees took their place. The conditions for an uninterrupted regeneration of the forest were favourable, and the result was vigorous production by the creative powers of soil and climate. Then came man, and by degrees interfered, until in most countries of the earth the area under forest has been considerably reduced. The first decided interference was probably due to the establishment of domestic animals; men burnt the forest to obtain pasture for their flocks. Subsequently similar measures on an ever-increasing scale were employed to prepare the land for agricultural purposes. More recently enormous areas of forests were destroyed by reckless cutting and subsequent firing in the extraction of timber for economic purposes.

It will readily be understood that the distribution and character of the now remaining forests must differ enormously (see PLANTS: *Distribution*). Large portions of the earth are still covered with dense masses of tall trees, while others contain low scrub or grass land, or are desert. As a general rule, natural forests consist of a number of different species intermixed; but in some cases certain species, called gregarious, have succeeded in obtaining the upper hand, thus forming more or less pure forests of one species only. The number of species differs very much. In many tropical forests hundreds of species may be found on a comparatively small area, in other cases the number is limited. Burma has several thousand species of trees and shrubs, Sind has only ten species of trees. Central Europe has about forty species, and the greater part of northern Russia, Sweden and Norway contains forests consisting of about half a dozen species. Elevation above the sea acts similarly to rising latitude, but the effect is much more rapidly produced. Generally speaking, it may be said that the Tropics and adjoining parts of the earth, wherever the climate is not modified by considerable elevation, contain broad-leaved species, palms, bamboos, &c. Here most of the best and hardest timbers are found, such as teak, mahogany and ebony. The northern countries are rich in conifers. Taking a section from Central Africa to North Europe, it will be found that south and north of the equator there is a large belt of dense hardwood forest; then comes the Sahara, then the coast of the Mediterranean with forests of cork oak; then Italy with oak, olive, chestnut, gradually giving place to ash, sycamore, beech, birch and certain species of pine; in Switzerland and Germany silver fir and spruce gain ground. Silver fir disappears in central Germany, and the countries around the Baltic contain forests consisting chiefly of Scotch pine, spruce and birch, to which, in Siberia, larch must be added, while the lower parts of the ground are stocked with hornbeam, willow, alder and poplar. In North America the distribution is as follows: Tropical vegetation is found in south Florida, while in north Florida it changes into a subtropical vegetation consisting of evergreen broad-leaved species with pines on sandy soils. On going north in the Atlantic region, the forest becomes temperate, containing deciduous broad-leaved trees and pines, until Canada is reached, where larches, spruces and firs occupy the ground. Around the great lakes on sandy soils the broad-leaved forest gives way to pines. On proceeding west from the Atlantic region the forest changes into a shrubby vegetation, and this into the prairies. Farther west, towards the Pacific coast, extensive forests are found consisting, according to latitude and elevation above the sea, of pines, larches, fir, Thujas and Tsugas. In Japan a tropical vegetation is found in the south, comprising palms, figs, ehony, mangrove and others. This is followed on proceeding north by subtropical forests containing evergreen oaks, *Podocarpus*, tree-ferns, and, at higher elevations, *Cryptomeria* and *Chamaecyparis*. Then follow deciduous broad-leaved forests, and finally firs, spruces and larches. In India the character of the forests is governed chiefly by rainfall and elevation. Where the former is heavy evergreen forests of Guttiferae, Dipterocarpeae, Leguminosae, Euphorbias, figs, palms, ferns, bamboos and india-rubber trees are found. Under a less copious rainfall deciduous forests appear, containing teak and sal (*Shorea robusta*) and a great variety of other valuable trees. Under a still smaller rainfall the vegetation becomes sparse,

containing acacias, *Dalbergia sissoo* and Tamarix. Where the rainfall is very light or *nil*, desert appears. In the Himalayas, subtropical to arctic conditions are found, the forests containing, according to elevation, pines, firs, deodars, oaks, chestnuts, magnolias, laurels, rhododendrons and bamboos. Australia, again, has its own particular flora of eucalypts, of which some two hundred species have been distinguished, as well as wattles. Some of the eucalypts attain an enormous height.

Utility of Forests.—In the economy of man and of nature forests are of direct and indirect value, the former chiefly through the produce which they yield, and the latter through the influence which they exercise upon climate, the regulation of moisture, the stability of the soil, the healthiness and beauty of a country and allied subjects. The *indirect* utility will be dealt with first. A piece of land bare of vegetation is, throughout the year, exposed to the full effect of sun and air currents, and the climatic conditions which are produced by these agencies. If, on the other hand, a piece of land is covered with a growth of plants, and especially with a dense crop of forest vegetation, it enjoys the benefit of certain agencies which modify the effect of sun and wind on the soil and the adjoining layers of air. These modifying agencies are as follows: (1) The crowns of the trees intercept the rays of the sun and the falling rain; they obstruct the movement of air currents, and reduce radiation at night. (2) The leaves, flowers and fruits, augmented by certain plants which grow in the shade of the trees, form a layer of mould, or humus, which protects the soil against rapid changes of temperature, and greatly influences the movement of water in it. (3) The roots of the trees penetrate into the soil in all directions, and bind it together. The effects of these agencies have been observed from ancient times, and widely differing views have been taken of them. Of late years, however, more careful observations have been made at so-called parallel stations, that is to say, one station in the middle of a forest, and another outside at some distance from its edge, but otherwise exposed to the same general conditions. In this way, the following results have been obtained: (1) Forests reduce the temperature of the air and soil to a moderate extent, and render the climate more equable. (2) They increase the relative humidity of the air, and reduce evaporation. (3) They tend to increase the precipitation of moisture. As regards the actual rainfall, their effect in low lands is *nil* or very small; in hilly countries it is probably greater, but definite results have not yet been obtained owing to the difficulty of separating the effect of forests from that of other factors. (4) They help to regulate the water supply, produce a more sustained feeding of springs, tend to reduce violent floods, and render the flow of water in rivers more continuous. (5) They assist in preventing denudation, erosion, landslips, avalanches, the silting up of rivers and low lands and the formation of sand dunes. (6) They reduce the velocity of air-currents, protect adjoining fields against cold or dry winds, and afford shelter to cattle, game and useful birds. (7) They may, under certain conditions, improve the healthiness of a country, and help in its defence. (8) They increase the beauty of a country, and produce a healthy aesthetic influence upon the people.

The *direct* utility of forests is chiefly due to their produce, the capital which they represent, and the work which they provide. The principal produce of forests consists of timber and firewood. Both are necessities for the daily life of the people. Apart from a limited number of broad-leaved species, the conifers have become the most important timber trees in the economy of man. They are found in greatest quantities in the countries around the Baltic and in North America. In modern times iron and other materials have, to a considerable extent, replaced timber, while coal, lignite, and peat compete with firewood; nevertheless wood is still indispensable, and likely to remain so. This is borne out by the statistics of the most civilized nations. Whereas the population of Great Britain and Ireland, during the period 1880-1900, increased by about 20%, the imports of timber, during the same period, increased by 45%; in other words, every head of population in 1900 used more timber than

twenty years earlier. Germany produced in 1880 about as much timber as she required; in 1899 she imported 4,600,000 tons, valued at £14,000,000, and her imports are rapidly increasing, although the yield capacity of her own forests is much higher now than it was formerly. Wood is now used for many purposes which formerly were not thought of. The manufacture of the wood pulp annually imported into Britain consumes at least 2,000,000 tons of timber. A fabric closely resembling silk is now made of spruce wood. The variety of other, or minor, produce yielded by forests is very great, and much of it is essential for the well-being of the people and for various industries. The yield of fodder is of the utmost importance in countries subject to periodic droughts; in many places field crops could not be grown successfully without the leaf-mould and brushwood taken from the forests. As regards industries, attention need only be drawn to such articles as commercial fibre, tanning materials, dye-stuffs, lac, turpentine, resin, rubber, gutta-percha, &c. Great Britain and Ireland alone import every year such materials to the value of £12,000,000, half of this being represented by rubber.

The capital employed in forests consists chiefly of the value of the soil and growing stock of timber. The latter is, ordinarily, of much greater value than the former wherever a sustained annual yield of timber is expected from a forest. In the case of a Scotch pine forest, for instance, the value of the growing stock is, under the above-mentioned condition, from three to five times that of the soil. The rate of interest yielded by capital invested in forests differs, of course, considerably according to circumstances, but on the whole it may, under proper management, be placed equal to that yielded by agricultural land; it is lower than the agricultural rate on the better classes of land, but higher on the inferior classes. Hence the latter are specially indicated for the forest industry, and the former for the production of agricultural crops. Forests require labour in a great variety of ways, such as (1) general administration, formation, tending and harvesting; (2) transport of produce; and (3) industries which depend on forests for their prime material. The labour indicated under the first head differs considerably according to circumstances, but its amount is smaller than that required if the land is used for agriculture. Hence forests provide additional labour only if they are established on surplus lands. Owing to the bulky nature of forest produce its transport forms a business of considerable magnitude, the amount of labour being perhaps equal to half that employed under the first head. The greatest amount of labour is, however, required in the working up of the raw material yielded by forests. In this respect attention may be drawn to the chair industry in and around High Wycombe in Buckinghamshire, where more than 20,000 workmen are employed in converting the beech, grown on the adjoining chalk hills, into chairs and tools of many patterns. Complete statistics for Great Britain are not available under this head, but it may be mentioned that in Germany the people employed in the forests amount to 2.3 % of the total population; those employed on transport of forest produce 1.1 %; labourers employed on the various wood industries, 8.6 %; or a total of 12 %. An important feature of the work connected with forests and their produce is that a great part of it can be made to fit in with the requirements of agriculture; that is to say, it can be done at seasons when field crops do not require attention. Thus the rural labourers or small farmers can earn some money at times when they have nothing else to do, and when they would probably sit idle if no forest work were obtainable.

Whether, or how far, the utility of forests is brought out in a particular country depends on its special conditions, such as (1) the position of a country, its communications, and the control which it exercises over other countries, such as colonies; (2) the quantity and quality of substitutes for forest produce available in the country; (3) the value of land and labour, and the returns which land yields if used for other purposes; (4) the density of population; (5) the amount of capital available for investment; (6) the climate and configuration, especially

the geographical position, whether inland or on the border of the sea, &c. No general rule can be laid down, showing whether forests are required in a country, or, if so, to what extent; that question must be answered according to the special circumstances of each case.

The subjoined table shows the forests of various European states:—

Countries.	Area of Forests, in Acres.	Percentage of Total Area of Country under Forest.	Percentage of Forest Area belonging to the State.	Forest Area per Head of Population, in Acres.
Sweden	49,000,000	48	33	9.5
Norway	17,000,000	21	28	7.6
Russia, including Finland	518,000,000	40	61	5.9
Bosnia and Herzegovina	6,400,000	50	78	4.0
Bulgaria	7,600,000	30	30	2.3
Turkey	11,200,000	20	..	1.7
Servia	3,900,000	32	37	1.5
Rumania	6,400,000	18	40	1.3
Spain	21,200,000	17	84	1.2
Hungary	22,500,000	28	15	1.2
Austria	24,000,000	32	7	.9
Greece	2,000,000	13	80	.85
Luxemburg	200,000	30	..	.82
Switzerland	2,100,000	20	5	.7
Germany	35,000,000	26	34	.6
France	24,000,000	18	12	.6
Italy	10,400,000	15	4	.3
Denmark	600,000	6	24	.25
Belgium	1,300,000	18	5	.2
Portugal	770,000	3.5	8	.15
Holland	560,000	7	?	.1
Great Britain	3,000,000	4	3	.07

These data exhibit considerable differences, since the percentage of the forest area varies from 3.5 to 50, and the area per head of population from .07 to 9.5 acres. Russia, Sweden and Norway may as yet have more forest than they require for their own population. On the other hand, Great Britain and Ireland, Germany, Denmark, Portugal, Holland, and even Belgium, France and Italy have not a sufficient forest area to meet their own requirements; at the same time, they are all sea-bound countries, and importation is easy, while most of them are under the influence of moist sea winds, which reduces to a subordinate position the importance of forests for climatic reasons.

Intimately connected with the area of forests in a country is the state of ownership—whether they belong to the state, corporations or to private persons. Where, apart from the financial aspect and the supply of work, forests are not required for the sake of their indirect effects, and where importation from the other countries is easy and assured, the government of the country need not, as a rule, trouble itself to maintain or acquire forests. Where the reverse conditions exist, and especially where the cost of transport over long distances becomes prohibitive, a wise administration will take measures to assure the maintenance of a suitable proportion of the country under forest. This can be done either by maintaining or constituting a suitable area of state forests, or by exercising a certain amount of control over corporation and even private forests. Such measures are more called for in continental countries than in those which are sea-bound, as is proved by the above statistics.

Supply of Timber—Imports and Exports.—The following table shows the net imports and exports of European countries (average data, calculated from the returns of recent years).

The only timber-exporting countries of Europe are Russia, Sweden, Norway, Austria-Hungary and Rumania; all the others either have only enough for their own consumption, or import timber. Great Britain and Ireland import now upwards of 10,000,000 tons a year, Germany about 4,600,000 tons, and

Belgium about 1,300,000 tons. Holland, France, Portugal, Spain and Italy are all importing countries, as also are Asia Minor, Egypt and Algeria. The west coast of Africa exports hardwoods, and imports coniferous timber. The Cape and Natal import considerable quantities of pine and fir wood. Australasia

Net Imports and Exports of European Countries.

Countries.	Quantities in Tons.		Value in £ Sterling.	
	Imports.	Exports.	Imports.	Exports.
United Kingdom . . .	10,004,000	..	26,540,000	..
Germany	4,600,000	..	14,820,000	..
Belgium	1,300,000	..	5,040,000	..
France	1,230,000	..	3,950,000	..
Italy	620,000	..	2,100,000	..
Spain	470,000	..	1,500,000	..
Denmark	470,000	..	1,250,000	..
Switzerland	204,000	..	480,000	..
Holland	180,000	..	720,000	..
Servia	110,000	..	160,000	..
Portugal	60,000	..	200,000	..
Greece	35,000	..	130,000	..
Rumania	400,000	..	840,000
Norway	1,300,000	..	2,200,000
Austria - Hungary with Bosnia and Herzegovina	3,996,000	..	11,400,000
Sweden	4,460,000	..	7,930,000
Russia with Fin- land	6,890,000	..	10,440,000
Total	19,283,000	17,046,000	56,890,000	32,810,000
Net Imports	2,237,000		24,080,000	

These net imports are received from non-European countries. They consist chiefly of valuable hardwoods, like teak, mahogany, eucalypts and others.

exports hardwoods and some Kauri pine from New Zealand, but imports larger quantities of light pine and fir timber. British India and Siam export teak and small quantities of fancy woods. The West Indies and South America export hardwoods, and import pine and fir wood. The United States of America will not much longer be a genuine exporting country, since they import already almost as much timber from Canada as they export. Canada exports considerable quantities of timber. The Dominion has still a forest area of 1,250,000 sq. m., equal to 38 % of the total area, and giving 165 acres of forest for every inhabitant. Although only about one-third of the forest area can be called regular timber land, Canada possesses an enormous forest wealth, with which she might supply permanently nearly all other countries deficient in material, if the governing bodies in the several provinces would only determine to stop the present fearful waste caused by axe and fire, and to introduce a regular system of management. As matters stand, the supplies of the most valuable timber of Canada, the white or Weymouth pine (*Pinus strobus*), are nearly exhausted, the great stores of spruce in the eastern provinces are being rapidly destroyed, and the forests of Douglas fir in the western provinces have been attacked for export to the United States and to other countries.

Taking the remaining stocks of the whole earth together, it may be said that a sufficient quantity of hardwoods is available, but the only countries which are able to supply coniferous timber for export on a considerable scale are Russia, Sweden, Norway, Austria and Canada. As these countries have practically to supply the rest of the world, and as the management of their forests is far from satisfactory, the question of supplying light pine and fir timber, which forms the very staff of life of the wood industries, must become a very serious matter before many years have passed. Unmistakable signs of the coming crisis are everywhere visible to all who wish to see, and it is difficult to over-state the gravity of the problem, when it is remembered, for instance, that 87 % of all the timber imported into Great Britain consists of light pine and fir, and that most of the other importing countries are similarly situated. In some of these countries little or no room exists for the extension of woodland, but this statement does not apply to Great Britain and Ireland, which

contain upwards of 12,000,000 acres of waste land, and 12,500,000 acres of mountain and heath land used for light grazing. One-fourth of that area, if put under forest, would produce all the timber now imported which can be grown in Britain, that is to say, about 95 % of the total.

The subjoined table shows the movements of timber within the greater part of the British empire:—

Net Imports and Exports into and from the British Empire.

Countries.	Annual Average during the Years 1884-1888.		Annual Average during the Years 1900-1903.	
	Net Imports.	Net Exports.	Net Imports.	Net Exports.
United Kingdom . . .	£ 15,000,000	£ ..	£ 26,540,000	£ ..
Australasia	1,284,000	..	568,000	..
Africa	72,000	..	737,000	..
West Indies, Honduras and Guiana	207,000	..	71,000
India, Ceylon and Mauritius	528,000	..	580,000
Dominion of Canada	4,025,000	..	4,789,000
Total	16,356,000	4,760,000	27,845,000	5,440,000
Net Imports	11,596,000	..	22,405,000	..
Total increase in 16 years	10,809,000	..
Average annual increase of net imports	675,562	..

Forest Management.—In early times there was practically no forest management. As long as the forests occupied considerable areas, their produce was looked upon as the free gift of nature, like air and water; men took it, used it, and even destroyed it without let or hindrance. With the gradual increase of population and the consequent reduction of the forest area, proprietary ideas developed; people claimed the ownership of certain forests, and proceeded to protect them against outsiders. Subsequently the law of the country was called in to help in protection, leading to the promulgation of special forest laws. By degrees it was found that mere protection was not sufficient, and that steps must be taken to enforce a more judicious treatment, as well as to limit the removal of timber to what the forests were capable of producing permanently. The teaching of natural science and of political economy was brought to bear upon the subject, so that now forestry has become a special science. This is recognized in many countries, amongst which Germany stands first, closely followed by France, Austria, Denmark and Belgium. Of non-European countries the palm belongs to British India, and then follow Ceylon, the Malay States, the Cape of Good Hope and Japan. The United States of America have also turned their attention to the subject. Most of the British colonies are, in this respect, as yet in a backward state, and the matter has still to be fought out in Great Britain and Ireland, though many writers have urged the importance of the question upon the public and the government. There can be no doubt that all civilized countries must, sooner or later, adopt a rational and systematic treatment of their forests.

For details as to the separate countries, see the articles under the country headings; in this article only some of the more important countries are dealt with, in so far as the history of their forestry is important. A few notes on Germany and France will be given, because in these countries forest management has been brought to highest perfection; Italy is mentioned, because she has allowed her forests to be destroyed; and a short description of forestry in the United Kingdom and in India follows. A separate section is devoted to the United States.

Germany is in general well-wooded. The winters being long and severe, an abundant supply of fuel is almost as essential as a sufficient supply of food. This necessity has led, along

with a passion for the chase, to the preservation of forests, and to the establishment of an admirable system of forest cultivation, almost as carefully conducted as field tillage. The Black Forest stretches the whole length of the grand-duchy of Baden and part of the kingdom of Württemberg, from the Neckar to Basel and the Lake of Constance. The vegetation resembles that of the Vosges; forests of spruce, silver fir, Scotch pine, and, mingled with birches, beech and oak, are the chief woods met with. Until comparatively recent times large quantities of timber derived from these forests were floated down the Rhine to Holland and also shipped to England. Now the greater part of it is used locally for construction, or it is converted into paper pulp. In the grand-duchy of Hesse the Odenwald range of mountains, stretching between the Main and the Neckar, contains the chief supply of timber. In the province of Nassau there are the large wooded tracts of the Taunus mountain range and the Westerwald.

In Rhenish Prussia valuable forests lie partly in the Eifel, on the borders of Belgium, and on the mountains overhanging the Upper Moselle, but they do not furnish such stately trees as the Black Forest and the Odenwald. The Spessart, near Aschaffenburg in Bavaria, is one of the most extensive forests of middle Germany, containing large masses of fine oak and beech, with plantations of coniferous trees, such as spruce, Scotch pine and silver fir. Bavaria possesses other fine forest tracts, such as the Baierischewald on the Bohemian frontier, the Kranzberg near Munich, and the Frankenwald in the north of the kingdom. North Germany has extensive forests on the Harz and Thuringian Mountains, while in East Prussia large tracts of flat ground are covered with Scotch pine, spruce, oak and beech.

Every German state has its forest organization. In Prussia the department is presided over by the Oberland Forstmeister at Berlin, while each province, or part of a province, has an Oberforstmeister, under whom a number of Oberförsters administer the state and communal forests. These, again, are assisted by a lower class of officials called Försters. The Oberförsters throughout Germany are educated at special schools of forestry, of which in 1909 the following nine existed:

In Prussia: at Eberswalde and Münden.

In Bavaria: at Munich and Aschaffenburg.

In Saxony: at Tharand.

In Württemberg: at Tübingen.

In Baden: at Karlsruhe.

In Hesse: at Giessen.

In the grand-duchy of Saxony: at Eisenach.

The schools at Munich, Tübingen and Giessen form part of the universities at these places; that at Karlsruhe is attached to the technical high school; the others are academies for the study of forestry only, but there is a tendency to transfer them all to the universities. The subordinate staff are trained for their work in so-called silvicultural schools, of which a large number exist. In this way the German forests have been brought to a high degree of productiveness, but the material derived from them falls far short of the requirements, although the forests occupy 26 % of the total area of the country; hence the net imports of timber amount already to 4,600,000 tons a year, and they are steadily rising.

France.—The principal timber tree of France is the oak. The cork oak is grown extensively in the south and in Corsica. The beech, ash, elm, maple, birch, walnut, chestnut and poplar are all important trees, while the silver fir and spruce form magnificent forests in the Vosges and Jura Mountains, and the Aleppo and maritime pines are cultivated in the south and south-west. About one-seventh of the entire territory is still covered with wood.

Forest legislation took its rise in France about the middle of the 16th century, and the great minister Sully urged the enforcement of restrictive forest laws. In 1669 a fixed treatment of state forests was enacted. Duhamel in 1755 published his famous work on forest trees. Reckless destruction of the forests, however, was in progress, and the Revolution of 1789 gave a fresh stimulus to the work of devastation. The usual results have followed in the frequency and destructiveness of floods, which have washed away the soil from the hillsides and valleys of many districts,

especially in the south, and the frequent inundations of the last fifty years are no doubt caused by the deforesting of the sources of the Rhone and Saône. Laws were passed in 1860 and 1864, providing for the reforesting, "*reboisement*," of the slopes of mountains, and these laws take effect on private as well as state property. Thousands of acres are annually planted in the departments of Hautes and Basses Alpes; and during the summer of 1875, when much injury was done by floods in the south of France, the Durance, formerly the most dangerous in this respect of French rivers, gave little cause for anxiety, as it is round the head waters of this river that the chief plantations have been formed. While tracts formerly covered with wood have been replanted, plantations have been formed on the shifting sands or dunes along the coast of Gascony. A forest of *Pinus pinaster*, 150 m. in length, now stretches from Bayonne to the mouth of the Gironde, raised by means of sowing steadily continued since 1789; the cultivation of the pine, along with draining, has transformed low marshy grounds into productive soil extending over an area of about two million acres. The forests thus created provide annually some 600,000 tons of pit timber for the Welsh coal mines.

The state forest department is administered by the director-general, who has his headquarters at Paris, assisted by a board of administration, charged with the working of the forests, questions of rights and law, finance and plantation works.

The department is supplied with officers from the forest school at Nancy. This institution was founded in 1824, when M. Lorentz, who had studied forestry in Germany, was appointed its first director.

Italy.—The kingdom of Italy comprises such different climates that within its limits we find the birch and pines of northern Europe, and the olive, fig, manna-ash, and palm of more southern latitudes. By the republic of Venice and the duchy of Genoa forestal legislation was attempted at various periods from the 15th century downwards. These efforts were not successful, as the governments were lax in enforcing the laws. In 1789 Pius VI. issued regulations prohibiting felling without licence, and later orders were published by his successors in the pontifical states. In Lombardy the woods, which in 1830 reached nearly down to Milan, have almost disappeared. The province of Como contains only a remnant of the primitive forests, and the same may also be said of the southern slopes of Tirol. At Ravenna there is still a large forest of stone pine, *Pinus pinea*, though it has been much reduced. The plains of Tuscany are adorned with planted trees, the olive, mulberry, fig and almond. Sardinia is rich in woods, which cover one-fifth of the area, and contain a large amount of oak, *Quercus suber*, *robur* and *cerris*. In Sicily the forests have long been felled, save the zone at the base of Mount Etna.

The destruction of woods has been gradual but persistent; at the end of the 17th century the effects of denudation were first felt in the destructive force given to mountain torrents by the deforesting of the Apennines. The work of devastation continued until a comparatively recent time.

In 1867 the monastic property of Vallombrosa, Tuscany, 30 m. from Florence, was purchased by government for the purposes of a forest academy, which was opened in 1869. As only 4 % of the total forest area belongs to the state, it is doubtful whether much good can now be done.

Great Britain and Ireland.—The British Isles were formerly much more extensively wooded than at present. The rapid increase of population led to the deforesting of woodland; the climate required the maintenance of household fires during a great part of the year, and the increasing demand for arable land and the extension of manufacturing industries combined to cause the diminution of woodland. The proportion of forest is now very small, and yields but a fraction of the required annual supply of timber which is imported with facility from America, northern Europe and the numerous British colonies.

Owing to the nature of the climate of the British Islands, with its abundance of atmospheric moisture and freedom from such extremes of heat and cold as are prevalent in continental

Europe, a great variety of trees are successfully cultivated. In England and Ireland oak and beech are on the whole the most plentiful trees in the low and fertile parts; in the south of Scotland the beech and ash are perhaps most common, while the Scotch fir and birch are characteristic of the arboreal vegetation in the Highlands. Although few extensive forests now exist, woods of small area, belts of planting, clumps of trees, coppice and hedgerows, are generally distributed over the country, constituting a mass of wood of considerable importance, giving a clothed appearance in many parts, and affording illustrations of skilled arboriculture not to be found in any other country.

The principal state forests in England are Windsor Park, 14,000 acres; the New Forest, &c., in Hampshire, 76,000 acres; and the Dean Forest in Gloucestershire, 22,500 acres. The total extent of crown forests is about 125,000 acres. A large proportion of the crown forests, having been formed with the object of supplying timber for the navy, consists of oak. The largest forests in Scotland are in Perthshire, Inverness-shire and Aberdeenshire. Of these the most notable are the earl of Mansfield's near Scone (8000 acres), the duke of Atholl's larch plantations near Dunkeld (10,000 acres), and in Strathspey a large extent of Scotch pine, partly native, partly planted, belonging to the earl of Seafield. In the forests of Mar and Invercauld, the native pine attains a great size, and there are also large tracts of indigenous birch in various districts. Ireland was at one time richly clothed with wood; this is proved by the abundant remains of fallen trees in the bogs which occupy a large surface of the island. In addition to the causes above alluded to as tending to disforest England, the long unsettled state of the country also conduced to the diminishing of the woodlands.

The forests of Great Britain and Ireland, in spite of the large imports of timber, have not been appreciably extended up to the present time because (1) the rate at which foreign timber has been laid down in Britain is very low, thus keeping down the price of home-grown timber; (2) foreign timber is preferred to home-grown material, because it is in many cases of superior quality, while the latter comes into the market in an irregular and intermittent manner; (3) nearly the whole of the waste lands is private property. As regards prices, it can be shown that the lowest point was reached about the year 1883, in consequence of the remarkable development of means of communication, that prices then remained fairly stationary for some years, and that about 1894 a slow but steady rise set in, showing during the years 1894-1904 an increase of about 20 % all round. This was due to the gradual approach of the coming crisis in the supply of coniferous timber to the world. It can be shown that even with present prices the growing of timber can be made to pay, provided it is carried on in a rational and economic manner. Improved silvicultural methods must be applied, so as to produce a better class of timber, and the forests must be managed according to well-arranged working plans, which provide for a regular and sustained out-turn of timber year by year, so as to develop a healthy and steady market for locally-grown material. Unfortunately the private proprietors of the waste lands are in many cases not in a financial position to plant. Starting forests demands a certain outlay in cash, and the proprietor must forgo the income, however small, hitherto derived from the land until the plantations begin to yield a return. In these circumstances the state may well be expected to help in one or all of the following ways: (1) The equipment of forest schools, where economic forestry, as elaborated by research, is taught; (2) the management of the crown forests on economic principles, so as to serve as patterns to private proprietors; (3) advances should be made to landed proprietors who desire to plant land, but are short of funds, just as is done in the case of improvements of agricultural holdings; and (4) the state might acquire surplus lands in certain parts of the country, such as congested districts, and convert them into forests. Action in these directions would soon lead to substantial benefits. The income of landed proprietors would rise, a considerable sum of money now sent abroad would remain in the country, and forest industries would spring up, thus helping to counteract

the ever-increasing flow of people from the country into the large towns, where only too many must join the army of the unemployed. Even within a radius of 50 m. of London 700,000 acres of land are unaccounted for in the official agricultural returns. In Ireland more than 3,000,000 acres are waiting to be utilized, and it is well worth the consideration of the Irish Land Commissioners whether the lands remaining on their hands, when buying and breaking up large estates, should not be converted into state forests. Such a measure might become a useful auxiliary in the peaceful settlement of the Irish land question. No doubt success depends upon the probable financial results. There are at present no British statistics to prove such success; hence, by way of illustration, it may be stated what the results have been in the kingdom of Saxony, which, from an industrial point of view, is comparable with England. That country has 432,085 acres of state forests, of which about one-eighth are stocked with broad-leaved species, and seven-eighths with conifers. Some of the forests are situated on low lands, but the bulk of the area is found in the hilly parts of the country up to an elevation of 3000 ft. above the sea. The average price realized of late years per cubic foot of wood amounts to 5d., and yet to such perfection has the management been brought by a well-trained staff, that the mean annual net revenue, after meeting all expenses, comes to 21s. an acre all round. There can be no doubt that, under the more favourable climate of Great Britain, even better results can be obtained, especially if it is remembered that foreign supplies of coniferous timber must fall off, or, at any rate, the price per cubic foot rise considerably.

These things have been recognized to some extent, and a movement has been set on foot to improve matters. The Commissioners of Woods and a number of private proprietors had rational working plans prepared for their forests, and instruction in forestry has been developed. There is now a well-equipped school of forestry connected with the university of Oxford, while Cambridge is following on similar lines; instruction in forestry is given at the university of Edinburgh, the Durham College of Science, at Bangor, Cirencester and other places. The Commissioners of Woods have purchased an estate of 12,500 acres in Scotland, which will be converted into a crown forest, so as to serve as an example. The experience thus gained will prove valuable should action ever be taken on the lines suggested by a Royal Commission on Coast Erosion, Reclamation of Tidal Lands and Afforestation, which reported on the last subject in 1909.

India.—The history of forest administration in India is exceedingly instructive to all who take an interest in the welfare of the British Empire, because it places before the reader an account of the gradual destruction of the greater part of the natural forests, a process through which most other British colonies are now passing, and then it shows how India emerged triumphantly from the self-inflicted calamity. As far as information goes, India was, in the early times, for the most part covered with forest. Subsequently settlers opened out the country along fertile valleys and streams, while nomadic tribes, moving from pasture to pasture, fired alike hills and plains. This process went on for centuries. With the advent of British rule forest destruction became more rapid than ever, owing to the increase of population, extension of cultivation, the multiplication of herds of cattle, and the universal firing of the forests to produce fresh crops of grass. Then railways came, and with their extension the forests suffered anew, partly on account of the increased demand for timber and firewood, and partly on account of the fresh impetus given to cultivation along their routes. Ultimately, when failure to meet the requirements of public works was brought to notice, it was recognized that a grievous mistake had been made in allowing the forests to be recklessly destroyed. Already in the early part of the 19th century sporadic efforts were made to protect the forests in various parts of the country, and these continued intermittently; but the first organized steps were taken about the year 1855, when Lord Dalhousie was governor-general. At that time conservators of forests existed in Bombay, Madras and Burma.

Soon afterwards other appointments followed, and in 1864 an organized state department, presided over by the inspector-general of forests, was established. Since then the Indian Forest Department has steadily grown, so that it has now become of considerable importance for the welfare of the people, as well as for the Indian exchequer.

The first duty of the department was to ascertain the position and extent of the remaining forests, and more particularly of that portion which still belonged to the state. Then a special forest law was passed, which was superseded in 1878 by an improved act, providing for the legal formation of permanent state forests; the determination, regulation, and, if necessary, commutation of forest rights; the protection of the forests against unlawful acts and the punishment of forest offences; the protection of forest produce in transit; the constitution of a staff of forest officers, provision to invest them with suitable legal powers, and the determination of their duties and liabilities. The officers who administered the department in its infancy were mostly botanists and military officers. Some of these became excellent foresters. In order to provide a technically trained staff arrangements were made in 1866 by Sir Dietrich Brandis, the first inspector-general of forests, for the training of young Englishmen at the French Forest School at Nancy and at similar institutions in Germany. In 1876 the students were concentrated at Nancy, and in 1885 an English forest school for India was organized in connexion with the Royal Indian Engineering College at Cooper's Hill. In 1905 the school was transferred to the university of Oxford. The imperial forest staff of India consisted in 1909 of—officers not specially trained before entering the department, 17; officers trained in France and Germany, 23; officers trained at Cooper's Hill, 143—total 184.

In 1878 a forest school was started at Dehra Dun, United Provinces, for the training of natives of India as executive officers on the provincial staff. Since then a similar school, though on a smaller scale, has been established at Tharrawaddy in Burma. About 500 officers of this class have been appointed. In addition, there are about 11,000 subordinates, foresters and forest guards, who form the protective staff. The school at Dehra Dun has lately been converted into the Imperial Forest College.

The progress made since 1864 is really astonishing. According to the latest available returns, the areas taken under the management of the department are—reserved state forests, or permanent forest estates, 91,272 sq. m.; other state forests, 141,669 sq. m.; or a total of 232,941 sq. m., equal to 24 % of the area over which they are scattered. At present, therefore, the average charge of each member of the controlling staff comprises 1266 sq. m.; that of each executive officer, 446 sq. m.; and that of each protective official, 21 sq. m. It is the intention to increase the executive and protective staff considerably, in the same degree as the management of the forests becomes more detailed. Of the above-mentioned area the Forest Survey Branch, established in 1872, has up to date surveyed and mapped about 65,000 sq. m. From 1864 onwards efforts were made to introduce systematic management into the forests, based upon working plans, but, as the management had been provincialized, there was no central or continuous control. This was remedied in 1884, when a central Working Plans Office, under the inspector-general of forests, was established. This officer has since then controlled the preparation and execution of the plans, a procedure which has led to most beneficial results. Plans referring to about 38,000 sq. m. are now (1909) in operation, and after a reasonable lapse of time there should not be a single forest of importance which is not worked on a well-regulated plan, and on the principle of a sustained yield. While the danger of overworking the forests is thus being gradually eliminated, their yield capacity is increased by suitable silvicultural treatment and by fire protection. Formerly most of the important forests were annually or periodically devastated by jungle fires, sometimes lighted accidentally, in other cases purposely. Now 38,000 sq. m. of forest are actually protected against fire by the efforts of the department, and it is the intention gradually to extend protection to all permanent

state forests. Grazing of cattle is of great importance in India; at the same time it is liable to interfere seriously with the reproduction of the forests. To meet both requirements careful and minute arrangements have been made, according to which at present 38,000 sq. m. are closed to grazing; 19,000 sq. m. are closed only against the grazing of goats, sheep and camels; while 176,000 sq. m. are open to the grazing of all kinds of cattle. The areas closed in ordinary years form a reserve of fodder in years of drought and scarcity. During famine years they are either opened to grazing, or grass is cut in them and transported to districts where the cattle are in danger of starvation. The service rendered in this way by a wise forest administration should not be underrated, since one of the most serious calamities of a famine—the want of cattle to cultivate the land—is thus, if not avoided, at any rate considerably reduced. During 1907 the government of India established a Research Institute, with six members engaged in collecting data regarding silviculture, forest botany, forest zoology, forest economics, working plans, and chemistry in connexion with forest produce and production. The institute is likely to lead to further substantial progress in the management of the forests.

The financial results of forest administration in India for the years 1865 to 1905 show the progress made:

Period.	Mean Annual Net Revenue.	Percentage of Annual Increase during Period.
	Rupees.	
1865-1870 . . .	1,372,733	..
1870-1875 . . .	1,783,248	30
1875-1880 . . .	2,224,687	25
1880-1885 . . .	3,385,745	52
1885-1890 . . .	5,066,671	50
1890-1895 . . .	7,370,572	44
1895-1900 . . .	7,923,484	7
1900-1905 . . .	9,004,367	12

The highest percentage of increase occurred in the period 1880-1885. The revenue since 1886 has been considerably increased by the annexation of Upper Burma.

Apart from the net revenue, large quantities of produce are given free of charge, or at reduced rates, to the people of the country. Thus, in 1904-1905, the net revenue amounted to Rs. 11,062,094, while the produce given free or at reduced rates was valued at Rs. 3,500,661, making a total net benefit derived from the state forests during that year of Rs. 14,562,755, or in round figures one million pounds sterling. The out-turn during the same year amounted to 252 million cub. ft. of timber and fuel and 215 million bamboos. The receipts from the sale of other forest produce came to 9 million rupees, out of a total gross revenue of 24 million rupees.

These results are highly creditable to the government of India, which has led the way towards the introduction of rational forest management into the British empire, thus setting an example which has been followed more or less by various colonies. Even the movement in the United Kingdom during late years is due to it. Apart from India, substantial progress has been made in Cape Colony, Ceylon, the Straits Settlements and the Federated Malay States. Other British colonies are more backward in this respect. Energetic action is urgently wanted, especially in Canada and Australasia, where an enormous state property is threatened by destruction.

LITERATURE.—The following works of special interest may be mentioned: W. Schlich, *A Manual of Forestry* (London) (vols. i., ii. and iii. by W. Schlich; vols. iv. and v. by W. R. Fisher; 3rd ed. of vol. i., 1906, of vol. ii., 1904, of vol. iii., 1905; 2nd ed. of vol. iv., 1907; 2nd ed. of vol. v., 1908); Baden-Powell, *Forest Law* (London, 1893); Brown, *The Forester* (ed. by Nisbet, Edinburgh and London, 1905); Broilliard, *Le Traitement des bois* (Paris, 1894); Huffel, *Economie forestière* (Paris, 1904-1907); Lorey, *Handbuch der Forstwissenschaft* (2nd ed. by Stoetzer, Tübingen, 1903); Rossmässler, *Der Wald*. (W. SCH.)

UNITED STATES

The Forest Regions.—The great treeless region east of the Rocky Mountains separates the wooded area of the United

States into two grand divisions, which may be called the Eastern and the Western forests. The Eastern forest is characterized by the predominance, on the whole, of broad-leaved trees, the comparative uniformity of its general types over wide areas, and its naturally unbroken distribution. In the Western forest conifers are conspicuously predominant; the individual species often reaches enormous and even unequalled dimensions, the forest is frequently interrupted by treeless areas, and the transitions from one type to another are often exceedingly abrupt. Both divisions are botanically and commercially rich in species.

The Eastern forest may conveniently be subdivided into three members:

1. The Northern forest, marked by great density and large volume of standing timber, and a comparative immunity, in its virgin condition, from fire. The characteristic trees are maples, birches and beech (*Fagus atropurpurea*), among the hardwoods and white pine (*Pinus strobus*), spruce (*Picea rubens* and *Picea mariana*) and hemlock (*Tsuga canadensis*) among conifers.

2. The Southern forest is on the whole less dense than the Northern, and more frequently burned over. Among its characteristic trees are the longleaf (*Pinus palustris*) and other pines, oaks, gums, bald cypress (*Taxodium distichum*) and white cedar (*Chamaecyparis thyoides*).

3. The Central Hardwood forest, which differs comparatively little from adjacent portions of the Northern and Southern forests except in the absence of conifers. Among its trees are the chestnut (*Castanea dentata*), hickories, ashes and other hardwoods already mentioned.

The Western division has two members:

1. The Pacific Coast forest, marked by the great size of its trees and the vast accumulations of merchantable timber. Among its characteristic species are the redwood (*Sequoia sempervirens*) and the big tree (*S. Washingtoniana*), the Douglas fir (*Pseudotsuga taxifolia*), sugar pine (*Pinus lambertiana*), western hemlock (*Tsuga heterophylla*), giant arborvitae (*Thuja plicata*) and Sitka spruce (*Picea sitchensis*).

2. The Rocky Mountain forest, whose characteristic species are the western yellow pine (*Pinus ponderosa*), Engelmann spruce

(*Picea engelmanni*) and lodgepole pine (*Pinus murrayana*). This forest is frequently broken by treeless areas of greater or less extent, especially towards the south, and it suffers greatly from fire. Subarid in character, except to the north and at high elevations, the vast mining interests of the region and its treeless surroundings give this forest an economic value out of proportion to the quantities of timber it contains.

This distribution of the various forests is indicated on the first of the two accompanying maps. The second map shows the situation of the national forests hereafter mentioned.

The forests of Alaska fall into two main divisions: the commercial though undeveloped forests of the south-east coast, which occur along the streams and on the lower slopes of the mountains and consist chiefly of western hemlock (*Tsuga heterophylla*), Sitka spruce (*Picea sitchensis*), yellow cedar (*Chamaecyparis nootkatensis*) and giant arborvitae (*Thuja plicata*), usually of large size and uninjured by fire; and the vast interior forests, swept by severe fires, and consisting chiefly of white and black spruces (*Picea canadensis* and *nigra*), paper birch (*Betula papyrifera*) and aspen (*Populus tremuloides*), all of small size but of great importance in connexion with mining. Northern Alaska and the extreme western coast regions are entirely barren.

The National Forest Policy.—The forest policy of the United States may be said to have had its origin in 1799 in the enactment of a law which authorized the purchase of timber suitable for the use of the navy, or of land upon which such timber was growing. It is true that laws were in force under the early governments of Massachusetts, New Jersey and other colonies, providing for the care and protection of forest interests in various ways, but these laws were distinctly survivals of tendencies acquired in Europe, and for the most part of little use. It was not until the apparent approach of a dangerous shortage in certain timber supplies that the first real step in forest policy was taken by the United States. Successive laws passed from 1817 to 1831 strove to give larger effect to the original enactment, but without permanent influence towards the preservation of the live oak (*Quercus virginiana* Mill.), which was the object in view. A long period of inaction followed these early measures. In

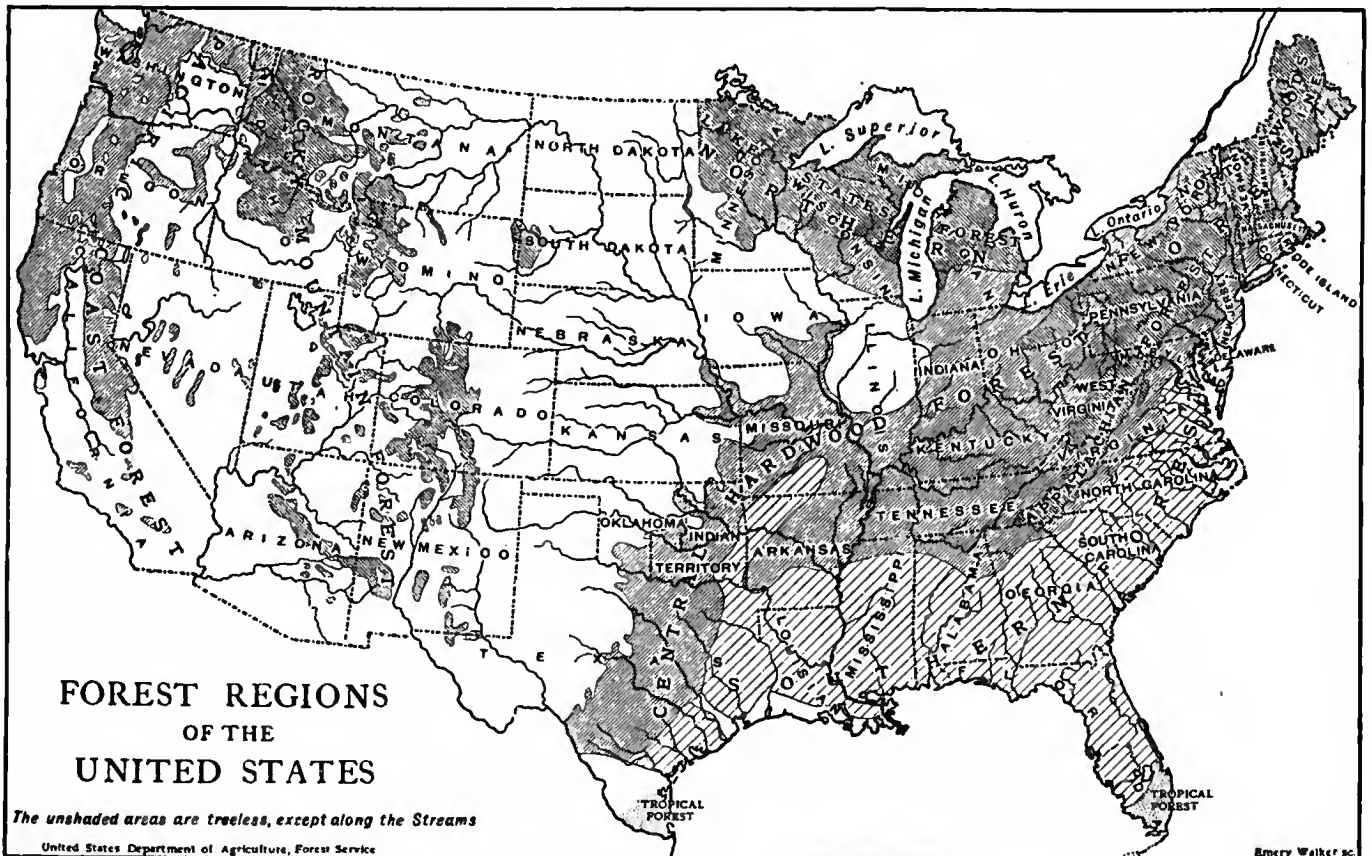

1831 the solicitor of the treasury assumed a partial responsibility for the care and protection of the public timber lands, and in 1855 this duty was transferred to the commissioner of the general land office in the Department of the Interior. The effect of these changes upon forest protection was unimportant. When, however, at the close of the Civil War railway building in the United States took on an unparalleled activity, the destruction of forests by fire and the axe increased in a corresponding ratio, and public sentiment began to take alarm. Action by several of the states slightly preceded that of the Federal government, but in 1876 Congress, acting under the inspiration of a memorial from the American Association for the Advancement of Science, authorized the appointment of an officer (Dr Franklin B. Hough) under the commissioner of agriculture, to collect and distribute information upon forest matters. His office became in 1880 the division of forestry in what is now the United States Department of Agriculture.

As the railways advanced into the treeless interior, public interest in tree-planting became keen. In 1873 Congress passed and later amended and repealed the timber culture acts, which granted homesteads on the treeless public lands to settlers who planted one-fourth of their entries with trees. Though these measures were not successful in themselves they directed attention towards forestry. The act which repealed them in 1891 contained a clause which lies at the foundation of the present forest policy of the United States. By it the president was authorized to set aside "any part of the public lands wholly or in part covered with timber or undergrowth, whether of commercial value or not, as public reservations, and the President shall, by public proclamation, declare the establishment of such reservations and the limits thereof." Some eighteen million acres had been proclaimed as reservations at the time when, in 1896, the National Academy of Sciences was asked by the secretary of the interior to make an investigation and report upon "the inauguration of a rational forest policy for the forest lands of the United States." Upon the recommendation of a commission named by the Academy, President Cleveland established more than twenty-one million acres of new reserves on the 22nd of February 1897. His action was widely misunderstood and attacked, but it awakened a public interest in forest questions without which the rapid progress of forestry in the United States since that time could never have been made.

Within a few months after the proclamation of the Cleveland reserves the present national forest policy took definite shape. Under this policy the national government holds and manages, in the common interest of all users of the forests or its products, such portions of the public lands as have been set aside by presidential proclamation in accordance with the act of 1891. These lands are held against private acquisition under the Homestead Act (except as to agricultural lands as hereafter mentioned), the Timber and Stone Act, and other laws under which the United States disposes of its unappropriated public domain, but not against private acquisition under the Mineral Land Laws. They are selected from lands believed to be more valuable for forest purposes than for agriculture, and are managed with the purpose of securing from them the best and largest possible returns, present and future, whether in the form of water for irrigation or power, of timber, of forage for stock, or of any other beneficial product. The aggregate area of the reserves, or national forests, has been steadily increased until they now include nearly all the timber lands left of the public domain.

The general lines of this policy were in part laid down by the commission already mentioned, in its report submitted to the secretary of the interior, May 1, 1897, and by the act of June 4, 1897, which was largely shaped by the work of the commission. Until this act was passed the national forests had been in theory closed against any form of use; nor had the possibility of securing forest preservation by wise use received much thought from those who had favoured their creation. Such a state of affairs could not continue. Before long public opinion would have forced the opening to use of the resources thus arbitrarily locked up, and in the absence of any administrative

system providing for conservative use, the national forests would inevitably have been abolished, and the whole policy of government forest holdings would have ceased. The act of June 4, 1897 was therefore of the first importance. This act conferred upon the secretary of the interior general powers for the proper management of the national forests through the general land office of his department. It provided for the designation and sale of dead, mature and large timber; authorized the secretary to permit free use of timber in small quantities by settlers, miners and residents; empowered him to "make such rules and regulations and establish such service as will insure the objects of such reservations, namely, to regulate their occupancy and use and to preserve the forests thereon from destruction"; and made violation of the act or of such rules and regulations a misdemeanour. The statute limited the power to establish forest reservations to the purpose of improving and protecting the forest, securing favourable conditions of water flows, and furnishing a continuous supply of timber for the use and necessities of citizens of the United States. Lands found, upon due examination, to be more valuable for other purposes than for forest uses might be eliminated from any reservation, and all mineral lands within the reservations were left open to private appropriation under the mineral laws. The rights of settlers and claimants were safeguarded, and civil and criminal jurisdiction, except so far as the punishment of offences against the United States in the reservations was concerned, was reserved to the States.

While the administration of the national forests was entrusted to the general land office, the same act assigned the surveying and mapping of them to the United States Geological Survey, which has published descriptions and maps of some of the more important.

No attempt was made in the general land office to develop a technical forest service. There were, indeed, at the time of passage of the act, less than ten trained foresters in the United States, no means of training more, and very little conception of what forestry actually meant. The purpose of the administration was therefore mainly protection against trespass and fire, particularly the latter. Regulations were made giving effect to the provisions of the act of June 4, set forth above, but in the absence of technical knowledge as to what might safely be done, the tendency was rather to restrict than to extend the use of the forest. Meanwhile, however, there was rapidly developing in another branch of the government service an organization qualified for actual forest management.

One year after the passage of the act of June 4, 1897, the division of forestry in the Department of Agriculture ceased to be merely a bureau of information, and became an active agency for introducing the actual practice of forestry among private owners and for conducting the investigations upon which a sound American forest practice could be based. The work awakened great interest among forest owners, and exerted a powerful educational influence upon the country at large. The division extended its work and became (July 1, 1901) the Bureau of Forestry. It drew into its employment for a time nearly all the men who were preparing themselves in increasing numbers (at first abroad, then in the newly-founded schools in the United States) for the profession of forestry, and was soon recognized as qualified to speak authoritatively on technical questions connected with the administration of the national forests. This led to a request from the secretary of the interior for the advice of the bureau on such questions. Working plans were accordingly undertaken for a number of the forests. The general land office, however, was not ready to attempt active forest management. Though some timber was sold and the grazing of stock regulated to some extent, the main object of the land office administration continued to be protection against fire. Many of the regulations which it made could not be enforced.

The disadvantages of dispersal of the Federal government forest work among three separate agencies grew more and more apparent, until, on the 1st of February 1905, control of the 63,000,000 acres of forest reserves which up to that time had been set aside was transferred from the general land office to

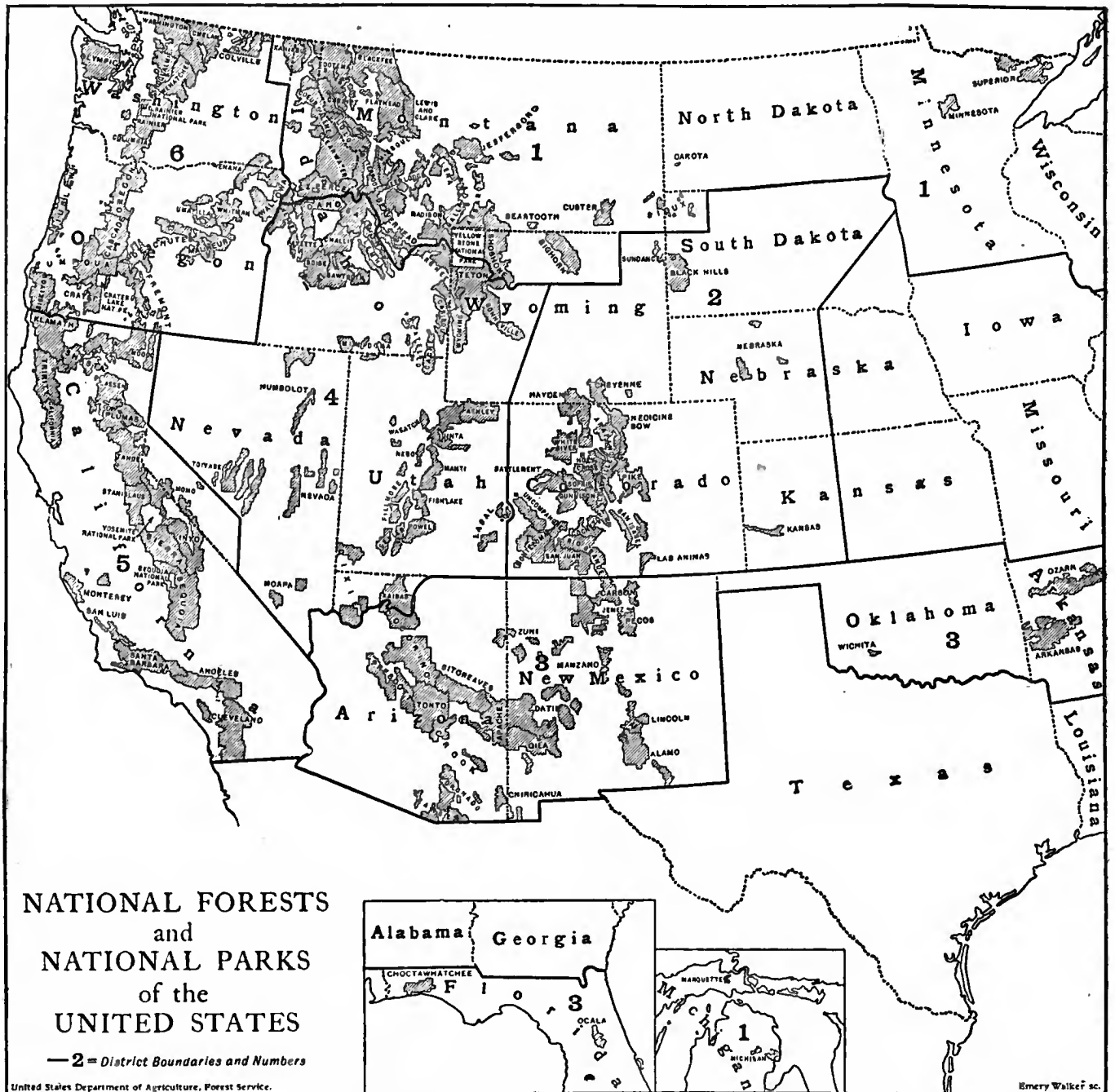

the Bureau of Forestry. In recognition of its new duties the designation of the bureau became the Forest Service.

Other provisions of the act which affected the transfer were that forest supervisors and rangers should be selected, so far as possible, from qualified citizens of the state or territory in which each forest was situated, and that all money received from the sale of any products or the use of any land or resources of the national forests should be covered into the treasury and constitute a special fund for their protection, administration, improvement and extension. Five days later a statute gave forest officers the power to arrest trespassers; and on the 3rd of March the lieu land selection law was repealed. This law had opened the way for grave abuses through the exchange of worthless land by private owners within the forests for an equal area of valuable timber lands outside.

The law has been modified since by the change of the old name "Forest Reserves" to "National Forests." The act of June 11, 1906, opened to homestead entry lands within national forests found by examination to be chiefly valuable for

agriculture. The administration and improvement of the national forests are now provided for directly by congressional appropriation. The power to create national forests conferred on the president by the act of March 1891 has been repealed for the states of Washington, Oregon, Idaho, Montana, Wyoming and Colorado, but for no others.

The Forest Service began in earnest the development of all the resources of the national forests. Mature timber was sold wherever there was a demand for it and the permanent welfare of the forests and protection of the streams permitted, but always so as to prevent waste, guard against fire, protect young growth and ensure reproduction. Regulations were adopted which allowed small sales to be made without formality or delay, secured for the government the full value of timber sold, and eliminated unnecessary routine. Care was taken to safeguard the interests of the government and provide for the maintenance of good technical standards. The conduct of local business was entrusted to local officers. Large transactions with general policies were controlled from Washington, but with careful

provision for first-hand knowledge and close touch with the work in the field. Business efficiency and the convenience of the public were carefully studied. In short, an organization was created capable of handling safely, speedily and satisfactorily the complex business of making useful a forest property of vast extent, scattered through sixteen different states of an aggregate area of over 1,500,000 sq. m. and with a population of 9,000,000.

The growth since the 1st of July 1897 of the area of the national forests, of the expenditures of the government for forestry, and of the receipts from the national forests, is shown by the statement which follows. Though the act of June 4, 1897, became effective immediately upon its passage, the fiscal year 1899 was the first of actual administration, because the first for which Congress made the appropriation necessary to carry out the law.

forest is ripe for the axe, the demand is strong, and control by trained men makes it safe to cut more freely. The increase is marked both in small and in large sales, but a score of sales for less than \$5000 are made against one for more. The total cut is still far below the annual increment of the forests. As the demand grows restrictions must increase in order to husband the present supply until the next crop matures.

3. The stumpage price would seem on the face of the figures to have risen from about one dollar to more than three dollars per thousand board-feet. The receipts, however, for any one year are not exclusively for the timber cut in that year, since payments are made in advance. In the year 1907 the average price obtained was something less than \$2.50 per thousand. It is therefore true that stumpage prices have risen greatly, although conditions new to the American lumbermen are im-

Area of National Forests, Annual Expenditures of the Federal Government for Forestry and National Forest Administration, and Receipts from National Forests, 1898-1909.

Fiscal Year. ¹	Area of National Forests at Close of Year (June 30). Acres.	Division of Forestry (Bureau of Forestry, Forest Service). \$	General Land Office. \$	Receipts from National Forests. \$	Receipts from National Forests, per Acre. \$	Expenditures upon National Forests, per Acre. \$
1898	40,866,184	20,000.00
1899	46,168,439	28,520.00	175,000.00	7,534.83	0.00016	0.0038
1900	46,515,039	48,520.00	210,000.00	36,754.02	.00078	.0045
1901	46,324,479	88,520.00	325,000.00	29,250.88	.00063	.0070
1902	51,896,357	185,440.00	300,000.00	25,431.87	.00049	.0060
1903	62,211,240	291,860.00	304,135.00	45,838.08	.00074	.0054
1904	62,611,449	350,000.00	375,000.00	58,436.19	.00093	.0072
1905	85,693,422	632,232.36 ²	217,907.64 ²	73,276.15	.00085	.0059
1906	106,994,018	1,191,400.21	..	767,219.96	.00717	.0089
1907	150,832,665	1,800,595.20	..	1,571,059.44	.01041	.0097
1909	167,677,749	2,948,153.08	..	1,807,276.66	.00931	.0151

Until 1906, the sole source of receipts was the sale of timber. In the fiscal year 1907, however, timber sales furnished less than half the receipts. The following statement concerning the timber sales of the fiscal years 1904-1907 will serve to bring out the change that followed the transfer of control to the forest service in the midst of the fiscal year 1905:—

Fiscal Year.	Amount of Timber Sold. Bd.-ft.	Amount of Timber Cut. Bd.-ft.	Receipts from Timber Sales. \$
1904	112,773,710	58,435,000	58,436.19
1905	113,661,508	68,475,000	73,270.15
1906	328,230,326	138,665,000	245,013.49
1907	1,044,855,000	194,872,000	686,813.12

These figures show (1) a large excess each year in the amount of timber sold over that cut and paid for; (2) nine times as much timber sold at the end of the four-year period as at the beginning and three times as much cut; and (3) a much higher price obtained per thousand board-feet at the end of the period than at the beginning. Each of these matters calls for comment. The sales are of stumpage only; the government does no logging on its own account.

1. More timber is sold each year than is cut and paid for, because many of the sales extend over several years. With increasing sales the amount sold each year for future removal has exceeded the amount to be removed during that year under sales of earlier years. Large sales covering a term of years are made because the national forests contain much overmature timber, which needs removal, but which is frequently too inaccessible to be saleable in small amounts. To prevent speculation the time allowed for cutting is never more than five years, and cutting must begin at once and be continued steadily.

2. The volume of sales has increased rapidly because much

¹ The United States fiscal year ends June 30, and receives its designation from the calendar year in which it terminates. Thus, the fiscal year 1898 is the year July 1, 1897-June 30, 1898.

² Administration transferred to Bureau of Forestry, February 1, 1905.

posed. Full utilization of all merchantable material, care of young growth in felling and logging, and the piling of brush, to be subsequently burned by the forest officers if burning is necessary, are among these conditions. Timber to be cut must first be marked by the forest officers. Sales of more than \$100 in value are made only after public advertisement.

Only the simplest forms of silviculture have as yet been introduced. The vast area of the national forests, the comparatively sparse population of the West, the rough and broken character of the forests themselves, and the newness of the problems which their management presents, make the general application of intensive methods for the present impracticable. Natural reproduction is secured. The selection system is most used, often under the rough and ready method of an approximate diameter limit, with the reservation of seed trees where needed. The tendency, however, is strongly towards a more flexible and effective application of the selection principle, as a better trained field force is developed and as market conditions improve.

One conspicuous achievement was the reduction of loss by fires on the national forests. During the unusually dry season of 1905 there were only eight fires of any importance, and the area burned over amounted only to about .16 of 1 % of the total area. In 1906 about .12 of 1 % was burned. This was accomplished by efficient patrol, co-operation of the public, and by preventive measures, such as piling and burning the brush on cut-over areas.

Since the beginning of 1906 the largest source of income from the national forests was their use for grazing. Stock-raising is one of the most important industries of the West. Formerly cattle and sheep grazed freely on all parts of the public domain. In the early days of the national forests the wisdom of permitting any grazing at all upon them was sharply questioned. Unrestricted grazing had led to friction between individuals, the deterioration of much of the range through overstocking, and serious injury to the forests and stream flow. The forests of the West, however, are largely of open growth and contain many grassy parks, the results of old fires, and many high mountain meadows. Under proper regulations the grass and

other forage plants which they produce in great quantity can be used without detriment to the forests themselves, and with great benefit to the stock industry, which often can find summer pasturage nowhere else. Except in southern California grazing is now permitted on all national forests unless the watersheds furnish water for domestic use; but the time of entering and leaving, the number of head to be grazed by each applicant, and the part of the range to be occupied are carefully prescribed. Planted areas and cut-over areas are closed to stock until the young growth is safe from harm, and goats are allowed only in the brushland of the foothills.

The results of regulation, in addition to the protection of forest growth and streams, are the prevention of disputes, improved range, better stock, stable conditions in the stock industry, and the best use of the range in the interest of progress and development. The first right to graze stock on the forests is given to residents, small owners and those who have used the range before. Thus the crowding out of the weaker by the stronger and of the settler by the roving outsider has been stopped. In 1906 the forest service began to impose a moderate charge for the use of the national forest range. The following statement shows the amount of stock grazed on the national forests 1904-09, and the receipts for the grazing charge:—

Year.	Number of Cattle and Horses.	Number of Sheep and Goats.	Receipts.
1904	610,091	1,806,722	\$
1905	692,124	1,709,987	..
1906	1,015,148	5,763,100	514,692.87
1907	1,200,158	6,657,083	863,920.32
1909	1,531,404	7,819,594	1,032,185.70

A work of enormous magnitude which has now begun is planting on the national forests. At present, with low stumpage prices and incomplete utilization of forest products, clear cutting with subsequent planting is not practicable. There are, however, many million acres of denuded land within the national forests which require planting. Such planting is still confined chiefly to watersheds which supply cities and towns with water. The first planting was done in 1892, in California. Since then similar work has been done on city watersheds in Colorado, Utah, Idaho and New Mexico. Other plantations are in the Black Hills national forest, where large areas of cut-over and burned-over land are entirely without seed trees, and in the sandhill region of Nebraska. Up to 1908 about 2,000,000 seedlings had been planted, on over 2000 acres—a small beginning, but the work was entirely new and presented many hard problems.

The nursery operations of the forest service are concentrated at seven stations, located in southern California, Nebraska, Colorado, New Mexico (2), Utah and Idaho, where stock is raised for local planting and for shipment elsewhere. These nurseries are small. Their annual productive capacity is between 8,000,000 and 10,000,000 seedlings. Each nursery is practically an experimental forest-planting station, at which a large variety of species are grown and various methods are tried.

The organization of the administrative work of the national forests is by single forests. On the 1st of January 1908 the total number of forests was 165 with a total area of 162,023,190 acres (on April 7, 1909, the numbers were 146 national forests in the U.S. with 167,672,467 acres, besides two in Alaska with 26,761,626 and one in Porto Rico with 65,950 acres). In charge of each forest is a forest supervisor. Under the supervisors are forest rangers and forest guards, whose duties include patrol, marking timber and scaling logs, enforcing the regulations and conducting some of the minor business arising from the use of the forests. Guards are temporary employes; rangers are employed by the year. The supervisors report directly to and receive instructions from the central office at Washington. In this office there are four branches—operation, grazing, silviculture and products—each of which directs that part of the work which belongs to it, dealing directly with the supervisor. For inspection purposes, however, the forests are separated into six districts, in each of

which is located a chief inspector with a corps of assistants. The inspectors are without administrative authority, but assist by their counsel the supervisors, and through inspection reports keep the Washington office informed of the condition of all lines of administrative work in progress. Administrative officers alternate frequently between field and office duties.

The number of forest officers in the several grades on the 1st of January 1908 were: 6 chief inspectors, 26 inspectors, 106 forest supervisors, 41 deputy forest supervisors, 820 forest rangers and 283 forest guards. The total number of employes of the forest service on the same date, including the clerical force, was 2034.

Besides the administration of the national forests, the forest service conducts general investigations, carries on an extensive educational work, and co-operates with private owners who contemplate forest management upon their own tracts. This last work is undertaken because of the need of bringing forestry into practice, the lack of trained foresters outside of the employ of the government, and the lack of information as to how to apply forestry and what returns may be obtained. Co-operation takes the form of advice upon the ground and, on occasion, of the making of working plans. The educational work of the service is performed chiefly through publications, the purpose of which is to spread very widely a knowledge of the importance of forestry to the nation and of the principles upon which its practice rests. The investigations which the service conducts extend from studies of the natural distribution and classification of American forests and of their varied silvicultural problems to statistics of lumber production and laboratory researches which bear upon the economical utilization of forest products. As examples of these researches may be mentioned tests of the strength of timber, studies of the preservative treatment of wood for various uses, wood-pulp investigations and studies in wood chemistry.

Forest Instruction.—Most of the men now in the forest service received their training in the United States. There are several professional schools of forestry. The Yale Forest School, which was opened as a department of Yale University in September 1900, offers a two-years' graduate course with abundant field work, and also conducts a summer school of forestry, especially adapted to the training of forest rangers and special students, at Milford, Pennsylvania. The university of Michigan and Harvard University also offer a two-years' graduate course in forestry. The Pennsylvania State College has recently established a four-years' undergraduate course in forestry. The Biltmore Forest School in North Carolina, the oldest of all these schools, offers a one-year course in technical forestry. A large number of the agricultural colleges give instruction in forestry. Among these are Nebraska, Minnesota, Maine, Michigan, Washington and Mississippi agricultural colleges, the university of Georgia and Iowa State College. Berea College, Kentucky, deserves special mention as a college which has done valuable work in teaching forestry without attempting to turn out professional foresters.

Forestry among the States.—Among the states forestry has hardly reached the stage of practical application on the ground. New York holds 1,500,000 acres of forest land. It has a commission to care for its forest preserve, and to protect the forest land throughout the state from fire. The constitution of the state, however, prohibits the cutting of timber on state land, and thus confines the work entirely to protection of the forest and to the planting of waste areas. Pennsylvania is at present showing the most efficient activity in working out a forest policy. It has state forests of 820,000 acres, a good fire law more and more satisfactorily enforced, and eight nurseries for growing planting material. In 1905, 160,000 white pine seedlings were set out. It has also a school for forest rangers, to be employed on the state forests, and it has just established a state professional school of forestry.

Twenty-six of the states have regularly appointed forest officers, six have carried on studies of forest conditions in co-operation with the forest service, and there is scarcely one which is not actively interested in forestry. Laws, generally good, to prevent damage from forest fires, have been enacted by practically all

the states, but their enforcement has unfortunately been lax. Public sentiment, however, is making rapid progress. Among the best laws are those of Maine, New Hampshire, Minnesota, New York, Pennsylvania and Wisconsin. The New York law, for example, provides for the appointment of one or more fire-wardens in each town of the counties in which damage by fire is especially to be feared. In other counties supervisors of towns are *ex-officio* fire-wardens. A chief fire-warden has general supervision of their work. The wardens, half of the cost of whose services is paid by the state, receive compensation only for the time actually employed in fighting fires. They may command the service of any citizen to assist them. Setting fire to woods or waste lands belonging to the state or to another, if such fire results in loss, is punishable by a fine not exceeding \$250 or imprisonment not exceeding one year, or both, and damages are provided for the person injured. Since fire is beyond question the most dangerous enemy of forests in the United States, the measures taken against it are of vital importance.

The following table shows the amount of forest land held by the different states, and by the territory of Hawaii:—

Area of State Forest Reservations, 1907.

Connecticut	1,360 acres
Hawaii	117,532 "
Indiana	2,000 "
Maryland	3,540 "
Michigan	39,000 "
Minnesota	42,800 "
New Jersey	2,474 "
New York	1,439,998 "
Pennsylvania	820,000 "
Wisconsin	254,072 "

Forestry on Private Lands.—The practice of forestry among private owners is of old date. One of the earliest instances was that of Jared Eliot, who, in 1730, began the systematic cutting of timber land to supply charcoal for an iron furnace at Old Salisbury, Connecticut. The successful planting of waste lands with timber trees in Massachusetts dates from about ten years later. But such examples were comparatively rare until recent times. At present the intelligent harvesting of timber with a view to successive crops, which is forestry, is much more common than is usually supposed. Among farmers it is especially frequent. It was begun among lumbermen by the late E. S. Coe, of Bangor, Maine, who made a practice of restricting the cut of spruce from his forests to trees 10, 12 or sometimes even 14 in. in diameter, with the result that much of his land yielded, during his life, a second crop as plentiful as the first. Many owners of spruce lands have followed his example, but until very recently without improving upon it. Systematic forestry on a large scale among lumbermen was begun in the Adirondacks during the summer of 1898 on the lands of Dr W. S. Webb and Hon. W. C. Whitney, of a combined area of over 100,000 acres, under the superintendence of the then Division of Forestry. In these forests spruce, maple, beech and birch predominate, but the spruce alone is at present of the first commercial importance. The treatment is a form of the selection system. Under it a second crop of equal yield would be ripe for the axe in thirty-five years. Spruce and pine are the only trees cut. The work had been executed, at least up to the year 1902, with great satisfaction to the owners and the lumbering contractors, as well as to the decided benefit of the forest. The lumbering is regulated by the following rules, and competent inspectors are employed to see that they are rightly carried out: (1) No trees shall be cut which are not marked. (2) All trees marked shall be cut. (3) No trees shall be left lodged in the woods, and none shall be overlooked by the skidders or haulers. (4) All merchantable logs which are as large as 6 in. in diameter at the small end must be utilized. (5) No stumps shall be cut more than 6 in. higher than the stump is wide. (6) No spruce shall be used for bridges, corduroy, skids, slides, or for any purpose except building camps, dams or booms, unless it is absolutely necessary on account of lack of other timber. (7) All merchantable spruce used for skidways must be cut into logs and hauled out. (8) Contractors must not do any unnecessary damage

to young growth in lumbering; and if any is done, they must discharge the men who did it.

These two instances of forestry have been most useful and effective among lumbermen and other owners of forest land in the north-east. Among those which have followed their example are the Berlin Mills Paper Company in northern New Hampshire, the Cleveland Cliffs Iron Company in northern Michigan, and the Delaware and Hudson Railroad Company in New York, all of which have employed professional foresters.

The most notable instance of forestry in the south is on the estate of George W. Vanderbilt at Biltmore, N.C. This was the first case of systematic forestry under regular working plans in the United States. It was begun in 1891 on about 4000 acres, and has since been extended until it now covers about 100,000 acres. A professional forester with a corps of trained rangers under him is in charge of the work. The Pennsylvania Railroad has recently employed a trained forester and several assistants and has undertaken systematic forestry on a large scale.

The effect of the work of the forest service in assisting private owners is evidenced by the fact that down to the year 1908 670 wood lots and timber tracts had been examined by agents of the forest service, of which 250 were tracts over 400 acres in extent, and planting plans had been made for 436 owners covering a total area of 80,000 acres. Expert advice is also given to wood lot owners upon application by many of the state foresters.

American Practice.—The conditions under which forestry is practised in Europe and in America differ so widely that rules which are received as axiomatic in the one must often be rejected in the other. Among these conditions in America are the highly developed and specialized methods and machinery of lumbering, the greater facilities for transportation and consequent greater mobility of the lumber trade, the vast number of small holdings of forest land, and the enormous supply of low-grade wood in the timbered regions. High taxes on forest properties, cut-over as well as virgin, notably in the north-western pineries, and the firmly established habits of lumbermen, are factors of great importance. From these and other considerations it follows that such generally accepted essentials of European methods of forestry as a sustained annual yield, a permanent force of forest labourers, a permanent road system and the like, are in most cases utterly inapplicable in the United States at the present day in private forestry. Methods of forest management, to find acceptance, must there conform as closely as possible to existing methods of lumbering. Rules of marked simplicity, the observance of which will yet secure the safety of the forest, must open the way for more refined methods in the future. For the present a periodic or irregular yield, temporary means of transport, constantly changing crews, and an almost total ignorance of the silvics of all but a few of the most important trees—all combine to enforce the simplest silvicultural treatment and the utmost concentration of purpose on the two main objects of forestry, which are the production of a net revenue and the perpetuation of the forest. Such concentration has been followed in practice by complete success.

The forests with which the American forester deals are rich in species, usually endowed with abundant powers of reproduction, and, over a large part of their range, greatly dependent for their composition and general character upon the action of forest fires. Of the commercially valuable trees there may be said to be, in round numbers, a hundred out of a total forest flora of about 500 species, but many trees not yet of importance in the lumber trade will become so hereafter, as has already happened in many cases. The attention of the forester must usually be concentrated upon the growth and reproduction of a single species, and never of more than a very few. Thus the silvicultural problems which must be solved in the practice of forestry in America are fortunately less complicated than the presence of so many kinds of trees in forests of such diverse types would naturally seem to indicate.

The forest fire problem is one of the most difficult with which the American forester has to deal. It is probable that forest

fires have had more to do with the character and distribution of forests in America than any other factor except rainfall. With an annual range over thousands of square miles, in many portions of the United States they occur regularly year after year on the same ground. Trees whose thick bark or abundant seeding gives them peculiar powers of resistance, frequently owe their exclusive possessions of vast areas purely to the action of fire. On the economic side fire is equally influential. The probability, or often the practical certainty, of fire after the first cut, commonly determines lumbermen to leave no merchantable tree standing. Forest fires are thus the most effective barriers to the introduction of forestry. Excessive taxation of timber land is another of almost equal effect. Because of it lumbermen hasten to cut, and afterwards often to abandon, lands which they cannot afford to hold. This evil, which only the progress of public sentiment can control, is especially prevalent in certain portions of the white pine belt.

Forest Associations.—Public sentiment in favour of the protection of forests is now widespread and increasingly effective throughout the United States. As the general understanding of the objects and methods of forestry becomes clearer, the tendency, formerly very marked, to confound ornamental tree planting and botanical matters with forestry proper is rapidly growing less. At the same time, the number and activity of associations dealing with forest matters is increasing with notable rapidity. There are now about thirty such associations in the United States. One of these, the Society of American Foresters, is composed exclusively of professional foresters. The American Forestry Association is the oldest and largest. It has been influential in preparing the ground work of popular interest in forestry, and especially in advocating and securing the adoption of the federal forest reservation policy, the most important step yet taken by the national government. It publishes as its organ a monthly magazine called *Forestry and Irrigation*. The Pennsylvania Forestry Association has been instrumental in placing that state in the forefront of forest progress. Its organ is a bi-monthly publication called *Forest Leaves*. Other states which have associations or societies of special influence in forest matters are California, Massachusetts, Minnesota, Colorado, New Hampshire, Georgia and Oregon. Arbor Day, instituted in Nebraska in 1872 as a day for shade-tree planting by farmers who had settled on the treeless prairies, has been taken up as a means of interesting school children in the planting of trees, and has spread until it is now observed in every state and territory. It continues to serve an admirable purpose.

Lumbering.—According to the census report for 1905 the capital invested in logging operations in the United States was \$90,454,596, the number of employes engaged 146,596, and their wages \$66,990,000; sawmills represented an invested capital of \$381,621,000, and employed 223,674 persons, whose wages were \$100,311,000, while planing mills represented a

capital of \$222,294,000 and employed 132,030 persons whose wages were \$66,434,000.

All the operations of the lumber trade in the United States are controlled, and to no small degree determined, by the peculiar unit of measure which has been adopted. This unit, the board-foot, is generally defined as a board one foot long, one foot wide and one inch thick, but in reality it is equivalent to 144 cub. in. of manufactured lumber in any form. To purchase logs by this measure one must first know about what each log will yield in one-inch boards. For this purpose a scale or table is used, which gives the contents of logs of various diameters and lengths in board feet. Under such a standard the purchaser pays for nothing but the saleable lumber in each log, the inevitable waste in slabs and sawdust costing him nothing.

The table at foot gives the estimated consumption of wood for certain purposes in the United States in 1906.

In addition to this amount, an immense quantity of wood is used each year for fuel, posts and other domestic purposes, and the total annual consumption is not less than 20 billion cub. ft.

The years 1890 to 1906 were marked by rapid changes in the rank of the important timber trees with reference to the amount of timber cut, and a shifting of the important centres of production. Among coniferous trees, white pine has yielded successively to yellow pine and Douglas fir, while the scene of greatest activity has shifted from the Northern forest to the Southern, and from there is rapidly shifting to the Pacific Coast. The total cut of coniferous lumber has increased steadily, but that of the hardwoods is falling off, and in 1906 it was 15% less than in 1899, while inferior hardwoods are gradually assuming more and more importance, and the scene of greatest activity has passed from the middle west to the south and the Appalachian region.

Conifers.—The coniferous supply of the country is derived from four forest regions: (1) The Northern forest; (2) the Southern forest; (3) the Pacific Coast forest; and (4) the Rocky Mountain forest.

1. The Northern forest was long the chief source of the coniferous lumber production in the United States. The principal timber tree of this region is the white pine, usually known in Europe as the Weymouth pine. It has an average height when mature of 110 ft., with a diameter a little less than 3 ft., but the virgin timber is approaching exhaustion. White pine was one of the first trees to be cut extensively in the United States, and Maine, the pine tree state, was at first the centre of production. In 1851 the cut of white pine on the Penobscot river was 144 million ft., that of spruce 14 million and of hemlock 11 million. Thirty years later the pine cut had sunk to 23 million, spruce had risen to 118 million, and hemlock had passed pine by a million feet. Meanwhile, the centre of production had passed from the north woods to the Lake States, and for many years this region was the scene of the most vigorous lumbering activity in the world. The following figures show the cut for the Lake

Product.	Output 1906.	Equivalent Wood Volume.	Estimated Woods Waste. ¹	Estimated Mill Waste. ²	Total Wood Volume Consumed.
		Million cub. ft.	Million cub. ft.	Million cub. ft.	Million cub. ft.
Lumber—					
Conifers	30,200,000 thousand bd. ft.	2517	1173	2170	5860
Hardwoods	7,300,000 " "	612	577	461	1650
Shingles	11,900,000 " "	107	54	109	270
Pulpwood	2,900,000 cords	261	79	..	340
Wood distillation	1,200,000 "	108	12	..	120
Heading	146,000,000 sets	32	33	45	110
Staves—					
Tight cooperage	267,000,000	22	36	32	90
Slack cooperage	1,097,000,000	27	22	21	70
Poles	3,500,000	35	15	..	50
Veneer	300,000 thousand bd. ft.	50	30	..	80
Round mine timbers	165,000,000 cub. ft.	165	35	..	200
Hewn cross ties	77,500,000	207	503	..	710
		4143	2569	2838	9550

¹ Woods waste includes tops, stumps, cull logs and butts, but does not include defective trees left or trees used for road purposes.

² Mill waste includes bark, kerf, slabs and edgings.

States from 1873 to 1906. It is certain that the remarkable decline in the cut of white pine which these figures show will continue still farther.

1873 . . .	3,993,780,000	1890 . . .	8,597,659,352
1874 . . .	3,751,306,000	1891 . . .	7,879,948,349
1875 . . .	3,968,553,000	1892 . . .	8,594,222,802
1876 . . .	3,879,046,000	1893 . . .	7,326,263,782
1877 . . .	3,595,333,496	1894 . . .	6,821,516,412
1878 . . .	3,629,472,759	1895 . . .	7,050,669,235
1879 . . .	4,806,943,000	1896 . . .	5,725,763,035
1880 . . .	5,651,295,000	1897 . . .	6,233,454,000
1881 . . .	6,768,856,749	1898 . . .	6,155,300,000
1882 . . .	7,552,150,744	1899 . . .	6,056,508,000
1883 . . .	7,624,789,786	1900 . . .	5,485,261,000
1884 . . .	7,935,033,054	1901 . . .	5,336,000,000
1885 . . .	7,053,094,555	1902 . . .	5,294,000,000
1886 . . .	7,425,368,443	1903 . . .	4,792,000,000
1887 . . .	7,757,916,784	1904 . . .	4,220,000,000
1888 . . .	8,388,716,460	1905 . . .	3,777,000,000
1889 . . .	8,183,050,755	1906 . . .	3,032,000,000

Second to the white pine among the coniferous lumber trees of the Northern forest is the hemlock (*Tsuga canadensis*). It is used chiefly for construction purposes and furnishes a comparatively low grade of lumber.

The spruce (*Picea rubens*) is used chiefly for lumber, but it is in large and increasing demand in the manufacture of paper pulp. For the latter purpose hemlock, poplar (*Populus tremuloides* and *P. grandidentata*) and several other woods are also employed, but on a smaller scale. The total consumption of wood for paper in the United States for 1906 was 3,660,000 cords, of which 2,500,000 was spruce. Of this, however, 720,000 cords were imported from Canada.

2. The chief product of the Southern forest is the yellow pine. This is the collective term for the longleaf, shortleaf, loblolly and Cuban pines. Of these the longleaf pine (*Pinus palustris* Mill.), called pitch-pine in Europe, is the most important. Its timber is probably superior in strength and durability to that of any other member of the genus *Pinus*, and in addition to its value as a timber tree it is the source of naval stores in the United States. The average size of the mature longleaf pine is 90 ft. in height and 20 in. in diameter. Shortleaf (*Pinus echinata*) and loblolly (*P. taeda*) are other important members of this group. Their wood very closely resembles that of the longleaf pine and is often difficult to distinguish from it. The trees are also of about the same size and height. Loblolly is, however, of more rapid growth. The total cut of yellow pine in 1906 was 11,661,000,000 board ft.; it has perhaps not yet reached its maximum, but is certainly near it.

Another important coniferous tree of the Southern forest is the bald cypress (*Taxodium distichum*), which grows in the swamps. The cut in 1906 was 839,000,000 board ft., a gain of 69% over 1899.

3. But the great supply of coniferous timber is now on the Pacific Coast. The Douglas fir (*Pseudotsuga taxifolia*), also known as Douglas spruce, red fir and Oregon pine, is the foremost tree in Oregon and Washington, and the redwood in California. When mature the Douglas fir averages 200 ft. in height and 4 ft. in diameter, and the redwood 225 ft. in height and 8 ft. in diameter. Other important trees of the Pacific Coast are sugar pine (*Pinus lambertiana*), western red cedar (*Thuja plicata*), western larch (*Larix occidentalis*), Sitka spruce (*Picea sitchensis*), western hemlock (*Tsuga heterophylla*) and western yellow pine (*Pinus ponderosa*). These trees will all be of increasing importance.

Logging on the Pacific Coast is characterized by the use of powerful machinery and by extreme skill in handling enormous weights. This is especially true in California, where the logs of redwood and of the big tree (*Sequoia Washingtoniana*) are often more than 10 ft. in diameter. Logging is usually done by wire cables operated by donkey-engines. The journey to the mill is usually by rail. The mills are often of great size, built on piles over tide water and so arranged that their product is delivered directly from the saws and dry kilns to vessels moored alongside. The products of the Pacific Coast forest make their way over land to the markets of the central and eastern states

and into foreign markets. Among the lumber-producing states, Washington has in seven years jumped from fifth place to first, and its output has increased from 1,428,000,000 board ft. in 1899 to 4,305,000,000 ft. in 1906. Oregon and California have increased their output from 734,000,000 each in 1899 to 1,605,000,000 and 1,349,000,000 ft. respectively in 1906. Of the total output of these three states (7,259,000,000 ft.) 4,880,000,000 ft. is Douglas fir and 660,000,000 redwood.

4. The important lumber trees of the Rocky Mountain forest are the western yellow pine, the lodgepole pine, the Douglas fir and the Engelmann spruce. The Douglas fir, here extremely variable in size and value, reaches in this region average dimensions of perhaps 80 ft. in height by 2 ft. in diameter, the western yellow pine 90 ft. by 3 ft. and the Engelmann spruce 60 ft. by 2 ft. Mining, railroad and domestic uses chiefly absorb the annual timber product, which is considerable in quantity, and of vast importance to the local population. The lumber output of the Rocky Mountain region is, however, increasing very rapidly both in the north and in the south-west. One of the largest mills in the United States is in Idaho.

The following table summarizes the cut of the important coniferous species during the years 1899-1906:

Kind.	1899.	1904.	1906.	Per Cent Increase (+) or Decrease (-) since 1899.
	Million ft.	Million ft.	Million ft.	
Yellow Pine . . .	9,659	11,533	11,661	+ 20.7
Douglas Fir . . .	1,737	2,928	4,970	+ 186.2
White Pine . . .	7,742	5,333	4,584	- 40.8
Hemlock . . .	3,421	3,269	3,537	+ 3.4
Spruce . . .	1,448	1,304	1,645	+ 13.6
Western Pine . . .	944	1,279	1,387	+ 46.9
Cypress . . .	496	750	839	+ 69.3
Redwood . . .	360	519	683	+ 83.2
Cedar . . .	233	223	358	+ 53.7
	26,040	27,138	29,664	+ 14

Hardwoods.—The hardwood supply of the country is derived almost entirely from the eastern half of the continent, and comes from each of the three great Eastern forest regions.

The following table shows the cut of the important species of hardwoods for 1899 and 1906:

Kind.	1899.	1906.	Per Cent Increase (+) or Decrease (-).
	Thousand Feet.	Thousand Feet.	
Oak . . .	4,438,027	2,820,393	- 36.5
Maple . . .	633,466	882,878	+ 39.4
Poplar . . .	1,115,242	693,076	- 37.9
Red gum . . .	285,417	453,678	+ 59.0
Chestnut . . .	206,688	407,379	+ 97.1
Basswood . . .	308,069	376,838	+ 22.3
Birch . . .	132,601	370,432	+ 179.4
Cottonwood . . .	415,124	263,996	- 36.4
Beech . . .	(a)	275,661	..
Elm . . .	456,731	224,795	- 50.8
Ash . . .	269,120	214,460	- 20.8
Hickory . . .	96,636	148,212	+ 53.4
Tupelo . . .	(a)	47,882	..
Walnut . . .	38,681	48,174	+ 24.5
Sycamore . . .	29,715	(a)	..
All other . . .	208,504	87,637	- 58.0
Total . . .	8,634,021	7,315,491	- 15.3

a Not separately reported.

Oak, which in 1899 furnished over half the entire output, has fallen off 36.5%. Yellow poplar, which in 1899 was second among the hardwoods, has fallen off 38% and now occupies third place; and elm, the great stand-by in slack cooperage, has fallen 50.8%. On the other hand less valuable species like maple and red gum have advanced 39 and 59% respectively.

The decrease is largely due to the fact that the hardwoods grow naturally on the better classes of soil, and in the eastern

United States where the population has always been the densest, and as a consequence of this, a large proportion of the original hardwood land has been cleared up and put under cultivation. The hardwood supply of the future must be obtained chiefly from the Appalachian region, where the conditions are less favourable to agriculture.

In addition to the lumber cut, enormous quantities of hardwoods are used each year for railroad ties, telephone and other poles, piles, fence posts and fuel, and there is a great amount of waste in the course of lumbering and manufacture.

AUTHORITIES.—Sargent, *Silva of North America* (Boston, 1891-1897); *Manual of Trees of North America* (Boston, 1903); Lemmon, *Handbook of West American Cone-Bearers* (San Francisco, 1895); Bruncken, *North American Forests and Forestry* (New York, 1900); Fernow, *Economics of Forestry* (New York, 1902); Pinchot, *The Adirondack Spruce* (New York, 1898); Pinchot and Graves, *The White Pine* (New York, 1896). See also the various publications of the U.S. forest service, including especially the following general works: *Forest Influences*; *Primer of Forestry*; the *Timber Supply of the United States*; the *Waning Hardwood Supply*; *Forest Products of the United States in 1906*; *Exports and Imports of Forest Products in 1906*; *Federal and State Forest Laws*; *Regulations and Instructions for the Use of the National Forests*; *The Use of the National Forests*; also part v. of the *Nineteenth and of the Twenty-first Annual Reports of the United States Geological Survey*, and vol. ix. of the *10th Census Report on the Forests of North America*; and *Reports of the State Forestry Commissions of New York, New Hampshire, Maine, Pennsylvania, Michigan, Ohio, &c.*, and of the *State Geological Surveys of New Jersey, Maryland and North Carolina.* (G. P.)

FOREY, ÉLIE FRÉDÉRIC (1804-1872), marshal of France, was born at Paris on the 5th of January 1804, and entered the army from St Cyr in 1824. He took part in the earlier Algerian campaigns, and became captain in 1835. Four years later he was given command of a battalion of *chasseurs à pied* and in 1844 he became colonel. At the Revolution of 1848 Cavaignac made him a general of brigade. He took an active part in the *coup d'état* of the 2nd of December 1851, and Napoleon III. made him a general of division shortly afterwards. He held a superior command in the Crimean War, and in the Italian campaign of 1859 distinguished himself very greatly in the action of Montebello (20th May). In 1862 Forey was placed in command of the French expeditionary corps in Mexico, with the fullest civil and military powers, and he crowned a successful campaign by the capture of Mexico city in May 1863, receiving as his reward the marshal's bâton. From December 1863 to 1867 he held high commands in France, but in the latter year he was struck with paralysis and had to retire. Marshal Forey died at Paris on the 20th of June 1872.

FORFAR, a royal, municipal and police burgh, and capital of the county of Forfarshire, Scotland. Pop. (1901) 12,117. It lies at the east end of the Loch of Forfar in the valley of Strathmore, and is 13 m. N. by E. of Dundee by road and 21½ m. by the Caledonian railway. It is also situated on the same company's main line to Aberdeen and sends off a branch to Brechin. The principal buildings comprise the court house, the county hall (with portraits by Raeburn, Romney, Opie and others), the town hall, the Meffan Institute (including the free library), the infirmary, poorhouse and the Reid hall, founded by Peter Reid, a merchant in the burgh who also gave the public park. The burgh unites with Montrose, Arbroath, Brechin and Inverbervie (the Montrose group of burghs) in returning one member to parliament. The Loch of Forfar, 1½ m. long by ¼ m. wide, is drained by Dean Burn, and contains pike and perch. On a gravel bank or spit in the north-west of the lake stood a castle which was sometimes used as a residence by Margaret, queen of Malcolm Canmore. The staple industries are linen and jute manufactures, but brewing, tanning, bleaching, ropemaking and iron-founding are also carried on.

Forfar is at least as old as the time of Malcolm Canmore, for the first parliament after the defeat of Macbeth met in the old castle, which stood on a mound on the northern side of the town. The parliaments of William the Lion, Alexander II. and Robert II. also assembled within its walls. The town, which was created a royal burgh by David I., was burnt down about the middle of the 13th century. Edward I. captured the

castle on one of his incursions, but in 1307 Robert Bruce seized it, put its defenders to the sword and then destroyed it, its site being now marked by the town cross. Previous to the reign of James VI. the weekly market was held on Sunday, but after the union of the crowns parliament enacted that it should be held on Friday. The town sided with Charles I. during the Civil War, and Charles II. presented the Cross to it out of regard for the loyalty shown to his father. Forfar seems to have played a less reputable part in the persecution of witches. In 1661 a crown commission was issued for the trial of certain miserable creatures, some of whom were condemned to be burnt. In the same year one John Ford for his services as a witch-finder was admitted a burgess along with Lord Kinghorne. The witches' bridle, a gag to prevent them from speaking whilst being led to execution, is still preserved in the county hall. One mile to the E. lie the ruins of Restennet Priory, where a son of Robert Bruce was buried. For twenty five years after the Reformation it was used as the parish church and afterwards by the Episcopalians, until they obtained a chapel of their own in 1822.

FORFARSHIRE, or **ANGUS**, an eastern county of Scotland, bounded N. by the shires of Kincardine and Aberdeen, W. by Perthshire, S. by the Firth of Tay and E. by the North Sea. It has an area of 559,171 acres, or 873.7 sq. m. The island of Rossie and the Bell Rock belong to the shire.

Forfarshire is characterized by great variety of surface and may be divided physically into four well-marked sections. In the most northerly of these many of the rugged masses of the Grampians are found; this belt is succeeded by Strathmore, or the Howe of Angus, a fertile valley, from 6 to 8 m. broad, which is a continuation of the Howe of the Mearns, and runs south-westwards till it enters Strathearn, to the south-west of Perth; then come the Sidlaw Hills and a number of isolated heights, which in turn give way to the plain of the coast and the Firth. The mountains are all in the northern division and belong to the Binchinnin group (sometimes rather inexactly called the Braes of Angus) of the Grampian ranges. Among the highest masses, most of which lie on or near the confines of the bordering counties, are Glas Maol (3502 ft.) on the summit of which the shires of Aberdeen, Forfar and Perth meet, Cairn-na-Glasha (3484), Fafernne (3274), Broad Cairn (3268), Creag Leacach (3238), Tolmount (3143), Tom Buidhe (3140), Driesh (3105), Mount Keen (3077) and Mayar (3043), while peaks of upwards of 2000 ft. are numerous. The Sidlaw Hills—the greater part of which, however, belongs to Perthshire—are much less lofty and of less striking appearance. They have a breadth of from 3 to 6 m., the highest points within the county being Craigowl Hill (1493 ft.), Auchterhouse Hill (1399) and Gallow Hill (1242). None of the rivers is navigable, and only three are of any importance. The Isla, rising in Cairn-na-Glasha, flows southwards, then turns S.E. and finally S.W. till it enters the Tay after a course of 45 m. Its chief tributaries on the right are the Alyth, Erich and Lunan, and on the left the Newton, Melgam and Dean. Near Bridge of Craig is the fall of Reekie Linn (70 ft.), so named from the fact that when the stream is in flood the spray rises in a dense cloud like smoke (*reek*). Near old Airlie Castle are the cascades called the Slugs of Auchrannie. The North Esk, formed by the confluence of the Lee and Mark at Invermark, after a south-easterly course of 28 m. enters the North Sea 3 m. N. of Montrose. On the right bank it receives the West Water and Cruick and on the left the Tarf and Luther. It gives the title of earl of Northesk to a branch of the Carnegie family. The South Esk rises in the Grampians near Mount Fafernne and not far from its source forms the Falls of Bachnagairn; after flowing towards the south-east, it bends eastwards near Tannadice and reaches the North Sea at Montrose, the length of its course being 48 m. Its principal affluents are the Prosen on the right and the Noran on the left. It supplies the title of earl of Southesk to another branch of the Carnegies. The lakes are small, the two largest being the Loch of Forfar and the mountain-girt Loch Lee (1 m. long by ¼ m. wide). Lintrathen (circular in shape and about ¾ m. across), to the north of Airlie Castle, supplies Dundee with drinking water. The glens of the Forfarshire

Grampians are remarkable for their beauty, and several of them for the wealth of their botanical specimens. The largest and finest of them are Glen Isla, in which are the ruins of Forter Castle, destroyed by Argyll in 1640, and the earl of Airlie's shooting-lodge of the Tulchan; Glen Clova, near the entrance to which stands Cortachy Castle, the seat of the earl of Airlie; Glen Esk and Glen Prosen.

Geology.—A great earth fracture traverses this county from near Edzell on the N.E. to Lintrathen Loch on the S.W. Between Cortachy and the south-western boundary this fault runs in Old Red Sandstone, but north-east of that place it forms the junction line of Silurian and Old Red; and in a general way we may say that on the N.W. side of the fault the metamorphosed Silurian rocks are found, while the remainder of the county is occupied by the Old Red Sandstone. On the margin of the disturbance the Silurian rocks are little-altered grey and green clay slates with bands of pebbly grit; farther towards the N.W. we find the same rocks metamorphosed into mica schists and gneisses with pebbly quartzites. Rising up through the schists between Carn Bannock and Mount Battock is a great mass of granite. The Old Red Sandstone extends from this county into Perthshire and Kincardineshire; here some 20,000 ft. of these deposits are seen; an important part being formed of volcanic tuffs and lavas which are regularly interbedded in the sandstones and conglomerates. North of Dundee some of the lower beds are traversed by intrusive dolerites, and Dundee Law is probably the remains of an old vent through which some of the contemporaneous lavas, &c., were discharged. The Old Red Rocks have been subjected to a good deal of folding, as may be seen along the coast. The principal direction of strike is from N.E. to S.W. A synclinal fold occupies Strathmore, and between Longforgan and Montrose the northern extension of the Sidlaw Hills is an anticlinal fold. Two fish-bearing beds occur in the county; from the lower one many large *Eurypterids* have been obtained. The well-known paving flags of Arbroath belong to the lower part of the formation. The Upper Old Red Sandstone is found only in one spot about a mile north of Arbroath. During the Glacial period the ice travelled south-eastward across Strathmore and over the Sidlaw Hills; abundant evidence of this transporting agent is to be seen in the form of morainic deposits, the most striking of which is the great transverse barrier of Glenairn in the valley of the S. Esk, half a mile in length and about 200 ft. high. Relics of the same period are found round the coast in the form of raised beaches at 100, 50 and 25 ft. above the present sea-level.

Climate and Agriculture.—On the whole the climate is healthy and favourable to agricultural pursuits. The mean temperature for the year is 47.3° F., for January 38° and for July 59°. The average annual rainfall is 34 in., the coast being considerably drier than the uplands. In the low-lying districts of the south the harvest is nearly as early as it is in the rest of Scotland, but in the north it is often late. The principal wheat districts are Strathmore and the neighbourhood of Dundee and Arbroath; and the yield is well up to the best Scottish average. Barley, an important crop, has increased steadily. Oats, however, though still the leading crop, have somewhat declined. Potatoes are mostly grown near the seaboard in the higher ground; turnips also are largely raised. The northern belt, where it is not waste land, has been turned into sheep walks and deer forests. The black-faced sheep are the most common in the mountainous country; cross-bred sheep in the lowlands. Though it is their native county (where they date from 1808), polled Angus are not reared so generally as in the neighbouring shire of Aberdeen, but shorthorns are a favourite stock and Irish cattle are imported for winter-feeding. Excepting in the vicinity of the towns there are no dairy farms. Horses are raised successfully, Clydesdales being the commonest breed, but the small native garrons are now little used. Pigs also are reared. Save perhaps in the case of the crofts, or very small holdings of less than 10 acres, farm management is fully abreast of the times.

Other Industries.—The staple industries are the jute and flax manufactures. Their headquarters are in Dundee, but they flourish also at other places. Shipbuilding is carried on at Dundee, Arbroath and Montrose. The manufactures of jams, confectionery, leather, machinery, soap and chemicals, are all of great and growing value. Sandstone quarries employ many hands and the deep-sea fisheries, of which Montrose is the centre, are of considerable importance. The netting of salmon at the mouth of the North Esk is also a profitable pursuit.

Two railway companies serve the county. The North British, entering from the south by the Tay Bridge, follows the coast north-eastwards, sending off at Montrose a branch to Bervie. The Caledonian runs up Strathmore to Forfar, whence it diverges due east to Guthrie, where it again resumes its north-easterly course to Dubton and Marykirk; it reaches Dundee from Perth by the shore of the estuary of the Tay, and sends branches from Dundee to Kirriemuir via Monikie and Forfar and to Alyth Junction via Newtyle, while a short line from Dubton gives it touch with Montrose.

Population and Government.—The population was 277,735 in 1891, and 284,083 in 1901, when 1303 spoke Gaelic and English, and 13 Gaelic only. The chief towns are Arbroath (pop. in 1901, 22,398), Brechin (8941), Broughty Ferry (10,484), Carnoustie (5204), Dundee (161,173), Forfar (11,397), Kirriemuir (4096), Monifieth (2134) and Montrose (12,427). Forfarshire returns one member to Parliament. It is a sheriffdom and there is a resident sheriff-substitute at Dundee and another at Forfar, the county town, and courts are held also at Arbroath. In addition to numerous board schools there are secondary schools at Dundee, Montrose, Arbroath, Brechin, Forfar and Kirriemuir, and technical schools at Dundee and Arbroath. Many of the elementary schools earn grants for higher education. The county council and the Dundee and Arbroath town councils expend the "residue" grant in subsidizing science and art and technical schools and classes, including University College, the textile school, the technical institute, the navigation school, and the workshop schools at Dundee, the technical school at Arbroath, besides cookery, dairy, dress-cutting, laundry, plumbing and veterinary science classes at different places.

History.—In the time of the Romans the country now known as Forfarshire was inhabited by Picts, of whose occupation there are evidences in remains of weems, or underground houses. Traces of Roman camps and stone forts are common, and there are vitrified forts at Finhaven, Dumsturdy Muir, the hill of Laws near Monifieth and at other points. Spearheads, battle-axes, sepulchral deposits, Scandinavian bronze pins, and other antiquarian relics testify to periods of storm and stress before the land settled down into order, towards which the Church was a powerful contributor. In the earliest days strife was frequent. The battle in which Agricola defeated Galgacus is supposed to have occurred in the Forfarshire Grampians (A.D. 84); the Northumbrian King Egfrith and the Pictish king Burde fought near Dunnichen in 685, the former being slain; conflicts with the Danes took place at Aberlemno and other spots; Elpin king of the Scots was defeated by Aengus in the parish of Liff in 730; at Restennet, about 835, the Picts and Scots had a bitter encounter. In later times the principal historical events, whether of peace or war, were more immediately connected with burghs than with the county as a whole. There is some doubt whether the county was named Angus, its title for several centuries, after a legendary Scottish prince or from the hill of Angus to the east of the church of Aberlemno. It was early governed by hereditary earls and was made a hereditary sheriffdom by David II. The first earl of Angus (by charter of 1389) was George Douglas, an illegitimate son of the 1st earl of Douglas by Margaret Stuart, who was countess of Angus in her own right. On the death of the 1st and only duke of Douglas, who was also 13th earl of Angus, in 1761, the earldom merged in the dukedom of Hamilton. Precisely when the shire became known by the name of the county town has not been ascertained, but probably the usage dates from the 16th century. Among old castles are the roofless square tower of Red Castle at the mouth of the Lunan; the tower of the castle of Auchinleck; the stronghold of Inverquharity near Kirriemuir; the castle of Finhaven; the two towers of old Edzell Castle; the ruins of Melgund Castle, which are fairly complete; the small castle of Newtyle, and the old square tower and gateway of the castle of Craig.

See A. Jervise, *Memorials of Angus and Mearns* (Edinburgh, 1895); *Land of the Lindsays* (Edinburgh, 1882); *Epitaphs and Inscriptions* (Edinburgh, 1879); Earl of Crawford, *Lives of the*

Lindsays (London, 1835); Sir W. Fraser, *History of the Carnegies* (Edinburgh, 1867); A. H. Millar, *Historical Castles and Mansions* (Paisley, 1890); G. Hay, *History of Arbroath* (Arbroath, 1876); D. D. Black, *History of Brechin* (Edinburgh, 1867).

FORFEITURE (from "forfeit," originally an offence, and hence a fine exacted as a penalty for such; derived through the O. Fr. *forfait*, from the late Lat. *foris factum*, a trespass, that which is done *foris*, outside), in English law, the term applied (1) to loss or liability to the loss of property in consequence of an offence or breach of contract; (2) to the property of which the party is deprived.

Under the common law, conviction and attainder on indictment for treason or felony was followed not only by forfeiture of the life of the offender, but also by forfeiture of his lands and goods. In the case of treason all the traitor's lands of whomsoever holden were forfeited to the king; in the case of felony (including *felo-de-se*, or suicide), the felon's lands escheated (*exceiderunt*) to his immediate lord, subject to the king's right to waste them for a year and a day. This rule did not apply to lands held in gavelkind in the county of Kent. The goods of traitors and felons were forfeited to the king. The desire of the king and his officers to realize the profits of these forfeitures was one of the chief motives for instituting the circuits of the king's justices throughout England; and from time to time conflicts arose from attempts by these justices to extend the law of treason—under which the king levied all the forfeitures—at the expense of felony, in which the lord of the felon benefited by the escheats. As regards theft, the king's rights overrode those of the owner of the stolen property, until, in the reign of Henry VIII., provision was made for restitution of the goods to the owner if he prosecuted the thief to conviction. In Pepys's *Diary*, 21st of January 1667–1668, will be found an illustration of the working of the old law. We find that on the suicide of his brother-in-law, Pepys at once applied to the king personally and obtained a grant of the brother-in-law's estate in favour of his widow and children should the inquest find a verdict of *felo-de-se*. It was common practice for persons anticipating conviction for treason or felony to assign all their property to others to avoid the forfeiture; and in some instances the accused refused to plead to the indictment and endured the *peine forte et dure*, until death supervened, to avoid these consequences of conviction. The royal rights to forfeitures arising within particular areas were frequently granted by charter to corporations or individuals. In 1897 the courts had to interpret such charters granted to the town of Nottingham in 1399 and 1448. All forfeitures and escheats with respect to conviction and attainder for treason and felony were abolished as from the 4th of July 1870, except forfeitures consequent upon the now disused process of outlawry, and the forfeitures included in the penalties of *praemunire*.

The term "forfeit" is also applied to penalties imposed by statute for acts or omissions which are neither treasonable nor felonious. In such statutes the forfeiture enures in favour of the crown unless the statute indicates another destination; and unless a particular method of enforcing the forfeiture is indicated it is enforceable as a debt to the crown and has priority as such. The words "forfeit and pay" are often used in imposing a pecuniary penalty for a petty misdemeanour, and where they are used the court dealing with the case must not only convict the offender but adjudicate as to the forfeiture.

Statutory forfeitures in some cases extend to specific chattels, e.g. of a British merchant-ship when her character as such is fraudulently dissimulated (Merch. Shipp. Act 1894, ss. 70, 76), or of goods smuggled in contravention of the customs acts or books introduced in violation of the copyright acts. Recognisances are said to be forfeited when the conditions are broken and an order of court is made for their enforcement as a crown debt against the persons bound by them.

The term "forfeiture" is now most commonly used with reference to real property, i.e. with reference to the rights of lords of the manor or lessors to determine the estate or interest of a copyholder or lessee for breach of the customary or con-

tractual terms of tenure. It is also applied to express the deprivation of a limited owner of settled property, real or personal, for breach of the conditions by which his rights are limited; e.g. by becoming bankrupt or attempting to charge or alienate his interest. As a general rule, the courts "lean against forfeitures" of this kind; and are astute to defeat the claim of the superior landlord or other person seeking to enforce them. By legislation of 1881 and 1892 there is jurisdiction to grant relief upon terms against the forfeiture of a lease for breach of certain classes of covenant, e.g. to pay rent or to insure.

FORGERY (derived through the French from Latin *fabricare*, to construct), in English law, "the fraudulent making or alteration of a writing to the prejudice of another man's right," or "the false making, or making *malo animo*, of any written instrument for the purpose of fraud or deceit." This definition, it will be seen, comprehends all fraudulent tampering with documents. "Not only the fabrication and false making of the whole of a written instrument, but a fraudulent insertion, alteration or erasure, even of a letter, in any material part of a true instrument whereby a new operation is given to it, will amount to forgery,—and this though it be afterwards executed by another person ignorant of the deceit" (Russell on *Crimes and Misdemeanours*, vol. ii.). Changing the word Dale into Sale in a lease, so that it appears to be a lease of the manor of Sale instead of the manor of Dale, is a forgery. And when a country banker's note was made payable at the house of a banker in London who failed, it was held to be forgery to alter the name of such London banker to that of another London banker with whom the country banker had subsequently made his notes payable. As to the fraud, "an intent to defraud is presumed to exist if it appears that at the time when the false document was made there was in existence a specific person, ascertained or unascertained, capable of being defrauded thereby; and this presumption is not rebutted by proof that the offender took or intended to take measures to prevent such person from being defrauded in fact, nor by the fact that he had or thought he had a right to the thing to be obtained by the false document" (Stephen's *Digest of the Criminal Law*). Thus when a man makes a false acceptance to a bill of exchange, and circulates it, intending to take it up and actually taking it up before it is presented for payment, he is guilty of forgery. Even if it be proved as a matter of fact that no person could be defrauded (as when A forges a cheque in B's name on a bank from which B had withdrawn his account), the intent to defraud will be presumed. But it would appear that if A knew that B had withdrawn his account, the absence of fraudulent intention would be inferred. A general intention to cheat the public is not the kind of fraud necessary to constitute forgery. Thus if a quack forges a diploma of the college of surgeons, in order to make people believe that he is a member of that body, he is not guilty of forgery.

The crime of forgery in English law has been from time to time dealt with in an enormous number of statutes. It was first made a statutory offence in 1562, and was punishable by fine, by standing in the pillory, having both ears cut off, the nostrils slit up and seared, the forfeiture of land and perpetual imprisonment. It was made capital, without benefit of clergy in 1634. The most notable cases of those who have suffered the extreme penalty of the law are those of the Rev. Dr W. Dodd in 1777, for forging Lord Chesterfield's name on a bond, and Henry Fauntleroy, a partner in the banking-house of Marsh, Sibbald & Co., for the appropriation by means of forged instruments of money entrusted to the bank, in 1824. "Anthony Hammond, in the title Forgery of his *Criminal Code*, has enumerated more than 400 statutes which contain provisions against the offence" (Sir J. T. Coleridge's notes to Blackstone). Blackstone notices the increasing severity of the legislature against forgery, and says that "through the number of these general and special provisions there is now hardly a case possible to be conceived wherein forgery that tends to defraud, whether in the name of a real or fictitious person, is not made a capital crime." These acts were consolidated in 1830. The later

statutes, fixing penalties from penal servitude for life downwards, were consolidated by the Forgery Act 1861. It would take too much space to enumerate all the varieties of the offence with their appropriate punishments. The following condensed summary is based upon chapter xlv. of Sir J. Stephen's *Digest of the Criminal Law*:

1. Forgeries punishable with penal servitude for life as a maximum are—
 - (a) Forgeries of the great seal, privy seal, &c.
 - (b) Forgeries of transfers of stock, India bonds, exchequer bills, bank-notes, deeds, wills, bills of exchange, &c.
 - (c) Obliterations or alterations of crossing on a cheque.
 - (d) Forgeries of registers of birth, &c., or of copies thereof and others.
2. Forgeries punishable with fourteen years' penal servitude are—
 - (a) Forgeries of debentures.
 - (b) Forgeries of documents relating to the registering of deeds, &c.
 - (c) Forgeries of instruments purporting to be made by the accountant general and other officers of the court of chancery, &c.
 - (d) Drawing bill of exchange, &c., on account of another, per procuration or otherwise, without authority.
 - (e) Obtaining property by means of a forged instrument, knowing it to be forged, or by probate obtained on a forged will, false oath, &c.
3. Forgeries punishable with seven years' penal servitude:—Forgeries of seals of courts, of the process of courts, of certificates, and of documents to be used in evidence, &c.

By the Merchandise Marks Acts 1887 and 1891, forgery of trade marks is an offence punishable on conviction by indictment with imprisonment not exceeding two years or to fine, or both, and on conviction by summary proceedings with imprisonment not exceeding four months or with a fine.

The Forged Transfers Act 1891, made retrospective by the Forged Transfers Act 1892, enables companies and local authorities to make compensation by a cash payment out of their funds for any loss arising from a transfer of their stocks, shares or securities through a forged transfer.

United States.—Forgery is made a crime by statute in most if not all the states, in addition to being a common law cheat. These statutes have much enlarged the common definition of this crime. It is also made a crime by a Federal statute (U.S. Rev. Stat., ch. 5), which includes forgery of national banknotes, letters patent, public bid, record, signature of a judge, land warrants, powers of attorney, ships' papers or custom-house documents, certificates of naturalization, &c.; the punishment is by fine or by imprisonment from one to fifteen years with or without hard labour.

In Illinois, fraudulently connecting together different parts of several banknotes or other genuine instruments so as to produce one additional note or instrument with intent to pass all as genuine, is a forgery of each of them (Rev. Stats. 1901, ch. 38, § 108). The alleged instrument must be apparently capable of defrauding (*Goodman v. People* [1907], 228, Ill. 154).

In Massachusetts, forgery of any note, certificate or bill of credit issued by the state treasurer and receiver general, or by any other officer, for a debt of that commonwealth, or a bank bill of any bank, is punishable by imprisonment for life or any term of years (Rev. Laws 1902, ch. 209, §§ 4 and 5).

In New York, forgery includes the false making, counterfeiting, alteration, erasure or obliteration of a genuine instrument (Penal Code, § 520). An officer or agent of a corporation who with intent to defraud sells, pledges or issues a fraudulent scrip, share certificate, is guilty of forgery in third degree. Falsely making any instrument which purports to be issued by a corporation bearing a pretended signature of a person falsely indicated as an officer of the company, is forgery just as if such person were in truth such officer (*id.* § 519). Counterfeiting railroad tickets is forgery in the third degree. Falsely certifying that the execution of a deed has been acknowledged is forgery (*id.* § 511). So also is the forging a fictitious name (*People v. Browne* [1907], 103 N.Y. suppl. 903). Punishment for forgery in the first degree may be twenty years, in the second degree ten years, in the third degree five years.

In Pennsylvania, fraudulently making, signing, altering, uttering or publishing any written instrument other than bank bills, cheques or drafts, was punishable by fine and imprisonment

“by separate or solitary confinement at labour for a term not exceeding ten years” (L. 1860, March 31); forging bank bills, &c., for a term not exceeding five years. Defacing, removing, or counterfeiting brands from lumber floating in any river is punishable by imprisonment for a term not exceeding two years or a fine (L. 1887, May 23). Fraudulently using the registered mark of another on lumber is punishable by fine or imprisonment by solitary confinement for a term not exceeding three years (*id.*).

In Tennessee, forgery may be committed by typewriting the body of and signature to an instrument which may be the subject of forgery (1906; *State v. Bradley*, 116 Tenn. 711).

In Vermont, the act of 1904, p. 135, no. 115, § 24, authorizes licensees to sell intoxicating liquors only on the written prescription of a legally qualified physician stating that it “is given and necessary for medicinal use.” It was held that a prescription containing no such statement was invalid and the alteration thereof was not forgery (1906; *State v. McManus*, 78 St. 433).

AUTHORITIES.—Pollock and Maitland, *History of English Law*; Stephen, *Digest of Criminal Law*; *History of Criminal Law*; L. O. Pike, *History of Crime in England, 1873-1876*; Russell, *On Crimes*; Archbold, *Criminal Pleadings*.

FORGET-ME-NOT, or SCORPION-GRASS (Ger. *Vergissmeinnicht*, Fr. *grémillet, scorpionne*), the name popularly applied to the small annual or perennial herbs forming the genus *Myosotis* of the natural order *Boraginaceae*, so called from the Greek *mûs*, a mouse, and *oûs*, an ear, on account of the shape of the leaves. The genus is represented in Europe, north Asia, North America and Australia, and is characterized by oblong or linear stem-leaves, flowers in terminal scorpioid cymes, small blue, pink or white flowers, a five-cleft persistent calyx, a salver- or funnel-shaped corolla, having its mouth closed by five short scales and hard, smooth, shining nutlets. The common or true forget-me-not, *M. palustris*, is a perennial plant growing to a height of 6 to 18 in., with rootstock creeping, stem clothed with lax spreading hairs, leaves light green, and somewhat shining, buds pink, becoming blue as they expand, and corolla rotate, broad, with retuse lobes and bright blue with a yellow centre. The divisions of the calyx extend only about one-third the length of the corolla, whereas in the other British species of *Myosotis* it is deeply cleft. The forget-me-not, a favourite with poets, and the symbol of constancy, is a frequent ornament of brooks, rivers and ditches, and, according to an old German tradition, received its name from the last words of a knight who was drowned in the attempt to procure the flower for his lady. It attains its greatest perfection under cultivation, and, as it flowers throughout the summer, is used with good effect for garden borders; a variety, *M. strigulosa*, is more hairy and erect, and its flowers are smaller. In *M. versicolor* the flowers are yellow when first open and change generally to a dull blue; sometimes they are permanently yellowish-white. Of the species in cultivation, *M. dissitiflora*, 6 to 8 in., with large handsome abundant sky-blue flowers, is the best and earliest, flowering from February onwards; it does well in light cool soils, preferring peaty ones, and should be renewed annually from seeds or cuttings. *M. rupicola*, or *M. alpestris*, 2 to 3 in., intense blue, is a fine rock plant, preferring shady situations and gritty soil; *M. azorica* (a native of the Azores) with purple, ultimately blue flowers about half an inch across, has a similar habit but larger flowers; *M. sylvatica*, 1 ft., blue, pink or white, used for spring bedding, should be sown annually in August.

FORGING, the craft of the smith, or “blacksmith,” exercised on malleable iron and steel, in the production of works of constructive utility and of ornament. It differs from founding (*q.v.*) in the fact that the metal is never melted. It is essentially a moulding process, the iron or steel being worked at a full red, or white, heat when it is in a plastic and more or less pasty condition. Consequently the tools used are in the main counterparts of the shapes desired, and they mould by impact. All the operations of forging may be reduced to a few very simple ones: (1) Reducing or drawing down from a larger to a smaller section (“fullering” and “swaging”); (2) enlargement of a smaller to a larger portion (“upsetting”); (3) bending, or turning round

to any angle or curvature; (4) uniting one piece of metal to another ("welding"); (5) the formation of holes by punching; and (6) severance, or cutting off. These include all the operations that are done at the anvil. In none of these processes, the last excepted, is the use of a sharp cutting tool involved, and therefore there is no violence done to the fibre of the malleable metal. Nor have the tools of the smith any sharp edges, except the cutting-off tools or "setts." The essential fact of the flow of the metal, which is viscous when at a full red heat, must never be lost sight of; and in forging wrought iron the judgment of the smith must be exercised in arranging the direction of the fibre in a way best calculated to secure maximum strength.

Fullering denotes the preliminary roughing-down of the material between tools having convex edges; swaging, the completion or finishing process between swages, or dies of definite shape, nearly hemispherical in form. When a bar has to be reduced from larger to smaller dimensions, it is laid upon a fuller or round-faced stake, set in the anvil, or, in some cases, on a flat face (fig. 1), and blows are dealt upon that portion

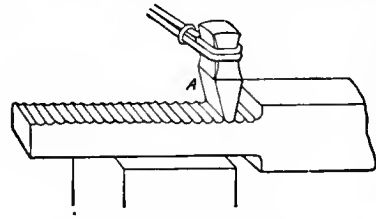

FIG. 1.

of the face which lies exactly opposite with a fullering tool A, grasped by a rather loosely-fitting handle and struck on its head by a sledge. The position of the piece of work is quickly changed at brief intervals in order to bring successive portions under the action of the swages until the reduction is completed; the upper face, and if a bottom fuller is used the under face also, is thus left corrugated slightly. These corrugations are then removed either by a flatter, if the surfaces are plane (fig. 2), or by hollow swages, if the cross section is circular (fig. 3). Spring swages (fig. 4) are frequently used instead of separate "top and bottom tools." Frequently swaging is prac-

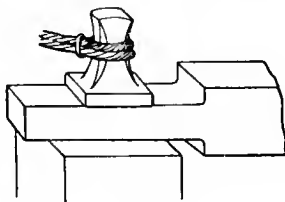

FIG. 2.

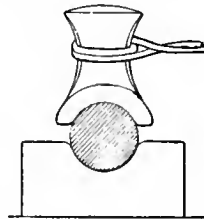

FIG. 3.

tised at once, without the preliminary detail of fullering. It is adopted when the amount of reduction is slight, and also when a steam hammer or other type of power hammer is available. This process of drawing down or fullering is, when practicable, adopted in preference to either upsetting or welding, because it is open to no objection, and involves no risk of damage to the material, while it improves the metal by consolidating its fibres. But its limitations in anvil work lie in the tediousness of the operation, when the part to be reduced is very much less in diameter, and very much longer, than the original piece of bar. Then there are other alternatives.



FIG. 4.

If a long bar is required to have an enlargement at any portion of its length, not very much larger in diameter than the bar, nor of great length, upsetting is the method adopted. The part to be enlarged is heated, the parts adjacent remaining cold, and an end is hammered, or else lifted and dropped heavily on the anvil or on an iron plate, with the result that the heated portion becomes both shortened and enlarged (figs. 5 and 6). This process is only suitable for relatively short lengths, and has the disadvantage that the fibres of wrought iron are liable to open, and so cause weakening of the upset portion. But steel, which has no direction of fibre, can be upset without injury; this method is therefore commonly adopted in steel work, in power presses to an equal extent with drawing down. The alternative to upsetting is generally to weld a larger to a smaller bar or section, or to encircle the bar with a ring and weld the two (fig. 7), and then to impart any shape desired to the ring in swages.

Bending is effected either by the hammer or by the simple exercise of leverage, the heated bar being pulled round a fulcrum. It is always, when practicable, preferable to cutting out a curved or

angular shape with a hot sett or to welding. The continuity of the fibre in iron is preserved by bending, and the risk of an imperfect weld is avoided. Hence it is a simple and safe process which is constantly being performed at the anvil. **Bending.** An objection to sharp bends, or those having a small radius, is that the fibres become extended on the outer radius, the cross section being

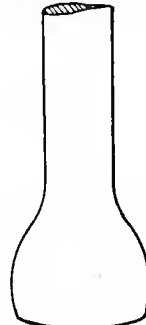

FIG. 5.



FIG. 6.

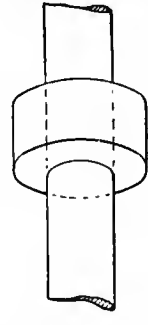

FIG. 7.

at the same time reduced below that of the bar itself. This is met by imparting a preliminary amount of upsetting to the part to be bent, sufficient to counteract the amount of reduction due to extension of the fibres. A familiar example is seen in the corners of dip cranks.

The property possessed by pieces of iron or steel of uniting automatically while in a condition of semi-fusion is very valuable. When portions which differ greatly in dimensions have to be united, welding is the only method practicable at the anvil. It is also generally the best to adopt when union has to be made between pieces at right angles, or when a piece on which much work has to be done is required at the end of a long plain bar, as in the tension rods of cranes and other structures with eyes. The art of welding depends chiefly on having perfectly clean joint



FIG. 8.



FIG. 9.

faces, free from scale, so that metal can unite to metal; union would be prevented by the presence of oxide or of dirt. Also it is essential to have a temperature sufficiently high, yet not such as to overheat the metal. A dazzling white, at which small particles of metal begin to drop off, is suitable for iron, but steel must not be made so hot. A very few hammer blows suffice to effect the actual union; if the joint be faulty, no amount of subsequent hammering will weld it. The forms of weld-joints include the scarf (figs. 8 and 9), the butt (fig. 10), the V (fig. 11) and the glut, one form of which



FIG. 10.



FIG. 11.

is shown in fig. 12; the illustrations are of bars prepared for welding. These forms give the smith a suitable choice for different conditions. A convexity is imparted to the joint faces in order to favour the expulsion of slag and dirt during the closing of the joint; these undesirable matters become entangled between concave faces. The ends are upset or enlarged in order to leave enough metal to be dressed down flush, by swaging or by flatter. The proportional lengths of the joint faces shown are those which conform to good practice. The fluxes used for welding are numerous. Sand alone is generally dusted on wrought iron, but steel requires borax applied on the joint while in the fire, and also dusted on the joint at the anvil and on the face of the latter itself. Electric welding is largely taking the place of the hand process, but machines are required to maintain the parts in contact during the passage of the current. Butt joints are employed, and a large quantity of power is absorbed, but the output is immensely greater than that of hand-made welds.

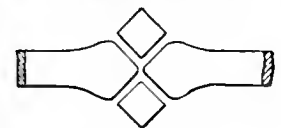

FIG. 12.

When holes are not very large they are formed by punching, but large holes are preferably produced by bending a rod round and welding it, so forming an eye (fig. 13). Small holes are often punched simply as a preliminary stage in the formation of a larger hole by a process of drifting. A piece of work to be punched is supported either on the anvil or on a ring of metal termed a bolster, laid on the anvil, through which the burr, when severed, falls. But in making small holes through a thick mass, no burr is produced, the metal yielding sideways and forming an enlargement or boss. Examples occur in the wrought iron stanchions

that carry light hand railing. In such cases the hole has to be punched from each face, meeting in the centre. Punching under power hammers is done similarly, but occupies less time.

The cutting-off or severance of material is done either on hot or cold metal. In the first case the chisels used, "hot setts," have keener cutting angles than those employed for the second, termed "cold setts." One sett is held in a hole in the anvil face, the "anvil chisel," the other is handled and struck with a sledge.

The difference between iron and steel at the forge is that iron possesses a very marked fibre whereas steel does not. Many forgings therefore must be made differently according as they are in iron or in steel. In the first the fibre must never be allowed to run transversely to the axis of greatest tensile or bending stress, but must be in line therewith. For this reason many

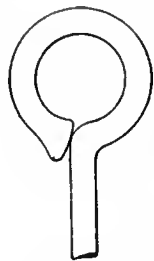

FIG. 13.

forgings, of which a common eye or loop (fig. 13) is a typical example, that would be stamped from a solid piece if made in steel, must be bent round from bar and welded if in wrought iron. Further, welding which is practically uniformly trustworthy in wrought iron, is distrusted in steel. The difference is due to the very fibrous character of iron, the welding of which gives much less anxiety to the smith than that of steel. Welds in iron are frequently made without any flux, those in steel never. Though mention has only been made of iron and steel, other alloys are forged, as those of

aluminium, delta metal, &c. But the essential operations are alike, the differences being in temperature at which the forging is done and nature of the fluxes used for welding. For hardening and tempering, an important section of smith's work, see ANNEALING.

Die Forging.—The smith operating by hand uses the above methods only. There is, however, a large and increasing volume of forgings produced in other ways, and comprehended under the general terms, "die forging" or "drop forging."

Little proof is needed to show that the various operations done at the anvil might be performed in a more expeditious way by the aid of power-operated appliances; for the elementary processes of reducing, and enlarging, bending, punching, &c., are extremely simple, and the most elaborate forged work involves only a repetition of these. The fact that the material used is entirely plastic when raised to a white heat is most favourable to the method of forging in matrices or dies. A white hot mass of metal can be placed in a matrix, and stamped into shape in a few blows under a hammer with as much ease as a medal can be stamped in steel dies under a coining press. But much detail is involved in the translation of the principle into practice. The parallel between coining dies and forging dies does not go far. The blank for the coin is prepared to such exact dimensions that no surplus material is left over by the striking of the coin, which is struck while cold. But the blank used in die forging is generally a shapeless piece, taken without any preliminary preparation, a mere lump, a piece of bar or rod, which may be square or round irrespective of whether the ultimate forging is to be square, or round, or flat or a combination of forms. At the verge of the welding heat to which it is raised, and under the intensity of the impact of hammer blows rained rapidly on the upper die, the metal yields like lead, and flows and fills the dies.

Herein lies a difference between striking a coin and moulding a forging. A large amount of metal is squeezed out beyond the concavity of the forging dies, and this would, if allowed to flow over between the joints, prevent the dies from being closed on the forging. There are two methods adopted for removing this "fin," or "flash" as it is termed, one being that of suppression, applicable to circular work, the other that of stripping, applied to almost all other cases.

The suppression of fin means that the circular bar is rotated in the dies (fig. 14) through a small arc, alternating between every few blows, with the result that the fin is obliterated immediately when formed, this being done at the same time that reduction of section is being effected over a portion or the whole of the bar.

Stripping means that when a considerable amount of fin has

been formed, it is removed by laying the forging on a die pierced right through with an opening of the same shape and area as the forging, and then dealing the forging a blow with the hammer. The forging is thus knocked through the die, leaving the severed or stripped fin behind. The forging is then returned to the dies and again treated, and the stripping may be repeated twice, or even oftener, before the forging can be completed.

Figs. 15 and 16 illustrate the bottom dies of a set for forging in a particular form of eye, the top dies being of exactly the same shape. The first operation takes place in fig. 15, in which a bar of metal is reduced to a globular and cylindrical form, being constantly rotated meanwhile. The shank portion is then drawn down in the parallel recess to the left. The shape of the eye is completed in fig. 16, and the shank in the recess to the left of that. Fig. 17 shows how a lever is stamped between top and bottom dies. The hole in the larger boss is formed by punching, the punches nearly meeting in the centre, and the centre for the hole to be drilled subsequently in the smaller boss is located by a conical projection in the top die.

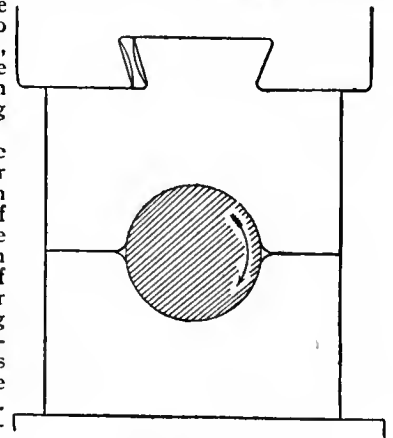

FIG. 14.

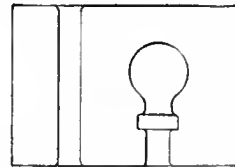

FIG. 15.

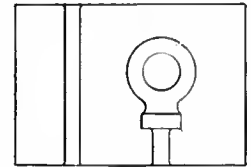

FIG. 16.

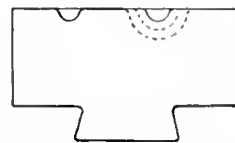
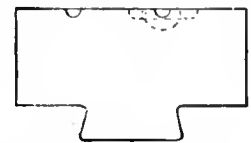

FIG. 17.



It is evident that the methods of die forging, though only explained here in barest outline, constitute a principle of extensive application.

An intricate or ornamental forging, which might occupy a smith a quarter of a day in making at the anvil, can often be produced in dies within five minutes (fig. 18). On the other hand, there is the cost of the preparation of the dies, which is often heavy, so that the question of method is resolved into the relative one of the cost of

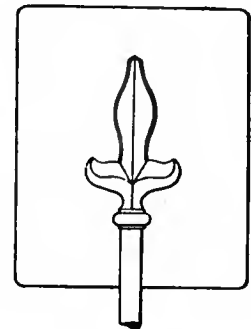
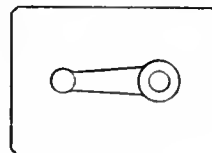
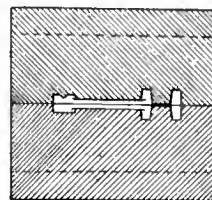

FIG. 18.

dies, distributed over the number of identical forgings required. From this point of view it is clear that given say a thousand forgings, ordered all alike, the cost of even expensive dies distributed over the whole becomes only an infinitesimal amount per forging.

There is, further, the very important fact that forgings which are produced in dies are uniform and generally of more exact dimensions than anvil-made articles. This is seen to be an advantage when forgings have to be turned or otherwise tooled in the engineer's machine shop, since it lessens the amount of work required there.

Besides, for many purposes such forgings do not require tooling at all, or only superficial grinding, while anvil-made ones would, in consequence of their slight inaccuracies.

Yet again, die forging is a very elastic system, and herein lies much of its value. Though it reaches its highest development when thousands of similar pieces are wanted, it is also adaptable to a hundred, or even to a dozen, similar forgings. In such cases economy is secured by using dies of a very cheap character; or, by employing such dies as supplementary to anvil work for effecting neat finish to more precise dimensions than can be ensured at the anvil. In the first case use is made of dies of cast iron moulded from patterns (fig. 19) instead of having their matrices laboriously cut in steel with drills, chisels and milling tools. In the second, preliminary drawing down is done under the steam hammer, and bending and welding at the anvil, or under the steam hammer, until the forgings are brought approximately to their final shape and dimensions.

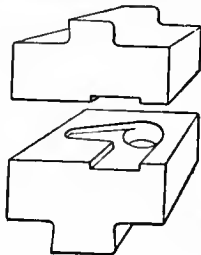

FIG. 19.

Then they are reheated and inserted in the dies, when a few blows under the steam or drop hammer suffice to impart a neat and accurate finish.

The limitations of die forging are chiefly those due to large dimensions. The system is most successful for the smallest forgings and dies which can be handled by one man without the assistance of cranes; and massive forgings are not required in such large numbers as are those of small dimensions. But there are many large articles manufactured which do not strictly come under the term forgings, in which the aid of dies actuated by powerful hydraulic presses is utilized. These include work that is bent, drawn and shaped from steel plate, of which the fittings of railway wagons constitute by far the largest proportion. The dies used for some of these are massive, and a single squeeze from the ram of the hydraulic press employed bends the steel plate between the dies to shape at once. Fairly massive forgings are also produced in these presses.

Die forging in its highest developments invades the craft of the skilled smith. In shops where it is adopted entirely, the only craftsmen required are the few who have general charge of the shops. The men who attend to the machines are not smiths, but unskilled helpers. (J. G. H.)

FORK (Lat. *furca*), an implement formed of two or more prongs at the end of a shaft or handle, the most familiar type of which is the table-fork for use in eating. In agriculture and horticulture the fork is used for pitching hay, and other green crops, manure, &c.; commonly this has two prongs, "tines"; for digging, breaking up surface soil, preparing for hand weeding and for planting the three-pronged fork is used. The word is also applied to many objects which are characterized by branching ends, as the tuning-fork, with two branching metal prongs, which on being struck vibrates and gives a musical note, used to give a standard of pitch; to the branching into two streams of a river, or the junction where a tributary runs into the main river; and in the human body, to that part where the legs branch off from the trunk.

The *furca*, two pieces of wood fastened together in the form of the letter A, was used by the Romans as an instrument of punishment. It was placed over the shoulders of the criminal, and his hands were fastened to it, condemned slaves were compelled to carry it about with them, and those sentenced to be flogged would be tied to it; crucifixions were sometimes carried out on a similar shaped instrument. From the great defeat of the Romans by the Samnites at the battle of the Caudine Forks (*Furculae Caudinae*), a narrow gorge, where the vanquished were compelled to pass under the yoke (*jugum*), as a sign of submission, the expression "to pass through or under the forks" has been loosely used of such a disgraceful surrender. The "forks" in any allusion to this defeat should refer to the topographical name and not to the *jugum*, which consisted of two upright spears with a third placed transversely as a cross-bar.

FORKEL, JOHANN NIKOLAUS (1749-1818), German musician, was born on the 22nd of February 1749 at Meeder in Coburg. He was the son of a cobbler, and as a practical musician, especially as a pianoforte player, achieved some eminence; but his claims to a more abiding name rest chiefly upon his literary skill and deep research as an historian of musical science and literature. He was an enthusiastic admirer of J. S. Bach, whose music he did much to popularize. His library, which was accumulated with care and discrimination at a time

when rare books were cheap, forms a valuable portion of the royal library in Berlin and also of the library of the Königlicher Institut für Kirchenmusik. He was organist to the university church of Göttingen, obtained the degree of doctor of philosophy, and in 1778 became musical director of the university. He died at Göttingen on the 20th of March 1818. The following is a list of his principal works: *Über die Theorie der Musik* (Göttingen, 1777); *Musikalisch kritische Bibliothek* (Gotha, 1778); *Allgemeine Geschichte der Musik* (Leipzig, 1788). The last is his most important work. He also wrote a *Dictionary of Musical Literature*, which is full of valuable material. To his musical compositions, which are numerous, little interest is to-day to be attached. But it is worth noting that he wrote variations on the English national anthem "God save the king" for the clavichord, and that Abt Vogler wrote a sharp criticism on them, which appeared at Frankfurt in 1793 together with a set of variations as he conceived they ought to be written.

FORLÌ (anc. *Forum Livii*), a town and episcopal see of Emilia, Italy, the capital of the province of Forlì, 40 m. S.E. of Bologna by rail, 108 ft. above sea-level. Pop. (1901) 15,461 (town); 43,321 (commune). Forlì is situated on the railway between Bologna and Rimini. It is connected by steam tramways with Ravenna and Meldola, and by a road through the Apennines with Pontassieve. The church of S. Mercuriale stands in the principal square, and contains, besides paintings, some good carved and inlaid choir stalls by Alessandro dei Bigni. The façade has been considerably altered, but the campanile, erected in 1178-1180, still exists; it is 252 ft. in height, square and built of brickwork, and is one of the finest of Lombard campanilli. The pictures in this church are the work of Marco Palmezzano (1456-1537) and others; S. Biagio and the municipal picture gallery also contain works by him. The latter has other interesting pictures, including a fresco representing an apprentice with pestle and mortar (Pestapepe), the only authentic work in Forlì of Melozzo da Forlì (1438-1494), an eminent master whose style was formed under the influence of Piero della Francesca, and who was the master of Palmezzano; the frescoes in the Sforza chapel in SS. Biagio e Girolamo are from the former's designs, though executed by the latter. The church also contains the fine tomb (1466) of Barbara Manfredi. The cathedral (Santa Croce) has been almost entirely rebuilt since 1844. The Palazzo del Podestà, now a private house, is a brick building of the 15th century. The citadel (Rocca Ravaldina), constructed about 1360-1370, and later rebuilt, is now used as a prison. Flavio Biondo, the first Renaissance writer on the topography of ancient Rome (1388-1463), was a native of Forlì.

Of the ancient Forum Livii, which lay on the Via Aemilia, hardly anything is known. In the 12th century we find Forlì in league with Ravenna, and in the 13th the imperial count of the province of Romagna resided there. In 1275 Forlì defeated Bologna with great loss. Martin IV. sent an army to besiege it in 1282, which was driven out after severe fighting in the streets; but the town soon afterwards surrendered. In the 14th and 15th centuries it was under the government of the Ordelaffi; and in 1500 was taken by Caesar Borgia, despite a determined resistance by Caterina Sforza, widow of Girolamo Riario. Forlì finally became a part of the papal state in 1504. (T. As.)

FORLIMPOPOLI (anc. *Forum Popillii*), a village of Emilia, Italy, in the province of Forlì, from which it is 5 m. S.E. by rail, 105 ft. above sea-level. Pop. (1901) 2299 (town); 5795 (commune). The ancient Forum Popillii, a station on the Via Aemilia, was destroyed by Grimuald in 672. Whether its site is occupied by the present town is not certain; the former should perhaps be sought a mile or so farther to the S.E., where were found most of the inscriptions of which the place of discovery is certain. Forlimpopoli was again destroyed by Cardinal Albornoz in 1360, and rebuilt by Sinibaldo Ordelaffi, who constructed the well-preserved medieval castle (1380), rectangular with four circular towers at the corners. (T. As.)

FORLORN HOPE (through Dutch *verloren hoop*, from Ger. *verlorene Haufe* = "lost troop"; *Haufe*, "heap," being equivalent in the 17th century to "body of troops"; the French

equivalent *isenfants perdus*), a military term (sometimes shortened to "forlorn"), used in the 16th and 17th centuries for a body of troops thrown out in front of the line of battle to engage the hostile line, somewhat after the fashion of skirmishers, though they were always solid closed bodies. These troops ran great risks, because they were often trapped between the two lines of battle as the latter closed upon one another, and fired upon or ridden down by their friends; further, their mission was to facilitate the attacks of their own main body by striking the first blow against or meeting the first shock of the fresh and unshaken enemy. In the following century (18th), when lines of masses were no longer employed, a thin line of skirmishers alone preceded the three-deep line of battle, but the term "forlorn hope" continued to be used for picked bodies of men entrusted with dangerous tasks, and in particular for the storming party at the assault of a fortress. In this last sense "forlorn hope," is often used at the present time. The misunderstanding of the word "hope" has led to various applications of "forlorn hope" such as to an enterprise offering little chance of success, or, further still from the original meaning, to the faint or desperate hope of such success.

FORM (Lat. *forma*), in general, the external shape, appearance, configuration of an object, in contradistinction to the matter of which it is composed; thus a speech may contain excellent arguments,—the *matter* may be good, while the style, grammar, arrangement,—the *form*—is bad. The term, with its adjective "formal" and the derived nouns "formality" and "formalism," is hence contemptuously used for that which is superficial, unessential, hypocritical: chap. xxiii. of Matthew's gospel is a classical instance of the distinction between the formalism of the Pharisaic code and genuine religion. With this may be compared the popular phrases "good form" and "bad form" applied to behaviour in society: so "format" (from the French) is technically used of the shape and size, e.g. of a book (octavo, quarto, &c.) or of a cigarette. The word "form" is also applied to certain definite objects: in printing a body of type secured in a chase for printing at one impression ("form" or "forme"); a bench without a back, such as is used in schools (perhaps to be compared with O. Fr. *s'asseoir en forme*, to sit in a row); a mould or shape on or in which an object is manufactured; the lair or nest of a hare. From its use in the sense of regulated order comes the application of the term to a class in a school ("sixth form," "fifth form," &c.); this sense has been explained without sufficient ground as due to the idea of all children in the same class sitting on a single form (bench).

The word has been used technically in philosophy with various shades of meaning. Thus it is used to translate the Platonic *ἰδέα*, *εἶδος*, the permanent reality which makes a thing what it is, in contrast with the particulars which are finite and subject to change. Whether Plato understood these forms as actually existent apart from all the particular examples, or as being of the nature of immutable physical laws, is matter of discussion. For practical purposes Aristotle was the first to distinguish between matter (*ὑλη*) and form (*εἶδος*). To Aristotle matter is the undifferentiated primal element: it is rather that from which things develop (*ὑποκείμενον*, *δύναμις*) than a thing in itself (*ἐνεργεία*). The development of particular things from this germinal matter consists in differentiation, the acquiring of particular *forms* of which the knowable universe consists (cf. CAUSATION for the Aristotelian "formal cause"). The perfection of the form of a thing is its entelechy (*ἐντελέχεια*) in virtue of which it attains its fullest realization of function (*De anima*, ii. 2, ἡ μὲν ὑλη δύναμις τὸ δὲ εἶδος ἐντελέχεια). Thus the entelechy of the body is the soul. The origin of the differentiation process is to be sought in a "prime mover" (*πρῶτον κινῶν*), i.e. pure form entirely separate (*χωριστόν*) from all matter, eternal, unchangeable, operating not by its own activity but by the impulse which its own absolute existence excites in matter (*ὡς ἐρώμενον*, *οὐ κινούμενον*). The Aristotelian conception of form was nominally, though perhaps in most cases unintelligently, adopted by the Scholastics, to whom, however, its origin in the observation of the physical universe was an entirely foreign

idea. The most remarkable adaptation is probably that of Aquinas, who distinguished the spiritual world with its "subsistent forms" (*formae separatae*) from the material with its "inherent forms" which exist only in combination with matter. Bacon, returning to the physical standpoint, maintained that all true research must be devoted to the discovery of the real nature or essence of things. His induction searches for the true "form" of light, heat and so forth, analysing the external "form" given in perception into simpler "forms" and their "differences." Thus he would collect all possible instances of hot things, and discover that which is present in all, excluding all those qualities which belong accidentally to one or more of the examples investigated: the "form" of heat is the residuum common to all. Kant transferred the term from the objective to the subjective sphere. All perception is necessarily conditioned by pure "forms of sensibility," i.e. space and time: whatever is perceived is perceived as having special and temporal relations (see SPACE AND TIME; KANT). These forms are not obtained by abstraction from sensible data, nor are they strictly speaking innate: they are obtained "by the very action of the mind from the co-ordination of its sensation."

FORMALIN, or FORMALDEHYDE, CH_2O or $\text{H}\cdot\text{CHO}$, the first member of the series of saturated aliphatic aldehydes. It is most readily prepared by passing the vapour of methyl alcohol, mixed with air, over heated copper or platinum. In order to collect the formaldehyde, the vapour is condensed and absorbed, either in water or alcohol. It may also be obtained, although only in small quantities, by the distillation of calcium formate. At ordinary temperatures formaldehyde is a gas possessing a pungent smell; it is a strong antiseptic and disinfectant, a 40% solution of the aldehyde in water or methyl alcohol, sold as *formalin*, being employed as a deodorant, fungicide and preservative. It is not possible to obtain the aldehyde in a pure condition, since it readily polymerizes. It is a strong reducing agent; it combines with ammonia to form *hexamethylene tetramine*, $(\text{CH}_2)_6\text{N}_4$, and easily "condenses" in the presence of many bases to produce compounds which apparently belong to the sugars (*g.z.*). It renders glue or gelatin insoluble in water, and is used in the coal-tar colour industry in the manufacture of para-rosaniline, pyronines and rosamines. Several polymers have been described. *Para-formaldehyde*, or trioxymethylene, obtained by concentrating solutions of formaldehyde *in vacuo*, is a white crystalline solid, which sublimes at about 100°C . and melts at a somewhat higher temperature, changing back into the original form. It is insoluble in cold water, alcohol and ether. A diformaldehyde is supposed to separate as white flakes when the vapour is passed into chloroform (Körber, *Pharm. Zeit.*, 1904, xlix. p. 609); F. Auerbach and H. Barschall (*Chem. Zentr.*, 1907, ii. p. 1734) obtained three polymers by acting with concentrated sulphuric acid on solutions of formaldehyde, and a fourth by heating one of the forms so obtained. The strength of solutions of formaldehyde may be ascertained by the addition of excess of standard ammonia to the aldehyde solution (hexamethylene tetramine being formed), the excess of ammonia being then estimated by titration with standard acid. On the formation of formaldehyde by the oxidation of methane at high temperatures, see W. A. Bone (*Journ. Chem. Soc.*, 1902, 81, p. 535; 1903, 83, p. 1074). Formaldehyde also appears to be a reduction product of carbon dioxide (see *Annual Reports of the Chemical Society*).

FORMAN, ANDREW (c. 1465–1521), Scottish ecclesiastic, was educated at the university of St Andrews and entered the service of King James IV. about 1489. He soon earned the favour of this king, who treated him with great generosity and who on several occasions sent him on important embassies to the English, the French and the papal courts. In 1501 he became bishop of Moray and in July 1513 Louis XII. of France secured his appointment as archbishop of Bourges, while pope Julius II. promised to make him a cardinal. In 1514 during a long absence from his own land Forman was nominated by Pope Leo X. to the vacant archbishopric of St Andrews and was made papal legate in Scotland, but it was some time before he secured possession of

the see owing to the attempts of Henry VIII. to subject Scotland to England and to the efforts of his rivals, Gavin Douglas, the poet, and John Hepburn, prior of St Andrews, and their supporters. Eventually, however, he resigned some of his many benefices, the holding of which had made him unpopular, and through the good offices of the regent, John Stewart, duke of Albany, obtained the coveted archbishopric and the primacy of Scotland. Afterwards he was one of the vice-regents of the kingdom and he died on the 11th of March 1521. As archbishop he issued a series of constitutions which are printed in J. Robertson's *Concilia Scotiae* (1866). Mr Andrew Lang (*History of Scotland*, vol. i.) describes Forman as "the Wolsey of Scotland, and a fomenter of the war which ended at Flodden."

See the biography of the archbishop which forms vol. ii. of *The Archbishops of St Andrews*, by J. Herkless and R. K. Hannay (1909).

FORMAN, SIMON (1552–1611), English physician and astrologer, was born in 1552 at Quidham, a small village near Wilton, Wiltshire. At the age of fourteen he became apprentice to a druggist at Salisbury, but at the end of four years he exchanged this profession for that of a schoolmaster. Shortly afterwards he entered Magdalen College, Oxford, where he studied chiefly medicine and astrology. After continuing the same studies in Holland he commenced practice as a physician in Philpot Lane, London, but as he possessed no diploma, he on this account underwent more than one term of imprisonment. Ultimately, however, he obtained a diploma from Cambridge university, and established himself as a physician and astrologer at Lambeth, where he was consulted, especially as a physician, by many persons of rank, among others by the notorious countess of Essex. He expired suddenly while crossing the Thames in a boat on the 12th of September 1611.

A list of Forman's works on astrology is given in Bliss's edition of the *Athenae Oxonienses*; many of his MS. works are contained in the Bodleian Library, the British Museum and the Plymouth Library. *A Brief Description of the Forman MSS. in the Public Library, Plymouth*, was published in 1853.

FORMERET, a French architectural term for the wall-rib carrying the web or filling-in of a vault (*q.v.*).

FORMEY, JOHANN HEINRICH SAMUEL (1711–1797), Franco-German author, was born of French parentage at Berlin on the 31st of May 1711. He was educated for the ministry, and at the age of twenty became pastor of the French church at Brandenburg. Having in 1736 accepted the invitation of a congregation in Berlin, he was in the following year chosen professor of rhetoric in the French college of that city and in 1739 professor of philosophy. On the organization of the academy of Berlin in 1744 he was named a member, and in 1748 became its perpetual secretary. He died at Berlin on the 7th of March 1797. His principal works are *La Belle Wolfienne* (1741–1750, 6 vols.), a kind of novel written with the view of enforcing the precepts of the Wolfian philosophy; *Bibliothèque critique, ou mémoires pour servir à l'histoire littéraire ancienne et moderne* (1746); *Le Philosophe chrétien* (1750); *L'Émile chrétien* (1764), intended as an answer to the *Émile* of Rousseau; and *Souvenirs d'un citoyen* (Berlin, 1789). He also published an immense number of contemporary memoirs in the transactions of the Berlin Academy.

FORMIA (anc. *Formiae*, called Mola di Gaeta until recent times), a town of Campania, Italy, in the province of Caserta, from which it is 48 m. W.N.W. by rail. Pop. (1901) 5514 (town); 8452 (commune). It is situated at the N.W. extremity of the Bay of Gaeta, and commands beautiful views. It lay on the ancient Via Appia, and was much frequented as a resort by wealthy Romans. There was considerable imperial property here and along the coast as far as Sperlonga, and there are numerous remains of ancient villas along the coast and on the slopes above it. The so-called villa of Cicero contains two well-preserved *nymphææ* with Doric architecture. Its site is now occupied by the villa Caposele, once a summer residence of the kings of Naples. There are many other modern villas, and the sheltered hillsides (for the mountains rise abruptly behind the town) are covered with lemon, orange and pomegranate gardens. The now deserted promontory of the Monte Scauri to the E. is

also covered with remains of ancient villas; the hill is crowned by a large tomb, known as Torre Giano. To the E. at Scauri is a large villa with substructions in "Cyclopean" work. The ancient Formiae was, according to the legend, the home of the Laestrygones, and later a Spartan colony (*Ὀρμιαὶ διὰ τὸ εὐορμον*, Strabo v. 3. 6, p. 233). It was a Volscian town, and, like Fundi, received the *civitas sine suffragio* from Rome in 338 (or 332 B.C.) because the passage through its territory had always been secure. This was strategically important for the Romans, as the military road definitely constructed by Appius Claudius in 312 B.C., still easily traceable by its remains, and in part followed by the high-road, traversed a narrow pass, which could easily be blocked, between Fundi and Formiae. In 188 B.C., with Fundi, it received the full citizenship, and, like it, was to a certain extent under the control of a *praefectus* sent from Rome, though it retained its three aediles. Mamurra was a native of Formia. Cicero possessed a favourite villa here, and was murdered in its vicinity in 43 B.C., but neither the villa nor the tomb can be identified with any certainty. It was devastated by Sextus Pompeius, and became a colony, with *duoviri* as chief magistrates, under Hadrian. Portus Caietae (the modern Gaeta) was dependent upon it.

See T. Ashby, "Dessins inédits de Carlo Labruzzi," in *Mélanges de l'école française de Rome* (1903), 410 seq. (T. As.)

FORMIC ACID, H₂CO₂ or H·COOH, the first member of the series of aliphatic monobasic acids of the general formula C_nH_{2n}O₂. It is distinguished from the other members of the series by certain characteristic properties; for example, it shows an aldehydic character in reducing silver salts to metallic silver, and it does not form an acid chloride or an acid anhydride. Its nitrile (prussic acid) has an acid character, a property not possessed by the nitriles of the other members of the series; and, by the abstraction of the elements of water from the acid, carbon monoxide is produced, a reaction which finds no parallel in the higher members of the series. Finally, formic acid is, as shown by the determination of its affinity constant, a much stronger acid than the other acids of the series. It occurs naturally in red ants (Lat. *formica*), in stinging nettles, in some mineral waters, in animal secretions and in muscle. It may be prepared artificially by the oxidation of methyl alcohol and of formaldehyde; by the rapid heating of oxalic acid (J. Gay-Lussac, *Ann. chim. phys.*, 1831 [2] 46, p. 218), but best by heating oxalic acid with glycerin, at a temperature of 100–110° C. (M. Berthelot, *Ann.*, 1856, 98, p. 139). In this reaction a glycerol ester is formed as an intermediate product, and undergoes decomposition by the water which is also produced at the same time.

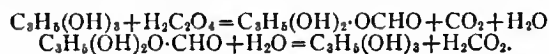

Many other synthetical processes for the production of the acid or its salts are known. Hydrolysis of hydrocyanic acid by means of hydrochloric acid yields formic acid. Chloroform boiled with alcoholic potash forms potassium formate (J. Dumas, *Berzelius Jahresberichte*, vol. 15, p. 371), a somewhat similar decomposition being shown by chloral and aqueous potash (J. v. Liebig, *Ann.*, 1832, 1, p. 198). Formates are also produced by the action of moist carbon monoxide on soda lime at 190–220° C. (V. Merz and J. Tibičira, *Ber.*, 1880, 13, p. 23; A. Geuther, *Ann.*, 1880, 202, p. 317), or by the action of moist carbon dioxide on potassium (H. Kclbe and R. Schmitt, *Ann.*, 1861, 119, p. 251). H. Moissan (*Comptes rend.*, 1902, 134, p. 261) prepared potassium formate by passing a current of carbon monoxide or carbon dioxide over heated potassium hydride,

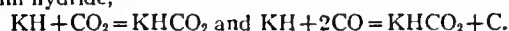

A concentrated acid may be obtained from the diluted acid either by neutralization with soda, the sodium salt thus obtained being then dried and heated with the equivalent quantity of anhydrous oxalic acid (Lorin, *Bull. soc. chim.*, 37, p. 104), or the lead or copper salt may be decomposed by dry sulphuretted hydrogen at 130° C. L. Maquenne (*Bull. soc. chim.*, 1888, 50, p. 662) distils the commercial acid, *in vacuo*, with concentrated sulphuric acid below 75° C.

Formic acid is a colourless, sharp-smelling liquid, which crystallizes at 0° C., melts at 8.6° C. and boils at 100.8° C. Its specific gravity is 1.22 (20°/4°). It is miscible in all proportions with water, alcohol and ether. When heated with zinc dust, the acid decomposes into carbon monoxide and hydrogen. The sodium and potassium salts, when heated to 400° C., give oxalates and carbonates of the

alkali metals, but the magnesium, calcium and barium salts yield carbonates only. The free acid, when heated with concentrated sulphuric acid, is decomposed into water and pure carbon monoxide; when heated with nitric acid, it is oxidized first to oxalic acid and finally to carbon dioxide. The salts of the acid are known as *formates*, and are mostly soluble in water, those of silver and lead being the least soluble. They crystallize well and are readily decomposed. Concentrated sulphuric acid converts them into sulphates, with simultaneous liberation of carbon monoxide. The calcium salt, when heated with the calcium salts of higher homologues, gives aldehydes. The silver and mercury salts, when heated, yield the metal, with liberation of carbon dioxide and formation of free formic acid; and the ammonium salt, when distilled, gives some formamide, HCONH_2 . The esters of the acid may be obtained by distilling a mixture of the sodium or potassium salts and the corresponding alcohol with hydrochloric or sulphuric acids.

Formamide, HCONH_2 , is obtained by heating ethyl formate with ammonia; by heating ammonium formate with urea to 140°C .

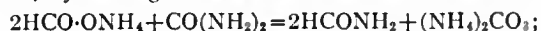

by heating ammonium formate in a sealed tube for some hours at 230°C ., or by the action of sodium amalgam on a solution of potassium cyanate (H. Basarow, *Ber.*, 1871, 4, p. 409). It is a liquid which boils *in vacuo* at 150° , but at $192\text{--}195^\circ \text{C}$. under ordinary atmospheric pressure, with partial decomposition into carbon monoxide and ammonia. It dissolves mercuric oxide, with the formation of mercuric formamide, $(\text{HCONH}_2)_2\text{Hg}$.

FORMOSA, a northern territory of the Argentine republic, bounded N. by Bolivia, N.E. and E. by Paraguay, S. by the Chaco Territory, and W. by Salta, with the Pilcomayo and Bermejo forming its northern and southern boundaries. Estimated area, 41,402 sq. m. It is a vast plain, sloping gently to the S.E., covered with marshes and tropical forests. Very little is known of it except small areas along the Bermejo and Paraguay rivers, where attempts have been made to form settlements. The unexplored interior is still occupied by tribes of wild Indians. The climate is hot, the summer temperature rising to a maximum of 104°F . Timber-cutting is the principal occupation of the settlers, though stock-raising and agriculture engage some attention in the settlements on the Paraguay. The capital, Formosa (founded 1879), is a small settlement on the Paraguay with a population of about 1000 in 1900. The settled population of the territory was 4829 in 1895, which it was estimated had increased to 13,431 in 1905. The nomadic Indians are estimated at 8000.

FORMOSA (called *Taiwan* by the Chinese, and following them by the Japanese, into whose possession it came after their war with China in 1895), an island in the western Pacific Ocean, between the Southern and the Eastern China Sea, separated from the Chinese mainland by the Formosa Strait, which has a width of about 90 m. in its narrowest part. The island is 225 m. long and from 60 to 80 m. broad, has a coast-line measuring 731 m., an area of 13,429 sq. m.—being thus nearly the same size as Kiushiu, the most southern of the four chief islands forming the Japanese empire proper—and extends from $20^\circ 56'$ to $25^\circ 15' \text{N}$. and from 120° to 122°E . It forms part of the long line of islands which are interposed as a protective barrier between the Asiatic coast and the outer Pacific, and is the cause of the immunity from typhoons enjoyed by the ports of China from Amoy to the Yellow Sea. Along the western coast is a low plain, not exceeding 20 m. in extreme width; on the east coast there is a rich plain called Giran, and there are also some fertile valleys in the neighbourhood of Karenko and Pinan, extending up the longitudinal valleys of the rivers Karenko and Pinan, between which and the east coast the Taito range intervenes; but the rest of the island is mountainous and covered with virgin forest. In the plains the soil is generally of sand or alluvial clay, covered in the valleys with a rich vegetable mould. The scenery of Formosa is frequently of majestic beauty, and to this it is indebted for its European name, happily bestowed by the early Spanish navigators.

On the addition of Formosa to her dominions, Fuji ceased to be Japan's highest mountain, and took the third place on the list. Mount Morrison (14,270 ft.), which the Japanese re-named Niitaka-yama (New High Mountain), stands first, and Mount Sylvia (12,480 ft.), to which they give the name of Setzu-zan (Snowy Mountain), comes second. Mount Morrison stands

nearly under the Tropic of Cancer. It is not volcanic, but consists of argillaceous schist and quartzite. An ascent made by Dr Honda of the imperial university of Japan showed that, up to a height of 6000 ft., the mountain is clothed with primeval forests of palms, banyans, cork trees, camphor trees, tree ferns, interlacing creepers and dense thickets of rattan or stretches of grass higher than a man's stature. The next interval of 1000 ft. has gigantic cryptomerias and chamoecyparis; then follow pines; then, at a height of 9500 ft., a broad plateau, and then alternate stretches of grass and forest up to the top, which consists of several small peaks. There is no snow. Mount Morrison, being surrounded by high ranges, is not a conspicuous object. Mount Sylvia lies in $24^\circ 30' \text{N}$. lat. There are many other mountains of considerable elevation. In the north is Getsurôbi-zan (4101 ft.); and on either side of Setzu-zan, with which they form a range running due east and west across the island, are Jusampunzan (4698 ft.) and Kali-zan (7027 ft.). Twenty-two miles due south of Kali-zan stands Hakumosha-zan (5282 ft.), and just 20 m. due south of Hakumosha-zan begins a chain of three peaks, Suisha-zan (6200 ft.), Hoo-zan (4928), and Niitaka-yama. These five mountains, Hari-zan, Hakumosha-zan, Suisha-zan, Hoo-zan and Niitaka-yama, stand almost exactly under 121°E . long., in the very centre of the island. But the backbone of the island lies east of them, extending S. from Setzu-zan through Gokan-zan, and Noko-zan and other peaks and bending S.W. to Niitaka-yama. Yet farther south, and still lying in line down the centre of the island, are Sankyakunanzan (3752 ft.), Shurogi-zan (5729 ft.), Poren-zan (4957 ft.), and Kado-zan (9055 ft.), and, finally, in the south-east Arugan-zan (4985 ft.). These, it will be observed, are all Japanese names, and the heights have been determined by Japanese observers. In addition to these remarkable inland mountains, Formosa's eastern shores show magnificent cliff scenery, the bases of the hills on the seaside taking the form of almost perpendicular walls as high as from 1500 to 2500 ft. Volcanic outbreaks of steam and sulphur-springs are found. Owing to the precipitous character of the east coast few rivers of any size find their way to the sea in that direction. The west coast, on the contrary, has many streams, but the only two of any considerable length are the Kotansui, which rises on Shurogi-zan, and has its mouth at Toko after a course of some 60 m. and the Seirakei, which rises on Hakumosha-zan, and enters the sea at a point 57 m. farther north after a course of 90 m.

The climate is damp, hot and malarious. In the north, the driest and best months are October, November and December; in the south, December, January, February and March. The sea immediately south of Formosa is the birthplace of innumerable typhoons, but the high mountains of the island protect it partially against the extreme violence of the wind.

Flora and Fauna.—The vegetation of the island is characterized by tropical luxuriance,—the mountainous regions being clad with dense forest, in which various species of palms, the camphor-tree (*Laurus Camphora*), and the aloe are conspicuous. Consul R. Swinhoe obtained no fewer than 65 different kinds of timber from a large yard in Taiwanfu; and his specimens are now to be seen in the museum at Kew. The tree which supplies the materials for the pith paper of the Chinese is not uncommon, and the cassia tree is found in the mountains. Travellers are especially struck with the beauty of some of the wild flowers, more especially with the lilies and convolvuluses; and European greenhouses have been enriched by several Formosan orchids and other ornamental plants. The pine-apple grows in abundance. In the lowlands of the western portion, the Chinese have introduced a large number of cultivated plants and fruit trees. Rice is grown in such quantities as to procure for Formosa, in former days, the title of the "granary of China"; and the sweet potato, taro, millet, barley, wheat and maize are also cultivated. Camphor, sugar, tea, indigo, ground peanuts, jute, hemp, oil and rattans are all articles of export.

The Formosan fauna has been but partially ascertained; but at least three kinds of deer, wild boars, bears, goats, monkeys (probably *Macacus speciosus*), squirrels, and flying squirrels

are fairly common, and panthers and wild cats are not unfrequent. A poisonous but beautiful green snake is often mentioned by travellers. Pheasants, ducks, geese and snipe are abundant, and Dr C. Collingwood in his *Naturalist's Rambles in the China Seas* mentions *Ardea prasinosceles* and other species of herons, several species of fly-catchers, kingfishers, shrikes and larks, the black drongo, the *Cotyle sinensis* and the *Prinia sonilans*. Dogs are kept by the savages for hunting. The horse is hardly known, and his place is taken by the ox, which is regularly bridled and saddled and ridden with all dignity. The rivers and neighbouring seas seem to be well stocked with fish, and especial mention must be made of the turtles, flying-fish, and brilliant coral-fish which swarm in the waters warmed by the *Kurosiwo* current, the gulf-stream of the Pacific. Shell-fish form an important article of diet to both the Chinese and the aborigines along the coast—a species of *Cyrena*, a species of *Tapes*, *Cytheraea petchiana* and *Modiola teres* being most abundant.

Population.—The population of Formosa, according to a census in 1904, is estimated at 3,022,687, made up as follows: aborigines 104,334, Chinese 2,860,574 and Japanese 51,770. The inhabitants of Formosa may be divided into four classes: the Japanese, who are comparatively few, as there has not been much tendency to immigration; the Chinese, many of whom immigrated from the neighbourhood of Amoy and speak the dialect of that district, while others were Hakkas from the vicinity of Swatow; the subjugated aborigines, who largely intermingled with the Chinese; and the uncivilized aborigines of the eastern region who refuse to recognize authority and carry on raids as opportunity occurs. The semi-civilized aborigines, who adopted the Chinese language, dress and customs, were called Pe-pa-hwan (*Anglice* Pepo-hoans), while their wilder brethren bear the name of Chin-hwan or “green savages,” otherwise Sheng-fan or “wild savages.” They appear to belong to the Malay stock, and their language bears out the supposition. They are broken up into almost countless tribes and clans, many of which number only a few hundred individuals, and their language consequently presents a variety of dialects, of which no classification has yet been effected: in the district of Posia alone a member of the Presbyterian mission distinguished eight different mutually unintelligible dialects. The people themselves are described as “middle height, broad-chested and muscular, with remarkably large hands and feet, the eyes large, the forehead round, and not narrow or receding in many instances, the nose broad, the mouth large and disfigured with betel.” The custom of tattooing is universal. In the north of the island at least, the dead are buried in a sitting posture under the bed on which they have expired. Petty wars are extremely common, not only along the Chinese frontiers, but between the neighbouring clans; and the heads of the slain are carefully preserved as trophies. In some districts the young men and boys sleep in the skull-chambers, in order that they may be inspired with courage. Many of the tribes that had least intercourse with the Chinese show a considerable amount of skill in the arts of civilization. The use of Manchester prints and other European goods is fairly general; and the women, who make a fine native cloth from hemp, introduce coloured threads from the foreign stuffs, so as to produce ornamental devices. The office of chieftain is sometimes held by women.

The chief town is Taipe (called by the Japanese Taihoku), which is on the Tamsui-yei river, and has a population of about 118,000, including 5850 Japanese. Taipe may be said to have two ports; one, Tamsui, at the mouth of the river Tamsui-yei, 10 m. distant on the north-west coast, the other Kelung (called by the Japanese Kiirun), on the north-east shore, with which it is connected by rail, a run of some 18 m. The foreign settlement at Taipe lies outside the walls of the city, and is called Twatutia (Taitotei by the Japanese). Kelung (the ancient Pekiang) is an excellent harbour, and the scenery is very beautiful. There are coal-mines in the neighbourhood. Tamsui (called Tansui by the Japanese) is usually termed Hobe by foreigners. It is the site of the first foreign settlement, has a population of about 7000, but cannot be made a good harbour

without considerable expenditure. On the west coast there is no place of any importance until reaching Anping (23° N. lat.), a port where a few foreign merchants reside for the sake of the sugar trade. It is an unlovely place, surrounded by mud flats, and a hotbed of malaria. It has a population of 4000 Chinese and 200 Japanese. At a distance of some 2½ m. inland is the former capital of Formosa, the walled city of Tainan, which has a population of 100,000 Chinese, 2300 Japanese, and a few British merchants and missionaries. Connected with Anping by rail (26 m.) and laying south of it is Takau, a treaty port. It has a population of 6800, and is prettily situated on two sides of a large lagoon. Six miles inland from Takau is a prosperous Chinese town called Fengshan (Japanese, Hozan). The anchorages on the east coast are Soo, Karenko and Pinan, which do not call for special notice. Forty-seven m. east of the extreme south coast there is a little island called Botel-tobago (Japanese, Koto-sho), which rises to a height of 1914 ft. and is inhabited by a tribe whose customs differ essentially from those of the natives on the main island.

Administration and Commerce.—The island is treated as an outlying territory; it has not been brought within the full purview of the Japanese constitution. Its affairs are administered by a governor-general, who is also commander-in-chief of the forces, by a bureau of civil government, and by three prefectural governors, below whom are the heads of twenty territorial divisions called *cho*; its finances are not included in the general budget of the Japanese empire; it is garrisoned by a mixed brigade taken from the home divisions; and its currency is on a silver basis. One of the first abuses with which the Japanese had to deal was the excessive use of opium by the Chinese settlers. To interdict the importation of the drug altogether, as is done in Japan, was the step advocated by Japanese public opinion. But, influenced by medical views and by the almost insuperable difficulty of enforcing any drastic import veto in the face of Formosa's large communications by junk with China, the Japanese finally adopted the middle course of licensing the preparation and sale of the drug, and limiting its use to persons in receipt of medical sanction. Under the administration of the Japanese the island has been largely developed. Among other industries gold-mining is advancing rapidly. In 1902 48,400 oz. of gold representing a value of £168,626 were obtained from the mines and alluvial washings. Coal is also found in large quantities near Kelung and sulphur springs exist in the north of the island.

An extensive scheme of railway construction has been planned, the four main lines projected being (1) from Takau to Tainan; (2) from Tainan to Kagi; (3) from Kagi to Shoka; and (4) from Shoka to Kelung; these four forming, in effect, a main trunk road running from the south-west to the north-east, its course being along the foot of the mountains that border the western coast-plains. The Takau-Tainan section (26 m.) was opened to traffic on the 3rd of November 1900, and by 1905 the whole line of 259 m. was practically complete. Harbour improvements also are projected, but in Formosa, as in Japan proper, paucity of capital constitutes a fatal obstacle to rapid development.

There are thirteen ports of export and import, but 75 % of the total business is done at Tamsui. Tea and camphor are the staple exports. The greater part of the former goes to Amoy for re-shipment to the west, but it is believed that if harbour improvements were effected at Tamsui so as to render it accessible for ocean-going steamers, shipments would be made thence direct to New York. The camphor trade being a government monopoly, the quantity exported is under strict control.

History.—The island of Formosa must have been known from a very early date to the Chinese who were established in the Pescadores. The inhabitants are mentioned in the official works of the Yuan dynasty as *Tung-fan* or eastern barbarians; and under the Ming dynasty the island begins to appear as Kilung. In the beginning of the 16th century it began to be known to the Portuguese and Spanish navigators, and the latter at least made some attempts at establishing settlements or missions. The Dutch were the first, however, to take footing in the island;

in 1624 they built a fort, Zelandia, on the east coast, where subsequently rose the town of Taiwan, and the settlement was maintained for thirty-seven years. On the expulsion of the Ming dynasty in China, a number of their defeated adherents came over to Formosa, and under a leader called in European accounts Coxinga, succeeded in expelling the Dutch and taking possession of a good part of the island. In 1682 the Chinese of Formosa recognized the emperor K'ang-hi, and the island then began to form part of the Chinese empire. From the close of the 17th century a long era of conflict ensued between the Chinese and the aborigines. A more debased population than the peoples thus struggling for supremacy could scarcely be conceived. The aborigines, *Sheng-fan*, or "wild savages," deserved the appellation in some respects, for they lived by the chase and had little knowledge even of husbandry; while the Chinese themselves, uneducated labourers, acknowledged no right except that of might. The former were not implacably cruel or vindictive. They merely clung to their homesteads, and harboured a natural resentment against the raiders who had dispossessed them. Their disposition was to leave the Chinese in unmolested possession of the plain. But some of the most valuable products of the island, as camphor and rattan, are to be found in the upland forests, and the Chinese, whenever they ventured too far in search of these products, fell into ambushes of hill-men who neither gave nor sought quarter, and who regarded a Chinese skull as a specially attractive article of household furniture. A violent rebellion is mentioned in 1788, put down only after the loss, it is said, of 100,000 men by disease and sword, and the expenditure of 2,000,000 taels of silver. Reconciliation never took place on any large scale, though it is true that, in the course of time, some fitful displays of administrative ability on the part of the Chinese, and the opening of partial means of communication, led to the pacification of a section of the *Sheng-fan*, who thenceforth became known as *Pe-pa-hwan* (*Pepohoan*).

In the early part of the 19th century the island was chiefly known to Europeans on account of the wrecks which took place on its coasts, and the dangers that the crews had to run from the cannibal propensities of the aborigines, and the almost equally cruel tendencies of the Chinese. Among the most notable was the loss in 1842 of the British brig "Ann," with fifty-seven persons on board, of whom forty-three were executed at Taichu. By the treaty of Tientsin (1860) Taichu was opened to European commerce, but the place was found quite unsuitable for a port of trade, and the harbour of Tam-sui was selected instead. From 1859 both Protestant and Presbyterian missions were established in the island. An attack made on those at Feng-shan (Hozan) in 1868 led to the occupation of Fort Zelandia and Anping by British forces; but this action was disapproved by the home government, and the indemnity demanded from the Chinese restored. In 1874 the island was invaded by the Japanese for the purpose of obtaining satisfaction for the murder of a shipwrecked crew who had been put to death by one of the semi-savage tribes on the southern coast, the Chinese government being either unable or unwilling to punish the culprits. A war was averted through the good offices of the British minister, Sir T. F. Wade, and the Japanese retired on payment of an indemnity of 500,000 taels. The political state of the island during these years was very bad; in a report of 1872 there is recorded a proverb among the official classes, "every three years an outbreak, every five a rebellion"; but subsequent to 1877 some improvement was manifested, and public works were pushed forward by the Chinese authorities. In 1884, in the course of belligerent proceedings arising out of the Tongking dispute, the forts at Kelung on the north were bombarded by the French fleet, and the place was captured and held for some months by French troops. An attack on the neighbouring town of Tamsui failed, but a semi-blockade of the island was maintained by the French fleet during the winter and spring of 1884-1885. The troops were withdrawn on the conclusion of peace in June 1885.

In 1895 the island was ceded to Japan by the treaty of

Shimonoseki at the close of the Japanese war. The resident Chinese officials, however, refused to recognize the cession, declared a republic, and prepared to offer resistance. It is even said they offered to transfer the sovereignty to Great Britain if that power would accept it. A formal transfer to Japan was made in June of the same year in pursuance of the treaty, the ceremony taking place on board ship outside Kelung, as the Chinese commissioners did not venture to land. The Japanese were thus left to take possession as best they could, and some four months elapsed before they effected a landing on the south of the island. Takau was bombarded and captured on the 15th of October, and the resistance collapsed. Liu Yung-fu, the notorious Black Flag general, and the back-bone of the resistance, sought refuge in flight. The general state of the island when the Japanese assumed possession was that the plain of Giran on the eastern coast and the hill-districts were inhabited by semi-barbarous folk, the western plains by Chinese of a degraded type, and that between the two there existed a traditional and continuous feud, leading to mutual displays of merciless and murderous violence. By many of these Chinese settlers the Japanese conquerors, when they came to occupy the island, were regarded in precisely the same light as the Chinese themselves had been regarded from time immemorial by the aborigines. Insurrections occurred frequently, the insurgents receiving secret aid from sympathizers in China, and the difficulties of the Japanese being increased not only by their ignorance of the country, which abounds in fastnesses where bandits can find almost inaccessible refuge, but also by the unwillingness of experienced officials to abandon their home posts for the purpose of taking service in the new territory.

BIBLIOGRAPHY.—C. Imbault-Huart, *L'Île Formose, histoire et description* (Paris, 1893), 4°; J. D. Clark, *Formosa* (Shanghai, 1896); W. A. Pickering, *Pioneering in Formosa* (London, 1898); George Candidius, *A Short Account of the Island of Formosa in the Indies . . .*, vol. i.; Churchill's *Collection of Voyages* (1744); Robert Swinhoe, *Notes on the Island of Formosa*, read before the British Association (1863); W. Campbell, "Aboriginal Savages of Formosa," *Ocean Highways* (April 1873); H. J. Klaproth, *Description de l'île de Formose, mém. rel. à l'Asie* (1826); Mrs T. F. Hughes, *Notes of a Six Years' Residence in Formosa* (London, 1881); Y. Takekoshi, *Japanese Rule in Formosa* (transl. by G. Braithwaite) (London, 1907).

FORMOSUS, pope from 891 to 896, the successor of Stephen V. (or VI.). He first appears in history when, as bishop of Porto, he was sent on an embassy to the Bulgarians. Having afterwards sided with a faction against John VIII., he was excommunicated, and compelled to take an oath never to return to Rome or again to assume his priestly functions. From this oath he was, however, absolved by Marinus, the successor of John VIII., and restored to his dignities; and on the death of Stephen V. in 891 he was chosen pope. At that time the Holy See was engaged in a struggle against the oppression of the princes of Spoleto, and a powerful party in Rome was eager to obtain the intervention of Arnulf, king of Germany, against these dangerous neighbours. Formosus himself shared this view; but he was forced to yield to circumstances and to consecrate as emperor Lambert, the young son of Guy of Spoleto. Guy had already been consecrated by Stephen V., and died in 894. In the following year Arnulf succeeded in seizing Rome, and Formosus crowned him emperor. But, as he was advancing on Spoleto against Lambert, Arnulf was seized with paralysis, and was forced to return to Germany. Overwhelmed with chagrin, Formosus died on the 4th of April 896. The discords in which he had been involved continued after his death. The validity of his acts was contested on the pretext that, having been originally bishop of Porto, he could not be a legitimate pope. The fundamental factor in these dissensions was the rivalry between the princes of Spoleto and the Carolingian house, represented by the king of Germany. The body of Formosus was disinterred in 897 by Stephen VI., and treated with contumely as that of a usurper of the papal throne; but Theodore II. restored it to Christian burial, and at a council presided over by John IX. the pontificate of Formosus was declared valid and all his acts confirmed. (L. D.*)

FORMULA (Lat. diminutive of *forma*, shape, pattern, &c., especially used of rules of judicial procedure), in general, a stereotyped form of words to be used on stated occasions, for specific purposes, ceremonies, &c. In the sciences, the word usually denotes a symbolical statement of certain facts; for example, a chemical formula exhibits the composition of a substance (see **CHEMISTRY**); a botanical formula gives the differential of a plant; a dentition formula indicates the arrangement and number of the teeth of an animal.

FORNER, JUAN BAUTISTA PABLO (1756–1799), Spanish satirist and scholar, was born at Mérida (Badajoz) on the 23rd of February 1756, studied at the university of Salamanca, and was called to the bar at Madrid in 1783. During the next few years—under the pseudonyms of “Tomé Cecial,” “Pablo Segarra,” “Don Antonio Varas,” “Bartolo,” “Pablo Ignocasto,” “El Bachiller Regañadientes,” and “Silvio Liberio”—Forner was engaged in a series of polemics with García de la Huerta, Iriarte and other writers; the violence of his attacks was so extreme that he was finally forbidden to publish any controversial pamphlets, and was transferred to a legal post at Seville. In 1796 he became crown prosecutor at Madrid, where he died on the 17th of March 1799. Forner's brutality is almost unexampled, and his satirical writings give a false impression of his powers. His *Oración apologética por la España y su mérito literario* (1787) is an excellent example of learned advocacy, far superior to similar efforts made by Denina and Cavanilles; and his posthumous *Exequias de la lengua castellana* (printed in the *Biblioteca de autores españoles*, vol. lxiii.) testifies to his scholarship and taste.

FORRES (Gaelic, *far uis*, “near water”), a royal and police burgh of Elginshire, Scotland. Pop. (1891) 3971; (1901) 4317. It is situated on the Findhorn, which sweeps past the town and is crossed by a suspension bridge about a mile to the W., 11 m. W. of Elgin by the Highland railway, and 6 m. by road from Findhorn, its port, due north. It is one of the most ancient towns in the north of Scotland. King Donald (892–900), son of Constantine, died in Forres, not without suspicion of poisoning, and in it King Duff (961–967) was murdered. Macbeth is said to have slain Duncan in the first structure that gave its name to Castlehill, which was probably the building demolished in 1297 by the adherents of Wallace. The next castle was a royal residence from 1189 to 1371 and was occupied occasionally by William the Lion, Alexander II. and David II. It was burned down by the Wolf of Badenoch in 1390. The ruins on the hill, however, are those of a later edifice and are surmounted by a granite obelisk, 65 ft. high, raised to the memory of Surgeon James Thomson, a native of Cromarty, who at the cost of his life tended the Russian wounded on the field of the Alma. The public buildings include the town hall, a fine and commodious house on the site of the old tolbooth; the Falconer museum, containing among other exhibits several valuable fossils, and named after Dr Hugh Falconer (1808–1865), the distinguished palaeontologist and botanist, a native of the town; the mechanics' institute; the agricultural and market hall; Leancoil hospital and Anderson's Institution for poor boys. The cross, in Decorated Gothic, stands beside the town hall. Adjoining the town on the south-east is the beautifully-wooded Cluny Hill, a favourite public resort, carrying on its summit the tower, 70 ft. high, which was erected in 1806 to the memory of Nelson, and on its southern slopes a well-known hydropathic. An excellent golf-course extends from Kinloss to Findhorn. The industries comprise the manufacture of chemicals and artificial manures, granite polishing, flour and sawmills, boot- and shoe-making, carriage-building and woollen manufactures. There is also considerable trade in cattle.

Sueno's Stone, about 23 ft. high, probably the finest sculptured monolith in Scotland, stands in a field to the east of the town. Its origin and character have given rise to endless surmises. It is carved with figures of soldiers, priests, slaughtered men and captives on one side, and on the other with a cross and Runic ornamentation. One theory is that it is a relic of the early Christian church, symbolizing the battle of life and the triumph

of good over evil. According to an older tradition it was named after Sueno, son of Harold, king of Denmark, who won a victory on the spot in 1008. A third conjecture is that it commemorates the expulsion of the Danes from Moray in 1014. Skene's view is that it chronicles the struggle in 900 between Sigurd, earl of Orkney, and Maelbrigd, Maormor of Moray. Another storied stone is called the Witches' Stone, because it marks the place near Forres where Macbeth is said to have encountered the weird sisters.

Forres is one of the Inverness district group of parliamentary burghs, the other members being Nairn, Fortrose and Inverness. The town is amongst the healthiest in Scotland and has the lowest rainfall in the county.

Within 2 m. of Forres, to the S.W., lie the beautiful woods of Altyre, the seat of the Gordon-Cummings. Three miles farther south is Relugas House, the favourite residence of Sir Thomas Dick Lauder, romantically situated on a height near the confluence of the Divic and the Findhorn. Not far away stand the ruins of the old castle of Dunphail. On the left bank of the Findhorn, 3½ m. W. of Forres, is situated Brodie Castle, partly ancient and partly modern. The Brodies—the old name of their estate was Brothie, from the Irish *broth*, a ditch, in allusion to the trench that ran from the village of Dyke to the north of the house—were a family of great consequence at the period of the Covenant. Alexander Brodie (1617–1680), the fourteenth laird, was one of the commissioners who went to the Hague to treat with Charles II., and afterwards became a Scottish lord of session and an English judge. He and his son were regarded as amongst the staunchest of the Presbyterians. Farther south is the forest of Darnaway, famous for its oaks, in which stands the earl of Moray's mansion of Darnaway Castle. It occupies the site of the castle which was built by Thomas Randolph, the first earl. Attached to it is the great hall, capable of accommodating 1000 men, with an open roof of fine dark oak, the only remaining portion of the castle that was erected by Archibald Douglas, earl of Moray, in 1450. Queen Mary held a council in it in 1562. Earl Randolph's chair, not unlike the coronation chair, has been preserved. Kinloss Abbey, now in ruins, stands some 2½ m. to the N.E. of Forres. It was founded in 1150 by David I., and remained in the hands of the Cistercians till its suppression at the Reformation. Robert Reid, who ruled from 1526 to 1540, was its greatest abbot. His hobby was gardening, and it is believed that many of the 123 varieties of pears and 146 varieties of apples for which the district is famous were due to his skill and enterprise. Edward I. stayed in the abbey for a short time in 1303 and Queen Mary spent two nights in it in 1562.

FORREST, EDWIN (1806–1872), American actor, was born at Philadelphia, Pennsylvania, on the 9th of March 1806, of Scottish and German descent. He made his first stage appearance on the 27th of November 1820, at the Walnut Street theatre, in Home's *Douglas*. In 1826 he had a great success in New York as Othello. He played at Drury Lane in the *Gladiator* in 1836, but his Macbeth in 1845 was hissed by the English audience, and his affront to Macready in Edinburgh shortly afterwards—when he stood up in a private box and hissed him,—was fatal to his popularity in Great Britain. His jealousy of Macready resulted in the Astor Place riot in 1849. In 1837 he had married Catherine, daughter of John Sinclair, an English singer, and his divorce suit in 1852 was a *cause célèbre* which hurt his reputation and soured his temper. His last appearance was as Richelieu in Boston in 1871. He died on the 12th of December 1872. He had amassed a large fortune, much of which he left by will to found a home for aged actors.

See Lawrence Barrett's *Edwin Forrest* (Boston, 1881).

FORREST, SIR JOHN (1847–), West Australian statesman and explorer, son of William Forrest, of Bunbury, West Australia, was born near Bunbury, on the 22nd of August 1847, and educated at Perth, W.A. In 1865 he became connected with the Government Survey Department at Perth, and in 1869 led an exploring expedition into the interior in search of D. Leichardt, penetrating through bush and salt-marshes as far inland as

123° E. In 1870 he again made an expedition from Perth to Adelaide, along the southern shores. In 1874, with his brother Alexander Forrest (born 1849), he explored eastwards from Champion Bay, following as far as possible the 26th parallel, and striking the telegraph line between Adelaide and Port Darwin; a distance of about 2000 m. was covered in about five months with horses and without carriers, a particularly fine achievement (see AUSTRALIA: *Exploration*). John Forrest also surveyed in 1878 the north-western district between the rivers Ashburton and Lady Grey, and in 1882 the Fitzroy district. In 1876 he was made deputy surveyor-general, receiving the thanks of the colony for his services and a grant of 5000 acres of land; for a few months at the end of 1878 he acted as commissioner of crown lands and surveyor-general, being given the full appointment in 1883 and retaining it till 1890. When the colony obtained in 1890 its constitution of self-government, Sir John Forrest (who was made K.C.M.G. in 1891, and G.C.M.G. in 1901) became its first premier, and he held that position till in 1901 he joined the Commonwealth government, first as minister for defence, later as minister for home affairs and postmaster-general, resigning the office of federal treasurer in July 1907. His influence in West Australia was one of an almost autocratic character, owing to the robust vigour of his personality and his success in enforcing his views (see WESTERN AUSTRALIA: *History*). In 1897 he was made a member of the Privy Council. Sir John Forrest married in 1876 Margaret Hamersley. He published *Explorations in Australia* (1876) and *Notes on Western Australia* (1884-1887).

FORREST, NATHAN BEDFORD (1821-1877), Confederate cavalry general in the American Civil War, was born near Chapel Hill, Tennessee, on the 13th of July 1821. Before his father's death in 1837 the family had removed to Mississippi, and for some years thereafter it was supported principally by Nathan, who was the eldest son. Thus he never received any formal education (as witnessed by the uncouth phraseology and spelling of his war despatches), but he managed to teach himself with very fair success, and is said to have possessed considerable ability as a mathematician. He was in turn a horse and cattle trader in Mississippi, and a slave dealer and horse trader in Memphis, until 1850, when he took to cotton planting in north-western Mississippi, where he acquired considerable wealth. At the outbreak of the Civil War in 1861 he volunteered as a private, raised a cavalry battalion, of which he was lieutenant-colonel, and in February 1862 took part in the defence of Fort Donelson, and refusing, like Generals Floyd and Pillow, to capitulate with the rest of the Confederate forces, made his way out, before the surrender, with all the mounted troops there. He was promptly made a colonel and regimental commander, and fought at Shiloh with distinction, receiving a severe wound. Shortly after this he was promoted brigadier-general (July 1862). At the head of a mounted brigade he took a brilliant part in General Bragg's autumn campaign, and in the winter of 1862-1863 he was continually active in raiding the hostile lines of communication. These raids have been the theme of innumerable discussions, and on the whole their value seems to have been overrated. At the same time, and apart from the question of their utility, Forrest's raids were uniformly bold and skilful, and are his chief title to fame in the history of the cavalry arm. Indeed, next to Stuart and Sheridan, he was the finest cavalry leader of the whole war. One of the most remarkable of his actions was his capture, near Rome, Georgia, after five days of marching and fighting, of an entire cavalry brigade under Colonel A. D. Streight (April 1863). He was present at the battle of Chickamauga in September, after which (largely on account of his criticism of General Bragg, the army commander) he was transferred to the Mississippi. Forrest was made a major-general in December 1863. In the winter of 1863-1864 he was as active as ever, and in the spring of 1864 he raided as far north as Paducah, Ky. On the 12th of April 1864 he assaulted and captured Fort Pillow, in Tennessee on the Mississippi; U.S. negro troops formed a large part of the garrison and according to survivors many were massacred after the fort had surrendered. The "Massacre of Fort Pillow" has been the

subject of much controversy and there is much conflicting testimony regarding it, but it seems probable that Forrest himself had no part in it. On the 10th of June Forrest decisively defeated a superior Federal force at Brice's Cross Roads, Miss., and throughout the year, though the greatest efforts were made by the Federals to crush him, he raided in Mississippi, Tennessee and Alabama with almost unvarying success. He was once more with the main Confederate army of the West in the last disastrous campaign of Nashville, and fought stubborn rearguard actions to cover the retreat of the broken Confederates. In February 1865 he was made a lieutenant-general, but the struggle was almost at an end and General James H. Wilson, one of the ablest of the Union cavalry generals, rapidly forced back the few Confederates, now under Forrest's command, and stormed Selma, Alabama, on the 2nd of April. The surrender of General Forrest and his whole command, under the agreement between General Richard Taylor and General E. S. Canby, followed on the 9th of May. After the war he lived in Memphis. He sold his cotton plantation in 1867, and for some years was president of the Selma, Marion and Memphis Railroad. He died at Memphis, Tennessee, on the 20th of October 1877.

The military character of General Forrest, apart from questions of his technical skill, horsemanship and detail special to his arm of the service, was admittedly that of a great leader. He never commanded a large force of all arms. He was uneducated, and had neither experience of nor training for the strategical handling of great armies. Yet his personality and his natural soldierly gifts were such that General Sherman considered him "the most remarkable man the Civil War produced on either side." Joseph Johnston, the Confederate general whose greatness lay above all in calm and critical judgment, said that Forrest, had he had the advantage of a thorough military training, "would have been the great central figure of the war."

See the biographies by J. A. Wyeth (1899) and J. H. Mathes (1902).

FORSKÅL, PETER (1736-1763), Swedish traveller and naturalist, was born in Kalmar in 1736. He studied at Göttingen, where he published a dissertation entitled *Dubia de principijs philosophiæ recentioris* (1756). Thence he returned to his native country, which, however, he had to leave after the publication of a pamphlet entitled *Pensées sur la liberté civile* (1759). By Linnaeus he was recommended to Frederick V. of Denmark, who appointed him to accompany Carsten Niebuhr in an expedition to Arabia and Egypt in 1761. He died of the plague at Jerim in Arabia on the 11th of July 1763.

His friend and companion, Niebuhr, was entrusted with the care of editing his MSS., and published in 1775 *Descriptiones animalium, avium, amphibiorum, piscium, insectorum, vermium, quae in itin. Orient. observavit Petrus Forskål*. In the same year appeared also his account of the plants of Arabia Felix and of lower Egypt, under the title of *Flora Aegyptiaco-Arabica*.

FORSSELL, HANS LUDVIG (1843-1901), Swedish historian and political writer, the son of Adolf Forssell, a distinguished mathematician, was born at Gefle, where his father was professor, on 14th January 1843. At the age of sixteen he became a student in Upsala University, where he distinguished himself, and where, in 1866, having taken the degree of doctor, he was appointed reader in history. At the age of thirty, however, Forssell, who had already shown remarkable business capacity, was called to Stockholm, where he filled one important post after another in the Swedish civil service. In 1875 he was appointed head of the treasury, and in 1880 was transferred to the department of inland revenue, of which he continued to be president until the time of his death. In addition to the responsibilities which these offices devolved upon him, Forssell was constantly called to serve on royal commissions, and his political influence was immense. In spite of all these public duties, which he carried through with the utmost diligence, Forssell also found leisure for an abundant literary activity. Of his historical writings the most important were: *The Administrative and Economical History of Sweden after Gustavus I.* (1869-1875) and *Sweden in 1571* (1872). He was also for several years, in company with the poet Wirsén, editor of the *Swedish Literary Review*. He published two volumes of *Studies and*

Criticisms (1875, 1888). In the year 1881, at the death of the historian Anders Fryxell, Forssell was elected to the vacant seat on the Swedish Academy. The energy of Forssell was so great, and he understood so little the economy of strength, that he unquestionably overtaxed his vital force. His death, however, which occurred with great suddenness on the 2nd of August 1901 while he was staying at San Bernardino in Switzerland, was wholly unexpected. There was little of the typical Swedish urbanity in Forssell's exterior manner, which was somewhat dry and abrupt. Like many able men who have from early life administered responsible public posts, there appeared a certain want of sympathy in his demands upon others. His views were distinct, and held with great firmness; for example, he was a free-trader, and his consistent opposition to what he called "the new system" had a considerable effect on Swedish policy. He was not exactly an attractive man, but he was a capable, upright and efficient public servant. In 1867 he married Miss Zulamith Eneroth, a daughter of the well-known pomologist of Upsala; she survived him, with two sons and two daughters. (E. G.)

FORST (originally FORSTA or FORSTE), a town of Germany, in the Prussian province of Brandenburg, on the Neisse, 44 m. S.E. of Frankfort-on-Oder. Pop. (1905) 33,757. It has two Evangelical, a Roman Catholic and an Old Lutheran church; there are two schools and two hospitals in the town. The chief industry of Forst is the manufacture of cloth, but spinning, dyeing and the making of artificial flowers are also carried on. Founded in the 13th century, Forst passed in 1667 to the duke of Saxe-Merseburg, becoming part of electoral Saxony in 1740. It was ceded to Prussia in 1815.

FORSTER, FRANÇOIS (1790–1872), French engraver, was born at Locle in Neuchâtel, on the 22nd of August 1790. In 1805 he was apprenticed to an engraver in Paris, and he also studied painting and engraving simultaneously in the *École des Beaux-Arts*. His preference was ultimately fixed on the latter art, and on his obtaining in 1814 the first "grand prix de gravure," the king of Prussia, who was then with the allies in Paris, bestowed on him a gold medal, and a pension of 1500 francs for two years. With the aid of this sum he pursued his studies in Rome, where his attention was devoted chiefly to the works of Raphael. In 1844 he succeeded Tardieu in the Academy. He died at Paris on the 27th of June 1872. Forster occupied the first position among the French engravers of his time, and was equally successful in historical pieces and in portraits. Among his works may be mentioned—*The Three Graces*, and *La Vierge de la légende*, after Raphael; *La Vierge au bas-relief*, after Leonardo da Vinci; Francis I. and Charles V., after Gros; St Cecilia, after Paul Delaroche; Albert Dürer and Henry IV., after Porbus; Wellington, after Gérard; and Queen Victoria, after Winterhalter.

FÖRSTER, FRIEDRICH CHRISTOPH (1791–1868), German historian and poet, was the second son of Karl Christoph Förster (1751–1811), and consequently a brother of the painter, Ernest Joachim Förster (1800–1885). Born at Münchengosserstadt on the Saale on the 24th of September 1791, he received his early education at Altenburg, and after a course of theology at Jena, devoted some time to archaeology and the history of art. At the outbreak of the War of Liberation in 1813, he joined the army, quickly attaining the rank of captain; and by his war-songs added to the national enthusiasm. On the conclusion of the war he was appointed professor at the school of engineering and artillery in Berlin, but on account of some democratic writings he was dismissed from this office in 1817. He then became connected with various journals until about 1829, when he received an appointment at the royal museum in Berlin, with the title of court councillor (*Hofrat*). He was the founder and secretary of the *Wissenschaftlicher Kunstverein* in Berlin, and died in Berlin on the 8th of November 1868. Förster's principal works are: *Beiträge zur neueren Kriegsgeschichte* (Berlin, 1816); *Grundzüge der Geschichte des preussischen Staates* (Berlin, 1818); *Der Feldmarschall Blücher und seine Umgebungen* (Leipzig, 1820); *Friedrich der Grosse, Jugendjahre, Bildung und Geist* (Berlin, 1822); *Albrecht von Wallenstein* (Potsdam, 1834);

Friedrich Wilhelm I., König von Preussen (Potsdam, 1834–1835); *Die Höfe und Kabinette Europas im 18. Jahrhundert* (Potsdam, 1836–1839); *Leben und Taten Friedrichs des Grossen* (Meissen, 1840–1841); *Wallensteins Prozess* (Leipzig, 1844); and *Preussens Helden in Krieg und Frieden, neuere und neueste preussische Geschichte*, 7 volumes (Berlin, 1849–1860). The three concluding volumes of this work contain the history of the war of liberation of 1813–14–15. He brought out an edition of Hegel's works, adapted several of Shakespeare's plays for the theatre, wrote a number of poems and an historical drama, *Gustav Adolf* (Berlin, 1832).

Many of his lesser writings were collected and published as *Kriegslieder, Romanzen, Erzählungen und Legenden* (Berlin, 1838). The beginning of an autobiography of Förster, edited by H. Klette, has been published under the title, *Kunst und Leben* (Berlin, 1873).

FORSTER, JOHANN GEORG ADAM (1754–1794), German traveller and author, was born at Nassenhuben, a small village near Danzig, on the 27th of November 1754. His father, Johann Reinhold Forster, a man of great scientific attainments but an intractable temper, was at that time pastor of the place; the family are said to have been of Scottish extraction. In 1765 the elder Forster was commissioned by the empress Catherine to inspect the Russian colonies in the province of Saratov, which gave his son an opportunity of acquiring the Russian language and the elements of a scientific education. After a few years the father quarrelled with the Russian government, and went to England, where he obtained a professorship of natural history and the modern languages at the famous non-conformist academy at Warrington. His violent temper soon compelled him to resign this appointment, and for two years he and his son earned a precarious livelihood by translations in London—a practical education, however, exceedingly useful to the younger Forster, who became a thorough master of English, and acquired many of the ideas which chiefly influenced his subsequent life. At length the turning point in his career came in the shape of an invitation for him and his father to accompany Captain Cook in his third voyage round the world. Such an expedition was admirably calculated to call forth Förster's peculiar powers. His account of Cook's voyage (*A Voyage round the World*, London, 1777; in German, Berlin, 1778–1780), is almost the first example of the glowing yet faithful description of natural phenomena which has since made a knowledge of them the common property of the educated world. The publication of this work was, however, impeded for some time by differences with the admiralty, during which Förster proceeded to the continent to obtain an appointment for his father as professor at Cassel, and found to his surprise that it was conferred upon himself. The elder Forster, however, was soon provided for elsewhere, being appointed professor of natural history at Halle. At Cassel Förster formed an intimate friendship with the great anatomist Sömmerring, and about the same time made the acquaintance of Jacobi, who gave him a leaning towards mysticism from which he subsequently emancipated himself. The want of books and scientific apparatus at Cassel induced him to resort frequently to Göttingen, where he became betrothed to Therese Heyne, the daughter of the illustrious philologist, a clever and cultivated woman, but ill-suited to be Förster's wife. To be able to marry he accepted (1784) a professorship at the university of Wilna, which he did not find to his taste. The penury and barbarism of Polish circumstances are graphically described in his and his wife's letters of this period. After a few years' residence at Wilna he resigned his appointment to participate in a scientific expedition projected by the Russian government, and upon the relinquishment of this undertaking became librarian to the elector of Mainz. He actively promoted the incorporation of the left bank of the Rhine with France and in 1793 went to Paris to carry on the negotiations. Meanwhile, however, the Germans seized Mainz, and Förster—already disheartened by the turn of events in France—was cut off from all return. Domestic sorrows were added to his political troubles and he died suddenly at Paris on the 10th of January 1794.

Forster's masterpiece is his *Ansichten vom Niederrhein, von Brabant, Flandern, Holland, England und Frankreich* (1791–1794), one of the ablest books of travel of the 18th century. His style is clear and vivid; his method of describing what he sees extraordinarily plastic; above all, he has the art of presenting objects to us from their most interesting and attractive side. The same qualities are also more or less conspicuous in his minor writings. By his translation (from the English) of the *Sakuntala* of Kalidasa (1791), he first awakened German interest in Indian literature.

Forster's *Sämmtliche Werke* appeared at Leipzig in 9 vols. in 1843. The *Ansichten vom Rhein*, &c., has been frequently reprinted (best edition by A. Leitzmann, Halle, 1893); Leitzmann has also published (Stuttgart, 1894) a selection of Forster's *Kleine Schriften*, which originally appeared in 6 vols. (1789–1797). His correspondence was published by his wife (2 vols., Leipzig, 1829); his *Briefwechsel mit Sömmerring* by H. Hettner (Brunswick, 1877). See J. Moleschott, *G. Forster, der Naturforscher des Volkes* (1854; 3rd ed., 1874); K. Klein, *G. Forster in Mainz* (Gotha, 1863); A. Leitzmann, *G. Forster* (Vorlesung) (Halle, 1893).

FORSTER, JOHN (1812–1876), English biographer and critic, was born on the 2nd of April 1812 at Newcastle. His father, who was a Unitarian and belonged to the junior branch of a good Northumberland family, was a cattle-dealer. After being well grounded in classics and mathematics at the grammar school of his native town, John Forster was sent in 1828 to Cambridge, but after only a month's residence he removed to London, where he attended classes at University College, and was entered at the Inner Temple. He devoted himself, however, chiefly to literary pursuits. He contributed to *The True Sun*, *The Morning Chronicle* and to *The Examiner*, for which he acted as literary and dramatic critic; and the influence of his powerful individuality soon made itself felt. His *Lives of the Statesmen of the Commonwealth* (1836–1839) appeared partly in Lardner's Cyclopaedia. He published the work separately in 1840 with a *Treatise on the Popular Progress in English History*. Its merits obtained immediate recognition, and Forster became a prominent figure in that distinguished circle of literary men which included Bulwer, Talfourd, Albany, Fonblanque, Landor, Carlyle and Dickens. Forster is said to have been for some time engaged to Letitia Landon, but the engagement was broken off, and Miss Landon married George Maclean. In 1843 he was called to the bar but he never became a practising lawyer. For some years he edited the *Foreign Quarterly Review*; in 1846, on the retirement of Charles Dickens, he took charge for some months of the *Daily News*; and from 1847 to 1856 he edited the *Examiner*. From 1836 onwards he contributed to the *Edinburgh Quarterly* and *Foreign Quarterly* Reviews a variety of articles, some of which were republished in two volumes of *Biographical and Historical Essays* (1858). In 1848 appeared his admirable *Life and Times of Oliver Goldsmith* (revised in 1854). Continuing his researches into English history under the early Stuarts, he published in 1860 the *Arrest of the Five Members by Charles I.—A Chapter of English History rewritten*, and *The Debates on the Grand Remonstrance, with an Introductory Essay on English Freedom*. These were followed by his *Sir John Eliot: a Biography* (1864), elaborated from one of his earlier studies for the *Lives of Eminent British Statesmen*. In 1868 appeared his *Life of Landor*, and, on the death of his friend Alexander Dyce, Forster undertook the publication of his third edition of Shakespeare. For several years he had been collecting materials for a life of Swift, but he interrupted his studies in this direction to write his standard *Life of Charles Dickens*. He had long been intimate with the novelist, and it is by this work that John Forster is now chiefly remembered. The first volume appeared in 1872, and the biography was completed in 1874. Towards the close of 1875 the first volume of his *Life of Swift* was published; and he had made some progress in the preparation of the second at the time of his death on the 2nd of February 1876. In 1855 Forster had been appointed secretary to the lunacy commission, and from 1861 to 1872 he held the office of a commissioner in lunacy. His valuable collection of manuscripts, including the original copies of Charles Dickens's novels, together with his

books and pictures, was bequeathed to South Kensington Museum.

An admirable account of him by Henry Morley is prefixed to the official handbook (1877) of the Dyce and Forster bequests.

FORSTER, JOHN COOPER (1823–1886), British surgeon, was born in 1823 in Lambeth, London, where his father and grandfather before him had been local medical practitioners. He entered Guy's hospital in 1841, was appointed demonstrator of anatomy in 1850, assistant-surgeon, 1855, and surgeon, 1870. He became a member of the College of Surgeons in 1844, fellow in 1849 and president in 1884. He was a prompt and sometimes bold operator. In 1858 he performed practically the first gastrotomy in England for a case of cancer of the oesophagus. Among his best-known papers were discussions of acupressure, syphilis, hydrophobia, intestinal obstruction, modified obturator hernia, torsion, and colloid cancer of the large intestine; and he published a book on *Surgical Diseases of Children* in 1860, founded on his experience as surgeon to the hospital for children and women in Waterloo Road. He died suddenly in London on the 2nd of March 1886.

FORSTER, WILLIAM EDWARD (1818–1886), British statesman, was born of Quaker parents at Bradpole in Dorsetshire on the 11th of July 1818. He was educated at the Friends' school at Tottenham, where his father's family had long been settled, and on leaving school he was put into business. He declined, however, on principle, to enter a brewery. Becoming in due time a woollen manufacturer in a large way at Bradford, Yorkshire (from which after his marriage he moved to Burley-in-Wharfedale), he soon made himself known as a practical philanthropist. In 1846–1847 he accompanied his father to Ireland as distributor of the Friends' relief fund for the famine in Connemara, and the state of the country made a deep impression on him. In 1849 he wrote a preface to a new edition of Clarkson's *Life of William Penn*, defending the Quaker statesman against Macaulay's criticisms. In 1850 he married Jane Martha, eldest daughter of the famous Dr Arnold of Rugby. She was not a Quaker, and her husband was formally excommunicated for marrying her, but the Friends who were commissioned to announce the sentence "shook hands and stayed to luncheon." Forster thereafter ranked himself as a member of the Church of England, for which, indeed, he was in later life charged with having too great a partiality. There were no children of the marriage, but when Mrs Forster's brother, William Arnold, died in 1859, leaving four orphans, the Forsters adopted them as their own.

One of these children was Mr H. O. Arnold-Forster (1855–1909), the well-known Liberal-Unionist member of parliament, who eventually became a member of Mr Balfour's cabinet; he was secretary to the admiralty (1900–1903), and then secretary of state for war (1903–1905), and was the author of numerous educational books published by Cassell & Co., of which firm he was a director.

W. E. Forster gradually began to take an active part in public affairs by speaking and lecturing. In 1858 he gave a lecture before the Leeds Philosophical Institution on "How we Tax India." In 1859 he stood as Liberal candidate for Leeds, but was beaten. But he was highly esteemed in the West Riding, and in 1861 he was returned unopposed for Bradford. In 1865 (unopposed) and in 1868 (at the head of the poll) he was again returned. He took a prominent part in parliament in the debates on the American Civil War, and in 1868 was made under-secretary for the colonies in Earl Russell's ministry. It was then that he first became a prominent advocate of imperial federation. In 1866 his attitude on parliamentary reform attracted a good deal of attention. His speeches were full of knowledge of the real condition of the people, and contained something like an original programme of Radical legislation. "We have other things to do," he said, "besides extending the franchise. We want to make Ireland loyal and contented; we want to get rid of pauperism in this country; we want to fight against a class which is more to be dreaded than the holders of a £7 franchise—I mean the dangerous class in our large towns. We want to see

whether we cannot make for the agricultural labourer some better hope than the workhouse in his old age. We want to have Old England as well taught as New England." In these words he heralded the education campaign which occupied the country for so many years afterwards. Directly the Reform Bill had passed, the necessity of "inducing our masters to learn their letters" (in Robert Lowe's phrase) became pressing. Mr Forster and Mr Cardwell, as private members in opposition, brought in Education Bills in 1867 and 1868; and in 1868, when the Liberal party returned to office, Mr Forster was appointed vice-president of the council, with the duty of preparing a government measure for national education. The Elementary Education Bill (see EDUCATION) was introduced on the 17th of February 1870. The religious difficulty at once came to the front. The Manchester Education Union and the Birmingham Education League had already formulated in the provinces the two opposing theories, the former standing for the preservation of denominational interests, the latter advocating secular rate-aided education as the only means of protecting Nonconformity against the Church. The Dissenters were by no means satisfied with Forster's "conscience clause" as contained in the bill, and they regarded him, the ex-Quaker, as a deserter from their own side; while they resented the "25th clause," permitting school boards to pay the fees of needy children at denominational schools out of the rates, as an insidious attack upon themselves. By the 14th of March, when the second reading came on, the controversy had assumed threatening proportions; and Mr Dixon, the Liberal member for Birmingham and chairman of the Education League, moved an amendment, the effect of which was to prohibit all religious education in board schools. The government made its rejection a question of confidence, and the amendment was withdrawn; but the result was the insertion of the Cowper-Temple clause as a compromise before the bill passed. Extremists on both sides abused Forster, but the government had a difficult set of circumstances to deal with, and he acted like a prudent statesman in contenting himself with what he could get. An ideal bill was impracticable; it is to Forster's enduring credit that the bill of 1870, imperfect as it was, established at last some approach to a system of national education in England without running absolutely counter to the most cherished English ideas and without ignoring the principal agencies already in existence.

Forster's next important work was in passing the Ballot Act of 1872, but for several years afterwards his life was uneventful. In 1874 he was again returned for Bradford, in spite of Dissenting attacks, and he took his full share of the work of the Opposition Front Bench. In 1875, when Mr Gladstone "retired," he was strongly supported for the leadership of the Liberal party, but declined to be nominated against Lord Hartington. In the same year he was elected F.R.S., and made lord rector of Aberdeen University. In 1876, when the Eastern question was looming large, he visited Servia and Turkey, and his subsequent speeches on the subject were marked by studious moderation, distasteful to extremists on both sides. On Mr Gladstone's return to office in 1880 he was made chief secretary for Ireland, with Lord Cowper as lord-lieutenant. He carried the Compensation for Disturbance Bill through the Commons, only to see it thrown out in the Lords, and his task was made more difficult by the agitation which arose in consequence. During the gloomy autumn and winter of 1880-1881 Forster's energy and devotion in grappling with the situation in Ireland (see IRELAND) were indefatigable, his labour was enormous, and the personal risks he ran were many; but he enjoyed the Irish character in spite of all obstacles, and inspired genuine admiration in all his coadjutors. On the 24th of January 1881 he introduced a new Coercion Bill in the House of Commons, to deal with the growth of the Land League, and in the course of his speech declared it to be "the most painful duty" he had ever had to perform, and one which would have prevented his accepting his office if he had known that it would fall upon him. The bill passed, among its provisions being one enabling the Irish government to arrest without trial persons "reasonably suspected" of crime and

conspiracy. The Irish party used every opportunity in and out of parliament for resenting this act, and Forster was kept constantly on the move between Dublin and London, conducting his campaign against crime and anarchy and defending it in the House of Commons. His scrupulous conscientiousness and anxiety to meet every reasonable claim availed him nothing with such antagonists, and the strain was intense and continuous. He was nicknamed "Buckshot" by the Nationalist press, on the supposition that he had ordered its use by the police when firing on a crowd. On the 13th of October Mr Parnell was arrested, and on the 20th the Land League was proclaimed. From that time Forster's life was in constant danger, and he had to be escorted by mounted police when he drove in Dublin. Early in March 1882 he visited some of the worst districts in Ireland, and addressed the crowd at Tullamore on the subject of outrages, denouncing the people for their want of courage in not assisting the government, but adding, "whether you do or not, it is the duty of the government to stop the outrages, and stop them we will." Forster's pluck in speaking out like this was fully appreciated in England, but it was not till after the revelations connected with the Phoenix Park murders that the dangers he had confronted were properly realized, and it became known that several plans to murder him had only been frustrated by the merest accidents. On the 2nd of May Mr Gladstone announced that the government intended to release Mr Parnell and his fellow-prisoners in Kilmainham, and that both Lord Cowper and Mr Forster had in consequence resigned; and the following Saturday Forster's successor, Lord Frederick Cavendish, was, with Mr Burke, murdered in Phoenix Park. It was characteristic of the man that Forster at once offered to go back to Dublin temporarily as chief secretary, but the offer was declined. His position naturally attracted universal attention towards him, particularly during the debates which ensued in parliament on the "Kilmainham Treaty." But Mr Gladstone's influence with the Liberal party was paramount, in spite of the damaging appearance of the compact made with Parnell, and Forster's pointed criticisms only caused thoroughgoing partisans to accuse him of a desire to avenge himself. It was not till the next session that he delivered his fiercest attack on Parnell in the debate on the address, denouncing him for his connexion with the Land League, and quoting against him the violent speeches of his supporters and the articles of his newspaper organs. It was on this occasion that Parnell, on Forster's charging him, not with directly planning or perpetrating outrages or murder, but with conniving at them, ejaculated "It's a lie"; and, replying on the next day, the Irish leader, instead of disproving Forster's charges, bitterly denounced his methods of administration. Though, during the few remaining years of his life, Forster's political record covered various interesting subjects, his connexion with these stormy times in Ireland throws them all into shadow. He died on the 6th of April 1886, on the eve of the introduction of the Home Rule Bill, to which he was stoutly opposed. In the interval there had been other questions on which he found himself at variance with Gladstonian Liberalism, for instance, as regards the Sudan and the Transvaal, nor was he inclined to stomach the claims of the Caucasus or the Birmingham programme. When the Redistribution Act divided Bradford into three constituencies, Forster was returned for the central division, but he never took his seat in the new parliament. Forster, like John Bright, was an excellent representative of the English middle-class in public life. Patriotic, energetic, independent, incorruptible, shrewd, fair-minded, he was endowed not only with great sympathy with progress, but also with a full faculty for resistance to mere democraticism. He was tall (the Yorkshiremen called him "Long Forster") and strongly though stiffly built, and, with his simple tastes and straightforward manners and methods, was a typical North-country figure. His oratory was rough and unpolished, but full of freshness and force and genuine feeling. It was Forster who, when appealing to the government at the time of Gordon's danger at Khartum, spoke of Mr Gladstone as able "to persuade most people of most things, and himself of almost anything," and though the phrase

was much resented by Mr Gladstone's *entourage*, the truth that underlay it may be taken as representing the very converse of his own character. His personal difficulties with some of his colleagues, both in regard to the Education Act of 1870 and his Irish administration, must be properly understood if a complete comprehension of his political career is to be obtained. For an account of them we need only refer to the *Life of the Right Hon. W. E. Forster*, by Sir T. Wemyss Reid. (H. CH.)

FORSYTH, PETER TAYLOR (1848-), British Nonconformist divine, was born at Aberdeen in 1848. He took first-class honours in classics at Aberdeen, subsequently studied at Göttingen (under Ritschl) and at New College, Hampstead, and entered the Congregational ministry. Having held pastorates at Shipley, Hackney, Manchester, Leicester and Cambridge, he became principal of Hackney Theological College, Hampstead, in 1901. In 1907 he delivered the Lyman Beecher lectures on preaching at Yale University, published as *Positive Preaching and Modern Mind*. Among his other publications may be mentioned *Religion in Recent Art*, and articles in the *Contemporary Review*, *Hibbert Journal*, and *London Quarterly*. He was chairman of the Congregational Union of England and Wales in 1905.

FORTALEZA (usually called CEARÁ by foreigners), a city and port of Brazil and the capital of the state of Ceará, on a crescent-shaped indentation of the coast-line immediately W. of Cape Mucuripe or Mocaripe, $7\frac{1}{2}$ m. from the mouth of the Ceará river, in lat. $3^{\circ} 42' S.$, long. $38^{\circ} 30' W.$ Pop. (1890) of the municipality, including a large rural district, 40,902. The city stands on an open sandy plain overlooking the sea, and is regularly laid out, with broad, well-paved, gas-lighted streets and numerous squares. Owing to the aridity of the climate the vegetation is less luxuriant than in most Brazilian cities. The temperature is usually high, but it is modified by the strong sea winds. Fortaleza has suffered much from epidemics of yellow-fever, small-pox and beri-beri, but the climate is considered to be healthy. A small branch of the Ceará river, called the Pajehú, traverses the city and divides it into two parts, that on its right bank being locally known as Outeiro. Fortaleza is the see of a bishopric, created in 1854, but it has no cathedral, one of its ten churches being used for that purpose. Its public buildings include the government house, legislative chambers, bishop's palace, an episcopal seminary, a lyceum (high school), Misericordia hospital, and asylums for mendicants and the insane. The custom-house stands nearer the seashore, $1\frac{3}{4}$ m. from the railway station in the city, with which it is connected by rail. The port is the principal outlet for the products of the state, but its anchorage is an open roadstead, one of the most dangerous on the northern coast of Brazil, and all ships are compelled to anchor well out from shore and discharge into lighters. Port improvements designed by the eminent engineer Sir John Hawkshaw have been under construction for many years, but have made very slow progress. The Baturité railway, built by the national government partly to give employment to starving refugees in times of long-continued droughts, connects the city and its port with fertile regions to the S.W., and extends to Senador Pompeu, 178 m. distant. The exports include sugar, coffee, rubber, cotton, rum, rice, beans, fruits, hides and skins.

Fortaleza had its origin in a small village adjoining a fort established at this point in early colonial times. In 1654 it took the name of Villa do Forte da Assumpção, but it was generally spoken of as Fortaleza. In 1810 it became the capital of Ceará, and in 1823 it was raised to the dignity of a city under the title of Fortaleza da Nova Bragança.

FORT AUGUSTUS, a village of Inverness-shire, Scotland. Pop. (1901) 706. It is delightfully situated at the south-western extremity of Loch Ness, about 30 m. S.W. of Inverness, on the rivers Oich and Tarff and the Caledonian Canal. A branch line connects with Spean Bridge on the West Highland railway via Invergarry. The fort, then called Kilchumin, was built in 1716 for the purpose of keeping the Highlanders in check, and was enlarged in 1730 by General Wade. It was captured by the Jacobites in 1745, but reoccupied after the battle of Culloden,

when it received its present name in honour of William Augustus, duke of Cumberland, the victorious general. The fort was used as a sanatorium until 1857, when it was bought by the 12th Lord Lovat, whose son presented it in 1876 to the English order of Benedictines. Within four years there rose upon its site a pile of stately buildings under the title of St Benedict's Abbey and school, a monastic and collegiate institution intended for the higher education of the sons of the Roman Catholic nobility and gentry. The series of buildings consists of the college, monastery, hospice and scriptorium—the four forming a quadrangle connected by beautiful cloisters. Amongst its benefactors were many Catholic Scots and English peers and gentlemen whose arms are emblazoned on the windows of the spacious refectory hall. The summit of the college tower is 110 ft. high.

FORT DODGE, a city and the county-seat of Webster county, Iowa, U.S.A., on the Des Moines river, 85 m. (by rail) N. by W. from Des Moines. Pop. (1890) 4871; (1900) 12,162; (1905, state census) 14,369, (2269 being foreign-born); (1910) 15,543. It is served by the Illinois Central, the Chicago Great Western, the Minneapolis & Saint Louis, and the Fort Dodge, Des Moines & Southern railways, the last an electric interurban line. Eureka Springs and Wild Cat Cave are of interest to visitors, and attractive scenery is furnished by the river and its bordering bluffs. The river is here spanned by the Chicago Great Western railway steel bridge, or viaduct, one of the longest in the country. Fort Dodge is the seat of Tobin College (420 students in 1907-1908), a commercial and business school, with preparatory, normal and classical departments, and courses in oratory and music; among its other institutions are St Paul's school (Evangelical Lutheran), two Roman Catholic schools, Corpus Christi Academy and the Sacred Heart school, Our Lady of Lourdes convent and a Carnegie library. Oleson Park and Reynold's Park are the city's principal parks. Immediately surrounding Fort Dodge is a rich farming country. To the E. of the city lies a gypsum bed, extending over an area of about 50 sq. m., and considered to be the most valuable in the United States; to the S. coal abounds; there are also limestone quarries and deposits of clay in the vicinity—the clay being, for the most part, obtained by mining. Fort Dodge is a market for the products of the surrounding country, and is a shipping centre of considerable importance. It has various manufactures, including gypsum, plaster, oatmeal, brick and tile, sewer pipe, pottery, foundry and machine-shop products, and shoes. In 1905 the value of all the factory products was \$3,025,650, an increase of 200.8% over that for 1900. Fort Clark was erected on the site in 1850 to protect settlers against the Indians; in 1851 the name was changed by order of the secretary of war to Fort Dodge in honour of Colonel Henry Dodge (1782-1867), who was a lieutenant-colonel of Missouri Volunteers in the War of 1812, served with distinction as a colonel of Michigan Mounted Volunteers in the Black Hawk War, resigned from the military service in March 1833, was governor of Wisconsin Territory from 1836 to 1841 and from 1846 to 1848, and was a delegate from Wisconsin Territory to Congress from 1841 to 1845, and a United States senator from Wisconsin in 1848-1857. The fort was abandoned in 1853, and in 1854 a town was laid out. It was chartered as a city in 1869. From the gypsum beds near Fort Dodge was taken in 1868 the block of gypsum from which was modelled the "Cardiff Giant," a rudely-fashioned human figure, which was buried near Cardiff, Onondaga county, New York, where it was "discovered" late in 1869. It was then exhibited in various parts of the country as a "petrified man." The hoax was finally exposed by Professor Othniel C. Marsh of Yale; and George Hall of Binghamton, N.Y., confessed to the fraud, his object having been to discredit belief in the "giants" of Genesis vi. 4. (See "The Cardiff Giant: the True Story of a Remarkable Deception," by Andrew D. White, in the *Century Magazine*, vol. xlii., 1902.)

FORT EDWARD, a village of Washington county, New York, U.S.A., in the township of Fort Edward, on the Hudson river, 56 m. by rail N. of Albany. Pop. of the village (1900) 3521, of whom 385 were foreign-born; (1905) 3806; (1910) 3762; of

the township, including the village (1900, 5216; (1905, 5300; (1910) 5740. The village lies mostly at the foot of a steep hill, is at the junction of the main line and the Glens Falls branch of the Delaware & Hudson railway, and is also served by electric line to Albany and Glens Falls; the barge canal connecting Lake Champlain and the Hudson river enters the Hudson here. The river furnishes good water-power, which is used in the manufacture of paper and wood pulp, the leading industry. Shirts and pottery (flower pots, jars and drain tile) are manufactured also. The village is the seat of the Fort Edward Collegiate Institute, a non-sectarian school for girls, which was founded in 1854 and until 1893 was coeducational. The village owns and operates the waterworks. Indian war parties on their way to Canada were accustomed to make a portage from this place, the head of navigation for small boats on the Hudson, to Lake George or Lake Champlain, and hence it was known as the Great Carrying Place. Governor (afterwards Sir) Francis Nicholson in 1709, in his expedition against Canada, built here a stockade which was named Fort Nicholson. Some years afterwards John Henry Lydius (1693-1791) established a settlement and protected it by a new fort, named Fort Lydius, but this was destroyed by the French and Indians in 1745. In 1755, a third fort was built by General Phineas Lyman (1716-1774), as preliminary to the expedition against Crown Point under General William Johnson, and was named Fort Lyman; in 1756 Johnson renamed it Fort Edward in honour of Edward, Duke of York. In the War for Independence Fort Edward was the headquarters of General Philip Schuyler while he and his troops were blocking the march of General Burgoyne's army from Fort Ticonderoga. When a part of Burgoyne's forces was distant only 3 or 4 m. from Fort Edward, on Fort Edward Hill, on the 27th of July 1777, the leader of an Indian band whose assistance the British had sought is supposed to have murdered Jane McCrea (c. 1757-1777), a young girl who had been visiting friends in Fort Edward, and who was to be escorted on that day to the British camp and there to be married to David Jones, a loyalist serving as a lieutenant in Burgoyne's army; it is possible that she was shot accidentally by Americans pursuing her Indian escorts, but her death did much to rouse local sentiment against Burgoyne and his Indian allies, and caused many volunteers to join the American army resisting Burgoyne's invasion. A monument has been erected by the Jane McCrea Chapter of the Daughters of the American Revolution near the spot where she was killed, and she is buried in Union Cemetery in Fort Edward. Fort Edward township was erected in 1818 from a part of the township of Argyle. Fort Edward village was incorporated in 1852.

See R. O. Bascom, *The Fort Edward Book* (Fort Edward, 1903).

FORTESCUE, SIR JOHN (c. 1394-c. 1476), English lawyer, the second son of Sir John Fortescue, of an ancient family in Devonshire, was born at Norris, near South Brent, in Somersetshire. He was educated at Exeter College, Oxford. During the reign of Henry VI. he was three times appointed one of the governors of Lincoln's Inn. In 1441 he was made a king's sergeant at law, and in the following year chief justice of the king's bench. As a judge Fortescue is highly recommended for his wisdom, gravity and uprightness; and he seems to have enjoyed great favour with the king, who is said to have given him some substantial proofs of esteem and regard. He held his office during the remainder of the reign of Henry VI., to whom he steadily adhered; and having faithfully served that unfortunate monarch in all his troubles, he was attainted of treason in the first parliament of Edward IV. When Henry subsequently fled into Scotland, he is supposed to have appointed Fortescue, who appears to have accompanied him in his flight, chancellor of England. In 1463 Fortescue accompanied Queen Margaret and her court in their exile on the Continent, and returned with them afterwards to England. During their wanderings abroad the chancellor wrote for the instruction of the young prince Edward his celebrated work *De laudibus legum Angliae*. On the defeat of the Lancastrian party he made his submission to Edward IV., from whom he received a general pardon dated

Westminster, October 13, 1471. He died at an advanced age, but the exact date of his death has not been ascertained.

Fortescue's masterly vindication of the laws of England, though received with great favour by the learned of the profession to whom it was communicated, did not appear in print until the reign of Henry VIII., when it was published, but without a date. It was subsequently many times reprinted. Another valuable and learned work by Fortescue, written in English, was published in 1714, under the title of *The Difference between an Absolute and a Limited Monarchy*. In the Cotton library there is a manuscript of this work, in the title of which it is said to have been addressed to Henry VI.; but many passages show plainly that it was written in favour of Edward IV. A revised edition of this work, with a very valuable historical and biographical introduction, was published in 1885 by Charles Plummer, under the title *The Governance of England*. All of Fortescue's minor writings appear in *The Works of Sir John Fortescue, now first Collected and Arranged*, published in 1869 for private circulation, by his descendant, Lord Clermont.

AUTHORITIES.—Plummer's Introduction to *The Governance of England*; *Life* in Lord Clermont's edition; Gairdner's *Paston Letters*; Foss's *Lives of the Judges*.

FORTESCUE, SIR JOHN (c. 1531-1607), English statesman, was the eldest son of Sir Adrian Fortescue (executed in 1539), and of his second wife, Anne, daughter of Sir William Reade or Redc of Borstall in Buckinghamshire. The exact date of his birth is unrecorded.¹ He was restored in blood and to his estate at Shirburn in Oxfordshire in 1551. Through his father's mother, Alice, daughter of Sir Geoffrey Boleyn, he was a second cousin once removed from Queen Elizabeth. He acquired early a considerable reputation as a scholar and was chosen to direct the Princess Elizabeth's classical studies in Mary's reign. On the accession of Elizabeth he was appointed keeper of the great wardrobe. He was returned in 1572 to parliament for Wallingford, in 1586 for Buckingham borough, in 1588 and 1597 for Buckingham county, and in 1601 for Middlesex. In 1589 he was appointed chancellor of the exchequer and a member of the privy council. In 1592 he was knighted, and in November 1601, in addition to his two great offices, he received that of chancellor of the duchy of Lancaster. By means of his lucrative employments he amassed great wealth, with which he bought large estates in Oxfordshire and Buckinghamshire, and kept up much state and a large household. He took a prominent part in public business, was a member of the court of the star chamber and an ecclesiastical commissioner, sat on various important commissions, and as chancellor of the exchequer explained the queen's financial needs and proposed subsidies in parliament. On the death of Elizabeth he suggested that certain restrictions should be imposed on James's powers, in order probably to limit the appointment of Scotchmen to office,² but his advice was not followed. He was deprived by James of the chancellorship of the exchequer, but evidently did not forfeit his favour, as he retained his two other offices and entertained James several times at Henden and Salden. In 1604 Sir John, who stood for Buckinghamshire, was defeated by Sir Francis Goodwin, whose election, however, was declared void by the lord chancellor on the ground of a sentence of outlawry under which he lay, and Fortescue was by a second election returned in his place. This incident gave rise to a violent controversy, regarding the chancellor's jurisdiction in deciding disputed elections to parliament, which was repudiated by the Commons but maintained by the king. The matter after much debate was ended by a compromise, which, while leaving the principle unsettled, set aside the elections of both candidates and provided for the issue of a new writ. Fortescue was then in February 1606 returned for Middlesex, which he represented till his death on the 23rd of December 1607. He was buried in Mursley church in Buckinghamshire, where a monument was erected to his memory. His long public career was highly honourable, and he served his sovereign and country with unswerving fidelity and honesty. His learned attainments too were considerable—Camden styles him "vir integer, Graece,

¹ The inscription on his tomb states that he was 76 at his death on the 23rd of December 1607 (Lord Clermont's *Hist. of the Family of Fortescue*, 377), but according to a statement ascribed to himself, he was born the same year as Queen Elizabeth and therefore in 1533 (Bucks. Architect. and Archaeolog. Soc. *Records of Bucks*, i. p. 89).

² David Lloyd's *State Worthies* (1670), 556.

Latineque apprime eruditus,"¹ and his scholarship is also praised by Lloyd, while his friendship with Sir Thomas Bodley procured gifts of books and manuscripts to the latter's library. Fortescue married (1) Cecily, daughter of Sir Edmund Ashfield of Ewelme, by whom, besides a daughter, he had two sons, Sir Francis and Sir William; and (2) Alice, daughter of Christopher Smyth of Annabels in Hertfordshire, by whom he had one daughter. His descent in the male line became extinct with the death of Sir John Fortescue, 3rd baronet, in 1717.

BIBLIOGRAPHY.—Article in the *Dict. of Nat. Biography*; Lord Clermont's *Hist. of the Family of the Fortescues*; *Hist. Notices of the Parishes of Swyncombe and Ewelme*, by A. Napier, p. 390; D. Lloyd's *State Worthies* (1670), p. 556; *Add. MSS.* 12497 f. 143 ("Sir John Fortescue's meanes of gaine by Sir R. Thikstin told me [Sir Julius Caesar]"); *Hist. MSS. Comm., Marquis of Salisbury's MSS.*; Spedding's *Life of Bacon*; Architectural and Archaeological Soc. for Bucks, *Records of Bucks*, vol. i. p. 86. (P. C. Y.)

FORTEVIOT, a village and parish of Perthshire, Scotland, on the Water of May, a right-hand affluent of the Earn, 6 $\frac{3}{4}$ m. S.W. of Perth. Pop. of parish (1901) 562. It is a place of remote antiquity, having been a capital of the Picts, when the district was known as Fortrenn, and afterwards of the Scots. The army led by Edward Baliol camped here before the battle of Dupplin (1332), in which the regent, Donald, earl of Mar, was slain along with 13,000 out of 30,000 men. The parish of Findo-Gask adjoining it on the N.W. contains remains of a Roman road, station and outpost, besides the "auld hoose" of Gask in which the Baroness Nairne was born, and which forms the theme of one of her most popular songs. The new house in which she died dates from 1801.

FORT GEORGE, a military station of Inverness-shire, Scotland. It lies 12 m. N.E. of Inverness, and is the terminus of the small branch line connecting with the Highland railway at Gollanfield junction. It occupies a sandy promontory forming the extreme end of the southern shore of Inner Moray Firth (also called the Firth of Inverness), which is here only 1 m. wide. There is communication by ferry with Fortrose on the opposite coast of the Black Isle. The fort was begun in 1748, partly after the plan of one of Vauban's works, and named in honour of George II. Wolfe, who saw it in course of erection in 1751, was much impressed with it and thought it would, when finished, be "the most considerable fortress and best situated in Great Britain." It covers 16 acres and contains accommodation for nearly 2200 men. It is the depot of the Seaforth Highlanders, and a military training-ground of some size and importance because the surrounding country gives ample facilities for exercise and manœuvres. General Wade's road is maintained in good order. Fort George, it is said, had almost been chosen as the place of detention for Napoleon when the claims of St Helena were put forward. About 2 m. S.E. is the fishing village of Campbelltown, in growing repute as a seaside resort. Midway between the fort and Inverness stands Castle Stuart, a shooting-box of the earl of Moray.

FORTH, a river and firth of the east of Scotland. The river is formed by two head streams, Duchray Water (12 m.) and Avondhu (10 m.), or Laggan as it is called after it leaves Loch Ard, both rising in the north-east of Ben Lomond in Stirlingshire, and uniting 1 m. west of Aberfoyle. From this point till it receives the Kelty, the Forth continues to be a Perthshire stream, but afterwards it becomes the dividing line between the counties of Perth and Stirling as far as the confluence of the Allan. Thence it belongs to Stirlingshire to a point 1 $\frac{1}{2}$ m. due west of Cambus, whence it serves as the boundary between the shires of Stirling and Clackmannan. Owing to the extremely tortuous character of its course between Gartmore and Alloa—the famous "links of the Forth,"—the actual length of the river is 66 m., or nearly double the distance in a direct line (30 m.) between the source of the Duchray and Kincardine, where the firth begins. The river drains an area of 645 sq. m. Its general direction is mainly easterly with a gentle trend towards the south, and the principal tributaries on the left are the Goodie, Teith, Allan and Devon, and on the right, the Kelty, Boquhan

¹ *Annales*, 613.

and Bannock. The alluvial plain extending from Gartmore to the county town is called the Carse of Stirling. The places of interest on the banks are Aberfoyle, Kippen, Stirling, Cambuskenneth, Alloa and Kincardine, but after it crosses the Highland line the Forth does not present many passages of remarkable beauty. There are bridges at Aberfoyle, Gartmore, Frew, Drip and Stirling (2), besides railway viaducts at Stirling and Alloa, and there are ferries at Stirling (for Cambuskenneth), Alloa (for South Alloa) and Kincardine (for Airth). The tide rises to 4 $\frac{1}{2}$ m. above Stirling, where the river is navigable at high water by vessels of 100 tons. There is, however, a brisk shipping trade at Alloa, where the dock accommodates vessels of at least 300 tons.

The Firth of Forth extends from Kincardine to the North Sea, that is, to an imaginary line drawn, just west of the Isle of May, from the East Neuk of Fife to the mouth of the Tyne in Haddingtonshire—a distance of 48 m. Thus, according to some calculations, the Forth measures from source to sea 114 m. The width of the firth varies from $\frac{1}{2}$ m. at Kincardine and 1 $\frac{1}{2}$ m. at Queensferry to 6 $\frac{1}{2}$ m. at Leith and 17 $\frac{1}{2}$ m. at the mouth. The chief affluents are, on the south, the Carron, Avon, Almond, Leith, Esk and Tyne, and on the north, the Tiel, Leven, Kiel and Dreel. The principal ports on the south shore are Grangemouth, Bo'ness, Granton and Leith, and on the north, Burntisland and Kirkcaldy; but fishery centres and holiday resorts are very numerous on both coasts. Since the opening of the Forth Bridge (see BRIDGES) in 1890 the ferries at Queensferry and Burntisland have greatly diminished in importance. The fisheries are still considerable, though the oyster trade is dwindling. The larger islands are Inchcolm, with the ruins of an abbey, Inchkeith, with fortifications and a lighthouse, and the Isle of May, with a lighthouse. The anchorage of St Margaret's Hope, with the naval base of Rosyth, lies off the shore of Fife immediately to the west of the Forth Bridge.

The Forth was the *Bodotria* of Tacitus and the Scots Water of the chroniclers of the 11th and 12th centuries; while Bede (d. 735) knew the firth as *Sinus orientalis* (the Eastern Gulf), and Nennius (fl. 796) as *Mare Friesicum* (the Frisian Sea).

FORTIFICATION AND SIEGECRAFT. "Fortification" is the military art of strengthening positions against attack. The word (Lat. *fortis*, strong, and *facere*, to make) implies the creation of defences. Thus the boy who from the top of a mound defies his comrades, or shelters from their snowballs behind a fence, is merely taking advantage of ground; but if he puts up a hurdle on his mound and stands behind that he has fortified his position.

Fortification consists of two elements, viz. *protection* and *obstacle*. The protection shields the defender from the enemy's missiles; the obstacle prevents the enemy from coming to close quarters, and delays him under fire.

Protection may be of several kinds, direct or indirect. Direct protection is given by a wall or rampart of earth, strong enough to stop the enemy's missiles. The value of this is reduced in proportion as the defender has to expose himself to return the enemy's fire, or to resist his attempts to destroy the defences. Indirect protection is given by *distance*, as for instance by a high wall placed on a cliff so that the defender on the top of the wall is out of reach of the enemy's missiles if these are of short range, such as arrows. This kind of defence was very popular in the middle ages. In the present day the same object is attained by pushing out detached forts to such a distance from the town they are protecting that the besieger cannot bombard the town as long as he is outside the forts. Another form of indirect protection of great importance is *concealment*.

The *obstacle* may consist of anything which will impede the enemy's advance and prevent him from coming to close quarters. In the earliest forms of fortification the protecting wall was also the obstacle, or it may be a wet or dry ditch, an entanglement, a swamp, a thorn hedge, a spiked palisade, or some temporary expedient, such as crows' feet or chevaux de frise. The two elements must of course be arranged in combination. The besieged must be able to defend the obstacle from their protected position, otherwise it can be surmounted or destroyed at leisure. But a close connexion is no longer essential. The effect of modern

firearms permits of great elasticity in the disposition of the obstacle; and this simplifies some of the problems of defence.

Protection must be arranged mainly with reference to the enemy's methods of attack and the weapons he uses. The obstacle, on the other hand, should be of such a nature as to bring out the best effects of the defender's weapons. It follows from this that a well-armed force operating against a badly-armed uncivilized enemy may use with advantage very simple old-fashioned methods of protection; or even dispense with it altogether if the obstacle is a good one.

When the assailant has modern weapons the importance of protection is very great. In fact, it may be said that in proportion as missile weapons have grown more effective, the importance of protection and the difficulty of providing it have increased, while the necessity for a monumental physical obstacle has decreased.

The art of the engineer who is about to fortify consists in appreciating and harmonizing all the conditions of the problem, such as the weapons in use, nature of the ground, materials available, temper of assailants and defenders, strategical possibilities, expenditure to be incurred, and so forth. Few of these conditions are in themselves difficult to understand, but they are so many and their reactions are so complex that a real familiarity with all of them is essential to successful work. The keynote of the solution should be simplicity; but this is the first point usually lost sight of by the makers of "systems," especially by those who during a long period of peace have time to give play to their imaginations.

Fortification is usually divided into two branches, namely *permanent fortification* and *field fortification*. Permanent fortifications are erected at leisure, with all the resources that a state can supply of constructive and mechanical skill, and are built of enduring materials. Field fortifications are extemporized by troops in the field, perhaps assisted by such local labour and tools as may be procurable, and with materials that do not require much preparation, such as earth, brushwood and light timber. There is also an intermediate branch known as *semi-permanent fortification*. This is employed when in the course of a campaign it becomes desirable to protect some locality with the best imitation of permanent defences that can be made in a short time, ample resources and skilled civilian labour being available.

The *objects of fortification* are various. The vast encintes of Nineveh and Babylon were planned so that in time of war they might give shelter to the whole population of the country except the field army, with their flocks and herds and household stuff. The same idea may be seen to-day in the walls of such cities as Kano. In the middle ages feudal lords built castles for security against the attacks of their neighbours, and also to watch over towns or bridges or fords from which they drew revenue; whilst rich towns were surrounded with walls merely for the protection of their own inhabitants and their property. The feudal castles lost their importance when the art of cannon-founding was fairly developed; and in the leisurely wars of the 17th and 18th centuries, when roads were few and bad, a swarm of fortified towns, large and small, played a great part in delaying the march of victorious armies.

In the present day isolated forts are seldom used, and only for such purposes as to block passes in mountainous districts. Fortresses are used either to protect points of vital importance, such as capital cities, military depots and dockyards, or at strategic points such as railway junctions. Combinations of fortresses are also used for more general strategic purposes, as will be explained later.

I. HISTORY

The most elementary type of fortification is the thorn *hedge*, a type which naturally recurs from age to age under primitive conditions. Thus, Alexander found the villages of the *Ancient methods.* Hyrcanians defended by thick hedges, and the same arrangements may be seen to-day among the least civilized tribes of Africa. The next advance from the hedge is

the *bank* of earth, with the exterior made steep by revetments of sods or hurdle-work. This has a double advantage over the hedge, as, besides being a better obstacle against assault, it gives the defenders an advantage of position in a hand-to-hand fight. Such banks formed the defences of the German towns in Caesar's time, and they were constructed with a high degree of skill. Timber being plentiful, the parapets were built of alternate layers of stones, earth and tree trunks. The latter were built in at right angles to the length of the parapet, and were thus very difficult to displace, while the earth prevented their being set on fire. The bank was often strengthened by a palisade of tree trunks or hurdle-work.

After the bank the most important step in advance for a nation progressing in the arts was the *wall*, of masonry, sun-dried brick or mud. The history of the development of the wall and of the methods of attacking it is the history of fortification for several thousand years.

The first necessity for the wall was height, to give security against escalade. The second was thickness, so that the defenders might have a platform on the top which would give them space to circulate freely and to use their weapons. A lofty wall, thick enough at the top for purposes of defence, would be very expensive if built of solid masonry; therefore the plan was early introduced of building two walls with a filling of earth or rubble between them. The face of the outer wall would be carried up a few feet above the platform, and crenellated to give protection against arrows and other projectiles.

The next forward step for the defence was the construction of *towers* at intervals along the wall. These provided flanking fire along the front; they also afforded refuges for the garrison in case of a successful escalade, and from them the platform could be enfiladed.

The evolution of the wall with towers was simple. The main requirements were despotic power and unlimited labour. Thus the finest examples of the system known to history are also amongst the earliest. One of these was Nineveh, built more than 2000 years B.C. The object of its huge perimeter, more than 50 m., has been mentioned. The wall was 120 ft. high and 30 ft. thick; and there were 1500 towers.

After this no practical advance in the art of fortification was made for a very long time, from a constructional point of view. Many centuries indeed elapsed before the inventive genius of man evolved engines and methods of attack fit to cope with such colossal obstacles.

The earliest form of attack was of course *escalade*, either by ladders or by heaping up a ramp of faggots or other portable materials. When the increasing height of walls made escalade too difficult, other means of attack had to be invented. Probably the first of these were the *ram*, for battering down the walls, and *mining*. The latter might have two objects: (a) to drive an underground gallery below the wall from the besiegers' position into the fortress, or (b) to destroy the wall itself by undermining.

The use of missile *engines* for throwing heavy projectiles probably came later. They are mentioned in the preparations made for the defence of Jerusalem against the Philistines in the 8th century B.C. They are not mentioned in connexion with the siege of Troy. At the sieges of Tyre and Jerusalem by Nebuchadnezzar in 587 B.C. we first find mention of the ram and of movable towers placed on mounds to overlook the walls.

The Asiatics, however, had not the qualities of mind necessary for a systematic development of siegecraft, and it was left for the Greeks practically to create this science. Taking it up in the 5th century B.C. they soon, under Philip of Macedon and Alexander, arrived at a very high degree of skill. They invented and systematized methods which were afterwards perfected by the Romans. *Classical times.* Alexander's siegecraft was extremely practical. His successors endeavoured to improve on it by increasing the size of their missile and other engines, which, however, were so cumbrous that they were of little use. When the Romans a little later took up the science they returned to the practical methods of Alexander, and by the time of Caesar's wars had become past-masters of it. The

highest development of siegecraft before the use of gunpowder was probably attained in the early days of the Roman empire. The beginning of the Christian era is therefore a suitable period at which to take a survey of the arts of fortification and siegecraft as practised by the ancients.

In fortification the wall with towers was still the leading idea. The towers were preferred circular in plan, as this form offered the best resistance to the ram. The wall was usually reinforced by a ditch, which had three advantages: it increased the height of the obstacle, made the bringing up of the engines of attack more difficult, and supplied material for the filling of the wall. In special cases, as at Jerusalem and Rhodes, the enclosure walls were doubled and trebled. Citadels were also built on a large scale.

The typical site preferred by the Romans for a fortified town was on high ground sloping to a river on one side and with steep slopes falling away on the other three sides. At the highest point was a castle serving as citadel. The town enclosure was designed in accordance with the character of the surrounding country. Where the enemy's approach was easiest, the walls were higher, flanking towers stronger and ditches wider and deeper. Some of the towers were made high for look-out posts. If there was a bridge over the river, it was defended by a bridge-head on the far side; and stockades defended by towers were built out from either bank above and below the bridge, between which chains or booms could be stretched to bar the passage.

The natural features of the ground were skilfully utilized. Thus when a large town was spread over an irregular site broken by hills, the enceinte wall would be carried over the top of the hills; and in the intervening valleys the wall would not only be made stronger, but would be somewhat drawn back to allow of a flanking defence from the hill tops on either side. The walls would consist of two strong masonry faces, 20 ft. apart, the space between filled with earth and stones. Usually when the lie of the ground was favourable, the outside of the wall would be much higher than the inside, the parapet walk perhaps being but a little above the level of the town. Palisades were used to strengthen the ditches, especially before the gates.

There was little scope, however, in masonry for the genius of Roman warfare, which had a better opportunity in the active work of attack and defence. For siegecraft the Roman legions were specially apt. No modern engineer, civil or military, accustomed to rely on machinery, steam and hydraulic apparatus, could hope to emulate the feats of the legionaries. In earthworks they excelled; and in such work as building and moving about colossal wooden towers under war conditions, they accomplished things at which nowadays we can only wonder.

The attack was carried on mainly by the use of "engines," under which head were included all mechanical means of attack—towers, missile engines such as catapults and balistae, rams of different kinds, "tortoises" (see below), &c. Mining, too, was freely resorted to, also approach trenches, the use of which had been introduced by the Greeks.

The object of mining, as has been said, might be the driving of a gallery under the wall into the interior of the place, or the destruction of the wall. The latter was effected by excavating large chambers under the foundations. These were supported while the excavation was proceeding by timber struts and planking. When the chambers were large enough the timber supports were burnt and the wall collapsed. The besieged replied to the mining attack by countermines. With these they would undermine and destroy the besiegers' galleries, or would break into them and drive out the workers, either by force of arms or by filling the galleries with smoke.

Breaches in the wall were made by rams. These were of two kinds. For dislodging the cemented masonry of the face of the wall, steel-pointed heads were used; when this was done, another head, shaped like a ram's head, was substituted for battering down the filling of the wall.

For escalade they used ladders fixed on wheeled platforms; but the most important means of attack against a high wall were the movable towers of wood. These were built so high that from their tops the parapet walk of the wall could be swept with arrows and stones; and drawbridges were let down from them, by which a storming party could reach the top of the wall. The height of the towers was from 70 to 150 ft. They were moved on wheels of solid oak or elm, 6 to 12 ft. in diameter and 3 to 4 ft. thick. The ground floor contained one or two rams. The upper floors, of which there might be as many as fifteen, were furnished with missile engines of a smaller kind. The archers occupied the top floor. There also were placed reservoirs of water to extinguish fire. These were filled by force pumps and fitted with hose made of the intestines of cattle. Drawbridges, either hanging or worked on rollers, were placed at the proper height to give access to the top of the wall, or to a breach, as might be required. Apollodorus proposed to place a couple of rams in the upper part of the tower to destroy the crenellations of the wall.

The siege towers had of course to be very solidly built of strong timbers to resist the heavy stones thrown by the engines of the

defence. They were protected against fire by screens of osiers, plaited rope or raw hides. Sometimes it was necessary, in order to gain greater height, to place them on high terraces of earth. In that case they would be built on the site. At the siege of Marseilles, described by Caesar, special methods of attack had to be employed on account of the strength of the engines used by the besieged and their frequent sallies to destroy the siege works. A square fort, with brick walls 30 ft. long and 5 ft. thick, was built in front of one of the towers of the town to resist sorties. This fort was subsequently raised to a height of six storeys, under shelter of a roof which projected beyond the walls, and from the caves of which hung heavy mats made of ships' cables. The mats protected the men working at the walls, and as these were built up the roof was gradually raised by the use of endless screws. The roof was made of heavy beams and planks, over which were laid bricks and clay, and the whole was covered with mats and hides to prevent the bricks from being dislodged. This structure was completed without the loss of a man, and could only have been built by the Romans, whose soldiers were all skilled workmen.

Although these towers were provided with bridges by which storming parties could reach the top of the wall, their main object was usually to dominate the defence and keep down the fire from the walls and towers. Under this protection breaching operations could be carried on. The approaches to the wall were usually made under shelter of galleries of timber or hurdle-work, which were placed on wheels and moved into position as required. When the wall was reached, a shelter of stronger construction, known as a "rat," was placed in position against it. Under this a ram was swung or worked on rollers; or the rat might be used as a shelter for miners or for workmen cutting away the face of the wall. The great rat at Marseilles, which extended from the tower already described to the base of the tower of the city, was 60 ft. long, and built largely of great beams 2 ft. square, connected by iron pins and bands. It was unusually narrow, the ground sills of the side walls being only 4 ft. apart. This was no doubt in order to keep down the weight of the structure, which, massive as it was, had to be movable. The sloping roof and sides of timber were protected, like those of the tower, with bricks and moist clay, hides and wool mattresses. Huge stones and barrels of blazing pitch were thrown from the wall upon this rat without effect, and under its cover the soldiers loosened and removed the foundations of the tower until it fell down.

In order that it might be possible to move these heavy structures, it was usually necessary to fill up the ditch or to level the surface of the ground. For this purpose an "approach tortoise" was often used. This was a shelter, something between the ordinary gallery and the rat, which was moved end on towards the wall, and had an open front with a hood, under cover of which the earth brought up for filling the ditch was distributed.

The missile engines threw stones up to 600 lb weight, heavy darts from 6 to 12 ft. long, and Greek fire. Archimedes at the siege of Syracuse even made some throwing 1800 lb. The ranges varied, according to the machine and the weight thrown, up to 600 yds. for direct fire and 1000 yds. for curved fire. At the siege of Jerusalem Titus employed three hundred catapults of different sizes and forty balistae, of which the smallest threw missiles of 75 lb weight. At Carthage Scipio found 120 large and 281 medium catapults, 23 large and 52 small balistae, and a great number of scorpions and other small missile engines.

Screens and mantlets for the protection of the engine-workers were used in great variety.

In addition to the above, great mechanical skill was shown in the construction of many kinds of machines for occasional purposes. A kind of jib crane of great height on a movable platform was used to hoist a cage containing fifteen or twenty men on to the wall. A long spar with a steel claw at the end, swung in the middle from a lofty frame, served to pull down the upper parts of parapets and overhanging galleries. The defenders on their side were not slow in replying with similar devices. Fenders were let down from the wall to soften the blow of the ram, or the ram heads were caught and held by cranes. Grapnels were lowered from cranes to seize the rats and overturn them. Archimedes used the same idea in the defence of Syracuse for lifting and sinking the Roman galleys. Wooden towers were built on the walls to overtop the towers of the besiegers. Many devices for throwing fire were employed. The tradition that Archimedes burnt the Roman fleet, or a portion of it, at Syracuse, by focusing the rays of the sun with reflectors, is supported by an experiment made by Buffon in 1747. With a reflector having a surface of 50 sq. ft., made up of 168 small mirrors each 6 by 8 in., lead was melted at a distance of 140 ft. and wood was set on fire at 160 ft.

The development of masonry in permanent fortification had long since reached its practical limit, and was no longer proof against the destructive methods that had been evolved. The extemporized defences were, as is always the case, worn down by a resolute besieger, and the attack was stronger than the defence.

Through the dark ages the Eastern Empire kept alive the twin sciences of fortification and siegecraft long enough for the Crusaders to learn from them what had been lost in the West.

Byzantium, however, always a storehouse of military science, while conserving a knowledge of the ancient methods and the great missile engines, contributed no new ideas to fortification, so far as we know. In practice the Byzantines favoured multiplied enceintes or several concentric lines of defence. This of course is always a tendency of decadent nations.

In the West the Roman fortifications remained standing, and the Visigoths, allies of Rome, utilized their principles in the defences of Carcassonne, Toulouse, &c. in the 5th century. Viollet-le-Duc's description and illustrations of the defences of Carcassonne will give a very good idea of the methods then in use:—

"The Visigoth fortification of the city of Carcassonne, which is still preserved, offers an analogous arrangement recalling those described by Vegetius. The level of the town is much more elevated than the ground outside, and almost as high as the parapet walks. The curtain walls, of great thickness, are composed of two faces of small cubical masonry alternating with courses of brick; the middle portion being filled, not with earth but with rubble run with lime. The towers were raised above these curtains, and their communication with the latter might be cut off, so as to make of each tower a small independent fort; externally these towers are cylindrical, and on the side of the town square; they rest, also, towards the country, upon a cubical base or foundation. We subjoin (fig. 1) the plan of one of these towers with the curtains adjoining. A

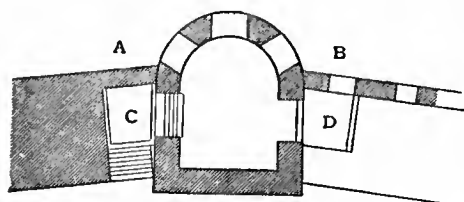

FIG. 1.—Plan of one of the Towers at Carcassonne.

is the plan of the ground-level; B the plan of the first storey at the level of the parapet. We see, at C and D, the two excavations formed in front of the gates of the tower to intercept, when the drawbridges were raised, all communication between the town or the parapet walk and the several storeys of the tower. From the first storey access was had to the upper crenellated or battlemented portion of the tower by a ladder of wood placed interiorly against the side of the flat wall. The external ground-level was much lower than that of the tower, and also beneath the ground-level of the town, from which it was reached by a descending flight of from ten to fifteen steps. Fig. 2 shows the tower and its two curtains on the

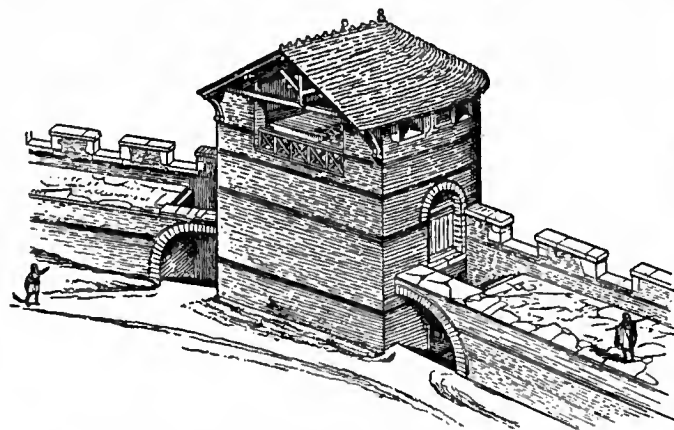

FIG. 2.—One of the Towers at Carcassonne, inside view.

side of the town; the bridges of communication are supposed to have been removed. The battlemented portion at the top is covered with a roof, and open on the side of the town in order to permit the defenders of the tower to see what was going on therein, and also to allow of their hoisting up stones and other projectiles by means of a rope and pulley. Fig. 3 shows the same tower on the side towards the country; we have added a postern, the sill of which is sufficiently raised above the ground to necessitate the use of a scaling or step ladder, to obtain ingress. The postern is defended, as was customary, by a palisade or barrier, each gate or postern being provided with a work of this kind."

Meanwhile, in western Europe, siegecraft had almost disappeared. Its perfect development was only possible for an army like that of the Romans. The Huns and Goths knew

nothing of it, and the efforts of Charlemagne and others of the Frankish kings to restore the art were hampered by the fact that their warriors despised handicrafts and understood nothing but the use of their weapons. During the dark ages the towns of the Gauls retained their old Roman and Visigoth defences, which no one knew properly how to attack, and accordingly the sieges of that period dragged themselves out through long years, and if ultimately successful were so as a rule only through blockade and famine. It was not until the 11th century that siegecraft was revived in the West on the ancient lines.

By this time a new departure of great importance had been

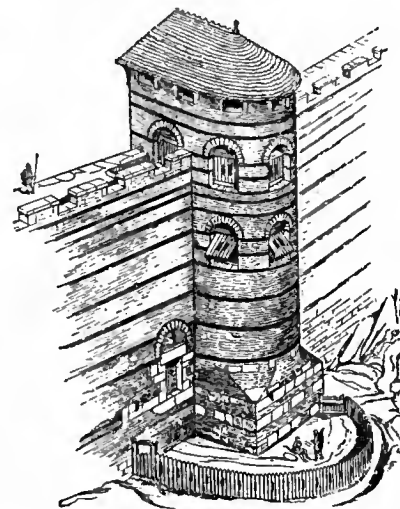

FIG. 3.—One of the Towers at Carcassonne, outside view.

Castles. made in the seigneurial castle (*q.v.*), which restored for some centuries a definite superiority to the defence. Built primarily as strongholds for local magnates or for small bodies of warriors dominating a conquered country, the conditions which called them into existence offered several marked advantages. The defences of a town had to follow the growth of the town, and would naturally have weak points. It was not to be expected that a town would develop itself in the manner most suitable for defence; nor indeed that any position large enough for a town could be found that would be naturally strong all round. But the site of a castle could be chosen purely for its natural strength, without regard, except as a secondary consideration, to the protection of anything outside it; and as its area was small it was often easy to find a natural position entirely suited for the purpose. In fact it frequently happened that the existence of such a position was the *raison d'être* of the castle. A small hill with steep sides might well be unapproachable in every direction by such cumbersome structures as towers and rats, while the height of the hill, added to the height of the walls, would be too much for the besiegers' missiles. If the sides of the hill were precipitous and rocky, mining became impossible, and the site was perfect for defence. A castle built under such conditions was practically impregnable; and this was the cause of the independence of the barons in the 11th and 12th centuries. They could only be reduced by blockade, and a blockade of long duration was very difficult in the feudal age.

A very instructive example of 12th-century work is the Château Gaillard, built by Richard Cœur-de-Lion in 1196. This great castle, with ditches and escarpments cut out of the solid rock, and extensive outworks, was completed in one year. In the article CASTLE will be found the plan of the main work, which is here supplemented by an elevation of the donjon (or keep). The waved face of the inner or main wall of the castle, giving a divergent fire over the front, is an interesting feature in advance of the time. So also is the masonry protection of the machicolation at the top of the donjon, a protection which at that time was usually given by wooden hoardings. After the death of Richard, Philip Augustus besieged the château, and carried it after a blockade of seven months and a regular attack of one month. In this attack the tower at A was first mined, after which the whole of that outwork was abandoned by the defenders. The outer enceinte was next captured by surprise; and finally the gate of the main wall was breached by the pioneers. When this happened a sudden rush of the besiegers

prevented the remains of the garrison from gaining the shelter of the donjon, and they had to lay down their arms.

Château Gaillard, designed by perhaps the greatest general of his time, exemplifies in its brief resistance the weak points of the designs of the 12th century. It is easy to understand how at each step gained by the besiegers the very difficulties which had been placed in the way of their further advance prevented the garrison from reinforcing strongly the points attacked.

In the 13th century many influences were at work in the development of castellar fortification. The experience of such sieges as that of Château Gaillard, and still more that gained in the Crusades, the larger garrisons at the disposal of the great feudal lords, and the importance of the interests which they had to protect in their towns, led to a freer style of design. We must also take note of an essential difference between the forms of attack preferred by the Roman soldiery and by the medieval chivalry. The former, who were artisans as well as soldiers, preferred

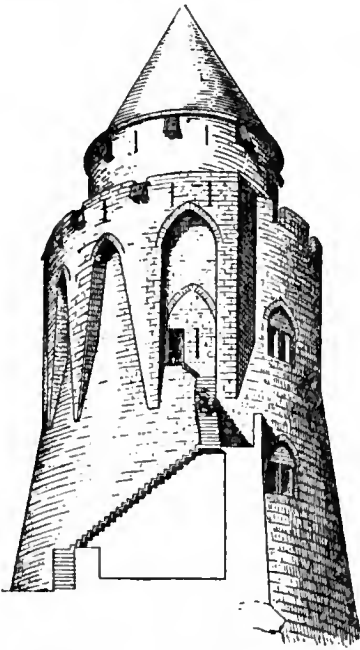

FIG. 4.—Donjon, Château Gaillard.

in siege works the certain if laborious methods of breaching and mining. The latter, who considered all manual labour beneath them and whose only ideal of warfare was personal combat, affected the tower and its bridge, giving access to the top of the wall rather than the rat and battering-ram. They were also fond of surprises, which the bad discipline of the time favoured.

We find, therefore, important progress in enlarging the area of defence and in improving arrangements for flanking. The size and height of all works were increased. The keep of Coucy Castle, built in 1220, was 200 ft. high. Montargis Castle, also built about this time, had a central donjon and a large open enclosure, within

which the whole garrison could move freely, to reinforce quickly any threatened point. The effect of flanking fire was increased by giving more projection to the towers, whose sides were in some cases made at right angles to the curtain walls. We find also a tendency, the influence of which lasted long after medieval times, towards complexity and multiplication of defences, to guard against surprise and localize successful assaults. Great attention was paid to the "step by step" defence. Flanking towers were cut off from their walls and arranged for separate resistance. Complicated entrances with traps and many doors were arranged. Almost all defence was from the tops of the walls and towers, the loopholes on the lower storeys being mainly for light and air and reconnoitring. Machicouli galleries (for vertical defence) were protected either by stone walls built out on corbels, or by strong timber hoardings built in war time, for which the walls were prepared beforehand by recesses left in the masonry. Loopholes and crenelles were protected by shutters. Great care and much ingenuity were expended on details of all kinds.

Already in the 12th century the engineers of the defence had made provision for countermining, by building chambers and galleries at the base of the towers and walls. Further protection for the towers against the pioneer attack was given by carrying out the masonry in front of the tower in a kind of projecting horn. This was found later to have the further advantages of doing away with the dead ground in front of the tower unseen from the curtain, and of increasing the projection and therefore

the flanking power of the tower itself. The arrangement is seen in several of the towers at Carcassonne, and has in it the germ of the idea of the bastion.

The defences of Carcassonne, remodelled in the latter half of the 13th century on the old Visigoth foundations, exemplify some of the best work of the period. Figs. 5 and 6 (reproduced from Viollet-le-Duc) show the plan of the defences of the town and castle, and a bird's-eye view of the castle with its two barbicans. The thick black line shows the main wall; beyond this are the lists and then the moat. It will be noted that the wall of the lists as well as the main wall is defended by towers. There are only two gates. That on the east is defended by two great towers and a semicircular barbican. The gate of the castle, on the west, has a most complicated approach defended by a labyrinth of gates and flanking walls, which cannot be shown on this small scale, and beyond these is a huge circular barbican in several storeys, capable of holding 1500 men. On the side of the town the castle is protected by a wide moat, and the entrance is masked by another large semicircular barbican. An interesting feature of the general arrangement is the importance which the lists

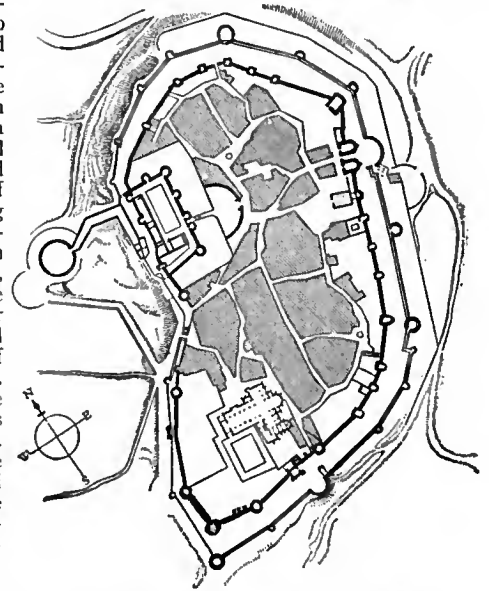

FIG. 5.—Plan of Carcassonne, 13th century.

have assumed. The slight wooden barricade of older times has developed into a wall with towers; and the effect is that the besieger, if he gains a footing in the lists, has a very narrow space in which to work the engines of attack. The castle, after the Roman fashion, adjoins the outer wall of the town, so that there may be a possibility of communicating with a relieving force from outside after the town has fallen. There were also several posterns, small openings made in the wall at some height above the ground, for use with rope ladders.

The siegecraft of the period was still that of the ancients. Mining was the most effective form of attack, and the approach to the walls was covered by engines throwing great stones against the hoardings of the parapets, and by cross-bowmen who were sheltered behind light mantlets moved on wheels. Barrels of burning pitch and other incendiary projectiles were thrown as before; and at one siege we read of the carcasses of dead horses and barrels of sewage being thrown into the town to breed pestilence, which had the effect of forcing a capitulation.

With all this the attack was inferior to the defence. As Professor C. W. C. Oman has pointed out, the mechanical application of the three powers of tension, torsion and counterpoise (in the missile engines) had its limits. If these engines were enlarged they grew too costly and unwieldy. If they were multiplied it was impossible on account of their short range and great bulk to concentrate the fire of enough of them on a single portion of the wall.

It is difficult to give anything like an accurate account, in a small space, of the changes in fortification which took place in the first two centuries after the introduction of gunpowder. The number of existing fortifications that had to be modified was infinite, so also was the number of attempted solutions of the new problems. Engineers had not yet begun to publish descriptions of their "systems"; also the new names and terms which came into use with the new works were spread over Europe by engineers of different countries, and adopted into new languages without much accuracy.

Artillery was in use for some time before it began to have any effect on the design of fortification. The earliest cannon threw so very light a projectile that they had no effect on masonry and

Introduction of gunpowder.

were more useful for the defence than the attack. Later, larger pieces were made, which acted practically as mortars, throwing stone balls with high elevation, and barrels of burning composition. In the middle of the 15th century the art of cannon-founding was much developed by the brothers Bureau in France. They introduced iron cannon balls and greatly strengthened the guns. In 1428 the English besieging Orleans were entirely defeated by the superior artillery of the besieged. By 1450 Charles VII. was furnished with so powerful a siege train that he captured the whole of the castles in Normandy from the English in one year.

But the great change came after the invasion of Italy by Charles VIII. with a greatly improved siege train in 1494. The astonishing rapidity with which castles and fortified towns fell

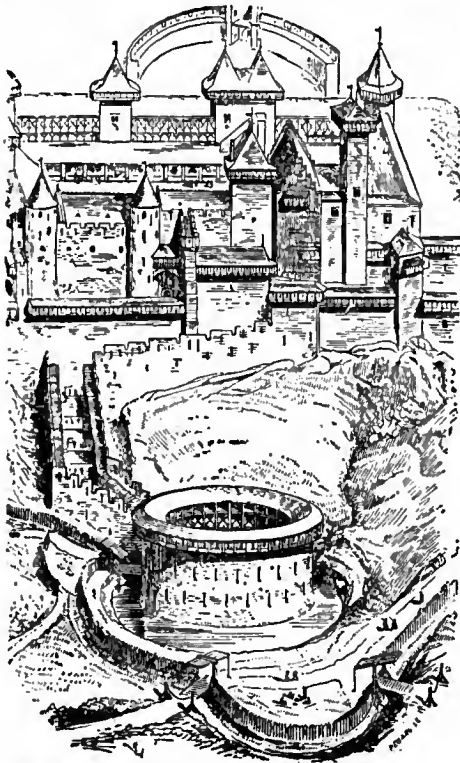

FIG. 6.—Carcassonne Castle and Barbican.

before him proved the uselessness of the old defences. It became necessary to create a new system of defences, and, says Cosseron de Villenoisy, "thanks to the mental activity of the Renaissance and the warlike conditions prevailing everywhere, the time could not have been more favourable." There is no doubt that the engineers of Italy as a body were responsible for the first advance in fortification. There, where vital and mental energy were at boiling-point, and where the first striking demonstration of

the new force had been given, the greatest intellects, men such as Leonardo da Vinci, Michelangelo and Machiavelli, busied themselves over the problem of defence.

It has been claimed that Albert Dürer was the first writer on modern fortification. This was not so; Dürer's work was published in 1527, and more than one Italian engineer, certainly Martini of Siena and San Gallo, had preceded him. Also Machiavelli, writing between 1512 and 1527, had offered some most valuable criticisms and general principles. Dürer, moreover, had little influence on the progress of fortification; though we may see in his ideas, if we choose, the germ of the "polygonal" system, developed long afterwards by Montalembert. Dürer's work was to some extent a connecting link between the old fortification and the new. He proposed greatly to enlarge the old towers; and he provided both them and the curtains with vaulted chambers for guns (casemates) in several tiers, so as to command both the ditch and the ground beyond it. His projects were too massive and costly for execution, but his name is associated with the first practical gun casemates.

Before beginning to trace the effect of gunpowder on the design of fortification, it may be noted that two causes weakened the influence of the castles. First, their owners were slow to adopt the new ideas and abandon their high strong walls for low extended parapets, and, secondly, they had not the men necessary for long lines of defence. At the same time the corporations of the towns had learnt to take an active part in

warfare, and provided trained and disciplined soldiers in large numbers.

When artillery became strong enough to destroy masonry from a distance two results followed: it was necessary to modify the masonry defences so as to make them less vulnerable, and to improve the means of employing the guns of the defence. For both these purposes the older castles with their restricted area were little suited, and we must now trace the development of the fortified towns.

Probably the first form of construction directly due to the appearance of the new weapons was the bulwark (*boulevard, baluardo or bollwerk*). This was an outwork usually semicircular in plan, built of earth consolidated with timber and revetted with hurdles. Such works were placed as a shield in front of the gates, which could be destroyed even by the early light cannon-balls; and they offered at the same time advanced positions for the guns of the defence. They were found so useful for gun positions for flanking fire that later they were placed in front of towers or at intervals along the walls for that purpose.

This, however, was only a temporary expedient, and we have now to consider the radical modifications in designs. These affected both the construction and trace of the walls.

The first lesson taught by improved artillery was that the walls should not be set up on high as targets, but in some manner screened. One method of doing this in the case of old works was by placing bulwarks in front of them. In other cases the lists or outer walls, being surrounded by moats, were already partially screened and suitable for conversion into the main defence; and as with improved flanking defence great height was no longer essential, the tops of the walls were in some cases cut down. In new works it was natural to sink the wall in a ditch, the earth from which was useful for making ramparts.

As regards resistance to the effect of shot, it was found that thin masonry walls with rubble filling behind them were very easily destroyed. A bank of earth behind the wall lessened the vibration of the shot, but once a breach was made the earth came down, making a slope easy of ascent. To obviate this, horizontal layers of brushwood, timber and sometimes masonry were built into the earth bank, and answered very well (fig. 7).

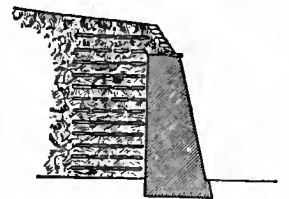

FIG. 7.

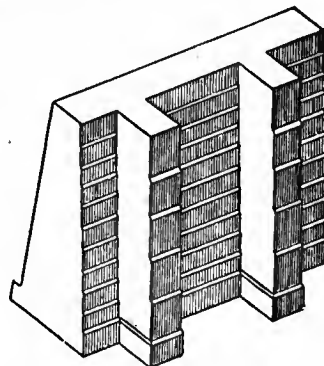

FIG. 8.

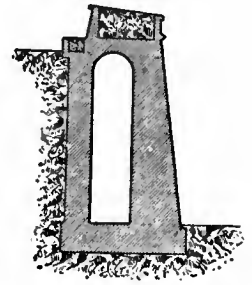

FIG. 9.

Another expedient of still greater value was the use of counterforts. The earliest counterforts were simply buttresses built inward from the wall into the rampart instead of outward (fig. 8). Their effect was to strengthen the wall and make the breaches more difficult of ascent. An alternative arrangement for strengthening the wall was an arched gallery built behind it under the rampart (fig. 9). This construction was in harmony with the idea, already familiar, of a passage in the wall from which countermines could be started; but it has the obvious weakness that the destruction of the face wall takes away one of the supports of the arch. The best arrangement, which is ascribed to Albert Dürer, was the "counter-arched revetment." This consisted of a series of arches built between the counterforts, with their axes at right angles to the face of the wall. Their advantage was that, while supporting the wall and taking all the weight of the rampart, they formed an obstacle after the destruction of the wall more difficult to surmount than the wall itself and very hard to destroy. The counter-arches might be in one, two or three tiers, according to the height of the wall (figs. 10 and 11, the latter without the earth of the rampart and showing also a countermine gallery).

A more important question, however, than the improvement of the passive defence or obstacle was the development of the active

detence by artillery. For this purpose it was necessary to find room for the working of the guns. At the outset it was of course a question of modifying the existing defences at as little cost as possible. With this object the roofs of towers were removed and platforms for guns substituted, but this only gave room for one or two guns. Also the loopholes in the lower storeys of towers were converted into embrasures to give a grazing fire over the ditch; this became the commonest method of strengthening old works for cannon, but was of little use as the resulting field of fire was so small. In some cases the towers were made larger, with a semi-circular front and side walls at right angles to the curtain. Such towers built at Langres early in the 16th century had walls 20 ft. thick to resist battering.

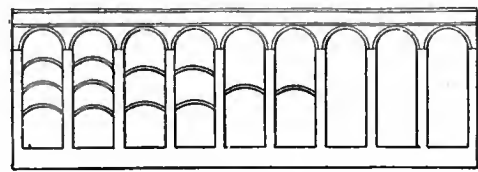

FIG. 10.

Even in new works some attempts were made to combine artillery defence with pure masonry protection. The works of Albert Dürer in theory, and the bridge-head of Schaffhausen in practice, are the best examples of this. The Italian engineers also showed much ingenuity in arranging for the defence of ditches with masonry caponiers. These were developed from external buttresses, and equally with the casemated flanking towers of Dürer contained the germs of the idea of "polygonal" defence.

The natural solution, however, which was soon generally adopted, was the rampart; that is, a bank of earth thrown up behind the wall, which, while strengthening the wall as already indicated, offered plenty of space for the disposal of the guns.

The ditch, which had only been occasionally used in ancient and medieval fortification, now became essential and characteristic. Serving as it did for the double purpose of supplying earth for a rampart and allowing the wall to be sunk for concealment, it was found also to have a definite use as an obstacle. Hitherto the wall had sufficed for this purpose, the ditch being useful mainly to prevent the besieger from bringing up his engines of attack.

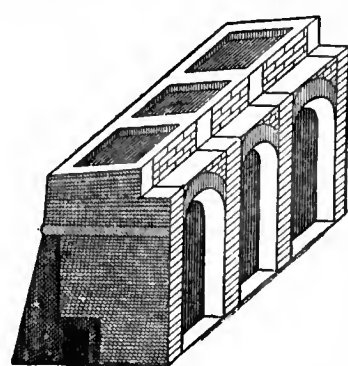

FIG. 11.

When the wall (or escarp) was lowered, the obstacle offered by the ditch was increased by revetting the far side of it with a counterscarp. Beyond the counterscarp wall some of the earth excavated from the ditch was piled up to increase the protection given to the escarp wall. This earth was sloped down gently on the outer side to meet the natural surface of the ground in such a manner as to be swept by the fire from the ramparts and was called the glacis.

Now, however, a new difficulty arose. In all times a chief element in a successful defence has consisted in action by the besieged outside the walls. The old ditches, when they existed, had merely a slope on the far side leading up to the ground-level; and the ditch was a convenient place in which troops preparing for a sortie could assemble without being seen by the enemy, and ascend the slope to make their attack. The introduction of the counterscarp wall prevented sorties from the ditch. At first it was customary, after the introduction of the counterscarp, to leave a narrow space on the top of it, behind the glacis, for a patrol path. Eventually the difficulty was met by widening this patrol path into a space of about 30 ft., in which there was room for troops to assemble. This was known as the covered way.

With this last addition the ordinary elements of a profile of modern fortification were complete and are exemplified in fig. 12.

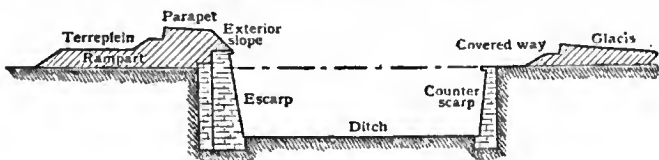

FIG. 12.

Up to the gunpowder period the trace of fortifications, that is, the plan on which they were arranged on the ground, was very simple. It was merely a question of an enclosure wall adapted to the site and provided with towers at suitable intervals. The

foot of the wall could be seen and defended everywhere, from the tops of the towers and the machicolis galleries. The introduction of ramparts and artillery made this more difficult in two ways. The rampart, interposed between the defenders and the face of the wall, put a stop to vertical defence. Also with the inferior gun-carriages of the time very little depression could be given to the guns, and thus the top of the enceinte wall, with or without a rampart, was not a suitable position for guns intended to flank the ditch in their immediate neighbourhood. The problem of the "trace" therefore at the beginning of the 16th century was to rearrange the line of defence so as to give due opportunity to the artillery of the besieged, both to oppose the besiegers' breaching batteries and later to defend the breaches. At the outset the latter rôle was the more important.

In considering the early efforts of engineers to solve this problem we must remember that for economical reasons they had to make the best use they could of the existing walls. At first for flanking purposes casemates on the ditch level were used, the old flanking towers being enlarged for the purpose. Masonry galleries were constructed across the ditch, containing casemates which could fire to either side, and after this casemates were used in the counterscarps. Some use was also made of the fire from detached bulwarks. It was soon realized, however, that the flanking defence of the body of the place ought not to be dependent on outworks, and that greater freedom was required for guns than was consistent with casemate defence. The bulwark (which in its earliest shape suggests that it was in some sort the offspring of the barbican, placed to protect an entrance) gave plenty of space for guns, but was too detached for security. The enlarged tower, as an integral part of the lines, gave security, and its walls at right angles to the curtain gave direct flanking fire, but the guns in it were too cramped. The blending of the two ideas produced the bastion, an element of fortification which dominated the science for three hundred years, and so impressed itself on the imagination that to this day any strong advanced position in a defensive line is called by that name by unscientific writers. The word had been in use for a long time in connexion with extemporized towers or platforms for flanking purposes, the earliest forms being *bastille*, *bastide*, *bastillon*, and in its origin it apparently refers rather to the quality of work in the construction than to its defensive intention.

The earliest bastions were modified bulwarks with straight faces and flanks, attached to the main wall, for which the old towers often acted as keeps; and at first the terms bulwark and bastion were more or less interchangeable. Fig. 13, taken from a contemporary MS. by Viollet-le-Duc, shows a bastion added to the old wall of Troyes about 1528. On the other hand, in fig. 14 (taken from an English MS. of 1559, which again is based on the Italian work of Zanchi published in 1554), we find a *a* spoken of as "bulwarks" and *b b* as "bastilions."

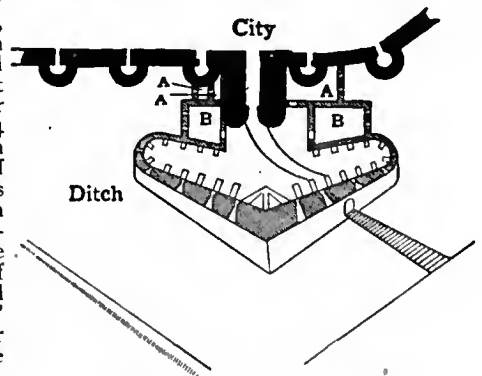

FIG. 13.—Bastion at Troyes.

The triangular works between the bastilions are described as "ramparts," intended to protect the curtains from breaching fire. (We may also notice in this design the broad ditch, the counterscarp with narrow covered way, and loopholes indicating counterscarp galleries.)

Towards the end of the 16th century the term "bulwark" began to be reserved for banks of earth thrown up a little distance in front of the main wall to protect it from breaching fire, and it thus reverted to its original defensive intention. The term "bastion" henceforth denoted an artillery position connected by flanks to the main wall; and the question of the arrangement of these flanks was one of the main preoccupations of engineers.

Flanks retired, casemated or open, or sometimes in several tiers were proposed in infinite variety.

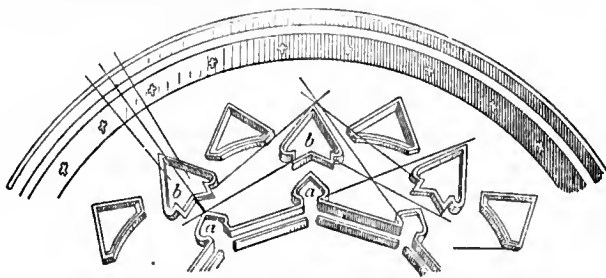
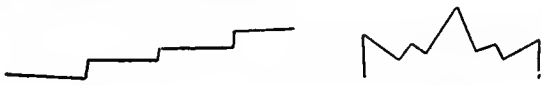

FIG. 14.

Thus, while in the early part of the 16th century the actual modification of existing defences was proceeding very slowly on account of the expense involved, the era of theoretical "systems" had begun, based on the mutual relations of flank and face. These can be grouped under three heads as follows:—

1. The *crémaillère* or indented trace: Faces and flanks succeeding each other in regular order (fig. 15).



2. The *tenaille* trace: Flanks back to back between the faces (fig. 16). The development of the flanks in this case gives us the *star* trace (fig. 17).



3. The *bastioned* trace: Flanks facing each other and connected by curtains (fig. 18).

In comparing these three traces it will be observed that unless casemates are used the flanking in the first two is incomplete. Guns on the ramparts of the faces cannot defend the flanks, and therefore there are "dead" angles in the ditch. In the bastioned trace there is no "dead" ground, provided the flanks are so far apart that a shot from the rampart of a flank can reach the ditch at the centre of the curtain.

Here was therefore the parting of the ways. For those who objected to casemate fire, the bastioned trace was the way of salvation. They were soon in the majority; perhaps because the symmetry and completeness of the idea captivated the imagination. At all events the bastioned trace, once fairly developed, held the field in one form or another practically without a rival until near the end of the 18th century. The Italian engineers, who were supreme throughout most of the 16th century, started it; the French, who took the lead in the following century, developed it, and officially never deserted it until late in the 19th century, when the increasing power of artillery made enceintes of secondary importance.

It will be useful at this point to go forward a little, with a couple of explanatory figures, in order to get a grasp of the component

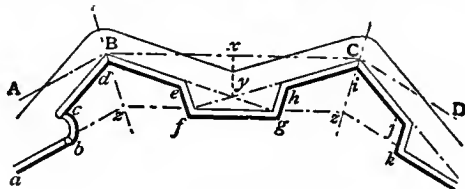

FIG. 19.

parts of the bastioned trace as ultimately developed, and of its outworks. In fig. 19 ABCD represents part of an imaginary line drawn round the place to be fortified, forming a polygon, regular or irregular. ABC is an exterior angle or angle of the polygon.

BC is an exterior side.
 zz is an interior side.
 abcdefghijk is the trace of the enceinte.
 bcdef is a bastion.
 zdef is a demi-bastion.
 de is a face of the bastion.
 ef is a flank of the bastion.
 fg is the curtain.
 bf is the gorge.

(Two demi-bastions with the connecting curtain make the bastioned front, defghi.)

zd bisecting the exterior angle ABC is the capital of the bastion. xy is the perpendicular, the proportionate length of which to the exterior side BC (usually about one-sixth) is an important element of the trace.

efc is the angle of defence.
 BCf is the diminished angle.
 cde is the flanked angle or salient angle of the bastion.
 e is the shoulder of the bastion.
 def is the angle of the shoulder.
 efg is the angle of the flank.

The line of the escarp is called the *magistral line* since it regulates the trace. When plans of fortifications are given without much detail, this line, with that of the counterscarp and the crest of the parapet, are often the only ones shown,—the crest of the parapet, as being the most important line, whence the fire proceeds, being usually emphasized by a thick black line.

Fig. 20, reproduced from a French engraving of 1705, shows an imaginary place fortified as a hexagon with bastions and all the

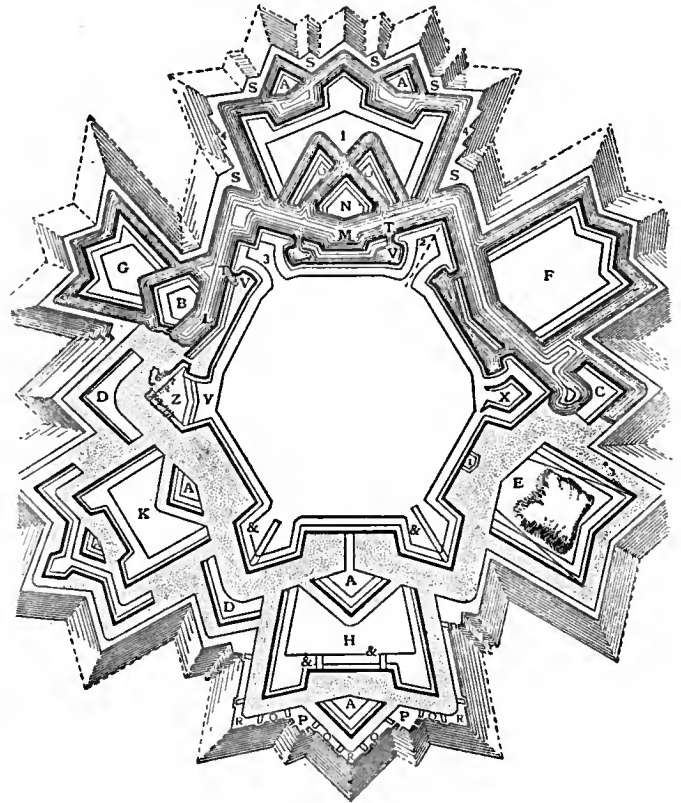

FIG. 20.

different kinds of outworks then in use. The following is the explanation of its figuring and lettering.

1. *Flat bastion*: Placed in the middle of a curtain when the lines of defence were too long for musketry range.
2. *Demi-bastion*: Used generally on the bank of a river.
3. *Tenaille bastion*: Used when the flanked angle is too acute; that is, less than 70°.
4. *Redans*: Used along the bank of a river, or when the parapet of the covered way can be taken in reverse from the front.

- A, B. *Ravelins*.
 - C. *Demi-lunes*: So called from the shape of the gorge. They differ from the ravelins in being placed in front of the bastions instead of the curtains.
 - D. *Counter-guards*: Used instead of demi-lunes, which were then going out of fashion.
 - E. *Simple tenaille*.
 - F. *Double tenaille* (see L and M).
- (If the tenaille E is reduced in width towards the gorge, as shown alternatively, it is called a *swallow-tail*. If the double tenaille is

reduced as at G, it is called a *bonnet de prêtre*. Such works were rarely used.)

- H. *Hornwork*: Much used for gates, &c.
- I. *Crown-work*.
- K. *Crowned hornwork*.
- L. M. New forms of *tenaille*: (N.B.—These are the forms which ultimately retained the name.)
- N. New form of work called a *demi-lune lunettée*, the ravelin N being protected by two counter-guards, O.
- P. *Re-entering places of arms*.
- Q. *Traverses*.
- R. *Salient places of arms*.
- S. *Places of arms without traverses*.
- T. *Orillon*, to protect the flank V.
- X. A *double bastion or cavalier*.
- Y. A *retrenchment with a ditch*, of the breach Z.
- &. *Traverses* to protect the terreplein of the ramparts from enfilade.

Turning back now to the middle of the 16th century we find in the early examples of the use of the bastion that there is no attempt made to defend its faces by flanking fire, the curtains being considered the only weak points of the enceinte. Accordingly, the flanks are arranged at right angles to the curtain, and the prolongation of the faces sometimes falls near the middle of it. When it was found that the faces needed protection, the first attempts to give it were made by erecting *cavaliers*, or raised parapets, behind the parapet of the curtain or in the bastions.

The first example of the complete bastioned system is found in Paciotto's citadel of Antwerp, built in 1568 (fig. 21). Here we

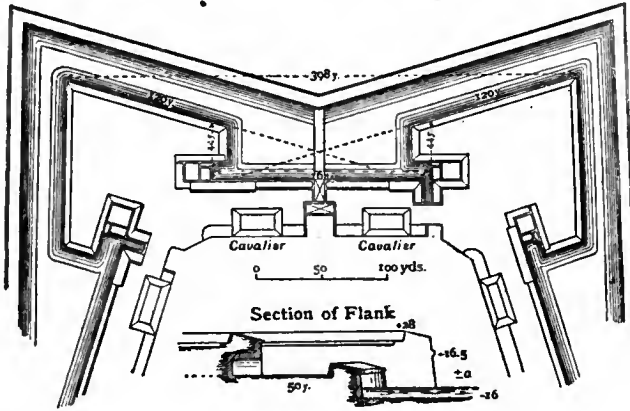

FIG. 21.

have faces, flanks and curtain in due proportion; the faces long enough to contain a powerful battery, and the flanks able to defend both curtain and faces. The weak points of this trace, due to its being arranged on a small pentagon, are that the terreplein or interior space of the bastions is rather cramped, and the salient angles too acute.

In the systems published by Speckle of Strassburg in 1589 we find a distinct advance. Speckle's actual constructions in fortification are of no great importance; but he was a great traveller and observer, and in his work, published just before his death, he has evidently assimilated, and to some extent improved, the best ideas that had been put forward up to that time.

Two specimens from Speckle's work are well worth studying as connecting links between the 16th and 17th centuries.

Fig. 22 is early 16th-century work much improved. There are no outworks, except the covered way, now fully developed, with a battery in the re-entering place of arms. The bastions are large, but the faces directed on the curtain get little protection from the flanks. To make up for this they are flanked by the large cavaliers in the middle of the curtain. The careful arrangement of the flank should be noted; part of it is retired, with two tiers of fire, some of which is arranged to bear on the face of the bastion. The great saliency of the bastion is a weak point, but the whole arrangement is simple and strong.

In the second example, known as Speckle's "reinforced trace" (fig. 23), we find him anticipating the work of the next century. The ravelin is here introduced, and made so large that its faces are in prolongation of those of the bastions. Speckle's other favourite

ideas are here: the cavaliers and double parapets and his own particular invention of the low batteries behind the re-entering place of arms and the gorge of the ravelin. These low batteries did not find favour with other writers, being liable to be too easily destroyed by the besiegers' batteries crowning the salients of the covered way.

Speckle's book is of great importance as embodying the best work of the period. His own ideas are large and simple, but rather in advance of the powers of the artillery of his day.

At the beginning of the 17th century we find the Italian engineers following Paciotto in developing the complete bastioned trace; but they

got on to a bad line of thought in trying to reduce everything to symmetry and system. The era of geometrical fortification (or, as Sir George Clarke has called it, "drawing-board" fortification) had already begun with Marchi, and his followers busied themselves entirely in finding geometrical solutions for the application of symmetrical bastioned fronts to such imaginary forms of perimeter as the oval, club, heart, figure of eight, &c. Marchi, however, was one of the first to think of prolonging the resistance of a place by means of outworks such as the ravelin. De Villenoisy says that Busca was the first to discuss the proportions and functions of

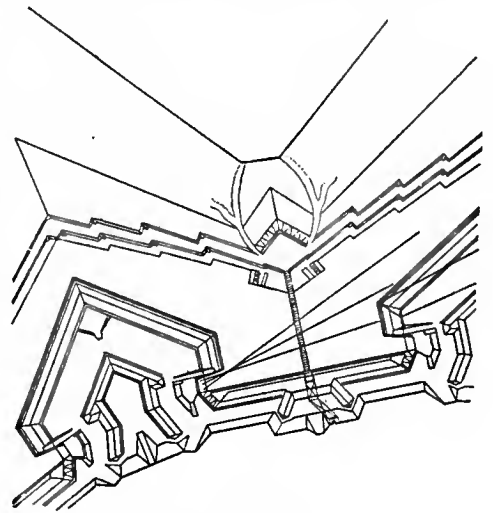

FIG. 22.

The 17th century.

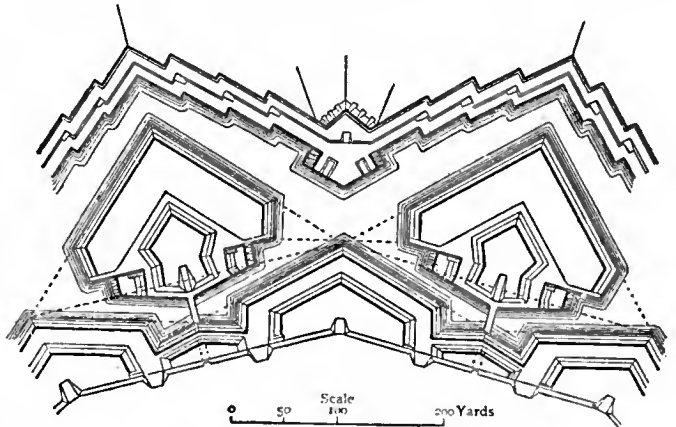

FIG. 23.—Speckle's Reinforced Trace.

all the component parts of a front; and Floriani, about 1630, was the last of the important Italians. The characteristics of a good deal of Spanish fortification carried out at this time were, according to the same authority, that the works were well adapted to sites, and the masonry excellent but too much exposed, while the bastions were too small. The Dutch and German schools will be referred to later.

The French engineers now began to take the lead in adapting the principles already established to actual sites. In the first half of the century the names of de Ville and Pagan stand out as having contributed valuable studies to the advancement of the science. In putting forward their designs they discussed very fully such practical questions as the length of the line of defence, whether this should be governed by the range of artillery or musketry fire, the length of flanks, the use in them of orillons, casemates and retired flanks, the size of bastions, &c.

It is the latter half of the 17th century, however, which is one

of the most important periods in the history of fortification, chiefly because it was illuminated by the work of Vauban. It was at this time also that a prodigious output of purely theoretical fortification began, which went on till the French Revolution. Many of the "systems" published at this time were elaborated by men who had no practical knowledge of the subject, some of them priests who were engaged in educating the sons of the upper classes, and who had to teach the elements of fortification among other things. They naturally wrote treatises, which were valuable for their clearness of style; and with their industry and ingenuity the elaboration of existing methods was a very congenial task. Most of these essays took the form of multiplication and elaboration of outworks on an impossible scale, and they culminated in such fantastic extravagances as the system of Rhana, published in 1769 (fig. 24). These proposals, however, were of no practical importance.

The work of the real masters who knew more than they published can always be recognized by its comparative simplicity. The greatest of these was

Vauban. Sebastien le Prestre de Vauban (*q.v.*). Born in 1633, and busied from his eighteenth year till his death in 1707 in war or preparations for war, he earned alike by his genius, his experience, his industry and his personal character the chief place among modern military engineers. His experience alone puts him in a category apart from others. Of this it is enough to say that he took part in forty-eight sieges, forty of which he directed as chief engineer without a single failure, and repaired or constructed more than 160 places. Vauban's genius was essentially practical, and he was no believer in systems. He would say, "One does not fortify by systems but by common sense." Of new ideas in fortification he introduced practically none, but he improved and modified existing ideas with consummate skill in actual construction. His most original work was in the attack (see below), which he reduced to a scientific method most certain in its results. It is therefore one of the ironies of fate that Vauban should be chiefly known to us by three so-called "systems," known as his "first," "second" and "third." How far he was from following a system is shown by de Villenois, who reproduces twenty-eight fronts constructed by him between 1667 and 1698, no two of which are quite alike and most of which vary very considerably to suit local conditions.

Vauban's "first system," as variously described by other writers even in his own time, is pieced together from some



FIG. 24.

of the early examples of his work. The "second system" is the "tower bastion" defence of Belfort and Landau (1684-1688), obviously suggested by a design of Castriotto's one hundred years earlier; and the "third system" is the front of Neu-Breisach (1698), which is merely Landau slightly improved. In other

works, between 1688 and 1698, he did not keep to the tower bastion idea. It will be convenient to take the "first system," as reproduced in the Royal Military Academy text book of fortification (fig. 25) as typical of much of Vauban's work. It may be observed that he sometimes uses the straight flank, and sometimes the curved flank with orillon. Parapets in several tiers are never used, nor cavaliers. The ravelin is almost always used. It is small, having little artillery power and giving no protection to the shoulders of the bastions. Sometimes it has flanks and occasionally a keep.

The tenaille is very generally found. In this form, viz. as a shield to the escarp of the curtain, it was probably invented by

him. Fig. 25 shows two forms. In both the parapet of the tenaille had to be kept low, so that the flanks might defend a breach at the shoulder of the opposite bastion, with artillery fire striking within 12 ft. of the base of the escarp. Traverses are used for the first time on the covered way to guard against enfilade fire; and the re-entering place of arms, to which Vauban attached considerable importance, is large.

For the construction of the trace an average length of about

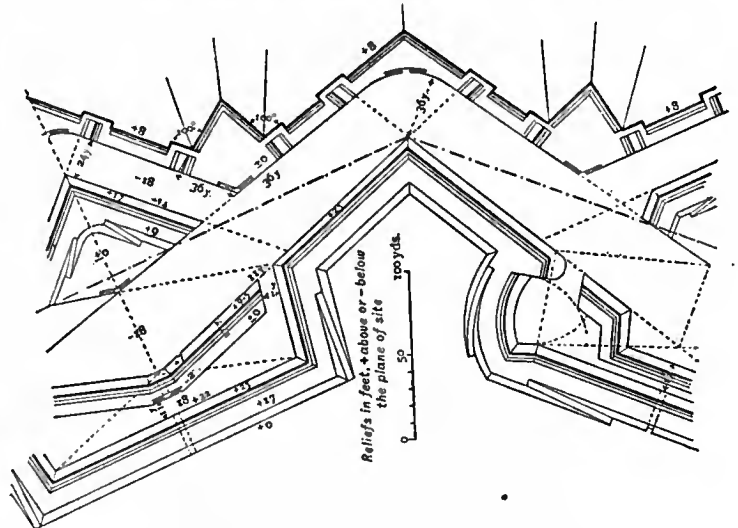

FIG. 25.—Vauban's First System.

400 yds. (which, however, is a matter entirely dependent on the site) may be taken for the exterior side. The perpendicular, except for polygons of less than six sides, is one-sixth, and the faces of the bastions two-sevenths of the exterior side. The flanks are chords of arcs struck from the opposite shoulder as centres. An arc described with the same radius, but with the angle of the flank as a centre, and cutting the perpendicular produced outwardly, gives the salient of the ravelin; the prolongations of the faces of the ravelin fall upon the faces of the bastions at 11 yds. from the shoulders. The main ditch has a width of 38 yds. at the salient of the bastions, and the counterscarp is directed upon the shoulders of the adjoining bastions. The ditch of the ravelin is 24 yds. wide throughout.

As regards the profile the bastions and curtain have a command of 25 ft. over the country, 17 ft. over the crest of the glacis and 8 ft. over the ravelin. The ditches are 18 ft. deep throughout. The parapets are 18 ft. thick with full revetments. In his later works he used demi-revetments.

Fig. 26 shows the tower bastions of Neu-Breisach, or the so-called "third system." It is worth introducing, simply as showing that even a mind like Vauban's could not resist in old age the tendency to duplicate defences. Here the main bastions and tenaille are detached from the enceinte. The line of the enceinte is broken with flanks and further flanked by the towers. The ravelin is large and has a keep. The section through the face of the bastion shows a demi-revetment with wide berm, and a hedge as an additional obstacle.

After Vauban died, though the theories continued, the valuable additions to the system were few. Among his successors in the early part of the 18th century Cormontaigne (*q.v.*) has the greatest reputation, though his experience and authority fell far short of Vauban's. He was a clear thinker and writer, and the elements of the system were distinctly advanced by him. His trace includes an enlarged ravelin with flanks, the ends of which were intended to close the gaps at the end of the tenaille, and a keep to the ravelin with flanks. He provides a very large re-entering place of arms, also with a keep, the ditches of which are carefully traced so as to be protected from enfilade by the salients of the ravelin and bastion. He was also in favour of a permanent retrenchment of the gorge of the bastion. His works were printed, with many alterations, more than twenty years after his death, to serve as a text-book for the school of Mézières. This school was established in 1748, and from this time forward there was an official school of thought, based on Vauban. Cormontaigne's work, therefore, represents the modifications of Vauban's ideas accepted

18th and
19th cen-
turies.

by French engineers in the latter part of the 18th century. The school of Mézières was afterwards replaced by that of Metz, which carried on its traditions. Such schools are necessarily conservative, and hence, in spite of the gradual improvement in ordnance and firearms, we find the main elements of the bastioned system remaining unchanged right up to the period of

put in both to facilitate their defence and to protect portions of the escarps.

Among the unorthodox two names deserve mention. The first of these is Chasseloup-Laubat (*q.v.*), who served throughout the wars of the Republic and Empire, and constructed the fortress of Alessandria in Piedmont.

Chasseloup's main proposals to improve the bastioned system were two:

First, in order to prevent the bastions from being breached through the gaps made by the ditch of the ravelin, he threw forward the ravelin and its keep outside the main glacis. This had the further advantage of giving great saliency to the ravelin for cross-fire over the terrain of the attack. On the other hand, it made the ravelin liable to capture by the gorge. It is probable that this system would have lent itself to a splendid defence by an able commander with a strong force; but under the opposite conditions it has a dangerous element of weakness.

Secondly, in order to get freedom to use longer fronts than those admissible for the ordinary bastioned trace, he proposed to extend his exterior side up to about 650 yds. and to break the faces of his bastions; the portion next the shoulder being defended from the flank of the collateral bastion and coinciding with the line of defence, and the portion next the salient, up to about 80 yds. in length, being defended from a central keep or caponier placed in front of the tenaille. The natural criticism of this arrangement is that it combines some of the defects of both the bastioned and polygonal systems without getting the full advantages of either.

Fig. 28 shows a half front of Chasseloup's system, of ordinary length, as actually constructed. The section shows an interesting

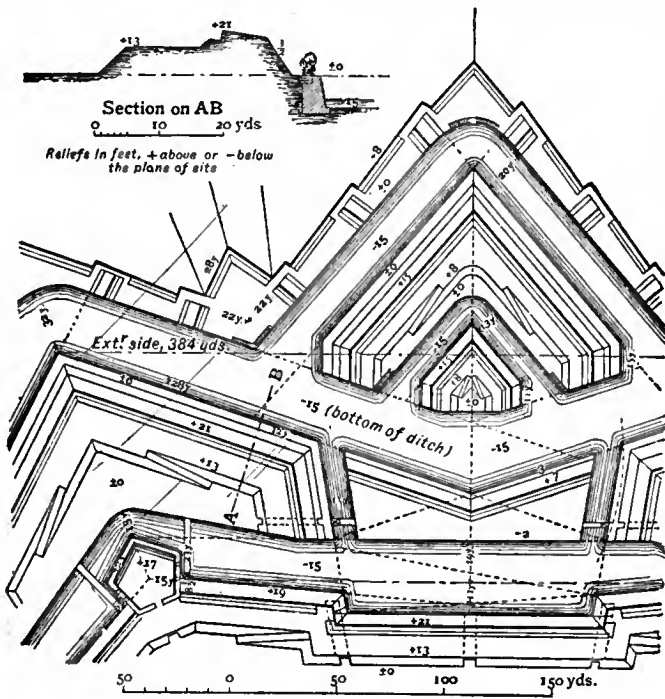

FIG. 26.—Neu-Breisach.

the Franco-German War in 1870. Chasseloup-Laubat tells us that, before the Revolution, to attempt novelties in fortification was to write one's self down ignorant. How far the general form of the bastion with its outworks had become crystallized is evident from a cursory comparison of fig. 27 with Vauban's

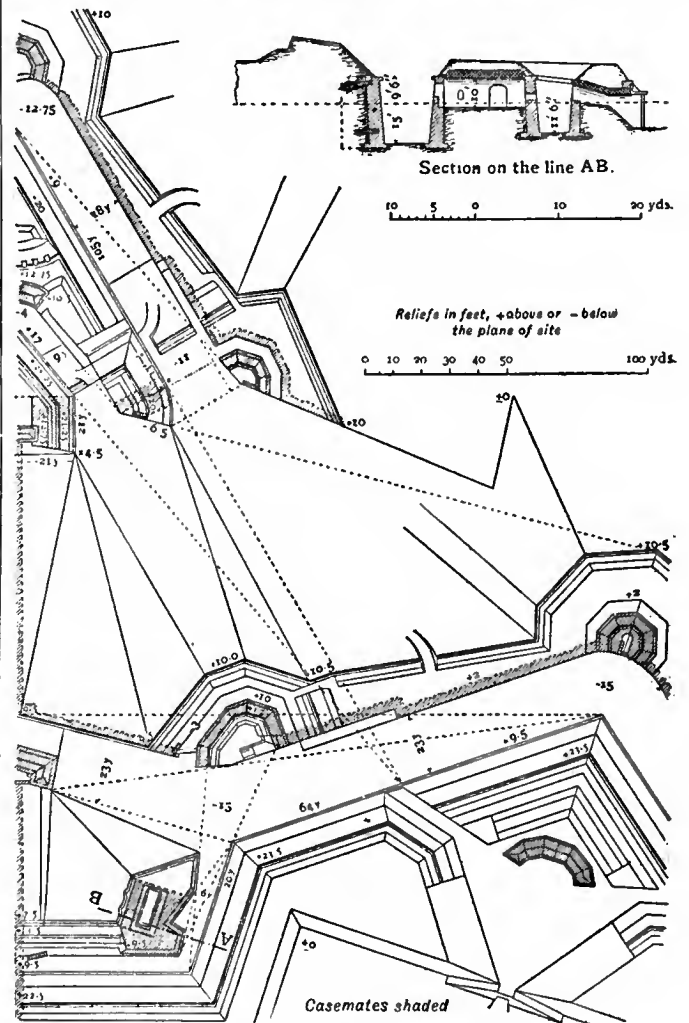

FIG. 28.—Chasseloup-Laubat.

detail, viz. the Chasseloup mask—a detached mask with tunnels for the casemate guns to fire through, the intention of which is to save them from being destroyed from a distance.

The second name is that of Captain Choumara of the French Engineers, born in 1787, whose work was published in 1827.

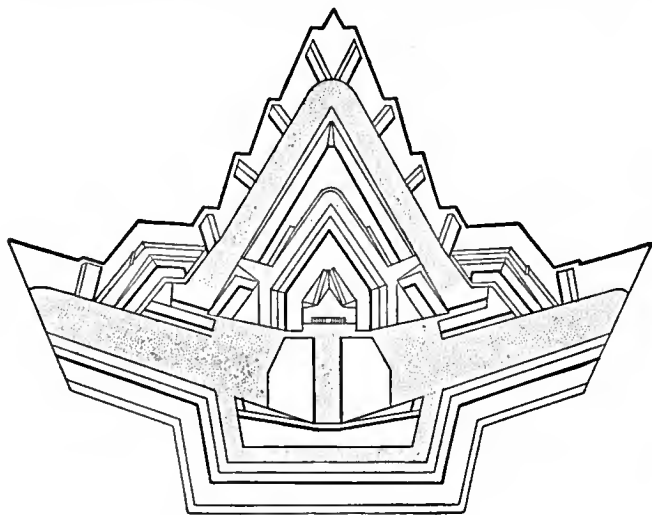

FIG. 27.—Noizet.

early work. This figure is the front of the Metz school in 1822, by General Noizet.

Since, therefore, the official view was that the general outlines of the system were sacred, the efforts of orthodox engineers from Cormontaigne's time onwards were given to improvements of detail, and mainly to retard breaching operations as long as possible. We find enormous pains being bestowed on the study of the comparative heights of the masonry walls and crest levels; with the introduction here and there of glacis slopes in the ditches,

Two leading ideas are due to him. The first is that of the "independence of parapets." A glance at any of the plans that have already been shown will show that hitherto the crests of parapets had always been traced parallel to the escarp or magistral line. Choumara pointed out that, while it was necessary for the escarp to be traced in straight lines with reference to the flanking arrangements, there was no such necessity as regards the parapets. By making the crest of the parapet quite independent of the escarp line he obtained great freedom of direction for his fire. The second idea is that of the "inner glacis." This was a glacis parapet placed in the main ditch to shield the escarp; its effect being to prevent the escarp of the body of the place from being breached in the usual way by batteries crowning the crest of the covered way.

The need for Choumara's improvements has passed by, but he was in his time a real teacher. One sentence of his strikes a resounding note: "What is chiefly required in fortification is simplicity and strength. It is not on a few little contrivances carefully hidden that one can rely for a good defence. *The fate of a place should not depend on the intelligence of a corporal shut up in a small post prepared for his detachment.*"

Before leaving the bastioned system it will be of interest to study a couple of actual and complete examples, one irregular and one regular. Fig. 29 shows the defences of Sedan as they were at the end of the 17th century. One sees the touch of Vauban here and there, but the work is for the most part apparently early 17th century. It will be observed that on the river side of the town the defence consists of very irregular bastions with duplicated wet

a second line only serves to suggest the advisability of retreat. There are also, of course, the recognized drawbacks of outworks, difficulty of retreat, of relief and so forth, and the moral effect of their loss. But the engineers of such defences as Ostend and Candia might well say, "Oh, if only when we had held on to that bastion for so many months we had had a second and a third line of permanent

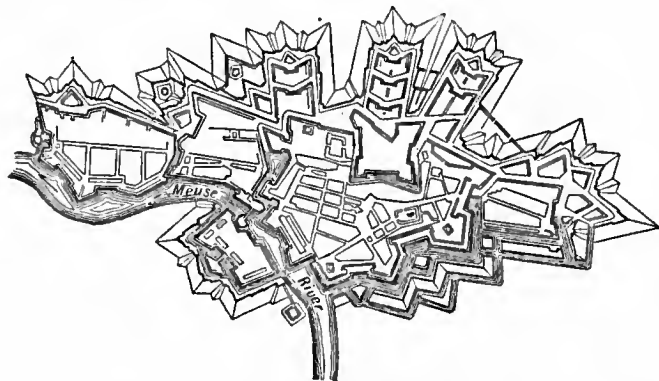

FIG. 29.—Sedan in 1705.

ditches (see the Dutch style, below); and on the other side, where water is not available, strength is sought for by pushing a succession of hornworks far out.

Fig. 30 is Saarlouis, constructed by Vauban in 1680 in his early manner, a remarkable example of symmetry. Vauban of course never thought of aiming at symmetry, which is of itself neither good nor bad, but it is interesting to note such a perfect example of the system.

It must here be remarked that the reproach of "geometrical" fortification is in no way applicable to the works of Vauban and his immediate successors. The true geometric fortification, which worshipped symmetry as a fetish, marked, as has been already pointed out, the decadence of the Italian school. Vauban and his fellows excelled in adapting works to sites, the real test of the engineer.

The bastioned system was the 17th-century solution of the fortification problem. Given an artillery and musketry of short range and too slow for effective frontal defence, a ditch is necessary as an obstacle. What is the best means of flanking the ditch and of protecting the flanking arrangements? If Vauban elected for the bastion, we must before criticizing his choice remember that he was the most experienced engineer of his day, a man of the first ability and quite without prejudice. What is matter for regret is that the authority of Vauban should have practically paralysed the French school during the 18th and most of the 19th century, so that while the conditions of attack and defence were gradually altering they could admit no change of idea, and their best men, who could not help being original, were struggling against the whole weight of official opposition.

Again, such duplication of outworks as we see at Sedan is not geometric fortification. It is a definite attempt to retard the attack, on ground favourable to it, by successive lines of defence. As to the policy of this, no axiom can be laid down. Nowadays most of us think, as Machiavelli did, that a single line of defence is best and that

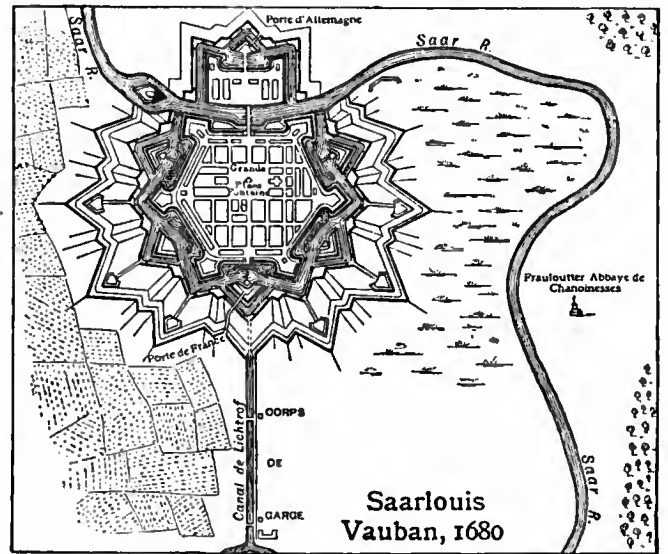

FIG. 30.

retrenchment to fall back upon, we could have held the place for ever." And who shall say that they were wrong? Let us at all events remember that the leading engineers of that time were men who had passed their lives in a state of war, and that we ourselves in comparison with them are the theorists.

From the end of the 16th century the Dutch methods of fortification acquired a great reputation, thanks to the stout resistance offered to the Spaniards by some of their fortresses, the three years' defence of Ostend being perhaps the most striking example. Prolonged defences, which were mainly due to the desperate energy of the besieged, were credited to the quality of their defences. In point of fact the Dutch owed more to nature, and more still to their own spirit, than to art; but they showed a good deal of skill in adapting recent ideas to their needs.

The Dutch school.

Three conditions governed the development of the Dutch works at this time, viz. want of time, want of money and abundance of water. When the Netherlands began their revolt against Spain, they would no doubt have been glad enough of expensive masonry fortresses on such models as Paciotto's citadel of Antwerp. But there was neither time nor money for such works. Something had to be extemporized, and fortunately for them they had wet ditches to take the place of high revetted walls. Everywhere water was near the surface, and rivers or canals were available for inundations. A wide and shallow ditch, while making a good obstacle, was also the readiest means of obtaining earth for the ramparts. High command was, owing to the flatness of the country, unnecessary and even undesirable, as it did not allow of grazing fire.

What the Dutch actually did in strengthening their towns gives little evidence of system. Starting as a rule from an existing enceinte, sometimes a medieval wall, they would provide a broad wet ditch. No further provision was usually made on the sides of the town which were additionally protected by a river or inundation. On the other sides the wet ditch was made still broader, and sometimes contained a counterguard, sometimes ravelins and lunettes. These were quite irregular in their design and relation to each other. At the foot of the glacis would be found another but narrower wet ditch, which was a peculiarly Dutch feature; and sometimes if the town was in a bend of a river there would be a canal cut across the bend in a straight line, strengthened by several redans.

Speaking generally, they endeavoured to provide for the want

of a first-class masonry obstacle by multiplication of wet ditches, and further to strengthen these obstacles by great quantities of palisading, for which purpose the timber of old ships was used. They also recognized the inherent weaknesses of wet ditches, as, for instance, that when frozen they no longer provide an obstacle; and they studied the means, not only of causing inundations, but also of arranging to empty as well as to fill the ditches at will. Simon Stevin was the leader in this work.

Nevertheless a Dutch school of design did come into existence at this time. The leaders, early in the 17th century, were Simon Stevin, Maurice and Henry of Nassau, Marollois and Freitag. The fortress of Coevorden, constructed by Prince Maurice, of which fig. 31 shows a front, is a well-known example of this, and the section shows clearly some typical features of the school.

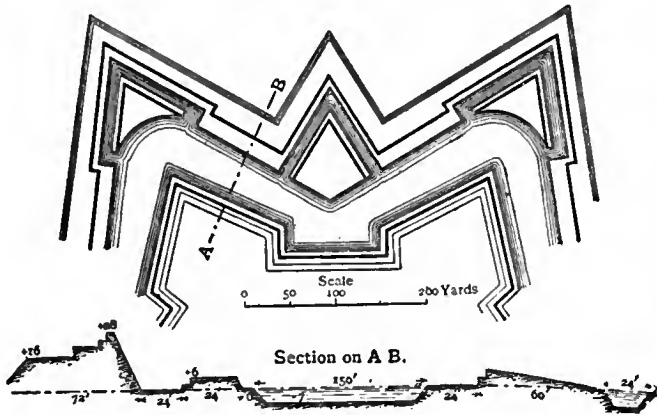

FIG. 31.—Coevorden.

The elements of the plan are those of the early bastioned trace, but we find added both ravelins and lunettes, very regular in design. There is also the ditch at the foot of the glacis, and surrounding the rampart of the enceinte a continuous fausse-braie. This work, which partook of the nature of both boulevard and counterguard, served several purposes. It was desirable that the weight of the rampart should be drawn back a little from the edge of the ditch, and the fausse-braie filled what would otherwise have been dead ground at the foot of the rampart. It also afforded a grazing fire over the ditch, which was very important, and which the rampart supported by a plunging fire.

Coehoorn (*q.v.*), the contemporary and nearest rival to Vauban, was the greatest light of the Dutch school. Like Vauban he was distinguished as a fighting engineer, both in attack and defence; but in the attack he differed from him in relying more on powerful artillery fire than systematic earthworks. He introduced the Coehoorn mortar. His "first system," which was employed at Mannheim (fig. 32), is reproduced for the sake of comparison with the Coevorden front designed a hundred years earlier. Among other points will be

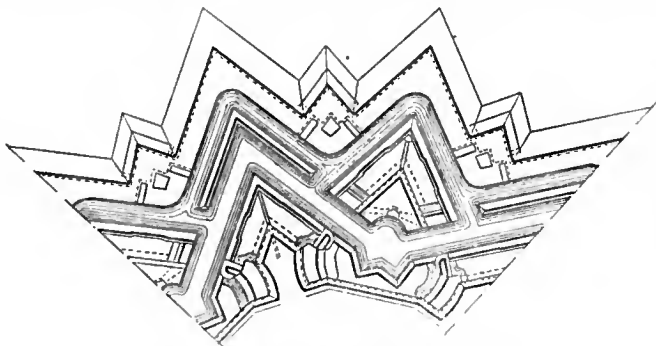

FIG. 32.—Coehoorn's First System.

noticed the combination of wet and dry ditches; the very broad main ditch with counterguard; the roomy keep of the ravelin; the expansion of the fausse-brais into an independent low parapet; and the powerful flanking fire in three tiers.

The "tenaille" system and the "polygonal" system which grew out of it are mainly identified with the *German school*. That school, says von Zastrow, does not, like that of France, represent the authoritative teaching of an official establishment, but rather the general practice of the German engineers. It was founded on the principles of Dürer, Speckle and especially Rimpler, and much influenced in execution by Montalembert. "The German engineers desired a simple trace, a strong fortification with retrenchments and keeps, bomb-proof accommodation and an organization suitable for an offensive defence."

German school.

These had always been the German principles. Already in the 16th century the Prussian defences of Kustrin, Spandau and Peitz had large bomb-proof casemates sufficient for a great part of the garrison. The same thing is seen in the defences of Glogau, Schweidnitz, &c., built by Frederick the Great. These works show various applications of the tenaille system. In 1776 Frederick became acquainted with the work of Montalembert, and his influence is seen in the casemates of Kosel.

Whether through the influence of Albert Dürer or not cannot be said, but while the bastion was being developed in France the tenaille and the accompanying casemates from the first found acceptance in Germany, and thence in eastern and northern Europe. De Groote, who wrote in 1618, produced a sort of tenaille system, and may have been the inspiration of Rimpler. Dillich (1640), Landsberg the elder (1648), Griendel d'Aach (1677), Werthmuller (1685) and others advocated both bastion and tenaille, sometimes in combination; the German bastion being usually distinguished by short faces and long flanks.

Rimpler, who was present at the siege of Candia (taken by the Turks in 1669) and died at that of Vienna in 1683, exercised a great influence. He had been struck by the weakness of the early Italian bastions at Candia, and published a book in 1673 called *Fortification with Central Bastions*, which was practically the polygonal trace. Zastrow thinks that Rimpler inspired Montalembert. He left unfortunately no designs to illustrate his ideas.

Landsberg the younger (1670-1746), a major-general in the Prussian service, who saw many sieges, also had a great influence.

He appears to have been the first who frankly advocated the tenaille alone, chiefly on the ground that the flank, which was the most important part of the bastioned system, was also the weakest. Fig. 33 shows his system, published in 1712.

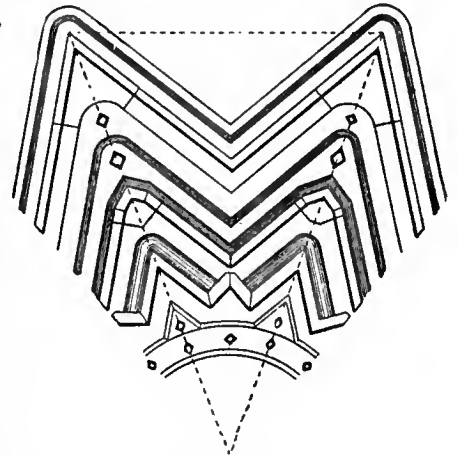

FIG. 33.

It was, however, ultimately a Frenchman, Marc René Montalembert (*q.v.*), who was the great apostle of the tenaille, though in his later years he leaned more to the polygonal trace. He objected to the bastioned trace on many grounds; principally that the bastion was a shell trap, that the flanks by crossing their fire lost the advantage of the full range of their weapons, and that the curtain was useless for defence. He took the view that the bastions with their ravelins constituted practically a tenaille trace, spoilt by the detachment of the ravelins and cramped by the presence of the curtains and flanks. His tenaille system consisted of redans, with salient angles of 60° or more, flanking each other at right angles; from which he gave to his system the name of "perpendicular fortification."

Montalembert and Carnot.

Lazare Carnot (*q.v.*), the "Organizer of Victory," was, in

fortification, a follower of Montalembert, and produced in 1797 a tenaille system (fig. 34) on strong and simple lines.

In 1812 Carnot offered three systems. For a dry and level site he recommended a bastioned trace; but for wet ditches and for irregular ground, tenaille traces. Both of these latter differ from his 1797 trace in that the re-entering angle is reinforced by a tenaille whose faces are parallel to the main faces and reach almost to the salients. There are also counterguards in front of the salients, whose ends overlap the ends of the tenaille. (N.B. To avoid confusion between

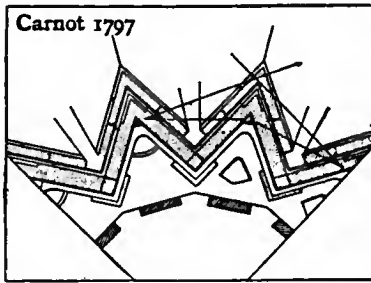

FIG. 34.

the *tenaille trace* and the *tenaille*, it should be noted that the latter is a low detached parapet placed in front of the escarp of the body of the place, partly as a shield, and partly as an additional line of defence. It is used in front of the curtain in the bastioned trace, and in the re-entering angle in the tenaille trace.)

Other important features of Carnot's work were: a continuous general retrenchment, or interior parapet, following more or less the

lines of the main parapet; the use of the detached wall in place of the escarp revetment; and the countersloping glacis. This last (of which Carnot was not the inventor), instead of sloping gently outwards from a crest raised about 8 ft. down to the natural level of the ground, sloped inwards from the ground-level to the bottom of the ditch. The advantage of the additional obstacle of the counterscarp was thus lost to the defence. On the other hand, the besiegers' saps, as they progressed down the glacis, were exposed to a plunging fire from the parapet.

Carnot was also, like Coehoorn, a great believer in the mortar; but while Coehoorn introduced the small portable mortar that bears his name, Carnot expected great results from a 13 in. mortar throwing 600 iron balls at each discharge. He endeavoured to prove mathematically that the discharge of these mortars would in due course kill off the whole of the besieging force.

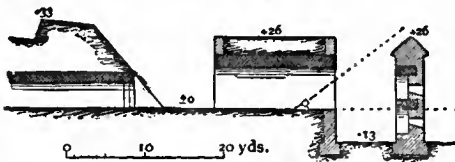

FIG. 35.—Mortar-casemate and Detached Wall.

These mortars he emplaced in open fronted mortar-casemates, in concealed positions. Fig. 35 shows in section one of these mortar-casemates, placed between the parapet of the retrenchment and a detached wall.

The leading idea of Montalembert was that for a successful defence it was necessary for the artillery to be superior to that of the enemy. This idea led him to the adoption of casemates in several tiers; in preference to open parapets, exposed to artillery fire of all kinds, high angle, ricochet and reverse. In considering the defects of bastions he had arrived at the conclusion that for flanking purposes two forms of trace were preferable; either the tenaille form, connecting the ravelins with the body of the place, or the form in which the primary flanking elements, instead of facing each other with overlapping fire, as with the bastions, should be placed back to back in the middle of the exterior side Fig. 36 is an example of this. The central flanking work resulting from this arrangement is

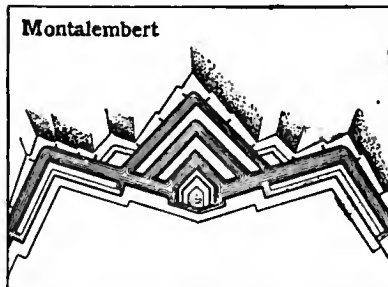

FIG. 36.—Montalembert, 1786.

the caponier of the early Italians, reintroduced and developed; and with it Montalembert laid the foundation of the polygonal system of our own time.

Montalembert was one of the first to foresee the coming necessity for detached forts, and it was for these that he chiefly

proposed to use his caponier flanking, preferring the tenaille system for large places. In abandoning the bastioned trace he was already committed to the principle of casemate defence for ditches; and the combination of this principle with his desire for an overwhelming artillery defence led him in the course of years of controversial writing into somewhat extravagant proposals. For instance, for a square fort of about 400 yds. side, he proposed over 1000 casemate guns; and one of his caponier sections shows 10 tiers of masonry gun-casemates one above the other. Confiding in the power of such an artillery, he freely exposed the upper parts of his casemates to direct fire.

Montalembert is said to have contributed more new ideas to fortification than any other man. His designs must be considered in some ways unworkable and unsound, but all the best work of the 19th century rests on his teaching. The Germans, who already used the tenaille system and made free provision of bomb-proof casemates, took from him the polygonal trace and the idea of the entrenched camp.

The polygonal system in fortification implies straight or slightly broken exterior sides, flanked by casemated caponiers. The caponier is the vital point of the front, and is protected in important works by a ravelin and keep. The essence of the system is its simplicity, which allows of its being applied to any sort of ground, level or broken, and to long or short fronts.

The final period of smooth bore artillery is an important one in the history of fortification. It is true that the many expensive works that were constructed at this time were obsolete almost as soon as they were finished; but this was inevitable, thanks to the pace at which the world was ^{1815-1855,} entrenched camps.

travelling. After the Napoleonic wars the Germanic Confederation began to strengthen its frontiers; and considering that they had not derived much strategic advantage from their existing fortresses, the Germans took up

Montalembert's idea of entrenched camps, utilizing at the same time his polygonal system with modifications for the main enceintes. The Prussians began with the fortresses of Coblenz and Cologne; later Posen, Königsberg and other places were treated on the same lines. The Austrians constructed, among other places, Linz and Verona. The Germanic Confederation reinforced Mainz with improved works, and re-organized entirely Rastatt and Ulm. The

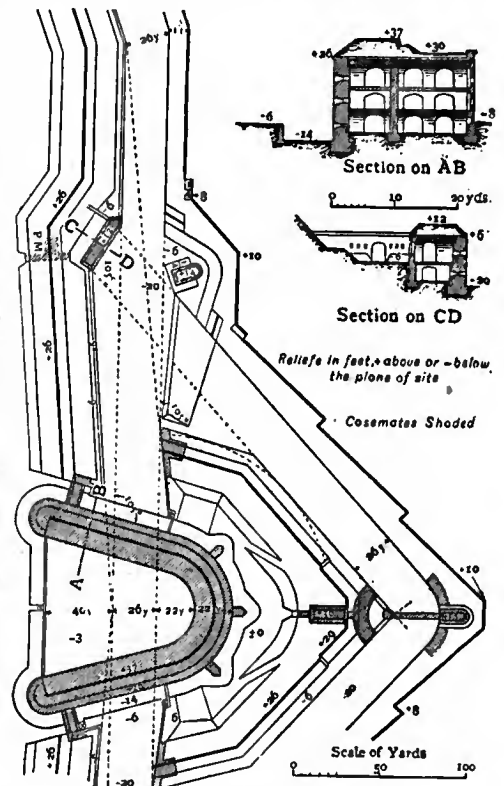

FIG. 37.—Front at Posen.

Bavarians built Gernersheim and Ingolstadt. While all these works were conceived in the spirit of Rimpler and Montalembert, they showed the differences of national temperament. The Prussian works, simple in design, relied upon powerful artillery fire, and exposed a good deal of masonry to the enemy's view. The Austrians covered part of their masonry with earth and gave more attention to detail.

The German development of the polygonal system at this time is not of great importance, since the great masonry caponiers were designed without sufficient consideration for the increasing powers of artillery. One example (fig. 37) is given for the sake of historical comparison. It is a front of Posen.

"The exterior side of the front is about 650 yds. (600 metres) long. It is flanked by a central caponier, which is protected by a *detached bastion*. . . . The main front is broken back to flank the faces of the bastion from casemates behind the escarp, as well as from the parapet.

"The central caponier forms the keep of the whole front and sweeps both the interior and the ditch by its flanking fire. It has two floors of gun-casemates and one for musketry, and on the top is a parapet completely commanding alike the outworks and the body of the place. It contains barrack accommodation for a battalion of 1000 men, and has a large inner courtyard closed at the gorge by a detached wall. The caponier is itself flanked by three small caponiers at the head, and one at the inner end of each flank.

"The escarp of the body of the place is a simple detached wall; that of the detached bastion is either a detached wall with piers and arches, or a counter-arched revetment. At the salient of the bastion there is a mortar battery under the rampart, and a casemated traverse for howitzers upon the terreplein. The flanks of the bastion are parallel to those of the caponier, and at the same distance from it as the faces.

"Masonry blockhouses, loopholed for musketry, are provided as keeps of the re-entering and salient places of arms. In the latter case they have stairs leading down into a counterscarp gallery, which serves as a base for countermine galleries, and is connected with the detached bastion by a gallery under the ditch. The counterscarp is not revetted if the ditch is wet.

"The angle of the polygon should not be less than 160°, in order that the prolongation of the main ditch may fall within the salients of the detached bastions of the neighbouring fronts, and the masonry of the caponiers may thus be hidden from outside view." (R.M.A. *Text-book of F. & M.E.*, 1886.)

We have now reached a period when the "detached fort" becomes of more importance than the organization of the enceinte.

The early conception of the rôle of detached forts in connexion with the fortress was to form an entrenched camp within which an army corps could seek safety if necessary. The idea had occurred to Vauban, who added to the permanent defences of Toulon a large camp defended by field parapets attached to one side of the fortress. The substitution of a ring of detached forts, while giving it the greater safety of permanent instead of field defences, gave also a wider area and freer scope for the operations of an army seeking shelter under the guns of a fortress, and at the same time made siege more difficult by increasing the line of investment. The use of the detached fort as a means of protecting the body of the place from bombardment had not yet been made necessary by increased range of artillery.

When these detached forts were first used by Germany the scope of the idea had evidently not been realised, as they were placed much too close to the fortress. Those at Cologne, for instance, were only some 400 or 500 yds. in advance of the ramparts. The same leading idea is seen in most of these forts as in the new enceintes; *i.e.* a lunette, with a casemated keep at the gorge. The keep is the essential part of the work, the rampart of the lunette serving to protect it from frontal artillery fire. The keep projects to the rear, so as not only to be able to flank its own gorge, but to give some support to the neighbouring works with guns protected from frontal fire. This is a valuable arrangement, which is still sometimes used. The front ditches of the lunettes were flanked by caponiers. Some of the larger forts were simple quadrangular works with casemate barracks and caponier ditch defence.

In 1830, in Austria, the archduke Maximilian made an entirely fresh departure with the defences of Linz. The idea was to provide an entrenched camp at the least possible cost, whose works should require the smallest possible garrison. With this object Linz was surrounded with a belt of circular towers spaced about 600 yds. apart. The towers, 25 metres in diameter, were enclosed by a ditch and glacis, and contained 3 tiers of casemates. The masonry was concealed from view by the ditch and glacis. On the top of the tower was an earth parapet, over which a battery of 13 guns fired *en barbette*. In order to find room for

so many guns in the restricted space, the whole 13 were placed parallel and close together on a single specially designed mounting.

This new departure was received with a certain amount of approval at the time, which is somewhat difficult to account for, as a more faulty system could hardly be devised; but the experiment was never repeated.

The credit for much of the clear views and real progress made in Germany during this period is due to General von Brese-Winiari, inspector-general of the Prussian engineers.

France, for a few years after 1815, could spare little money for fortifications, and nothing was done but repairs and minor improvements on the old lines. Belgium, having some money in hand, rebuilt and improved in detail a number of bastioned fortresses which had fallen into disrepair.

In 1830 France began to follow the lead of Germany with entrenched camps. The enceinte of Paris was reconstructed, and detached forts were added at a cost, according to von Zastrow, of £8,000,000. The Belgian and German frontiers

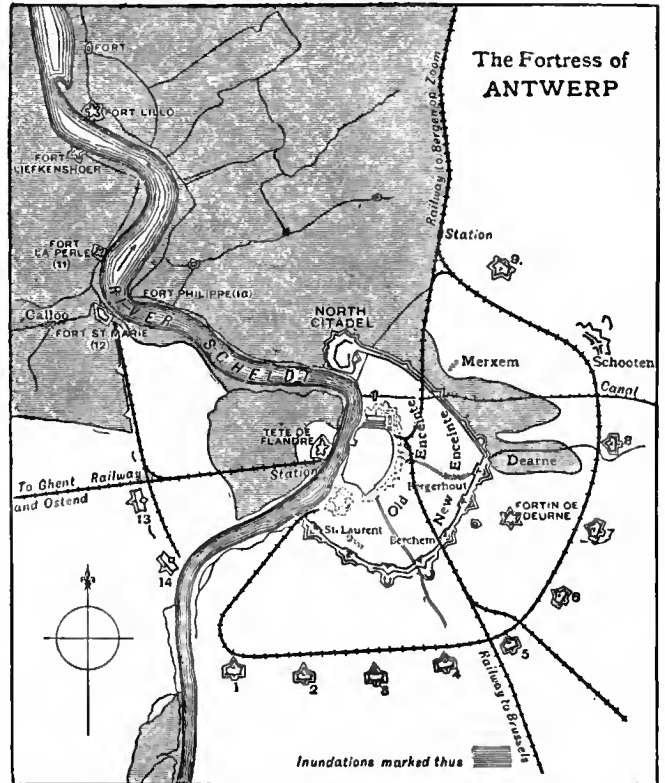

FIG. 38.

of France being considered fairly protected by the existing fortresses, they turned their attention to the Swiss and Italian frontiers, and constructed three fortresses with detached forts at Belfort, Besançon and Grenoble. The cost of the new works at Lyons was, according to the same writer, £1,000,000 without the armament. Here and elsewhere the enceinte was simplified on account of the advanced defences. That of Paris, which was influenced by political considerations, was a simple bastioned trace with rather long fronts and without ravelins or other outworks; the escarp was high and therefore exposed, and the counterscarp was not revetted.

As regards the detached forts there was certainly a want of clearness of conception. Those of Paris were simply fortresses in miniature, square or pentagonal figures with bastioned fronts and containing defensible barracks. Those of Lyons were much more carefully designed, but the authors wavered between two ideas. Unwilling to give up the bastion, but evidently hankering after the new caponiers, they produced a type which it is difficult to praise. The larger works were irregular four- or five-sided figures with bastioned fronts; and practically the whole interior space was taken up by a large keep, with its ditch, on the

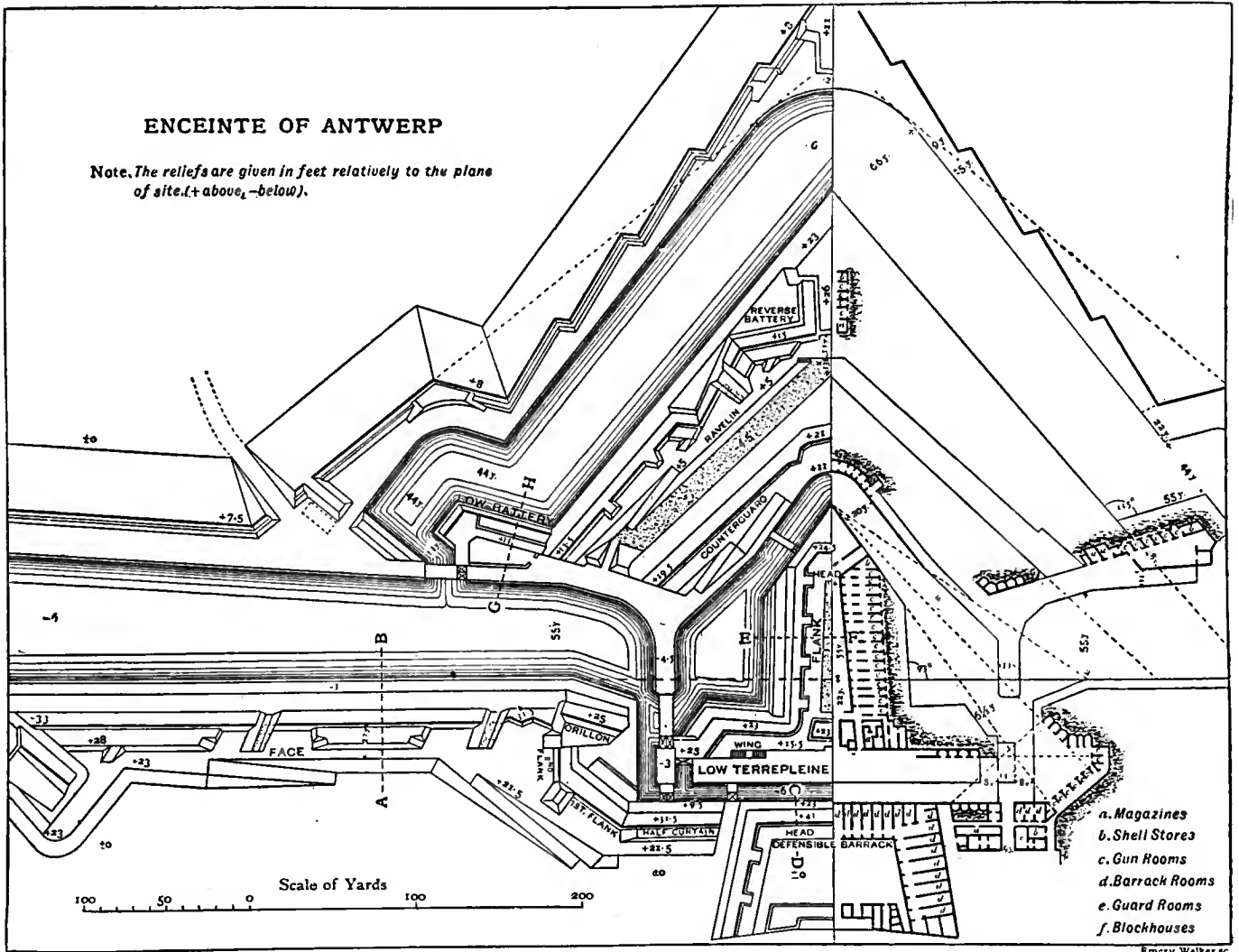

FIG. 39.

polygonal system. The smaller works, instead of a keep, had defensible barracks in the gorge.

During the period 1855-1870 a considerable impulse was given to the science of fortification, both by the Crimean War and the arrival of the rifled gun. One immediate result of these was the condemnation of masonry exposed to artillery fire. The most important work of the period was the new scheme of defence of Antwerp, initiated in 1859.

This is chiefly interesting as giving us the last and finest expression of the medieval enceinte, at a time when the war between the polygonal and bastioned traces was still raging, though the boom of the long-range guns had already given warning that a new era had begun. Antwerp is also associated with the name of General Brialmont (*q.v.*), of the Belgian engineers, whom posterity will no doubt regard as the greatest writer on fortification of the latter half of the 19th century.

We give in figs. 38, 39 and 40 the general plan of the 1859 defences of Antwerp, the plan of a front of the enceinte, and its sections, as showing almost the last word of fortification before the arrival of high explosives.

The defences of Antwerp were designed, as the strategic centre of the national defence of Belgium, for an entrenched camp for 100,000 men. The length of the enceinte is about 9 m. The detached forts, which on the sides not defended by inundation are about 1½ m. apart and from 2 to 3 m. in front of the enceinte, are powerful works, arranged for a garrison of 1000 men. They have each a frontal crest-line of over 700 yds. and are intended for an armament of 120 guns and 15 mortars.

The general arrangement of the fronts of the enceinte should be compared with the earlier German type of Posen. It will be noticed that while the large casemated caponier at Posen breaks the enceinte and flanks it both without and within, at Antwerp the caponier is detached—a much sounder arrangement—and flanks the front only. The defence of the faces rests on the width of the wet ditches and on the flanking power of the caponier; there is no attempt to add to it by faussc-braié or detached wall. The dimensions are everywhere very generous, allowing free movement for the troops of the defence; the covered way is 22 yds.

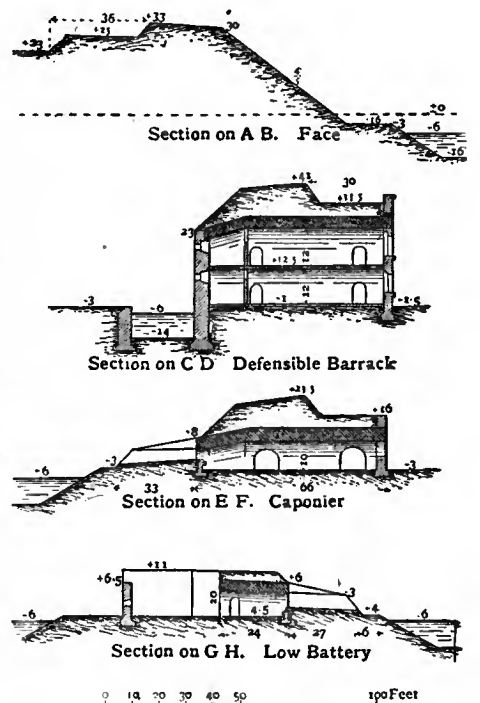

FIG. 40.—Sections of fig. 39.

wide and there is a double terreplein on the face. The parapet of the face is 27 ft. thick. The masonry of the casemate guns in the caponier, first flank and low battery, is protected by earth, *à la Haxo*.

In 1859 Austria acknowledged the influence of the new artillery with some new forts at Verona. The detached forts built by Radetzky in 1848 were only from 1000 to 2000 yds. distant from the ramparts. Those now added, of which fig. 41 is an example, were from 3000 to 4000 yds. out.

In the same year the land defences of some of the British dockyards were taken in hand. These first serious attempts at

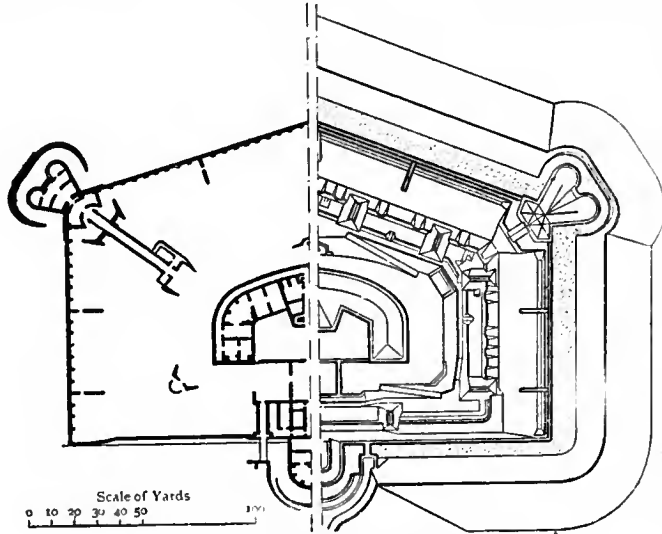

FIG. 41.—Austrian Fort at Verona.

permanent fortification in England were received with approval on the continent, as constituting an advance on anything that had been done before. The detached forts intended to keep an enemy outside bombarding distance were roomy works with small keeps. The parapets were organized for artillery and the ditches were defended by caponiers or counterscarp galleries. The forts were spaced about a mile apart and arranged so as to support each other by their fire.

The sieges of the Franco-German War of 1870 are alluded to in the section below dealing with the "Attack of Fortresses."

As regards their effect on the designs of fortification the most important thing to note is the distance to which it was thought necessary to throw out the detached forts. These distances were of course influenced by the character of the ground, but for the most part they were very largely increased. Thus at Paris the fort at St Cyr was 18,000 yds. from the enceinte; at Verdun the distances varied from 2300 to 12,000 yds.; at Belfort the new forts were from 4500 to 11,500 yds. out; at Metz 2300 to 4500; and at Strassburg 5200 to 10,000. One result of these increased distances was of course to increase very largely the length of the zone of investment, and therefore the strength necessary for the besieging force.

As regards the character of the works, the typical shape adopted both in France and Germany was a very obtuse-angled lunette, shallow from front to rear. The German type had one parapet only, which was organized for artillery and heavily traversed, the living casemates being under this parapet. The ditch defence was provided for by caponiers and a detached wall (see fig. 42).

The French forts had two parapets, that in the rear being placed over living casemates (in two tiers, as shown in the section of fig. 43 by a dotted line), and commanding the front one. There was a long controversy as to whether the artillery of the fort should be on the upper or the lower parapet, the advocates of the upper parapet attaching great importance to the command that the guns would have over the country in front. The other school, objecting to having guns on the skyline, preferred to

sacrifice the command and place them on the lower parapet, as in fig. 43, the infantry occupying the upper parapet. It will be observed that the bastioned trace is abandoned, the ditches, like those of the German fort, being defended by caponiers.

While a great deal of work was done on these lines, a very active controversy had already begun on the general question as to whether guns should be employed in forts at all. Some

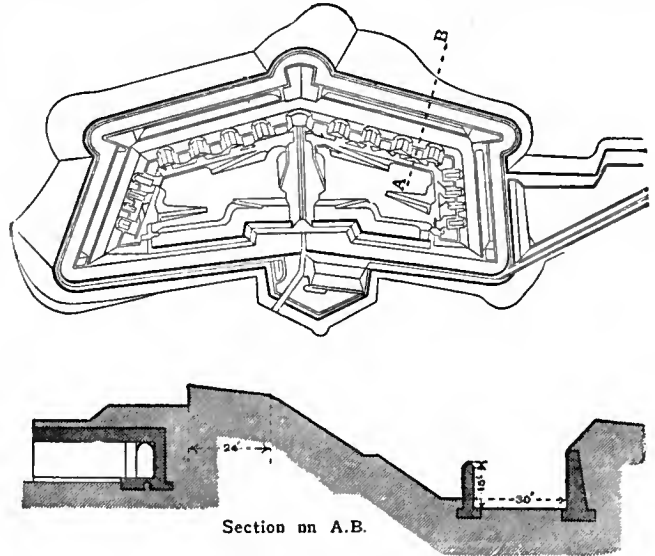

FIG. 42.—German Fort about 1880.

declared that the accuracy and power of artillery had already developed so far, that guns in fixed and visible positions must needs be put out of action in a very short time. The remedy proposed by these was the removal of the guns from the forts into "wing-batteries" which should be less conspicuous; but soon the broader idea was put forward of placing the guns in concealed positions and moving them from one to another by means of

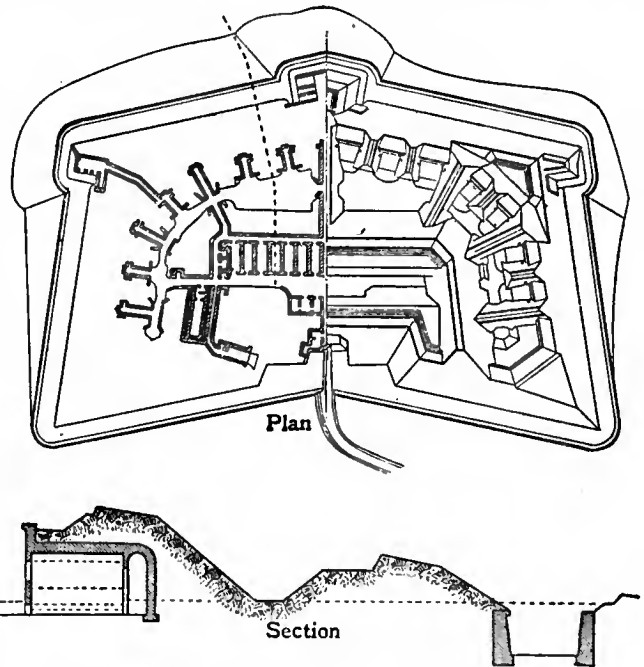

FIG. 43.—French Fort about 1880.

previously prepared roads or railways. Others declared that there was no safety for the guns outside the forts, and that the use of steel turrets and disappearing cupolas was the only solution of the difficulty. General Brialmont, who had by this time become the first European authority on fortification questions, ranged himself on the side of the turrets. The younger

school were largely in favour of mobility and expressed themselves eagerly in a shower of pamphlets.

It was at this juncture that a new factor was introduced, namely, the obus-torpille, or long shell with high-explosive bursting charge. With its appearance we say good-bye to the old school and enter upon the consideration of the fortification of to-day.

II. MODERN PERMANENT FORTIFICATION

Modern fortification dates by universal consent from 1885. The Germans had begun experiments a year or two before this, with long shell containing large charges of gun-cotton. But it was the experiments at Fort Malmaison in France in 1886 that set the military world speculating on the future of fortification. The fort was used as a target for 8-in. shell of five calibres length containing large charges of melinite. The reported effects of these made a tremendous sensation, and it was thought at first that the days of permanent fortification were over. Magazine casemates were destroyed by a single shell, and revetment walls were overturned and practicable breaches made by two or three shells falling behind them. It must be remembered, however, that the works were not adapted to meet this kind of fire. The casemates had enough earth over them to tamp the shell thoroughly, but not enough to prevent it from coming into contact with the

masonry, and the latter was not thick enough to resist the explosion of the big charges. Other experiments were made in the same direction in Germany, Holland, Belgium and Austria. The Germans used shell containing from 60 to 130 lb of high explosive.

After the first alarm had subsided foreign engineers set about adapting their works to meet the new projectiles. Revetments were enormously strengthened, and designed so that their weight resisted overturning. Concrete roofs were made from 6 to 10 ft. thick, and in many cases the surface of the concrete was left bare so as to expose a hard surface to the shell without any earth tamping. The idea of cupolas and shielded guns gained ground, and is now practically accepted all over the continent of Europe. In many cases the main armament, in some only the safety armament (see below), is in cupolas in the forts.

But meanwhile Europe had been flooded with literature on the subject, and the whole policy of fortification as well as its minutest details were discussed *ab ovo*. The extremists of both sides revelled in their opportunity. Some declared that, with the use of heavy guns and armour, fortresses could be made stronger than ever. Others held that modern fortresses were far too expensive, that their use led to strategic mistakes, and (arguing from certain well-known examples) that extemporized field defences could offer as good a resistance as permanent works.

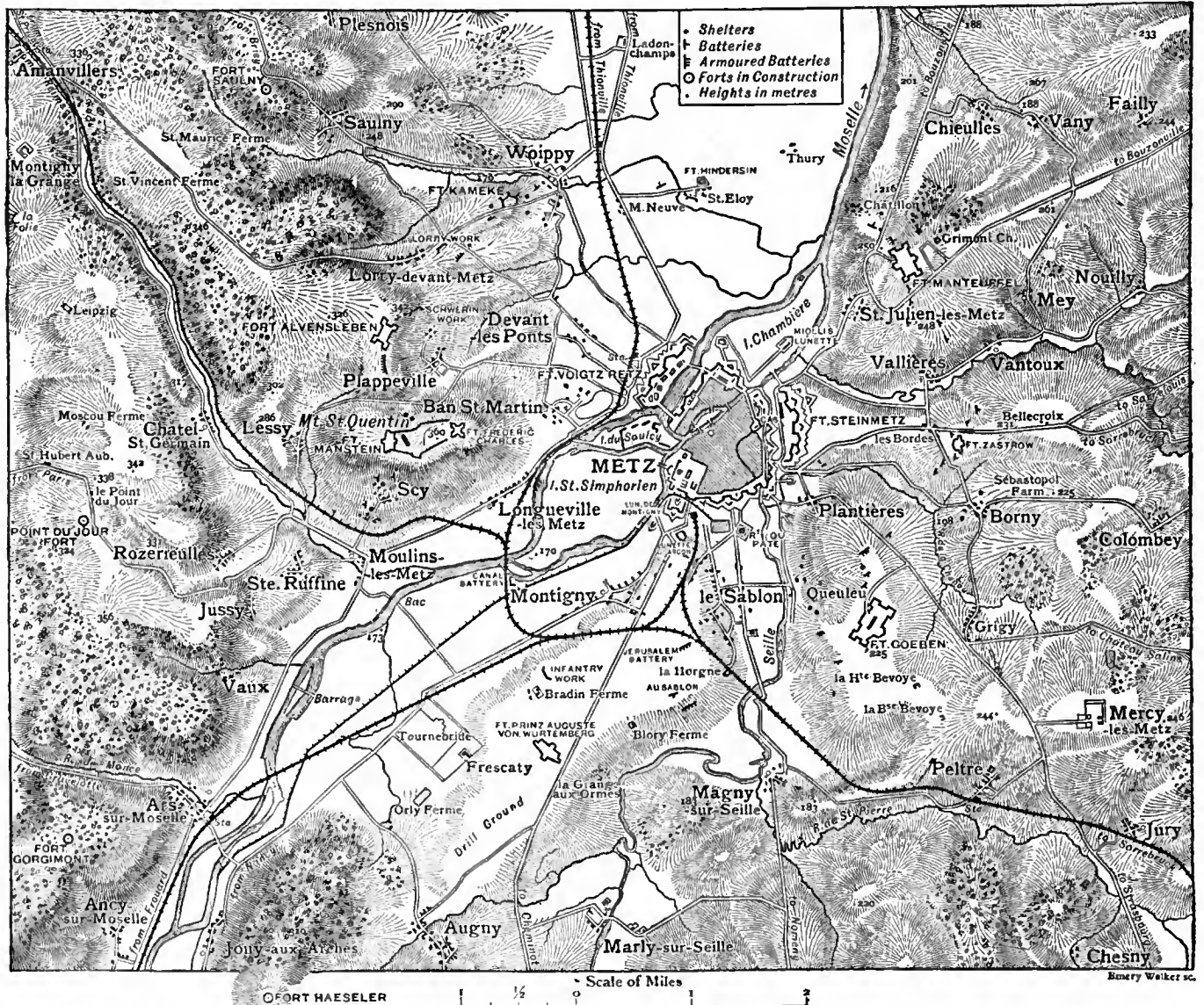

From Plessix and Legrand's *Manuel complet de la fortification*, by permission.

FIG. 44.—Metz in 1899.

European military opinion generally is now more or less agreed on the following lines:—

1. Important places must be defended by fortresses.
2. Their girdle of forts must be far enough out to prevent the bombardment of the place.
3. An enceinte is desirable, but need not be elaborate.
4. A few guns (called "safety armament") should be in the forts, and these must be protected by armour.
5. The bulk of the artillery of the defence should be outside the forts; the direct-fire guns preferably in cupolas, the howitzers in concealed positions.
6. The forts should be connected by lines of entrenched infantry positions and obstacles, permanent bomb-proof shelters being provided for the infantry.
7. There should be ample communications—radial and peripheral—between the place and the forts, both by road and rail.
8. Special lines of communication—such as mountain passes—should be closed by barrier forts.

These considerations will now be taken somewhat more in detail, but first it will be useful to deal with the plan of Metz in 1899 (fig. 44).

Here the fortifications of successive periods can be readily recognized. First the old enceinte, unaltered by the Germans and now *déclassée*. Next the detached forts, begun by the French engineers in 1868 and still unfinished in 1870, can be readily recognized by their bastioned trace. Among them are Fort Manteuffel, formerly St Julien, and Fort Goeben (fig. 45), formerly Queuleu. These were not altered in their general lines.

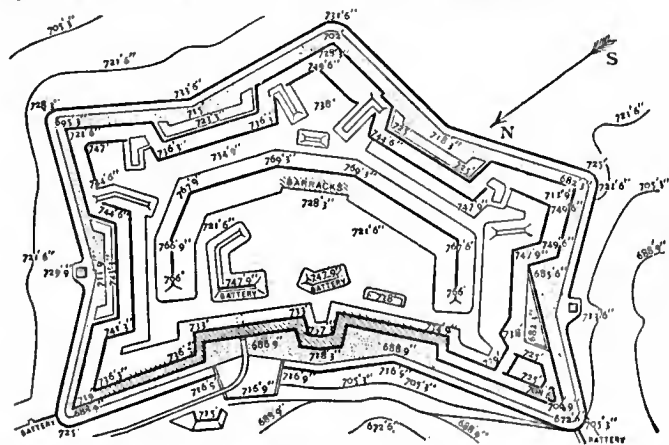

From Plessix and Legrand's *Manuel complet de la fortification*, by permission.

FIG. 45.—Fort Goeben, Metz.

This early line of detached forts, less than 3000 yds. from the enceinte, was completed by the Germans with forts of polygonal type such as Fort Prinz August. The hill of St Quentin (fig. 46), a very important point, was converted into a fortified position, with two forts and connecting parapets, and a communication running north to Fort Alvensleben.

The arrangement of wing batteries in connexion with the forts can be clearly noted at Fort Manteuffel. These are reinforced by other batteries either for the defence of the intervals or to dominate important lines of approach such as the valley of the Moselle (canal battery at Montigny). To these were added later armoured batteries.

There are also infantry positions, shelters and magazines in connexion with this line.

Finally some new forts of modern type were commenced in 1899 at about 9000 yds. from the place.

Leaving out of consideration at present the strategic use of groups of fortresses, the places which, as mentioned above, are intrinsically worth being defended as fortresses are:—

- (a) Centres of national, industrial or military resources.
- (b) Places which may serve as *points d'appui* for manoeuvres.
- (c) Points of intersection of important railroads.
- (d) Bridges over considerable rivers.
- (e) Certain lines of communication across a frontier.

Examples of (a) are Paris, Antwerp, Lyons, Verdun. Again for (a) and (b), as is pointed out by Plessix and Legrand, Metz in the hands of the Germans may serve both as a base of supplies and a *point d'appui* for one flank. Strassburg is a bridge-head giving the Germans a secure retreat across the Rhine if beaten in the plains of Alsace, and an opportunity of resuming the offensive when they have re-formed behind the river.

The distance of detached forts from the place depends on the range of the siege artillery and the distance at which it can usually be established from the forts, and is variously given by different continental writers at from 4 to 9 km. (4500 to 10,000 yds.). The bombarding range of siege howitzers with heavy shells is considered to be about 8000 yds., and if it is possible for them to be emplaced within say 2000 yds. of the forts, this would give a minimum distance of 6000 yds. from the forts to the body of the place. Some writers extend the minimum distance to 7 km., or nearly 8000 yds. In practice, however, it must happen that the position of the forts is determined to a very large extent by the lie of the ground. Thus some good positions for forts may be found within 4000 or

The ring of detached forts.

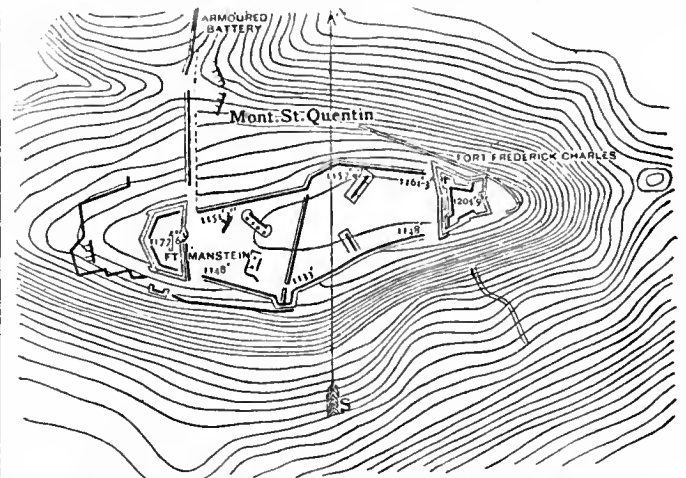

From Plessix and Legrand's *Manuel complet de la fortification*, by permission.

FIG. 46.—St Quentin position, Metz.

5000 yds. of the place, and no others suitable on the same front within 15,000 yds. In that case the question of expense might necessitate choosing the nearer positions. Some examples of the actual distances of existing forts have already been given. Others, more recent, are, at Bucharest 7-10 km., Lyons 8-10½, Copenhagen 7-8 and Paris 14-17. *Strategic pivots* are in a different category from other fortresses. While not necessarily protected from bombardment, they may yet have one or two forts thrown out from 9 to 12 km., to get advantage of ground. Such are Langres, Epinal and Belfort.

The Enceinte.—The desirability of this is almost universally allowed; but often it is more as a concession to tradition than for any solid reason. The idea is that behind the line of forts, which is the main defensive position, any favourable points that exist should be provisionally fortified to assist in a "step-by-step" defence; and behind these again the body of the place should be surrounded by a last line of defence, so that the garrison may resist to the last moment. It may be remarked that apart from the additional expense of an enceinte, such a position would not, under modern conditions, be the most favourable for the last stages of a defence. Again, there is the difficulty that it is practically impossible to shut in a large modern town by a continuous enceinte. It has been proposed to construct the enceinte in sections in front of the salient portions of the place. This system of course abandons several of the chief advantages claimed for an enceinte.

In actual practice enceintes have been constructed since 1870 in France and other countries, consisting of a simple wall 10 or 12 ft. high with a banquette and loopholes at intervals. This of course can only be looked upon as a measure of police. For war purposes, in face of modern artillery, it is a *reductio ad absurdum*.

The Safety Armament.—If the bulk of the artillery is to be placed in positions prepared on the outbreak of war, it is considered very necessary that a few heavy long-range guns should be permanently in position ready at any moment to keep an enemy at a distance, forcing him to open his first batteries at long range and checking the advance of his investment line. Such guns would naturally be in secure positions inside the forts, and if they are to be worked from such positions they must have armour to shield them from the concentrated fire of the numerous field artillery that a besieger could bring to bear from the first.

Artillery outside the forts constitutes the most important part of the defence, and there is room for much discussion as to whether it should have positions prepared for it beforehand

or should be placed in positions selected as the attack develops itself. On the one hand the preparation of the positions beforehand, which in many cases means the use of armour and concrete, increases very largely the initial expense of the defence, and ties the defender somewhat in the special dispositions that become desirable once the attack has taken shape. Moreover, such expenditure must be incurred on all the fronts of the fortress, whereas the results would only be realized on the front or fronts actually attacked. On the other hand much time and labour are involved in emplacing heavy and medium artillery with extemporized protection, and this becomes a serious consideration when one remembers how much work of all kinds is necessary in preparing a fortress against attack. Again, to avoid the danger of a successful attack on the intervals between the forts before their defences have been fully completed, the fire of the guns in the intermediate positions might be urgently required. The solution in any given case would no doubt depend on the importance of the place. In most cases a certain amount of compromise will come in, some preparation being made for batteries, without their being completed. Armoured batteries of whatever kind must in any case be prepared in peace time. It should not be overlooked that as, whatever theories may exist about successive lines of defence, the onus of the defence will now lie on the fort line, just as it formerly did on the enceintes, so that line should be fully prepared, and should not have to commence its fight in a position of inequality.

Defence of Intervals of Forts.—The frontal fire of the batteries in the intervals and the flanking fire of some of the guns in the forts will play an important part, but the main reliance should be on infantry defence. A fully prepared fortress would have practically a complete chain of infantry fighting positions and obstacles between the forts, at all events on the fronts likely to be seriously attacked. The positions would consist largely of fire trenches, with good communications; but it is pretty generally recognized that there

must be some *points d'appui* in the shape of redoubts or infantry forts, and also bomb-proof shelter for men, ammunition and stores near the fighting line. This is usually included in the redoubts. If they are to resist the heaviest shell, such shelters must be built in peace time.

Communications are of the first importance, not merely to facilitate the movement of the enormous stores of ammunition and materials required in the fighting line, but also that defenders may fully utilize the advantage of acting on interior lines. They should include both railways and roads running from the centre of the place to the different sectors of defence, and all round, in rear of the line of forts; also ample covered approaches to the fighting line. Concealment is essential, and where the lie of the ground does not help, it must be got from earth parapets or plantations.

The principal use of barrier forts is in country where the necessary line of communication cannot be easily diverted. For instance, in a comparatively flat country a barrier fort commanding a road or railway is of little use because roads may be found passing round it, or a line of railway may be diverted for some miles to avoid it. But in mountainous country, where such diversion is impossible, it will be necessary for the enemy to capture the fort before he can advance; and the impossibility of surrounding it, the few positions from which siege artillery can be brought into play, and the fact that there is practically only one road of approach to be denied, make these positions peculiarly suitable for forts with armoured batteries. Italy makes considerable use of such forts for the defence of frontier passes.

Barrier forts.

General Brialmont's Theoretical Claim for the Defence of a Country.—Before going into details, it is worth while to state the full claim of strategic fortification advanced by General Brialmont, the most thorough of all its advocates. It is as follows:—

- A. Fortify the capital.
- B. Fortify the points where main lines of communication pass a strategic barrier.
- C. Make an entrenched camp at the most important centre of communication in each zone of invasion: and support it by one or two places arranged so as to make a fortified district.

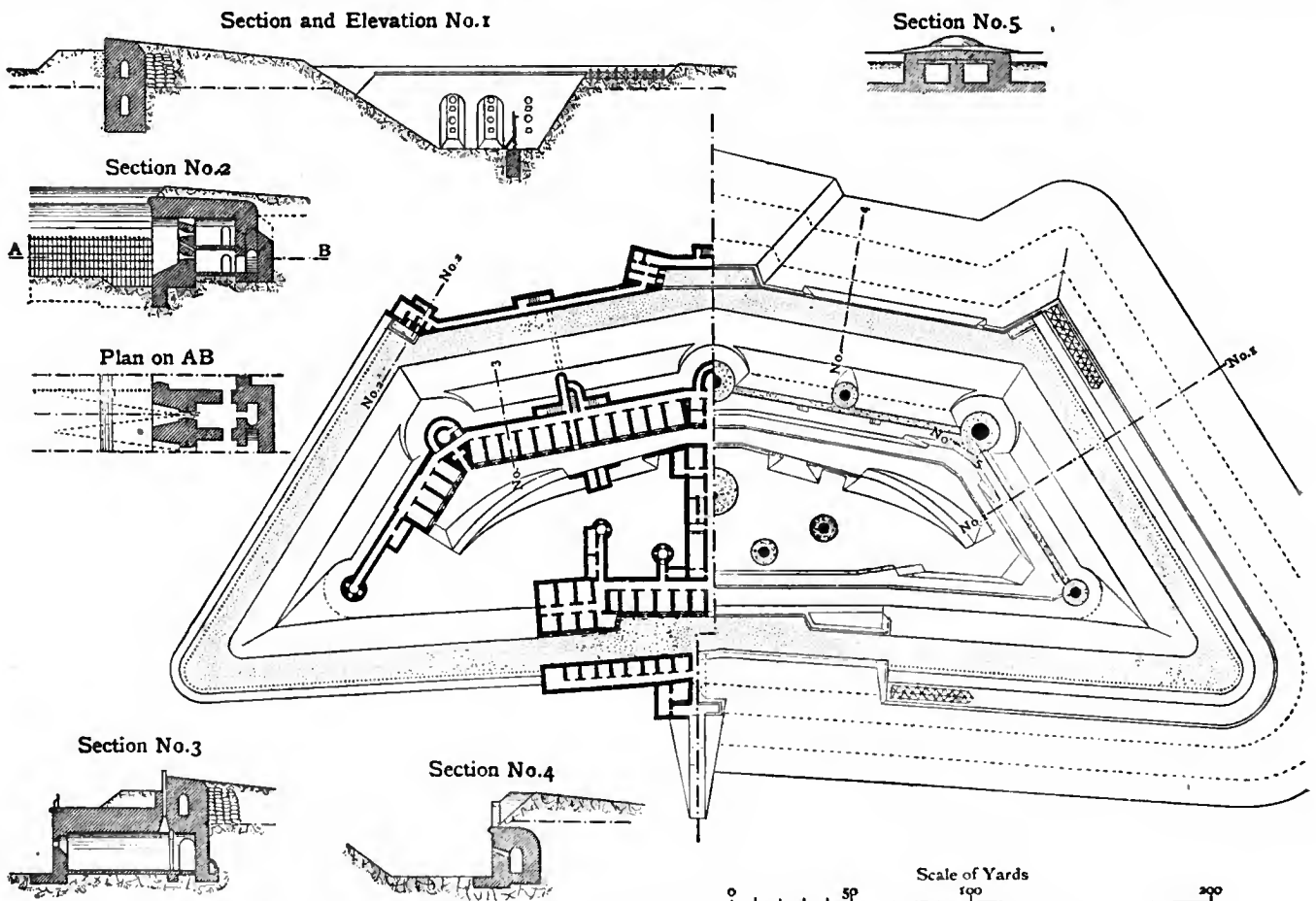

From Brialmont's *Progrès de la défense des états et de la fortification permanente depuis Vauban*, by permission of M. le Commandant G. Meetis.

FIG. 47.

- D. Close with barrier forts the lines necessary to an enemy across mountains or marshes.
- E. Make a central place behind a mountain chain as a pivot for the army watching it.
- F. Defend mountain roads by provisional fortifications.

- G. Make a large place in each theatre of war which is far from the principal theatre, and where the enemy might wish to establish himself.
 - H. Fortify coasts and harbours.
- Objections to these proposals will be readily supplied by the

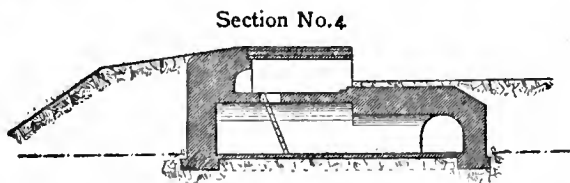
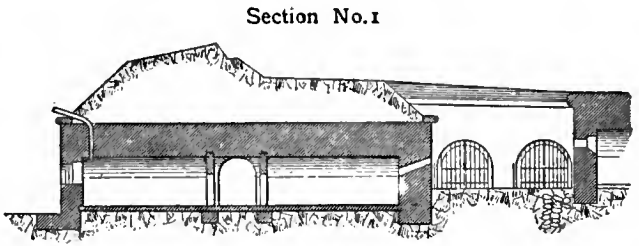
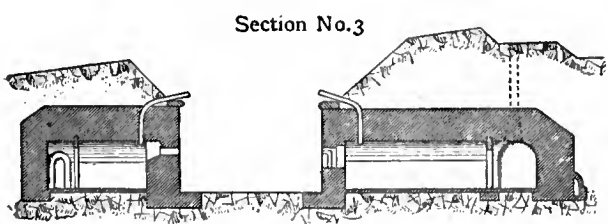
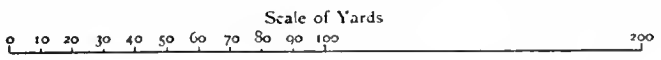
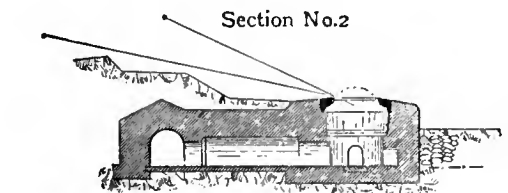
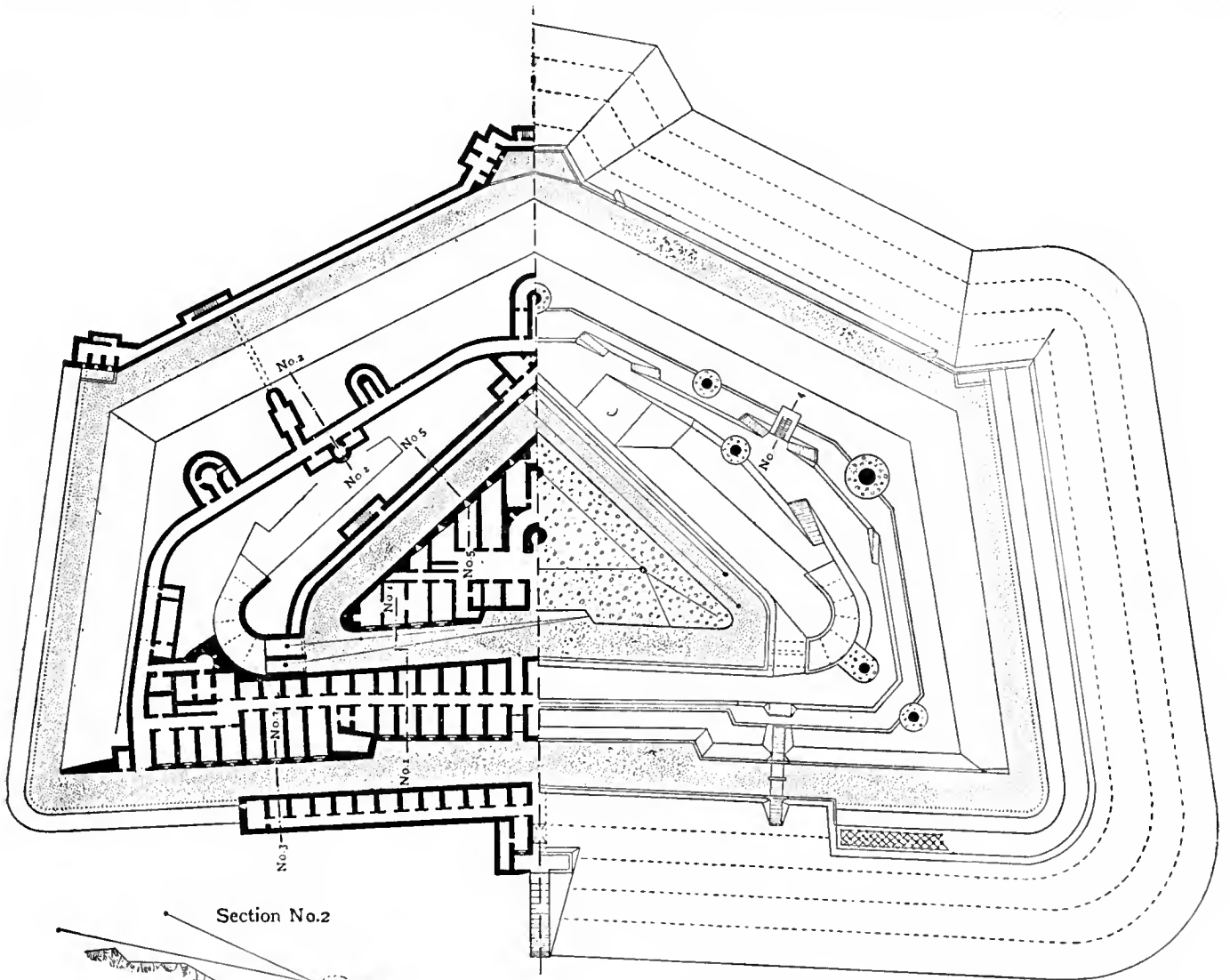

From Brialmont's *Progrès de la défense des états et de la jortification depuis Vauban*, by permission of Commandant G. Meets.

FIG. 48.

officials of the national treasury and the commanders-in-chief of the active armies.

So many types of detached forts have been proposed by competent authorities, as well as actually constructed in recent years, that it is impossible here to consider all of them, and a few only will be reproduced of those which are most representative of modern continental thought.

Types of detached forts.

Taking first the type of heavily armed fort, which contains guns for the artillery fight as well as safety armament, we must give precedence to General Brialmont. The two works here shown are taken from the *Progrès de la défense des états, &c.*, published in 1898. The pentagonal fort (fig. 47) has two special features. In section 1 is shown a concrete infantry parapet, with a gallery in which the defenders of the parapet may take shelter from the bombardment preceding an assault. In section 2 it will be seen that the counterscarp galleries flanking the ditch are drawn back from the face of the counterscarp. This is to counteract proposals that have been made to obscure the view from the flanking galleries, and perhaps drive the defenders out of them by throwing smoke-producing materials into the ditch at the moment of an assault. The arrangement may save the occupants of the galleries from excessive heat and noxious fumes, but will not of course prevent the smoke from obscuring the view.

The following points may be noticed about this design in comparing it with earlier types. There is no escarp, the natural slope of the rampart being carried down to the bottom of the ditch. There is a counterscarp to the faces, but no covered way. The flanks have no counterscarp, but a steel fence at the foot of the slope, and the covered way which is utilized for a wire entanglement which is under the fire of the parapet. The gorge has a very slight bastioned indentation, which allows for an efficient flanking of the ditch by a couple of machine guns placed in a single casemate on either side.

The abolition of the covered way as such is noteworthy. It marks an essential difference between the fort and the old enceinte profiles; showing that offensive action is not expected from the garrison of the fort, and is the duty of the troops of the intermediate lines.

The great central mass of concrete containing all the casemates and the gun-cupolas, a very popular feature, is omitted in this design, advantage being taken of the great lateral extent of the fort to spread the casemates under the faces, flanks and gorge, with a communication across the centre of the fort. This arrangement gives more freedom to the disposition of the cupolas. The thickness of the concrete over the casemate arches is more than 8 ft. Communication between the faces and the counterscarp galleries is obtained by posterns under the ditch. From Brialmont's *Progrès de la défense des états, &c.*, by permission of Commandant G. Meëus.

The armament, which is all protected by cupolas, is powerful. It consists of two 150-mm. (6 in.) guns, four 120-mm. (4.7 in.) guns, two 210-mm. (8.4 in.) howitzers, two 210-mm. (8.4 in.) mortars, four 57-mm. Q.F. guns for close defence. There is also a shielded electric light projector in the centre.

This fort is a great advance on General Brialmont's designs before 1885. These were marked by great complexity of earth parapets and various *chicanes* which would not long survive bombardment. This type is simple and powerful. It is also very expensive.

The second Brialmont fort (fig. 48) is selected because it shows a keep or citadel, an inner work designed to hold out after the capture of the outer parapet. General Brialmont held strongly to the necessity of keeps for all important works. History of course gives instances of citadels which have enabled the garrison to recapture the main work with assistance, or caused a really useful delay in the progress of the general attack. It affords still more instances in which the keeps have made no resistance, or none of any value. Some think that the existence of a keep encourages the defenders of the main work; others that it encourages the idea of retreat. The British school of thought is against keeps. In any case they add largely to expense.

In the present design the keep is a mass of concrete, which depends for the defence of its front ditches on counterscarp galleries in the main work, the few embrasures for frontal defence being practically useless. Its main function is to prevent the attackers from establishing themselves on the gorge, thus leaving the way open for a reinforcement from outside to enter (assisted by bamboo flying bridges) through the passages left for the purpose in the outer and inner gorge parapets.

As regards the main work, the arrangements for defence of the ditch and the armament are similar to the design last considered.

This parapet has no concrete shelter for the defenders. The casemates are all collected in the keep and the gorge, with a passage all round giving access to the parapet and the cupolas.

Fig. 49 is a German work, Fort Molsheim at Strassburg. This is a simple type of triangular fort. The main mass of concrete rests on the gorge, and is divided by a narrow courtyard to give light and air to the front casemates. The fort has a medium armament for the artillery fight, consisting of four 6-in. howitzers in cupolas. On each face are two small Q.F. guns in cupolas for close defence, for which purpose, it will be seen, there is also an infantry parapet. At the angles are look-out turrets. The ditch has escarp and counterscarp, and is defended by counterscarp galleries at the angles. There is no covered way. The thickness of concrete over the casemates, where it is uncovered, is about 10 ft.

Fig. 50 is Fort Lyngby at Copenhagen. The new Copenhagen defences are very interesting, giving evidence of clear and original thought, and effectiveness combined with economy. There is one special feature worth noting about the outer ring of forts, of which Lyngby is one. These works are intended for the artillery fight only, their main armament being four 6-in. guns (in pairs) and three 6-in. howitzers, all in cupolas. The armament for immediate defence is

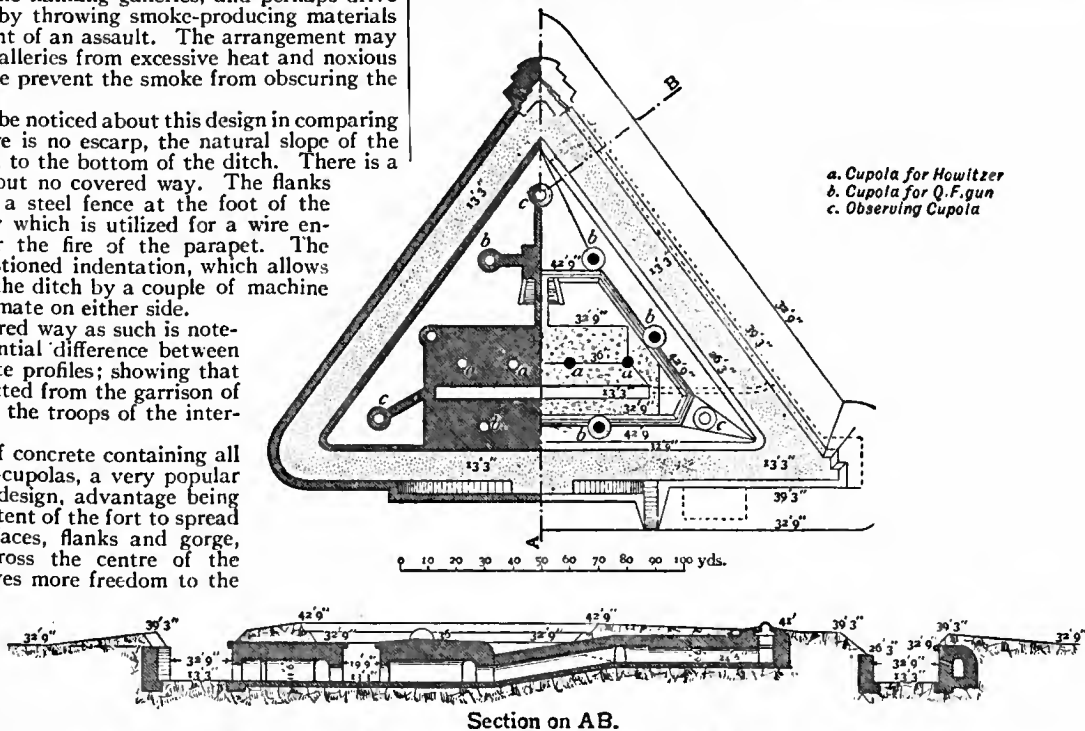

FIG. 49.—Fort Molsheim, Strassburg.

trifling, consisting of only two 57-mm. guns and a machine-gun. There is no provision for infantry defence. The ditch has no escarp or counterscarp, and is flanked by counterscarp galleries at the salient.

It is usual in the case of works so slightly organized for their own defence, and intended only for the long-range artillery fight, to withdraw them somewhat from the front line. The Danish engineers, however, have not hesitated to put these works in the very front line, some 2000 metres in front of the permanent intermediate batteries. The object of this is to force the enemy to establish his heavy artillery at such long ranges that it will be able to afford little assistance to the trench attack of the infantry. The intermediate batteries, being withdrawn, are comparatively safe. They therefore do not require expensive protection, and can reserve their strength to resist the advance of the attack. The success of this arrangement will depend on the fighting strength of the cupolas under war conditions; and what that may be, war alone can tell us.

In the details of these works, besides the bold cutting down of defensive precautions, we may note the skilful and economical use of layers of large stones over the casemates to diminish the thickness of concrete required. The roofs of the casemates are stiffened underneath with steel rails, and steel lathing is used to prevent lumps of concrete from falling on the occupants. The living casemates look out on the gorge, getting plenty of light and air, while the magazines are under the cupolas.

The forts above described are all armed with a view to their taking an important part in the distant artillery fight. The next type to be considered (fig. 51) is selected mainly because it is a good example of the use of concealed flanking batteries, known on the continent as *batteries traîtres*, which seem to be growing in popularity.

This design by Colonel Voorduin of the Dutch engineers has a

- a. Cupola for 2 6" guns
- b. Cupola for 1 6" Howitzer
- c. Disappearing Cupola for Q. F. gun
- d. Machine gun
- e. Observing Station

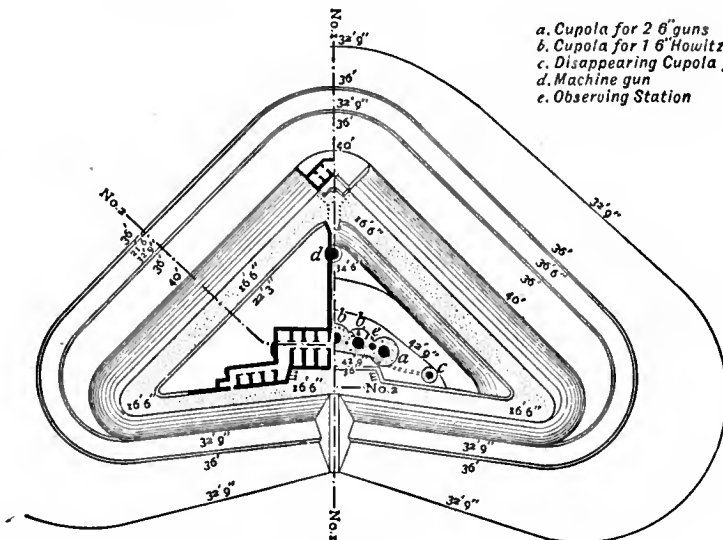

cupola concealed from view, though not protected, by a bank of earth in front. The other six are in an armoured battery behind the cupola. It may be remarked that as the cupola gets no real protection from the covering mass of earth, it would be better to be able to utilize the fire of its guns to the front. The *batterie traditore*, if properly protected overhead, would be very difficult to silence, and its flanking fire would probably be available up to the last moment. There is very much to be said both for and against the policy of so emplacing the guns. The immediate defence of the work, with the aid of a broad wet ditch, is easy; but the great mass of concrete, which is intended to form an indestructible platform and breastwork for the infantry, would seem to be a needless expense.

Fig. 52, designed by the Austrian lieutenant field-marshal Moritz Ritter von Brunner (1839-1904), is selected as a type of the intermediate fort which is intended only to be a strong point in the infantry line of defence between the main forts. It has a protected armament, but this, which consists only of four small Q.F. guns in cupolas, is for its own defence, and not to take part in the artillery duel. There is also a movable armament of four light Q.F. guns on wheels, for which a shelter is provided between the two observatory cupolas. The garrison would be a half company of infantry, for whom casemates are provided in the gorge. The gorge ditch is flanked by a caponier, but there is no flank defence for the front ditch. This is defended by a glacis parapet. At

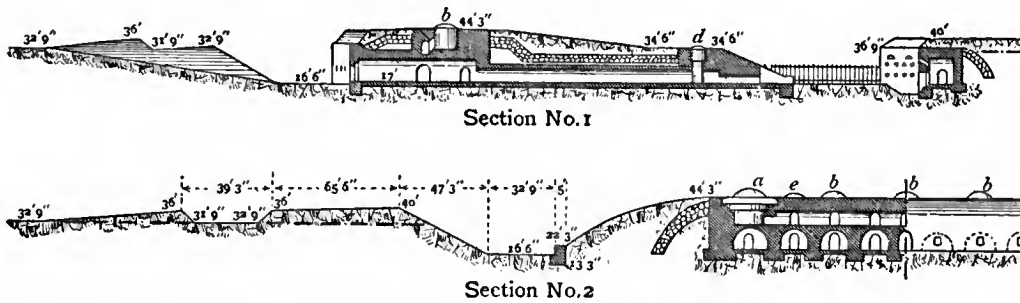

From Brialmont's *Progrès de la défense des états*, &c., by permission of Commandant G. Meëus.
FIG. 50.—Fort Lyngby, Copenhagen.

medium armament, which is not intended for the artillery duel, but to command the immediate front of the neighbouring forts and the intervals. The fort is long and narrow, with small casemate accommodation. It contains eight 4.7-in. guns. Two of these are in a

the bottom of the ditch is a wire entanglement and the glacis slope is planted with thorns. The thickness of concrete on the casemates is 2 metres (6 ft. 7 in.). This is a strong and simple form of infantry work, but considering its rôle it appears to be needlessly expensive.

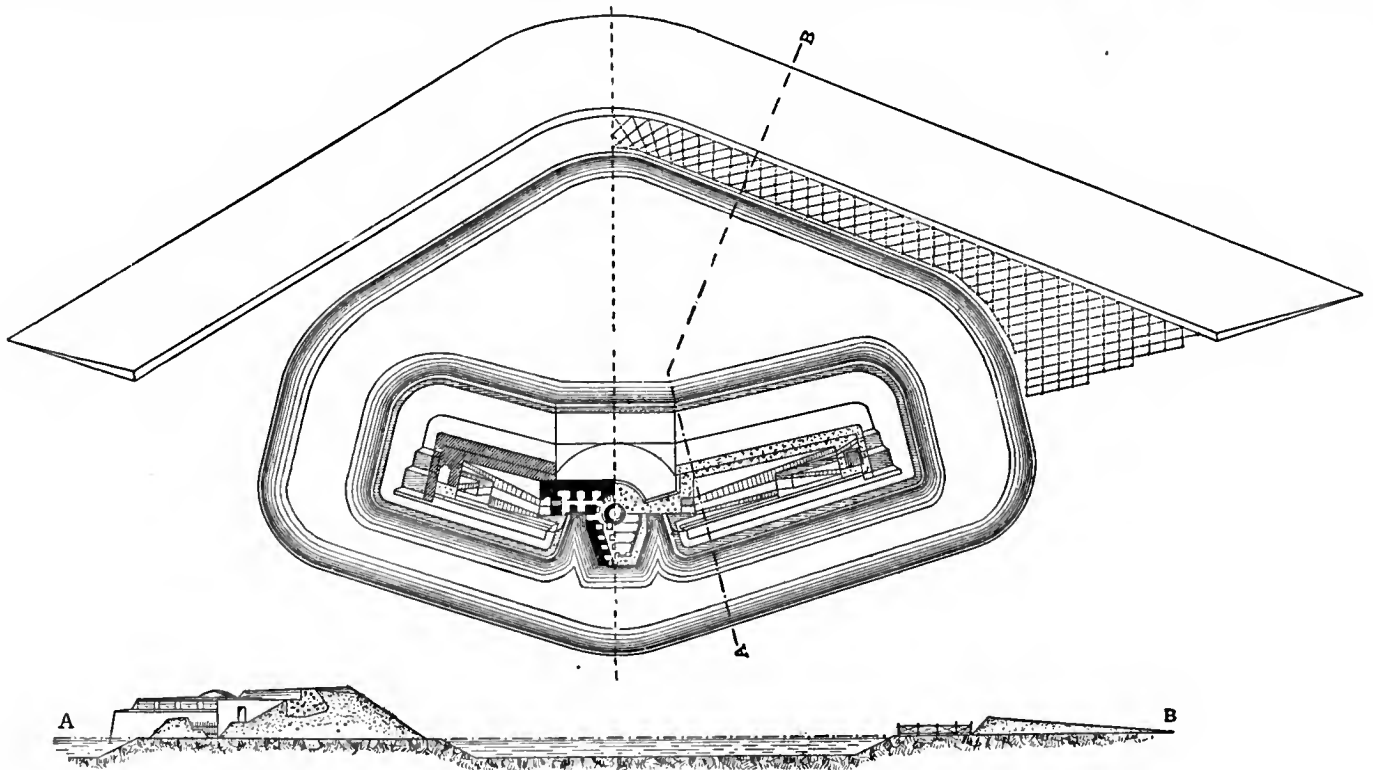

From Leithner's *Beständige Befestigung*.

FIG. 51.

Fig. 53 is an Italian type of barrier fort in mountainous country. A powerful battery of eight medium guns protected by a Gruson shield commands the approach. The fort with its dwelling casemates is surrounded by a deep ditch flanked by counterscarp galleries. There are certain apparent weaknesses in the type, but the difficulties of the attack in such country and its limitations must be borne in mind.

Modern Details of Protection and Obstacle.—After considering the above types of fort, it will be of use to note some of the details in which modern construction has been modified to provide against the increasing power of artillery.

The penetration of projectiles varies according to the nature of the soil—the lighter the better for protection. Sand offers the greatest resistance to penetration, clay the least. Since, however, the penetration of heavy shells fired from long ranges with high elevation may be 20 ft. or more in ordinary soil, we can no longer look to earth alone as a source of protection against bombardment. Again a moderate quantity of earth over a casemate increases the explosive effect of a shell by “tamping” it, that is by preventing the force of the explosion from being wasted in the open air.

Bomb-proof protection.

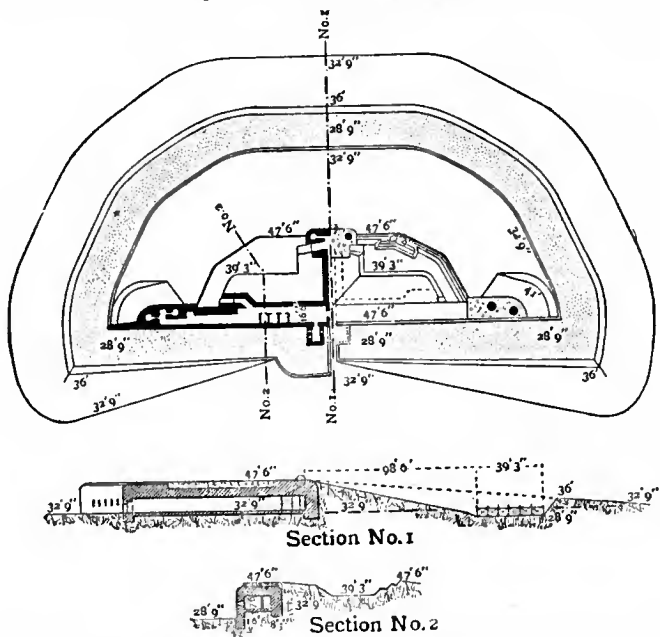

From Brialmont's *Progrès de la défense des états, &c.*, by permission of Commandant G. Meëus.

FIG. 52.

We find therefore that in most modern designs the tops of casemates are left uncovered, or with only a few inches of earth over them, in which grass may be grown for concealment.

For the materials of casemates and revetment walls exposed to fire, concrete (*q.v.*) has entirely replaced masonry and brickwork, not because of its convenience in construction, but because it offers the best resistance. The exact composition of the concrete is a matter that demands great care and knowledge. It should be, like an armour plate, hard on the surface and tough within. The great thickness of 10 ft. of concrete for casemate arches, very generally prescribed on the continent in important positions, is meant to meet the danger of several successive shells striking the same spot. To stop a single shell of any siege calibre in use at present, 5 ft. of good concrete would be enough. A good deal is expected from the use of “reinforced concrete” (that is concrete strengthened by steel) both for revetment walls and casemates.

Parapets are frequently made continuous or glacis-wise, that is the superior slope is prolonged to the bottom of the ditch so that the whole rampart can be swept by the fire of the defenders from the crest, and there is no dead ground in front of it. It is also common to build the crest of the parapet in solid concrete, with sometimes a concrete banquette, so that bombardment shall not destroy the line the defenders have to

Parapets.

man in repelling an assault. This concrete parapet may be further reinforced by hinged steel bullet-proof plates, to give head cover; which when not in use hang down behind the crest.

The escarp is falling into disfavour, on account of the great expense of a revetment that can withstand breaching fire. A counterscarp of very solid construction is generally used. It is low and gives cover to a wire entanglement in the ditch. This may be supplemented by a steel unclimbable

Obstacles.

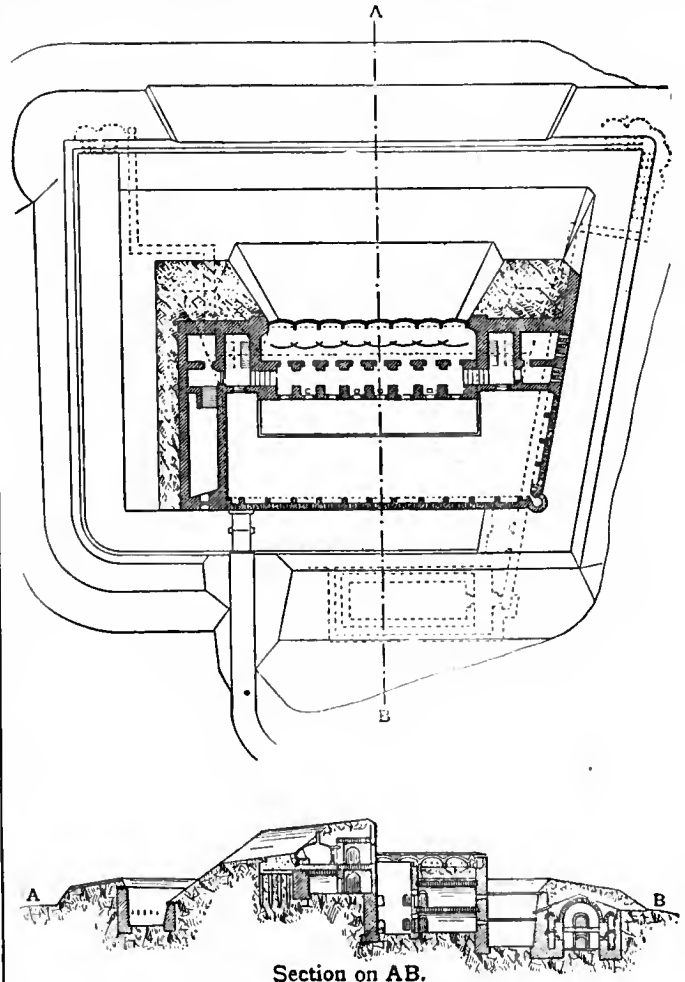

From General Rocchi's *Trattato per lo studio della fortificazione*, by permission.

FIG. 53.

fence, and by entanglements or thorn plantations on the covered way and the lower slopes of the parapet. Entanglements are attached to steel posts bedded in concrete. The upper parts of revetments and the foundations of walls are protected against the action of shells, that falling steeply might act as mines to overturn them, by thick aprons of large stones. Fig. 54 shows most of these dispositions.

Electric search-lights are now used in all important works and batteries. They are usually placed in disappearing cupolas. They are of great value for discovering working parties at night, and lighting up the foreground during an attack; and since only the projector need be exposed, they are not very vulnerable. Their value, however, must not be over-estimated. The most powerful search-light can in no way compare with daylight as an illuminant, and, like all other mechanical contrivances, they have certain marked drawbacks in war. They may give rise to a false confidence; an important light may fail at a critical moment; and in foggy weather they are useless.

Search-lights.

The use of armour (see also ARMOUR-PLATES) for coast batteries followed closely upon its employment for ships, for those were the days of short ranges and close fighting, and it seemed natural not to leave the battery in a position of inferiority to



From Deguise's *La Fortification permanente*, by permission of J. Polleunis.

FIG. 54.

the ship in the matter of protection. In England the coast battery for a generation after the Crimean War was a combination of masonry and iron; and in 1860 Brialmont employed **Armour.** armoured turrets at Antwerp in the forts which commanded the Scheldt. For land defence purposes, however, engineers were very slow to adopt armour. Apart from all questions of difficulty of manufacture, expense, &c., the idea was that sea and land fronts were radically different. It was pointed out that a ship gun, fired from an unsteady platform, had not enough accuracy to strike repeated blows on the same spot; so that a shield which was strong enough to resist a single shot would give complete protection. A battery on a land front, on the other hand, was exposed to an accurate fire from guns which could strike successive blows on the same spot, and break down the resistance of the strongest shield. But in time continental opinion gradually began to turn in favour of iron protection. Practical types of disappearing and revolving cupolas were produced, and many engineers were influenced in their favour by the effect of the big high-explosive shell. Eventually it was argued that, after all, the object of fortification is not to obtain a resisting power without limit, but to put the men and guns of a work in an advantageous position to defend themselves as long as possible against a superior force; and that from this point of view armour cannot but add strength to defensive works.

The question has of course long passed beyond the stage of theory. Practically every European state uses iron or steel casemates and cupolas. German, Danish, Italian and other types of forts so armed have been shown. Recent French types have not been published, but it is known that cupolas are employed; and Velichko, the Russian authority, long an uncompromising opponent of armour, in the end changed his views. These countries have had to proceed gradually, by improving existing fortresses, and with such resources as could be spared from the needs of the active armies. Among the smaller states Rumania and Belgium have entered most freely into the new way. In England, which is less directly interested, opinion has been led by Sir George Clarke, since the publication in 1890 of his well-known book on fortification. Having witnessed officially the experiments at Bucharest in 1885 with a St Chamond turret and a Gruson cupola, he expressed himself very strongly against the whole system. Besides pointing out very clearly the theoretical objections to it, and the weak points of the con-

structions under experiment, he added: "The cost of the French turret was about £10,000 exclusive of its armament, and for this sum about six movable overbank guns of greater power could be provided." In view of the weight that belongs of right to his criticisms it is as well to point out that while this remark is quite true, yet the six guns would require also six gun detachments, with arrangements for supply, &c.; a consideration which alters the working of this apparently elementary sum. The whole object of protection is to enable a few men and guns successfully to oppose a larger number.

At the time when Sir George Clarke's first edition came out, such extravagances were before the public as Mougin's fort; "a mastless turret ship," as he called it, "buried up to the deck-level in the ground and manned by mechanics." Such ideas tended to throw discredit on the more reasonable use of armour, but whether the system be right or wrong, it exists now and has to be taken account of. Nowhere has it been applied more boldly than in Rumania. The defences of Bucharest (designed by Brialmont) consist of 18 main and 18 small forts, with intermediate batteries. The main forts are some 4500 yds. apart, and 11,000 to 12,000 yds. from the centre of the place. The typical armament of a main fort is six 6-in. guns in three cupolas (one for indirect fire), two 8.4-in. howitzers in cupolas, one 4.7-in. howitzer in a cupola, six small Q.F. guns in disappearing cupolas. The total armament of the place (all protected) is eighty-six 6-in. guns, seventy-four 8.4-in. howitzers, eighteen 4.7-in. howitzers, 127 small calibre Q.F. guns in disappearing cupolas, 476 small calibre Q.F. guns in casemates for flanking the ditches. The "Sereth Line" will be described later.

Different Forms of Protection: Casemate, Cupola, &c.—The broad difference between casemates or shielded batteries and turrets and cupolas is that the former are fixed while the latter revolve and in some cases disappear. The casemate thus has the disadvantages that the arc of fire of the gun, which has to fire through a fixed embrasure or port-hole, is very limited, and that the muzzle of the gun and the port-hole, the weak points of the system, are constantly exposed to the fire of the enemy. The advantage of the casemate lies in its comparative cheapness and the greater strength of a fixed structure. It is well suited for barrier forts (fig. 53) and other analogous positions; and the Italians amongst other nations have so employed it at such places as the end of the Mont Cenis tunnel. Steel and iron casemates are also useful as caponiers for ditch flanking (fig. 55).

Turrets and Cupolas.—The difference between a turret and a cupola is that the former is cylindrical with a flat or nearly flat top and presents a vertical target; while the latter is a flattened

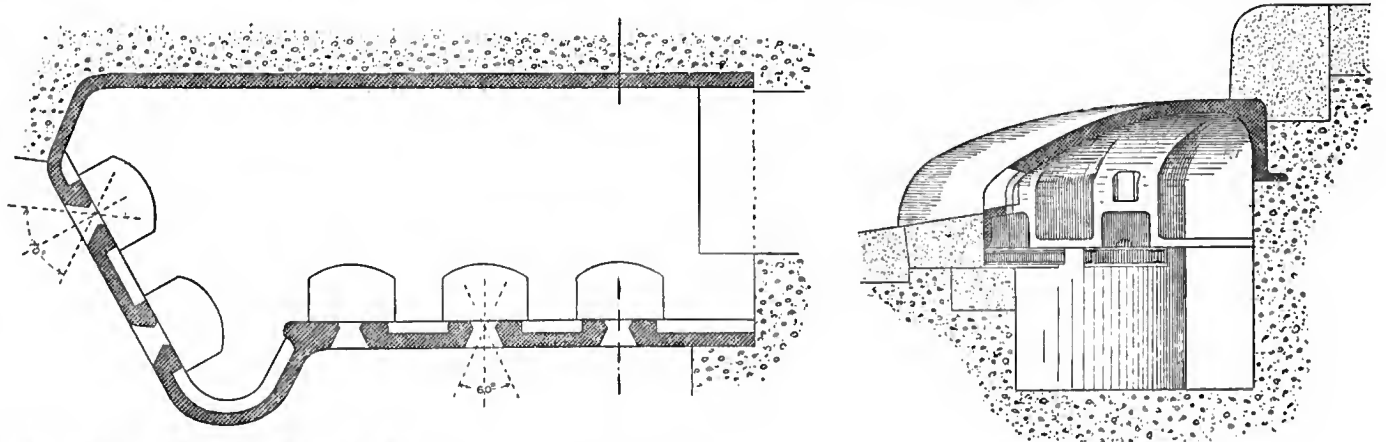

From Leithner's *Beständige Befestigung*, by permission.

FIG. 55.

dome, the vertical supports of which are entirely concealed. The turret appears to be little used. The object of both forms is at once to give an all-round arc of fire to the guns and to allow of the weak point of the structure, the port-hole and muzzle of the gun, being turned away from the enemy in the intervals of firing. Both usually emerge from a mass of concrete, which is strengthened round the opening by a collar of chilled cast iron about 12 to 15 in. thick.

There are four types of cupolas, viz. (a) Disappearing, (b) Oscillating, (c) Central pivot, (d) On roller rings.

(a) Disappearing cupolas are used chiefly for small quick-firing guns, on account of the expense of the various systems. They can be used for medium guns. The details of the best foreign

Cupolas. systems are secret. (b) The oscillating turret is a Mougin type, in which the turret is supported in the centre by a knife-edge on which it can swing. The oscillation is controlled by powerful springs. The effect of it is that after firing, the front of the cupola with the port-hole swings downwards under cover, and is held there until the gun is ready to fire again. (c) Schumann's centre pivot is understood to be approved in Germany. It has been adopted in Rumania and Belgium for howitzer cupolas. It is only suitable for a single piece; *d* is strong and steady—the best cupola for coast batteries; *c* and *d* are best for rapid fire because they can be loaded without lowering. They are suited for long guns.

The following types are illustrated as being generally representative of the different classes of cupola.

Fig. 56 is a section of Messrs Krupp's typical cupola for one 6-in. gun. The shield is of nickel steel, the collar of cast steel. A small space is left between the cupola and its collar to prevent the possibility of the shield jamming after being damaged. The guns are muzzle-pivoting and thickened out near the muzzle by the addition of a ring, so as to close the port as much as possible. The recoil is controlled within narrow limits both to economize space and to prevent the smoke from the muzzle from getting into the cupola. To facilitate the elevation and depression of the gun (with muzzle pivoting the breech has of course to be moved through a much larger arc than with ordinary mountings) it is balanced by a counterweight. The cupola rests on a roller ring and is traversed by a winch. It can be turned through a complete circle in about one minute.

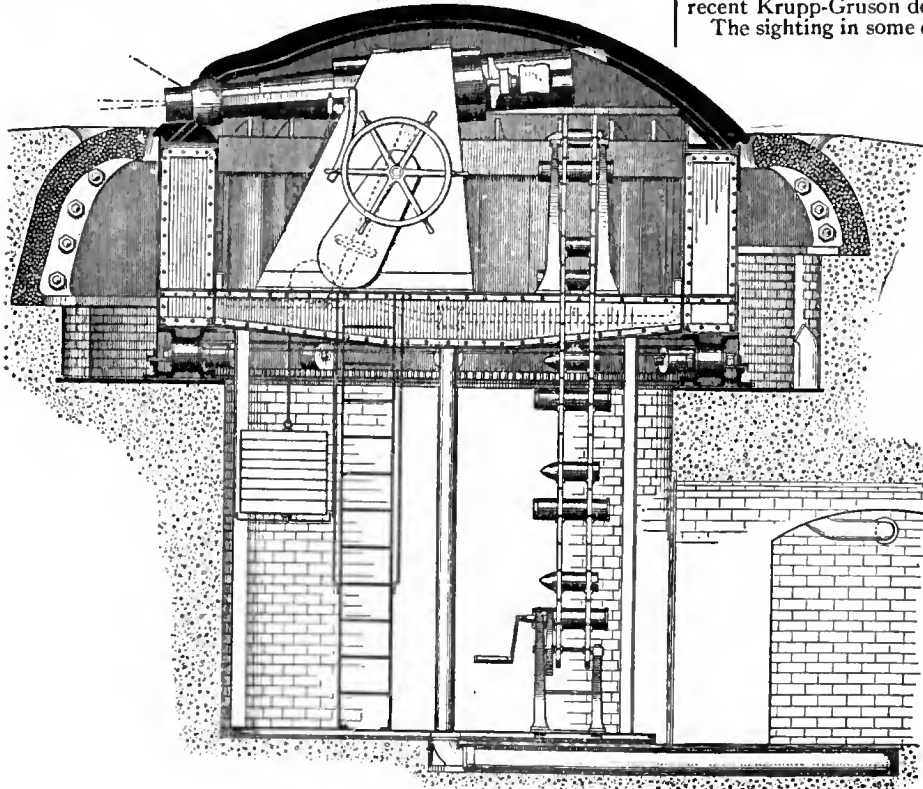
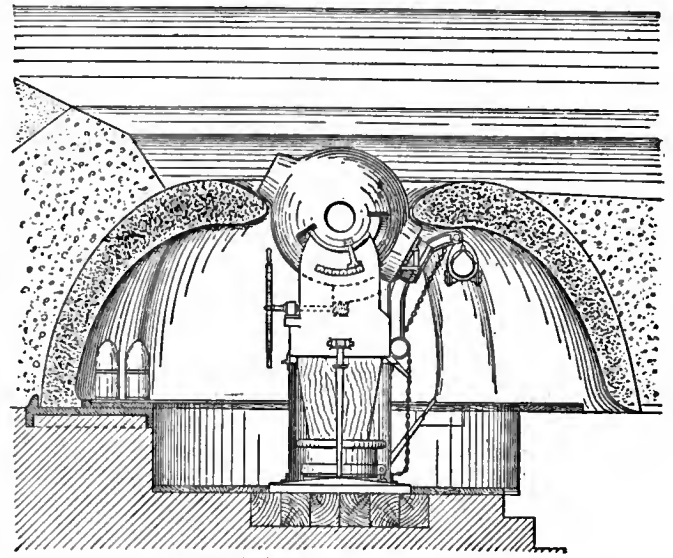

FIG. 56.—Cupola for 6-in. gun (Friedr. Krupp A.G.).

Fig. 57 shows a Schumann shielded mortar (sphere-mortar, *Kugelmörser*). In this case it will be observed that the cupola is replaced by an enlargement of the encircling collar; and the mortar (8.4-in. calibre) is enclosed in a sphere of cast iron, so as to close completely the opening of the collar in any position.

Fig. 58 shows a Gruson cupola for one 4.7-in. Q.F. howitzer.

Fig. 59 shows a disappearing turret for an electric light projector. Fig. 60 shows a Krupp transportable cupola for a 5.7-cm. gun. This is drawn on a four-wheeled carriage, and when coming into action slides on rollers on to a platform in the parapet. It weighs about 2½ tons, and with carriage and platform about 4 tons.



From Leithner's *Beständige Befestigung*.

FIG. 57.—Gruson Spherical Mortar.

The mechanism of these cupolas is for the most part simpler than it appears. Counterweights and hand winches are much in use for the lighter natures of guns. The armouring of course keeps pace with improvements in manufacture. The chilled cast iron first made popular by the Gruson firm is now little used except for such purposes as the collar round a cupola. Wrought iron, steel and compound plates for the tops of cupolas have all been tried, the most recent Krupp-Gruson designs being of nickel steel.

The sighting in some cases may be done by sights on the gun, with suitable enlargements in the port-hole; in others by sights affixed to the cupola itself (which of course can give horizontal direction only); in others training and elevation are given in accordance with the readings on electric dials, or instructions by telephone or speaking tube. There is of course nothing unreasonable in this in the case of indirect fire guns and howitzers, for if not firing from cupolas they would be behind the shelter of some wood or quarry.

Schumann's System: "Armoured Fronts."—Lieut.-Colonel Maximilian Schumann (1827-1889) of the Prussian engineers, who took a very prominent part in the design and advocacy of armoured defences, eventually produced a system which dispensed entirely with forts and relied on the fire of protected guns. It consists of several lines of batteries for Q.F. guns and howitzers in cupolas. He considered that such batteries would be able to defend their own front, and the infantry garrison was not to be called into action except in the case of the enemy breaking through at some point of the line.

This system was actually adopted by Rumania (1889-1892) for the Sereth Line. There are three routes by which the Russians can enter the country across the Sereth river: through Focshani, Nemolassa and Galatz. These three routes are barred by bridge-heads, those at Focshani, the most important, being on the left bank of the Milkov, a tributary of the Sereth.

The Focshani works consist of 71 batteries arranged on a semicircular front about 12 m. long and from 800 to 10,000 yds. in advance of the bridges. The batteries are placed in three lines, which are about 500 yds. apart, and are subdivided into groups. The normal group consists of 5 batteries, of which 3 are in the first line, 1 in the second, and 1 in the third. The first-line batteries each contain five small Q.F. guns in travelling

cupolas. The second-line batteries, each six small Q.F. guns in disappearing cupolas. The third-line batteries have one 120-mm. gun in a cupola, and two 210-mm. spherical mortars with Gruson shields. The immediate defence of the batteries consists of a glacis planted with thorn bushes and a wire entanglement.

The fortification of these three bridge-heads are said to have cost about £1,100,000. But the system of "armoured fronts" is never likely to be reproduced, having been condemned by all authoritative continental opinion. Its defects have been summarized by Schroeter as follows: weakness of artillery at long ranges, want of security against a surprise rush, the neglect of the use of infantry in the defence, and the difficulty of command. This last is the most

and that those of the attacker shall have the minimum chances of effecting injury."

Since Sir George Clarke published his first edition in 1890 continental ideas have expanded a good deal. The foregoing statement as to the three categories of defences would be accepted anywhere now: the differences of opinion come in when we reach the stage of classifying under the first head the permanent works to be constructed in peace time. In most countries these would include forts with guns for the artillery duel, forts with safety armaments, fixed batteries with or without armour, and forts for infantry only. Sir George

Infantry redoubts.

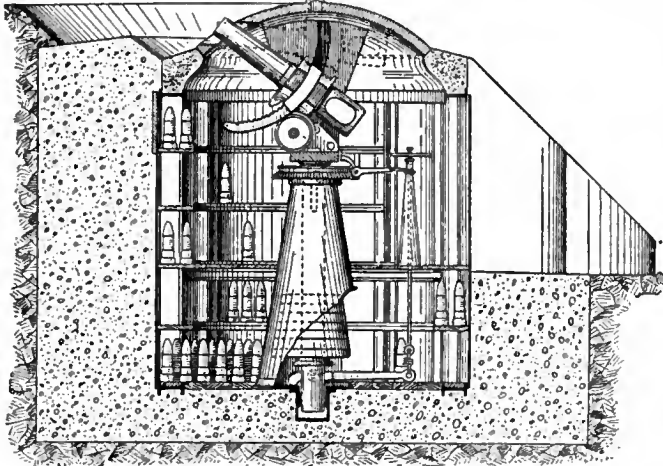

From Leithner's *Beständige Befestigung*.

FIG. 58.—Cupola for 4.7-in. Howitzer.

serious of all. It is indeed difficult to conceive that any one should expect half-a-dozen expert gunners, each shut up in an iron box with a gun, to stop the rush of a thousand men, even by day. But imagine the feelings of the gunner on the night of a big attack, alone in his box, his nerves already strained by a preliminary bombardment and nights of watching. He hears the sounds of battle all around; he knows nothing of the progress of the attack, but expects everything, and feels every moment the door of his box being opened and the bayonet entering his back. No wise commander would submit his troops to such a test.

Sir George Clarke and Unarmoured Systems.—Before leaving the subject of fortresses it is necessary to consider the ideas of those who, while recognizing the necessity for places permanently organized for defence, prefer to treat them more from the point of view of perfected field defences. It is to the credit of English military science that Sir George Clarke may be taken as the representative of this school of thought. His study of fortification, as he tells us, began with a history of the defence of Plevna (*q.v.*). He was led to compare the resistance made behind extemporized defences at such places as Sevastopol, Kars and Plevna, with those at other places fortified in the most complete manner known to science. From this comparison he drew the conclusion that the true strength of fortification does not depend on great masonry works intricately pieced together at vast expense, but on organization, communications and invisibility. In his 1907 edition he says:—

"Future defences will divide themselves naturally into the following categories: (1) Permanent works wholly constructed in the peace time and forming the key points of the position. (2) Gun emplacements, magazines and shelters for men in rear of the main line, all concrete structures and platforms to be completed, though some earthwork may be left until the position is placed in a state of defence. (3) Field works, trenches, &c., guarding the intervals between the permanent defences in the main line, or providing rear positions. These should be deliberately planned in time of peace ready to be put in hand at short notice. The essence of a well-fortified position is that the weapons of the defender shall obtain the utmost possible scope of action,

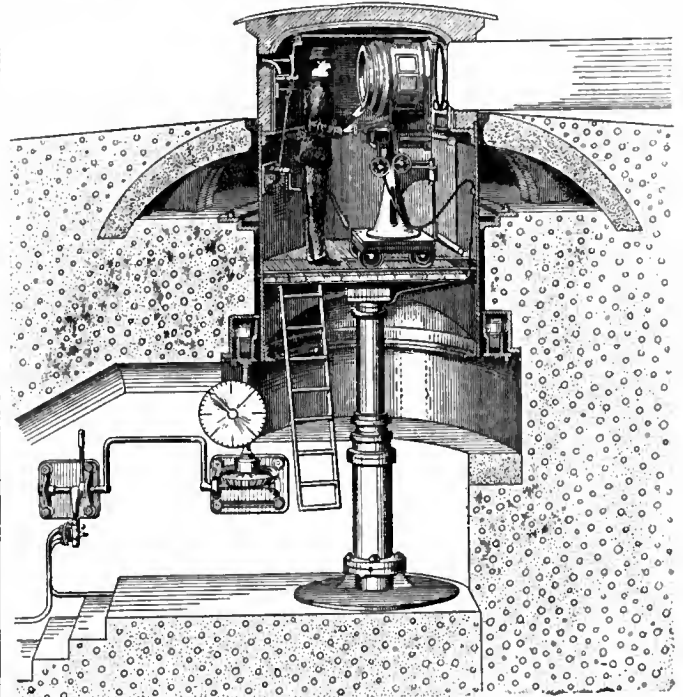

Drawn from illustration in Leithner's *Beständige Befestigung*, by permission.

FIG. 59.—Disappearing Turret for Searchlight.

Clarke will have no armour for guns except in certain special cases of barrier forts. Heavy guns and howitzers requiring permanent emplacements (concrete platforms, &c.) must either be well concealed or be provided with alternative positions. The only permanent works which he admits are for infantry. They are redoubts of simple form intended for 350 or 400 men, with casemate accommodation for three-fourths of that number. Fig. 61 shows the design:—two rows of casemates, one under the front parapet, one under a parados; frontal musketry defence; obstacle consisting of entanglements, mines, &c., with or without escarp and counterscarp.

"The intervals (he says) between the infantry redoubts may be about 2500 yds.; but this will necessarily depend upon the conformation of the ground. Where there are good artillery positions falling within the sphere of protection of the redoubts, large intervals will be permissible. Thus, in the case of an extended line of defence where the ground offers marked tactical features, the idea of a continuous chain of permanent works may be abandoned in favour

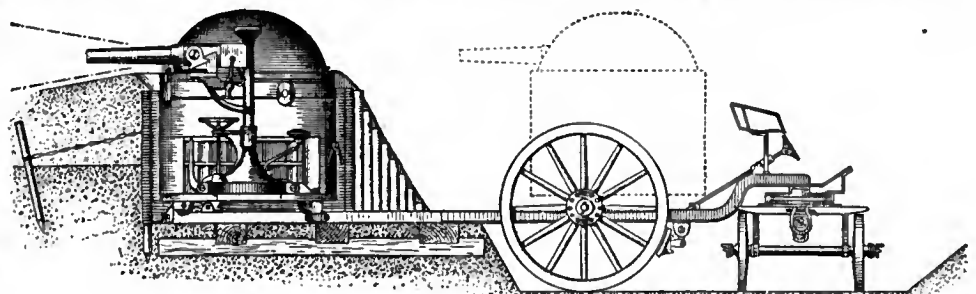
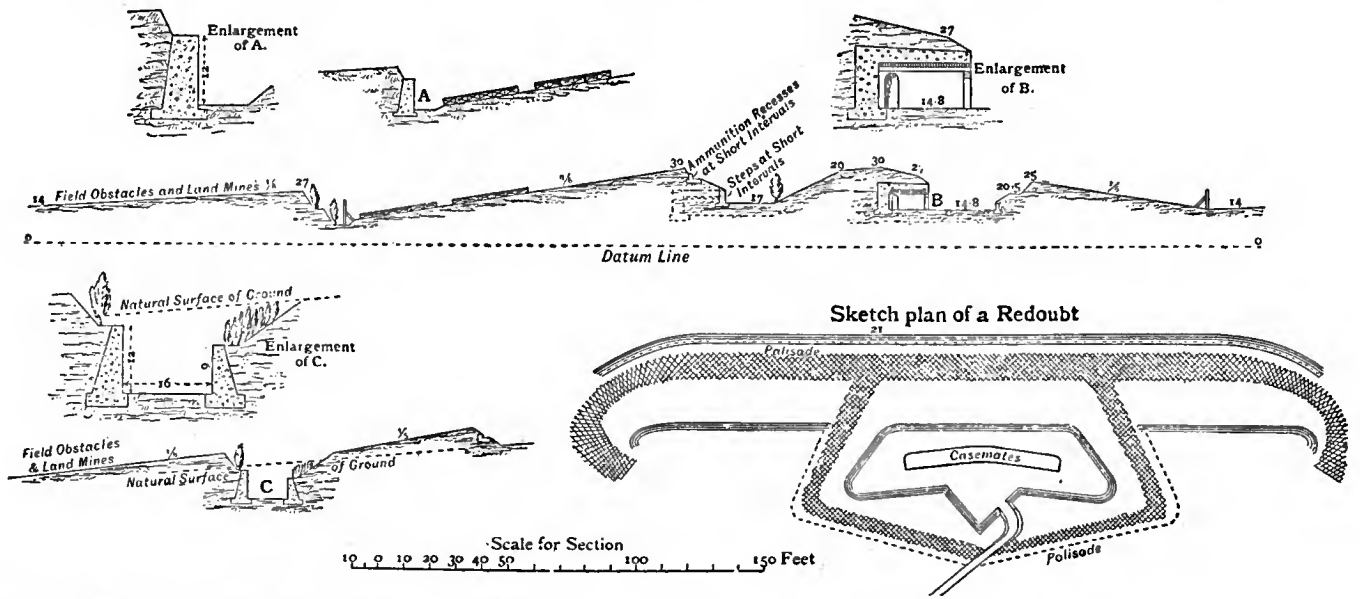

FIG. 60.—Transportable Cupola for 5.7-cm. Gun (Friedr. Krupp A.G.).



From Sir George S. Clarke's *Fortification*, by permission of John Murray.

FIG. 61.

of groups of redoubts guarding the artillery positions. In this case, the redoubts in a group might be distributed on a curve bent back in approximately horse-shoe form."

The keystones of the close defence of the fighting line in future will undoubtedly be these infantry redoubts, and therefore it is of great interest to compare with the above types two studies put forward by Schroeter (*Die Festung in der heutigen Kriegführung*), one in his first edition in 1898 (fig. 62), and the other in the second in 1905 (fig. 63). In both these the defensive arrangements are merely trenches of field profile with entanglements, the command and the obstacle being less than in Sir George Clarke's work; and it will be noticed that in the 1905 type, published after the Russo-Japanese War, the plan is much

less simple and arrangements for close flanking defence have been introduced. But these works of Schroeter's are merely infantry supporting points in a line which contains forts of the triangular type with guns, and armoured batteries, as well as a very complete arrangement of field defences and communications; while Sir G. Clarke's redoubts are the only permanent works giving casemate protection in the front line.

The comparative merits of either design for an infantry redoubt are not of much importance. It is agreed that the main line of defence must consist of a more or less continuous line of field defences and obstacles, and that at some points in the line there should be infantry supporting points with bomb-proof protection capable of resisting big shells. The open question is, what additional works, if any, are required for the artillery, whether for the medium and heavy guns that will take part in the "artillery duel," or for the lighter natures that will help in the close fight and defence of the intervals. Is it best for the defenders to rely on armoured protection or on concealment for his guns?

Official opinion outside England has certainly sanctioned armour, since all over the continent it is to some extent adopted in practice. National practice is usually based on the advice of the most distinguished officers of the day, and therefore it is unsafe to condemn it hastily. Sir George Clarke and those who are with him—and they are many, both in Great Britain and abroad—object entirely to armour. He says (*Fortification*, ed. 1907, p. 96): "The great advantage possessed by the attack in all ages has been the employment of a mobile artillery against armaments cribbed, cabined and confined by fortification. It is necessary to perpetuate this advantage?" Of course the effect of long-range weapons, in increasing the length of front that can be held by a given force, has given much greater

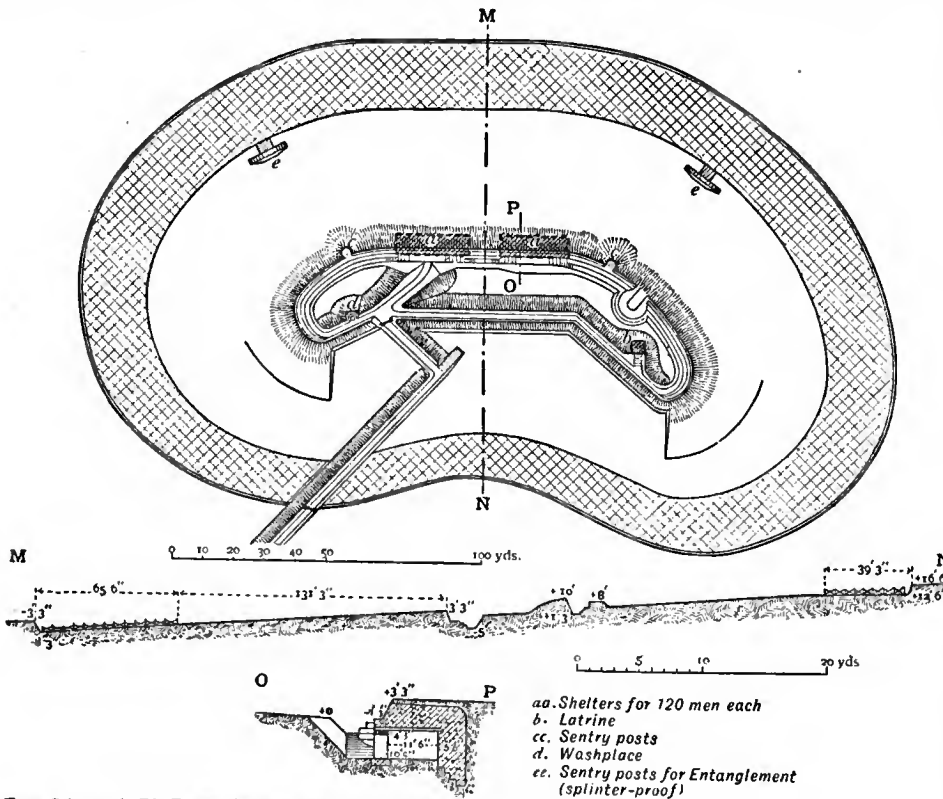

From Schroeter's *Die Festung in der heutigen Kriegführung*, by permission of E. S. Mittler u. Sohn.

FIG. 62.

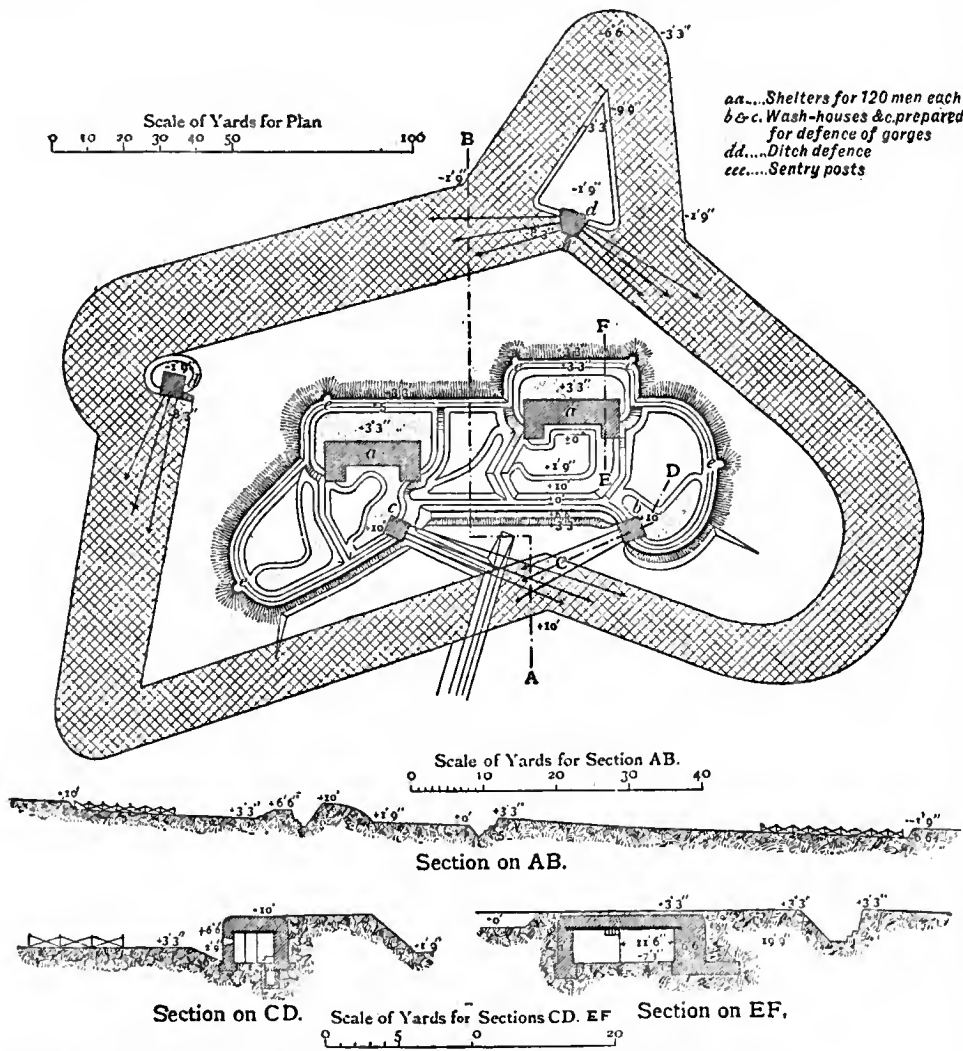

From Schroeter's *Die Festung in der heutigen Kriegführung*, by permission of E. S. Mittler u. Sohn.

FIG. 63.

freedom of action to the defence and this should be taken full advantage of.

The argument as to the vulnerability of shielded guns is not at present strong. Sir George says (*ib.* p. 94), "If the high angle fire . . . is ever to find a favourable opportunity, it will surely be against a cupola, the site of which can generally be determined with accuracy." On the other hand he says (p. 90), "During the long and costly experiments carried on at Bucharest in 1885-1886, 164 rounds were fired from the Krupp 21 cm. mortar at targets of about 40 sq. metres area" (about 430 sq. ft.) "without obtaining a single hit. The range was 2700 yds.; the targets were towers built upon a level plain; the shooting conditions were ideal, and the fall of each shell was telephoned back to the firing point; but it must have been evident to the least instructed observer that to attempt to group 6 or 8 shells on an invisible area 2 metres square would have been absolutely futile." These facts are adduced to prove that it is not necessary to give great thickness to concrete casemates, to resist successive bursts of shells in the same place; but surely they are equally applicable to cupolas. Again (p. 252), "The experience gained at Port Arthur was not altogether encouraging as regards the use of high angle fire. The Russian vessels in the harbour were sunk by opening their sea-valves. . . . Fire was subsequently directed upon them from 11 in. howitzers at ranges up to about 7500 yds. This was deliberate practice from siege batteries at stationary targets; but the effect was distinctly disappointing." The cupolas therefore can hardly be considered ideal targets: and the probability is that they would hold their own against both direct and indirect fire for a long time. There are other

and stronger arguments against the general use of them, all of which are clearly set forth by Sir George Clarke.

The worst objections to the cupola are the military disadvantages of isolation and immobility, and the multiplication of mechanical arrangements. For a successful round from a disappearing cupola, the elevating and traversing arrangements, the elevating and loading gear of the gun, and the telephonic communication, must all be in good order. At night the successful co-operation of the searchlight is also in many cases necessary.

The teaching of history is all against immobile mechanical defences. Initiative, surprise, unforeseen offensive action, keeping the besieger in ignorance of the dispositions of the garrison, and of what progress he is making: all these, with their influence on the morale of both sides, tend towards successful defences and do not point towards the use of armour.

It may further be said that the use of armour as a general rule is unnecessary, because a concealed battery is a protected one; and with the long ranges now usual for heavy guns and howitzers, there is not generally much difficulty about concealment.

In the opinion, however, of the present writer an exception must be made for guns intended to flank the line of defence, which would generally need bomb-proof over-head cover. Further, when we leave theory and come to the consideration of actual problems of defence, it will often be found that it is necessary to place guns in certain positions where good concealment cannot be got.

In such cases some form of protection must be given if the guns are to engage the concealed batteries of the attack.

III. THE ATTACK OF FORTRESSES

In considering the history of siegecraft since the introduction of gunpowder, there are three main lines of development to follow, viz. the gradually increasing power of artillery, the systematizing of the works of attack, and in recent times the change that has been brought about by the effect of modern small-arm fire.

Cannon appear to have been first used in sieges as mortars, to destroy hoardings by throwing round stones and barrels of burning composition. Early in the 15th century we find cannon throwing metal balls, not only against hoarding and battlements, but also to breach the bases of the walls. It was only possible to work the guns very slowly, and archers or crossbowmen were needed in support of them, to drive the defenders from the crenellations or loopholes of the battlements. At that period the artillery was used in place of the medieval siege engines and in much the same manner. The guns of the defence were inaccurate, and being placed high on the walls were made ineffective by bad mountings, which did not allow of proper depression. The besieger therefore could place his guns close to the walls, with only the protection of a few large gabions filled with earth, set up on the ground on either side of the muzzle.

In the course of the 15th century the power of artillery was largely increased, so that walls and gates were destroyed by it in an astonishingly short time. Three results shortly followed.

The guns of the defence having gained equally in effectiveness, greater protection was needed for the attack batteries; bastions and outworks were introduced to keep the besieger at a distance from the inner walls; and the walls were sunk in ditches so that they could only be breached by batteries placed on the edge of the glacis.

Early in the 16th century fortresses were being rapidly remodelled on these lines, and the difficulties of the attack were at once very much increased. The tendency of the assailants was still to make for the curtain, which had always been considered the weak point; but the besiegers now found that they had to bring their guns right up to the edge of the ditch before they could make a breach, and in doing so had to pass over ground which was covered by the converging fire from the faces of the bastions. Towards the end of the century the attack of the curtain was delayed and the cross-fire over the ground in front increased by the introduction of ravelins.

The slight gabion protection for the siege batteries was at first replaced by strong timber shelters. These were found inadequate; but a still greater difficulty was that of bringing up the siege guns to their positions, emplacing them and maintaining communication with them under fire. In addition to this, the guns of the defence until they could be overpowered (a slow process) dominated a wide belt of ground in front of the fortress; and unless the besiegers could find some means of maintaining a strong guard close to their batteries these were liable to be destroyed by sorties from the covered way.

Gradually the whole problem of siege work centred round the artillery. The besiegers found that they had first to bring up enough guns to overpower those of the defence; then to advance their guns to positions from which they could breach the walls; and throughout these operations to protect them against sorties. Breaches once made, the assault could follow on the old lines.

The natural solution of the difficulty of approach to the battery positions was the use of trenches. The Turks were the first to make systematic use of them, having probably inherited the idea from the Eastern Empire. The soldiers of Christendom, however, strongly disliked digging, and at first great leaders like Bayard and Montluc had themselves to use pick and shovel, to give their men an example. In due course the necessity of the trenches was recognized, but the soldiers never took kindly to them, and the difficulty was dealt with in a manner reminiscent of the feudal ages, by impressing large bodies of peasantry as workmen whenever a siege was in contemplation.

Through the 16th and most of the 17th century, therefore, we find the attack being conducted by means of trenches leading to the batteries, and supported by redoubts often called "places of arms" also made by trench work. During this period the result of a siege was always doubtful. Both trenches and batteries were arranged more or less at haphazard without any definite plan; and naturally it often happened that offensive action by the besieged against the trenches would disorder the attack and at times delay it indefinitely. Fig. 64, taken from a late 17th-century print by de Fer of Paris, gives a good idea of the general practice of that day when Vauban's methods were not yet generally known.

Another weak point about the attack was that after the escarp walls had been strengthened to resist artillery fire as has been described, there was no clear idea as to how they should be breached. The usual process was merely an indiscriminate pounding from batteries established on the crest of the glacis. Thus there were cases of sieges being abandoned after they had been carried as far as the attempt to breach.

It is in no way strange that this want of method should have characterized the attack for two centuries after artillery had begun to assert its power. At the outset many new ideas had to be assimilated. Guns were gradually growing in power; sieges were conducted under all sorts of conditions, sometimes against medieval castles, sometimes against various and widely-differing examples of the new fortification; and the military systems of the time were not favourable to the evolution of

method. It is the special feature of Vauban's practical genius for siege warfare that he introduced order into this chaos and made the issue of a siege, under normal conditions, a mere matter of time, usually a very short time.

The whole of Vauban's teaching and practice cannot be condensed into the limits of this article, but special reference must be made to several points. The most important of these is his general arrangement of the attack. *Vauban's teaching.* The ultimate object of the attack works was to make a breach for the assaulting columns. To do this it was necessary to establish breaching batteries on the crest of the glacis; and before this could be done it was necessary to overpower the enemy's artillery. This preliminary operation is nowadays called the "artillery duel." In Vauban's day the effective range of guns was 600 to 700 yds. He tells us that it was customary to establish batteries at 1000 yds. from the place, but

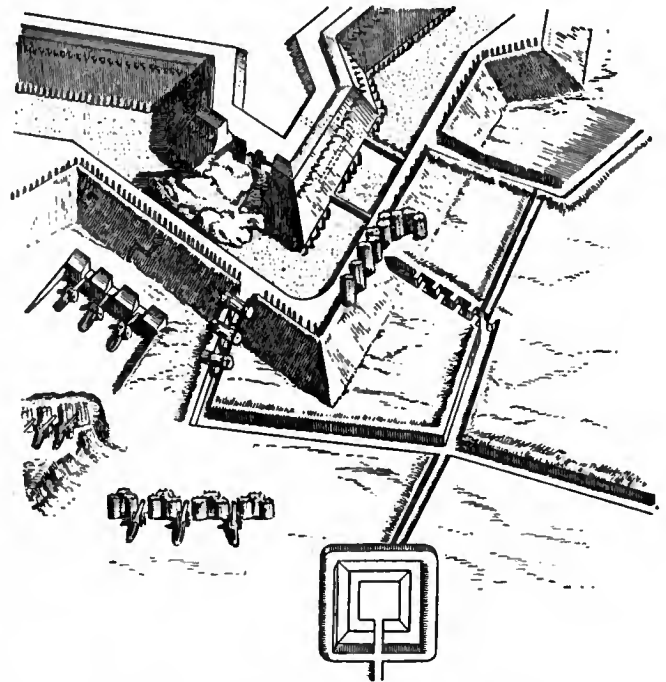

FIG. 64.—Siege-works of the 17th century.

that at that range they did little more than make a great deal of noise. The first object of the attack, therefore, after the preliminary operations of investment, &c., had been completed, was to establish batteries within 600 or 700 yds. of the place, to counter-batter or enfilade all the faces bearing on the front of attack; and to protect these batteries against sorties. After the artillery of the defences had been subdued—if it could not be absolutely silenced—it was necessary to push trenches to the front so that guns might be conveyed to the breaching positions and emplaced there in batteries. Throughout these processes it was necessary to protect the working parties and the batteries against sorties.

For this purpose Vauban devised the *Places d'armes* or *lignes parallèles*. He tells us that they were first used in 1673 at the siege of Maestricht, where he conducted the attack, and which was captured in thirteen days after the opening of the trenches. The object of these parallels was to provide successive positions for the guard of the trenches, where they could be at hand to repel sorties. The latter were most commonly directed against the trenches and batteries, to destroy them and drive out the working parties. The most vulnerable points were the heads of the approach trenches. It was necessary, therefore, that the guard of the trenches should be in a position to reach the heads of the approaches more quickly than the besieged could do so from the covered way. This was provided for as follows.

The first parallel was usually established at about 600 yds. from the place, this being considered the limiting range of action

of a sortie. The parallel was a trench 12 to 15 ft. wide and 3 ft. deep, the excavated earth being thrown forward to make a parapet 3 or 4 ft. high. In front of the first parallel and close to it were placed the batteries of the "first artillery position."

While these batteries were engaged in silencing the enemy's artillery, for which purpose most of them were placed in prolongation of the faces of the fortress so as to enfilade them, the "Approach Trenches" were being pushed forward. The normal attack included a couple of bastions and the ravelin between, with such faces of the fortress as could support them; and the approach trenches (usually three sets) were directed on the capitals of the bastions and ravelin, advancing in a zigzag so arranged that the prolongations of the trenches always fell clear of the fortress and could not be enfiladed.

Fig. 65, taken from Vauban's *Attack and Defence of Places*, shows clearly the arrangement of trenches and batteries.

After the approach trenches had been carried forward nearly half-way to the most advanced points of the covered way, the "second parallel" was constructed, and again the approach trenches were pushed forward. Midway between the second parallel and the covered way, short branches called *Demi-parallels* were thrown out to either flank of the attacks: and finally at the foot of the glacis came the third parallel. Thus there was always a secure position for a sufficient guard of the trenches. Upon an alarm the working parties could fall back and the guard would advance.

Trenches were either made by *common trenchwork*, *flying trenchwork* or *sap*. In the first two a considerable length of trench was excavated at one time by a large working party extended along the trench: flying trenchwork (formerly known as flying sap) being distinguished from common trenchwork by the use of gabions, by the help of which protection could be more quickly obtained. Both these kinds of trenchwork were commenced at night, the position of the trench having been previously marked out by tape. The "tasks" or quantities of earth to be excavated by each man were

trench 1 ft. 6 in. wide and deep. To protect the head of the trench he had a shield on wheels, under cover of which he placed the gabions in position one after another as the sap-head progressed. Other men following strengthened the parapet with fascines, and increased the trench to a depth of 3 ft., and a width of 2 ft. 6 in. to 3 ft. Fig. 66, taken from Vauban's treatise on the attack, shows the process clearly. The sap after being completed to this extent could be widened at leisure to ordinary trench dimensions by infantry working parties.

The attack.

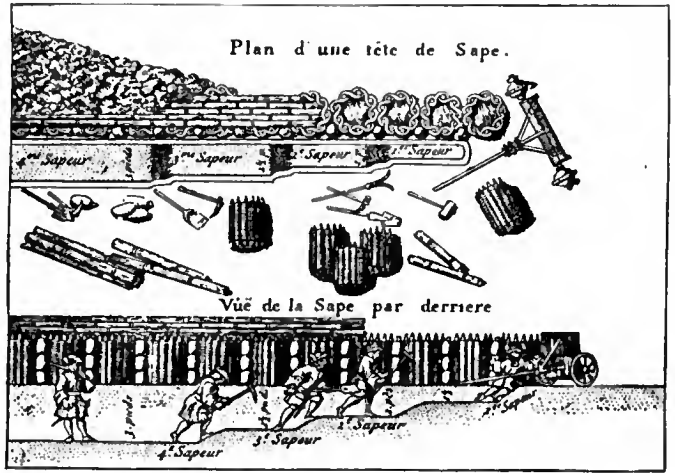

FIG. 66.—Sapping (Vauban).

As the work at the sap-head was very dangerous, Vauban encouraged his sappers by paying them on the spot at piecemeal rates, which increased rapidly in proportion to the risk. He thus stimulated all concerned to do their best, and reckoned that under average conditions he could depend on a rate of progress for an ordinary sap of about 50 yds. in 24 hours.

It is interesting to compare the more recent method of sapping with that above described (fig. 67 taken from the *Instruction in Military Engineering*, 1896). It is no longer possible to place gabions in position at the sap-head under fire. Accordingly the leading sapper excavates to the full depth of 4 ft. 6 in., and the rate of progress is retarded proportionately, so that an advance of only 15 to 30 yds. in 24 hours can be reckoned on instead of 50. The head of the sap is protected by a number of half-filled sandbags, which the leading sapper throws forward as he goes on.

The nearer the approaches drew to the covered way, the more oblique became the zigzags, so that little forward progress was made in proportion to the length of the trench. The approaches were then carried straight to the front, by means of the "double sap," which consisted of two single saps worked together with a parapet on each side (fig. 68). To protect these from being enfiladed from the front, traverses had to be left

at intervals, usually by turning the two saps at right angles to right or left for a few feet, then forward, and so on as shown in fig. 69, the distance apart of these traverses being of course regulated by the height from which the enemy's fire commanded the trench.

The later stages in the attack are illustrated in fig. 70. From the third parallel the attack was pushed forward up the glacis by means of the double sap. It was then pushed right and left along the glacis, a little distance from the crest of the covered way. This was called "crowning" the covered way,

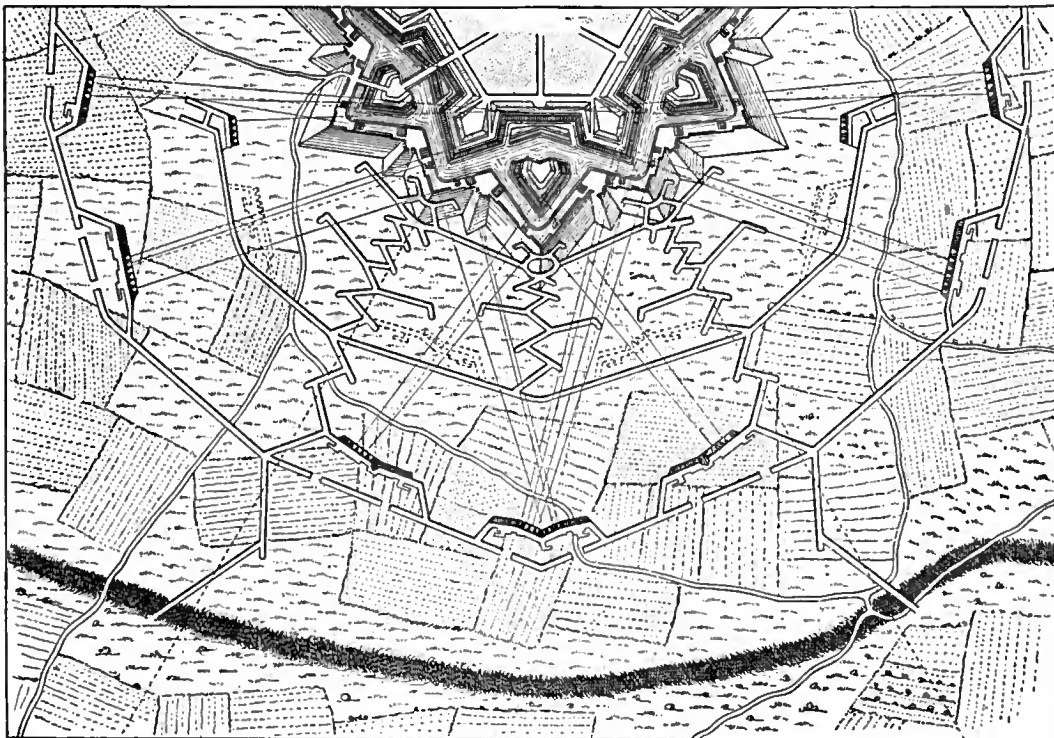

FIG. 65.—Regular Attack (Vauban).

so calculated that by daybreak the trench would afford a fair amount of cover. Flying trenchwork was generally used for the 2nd parallel and its approaches, and as far beyond it as possible. In proportion as the attack drew nearer to the covered way, the fire of the defenders' small-arms and wall-pieces naturally grew more effective, though by this time most of their artillery would have been dismantled by the fire of the siege batteries. It therefore became necessary before reaching the 3rd parallel to have recourse to sap.

Sapping required trained men. It consisted in gradually pushing forward the end of a narrow trench in the desired direction. At the sap-head was a squad of sappers. The leading man excavated-a

and on the position thus gained breaching batteries were established in full view of the escarp. While the escarp was being breached, if it was intended to use a systematic attack throughout, a mine gallery (see *Mining* below) was driven under the covered way and an opening made through the counterscarp into the ditch. The sap was then pushed across the ditch, and if necessary up the breach, the defenders' resistance being kept under by musketry and artillery fire from the covered way. The ravelin and bastions were thus captured successively, and where the bastions had been retrenched the same methods were used against the retrenchment.

Vauban showed how to breach the escarp with the least expenditure of ammunition. This was done by making, with successive shots placed close together (which was feasible even in those days from a position so close as the crest of the covered way) horizontal and vertical cuts through the revetment wall. The portion of revetment enclosed by the cuts being thus detached from support was overturned by the pressure of the

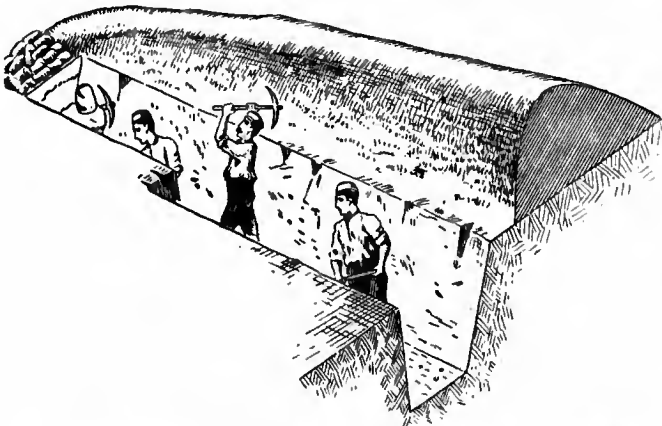

From *Military Engineering*, by permission of the Controller of H. M. Stationery Office.

FIG. 67.—“Deep” Sap.

earth from the rampart. Ricochet fire was also the invention of Vauban. He showed how, in enfilading the face of a work, by using greatly reduced charges a shot could be made to drop over the crest of the parapet and skim along the terreplein, dismounting guns and killing men as it went.

The constant success of Vauban must be ascribed to method and thorough organization. There was a deadly certainty about his system that gave rise to the saying “Place assiégée, place prise.” He left nothing to chance, and preferred as a rule the slow and certain progress of saps across the ditch and up the breach to the loss and delay that might follow an unsuccessful assault. His contemporary and nearest rival Coehoorn tried to shorten sieges by heavy artillery fire and attacks across the open; but in the long run his sieges were slower than Vauban's.

So much a matter of form did the attack become under these conditions, that in comparing the supposed defensive powers of different systems of fortification it was usual to calculate the number of days that would be required in each case before the breach was opened, the time being measured by the number of hours of work required for the construction of the various trenches and batteries. It began to be taken as a matter of course that no place under any circumstances could hold out more than a given number of days; and naturally, when the whole question had become one of formula, it is not surprising to find that places were very often surrendered without more than a perfunctory show of resistance.

The theory of defence at this time appeared to be that since it was impossible to arrest the now methodical and protected progress of the besiegers' trenches, no real resistance was possible until after they had reached the covered way, and this idea is at the root of the extraordinary complications of outworks and multiplied lines of ramparts that characterized the “systems” of this period. No doubt if a successor to Vauban could have

brought the same genius to bear on the actual defence of places as he did on the attack, he would have discovered that the essence of successful defence lay in offensive action outside the body of the place, viz. with trench against trench. For want of such a man the engineers of the defence resigned themselves contentedly to the loss of the open ground outside their walls, and relied either upon successive permanent lines of defence, or if these did not exist, upon extemporized retrenchments, usually at the gorge of the bastion.

It is curious that such experienced soldiers as most of them were should not have realized the fatal effect upon the minds of the defenders which this almost passive abandonment of line after line must needs produce. Even a civilian—Machiavelli—had seen into the truth of the matter years before when he said (*Treatise on the Art of War*, Book vii.): “And here I ought to give an advice . . . to those who are constructing a fortress, and that

is, not to establish within its circuit fortifications which may serve as a retreat to troops who have been driven back from the first line. . . . I maintain that there is no greater danger for a fortress than rear fortifications whither troops can retire in case of a reverse; for once the soldier knows that he has a secure retreat after he has abandoned the first post, he does in fact abandon it and so causes the loss of the entire fortress.”

It must, however, be remembered that in those days when soldiers were mostly of a separate or professional caste, the whole thing had become a matter of business. Fighting was so much regulated by the laws and customs of war that men thought nothing of giving up a place if, according to accepted opinion, the enemy had advanced so far that they could no longer hope to defend it successfully. Once this idea had set in it became hopeless to expect successful defences, save now and then when

some officer of very unusual resolution was in command. This is the real reason for the feeble resistance so often made by fortresses in the 17th and 18th centuries, which has been attributed to inherent weakness in fortifications.

Custom exacted that a commandant should not give up a place until there was an open breach or, perhaps, until he had stood at least one assault. Even Napoleon recognized this limitation of the powers of the defence when in the later years of his reign he was trying to impress upon his governors the importance of their charge. The limitation was perfectly unnecessary, for history at that time could have afforded plenty of instances of places that had been successfully defended for many months after breaches were opened, and assault after assault repulsed on the same breach. But the same soldiers of the 17th and 18th centuries who had created this artificial condition of affairs,

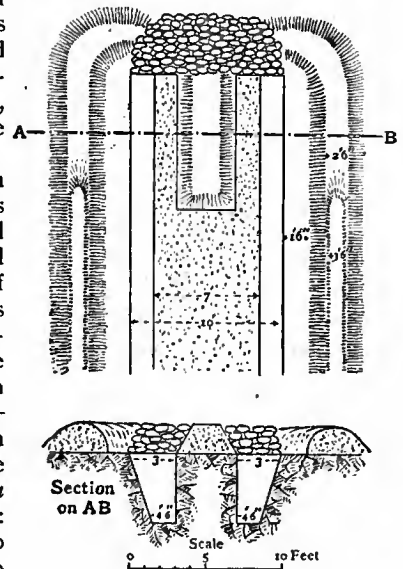

FIG. 68.—Double Sap.

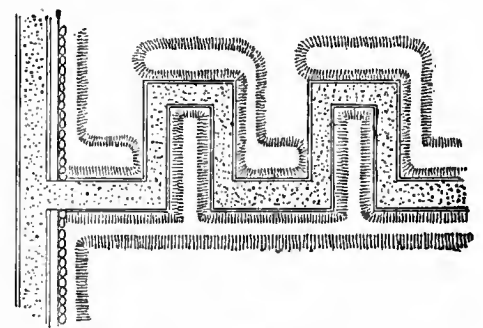

FIG. 69.—Direct advance by Double Sap.

established it by making it an understood thing that a garrison which surrendered without giving too much trouble after a breach had been opened should have honourable consideration; while if they put the besiegers to the pains of storming the breach, they were liable to be put to the sword.

It has been necessary to dwell at some length on the siegecraft of Vauban and his time, not merely for its historical interest,

but because the system he introduced was practically unaltered until the end of the 19th century. The

Peninsular War. sieges of the Peninsular War were conducted on his lines; so was that of Antwerp in 1830; and as far as the disposition of siege trenches was concerned, the same system remained in the Crimea, the Franco-German War and the Russo-Turkish War. The sieges in the Napoleonic wars were few, except in the Iberian peninsula. These last differed from those of the Vauban period and the 18th century in this, that instead of being deliberately undertaken with ample means, against fortresses that answered to the requirements of the time, they were attempted

at that time (*Journals of Sieges in Spain, 1811 to 1814*). Sir John Jones summarizes his own experience in Spain and the data accumulated by practical engineers in former sieges from the time of Vauban onwards, in the following conclusions: The actual work of entrenching, sapping, &c., on the front attacked was much the same whether the fortress contained 5000 or 10,000 men. On the other hand the guard of the trenches was proportionate to the fighting men inside the fortress. (The total number of men had of course to be sufficient to allow three or four complete shifts or "reliefs" for all work and duties.) Adding a proportion of men for camp and other duties, he calculates, for the vigorous siege of an ordinary place situated in open country and containing 5000 men, a corps of 32,080 effectives, and remarks further that this force would be greatly exhausted after a month's service. The same place held by 10,000 would call for a besieging army of 50,830 men (guards and duties increasing, but not working parties). Thus the besieger should if possible have a superiority of 7 to 1 if the garrison numbered 5000, 6 to 1 if 10,000 and 5 to 1 if 15,000 and so on. As regards artillery, he should have as many, and if possible twice as many, guns as those of the defender on the front of attack, as well as howitzers for sweeping every line subject to enfilade and mortars for destroying traverses, &c. Later in the siege, more howitzers and mortars to clear the

covered way and places of arms, and finally, after the covering of the covered way, fifty additional battering guns would be required. It is apparent from this that the practical engineers of the day looked upon a siege as a serious matter, and did not find permanent fortifications wanting in defensive strength.

During the long peace that followed the Napoleonic wars, one advance

was made in siegecraft. In England in 1824 successful experiments were carried out in breaching an unscen wall by curved or indirect fire from howitzers. At Antwerp in 1830 the increasing power and range of artillery, and especially of howitzers, were used for bombarding purposes, the breaches there being mostly made by mines. Then came one of the world's great sieges; that of Sevastopol in 1854-1855 (see CRIMEAN WAR). The outstanding lesson of Sevastopol is the value of an active defence;

Crimea.

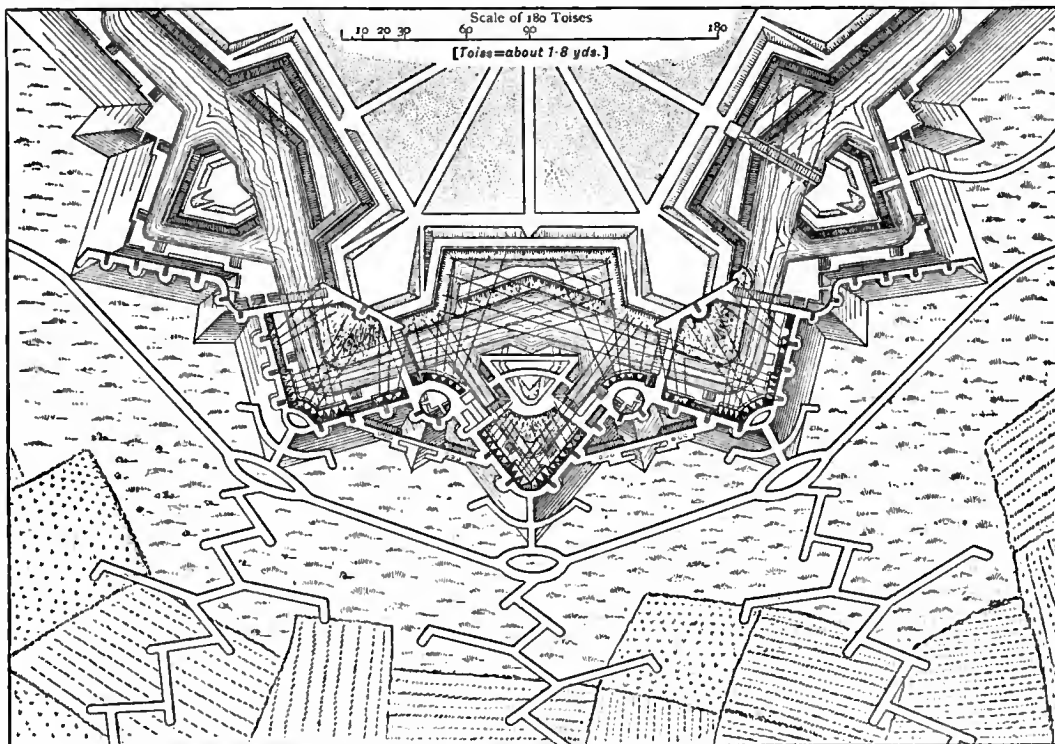

Fig. 70.—Later Stages of the Attack (Vauban).

with inadequate forces and materials, against out-of-date works. The fortresses that Wellington besieged in Spain had rudimentary outworks, and escarps that could be seen and breached from a distance. At that time, though the power of small arms had increased very slightly since the last century, there had been a distinct improvement in artillery, so that it was possible to breach a visible revetment at ranges from 500 to 1000 yds. Wellington was very badly off for engineers, siege artillery and material. Trench works could only be carried out on a small scale and slowly. Time being usually of great importance, as in the first two sieges of Badajoz, his technical advisers endeavoured to shorten sieges by breaching the escarp from a distance—a new departure—and launching assaults from trenches that had not reached the covered way. Under these circumstances the direct attacks on breaches failed several times, with great loss of life. Wellington in one or two earlier despatches reflected on his engineers for not establishing their batteries on the crest of the glacis. The failures are, however, clearly due to attempts to push sieges to a conclusion without proper preparation.

So much has been written of late years in criticism of the fortification to what may be called the Vauban period that it is important to note what were the preparations considered necessary for a siege

of going out to meet the besieger, with countertrench and countermine. This lesson has increased in value for us in proportion to the increased power of the rifle.

In comparing the resistance made behind the earthworks of Sevastopol with the recorded defences of permanent works, it is essential to remember that the conditions there were quite abnormal. Sir John Jones has told us what the relative forces of besiegers and besieged should be, and the necessary preponderance of artillery for the attack. The following quotations may be added:

"The siege corps should be sufficiently strong—(1) To invest the fortress completely, and maintain the investment against all the efforts of the garrison. (2) If a regular siege is contemplated, to execute and guard all the siege works required for it. Complete investment may sometimes be impossible, but experience has repeatedly shown that the difficulties of a siege are enormously increased if the garrison are able to draw fresh troops and supplies from outside, and to rid themselves of their sick and wounded" (Lewis). Again as regards artillery: "In a regular attack, where every point is gained inch by inch, it is impossible to succeed without overpowering the defensive artillery"; and "it is useless to attempt to sap near a place till its artillery fire is subdued . . ." (Jones).

These conditions were so far from being fulfilled at Sevastopol that (a) there was no investment—in fact the Russians came nearer to investing the Allies; (b) the Russians had the preponderance in guns almost throughout; (c) the Russian force in and about Sevastopol was numerically superior to that of the Allies. We must add to this that Todleben had been able to get rid of most of his

civilian population, and those who remained were chiefly dockyard workmen, able to give most valuable assistance on the defence works. The circumstances were therefore exceptionally favourable to an active defence. The weak point about the extemporized earthworks, which eventually led to the fall of the place, was the want of good bomb-proof cover near the parapets.

The Franco-German War of 1870 produced no great novelty. The Germans were not anxious to undertake siege operations when it could be avoided. In several cases minor fortresses surrendered after a slight bombardment. In others, after the bombardment failed, the Germans contented themselves with establishing a blockade or detaching a small observing force. By far the most interesting siege was that of Belfort (*q.v.*). Here Colonel Denfert-Rochereau employed the active defence so successfully by extemporizing detached redoubts and fortifying outlying villages, that he obliged the besiegers (who, however, were a small force at first) to take up an investing line 25 m. long; and succeeded in holding the village of Danjoutin, 2000 yds. in advance of the enceinte, for two months after the siege began. He also used indirect fire, withdrawing guns from the ramparts and placing them in the ditches, in the open spaces of the town, &c. At Paris the French found great advantage in placing batteries in inconspicuous positions outside the forts. Their direct fire guns were at a disadvantage in being fired through embrasures. These had served their purpose when artillery fire was very inaccurate, but had now for a long time been recognized by the best engineers as out of date. The Germans since the siege of Düppel in 1864 had mounted their siege guns on "overbank" carriages; that is, high carriages which made it possible to fire the guns over the parapet of the battery without embrasures. The guns in the Paris forts which were further handicapped by conspicuous parapets and the bad shooting of the gunners were easily silenced.

At Strassburg indirect fire against escarpments was used. The escarp of Lunette 53 was successfully breached by this method. The breaching battery was 870 yds. distant, and the shot struck the face of the wall at an angle (horizontally) of 55° , the effect being observed and reported from the counterscarp. 1000 rounds from 60-pounder guns sufficed to make a breach 30 yds. wide.

Fig. 71 is a good example of the attack in the late stages. It will be observed that batteries for mortars and field guns are established in the captured lunettes. The narrow wet ditch of Lunette 53 was crossed by a dam of earth and fascines, the headway protected by a parapet or screen of sandbags.

"Lunette 52 was unrevetted, and its ditch was more than 60 yds. wide, and 6 to 9 ft. deep. . . . It was determined to effect the passage by a cask bridge, for which the casks were furnished by breweries near at hand. . . . The formation of the bridge was begun at nightfall. A pioneer swam across, hauled over a cable, and made it fast to the hedge on the berm. Four men were stationed in the water, close to the covered way, the casks were rolled down to them one after the other, and fitted with saddles, so as to form piers. . . . these piers were successively boomed out along the line of the cable. . . . In two hours the bridge was finished, and the lunette was entered. . . . The work had not been discovered by the besieged, and the formation of lodgments inside the lunette was already begun, when the noise made by some troops in passing the bridge attracted attention, and drew a fire which cost the besiegers about 50 men. A dam was afterwards substituted for the bridge, as it was repeatedly struck by shells." (*R.E. Professional Papers*, vol. xix.)

It is curious to realize that this happened at so recent a time. Such operations would be impossible now, as long as any defending guns remained in action.

On the whole it may be said that siegecraft gained practically nothing from the Franco-German War. The Russo-Turkish war taught less, Plevna (*q.v.*) having been defended by field works and attacked by the old-fashioned methods. For the last ten years of the 19th century military opinion was quite at a loss as to how the sieges of the future would work out. As guns and projectiles continued to improve the "attaque brusquée" proposed by von Sauer had many adherents. It was thought that a heavy bombardment would paralyse resistance and open the way for an attack, to be delivered by great numbers and with special appliances for crossing obstacles. Others thought that the strength of the defence, as manifested by the Plevna field works,

would be greater than ever when the field works were backed by permanent works, good communications and the resources of a fortress. One thing was obvious—namely, that as long as the artillery of the place, of even the smallest calibres, remained unsubdued, the difficulty of trenchwork and sapping would be enormously increased, and no one seemed to have formed a clear conception of how that difficulty was to be met. A lecture delivered in Germany about 1895 is worth quoting as a fair example of the vagueness of idea then prevailing: "For the attack, the following is the actual procedure: Accumulation and preparation of material for attack before the fortress: advance of attacking artillery, covered by infantry. Artillery duel. Throwing forward of infantry: destruction of the capability for defence of the position attacked; when possible by long-

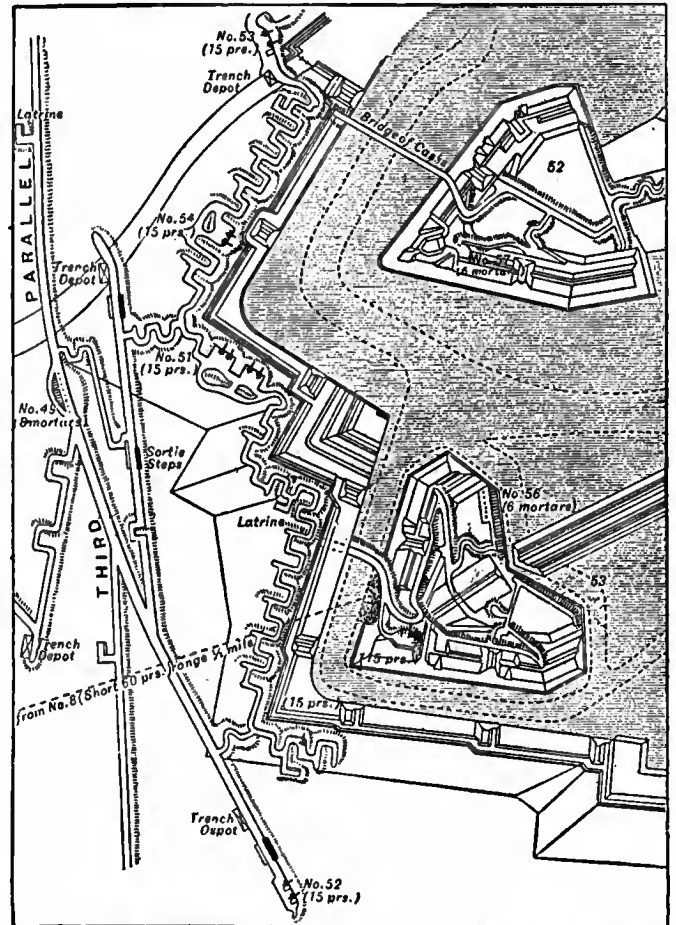

From *Textbook of Fortification*, by permission of the Controller H.M. Stationery Office.

FIG. 71.—Strassburg, Lunettes 52 and 53, 1870.

range artillery fire, otherwise by the aid of the engineers. Occupation of the defensive position. Assault on the inner lines of the fortress." That seemed quite a simple prescription, but the necessary drugs were wanting. And even since Port Arthur great uncertainty as to the future of the attack remains.

Modern artillery has much simplified the construction of siege batteries. Formerly siege batteries and rampart batteries opposed each other with direct fire at ranges not too long for the unaided human eye, and the shells, travelling with low velocity, bit into the parapets, and, exploding, produced their full effect. Accordingly the task of the gunners was, by accurate fire, to destroy the parapets and embrasures, and to dismount the guns. The parapets of siege batteries were therefore made from 18 to 30 ft. thick, and the construction of such batteries, with traverses, &c., involved much work. The height of parapet necessary for proper protection being 7 ft. 6 in. to 8 ft., a great deal of labour could be saved by sinking the gun-platforms about 4 ft. below the surface level, but of course this was only possible where rock or water were not near the surface.

The effect of modern projectiles was to reduce the thickness of earth necessary for parapets. High velocity projectiles are very easily deflected upwards by even a slight bank of earth. This is

Modern
siege war-
fare.

especially the case with sand. Loose earth is better than compacted earth, and clay offers the least resistance to penetration. These facts were taken note of in England more than on the Continent in the design of instructional siege batteries.

The construction of batteries is moreover vastly simplified by the long ranges at which artillery will fight in future. It will as a rule be possible to place howitzer batteries in such positions that even from balloons it will be difficult to locate them; and even direct fire batteries can easily be screened from view. This renders parapets unnecessary, and probably no more protection will be used than light splinter-proof screens to stop shrapnel bullets or fragments of common shell. Moreover batteries can be constructed at leisure and by daylight.

The most important point about the modern battery is the gun platform for the larger natures of guns and howitzers. These require very solid construction to resist the heavy shock of discharge. Not long ago it was thought that the defence would have larger ordnance than the attack, as anything heavier than an 8 in. howitzer required a concrete bed, which could not be made at short notice. The Japanese, however, at Port Arthur made concrete platforms for 11 in. howitzers. It may be remarked that difficulties which loom largely in peace are often overcome easily enough under the stress of war.

Another gain to the attack is in connexion with magazines. The old powder magazines were particularly dangerous adjuncts to batteries, and had to be very carefully bomb-proofed. Such propellants as cordite, however, are comparatively harmless in the open. They are very difficult to detonate, and if set on fire do not explode like gunpowder. It is therefore unnecessary to provide bomb-proof magazines for them in connexion with the batteries.

In future sieges the question of supply will be more important than it has ever been. Leaving out of the question the bringing up of supplies from the base of operations, the task of distribution at the front is a very large one. The Paris siege manoeuvres of 1894 furnish some instructive data on this point. The main siege park was at Meaux, 10 m. from the 1st artillery position, and the average distance from the 1st artillery position to the principal fort attacked was 5000 yds. The front of attack on Fort Vaujours and its collateral batteries covered 10,000 yds. There were 24 batteries in the 1st artillery position; say 100 guns, spread over a front of 4000 yds. To connect Meaux with the front, the French laid some 30 m. of narrow gauge railway largely along existing roads. The line was single, with numerous branches and sidings. They ran 11 regular trains to the front daily and half-a-dozen supplementary. The amount of artillery material sent up was over 5000 tons, without any projectiles; but it can easily be imagined that large demands were also made on transport for other purposes. For instance, one complete bakery train was sent up daily. The amount of ammunition sent up would be limited only by the power of transporting it. A siege train of 100 pieces could probably dispose of from 500 to 1000 tons of ammunition a day, at the maximum rate of firing.

But the most important question affecting the sieges of the future (putting aside accidental circumstances) will be the configuration of the ground. Assuming that local conditions do not specially favour the artillery of either side, it is highly probable that the artillery duel will result in a deadlock. If the besiegers' guns do not succeed in silencing those of the defence from the 1st or distant artillery position (which, whether they are in cupolas or in concealed positions, will in any case be an extremely difficult task), it will be necessary for the infantry to press in; to feel for weak points, and to fight for those that offer better positions for fire and observation. In doing this they will have to face the defenders' infantry, entrenched, backed by their unsilenced guns, and having secure places of assembly from which to deliver counter-attacks. The distance to which they can work forward and establish themselves under these conditions will depend on the ground. It will then be for the engineers to cross the remaining space by sap. This, under present conditions, will be a tedious process, and may even take long enough to cause the failure of the siege.

As to the manner of the sap, it will certainly be "deep," as long as the defence retains any artillery power. When the 4 ft. 6 in. sap already described was first introduced, it was known as a "deep sap"; but the sieges of the future will probably necessitate a true deep sap, that is one in which the whole of the necessary cover is got below the surface of the earth.

Such a sap may consist of an open trench, about 6 ft. deep, the whole of the excavated earth being carried away through the trench to the rear; or a blinded trench, covered in as it progresses by splinter-proof timbers and earth; or a tunnelled trench, leaving a foot or so of surface earth undisturbed. In either case nothing should be visible from the front to attract artillery fire. As the sap is completed, it will sometimes be necessary to add a slight parapet in places, to give command over the foreground for the rifles of the guard of the trenches.

The sap will have to be pushed up quite close to the defenders' trenches and obstacles. After that further progress must either be made by mining, or as seems very probable, by getting the better of the defenders in a contest with shells from short-range mortars.

Just as in the feudal ages a castle was built on some solitary eminence which lent itself to the defensive methods of the time, so in the future the detached forts and supporting points in the girdle

of a fortress will be sited where smooth and gentle slopes of ground give the utmost opportunity to the defenders' fire, and the least chance of concealment to the enemy. There will be considerable latitude of choice in the defensive positions; though not, of course, the same latitude as when the existence of a precipitous hill was the *raison d'être* of the castle. In some places, as at Port Arthur, the whole country-side may by reason of its steep and broken slopes be unfavourable to the defence, though even then genius will turn the difficulties to account. But wherever it is possible the defender will provide for a space of 1000 yds. or so, swept by fire and illuminated by searchlights, in front of his lines. That space will have to be crossed by sap, and it needs little imagination to realize how great the task will be for the besieger.

There are other modern methods of siege warfare to be noticed, the use of which is common to besiegers and besieged. Much is expected of balloons; but the use of these in war is unlikely to correspond to peace expectations. They must be kept at a considerable distance from the enemy's guns, a distance which will increase as the means of range-finding improve; and as the height from which they can observe usefully is limited, so is the observers' power to search out hidden objects behind vertical screens. Thus, suppose a captive balloon at a height of 2000 ft., and distant 4000 yds. from an enemy's howitzer battery: and suppose the battery placed behind a steep hill-side or a grove of trees, at such a distance that a shell fired with 30° elevation can just clear this screen. The line of sight from the observer to the battery is inclined to the horizontal at $\frac{2000}{3 \times 4000}$, that is $\frac{1}{6}$, or roughly 10°. It is obvious, therefore, that the observer cannot see the battery.

Balloon observers are expected to assist the batteries by marking the effects of their fire. For this to be done on any practical scale a balloon would be required for each battery: that is, for only 100 guns, some 20 or 25 balloons. These would require an equal number of highly skilled observers (of whom there are not too many in existence), besides the other balloon personnel and accessories, and the means of making gas, which is too much to expect, even if an enemy were obliging enough to give notice of his intentions.

Telephones and all other means of transmitting intelligence rapidly are now of the utmost importance to both attack and defence. Maps marked with numbered squares are necessary for directing artillery fire, especially from cupolas. Organization in every branch will give better results than ever before, and the question of communication and transport from the base of supplies right up to the front needs detailed study, in view of the great weight of ammunition and supplies that will have to be handled.

The use of light mortars for the trenches, introduced by Coehoorn and revived with extemporized means at Port Arthur, needs great attention. It may be prophesied that the issue of important sieges in the future, when skilfully conducted on both sides with sufficient resources, will depend mainly on the energy of the defenders in trench work, on mining and countermining in connexion with the trenches, and on the use of light mortars made to throw large charges of high explosive for short distances with great accuracy.

For a brief narrative of the siege of Port Arthur in 1904, one of the greatest sieges of history, both as regards its epic interest and its military importance, the reader is referred to the article *RUSSO-JAPANESE WAR*.

DEFINITIONS.—The following definitions may be useful, but have no place in the evolution of the attack, to which this section is mainly devoted.

Investment.—This most necessary, almost indispensable operation of every siege consists in surrounding the fortress about to be besieged, so as to cut off its communications with the outside world. **Preliminary investment** which is carried out by cavalry and light troops before the arrival of the besieging force, consists in closing the roads so as to shut out supplies and reinforcements. **Close investment** should be of such a character as to prevent any sort of communication, even by single messengers or spies. The term "**blockade**" is sometimes loosely used instead of investment.

Lines of Circumvallation and Contravallation.—These now obsolete terms were in great use until the 19th century. The **circumvallation** was a line of parapet which the besieger made outside the investing position of his own force, to protect it when there was a chance of attack by a relieving army. The line of **contravallation** was the line of parapet and trench sometimes made by the besieger all round the town he was attacking, to check the sorties of the garrison.

Observing Force.—When circumstances make the reduction of a particular fortress in the theatre of operations unnecessary a force is often detached to "observe" it. The duty of this force will be to watch the garrison and prevent any hostile action such as raids on the lines of communications.

Bombardment.—This operation, common to all ages, consists in a general (sometimes an indiscriminate) fire against either the whole target offered by the fortress or a particular section of that target. In ancient and medieval times the effect of a bombardment—whether of ordinary missiles, of incendiary projectiles, or of poisonous matters tending to breed pestilence—upon a population closely crowded within its walls was very powerful. In the present day little military importance is attached to bombardment, since under modern conditions it cannot do much real harm.

IV. MILITARY MINING

It has been noted already that mining is one of the most ancient resources of siege warfare. The use of gunpowder in mining operations dates from the end of the 15th century. When Shakespeare makes Fluellen say, at Henry V.'s siege of Harfleur, "th'athversary is digt himself four yards under the countermines; I think 'a will plow up all, if there is not better directions," he is anticipating the development of siegecraft by nearly 100 years. Pedro di Navarro, a Spanish officer, is credited with the first practical use of explosive mines. He employed them with great success at the siege of Naples in 1503; and afterwards, when rebuilding the Castello Nuovo after the siege, was probably the first to make permanent provision for their use in countermines. Countermining had been a measure of defence against the earlier methods of attack-mining; the object being to break into the besiegers' galleries and fight hand to hand for the possession of them. When the explosive mine was introduced, it became the object of the defenders to establish their countermines near the besiegers' galleries and destroy them by the effect of the explosion. In the 400 years or so that have passed this branch of warfare has changed less than any other. Methods of mining have not advanced much, and the increased power of high explosives as compared with gunpowder has its least advantage in moving masses of earth.

When a besieger has arrived by means of trenches within a certain distance of the enemy's works without having subdued their fire, he may find that the advance by sap becomes too slow and too dangerous. He can then advance underground by means of mine galleries, and by exploding large charges at the heads of these galleries can make a series of craters. These craters are then occupied by infantry, and are connected with each other and with the parallel in rear by trenches, thus forming a new parallel. If not interfered with by the defenders the besieger can advance in this way until he reaches the counterscarp. His mines will now be turned to a new purpose, viz. to breach the counterscarp and afterwards the escarp. This is done by placing suitable charges at intervals behind the scarps at such a height above the foundations that the pressure of the earth above the mine will more than counterbalance the resistance of the masonry.

But if the defenders are active, they will countermine. There is as a general rule this broad difference between the mines of the defence and those of the attack, that the defenders do not wish the surface of the ground broken, lest increased opportunities of getting cover should be offered to the besiegers. The object of the defence, therefore, is to destroy the besiegers' galleries without forming craters, and for this purpose they generally endeavour to get underneath the attack galleries. The defenders may, however, wish, if the opportunity is allowed them, to explode mines under the attack parallels, in which case there is of course no objection to disturbing the surface.

"At the commencement of the subterranean war the main object of the defence is to force the besieger to take to mining operations as early as possible, as it is a tedious operation and will prolong the siege. Every endeavour must be made to push forward countermines so as to meet and check the attack. On the approach of the opponents to each other careful listening for the enemy must be resorted to. To this end it is necessary at irregular intervals to suspend all work for some minutes at a time, closing doors of communication and employing experienced listeners at the heads of the countermines. This matter is a most important one, as a premature explosion of the defender's mines is a double loss to the defender, a loss of a mine and an advantage to the enemy in more than one way. As soon as the overcharged mines of the besieger have been fired, a heavy fire should be brought to bear on the craters, and if possible sorties should be made to prevent the enemy occupying them. At the same time every effort should be made underground to surround with galleries, and as it were isolate, the craters so as to prevent the besieger making a new advance from them. The efforts of the attack at this stage will probably be directed to the formation of what are called "Boule shafts" (i.e. shafts partially lined in which charges are hastily fired with little or no tamping), and to meet these in time the defender may resort to the use of boring tools, and so place charges somewhere in advance of the heads of the counter-

mines. His great object must be to prevent as long as possible the besieger from getting underground again; and these occasions, when the power of resistance is temporarily equal to, if not greater than, that of the attack, should be made the most of by the defence." (Lewis, *Text-book on Fortification, &c.*, 1893.)

The defence has the advantage, in the case of fortresses, of being able to establish beforehand a system of countermine galleries in masonry. Many systems have been worked out for this purpose. A good typical arrangement is that of General Marescot, published in 1799, shown in fig. 72

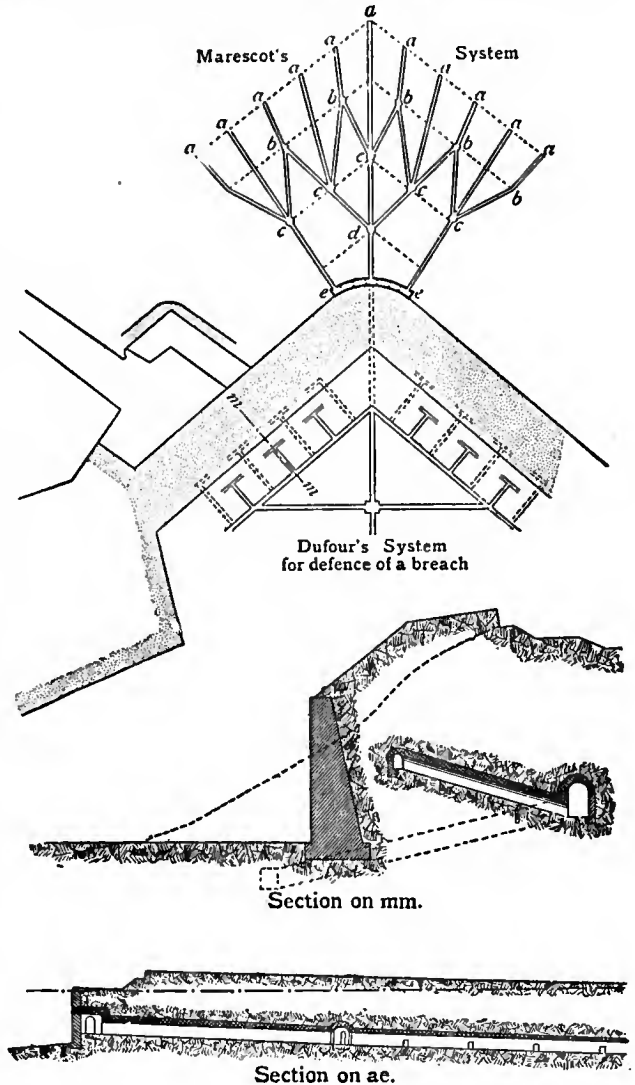

From *Textbook of Fortification*, by permission of the Controller H.M. Stationery Office.

FIG. 72.

The main galleries (those running out in a straight line from the counterscarp gallery *e* to three of the points *a*) fall gently to the front to a depth of 30 or 40 ft. below the surface—the deeper they are the less they will suffer from the enemy's mines. Branch galleries (marked *c b + d c*) run obliquely upward from them to right and to left, leading to the mines, which are placed at various depths, according to circumstances.

Two main points must be observed in any system of countermines: the branch galleries must run obliquely forward, so as not to present their sides to the action of the enemy's mines; and the distance between the ends of the branches from adjacent main galleries should be such that the enemy cannot pass between them unheard. This distance will vary with the nature of the soil, but may be taken roughly as 20 yds. A convenient size for main galleries is 6 ft. high by 3 ft. wide: branch galleries may be 5 ft. by 3 ft. When the enemy is approaching, other branch galleries, called *listeners*, will be pushed out from main

and branch galleries. The section to fig. 1 of fig. 72 shows openings left for the purpose.

Another use of mines in defence is in connexion with breaches. A permanent arrangement for this purpose, by General Dufour, is shown in fig. 72. Yet another use, on which much ingenuity was expended in the 18th century, is to extemporize retrenchments.

The charges of mines depend of course upon the effect which is desired. When the charge is strong enough to produce a crater, the radius of the circular opening on the surface of the ground is called the *radius of the crater*. The line drawn from the centre of the charge to the nearest surface, which is expressed in feet, is called the *line of least resistance* (L.L.R.). When a mine produces a crater the diameter of which is equal to the line of least resistance, it is called a *one-lined crater*; when the diameter is double the L.L.R., a *two-lined crater* and so on. *Common mines* are those which produce a two-lined crater. *Over-charged mines* produce craters greater than two-lined, and *undercharged mines* less. A *camouflet* does not produce a crater; it is used when the object is to destroy an enemy's gallery without breaking the surface. Fig. 73 shows sections of the different kinds of mines, with their

Different kinds of mines.

of least resistance (L.L.R.). When a mine produces a crater the diameter of which is equal to the line of least resistance, it is called a one-lined crater; when the diameter is double the L.L.R., a two-lined crater and so on. Common mines are those which produce a two-lined crater. Over-charged mines produce craters greater than two-lined, and undercharged mines less. A camouflet does not produce a crater; it is used when the object is to destroy an enemy's gallery without breaking the surface. Fig. 73 shows sections of the different kinds of mines, with their

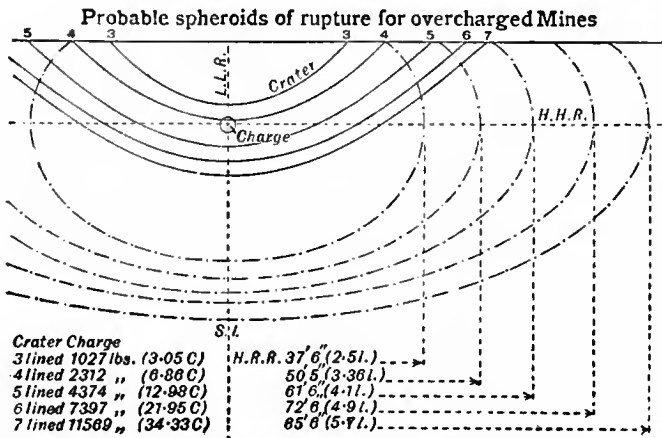
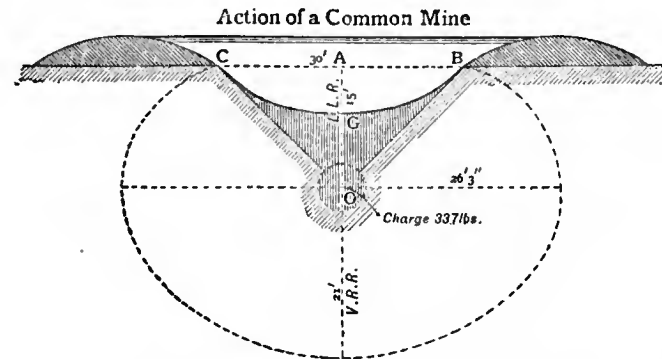

From *Instructions in Military Engineering*, by permission of the Controller of H.M. Stationery Office.

FIG. 73.—Mines.

craters and the effect they will produce downwards and horizontally in ordinary earth.

Consideration of this figure will show that it is possible to place a long charge at such a depth below the surface that it will destroy all galleries of the enemy within a considerable radius, without much disturbing the surface of the ground.

Bored mines, which have been alluded to above, are a comparatively recent innovation. When the enemy is heard at work in one of his galleries and his position approximately determined by the sound, it is necessary to drive a branch gallery with all speed in that direction, and when it has advanced as far as appears necessary, to load, tamp and discharge a mine before the enemy can fire his own mine. This is one of the most delicate and dangerous operations of war, and success will fall to those who are at the same time most skilful and most determined. The work can be hastened and made

less dangerous as follows: Instead of driving a branch gallery, a hole several inches in diameter is bored in the required direction. With suitable tools there is no difficulty in driving a straight bore hole 20 or 30 ft. long. A small charge of high explosives is then pushed up to the end of the borehole and fired. This forms a small camouflet chamber by compressing the earth around it. Into this chamber the charge for the mine is passed up the bore-hole. No tamping of course is required.

Mine warfare is slow, dangerous and uncertain in its results. It will certainly delay the besiegers' advance very much and may do so indefinitely. One point is distinctly in favour of the defence, namely that when ground has been much mined it becomes charged with poisonous gases. Some explosives are less noxious than others in this way, and it will be advantageous for the attack, but not necessarily for the defence, to make use of these.

Calculation of Charges.—The quantity of powder required for a charge is expressed in lbs. in terms of L.L.R.³, and the following formulæ are used:

l = L.L.R. in feet, r = radius of crater in feet, c = powder charge in pounds, s = a variable dependent on the nature of the soil.

For a common mine $c = \frac{s}{10} l^3$

For an overcharged mine $c = \frac{s}{10} \{l + .9(r-l)\}^3$

For an undercharged mine $c = \frac{s}{10} \{l - .9(l-r)\}^3$

The values to be given to s are:

Nature of Soil.	Value of s .
Very light earth	0.80
Common earth	1.00
Hard sand	1.25
Earth mixed with stones.	1.40
Clay mixed with loam	1.55
Inferior brickwork	1.66
Rock or good new brickwork.	2.25
Very good old brickwork	2.50

Military mining is carried on by means of vertical *shafts* and horizontal or inclined *galleries*. When the soil is very stiff, very little or even no lining is required for shafts and galleries; but usually they have to be lined either with cases or frames.

Cases make a complete lining of 2 in. planking. Frames are used at intervals of 4 or 5 ft. to support a partial lining of planks. Cases are of course preferable in other respects; but in ordinary soil they take up more timber.

There are two kinds of gallery in ordinary use in the British service, namely the *common gallery* whose interior dimensions with cases are 5 ft. 6 in. x 2 ft., and the *branch gallery* which is 4 ft. x 2 ft. The *shaft* has about the same dimensions as a branch gallery. Formerly it was sometimes necessary in the systematic attack of a fortress to get guns down into the ditch. For this purpose a "great gallery" was used, 6 ft. 6 in. in height and 6 ft. 8 in. wide, internal dimensions.

Miners' Tools.—These are few and simple. The pick and shovel differ from the ordinary types in having rather shorter helves suitable for the confined space in which they are used. There is also a *push-pick*, an implement with a straight helve and a pointed shovel head 6 in. long and 3½ in. wide. The *miner's truck*, used for drawing the earth from the end of the gallery to the bottom of the shaft, is a small wooden truck holding about 2 cub. ft. of earth. Formerly the noise of the wheels of the truck passing over the uneven wooden floor of the gallery was very liable to be heard by the enemy. To obviate this they now have leather tyres and should run on battens nailed to the floor. The *miner's bucket* is a small canvas bucket with a couple of ropes attached, by which the earth can be drawn up the shaft. Nowadays, however, the truck itself has chains attached to it, by which it is drawn up, with the aid of a windlass, to the surface. By this method more earth can be taken up in one lift, and time and labour are not wasted in transferring the contents of the truck to the bucket.

Ventilation is an important point. The breath of the miners and the burning of their candles (when electric light is not available) vitiates the air in the galleries; so that even in clean ground a gallery should not be driven more than 60 ft. without providing some means of renewing the air. This is usually done by forcing fresh air, by means of a pump or bellows, through a flexible hose to the head of the gallery. Where mines have been fired close by, there is great danger from poisonous gases filtering through the soil into the gallery. This difficulty is nowadays met by the use of special apparatus, such as helmets into which fresh air is pumped, so that the wearers need not breathe the air of the gallery at all. Ventilation can also be assisted by boring holes vertically to the surface of the ground.

Where a point has been reached at which it is proposed to fire a mine, a chamber just large enough to hold the charge is cut in the

side of the gallery. The object of this is to keep the charge out of the direct line of the gallery and thus increase the force of the explosion. The charge may be placed in canvas bags, barrels or boxes, precautions being taken against damp.

The operation of loading is of the first importance, for if the mine is not exploded with success, not only is valuable time lost, which may give the enemy his opportunity, but it will probably be necessary to untamp the mine in order to renew the fuze; an operation attended by considerable danger. The loading of the mine should therefore be done by the officer in charge with his own hands. He has to work in a very cramped position and practically in the dark (unless with electric light) as of course no naked lights can be allowed near powder. Everything should therefore be prepared beforehand to facilitate the loading of the mine and placing of the fuze. At Chatham a 1000 lb mine, at the end of a gallery 136 ft. long, has been loaded in 30 minutes. The powder was passed up the gallery by hand in sandbags, and emptied into a box of the required size.

Whatever method of firing (see below) is employed, the officer who loads the mine must be careful to see that it is so arranged as to make firing certain, and that the leads passing out of the gallery are not liable to damage in the process of tamping.

Tamping.—This operation consists in filling up the head of the gallery solidly, for such a distance that there shall be no possibility of the charge wasting its force along the gallery. The distance depends on the charge and on the solidity of the tamping. For a common mine it should extend to about $\frac{1}{3}$ L.L.R. from the charge, when the tamping is of earth in sandbags; for a 3-lined crater, to about 2 L.L.R. Tamping can be improved by jamming pieces of timber across the shaft or gallery among the other filling.

Firing.—This may be done electrically, or by means of *safety* or *instantaneous fuze* or *powder hose*.

Electric firing is the safest and best, and allows of the charge being exploded at any given moment. For this purpose *electric fuzes* (for powder) or *electric detonators* (for guncotton or other high explosive) are employed. The current that fires them is passed through copper wire leads.

The safety fuze used in the British service burns at the rate of about 3 ft. a minute. Instantaneous fuze burns at the rate of a mile a minute. Both can be fired under water. They are often used in conjunction, a considerable length of instantaneous fuze, leading from the charge, being connected to a short length of safety fuze.

Powder hose, an old-time expedient, can be extemporized by making a tube of strong linen, say 1 in. in diameter, and filling it with powder. It burns at the rate of 10 to 20 ft. per second.

Explosives.—The old-fashioned gunpowder of the grained black variety is still the best for most kinds of military mines. Pebble and prism powders do not give as good results, presumably because their action is so slow that some of the gases of explosion can escape through the pores of the earth. High explosives, with their quick shattering and rending effect, are little more effective than gunpowder in actually moving large quantities of earth. Most of them give off much more poisonous fumes than gunpowder. Some recent high explosives, however, have been specially designed to be comparatively innocuous in this respect.

Some formulæ have been given above for the calculation of charges. It will, however, simplify matters for the reader to record some actual instances of charges fired both in peace and war.

In the matter of scientific experiment we find Vauban as usual leading the way, and the following results among others were obtained by him at Tournay in 1686 and 1689: A charge of 162 lb placed 13 ft. below the surface produced a crater of 13 ft. radius (a two-lined crater, or "common mine"). Galleries were destroyed at distances equal to the L.L.R. in both horizontal and vertical directions. Double the charge, placed at double the depth, *i.e.* 324 lb with an L.L.R. of 27 ft. made no crater, but like the first destroyed galleries below it and on each side at distances equal to the L.L.R. A charge of 3828 lb with L.L.R. of 37 ft. made a two-lined crater and destroyed a gallery distant 61 ft. horizontally.

Bernard Forest de Belidor, a French engineer, made many experiments at La Fère about 1732, and 20 years later, as a general officer and inspector of miners, continued them on a larger scale. His experiments were directed towards destroying an enemy's galleries at greater distances than had hitherto been supposed possible, by means of very large charges (in proportion to the L.L.R.) which he called "globes of compression." In one of them a charge of 4320 lb of powder placed only 15 ft. 9 in. below the surface damaged or "compressed" a gallery distant 65 ft. horizontally. The radius of the crater was 34 ft. 8 in.

At Frederick the Great's siege of Schweidnitz in 1762 some very large charges were exploded. One of them, of 5400 lb with an L.L.R. of 16 ft. 3 in., made a crater of 42 ft. 3 in. radius. Readers of Carlyle's *Frederick the Great* may recall his description of the contest of the rival engineers on this occasion.

At Graudenz in 1862 (experiments) a charge of 1031 lb of powder placed 10 ft. deep, untamped, in a vertical shaft, made a crater of 15 ft. 6 in. radius. A charge of 412 lb of guncotton, calculated as

being equivalent to the above charge of powder and placed under the same conditions, made a crater of 14 ft. radius. The absence of tamping in both cases of course placed the gunpowder at a disadvantage.

Perhaps the most interesting mine ever fired was that at the siege of Petersburg in the American Civil War, in June 1864. The circumstances were all abnormal, and the untechnical account of it in *Battles and Leaders of the Civil War* (vol. iv.) is well worth perusal. No mining tools or materials and no military miners were available; and no one had any confidence in the success of the attempt except its originator, Lieut.-Colonel Pleasants, a mining engineer by profession, his regiment which was recruited from a mining population, and General Burnside the corps commander. The opposing entrenchments were 130 yds. apart. The mine gallery was started behind the Federal lines and driven a distance of 510 ft. till it came under a field redoubt in the Confederate lines. There two branches were made right and left, each about 38 ft. long, and in them eight mines aggregating 8000 lb of powder were placed. The first attempt to fire them failed, and an officer and a sergeant volunteered to enter the gallery to seek the cause of the failure. A defective splice in two lengths of fuze was thus discovered and repaired. At the second attempt all the mines were fired simultaneously with success, and made a gigantic crater 170 ft. long by 60 ft. wide and 30 ft. deep. The occupants of the redoubt, at least several hundred men (they have been stated at 1000), were blown up and mostly killed. The assault which followed, however, failed completely, for want of organization. The infantry was drawn up in readiness to advance, but no outlets had been provided from the parallel, and this and other causes delayed the occupation of the crater and gave the defending artillery a moment's respite. Thus the assailants gained the crater but could not advance beyond it in face of the defenders' fire, nor could they establish themselves within it, on its steep clay sides, for want of entrenching tools. A good many troops were sent forwards in support, but being in many cases of inferior quality, they could not be induced to go forward, and huddled in disorder in the already overcrowded crater. Over 1000 of these were captured when the Confederates retook the crater by a counter-attack and the total loss of the Federals in the attack was nearly 4000.

The wars of the last generation have done little or nothing to advance the science of military mining, but a good deal has been done in peace to improve the means. Electric lighting and electric firing of mines will be a great help; modern drilling machines may be used to go through rock; ventilating arrangements are much improved; and the use of bored mines is sure to have great developments. The Russo-Japanese War taught nothing new in mine-warfare, or as to the effects of mines, but the siege of Port Arthur had this moral among others; just as in future, in the frontal attack of positions, trench must oppose trench, so in fortress warfare mines will be more necessary than ever. It appears that they will be essential to destroy both the ditch-flanking arrangements of forts and the escarp or other permanent obstacle beyond the ditch.

V. FIELD FORTIFICATION

Field Fortifications, now more often spoken of as field defences, are those which are constructed at short notice, with the means locally available, usually when the enemy is near at hand. Subject to the question of time, a very high degree of strength can be given to them, if the military situation makes it worth while to expend sufficient labour. A century or more ago, the dividing line between permanent and field fortification was very rigidly drawn, since in those days a high masonry escarp surmounted by a rampart was essential to a permanent fortress, and these could naturally not be extemporized. Works without masonry, in other ways made as strong as possible with deep ditches and heavy timbers,—such as would require about six weeks for their construction—were known as *semi-permanent*, and were used for the defence of places which acquired strategic importance in the course of a war, but were not immediately threatened. The term *field fortification* was reserved for works constructed of lighter materials, with parapets and ditches of only moderate development. Redoubts of this class required a fortnight at most for their construction.

In modern fortification if cupolas and deep revetted ditches were essential to permanent defences, the dividing line would be equally clear. But as has been shown, this is not universally admitted, and where the resources exist, the use of our present

The Petersburg Mine, 1864.

means of construction, such as steel joists, railway rails, reinforced concrete and wire, in conjunction with the defensive power of modern fire-arms, makes it possible to extemporize in a very short time works having much of the resisting power of a permanent fortress. Further, such works can be expanded from the smallest beginnings; and, if the site is not too exposed, in the presence of the enemy.

Field fortification offers, as regards the actual constructions, a very limited scope to the engineer; and a little consideration will show that its defensive possibilities were not greatly affected by the change from machine-thrown projectiles to those fired by rude smooth-bore guns. There is therefore nothing in the history of this branch of the subject that is worth tracing, from the earliest ages to about the end of the 18th century. One or two points may be noticed. The use of obstacles is probably one of the earliest measures of defence. Long before missile weapons had acquired such an importance as to make it worth while to seek shelter from them, it would obviously have been found desirable to have some means of checking the onrush of an enemy physically or numerically superior. Hence the use by savage tribes, to this day, of pits, pointed stakes hidden in the grass, entanglements and similar obstacles. In this direction the ages have made no change, and the most highly civilized nations still use the same obstacles on occasion.

Another use of field defences common to all ages is the protection of camps at night, where small forces are operating against an enemy more numerous but inferior in arms and discipline. In daylight such an enemy is not feared, but at night his numbers might be dangerous. Hence the Roman practice of making each foot-soldier carry a couple of stakes for palisades; and the simple defence of a thorn zariba used by the British for their camps in the Sudan.

Palisades and trenches, abatis and sharpened stakes have always been used. Except wire, there is practically no new material. As to methods, the laagers of the Boers are preceded by similar arrangements of British or Assyrian war chariots; and so in almost every direction it will be found that the expedient of to-day has had its forerunners in those of the countless yesterdays. The only really marked change in the arrangements of field defences has been caused not by gunpowder but by quick-firing rifled weapons. For that reason it is worth while to consider briefly what were the principles of field fortification at the end of the 18th century. That period has been chosen because it gives us the result of a couple of centuries of constant fighting between disciplined troops with fairly effective fire-arms. The field defences of the 19th century are transitional in character. Based mainly on the old methods, they show only faint attempts at adaptation to new conditions, and it was not till quite the end of the century that the methods now accepted began to take shape.

The essential elements of fieldworks up to the time of the Peninsular War were *command* and *obstacle*; now they are *protection* and *concealment*.

The command and obstacle were as necessary in the days of smooth-bore muskets and guns as in those of javelins and arrows. When the enemy could get close up to a work without serious loss, and attack in close order, the defenders needed a really good obstacle in front of them. Moreover, since they could not rely on their fire alone to repulse the attack, they needed a two-deep line, with reserves close at hand, to meet it with the "arme blanche." For this purpose a parapet 7 or 8 ft. high, with a steep slope, perhaps palisaded, up which the attackers must climb after passing the obstacle, was excellent. The defenders after firing their last volley could use their bayonets from the top of the parapet with the advantage of position. The high parapet had also the advantage that the attackers could not tell what was going on inside the redoubt, and the defenders were sheltered from their fire as well from view until the last moment.

The strength of a fortified line in the 18th century depended principally on its redoubts. Lines of shelter trenches had little

power of defence at the time, unless they held practically as many men as would have sufficed to fight in the open. Obstacles on the other hand had a greater value, against the inelastic tactics of the time, than they have now. A good position therefore was one which offered good fire-positions for redoubts and plenty of facilities for creating obstacles. Strong redoubts which could resist determined assaults; good obstacles in the intervals, guns in the redoubts to sweep the intervals, and troops in formed bodies kept in reserve for counter-strokes—these were the essentials in the days of the smooth-bore.

The redoubts were liable to a heavy cannonade by field-guns before the attack. To withstand this, the parapets had to be made of a suitable thickness—from 4 or 5 ft. upwards—according to the time available, the resisting nature of the soil, and the severity of the bombardment expected.

The whole of the earth for the parapet was as a rule obtained from the ditch, in order to make as much as possible of this obstacle. The garrison in all parts of the interior of the redoubt were to be sheltered, if possible, from the enemy's fire, and with this object great pains were bestowed on the principle of "defilade." The object of defilade, which was a great fetish in theoretical works, was so to arrange the height of the parapet with reference to the terreplein of a work that a straight line (not, be it observed, the trajectory of the projectiles) passing from the muzzle of a musket or gun on the most commanding point of the enemy's position, over the crest of the parapet, should just clear the head of a defender standing in any part of the work. This problem of defilade became quite out of date after the development of time shrapnel, but was nevertheless taught with great rigour till within the last twenty years.

The sectional area of the ditch was calculated so that with an addition of about 10% for expansion it would equal that of the parapet. If a wider and deeper ditch was considered necessary, the surplus earth could be used to form a glacis.

The interior of the redoubt had to afford sufficient space to allow the garrison to sleep in it, which was sometimes a matter of some difficulty if a small irregularly shaped work had to contain a strong garrison. Consideration of the plan and sections of these works will show that the banquettes for infantry with its slopes, and the gun platforms, took off a good deal from the interior space within the crest-line. Guns were usually placed at the salients, where they could get the widest field of fire. They were sometimes placed on the ground level, firing through embrasures in the parapet, and sometimes on platforms so as to fire over the parapet (*en barbette*).

As in permanent fortification, immense pains were taken to elaborate theoretically the traces of works. A distinction was made between forts and redoubts, the former being those which were arranged to flank their own ditches, while the redoubts did not. Redoubts again were classed as "closed," those which had an equally strong defence all round; and "half-closed," those which had only a slight parapet or timber stockade for the gorge or rear faces. Open works (those which had no gorge defence) were named according to their trace, as *redans* and *lunettes*. A redan is a work with two faces making a salient angle. It was frequently used in connexion with straight lines of trench or breastwork. A lunette is a work with two faces, usually forming an obtuse angle, and two flanks.

The forts described in the text-books, as might be expected, were designed with great ingenuity, with bastioned or demi-bastioned fronts, star traces, and so forth, and in the same books intricate calculations were entered into to balance the *remblai* and *déblai*, that is, the amount of earth in the parapets with that excavated from the ditches. In practice such niceties of course disappeared, though occasionally when the ground allowed of it star forts and bastioned fronts were employed.

Or irregular ground the first necessity was to fit the redoubt to the ground on which it stood, so as to sweep the whole of the foreground, and this was generally a sufficiently difficult matter without adding the complications of flanking defences. Sir John Jones, speaking of the traces of the several works in the Torres Vedras lines, says:—

"The redoubts were made of every capacity, from that of fig. 74 a, limited by want of space on the ground it occupied to 50 men and two pieces of artillery, to that of fig. 74 b, for 500 men and six pieces of artillery, the importance of the object to be attained being the only guide in forming the dimensions. Many of the redoubts first thrown up, even some of the smallest, were shaped like stars, under the idea of procuring a flank defence for the ditches; but this construction was latterly rejected, it being found to cut up the interior space, and to be almost fallacious with

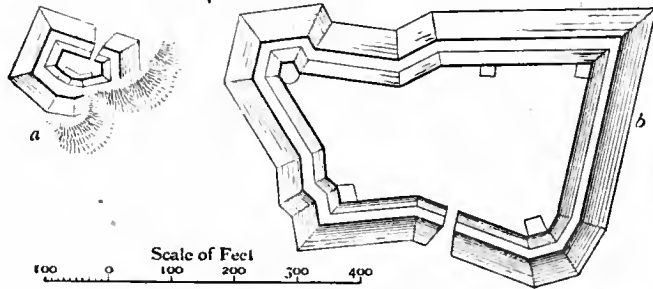

FIG. 74.—Torres Vedras Works.

respect to flank defence, the breadth of the exterior slopes being in some cases equal to the whole length of the flanks so obtained. Even when, from the greater size of the work, some flanking fire was thus gained, the angle formed by the faces was generally so obtuse that it demanded more coolness in the defenders than ought reasonably to be expected to aim along the ditch of the opposite face: and further, this construction prevented the fire of the work being more powerful in front than in rear.

In order to decide on the proper trace of a work, it is necessary to consider whether its object be to prevent an enemy establishing himself on the ground on which it is to be placed, or whether it be to insure a heavy fire of artillery on some other point in its vicinity. In the first case every consideration should be sacrificed to that of adding to its powers of self-defence by flanks or other expedients. In the second, its powers of resistance are secondary to the establishment of a powerful offensive fire and its trace cannot be too simple. Latterly, the shape of the redoubts was invariably that most fitted to the ground, or such as best parried the enfilade fire or musketry plunge of neighbouring heights, care being taken to present the front of fire deemed necessary towards the pass, or other object to be guarded; and such will generally be found the best rule of proceeding.

This recommendation, however, is not intended to apply to isolated works of large dimensions, and more particularly to those considered the key of any position. No labour or expense should be spared to render such works capable of resisting the most furious assaults, either by breaking the parapet into flanks, or forming a flank defence in the ditch; for the experience gained in the Peninsula shows that an unflanked work of even more than an ordinary field profile, if skilfully and determinedly assaulted, will generally be carried. . . . Nor does the serious evil of curtailing the interior space, which renders breaks in the outline so objectionable in small works, apply to works of large dimensions. . . . Under this view the great work on Monte Agraça (fig. 75) must be considered as very

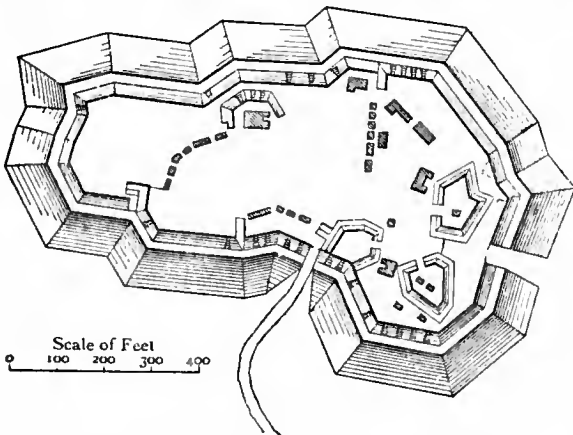

FIG. 75.—Monte Agraça, Torres Vedras.

defective, the flank defence being confined to an occasional break of a few feet in the trace, caused by a change of direction in the contour of the height, whilst the interior space is more than doubly sufficient for the number of its allotted garrison to encamp.

Interior and other Defences.—This work, however, had some of its salient points . . . cut off by earthen lines of parapet, steeply

revetted externally, and so traced as to serve for traverses to the interior. It had also three or four small enclosed posts formed within it; and the work at Torres Vedras (fig. 76) had each of its salient points formed into an independent post. These interior defences and retrenchments were intended to guard against a general panic amongst the garrison, which would necessarily be composed in part

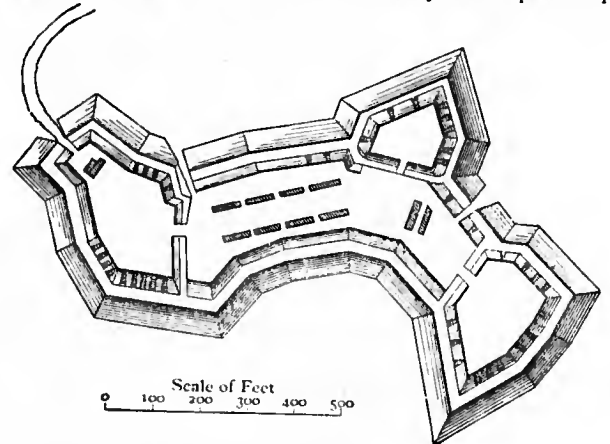

FIG. 76.—Torres Vedras Works.

of indifferent troops, and also to prevent the loss of the work by the entry of the assailants at any weak or ill-defended point. Such interior lines to rally on are absolutely essential to the security of a large field-work. They serve as substitutes for a blockhouse or tower, placed in the interior of all well-constructed permanent earthen works, and merit far more attention than they generally receive.

The small circular windmills of stone, which were frequently found occupying salient knolls . . . readily converted into admirable interior posts of that nature. The profile of the several works varied on every face and flank, according to its liability to be attacked or cannonaded; the only general rule enforced being that all ditches should be at least 15 ft. wide at top and 10 ft. in depth, and the crest of the parapet have at least 5 ft. command over the crest of the counterscarp. No parapet exceeded 10 ft. in thickness, unless exposed to be severely cannonaded, and few more than 6 or 8 ft.; and some, on high knolls, where artillery could not by any possibility be brought against them, were made of stone or rubble less than 2 ft. in thickness, to gain more interior space, and allow full liberty for the use of the defenders' bayonets."

Fig. 77 gives two typical sections of these works.

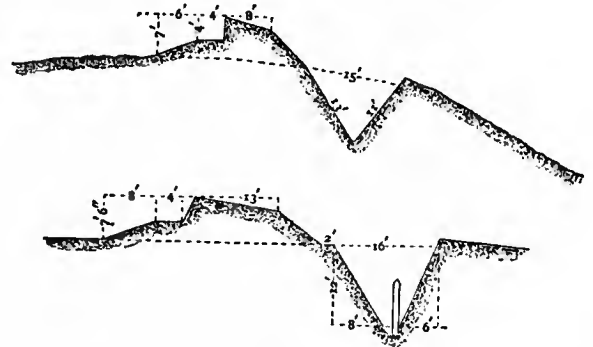

FIG. 77.

The works of Torres Vedras have been chosen for illustration because they offer very good historical examples, and also because of the value of the critical remarks of Sir John Jones, who as a captain was the engineer in charge of their construction. At the same time it must be remembered that they differ from ordinary field-works in having an unusual degree of strength, plenty of time and civilian labour having been available for their construction. In this respect they approximate more to semi-permanent works, the main reason why they did not receive under the circumstances a greater development of ditch and parapet being that in addition to the large number of works required, much labour was expended in abatis, inundations, scarping hill-sides and constructing roads.

Some further remarks of Sir John on the *situations of the works* are very instructive:—

"Many of the redoubts were placed on very elevated situations on the summit of steep hills, which gave them a most imposing

appearance; but it was in reality a defect . . . for the fire of their artillery on the object to be guarded became so plunging as to lose half its powers; the musketry could not be made to scour the face of the hill sufficiently; and during the night both arms became of most uncertain effect.

"The domineering situation of the redoubts, however, gave confidence to the young troops which composed their garrisons, protected them from a cannonade, and screened their interior from musketry, unless fired at a high angle, and consequently at random. These considerations perhaps justify the unusually elevated sites selected for most of the redoubts on the lines, though they cannot induce an approval of them as a general measure."

The chief principle of the period was thus that the redoubts were the most important features of lines of defence, and that they combined physical obstacle and protection with good musketry and artillery positions. The value of concealment was not ignored, but it was as a rule subordinated to other considerations.

The principles of this time remained unaltered until after the Crimean War. In the American Civil War the power of the rifle began to assert itself, and it was found that a simple breastwork defended by a double rank of men could protect itself by its fire against an ordinary assault. This power of the rifle gave greatly enhanced importance to any defences that could be hastily extemporized behind walls, hedges or any natural cover. About the period of the Franco-German War other considerations came in. The increased velocity of artillery projectiles reduced in some ways their destructive effects against earth parapets, because the shell had an increasing tendency to deflect upwards on striking a bank of loose earth. Also the use of shrapnel made it impossible for troops to find cover on the terreplein of a work some distance behind the parapet.

These considerations, however, were not fully realized at that time. The reason was partly a want of touch between the engineers and the non-technical branches of most armies, and partly that original writers from the Napoleonic wars to the present day have been more occupied with the primary question of the value of field defences as a matter of tactics than with their details considered from the standpoint of fortification.

There was always an influential school of writers who declaimed against all defences, as being injurious to the offensive spirit so essential to success. Those writers who treated of the arrangements of defences devoted themselves to theoretical details of trace quite after the old style; discussing the size and shape of typical redoubts, their distance apart and relation to lines of trenches, &c. The profiles—the thick parapet with command of 7 ft. or more, the deep ditch, and the inadequate cover behind the parapet—remained as they had been for a century.

The American Civil War showed the power of rifles behind slight defences. Plevna in 1877 taught a further lesson. It proved the great resisting power of extemporized lines; but more than that, we begin to find new arrangements for protection against shell fire (see plans and sections in Greene's *The Russian Army and its Campaign in Turkey*). The trace of the works and the sections of parapet and ditch suggest Torres Vedras; but a multiplication of interior traverses and splinter-proof shelters show the necessity for a different class of protection. The parapet was designed according to the old type, for want of a better; the traverses and shelters were added later, to meet the necessities of the case. The Turks also used two or three tiers of musketry fire, as for instance one from the crest of the glacis, one from the parapet, and one from a traverse in rear of it. This, however, is a development which will not be necessary in future, thanks to magazine rifles.

From 1877 to 1899 the efficiency of rifles and guns rapidly increased, and certain new principles, causing the field defences of the present day to differ radically from those of the 18th century, remained to be developed. These may be considered under the following heads: the nature of protection required, the diminished need of obstacle, and the adaptation of works to ground.

The principle that *thickness* of parapet is no longer required, to resist artillery fire, was first laid down at Chatham in 1896.

The distance at which guns now engage makes direct hits on parapets comparatively rare. Further, a shell striking near the crest of a parapet may perhaps kill one man if he is in the way, and displace a bushel of earth. That is nothing. It is the contents of the shell, whether shrapnel or explosive, that is the source of danger and not the shell itself. Thus the enemy's object is to burst his common shell immediately behind the parapet, or his shrapnel a short distance in front of it, in order to get searching effect. It follows that a parapet is thick enough if it suffices to stop rifle bullets, since the same thickness will *a fortiori* keep out shrapnel bullets or splinters of shell. For this purpose 3 ft. is enough.

Real protection is gained by a trench close in rear of the parapet, deep enough to give shelter from high angle shrapnel, and narrow enough to minimize the chance of a common shell dropping into it. This protection is increased by frequent traverses across the trench.

The most essential point of all is *concealment*. In gaining this we say good-bye finally to the old type of work. Protection is now given by the trench rather than the parapet; command and the ditch-obstacle (which furnished the earth for the high parapet) are alike unnecessary. Concealment can therefore be studied by keeping the parapet down to the lowest level above the surface from which the foreground can be seen. This may be 18 in. or less.

The need of obstacle, in daylight and when the defenders are not abnormally few, has practically disappeared. For night work, or when the assailant is so strong as to be able to force home his attack in face of protected rifle fire, what is needed is not a deep ditch immediately in front of the parapet, difficult to climb, but also difficult to flank, but an obstacle that will detain him under fire at short range. It may be an entanglement, an abatis, an inundation: anything that will check the rush and make him move slowly.

In the *adaptation of works to ground*, the governing factor is the power of the rifle in frontal defence. We have seen that in Peninsular times great reliance was placed on the flanking defence of lines by guns in redoubts. Infantry extended behind a simple line of trench could not resist a strong attack without such support. Now, however, infantry behind a slight trench, with a good field of fire should be able to defend themselves against any infantry attack.

This being so, the enemy's artillery seeks to locate the trenches and to cover them with a steady hail of shells, so as to force the defenders to keep down under cover. If they can succeed in doing this, it is possible for the attacking infantry to advance, and the artillery fire is kept up until the last moment, so that the attack may have the narrowest possible space to cover after the defenders have manned their parapets and opened fire. Fig. 78 shows the action of various natures of projectiles.

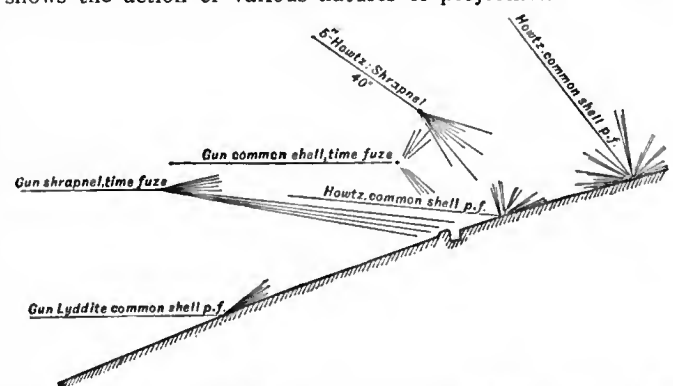

From *Mil. Engineering*, by permission of the Controller of H.M. Stationery Office.

FIG. 78.—Effect of Projectiles.

We need not here discuss the rôle of the defenders' artillery in replying to that of the enemy and playing on the attack; nor for the moment consider how far the defence of the trenches while under artillery fire can be made easier by overhead cover. The main question is—what is, in view of the nature of the attack,

the best disposition of lines of trench; and do they require the addition of redoubts?

The most important point, with the object of protection, is that the trenches must not be conspicuous; this is the best defence against artillery. With the object of resistance by their own fire they must have a good view, or, as it is generally described, no *dead ground* in front of them. For this purpose 300 or 400 yds. may be enough if the ground is even and affords no cover.

This necessity for invisibility, together with the shallowness of the zone that suffices for producing a decisive fire effect, has of late years very much affected the choice of ground for a line of trenches.

For a defensive position on high ground, it was usually laid down until the South African War that a line of trenches should be on the "military crest" (Fr. *crête militaire*), i.e. the highest point on the hill from which the whole of the slopes in front can be seen. Thus in the three sections of ground shown in fig. 79 it would be at *a*, *b* and *c* respectively. The simplicity

Siting of trenches.



FIG. 79.

of this prescription made it attractive and it came to be rather abused in the text-books. There were, even before the improvements in artillery, objections to it, because on most slopes the military crest would be found at very different elevations on different parts of the line, so that by a strict adherence to the rule some of the trenches would be placed near the top of the hill, and some in dangerous isolation near the bottom. Moreover a rounded hill has no military crest.

Further, we have to consider nowadays not only the position of the fire-trenches, but those of supports, reserves and artillery, and the whole question is extremely difficult.

For instance, considering the sections alone, as if they did not vary along the line, the positions at *a* and *b*, fig. 79, are bad because they are on the sky-line and therefore a good mark for artillery. That at *b* is especially bad because the slope in front is so steep that the defenders would have to expose themselves very much to fire down it, and the artillery fire against them can be kept up until the very last moment. The position *c* has the advantage of not being on the sky-line, but the position of the supports in rear is exposed.



FIG. 80.

Another possible position for the infantry line is at *f*, fig. 81, with the guns on the high ground behind. They might easily be quite concealed from the enemy's artillery. The drawback is that no retirement up the exposed slope would be possible for them, except at night. The fire from *f* will be grazing, which will



FIG. 81.

be a great advantage as compared with the *plunging* fire that would be obtained from a position up the hill.

It is idle, however, to give more than the most cursory consideration to sections of imaginary positions. It is only by actual practice on the ground that skill can be attained in laying out positions, and only a trained soldier with a good eye can succeed in it. Briefly, the advantages of view and position given by high ground must be paid for in some degree by exposure to the enemy's artillery; and at least as much consideration—possibly as much labour—must be given to communications with the fire-trenches as to the trenches themselves. Irregular ground simplifies the question of concealment but also gives cover to the enemy's approach. The lie of the ground will itself dictate the position of the trenches, subject to the predispositions of the responsible officer. On flat featureless ground the general trace of the trenches should be irregular. This makes a more difficult target for artillery, and affords a certain amount of cross and flanking fire, which is a very great advantage. Great care should, however, be taken not to expose the trenches to oblique or enfilade fire; or at least to protect them, if so exposed, by traversing.

Concealment of trenches is generally attempted by covering the freshly turned earth of the small parapet with sods, leafy branches or grass. In this connexion it should be remembered **Trenches.** that after a day or two cut leaves and grass wither and may become conspicuous against a green surface. Where the ground is so even that a good view of the foreground is possible from the surface level, the trench may be made without a parapet; but this entails great labour in removing and disposing of the excavated earth. A common device is to conceal the parapet as well as possible and to make a dummy trench some distance away to draw fire.

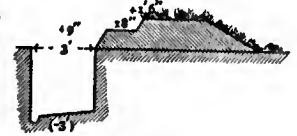

FIG. 82.

Besides the direct concealment of trenches, care must be taken that the site is not conspicuous. Thus a trench should not be placed along the meeting line of two different kinds of cultivation, or along the edge of a belt of heather on a hillside, or where a difference of gradient is sharply defined; or where any conspicuous landmark would help the enemy's artillery to get the range.

Trenches are broadly distinguished as "fire trenches" and "cover trenches," according as they are for the firing line or supporting troops. The following simple types are taken from the 1908 edition of *Military Engineering* (part 1): "Field Defences."

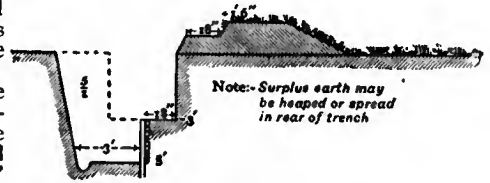
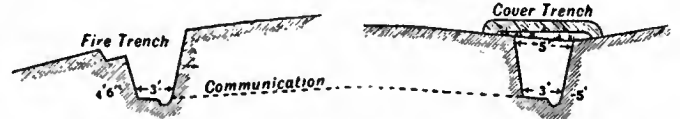

FIG. 83.

Fig. 82 is the most common form of fire trench, in which labour is saved by equalizing trench and parapet. This would take 1½ to 2 hours in ordinary soil. Fig. 83 shows the same trench improved by 2 or 3 hours' more work. Fig. 84 shows a fire trench without parapet, with cover trench and communication.

The addition of a loophole of sand-bags, sodded on the top for



From *Mil. Engineering: Field Defences* (1908), by permission of the Controller H. M. Stationery Office.

FIG. 84.

concealment (called *head-cover*), gives increased protection, but at the cost of greater prominence for the parapet (fig. 85). Overhead cover can only be provided in fire trenches by giving the parapet still greater height and it is not usually done. Portions of the trench not used for firing can, however, be given splinter-proof protection by putting over them branches or bundles, covered with a few inches of earth: or by boards, or sheets of corrugated iron if they can be had. A better plan when time permits is to provide cover trenches immediately behind and communicating with the fire trench.

The question of redoubts has been a vexed one for years; partly they were thought to be unnecessary in view of the resisting power of a line of trenches, but chiefly because the redoubt was always imagined as one of the older type, with a high conspicuous parapet. Of course a redoubt of such a nature would be readily identified and made untenable. But the idea of a redoubt

does not necessarily imply command. Its object is that it shall be capable of all-round defence. There can be no doubt that as there is always a possibility of lines being pierced somewhere, it is desirable, unless the whole line is to be thrown into confusion and forced back, to have some point at which the defenders can maintain themselves. This is not possible unless at such points there is provision for defence towards both flanks and rear, that is to say, when there are redoubts, which can hold on after certain portions of the line have been lost and thereby can localize the enemy's success and simplify

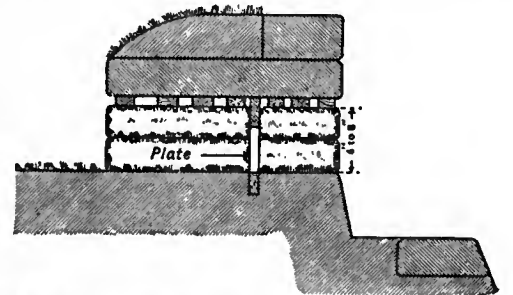

From *Mil. Engineering: Field Defences*, by permission of the Controller H. M. Stationery Office.

FIG. 85.

the action of supporting troops. In order that redoubts may exercise this function, all that is necessary is that their defenders should be able to see the ground for a furlong in front of them in every direction. Their parapets, therefore, need be in no way more conspicuous than those of the neighbouring fire trenches, and in that case there is no fear of their drawing special attention from the enemy's artillery. Whatever theories may have been put forward on the subject, in practice they are constantly used, and in the Russo-Japanese War, where the experience of South Africa was already available, we find them in the fighting lines on both sides.

cover. Such a section is only possible in very firm soil. Apart from this, the type is really only suited to rifle pits, as a trench proper should have room for officers and N.C.O.'s to move along within it. The Boers showed great skill in concealing their trenches. One good point was that there was generally something making a background immediately behind the men's heads, so that they did not stand out in relief when raised above the parapet.

Boer, Russian and Japanese types.

In the Russo-Japanese War the Russian trenches at the outset were of old-fashioned type and very conspicuous. Later on better types were evolved. Figs. 90 and 91 are a couple of sections from Port Arthur; the first borrowed from the Boers but wider at the

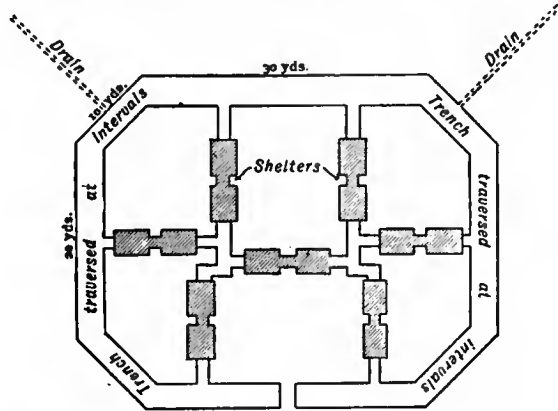

FIG. 86.

The modern type of field redoubt is a fire trench, no more conspicuous than the others, in any simple form adapted to the ground that will give effective all-round fire, such as a square with blunted

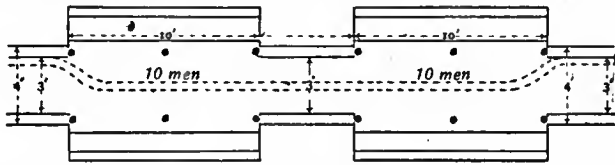

FIG. 87.

angles. Enhanced strength may be given by deepening the trenches and improving the overhead cover; and special use may here be made of obstacles.

Within the redoubt cover may be provided for men in excess of those required to man the parapet, by means of cover trenches and

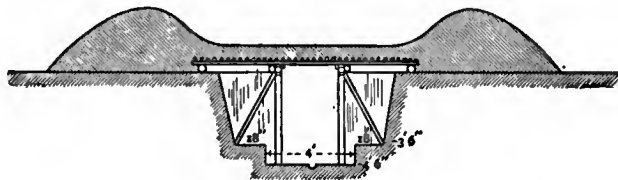
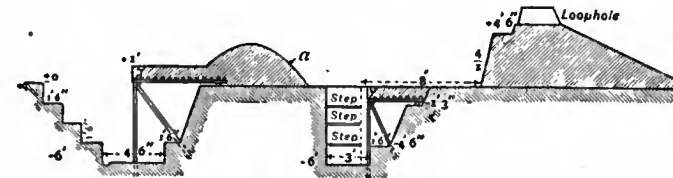

FIG. 88.

field casemates. Fig. 86 gives the general idea of such a redoubt, and figs. 87, 88 the plan and section of the interior shelters. Such a work can easily be made quite invisible from a distance. It gives excellent cover against shrapnel, but would not be tenable against howitzer common shell, if the enemy did manage to bring an accurate fire to bear on it.

Fig. 89 shows the section of a parapet with two shelters behind it for a work with a high command of 5 or 6 ft. This work would



From *Mil. Engineering: Field Defences* (1908), by permission of the Controller H. M. Stationery Office.

FIG. 89.

require a concealed position, which can often be found a little in rear of the firing line.

In the South African War a good deal of interest was excited by a type of trench used by the Boers. It was very narrow at the surface, giving only just room for a man to stand; but undercut or hollowed out below, so that he could sit down with very good

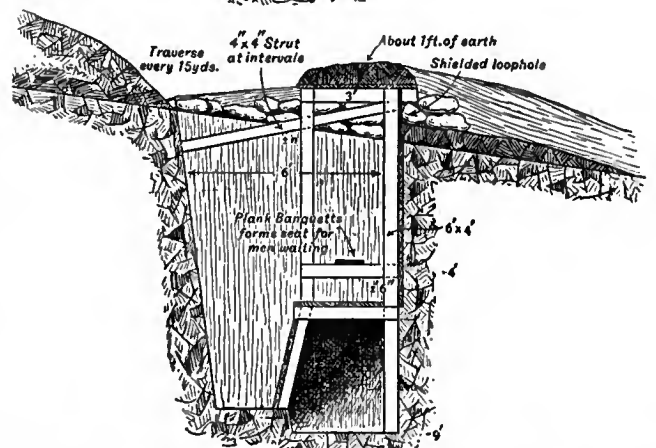
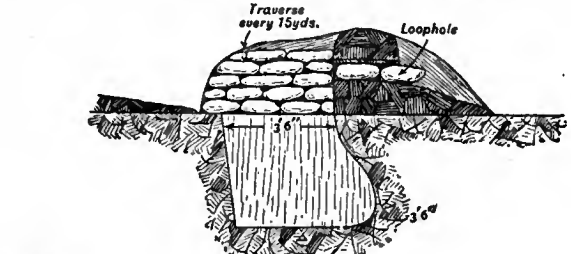

From *Russo-Japanese War: British Officers' Reports*, vol. ii., by permission of the Controller H. M. Stationery Office.

FIGS. 90 and 91.

top. The Japanese appear to have taken their type mainly from the latest British official books, but applied them with great skill to the ground, studying especially invisibility. In their prepared positions they used large redoubts manned by several companies.

Cover for Guns.—Some degree of cover for guns, in addition to the shield, is always desirable. If the gun stands on the natural surface of the ground, the cover is called an epaulment. In that case a bank is thrown up in front of the gun, about 1 ft. high in the centre, and

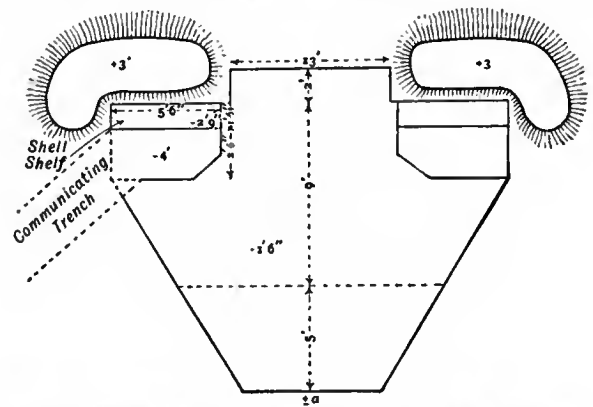

From *Mil. Engineering: Field Defences*, by permission of the Controller H. M. Stationery Office.

FIG. 92.—Gun-pit.

3 ft. 6 in. high at the ends. On either side of the gun and close up to the bank is a small pit for the gunners. The rest of the earth for the epaulment is got from a trench in front. If the gun is sunk, the shelter is called a gun-pit.

In this case there is no bank immediately in front of the gun. Shelter can be got more quickly with a pit than an epaulment, but it is generally undesirable to break the surface of the ground.

The commonest forms of *obstacle* now used are *abatis* and *wire entanglements*. Fig. 93 shows a well-finished type of *abatis*. The *Obstacles*, branches are stripped and pointed, and the butts are buried and pegged firmly down. Wire entanglement may be added to this with advantage. An *abatis* should be protected from artillery fire, which is sometimes done by placing it in a shallow excavation with the earth thrown up in front of it.



From *Mil. Engineering: Field Defences*, by permission of the Controller H.M. Stationery Office.

FIG. 93.—Abatis.

Wire may be used as a *high* or *low entanglement* or as a fence or trip wire or concealed obstacle. The usual form of high wire entanglement consists of several rows of stout stakes 4 or 5 ft. long, driven firmly into the ground about 6 ft. apart, and connected horizontally and diagonally with barbed wire.

Palisades are still used, and need no description. They were formerly often made bullet-proof, but this is no longer possible. *Fraises* are seldom heard of now, though they may appear occasionally in a modified form. They were much used in connexion with deep ditches, and are palisades placed so as to project horizontally from the escarp, or sloping forward in the bottom of the ditch. *Military pits* both *deep* and *shallow* (the latter, shown in fig. 95, called *trous de loup*) are not so much used as formerly, because the obstacle is hardly worth the labour expended on it. Both,



FIG. 94.—Crows' Feet.

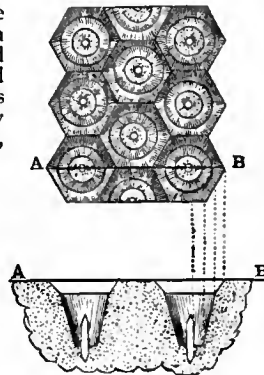

FIG. 95.—Plan and section of Trous-de-loup.

however, were employed in the Russo-Japanese War. *Crows' feet*, formerly much used as a defence against cavalry, are practically obsolete. They consisted of four iron spikes joined together at their bases in such a manner that however they were thrown down one point would always be pointing upwards (fig. 94). *Chevaux-de-frise* (*q.v.*) were formerly a much-used type of obstacle.

The best obstacle is that which can be made to fulfil a given object with the least expenditure of time and labour. From this point of view barbed wire is far the best. One of its greatest advantages is that it gives no cover whatever to the enemy.

Fougasses have always for convenience been classed as obstacles. A *fougasse* is a charge of powder buried at the bottom of a sloping pit. Over the powder is a wooden shield, 3 or 4 in. thick, and over the shield a quantity of stones are piled. The illustration, fig. 96, gives a clear idea of the arrangement. A *fougasse* of this form, charged with 80 lb of powder, will throw 5 tons of stones over a surface 160 yds. long by 120 wide. They may be fired by powder hose, fuze or electricity. Their actual effect is very often a matter of chance, but the moral effect is usually considerable.

Dams are most effective obstacles, when circumstances allow of their use. They are constructed by military engineers as small temporary dams would be in civil works.

A most important question, especially in connexion with obstacles, is that of lighting up the foreground at night. Portable electric searchlights are most valuable, especially for detecting the enemy's movements at some distance; but their use will naturally always be restricted. Star shells and parachute lights fired from guns are not of much use for the immediate foreground, and do not burn very long. They were formerly chiefly of use in siege works, to light up an enemy's working parties. Germany has introduced lightballs fired from pistols, which will probably have a considerable future.

Various civilian forms of *flare-light* would be very useful to illuminate obstacles, but cannot well be carried in the field. *Bonfires* are very useful when material is available. They require careful treatment, *e.g.* they must be so arranged that they can be lighted instantaneously (they may be lighted automatically, by means of a trip wire and a fuze); they must give a bright light at once (this can be ensured with shavings or straw sprinkled with petroleum); they must be firmly built so that the enemy cannot destroy them easily; and if possible there should be a screen arranged behind them so that they may not light up the defence as well as the attack.

Blockhouses are familiar to the public from the part they played in the South African War of 1899–1902. In the old-fashioned permanent fortification they were used as keeps in such positions as re-entering places of arms and built of masonry. Stone blockhouses have long been used in the Balkans for frontier outposts; they are sometimes built cruciform, so as to get some flanking defence. In the form of bullet-proof log-cabins they have played a great part in warfare between pioneer settlers and savages.

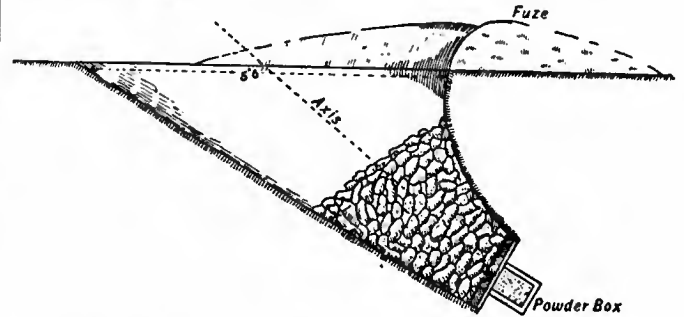

From *Mil. Engineering*, by permission of the Controller H.M. Stationery Office.

FIG. 96.—Fougasse.

In the 19th century blockhouses were usually designed to give partial protection against field artillery; the walls being built of two thicknesses of logs with earth between them, the roof flat and covered with 2 or 3 ft. of earth, and earth being piled against the walls up to the loopholes. Nowadays they are employed only in positions where it is not likely that artillery will be brought against them; but they may be made tenable for a while even under artillery fire if they are surrounded by a trench and parapet.

Blockhouses are especially useful for small posts protecting such points as railway bridges, which the enemy may attempt to destroy by cavalry raids. The essential feature is a bullet-proof loop-holed wall, arranged for all-round fire, with enough interior space for the garrison to sleep in. The roof may be simply weatherproof. Some arrangement for storing water must be provided. Circular blockhouses were very popular in South Africa. They were made of sheets of corrugated iron fastened 6 in. apart on a wooden framework, the space between the sheets being filled with small stones. The loop-holes were made of sheet-iron frames inserted in the walls. Fig. 97 shows a section of one of these blockhouses.

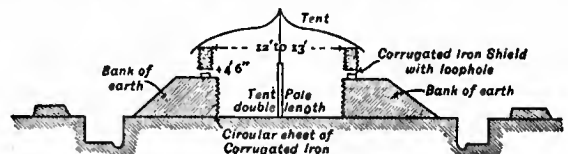

By permission of the Controller H.M. Stationery Office.

FIG. 97.—Blockhouse, South Africa, 1900–1902.

The defence of woods was formerly an important branch of field defences. *Abatis* and entanglements could readily be extemporized, trunks of trees made strong breastworks, and the wood concealed the numbers of the defenders. A wood was therefore generally considered a useful addition to a line of defence. It was customary to hold the front edge of the wood, the irregularities of the outline being utilized for frontal and flanking fire, while obstacles were disposed some 50 yds. in front. In a carefully prepared position, clearings would be made parallel to the front and some distance back from it, for support positions, and great attention was paid (in theory at least) to clearing communications, erections, signposts, &c., so that the defending troops might move freely in any desired direction.

Woods, however, had their inherent drawbacks. The ground is hard to dig, clearing involves great labour; and communication, at the best, is cramped. Nowadays a wood can hardly be considered a strong defensive element in a line. The front of it is an excellent ranging mark for artillery, and positions within the wood are not easily made, because of the difficulty of trenching, and the fact that no reasonable amount of timber will make a breastwork proof against the modern bullet. Once an enemy gets a footing within a wood, the position is more favourable to offensive than to defensive action. If a wood has to be occupied in a line of defence, it is probable that in most cases the rear edge or a line slightly behind it would be the best to fortify, though the front edge would no doubt be held by the fighting line at the outset.

The defence of villages is another question which has been much affected by recent improvements in artillery. Formerly villages were very important adjuncts to a line of defence, and strong points for a detached force to hold. There were indeed always drawbacks. The preparations for defence entailed

a good deal of labour, and the defending force was scattered in houses and enclosures, so that control and united action were difficult. But the value of the ready-made protection afforded by walls was so great—and sometimes even decisive—that villages were occupied as a matter of course. This is certainly now changed, but precisely to what extent it will be impossible to say, until after the next European war. A village under fire is not now an ideal defensive position. A single shrapnel penetrating the outer wall may kill all the occupants of a room; a single field-howitzer shell may practically ruin a house. At the same time, a house or line of houses may (without any preliminary labour at all) give very good protection against shell fire to troops *behind* them. Further, the value to the defence of the slightest cover, once the infantry attack has developed, is so great that the ruins of walls and houses occupied at the right moment may prove an impregnable stronghold. This class of fighting, however, does not properly come under the present heading. For the details of the defence of walls, houses, &c., see the official *Mil. Engineering* (1908).

Entrenching under Fire.—Progress in this direction has been delayed by the reluctance of military authorities to add a portable entrenching tool to the heavy burden already carried by the infantry soldier. Further delay has resulted from the attempts of enthusiastic inventors to produce a tool that shall weigh nothing, go easily in the pocket, and be available as a pick, shovel, saw, hand-axe or corkscrew. A tool that will serve more than one use is seldom satisfactory for any.

The object of entrenching under fire is to enable attacking infantry, when their advance is checked by the enemy's fire, to maintain the ground they have won by extemporizing cover where none exists. The need of this was first felt in the American Civil War, and towards the close of it a small entrenching spade 22 in. long and weighing only 1½ lb was introduced by Brigadier-General H. W. Benham into the Army of the Potomac. Since that time a great number of patterns have been tried, including shovel, trowel and adze types. The most popular of these has been the Linnemann spade, which is used by most continental armies and by the Japanese. The Austrian form of this tool is a rectangular spade with straight handle. The length over all is a little less than 20 in. The blade is 8 in. long by 6 wide. One side of it has a saw edge, and the other a cutting edge. For carriage, the blade is enclosed in a leather case, which is strapped to the pack or the waist-belt. In the British army the Wallace combined pick and shovel was used for some time, but was eventually dropped. There was always great doubt whether the utility of a portable entrenching tool was such as to justify the inconvenience caused to the soldier in carrying it. But the experience of the Russo-Japanese War seems to have finally established the necessity of it, and also the fact that it must generally be used lying down. For this purpose and for convenience in carrying it on the person, a very light short-handled tool is required.

The soldier lying down cannot attempt to dig a trench, but can make a little hole by his side as he lies, and put the earth in front of his head. A method introduced by the Japanese is that at each check in the advance the front line should do this, and, as they go forward, the supporting lines in succession should improve the cover thus commenced.

There are few things that soldiers dislike more, in the way of training, than trenchwork. For men unused to it, it is tiring and tedious work, and it is difficult for them to realize its importance. At the same time it is a commonplace of recent history that men who have been in action a few times develop a great affection for the shovel. The need of trenches grows with the growth of firearms, and the latest feature of modern tactics is the use of them in attack as well as in defence. The observation has often been made—with what truth as a general proposition we cannot here discuss—that modern battles tend more and more to resemble a siege. The weaker side, it is said, entrenches itself; the other bombards and attacks. After gaining as much ground as they can, the attacking troops wait for nightfall and entrench; perhaps making a further advance and entrenchment before dawn. In the last stage the attack might even be reduced to gaining ground by sapping. In open and featureless ground, where the rifle and gun have full play, the trench is to the modern soldier very much what the breast-plate was to the man-at-arms, an absolute essential.

The most important point in connexion with modern field fortification is the effect on both strategy and tactics of the increased resisting power of the defence. A small force well entrenched can check the frontal attack of a very much larger force, and while holding its position can make itself felt over a wider radius than ever before. This must needs have a marked effect on strategy, and it is quite possible to foresee such an ultimate triumph of field fortification as that one force should succeed in surrounding another stronger than itself, and by entrenching prevent the latter from breaking out and compel its surrender.

VI. CONCLUSION

In tracing the history of the science of fortification and in outlining the practice of our own time it has been necessary to

dwell chiefly on the material means of defence and attack. The human element has had to be almost ignored. But here comes in the paradox, that the material means are after all the least important element of defence. Certainly it is inconceivable that the designer of a fortress should not try to make it as strong as is consistent with the object in view and the means at his disposal. And yet while engineers in all ages have sought eagerly for strength and refinements of strength, the fact remains that the best defences recorded in history owed little to the builder's art. The splendid defence in 1667 of Candia, whose capture, of early Italian design, was already obsolete but whose capture cost the Turks 100,000 men; the three years defence of Ostend in 1601; the holding of Arcot by Clive, are instances that present themselves to the memory at once. The very weight of the odds against them sometimes calls out the best qualities of the defenders; and the *man* when at his best is worth many times more than the *rampart* behind which he fights. But it would be a poor dependence deliberately to make a place weak in order to evoke these qualities. One cannot be sure that the garrison will rise to the occasion, and the weakness of the place has very often been found an excuse for giving it up with little or no resistance.

Very much depends on the governor. Hence the French saying, "tant vaut l'homme, tant vaut la place." Among modern men we think of Tödleben (not governor, but the soul of the defence) at Sevastopol, Fenwick Williams at Kars, Denfert-Rochereau at Belfort, and Osman Pasha at Plevna. The sieges of the 16th and 17th centuries offer many instances in which the event turned absolutely on the personal qualities of the governor; in some cases distinguished by courage, skill and foresight, in others by incapacity, cowardice or treachery. The reader is referred to Carnot's *Défense des places fortes* for a most interesting summary of such cases, one or two of which are quoted below.

Naarden was besieged by the prince of Orange in September 1673 and defended by Philippe de Procé, sieur Dupas. The duke of Luxemburg visited the place some hours before it was invested, and arranged with Dupas to relieve him as soon as he had collected his cavalry. *The spirit of the defence.* But the governor lost his head when he saw the enemy encamped round the place, and surrendered it before he had even lost the covered way. He was subsequently tried by a council of war and sentenced to be degraded before the troops and imprisoned for life. The reason the court gave for not condemning him to death was that they could find no regulation which condemned a man to loss of life for being a coward. (At that period the decapitation of a governor who was considered to have failed in his duty was not uncommon.) This man, however, was not wanting in physical courage. He was in prison at Grave when it was besieged a year later, obtained leave to serve as a volunteer in the defence, fought well and was killed.

A similar case occurred in the English Civil War. In 1645 the young governor of the royal post at Bletchington House was entertaining a party of ladies from Oxford, when Cromwell appeared and summoned him to surrender. The attacking force had no firearm more powerful than a carbine, but the governor, overawed by Cromwell's personality, yielded. Charles I., who was usually merciful to his officers, caused this governor to be shot.

A defence of another kind was that of Quillebœuf in 1592. Henry IV. had occupied it and ordered it to be fortified. Before the works had been well begun, Mayenne sent 5000 men to retake it. Bellegarde undertook its defence, with 115 soldiers, 45 gentlemen and a few inhabitants. He had ammunition but not much provisions. With these forces and a line of defence a league in length, he sustained a siege, beat off an assault on the 17th day, and was relieved immediately afterwards. The relieving forces were astonished to find that he had been defending not a fortified town but a village, with a ditch which, in the places where it had been begun, measured no more than 4 ft. wide and deep.

At that period the business aspect of siege warfare already

alluded to had been recognized, but many commanders retained the old spirit of chivalry in their reluctance to say the "loth word." The gallant Marshal d'Essé, who feared nothing but the idea of dying in his bed, was lying ill at his country house when he was sent for by the king. He was ordered to take command at Théroanne, then threatened by Charles V., and made his farewell with these words, which remind us somewhat of Grenville: "Sire, je m'y en vais donc de bon et loyal cœur; mais j'ai ouï dire que la place est mal envitaillée, non pas seulement pourvue de palles, de tranches, ni de hottes pour remparer et remucr la terre; mais lors, quand entendrez que Théroanne est prise, dites hardiment que d'Essé est guéri de sa jaunisse et mort." And he made good his word, for he was killed at the breach by a shot from the arquebus of a Spanish soldier.

Sometimes the ardour of defence inspired the whole body of the inhabitants. Fine examples of this are the defences of Rochelle (1627) and Saint-Jean de Lône (1636), but these are too long to quote. We may, however, mention Livron, which is curious. In 1574 Henry III. sent one of his favourites, Saint Lary Bellegarde, against the Huguenots in the Dauphiné. Being entrusted with a good army, this gentleman hoped to achieve some distinction. He began by attacking the little town of Livron, which had no garrison and was defended only by the inhabitants. But he was repulsed in three assaults, and the women of the town conceived such a contempt for him that they came in crowds to empty their slops at the breach by way of insult. This annoyed him very much, and he ordered a fresh assault. The women alone sustained this one, repulsed it lightheartedly, and the siege was raised.

The history of siege warfare has more in it of human interest than any other branch of military history. It is full of the personal element, of the nobility of human endurance and of dramatic surprises. And more than any battles in the open field, it shows the great results of the courage of men fighting at bay. Think of Clive at Arcot. With 4 officers, 120 Europeans and 200 sepoys, with two 18-pounders and 8 lighter guns, he held the fort against 150 Europeans and some 10,000 native troops. "The fort" (says Orme) "seemed little capable of sustaining the impending siege. Its extent was more than a mile in circumference. The walls were in many places ruinous; the rampart too narrow to admit the firing of artillery; the parapet low and slightly built; several of the towers were decayed, and none of them capable of receiving more than one piece of cannon; the ditch was in most places fordable, in others dry and in some choked up," &c. These feeble ramparts were commanded almost everywhere by the enemy's musketry from the houses of the city outside the fort, so that the defenders were hardly able to show themselves without being hit, and much loss was suffered in this way. Yet with his tiny garrison, which numbered about one man for every 7 yds. of the enclosure, Clive sustained a siege of 50 days, ending with a really severe assault on two large open breaches, which was repulsed, and after which the enemy hastily decamped.

Such feats as this make arguments about *successive lines of defence* and the *necessity of keeps* seem very barren. History, as far as the writer knows, shows no instances where successive lines have been held with such brilliant results.

Clive's defence of his breaches, which by all the then accepted rules of war were untenable, brings us to another point which has been already mentioned, namely, that a garrison might honourably make terms when there was an open breach in their main line of defence. This is a question upon which Carnot delivers himself very strongly in endeavouring to impress upon French officers the necessity of defence to the last moment. Speaking of Cormontaigne's imaginary *Journal of the Attack of a Fortress* (which is carried up to the 35th day, and finishes by the words "It is now time to surrender"), he says with great scorn: "Crillon would have cried, 'It is time to begin fighting.' He would have said as at the siege of Quillebœuf, 'Crillon is within, the enemy is without.' Thus when Bayard was defending the shattered walls of Mézières, M. de Cormontaigne, if he had been there, would have said, 'It is time to surrender.' Thus when Guise

was repairing the breaches of Metz under the redoubled fire of the enemy, M. de Cormontaigne, if he had been there, would have said, 'It is time to surrender.'" Carnot of course allows that Cormontaigne was personally brave. His scorn is for the accepted principle, not for the man.

It is interesting to contrast with this passage some remarks by Sir John Jones, made in answer to Carnot's book. He says in the notes to the second volume of the *Journals of the Sieges in Spain*: "When the breach shall be pushed properly forward, if the governor insists upon the ceremony of his last retrenchment being stormed, as by so doing he spills the blood of many brave men without a justifiable object, his life and the lives of the garrison should be made the forfeit. A system enforced by terror must be counteracted by still greater terror. Humanity towards an enemy in such a case is cruelty to one's own troops. . . . The principle to be combated is not the obligation to resist behind the breach—for where there is a good retrenchment the bastion should be disputed equally with the counter-guard or the ravelin and can as safely be so—but the doctrine that surrender shall not take place when successful resistance becomes hopeless."

Carnot's word is "fight to the last." Sir John Jones says the commander has no right to provoke further carnage when resistance is hopeless. The question of course is, When is resistance hopeless? Sir John Jones's reputation leaves little doubt that if he had been commanding a fortress on British soil he would not have thought resistance hopeless as long as there was anything whatever left to defend. The reason why these two men of similar temper are found in opposition is quite simple: When Carnot wrote, the French army occupied most of the important fortresses of Europe, and it was to the interest of the emperor that if attacked they should be held to the last moment, in order to cause the enemy as much delay and loss as possible. Jones, on the other hand, was one of the engineers who were engaged in besieging those fortresses, and his arguments were prompted by sympathy for his own countrymen whose lives were sacrificed by the prolongation of such resistance.

A century has passed since Carnot and Jones wrote, and the ideas in which they had been educated were those of the pre-Napoleonic era. In the 18th century fortresses were many, good roads few, and campaigns for the most part leisurely. To the European nations of that time, inheritors of a perennial state of war, the idea of concentrating the national resources on a short and decisive campaign had not occurred. The "knock-out blow" had not been invented. All these conditions are now so changed that new standards must be and indeed have been set up, both for the defence of places and the general employment of fortification.

As regards the conduct of the defence, the massacre of a garrison as a penalty for holding out too long would meet with no sympathy in the present day. On the other hand, the issue of modern wars is worked out so rapidly that if a fortress is well defended, with the advantage of the present weapons, there is always a chance of holding out till the close of the war. If the place is worth holding, it should as a rule be held to the bitter end on the chance of a favourable turn in affairs; moreover, the maintenance of an important siege under modern conditions imposes a severe strain on the enemy and immobilizes a large number of his troops.

In concluding this article some elementary considerations in connexion with the use of permanent defences may be noticed, though the general question of strategic fortification is outside its scope. The objects of fortification differ, as has been shown, from age to age. In former times a peaceful people exposed to the raids of piratical Norsemen might find their refuge tower essential; later, a robber-baron might look on his castle as so much capital invested; a wealthy medieval town might prove the value of its walls more than once in a generation; a country without a standing army might gain time for preparation by means of fortresses barring the roads across the frontier. But how does the question stand to-day among European countries which can mobilize

Resisting
"to the
last."

Perman-
ent de-
fences.

their full fighting strength at a few hours' notice? It can only be answered when the circumstances of a particular country are examined.

If we assume such an impossible case as that of two nations of equal fighting strength and equal resources standing ready in arms to defend a common frontier, and that the theatre of war presents no difficulties on either side, then the use of permanent fortifications, merely as an adjunct to military strength, is wrong. Fortresses do not decide the issue of a campaign; they can only influence it. It is better, therefore, to put all the money the fortress would have cost, and all the man-power that its maintenance implies, into the increase and equipment of the active army. For the fate of the fortress must depend ultimately on the result of the operations of the active armies. Moreover, the very assumption that resources on both sides are equal means that the nation which has spent money on permanent fortifications will have the smaller active army, and therefore condemns itself beforehand to a defensive rôle.

This general negation is only useful as a corrective to the tendency to over-fortify, for such a case cannot occur. In practice there will always be occasion for some use of fortification. A mountain range may lend itself to an economical defence by a few men and some inexpensive barrier forts. A nation may have close to its frontier an important strategic centre, such as a railway junction, or a town of the first manufacturing importance, which must be protected. In such a case it may be necessary to guard against accidents by means of a fortress. Again, if one nation is admittedly slower in mobilization than the other, it may be desirable to guard one portion of the frontier by fortresses so as to force invasion into a district where concentration against it is easiest.

As for the defence of a capital, this cannot become necessary if it stands at a reasonable distance from the frontier until the active armies have arrived at some result. If the fighting strength of the country has been practically destroyed, it is not of much use to stand a siege in the capital. There can be but one end, and it is better, as business men say, to cut losses. If the fighting strength is not entirely destroyed and can be recruited within a reasonable time, say two or three months, then it appears that under modern conditions the capital might be held for that time by means of extemporized defences. The question is one that can only be decided by going into the circumstances of each particular case.

The case of a weak country with powerful and aggressive neighbours is in a different category. If she stands alone she will be eaten up in time, fortifications or no fortifications; but if she can reckon on assistance from outside, it may be worth while to expend most of the national resources on permanent defences.

These hypothetical cases have, however, no value, except as illustrations to the most elementary arguments. The actual problems that soldiers and statesmen have to consider are too complex to be dealt with in generalities, and no mere treatise can supply the place of knowledge, thought and practice.

BIBLIOGRAPHY.—The more important works on the subject are: Dürer, *Unterricht zur Befestigung* (Nuremberg, 1527); Speckle, *Architectur von Festungen* (Strassburg, 1589); Fritsch, *L'Architecture mil. ou la f. nouvelle* (Paris, 1637); Pagan, *Les Fortif.* (Paris, 1689); de Ville, *Les Fortif.* (Lyons, 1629); de Fer, *Introduction à la fortification* (Paris, 1723); B. F. de Belidor, *Science des Ingénieurs, &c.* (Paris, 1729); works of Coehoorn, Vauban, Montalembert, Cormontaigne; Mandar, *De l'architecture des forteresses* (Paris, 1801); Chasseloup-Laubat, *Essais sur quelques parties de l'artil. et de la fortification* (Milan, 1811); Carnot, *Défense des places fortes* (Paris, 1812); Jones, *Journals of Sieges in Spain* (3rd ed., London, 1846); T. Choumara, *Mémoire sur la fortification* (1847); A. von Zastrow, *Geschichte der beständigen Befestigung* (N.D., Fr. trans.); works of Sir C. Pasley; Noizet, *Principes de fortif.* (Paris, 1859); Dufour, *De la fortif. permanente* (Paris, 1850); E. Viollet le Duc, *L'Architecture militaire au moyen âge* (Paris, 1854); Cossaron de Villenoisy, *Essai historique sur la fortification* (Paris, 1869); works of Brialmont (*q.v.*); Delambre, *La Fortification dans ses rapports avec la tactique et la stratégie* (Paris, 1887); v. Sauer, *Angriff und Verteidigung fester Plätze* (Berlin, 1885); Schroeter, *Die Festung in der heutigen Kriegführung* (Berlin, 1898–1906); Baron E. v. Leithner, *Die beständige*

Befestigung und der Festungskrieg (Vienna, 1894–1899); W. Stavenhagen, *Grundriss der Befestigungslehre* (Berlin, 1900–1909); Plessix and Legrand, *Manuel complet de fortification* (Paris, 1900, new edition 1909); Ritter v. Brunner, *Die beständige Befestigung* (Vienna, 1909); *Die Feldbefestigung* (Vienna, 1904); Rocchi, *Traccia per lo studio della fortificazione permanente* (Turin, 1902); Sir G. S. Clarke, *Fortification* (1907); V. Deguise, *La Fortification permanente contemporaine* (Brussels, 1908); Royal Military Academy, *Text-book of Fortification*, pt. ii. (London, 1893); British official *Instruction in Military Engineering*, pts. i., ii. and iv. (London, 1900–1908). (L. J.)

FORTLAGE, KARL (1806–1881), German philosopher, was born at Osnabrück. After teaching in Heidelberg and Berlin, he became professor of philosophy at Jena (1846), a post which he held till his death. Originally a follower of Hegel, he turned to Fichte and Beneke (*q.v.*), with whose insistence on psychology as the basis of all philosophy he fully agreed. The fundamental idea of his psychology is impulse, which combines representation (which presupposes consciousness) and feeling (*i.e.* pleasure). Reason is the highest thing in nature, *i.e.* is divine in its nature, God is the absolute Ego and the empirical egos are his instruments.

Fortlage's chief works are: *Genetische Geschichte d. Philos. seit Kant* (Leipzig, 1852); *System d. Psych. als empirische Wissenschaft* (2 vols., Leipzig, 1855); *Darstellung und Kritik der Beweise für das Dasein Gottes* (Heidelberg, 1840); *Beiträge zur Psych. als Wissenschaft* (Leipzig, 1875).

FORT LEE, a borough of Bergen county, New Jersey, U.S.A., in the N.E. part of the state, on the W. bank of the Hudson river, opposite the northern part of New York City. Pop. (1905) 3433; (1910) 4472. It is connected with the neighbouring towns and cities by electric railways, and by ferry with New York City, of which it is a residential suburb. The main part of the borough lies along the summit of the Palisades; north of Fort Lee is an Interstate Palisades Park. Early in the War of Independence the Americans erected here a fortification, first called Fort Constitution but later renamed Fort Lee, in honour of General Charles Lee. The name of the fort was subsequently applied to the village that grew up in its vicinity. From the 15th of September until the 20th of November 1776 Fort Lee was held by Gen. Nathanael Greene with a garrison of 3500 men, but the capture by the British of Fort Washington on the opposite bank of the river and the crossing of the Hudson by Lord Cornwallis with 5000 men made it necessary for Greene to abandon this post and join Washington in the famous "retreat across the Jerseys." An attempt to recapture Fort Lee was made by General Anthony Wayne in 1780, but was unsuccessful. On the site of the fort a monument, designed by Carl E. Tefft and consisting of heroic figures of a Continental trooper and drummer boy, was erected in 1908. The borough of Fort Lee was incorporated in 1904.

FORT MADISON, a city and the county-seat of Lee county, Iowa, U.S.A., on the Mississippi river, in the S.E. corner of the state, and about 20 m. S.W. of Burlington. Pop. (1890) 7901; (1900) 9278, of whom 1025 were foreign-born; (1905) 8767; (1910) 8900. Fort Madison is served by the Atchison, Topeka & Santa Fé (which has repair shops here) and the Chicago, Burlington & Quincy railways. The city has various manufactures, including canned goods, chairs, paper and farm implements; the value of its factory product in 1905 was \$2,378,892, an increase of 50.8% over that of 1900. Fort Madison is the seat of one of Iowa's penitentiaries. A stockade fort was erected on the site of the city in 1808, but was burned in 1813. Permanently settled in 1833, Fort Madison was laid out as a town in 1836, and was chartered as a city in 1839.

FORTROSE (Gaelic *for t'rois*, "the wood on the promontory"), a royal and police burgh, and seaport of the county of Ross and Cromarty, Scotland. Pop. (1901) 1170. It is situated on the south-eastern coast of the peninsula of the Black Isle, 8 m. due N.N.E. of Inverness, 26½ m. by rail. It is the terminus of the Black Isle branch of the Highland railway; there is communication by steamer with Inverness and also with Fort George, 2½ m. distant, by ferry from Chanonry Ness. Fortrose consists of the two towns of Rosemarkie and Chanonry, about 1 m. apart, which were united into a free burgh by James II. in 1455 and created a royal burgh in 1590. It is a place of considerable antiquity, a monastery having been established in the 6th century by St. Moluag, a friend of Columba's, and St. Peter's

church built in the 8th century. In 1124 David I. instituted the bishopric of Ross, with its seat here, and the town acquired some fame for its school of theology and law. The cathedral is believed to have been founded in 1330 by the countess of Ross (her canopied tomb, against the chancel wall, still exists) and finished in 1485 by Abbot Fraser, whose previous residence at Melrose is said to account for the Perpendicular features of his portion of the work. It was Early Decorated in style, cruciform in plan, and built of red sandstone, but all that is left are the south aisles of the nave and the chancel, with the chapter-house, a two-storeyed structure, standing apart near the north-eastern corner. The cathedral and bishop's palace were destroyed by order of Cromwell, who used the stones for his great fort at Inverness. Another relic of the past survives in the bell of 1460. These ruins form the chief object of interest in the town, but other buildings include the academy and the Black Isle combination poorhouse. The town is an agricultural centre of some consequence, and the harbour is kept in repair. Rosemarkie, in the churchyard of which is an ancient Celtic cross, is much resorted to for sea-bathing, and there is a golf course in Chanonry Ness. The burgh belongs to the Inverness district group of parliamentary burghs.

FORT SCOTT, a city and the county-seat of Bourbon county, Kansas, U.S.A., on the Marmaton river, about 100 m. S. of Kansas City, Missouri. Pop. (1880) 5372; (1890) 11,946; (1900) 10,322, of whom 1205 were negroes; (1910 census) 10,463. It is the point of intersection of the Kansas City, Fort Scott & Memphis (St Louis & San Francisco system), the Missouri, Kansas & Texas, and the Missouri Pacific railways, and has in consequence a large traffic. The city is built on a rolling plain. Among its institutions are an Epworth house (1899), Mercy hospital (1889), the Goodlander home, and a Carnegie library. Near the city there is a national cemetery. Fort Scott is in the midst of the Kansas mineral fields, and its trade in bituminous coal is especially important. Building stones, cement rock, clays, oil and gas, lead and zinc are also found in the neighbourhood. An excellent white sulphur water is procured from artesian wells about 800 ft. deep, and there is a mineral-water bath house. The city is also a trading centre for a rich farming region, and is a horse and mule market of considerable importance. Among its manufactures are mattresses, syrup, bricks, pottery, cement and foundry products. In 1905 the total value of the city's factory product was \$1,349,026, being an increase of 89% since 1900. The city owns and operates its waterworks. The fort after which the city is named was established by the Federal government in 1842, at a time when the whole of eastern Kansas was still parcelled out among Indian tribes; it was abandoned in 1855. The town was platted in 1857, and Fort Scott was chartered as a city in 1860.

FORT SMITH, a city and the county-seat of Sebastian county, on the extreme W. border of Arkansas, U.S.A., lying about 440 ft. above sea-level, on the S. bank of the Arkansas river, at its junction with the Poteau, and at the point where the Arkansas breaks through the Boston mountains. Pop. (1890) 11,311; (1900) 11,587, of whom 2407 were of negro descent and 684 were foreign-born; (1910 census) 23,975. Transportation is afforded by the river and by six railways, the St Louis & San Francisco, the St Louis, Iron Mountain & Southern, the Arkansas Central, the Fort Smith & Western, the Midland Valley and the Kansas City Southern. A belt line round the business centre of the city facilitates freight transfers. Some of the business streets are unusually broad, and the streets in the residential district are well shaded. Fort Smith is the business centre of a fine agricultural country and of the Arkansas coal and natural gas region. It has extensive wholesale jobbing interests and a large miscellaneous trade, partly in its own manufactures, among which are cotton and timber products, chairs, mattresses and other furniture, wagons, brooms and bricks. In 1905 the total value of the factory product was \$2,329,454, an increase of 66.2% since 1900. The public schools have a rich endowment: the proceeds of lands (about

200 acres) once belonging to the local military reservation, which—except the part occupied by a national cemetery—was given by Congress to the city in 1884. Near the centre of the city are a Catholic academy, convent and infirmary; and there is a Carnegie library. A United States army post was established here in 1817; the town was laid out in 1821; and the county was created in 1851. Fort Smith was incorporated as a town in 1842, and was chartered as a city in 1845. All transportation was by river and wagon until 1876, when the railway was completed from Little Rock. The military post, in earlier years the chief depôt for the western forts, was abandoned in 1871. During the Civil War Fort Smith was strongly in sympathy with the Confederacy. The fort was seized by state troops in April 1861, and was reoccupied by the Union forces in September 1863. There was considerable unrest due to border "bush-whacking" throughout the war, and several skirmishes took place here in 1864. The area of the city was more than doubled in 1905.

FORTUNA (FORTUNE), an Italian goddess of great antiquity, but apparently not native at Rome, where, according to universal Roman tradition, she was introduced by the king Servius Tullius as Fors Fortuna, and established in a temple on the Etruscan side of the Tiber outside the city, and also under other titles in other shrines. In Latium she had two famous places of worship, one at Praeneste, where there was an oracle of *Fortuna primigenia* (the first-born), frequented especially by women who, as we may suppose, desired to know the fortunes of their children or their own fortune in child-birth; the other at Antium, well known from Horace's ode (i. 35). It is highly probable that Fortuna was never a deity of the abstract idea of chance, but represented the hopes and fears of men and especially of women at different stages of their life and experience; thus we find her worshipped as time went on under numerous cult-titles, such as *muliebris*, *virilis*, *hujusce diei*, *equestris*, *redux*, &c., which connected her supposed powers with individuals, groups of individuals, or particular occasions. Gradually she became more or less closely identified with the Gr. Τύχη, and was represented on coins, &c., with a cornucopia as the giver of prosperity, a rudder as the controller of destinies, and with a wheel, or standing on a ball, to indicate the uncertainty of fortune. In this semi-Greek form she came to be worshipped over the whole empire, and Pliny (*N.H.* ii. 22) declares that in his day she was invoked in all places and every hour. She even became identified with Isis, and as *Panthea* was supposed to combine the attributes of all other deities.

The best account of this difficult subject is to be found in Roscher's *Mythological Lexicon* (s.v.); see also Wissowa, *Religion und Kultus der Römer*, p. 206 foll. (W. V. F.*)

FORTUNATIANUS, ATILIUS, Latin grammarian, flourished in the 4th century A.D. He was the author of a treatise on metres, dedicated to one of his pupils, a youth of senatorial rank, who desired to be instructed in the Horatian metres. The manual opens with a discussion of the fundamental ideas of metre and the chief rules of prosody, and ends with a detailed analysis of the metres of Horace. The chief authorities used are Caesius Bassus and the Latin adaptation by Juba the grammarian of the Τέχνη of Heliodorus. Fortunatianus being a common name in the African provinces, it is probable that the author was a countryman of Juba, Terentianus Maurus and Victorinus.

Editions of the *Ars* in H. Keil, *Grammatici Latini*, vi., and separately by him (1885).

FORTUNATUS, the legendary hero of a popular European chap-book. He was a native, says the story, of Famagusta in Cyprus, and meeting the goddess of Fortune in a forest received from her a purse which was continually replenished as often as he drew from it. With this he wandered through many lands, and at Cairo was the guest of the sultan. Among the treasures which the sultan showed him was an old napless hat which had the power of transporting its wearer to any place he desired. Of this hat he feloniously possessed himself, and returned to Cyprus, where he led a luxurious life. On his death he left the

purse and the hat to his sons Ampedo and Andelosia; but they were jealous of each other, and by their recklessness and folly soon fell on evil days. The moral of the story is obvious: men should desire reason and wisdom before all the treasures of the world. In its full form the history of Fortunatus occupies in Karl Simrock's *Die deutschen Volksbücher*, vol. iii., upwards of 158 pages. The scene is continually shifted—from Cyprus to Flanders, from Flanders to London, from London to France; and a large number of secondary characters appear. The style and allusions indicate a comparatively modern date for the authorship; but the nucleus of the legend can be traced back to a much earlier period. The stories of Jonathas and the three jewels in the *Gesta Romanorum*, of the emperor Frederick and the three precious stones in the *Cento Novelle antiche*, of the Mazin of Khorassan in the *Thousand and one Nights*, and the flying scaffold in the *Bahar Danush*, have all a certain similarity. The earliest known edition of the German text of Fortunatus appeared at Augsburg in 1509, and the modern German investigators are disposed to regard this as the original form. Innumerable versions occur in French, Italian, Dutch and English. The story was dramatized by Hans Sachs in 1553, and by Thomas Dekker in 1600; and the latter's comedy appeared in a German translation in *Englische Komödien und Tragödien*, 1620. Ludwig Tieck has utilized the legend in his *Phantasmus*, and Adelbert von Chamisso in his *Peter Schlemihl*; and Ludwig Uhland left an unfinished narrative poem entitled "Fortunatus and his Sons."

See Dr Fr. W. V. Schmidt's *Fortunatus und seine Söhne, eine Zauber-Tragödie, von Thomas Decker, mit einem Anhang, &c.* (Berlin, 1819); Joseph Johann Görres, *Die deutschen Volksbücher* (1807).

FORTUNATUS, VENANTIUS HONORIUS CLEMENTIANUS (530-609), bishop of Poitiers, and the chief Latin poet of his time, was born near Ceneda in Treviso in 530. He studied at Milan and Ravenna, with the special object of excelling as a rhetorician and poet, and in 565 he journeyed to France, where he was received with much favour at the court of Sigbert, king of Austrasia, whose marriage with Brunhild he celebrated in an *epithalamium*. After remaining a year or two at the court of Sigbert he travelled in various parts of France, visiting persons of distinction, and composing short pieces of poetry on any subject that occurred to him. At Poitiers he visited Queen Radegunda, who lived there in retirement, and she induced him to prolong his stay in the city indefinitely. Here he also enjoyed the friendship of the famous Gregory of Tours and other eminent ecclesiastics. He was elected bishop of Poitiers in 599, and died about 609. The later poems of Fortunatus were collected in 11 books, and consist of hymns (including the *Vexilla regis prodeunt*, Englished by J. M. Neale as "The royal banners forward go"), epitaphs, poetical epistles, and verses in honour of his patroness Radegunda and her sister Agnes, the abbess of a nunnery at Poitiers. He also wrote a large poem in 4 books in honour of St Martin, and several lives of the saints in prose. His prose is stiff and mechanical, but most of his poetry has an easy rhythmical flow.

An edition of the works of Fortunatus was published by C. Brower at Fulda in 1603 (2nd ed., Mainz, 1617). The edition of M. A. Luschi (Rome, 1785) was afterwards reprinted in Migne's *Patrologiae cursus completus*, vol. lxxxviii. See the edition by Leo and Krusch (Berlin, 1881-1885). There are French lives by Nisard (1880) and Leroux (1885).

FORTUNE, ROBERT (1813-1880), Scottish botanist and traveller, was born at Kelloe in Berwickshire on the 16th of September 1813. He was employed in the botanical garden at Edinburgh, and afterwards in the Royal Horticultural Society's garden at Chiswick, and upon the termination of the Chinese War in 1842 was sent out by the Society to collect plants in China. His travels resulted in the introduction to Europe of many beautiful flowers; but another journey, undertaken in 1848 on behalf of the East India Company, had much more important consequences, occasioning the successful introduction into India of the tea-plant. In subsequent journeys he visited Formosa and Japan, described the culture of the silkworm and the manufacture of rice paper, and introduced many trees,

shrubs and flowers now generally cultivated in Europe. The incidents of his travels were related in a succession of interesting books. He died in London on the 13th of April 1880.

FORTUNY, MARIANO JOSE MARIA BERNARDO (1838-1874), Spanish painter, was born at Reus on the 11th of June 1838. His parents, who were in poor circumstances, sent him for education to the primary school of his native town, where he received some instruction in the rudiments of art. When he was twelve years old his parents died and he came under the care of his grandfather, who, though a joiner by trade, had made a collection of wax figures, with which he was travelling from town to town. In the working of this show the boy took an active part, modelling and painting many of the figures; and two years later, when he reached Barcelona, the cleverness of his handiwork made so much impression on some people in authority there that they induced the municipality to make him an allowance of forty-two francs monthly, so that he might be enabled to go through a systematic course of study. He entered the Academy of Barcelona and worked there for four years under Claudio Lorenzale, and in March 1857 he gained a scholarship that entitled him to complete his studies in Rome. Then followed a period of more than two years, during which he laboured steadily at copies of the old pictures to which he had access at Rome. To this period an end was put by the outbreak of the war between Spain and the emperor of Morocco, as Fortuny was sent by the authorities of Barcelona to paint the most striking incidents of the campaign. The expedition lasted for about six months only, but it made upon him an impression that was powerful enough to affect the whole course of his subsequent development, and to implant permanently in his mind a preference for the glitter and brilliancy of African colour. He returned to Spain in the summer of 1860, and was commissioned by the city of Barcelona to paint a large picture of the capture of the camps of Muley-el-Abbas and Muley-el-Hamed by the Spanish army. After making a large number of studies he went back to Rome, and began the composition on a canvas fifteen metres long; but though it occupied much of his time during the next few years, he never finished it. He busied himself instead with a wonderful series of pictures, mostly of no great size, in which he showed an astonishing command over vivacities of technique and modulations of colour. He visited Paris in 1868 and shortly afterwards married the daughter of Federico Madrazo, the director of the royal museum at Madrid. Another visit to Paris in 1870 was followed by a two years' stay at Granada, but then he returned to Rome, where he died somewhat suddenly on the 21st of November 1874 from an attack of malarial fever, contracted while painting in the open air at Naples and Portici in the summer of 1874.

The work which Fortuny accomplished during his short life is distinguished by a superlative facility of execution and a marvellous cleverness in the arrangement of brilliant hues, but the qualities of his art are those that are attainable by a master of technical resource rather than by a deep thinker. His insight into subtleties of illumination was extraordinary, his dexterity was remarkable in the extreme, and as a colourist he was vivacious to the point of extravagance. At the same time in such pictures as "La Vicaria" and "Choosing a Model," and in some of his Moorish subjects, like "The Snake Charmers" and "Moors playing with a Vulture," he showed himself to be endowed with a sensitive appreciation of shades of character and a thorough understanding of the peculiarities of a national type. His love of detail was instinctive, and he chose motives that gave him the fullest opportunity of displaying his readiness as a craftsman.

See Davillier, *Fortuny, sa vie, son œuvre, sa correspondance, &c.* (Paris, 1876); C. Yriarte, *Fortuny (Artistes célèbres series)* (Paris, 1889).

FORT WAYNE, a city and the county-seat of Allen county, Indiana, U.S.A., 102 m. N.E. of Indianapolis, at the point where the St Joseph and St Mary's rivers join to form the Maumee river. Pop. (1880) 26,880; (1890) 35,393; (1900) 45,115, of whom 6701 were foreign-born; (1910, census) 63,933. It is served by the Cincinnati, Hamilton & Dayton, the Fort Wayne,

Cincinnati & Louisville, the Grand Rapids & Indiana, the Lake Shore & Michigan Southern, the New York, Chicago & St Louis, the Pennsylvania and the Wabash railways, and also by inter-urban electric lines. The site of the city is high (about 770 ft. above sea-level) and level, and its land area was in 1906 a little more than 6 sq. m. The streets are laid out on a rectangular plan and bordered by a profusion of shade trees. The city has several parks, including Lawton Park (31 acres), in which there is a monument in honour of Major-General Henry Ware Lawton (1843-1899), who lived in Fort Wayne for a time, Lake Side Park (22 acres), Reservoir Park (13 acres), Piqua Park (1 acre), and Old Fort Park ($\frac{1}{4}$ acre), which is on the site of Old Fort Wayne. The educational institutions include the German Concordia Collegium (Lutheran), founded in 1839, and having 220 students in 1908, and the state school for feeble-minded youth (1879). The city has a Carnegie library. Fort Wayne is one of the most important railway centres in the Middle West, and several railways maintain here their principal car and repair shops, which add greatly to the value of its manufacturing industries; in 1905 it ranked first among the cities of the state in the value of cars constructed and repaired by steam-railway companies. The other manufactories include foundries and machine shops, iron and steel mills, knitting mills, planing mills, sash and door, car-wheel, electrical machinery, and woodenware factories and flour mills. In 1905 the total value of the factory product of the city was \$15,129,562, showing an increase of 34.3% since 1900.

The Miami Indians had several villages in the immediate neighbourhood, and the principal one, Kekionaga (Miami Town or Great Miami Village), was situated on the E. bank of the St Joseph river, within the limits of the present city. On the E. bank of the St Mary's a French trading post was built about 1680. In 1749-1750 the French fort (Fort Miami) was moved to the E. bank of the St Joseph. The English occupied the fort in 1760 and Pontiac captured it in May 1763, after a siege of more than three months. In 1790 the Miami villages were destroyed. In September 1794 General Anthony Wayne built on the S. bank of the Maumee river the stockade fort which was named in his honour, the site of which forms the present Old Fort Park. By the treaty of Greenville, concluded by General Wayne on the 3rd of August 1795, a piece of land 6 sq. m. in area, including the tract of the Miami towns, was ceded to the United States, and free passage to Fort Wayne and down the Maumee to Lake Erie was guaranteed to the people of the United States by the Indians. By the treaty of Fort Wayne, concluded by General W. H. Harrison on the 7th of June 1803, the tract about Vincennes reserved to the United States by the treaty of Greenville was described and defined; by the second treaty of Fort Wayne, concluded by Harrison on the 30th of September 1809, the Indians sold to the United States about 2,900,000 acres of land, mostly S.E. of the Wabash river. In September 1813 Fort Wayne was besieged by Indians, who withdrew on the arrival, on the 12th of September, of General Harrison with about 2700 men from Kentucky and Ohio. The fort was abandoned on the 19th of April 1819 and no trace of it remains. The first permanent settlement here was made in 1815, and the village was an important fur-trading depôt until 1830. The opening of the Wabash & Erie canal in 1843 stimulated its growth. A town was platted and was made the county-seat in 1824; and in 1840 Fort Wayne was chartered as a city.

See W. A. Brice, *History of Fort Wayne* (Ft. Wayne, 1868); John B. Dillon, *History of Indiana, from its Earliest Exploration by Europeans to the Close of the Territorial Government in 1816* (Indianapolis, Ind., 1859); and Charles E. Slocum, *History of the Maumee River Basin, from the Earliest Accounts to its Organization into Counties* (Dehance, Ohio, 1905).

FORT WILLIAM, the principal town of Thunder Bay district, Ontario, Canada, 426 m. (by rail) E.S.E. of Winnipeg, on the Kaministiquia river, about a mile from Lake Superior. It is the lake terminus of the Canadian Pacific railway, of the new Grand Trunk Pacific railway, and of several steamship lines. Port Arthur, the terminus of the Canadian Northern railway, lies 4 m. to the N.E. Fort William contains numerous grain

elevators, railway repair shops and docks, and has a large export trade in grain and other farm produce. Minerals are also exported from the mining district, of which it is the centre. Industries, such as saw, planing and flour mills, have also sprung up. The population was 4800 in 1901, but has since increased with great rapidity.

FORT WILLIAM, a police burgh of Inverness-shire, Scotland. Pop. (1901) 2087. It lies at the north-eastern end of Loch Linnhe, an arm of the sea, about 62 m. S.S.W. of Inverness by road or canal, and was, in bygone days, one of the keys of the Highlands. It is 122 $\frac{1}{2}$ m. N.E. of Glasgow by the West Highland railway. The fort, at first called Kilmallie, was built by General Monk in 1655 to hold the Cameron men in subjection, and was enlarged in 1690 by General Hugh Mackay, who renamed it after William III., the burgh then being known as Maryburgh in honour of his queen. Here the perpetrators of the massacre of Glencoe met to share their plunder. The Jacobites unsuccessfully besieged it in 1715 and 1746. The fort was dismantled in 1860, and demolished in 1890 to provide room for the railway and the station. Amongst the public buildings are the Belford hospital, public hall, court house and the low-level meteorological observatory, constructed in 1891, which was in connexion with the observatory on the top of Ben Nevis, until the latter was closed in 1904. Its great industry is distilling, and the distilleries, about 2 m. N.E., are a familiar feature in the landscape. Beyond the railway station stands the obelisk to the memory of Ewen MacLachlan (1775-1822), the Gaelic poet, who was born in the parish. Fort William is a popular tourist resort and place of call for the steamers passing through the Caledonian canal. The town is the point from which the ascent of Ben Nevis—4 $\frac{1}{2}$ m. E.S.E. as the crow flies—is commonly made. At Corpach, about 2 m. N., the Caledonian canal begins, the series of locks between here and Banavie—within little more than a mile—being known as "Neptune's Staircase." Both the Lochy and the Nevis enter Loch Linnhe immediately to the north of Fort William. A mile and a half from the town, on the Lochy, stands the grand old ruin of Inverlochy Castle, a massive quadrangular pile with a round tower at each corner, a favourite subject with landscape painters. Close by is the scene of the battle of the 2nd of February 1645, in which Montrose completely defeated the earl of Argyll. The modern castle, in the Scottish Baronial style, $1\frac{1}{2}$ m. to the N.E. of this stronghold and farther from the river, is the seat of Lord Abinger.

FORT WORTH, a city and the county-seat of Tarrant county, Texas, U.S.A., about 30 m. W. of Dallas, on the S. bank of the West Fork of the Trinity river. Pop. (1880) 6663; (1890) 23,076; (1900) 26,688, of whom 1793 were foreign-born and 4249 were negroes; (1910, census) 73,312. It is served by the Chicago, Rock Island & Gulf, the Fort Worth & Denver City, the Fort Worth & Rio Grande, and the St Louis, San Francisco & Texas of the "Frisco" system, the Gulf, Colorado & Santa Fé, the Houston & Texas Central, the International & Great Northern, the Missouri, Kansas & Texas, the St Louis South-Western, the Texas & Pacific, and the Trinity & Brazos Valley (Colorado & Southern) railways. Fort Worth is beautifully situated on a level space above the river. It is the seat of Fort Worth University (coeducational), a Methodist Episcopal institution, which was established as the Texas Wesleyan College in 1881, received its present name in 1889, comprises an academy, a college of liberal arts and sciences, a conservatory of music, a law school, a medical school, a school of commerce, and a department of oratory and elocution, and in 1907 had 802 students; the Polytechnic College (coeducational; Methodist Episcopal, South), which was established in 1890, has preparatory, collegiate, normal, commercial, and fine arts departments and a summer school, and in 1906 had 12 instructors and (altogether) 696 students; the Texas masonic manual training school; a kindergarten training school; St Andrews school (Protestant Episcopal), and St Ignatius Academy (Roman Catholic). There are several good business, municipal and county buildings, and a Carnegie library. On the 3rd of April 1909 a fire destroyed ten blocks in the centre of the city. Fort Worth lies in the

midst of a stock-raising and fertile agricultural region; there is an important stockyard and packing establishment just outside the city; and considerable quantities of cotton are raised in the vicinity. Among the products are packed meats, flour, beer, trunks, crackers, candy, paint, ice, paste, cigars, clothing, shoes, mattresses, woven wire beds, furniture and overalls; and there are foundries, iron rolling mills and tanneries. In 1905 the total value of the city's factory product was \$5,668,391, an increase of 62.5% since 1900; Fort Worth in 1900 ranked fifth among the cities of the state in the value of its factory product; in 1905 it ranked fourth. Fort Worth's numerous railways have given it great importance as a commercial centre. The municipality owns and operates the waterworks and the electric-lighting plant.

A military post was established here in 1849, being called first Camp Worth and then Fort Worth. It was abandoned in 1853. A settlement grew up about the fort, and the city was incorporated in 1873. The fort and the settlement were named in honour of General William Jenkins Worth (1794-1849), a native of Hudson, New York, who served in the War of 1812, commanded the United States forces against the Seminole Indians in 1817-1822, served under both General Taylor and General Scott in the Mexican War, distinguishing himself at Monterey (where he earned the brevet of major-general) and in other engagements, and later commanded the department of Texas. In 1907 Fort Worth adopted a commission form of government.

FORTY, the cardinal number equal to four tens. The word is derived from the O. Eng. *feōwertig*, a combination of *feōwer*, four, and *tig*, an old form of "ten," used as a suffix, cf. Icel. *tiu*, Dan. *ti*, ten, and Ger. *vierzig*, forty. The name "The Forty" has been given to various bodies composed of that number of members, particularly to a judicial body in ancient Athens, who tried small cases in the rural districts, and to a court of criminal jurisdiction and two civil appeal courts in the Venetian republic. The French Academy (see **ACADEMIES**) has also been known as "The Forty" or "The Forty Immortals." The period just before the repeal of the corn laws in the United Kingdom is frequently alluded to, particularly by the free trade school, as the "hungry forties"; and the "roaring forties" is a sailor's name for the stormy region between the 40th and 50th latitudes N. and S., but more particularly applied to the portion of the north Atlantic lying between those latitudes.

FORUM (Lat. from *foris*, "out of doors"), in Roman antiquity, any open place used, like the Greek *ἀγορά*, for the transaction of mercantile, judicial or political business, sometimes merely as a promenade. It was level, rectangular in form, surrounded by porticoes, basilicas, courts of law and other public buildings. In the laws of the Twelve Tables the word is used of the vestibule of a tomb (Cicero, *De legibus*, ii. 24); in a Roman camp the forum was an open place immediately beside the praetorium; and the term was no doubt originally applied generally to the space in front of any public building or gateway. In Rome (*q.v.*) itself, however, during the period of the early history, forum was almost a proper name, denoting the flat and formerly marshy space between the Palatine and Capitoline hills (also called Forum Romanum), which probably even during the regal period afforded the accommodation necessary for such public meetings as could not be held within the area Capitolina. In early times the Forum Romanum was used for athletic games, and over the porticoes were galleries for spectators; there were also shops of various kinds. But with the growth of the city and the increase of provincial business, more than one forum became necessary, and under the empire a considerable number of *civilia* (judicial) and *venalia* (mercantile) fora came into existence. In addition to the Forum Romanum, the Fora of Caesar and Augustus belonged to the former class; the Forum *boarium* (cattle), *holitorium* (vegetable), *pisarium* (fish), *pistorium* (bread), *vinarium* (wine), to the latter. The Fora of Nerva (also called *transitorium* or *perivium*, because a main road led through it to the Forum Romanum), Trajan, and Vespasian, although partly intended to facilitate the course of public

business, were chiefly erected to embellish the city. The construction of separate markets was not, however, necessarily the rule in the provincial fora; thus, in Pompeii, at the north-east end of the forum, there was a *macellum* (market), and shops for provisions and possibly money changers, and on the east side a building supposed to have been the clothworkers' exchange, and at Timgad in North-Africa (a military colony founded under Trajan) the whole of the south side of the forum was occupied by shops. The forum was usually paved, and although on festal occasions chariots were probably driven through, it was not a thoroughfare and was enclosed by gates at the entrances, of which traces have been found at Pompeii. When the sites for new towns were being selected, that for the forum was in the centre, and the two main streets crossed one another close to but not through it. At Timgad the main streets are some 5 or 6 ft. lower than the forum. The word *forum* frequently appears in the names of Roman market towns; as, for example, in Forum Appii, Forum Julii (*Fréjus*), Forum Livii (*Forli*), Forum Sempronii (*Fossombrone*). These *fora* were distinguished from mere *vici* by the possession of a municipal organization, which, however, was less complete than that of a prefecture. In legal phraseology, which distinguishes the *forum commune* from the *forum privilegiatum*, and the *forum generale* from the *forum speciale*, the word is practically equivalent to "court" or "jurisdiction."

For the fora at Rome, see **ROME: Archaeology**, and works quoted.

FORUM APPII, an ancient post station on the Via Appia, 43 m. S.E. of Rome, founded, no doubt, by the original constructor of the road. Horace mentions it as the usual halt at the end of the first day's journey from Rome, and describes it as full of boatmen and cheating innkeepers. The presence of the former was due to the fact that it was the starting-point of a canal which ran parallel to the road through the Pomptine Marshes, and was used instead of it at the time of Strabo and Horace (see **APPIA, VIA**). It is mentioned also as a halting place in the account of Paul's journey to Rome (Acts xviii. 15). Under Nerva and Trajan the road was repaired; one inscription records expressly the paving with silex (replacing the former gravelling) of the section from Tripontium, 4 m. N.W., to Forum Appii; the bridge near Tripontium was similarly repaired, and that at Forum Appii, though it bears no inscription, is of the same style. Only scanty relics of antiquity have been found here; a post station was placed here by Pius VI. when the Via Appia was reconstructed. (T. As.)

FORUM CLODII, a post station on the Via Clodia, about 23 m. N.W. of Rome (not 32 m. as in the *Antonine Itinerary*), situated above the western bank of the Lacus Sabatinus (mod. Lake of Bracciano), and connected with the Via Cassia at Vacanae by a branch road which ran round the N. side of the lake (*Ann. Inst.*, 1859, 43). The site is marked by the church of SS. Marcus, Marcellianus and Liberatus, which was founded in the 8th or 9th century A.D. Inscriptions mentioning the Foroclodenses have come to light on the spot; and an inscription of the Augustan period, which probably stood over the door of a villa, calls the place Pausilypon—a name justified by the beauty of the site.

See *Notizie degli scavi* (1889), 5; D. Vaglieri, *ibid.* (1895), 342.

FORUM TRAIANI (mod. *Fordongianus*), an ancient town of Sardinia, on the river Thyrsus (Tirso), and a station on the Roman road through the centre of the island from Carales to Olbia and Turris Libisonis. Many of its ruins have been destroyed since 1860. The best preserved are the baths, erected over hot mineral springs. The tanks for collecting the water and the large central *piscino* are noteworthy. The bridge over the Tirso has been to some extent modernized. On the opposite bank are the scanty remains of an amphitheatre. Not far off is a group of *muroghi*, of which that of St Barbara in the commune of Villanova Truschedda is one of the finest.

See Taramelli in *Notizie degli scavi* (1903), 469.

FOSBROKE, THOMAS DUDLEY (1770-1842), English antiquary, was born in London on the 27th of May 1770. He was educated at St Paul's school and Pembroke College, Oxford,

graduating M.A. in 1792. In that year he was ordained and became curate of Horsley, Gloucestershire, where he remained till 1810. He then removed to Walford in Herefordshire, and remained there the rest of his life, as curate till 1830, and afterwards as vicar. His first important work, *British Monachism* (2 vols., 1802), was a compilation, from manuscripts in the British Museum and Bodleian libraries, of facts relating to English monastic life. In 1799 Fosbroke had been elected fellow of the Society of Antiquaries. The work for which he is best remembered, the *Encyclopaedia of Antiquities*, appeared in 1824. A sequel to this, *Foreign Topography*, was published in 1828. Fosbroke published many other volumes. He died at Walford on the 1st of January 1842.

FOSCARI, FRANCESCO (1373-1457), doge of Venice, belonged to a noble Venetian family, and held many of the highest offices of the republic—ambassador, president of the Forty, member of the Council of Ten, inquisitor, procurator of St Mark, *avogadore di comun*, &c. His first wife was Maria Priuli and his second Maria Nani; of his many children all save one son (Jacopo) died young. But although a capable administrator he was ambitious and adventurous, and the reigning doge Tommaso Mocenigo, when speaking on his deathbed of the various candidates for the succession, warned the council against electing Foscari, who, he said, would perpetually plunge the republic into disastrous and costly wars. Nevertheless Foscari was elected (1423) and reigned for thirty-four years. In proclaiming the new doge the customary formula which recognized the people's share in the appointment and asked for their approval—the last vestige of popular government—was finally dropped.

Foscari's reign bore out Mocenigo's warning and was full of wars on the *terra ferma*, and through the doge's influence Venice joined the Florentines in their campaign against Milan, which was carried on with varying success for eight years. In 1430 an attempt was made on Foscari's life by a noble to whom he had refused an appointment; and three years later a conspiracy of young bloods to secure the various offices for themselves by illicit intrigues was discovered. These events, as well as the long and expensive wars and the unsatisfactory state of Venetian finances, induced Foscari to ask permission to abdicate, which was, however, refused. In 1444 began that long domestic tragedy by which the name of Foscari has become famous. The doge's son Jacopo, a cultivated and intelligent but frivolous and irresponsible youth, was in that year accused of the serious crime of having accepted presents from various citizens and foreign princes who either desired government appointments or wished to influence the policy of the republic. Jacopo escaped, but was tried in contumacy before the Council of Ten and condemned to be exiled to Napoli di Romania (Nauplia) and to have his property confiscated. But the execution of the sentence was delayed, as he was lying ill at Trieste, and eventually the penalty was commuted to banishment at Treviso (1446). Four years later Ermolao Donato, a distinguished official who had been a member of the Ten at the time of the trial, was assassinated and Jacopo Foscari was suspected of complicity in the deed. After a long inquiry he was brought to trial for the second time, and although all the evidence clearly pointed to his guilt the judges could not obtain a confession from the accused, and so merely banished him to Candia for the rest of his life, with a pension of two hundred ducats a year. In 1456 the council received information from the rector (governor) of Candia to the effect that Jacopo Foscari had been in treasonable correspondence with the duke of Milan and the sultan of Turkey. He was summoned to Venice, tried and condemned to a year's imprisonment, to be followed by a return to his place of exile. His aged father was allowed to see him while in prison, and to Jacopo's entreaties that he should obtain a full pardon for him, he replied advising him to bear his punishment without protest. When the year was up Jacopo returned to Candia, where he died in January 1457. The doge was overwhelmed with grief at this bereavement and became quite incapable of attending to business. Consequently the council decided to ask him to abdicate;

at first he refused, but was finally obliged to conform to their wishes and retired on a yearly pension of 1500 ducats. Within a week Pasquale Malipiero was elected in his place and two days later (1st of November 1457) Francesco Foscari was dead.

The story is a very sad and pathetic one, but legend has added many picturesque though quite apocryphal details, most of them tending to show the iniquity and harshness of Jacopo's judges and accusers, whereas, as we have shown, he was treated with exceptional leniency. The most accurate account is contained in S. Romanin's *Storia documentata di Venezia*, lib. x. cap. iv. vii. and x. (Venice, 1855); where the original authorities are quoted; see also Berlan, *I due Foscari* (Turin, 1852). Among the poetical works on the subject Byron's tragedy is the most famous (1821), and Roger's poem *Italy* (1821); Giuseppe Verdi composed an opera on the subject entitled *I due Foscari*. (L. V. *)

FOSCOLO, UGO (1778-1827), Italian writer, was born at Zante in the Ionian Isles on the 26th of January 1778. On the death of his father, a physician at Spalatro, in Dalmatia, the family removed to Venice, and in the University of Padua Foscolo prosecuted the studies begun in the Dalmatian grammar school. The fact that amongst his Paduan masters was the abbé Cesarotti, whose version of Ossian had made that work highly popular in Italy, was not without influence on Foscolo's literary tastes, and his early knowledge of modern facilitated his studies in ancient Greek. His literary ambition revealed itself by the appearance in 1797 of his tragedy *Tieste*—a production which obtained a certain degree of success. Foscolo, who, from causes not clearly explained, had changed his Christian name Niccolò to that of Ugo, now began to take an active part in the stormy political discussions which the fall of the republic of Venice had provoked. He was a prominent member of the national committees, and addressed an ode to Napoleon the liberator, expecting from the military successes of the French general, not merely the overthrow of the effete Venetian oligarchy, but the establishment of a free republican government.

The treaty of Campo Formio (17th Oct. 1797), by which Napoleon handed Venice over to the Austrians, gave a rude shock to Foscolo, but did not quite destroy his hopes. The state of mind produced by that shock is reflected in the *Letters of Jacopo Ortis* (1798), a species of political *Werther*,—for the hero of Foscolo embodies the mental sufferings and suicide of an undecieved Italian patriot just as the hero of Goethe places before us the too delicate sensitiveness embittering and at last cutting short the life of a private German scholar. The story of Foscolo, like that of Goethe, had a groundwork of melancholy fact. Jacopo Ortis had been a real personage; he was a young student of Padua, and committed suicide there under circumstances akin to those described by Foscolo. At this period Foscolo's mind appears to have been only too familiar with the thought of suicide. Cato and the many classical examples of self-destruction scattered through the pages of Plutarch appealed to the imaginations of young Italian patriots as they had done in France to those of the heroes and heroines of the Gironde. In the case of Foscolo, as in that of Goethe, the effect produced on the writer's mind by the composition of the work seems to have been beneficial. He had seen the ideal of a great national future rudely shattered; but he did not despair of his country, and sought relief in now turning to gaze on the ideal of a great national poet. At Milan, whither he repaired after the fall of Venice, he was engaged in other literary pursuits besides the composition of *Ortis*. The friendship formed there with the great poet Parini was ever afterwards remembered with pride and gratitude. The friendship formed with another celebrated Milanese poet soon gave place to a feeling of bitter enmity. Still hoping that his country would be freed by Napoleon, he served as a volunteer in the French army, took part in the battle of the Trebbia and the siege of Genoa, was wounded and made prisoner. When released he returned to Milan, and there gave the last touches to his *Ortis*, published a translation of and commentary upon *Callimachus*, commenced a version of the *Iliad*, and began his translation of Sterne's *Sentimental Journey*. The result of a memorandum prepared for Lyons, where, along with other Italian delegates, he was to have laid before Napoleon the state of Italy, only proved that the views cherished by him for his

country were too bold to be even submitted to the dictator of France. The year 1807 witnessed the appearance of his *Carme sui sepolcri*, of which the entire spirit and language may be described as a sublime effort to seek refuge in the past from the misery of the present and the darkness of the future. The mighty dead are summoned from their tombs, as ages before they had been in the masterpieces of Greek oratory, to fight again the battles of their country. The inaugural lecture on the origin and duty of literature, delivered by Foscolo in January 1809 when appointed to the chair of Italian eloquence at Pavia, was conceived in the same spirit. In this lecture Foscolo urged his young countrymen to study letters, not in obedience to academic traditions, but in their relation to individual and national life and growth. The sensation produced by this lecture had no slight share in provoking the decree of Napoleon by which the chair of national eloquence was abolished in all the Italian universities. Soon afterwards Foscolo's tragedy of *Ajax* was represented but with little success at Milan, and its supposed allusions to Napoleon rendering the author an object of suspicion, he was forced to remove from Milan to Tuscany. The chief fruits of his stay in Florence are the tragedy of *Ricciarda*, the *Ode to the Graces*, left unfinished, and the completion of his version of the *Sentimental Journey* (1813). His version of Sterne is an important feature in his personal history. When serving with the French he had been at the Boulogne camp, and had traversed much of the ground gone over by Yorick; and in his memoir of Didimo Chericco, to whom the version is ascribed, he throws much curious light on his own character. He returned to Milan in 1813, until the entry of the Austrians; thence he passed into Switzerland, where he wrote a fierce satire in Latin on his political and literary opponents; and finally he sought the shores of England at the close of 1816.

During the eleven years passed by Foscolo in London, until his death there, he enjoyed all the social distinction which the most brilliant circles of the English capital confer on foreigners of political and literary renown, and experienced all the misery which follows on a disregard of the first conditions of domestic economy. His contributions to the *Edinburgh* and *Quarterly Reviews*, his dissertations in Italian on the text of Dante and Boccaccio, and still more his English essays on Petrarch, of which the value was enhanced by Lady Dacre's admirable translations of some of Petrarch's finest sonnets, heightened his previous fame as a man of letters. But his want of care and forethought in pecuniary matters involved him in much embarrassment, and at last consigned him to a prison; and when released he felt bitterly the change in his social position, and the coldness now shown to him by many whom he had been accustomed to regard as friends. His general bearing in society—if we may accept on this point the testimony of so keen an observer and so tolerant a man as Sir Walter Scott—had unhappily not been such as to gain and retain lasting friendships. He died at Turnham Green on the 10th of October 1827. Forty-four years after his death, in 1871, his remains were brought to Florence, and with all the pride, pomp and circumstance of a great national mourning, found their final resting-place beside the monuments of Macchiavelli and Alfieri, of Michelangelo and Galileo, in Italy's Westminster Abbey, the church of Santa Croce. To that solemn national tribute Foscolo was fully entitled. For the originality of his thoughts and the splendour of his diction his country honours him as a great classic author. He had assigned to the literature of his nation higher aims than any which it previously recognized. With all his defects of character, and through all his vicissitudes of fortune, he was always a sincere and courageous patriot.

Ample materials for the study of Foscolo's character and career may be found in the complete series of his works published in Florence by Le Monnier. The series consists of *Prose letterarie*, (4 vols., 1850); *Epistolario* (3 vols., 1854); *Prose politiche* (1 vol., 1850); *Poesie* (1 vol., 1856); *Lettere di Ortis* (1 vol., 1858); *Saggi di critica storico-letteraria* (1st vol., 1859; 2nd vol., 1862). To this series must be added the very interesting work published at Leghorn in 1876, *Lettere inedite del Foscolo, del Giordani, e della Signora di Staël, a Vincenzo Monti*. The work published at Florence in the summer of 1878, *Vita di Ugo Foscolo, di Pellegrino Artusi*, throws

much doubt on the genuineness of the text in Foscolo's writings as given in the complete Florence edition, whilst it furnishes some curious and original illustrations of Foscolo's familiarity with the English language. (J. M. S.)

FOSS, EDWARD (1787–1870), English lawyer and biographer, was born in London on the 16th of October 1787. He was a solicitor by profession, and on his retirement from practice in 1840, he devoted himself to the study of legal antiquities. His *Judges of England* (9 vols., 1848–1864) is a standard work, characterized by accuracy and extensive research. *Biographia Juridica, a Biographical Dictionary of English Judges*, appeared shortly after his death. He assisted in founding the Incorporated Law Society, of which he was president in 1842 and 1843. He died of apoplexy on the 27th of July 1870.

FOSSANO, a town and episcopal see of Piedmont, Italy, in the province of Cuneo, 15 m. N.E. of it by rail, 1180 ft. above sea-level. Pop. (1901) 7696 (town), 18,175 (commune). It has an imposing castle with four towers, begun by Filippo d'Acacia in 1314. The cathedral was reconstructed at the end of the 18th century. The place began to acquire some importance in the 13th century. It appears as a commune in 1237, but in 1251 had to yield to Asti. It finally surrendered in 1314 to Fillippo d'Acacia, whose successor handed it over to the house of Savoy. It lies on the main line from Turin to Cuneo, and has a branch line to Mondovì.

FOSSANUOVA, an abbey of Italy, in the province of Rome, near the railway station of Sonnino, 64 m. S.E. of Rome. It is the finest example of a Cistercian abbey, and of the Burgundian Early Gothic style, in Italy, and dates from the end of the 12th to the end of the 13th century. The church (1187–1208) is closely similar to that of Casamari. The other conventual buildings also are noteworthy. Thomas Aquinas died here in 1274.

See C. Enlart, *Origines françaises de l'architecture gothique en Italie* (Paris, 1894) (*Bibliothèque des écoles françaises d'Athènes et de Rome*, fasc. 66).

FOSSE (or Foss) **WAY**, the Early English name of a Roman road or series of roads in Britain, used later by the English, running from Lincoln by Leicester and Bath to Exeter. Almost all the Roman line is still in use as modern road or lane. It passes from Lincoln through Newark and Leicester (the Roman *Ratae*) to High Cross (*Venonae*), where it intersects Watling Street at a point often called "the centre of England." Hence it runs to Moreton-in-the-Marsh, Cirencester, Bath and Ilchester, crosses the hills near Chard, Axminster and Honiton, and enters Exeter. Antiquaries have taken it farther, usually to Totnes, but without warrant. (See further under **ERMINE STREET**.) (F. J. H.)

FOSSICK (probably an English dialectical expression, meaning fussy or troublesome), a term applied by the gold diggers of Australia to the search for gold by solitary individuals, in untried localities or in abandoned diggings. A "fossicker," or pocket miner, is one who buys up the right to search old claims, in the hope of finding gold overlooked by previous diggers.

FOSSOMBRONE (anc. *Forum Sempronii*), a town and episcopal see of the Marche, Italy, in the province of Pesaro and Urbino, 11 m. E.S.E. of the latter by road, 394 ft. above sea-level. Pop. (1901) town, 7531, commune, 10,847. The town is situated in the valley of the Metauro, in the centre of fine scenery, at the meeting-point of roads to Fano, to the Furlo pass and Fossato di Vico (the ancient Via Flaminia), to Urbino and to Sinigaglia, the last crossing the river by a fine bridge. The cathedral, rebuilt in 1772–1784, contains the chief work of the sculptor Domenico Rosselli of Rovezzano, a richly sculptured *ancona* of 1480. S. Francesco has a lunette by him over the portal. The library, founded by a nephew of Cardinal Passionei, contains some antiquities. Above the town is a medieval castle. There is a considerable trade in silk.

The ancient Forum Sempronii lay about 2 m. to the N.E. at S. Martino al Piano, where remains still exist. It was a station on the Via Flaminia and a *municipium*. The date of its foundation is not known. Excavations in 1879–1880 led to the discovery of a house and of other buildings on the ancient road (A.

Vernarecci in *Notizie degli scavi*, 1880, 458). It already had a bishop in the years 499–502. In 1295 the Malatesta obtained possession of it, and kept it until 1444, when it was sold, with Pesaro, to Federico di Montefeltrò of Urbino, and with the latter it passed to the papacy under Urban VIII. in 1631.

FOSSOMBRONI, VITTORIO, COUNT (1754–1844), Tuscan statesman and mathematician, was born at Arezzo. He was educated at the university of Pisa, where he devoted himself particularly to mathematics. He obtained an official appointment in Tuscany in 1782, and twelve years later was entrusted by the grand duke with the direction of the works for the drainage of the Val di Chiana, on which subject he had published a treatise in 1789. In 1796 he was made minister for foreign affairs, but on the French occupation of Tuscany in 1799 he fled to Sicily. On the erection of the grand duchy into the ephemeral kingdom of Etruria, under the queen-regent Maria Louisa, he was appointed president of the commission of finance. In 1809 he went to Paris as one of the senators for Tuscany to pay homage to Napoleon. He was made president of the legislative commission on the restoration of the grand duke Ferdinand III. in 1814, and subsequently prime minister, which position he retained under the grand duke Leopold II. His administration, which was only terminated by his death, greatly contributed to promote the well-being of the country. He was the real master of Tuscany, and the bases of his rule were equality of all subjects before the law, honesty in the administration of justice and toleration of opinion, but he totally neglected the moral improvement of the people. At the age of seventy-eight he married, and twelve years afterwards died, in 1844.

BIBLIOGRAPHY.—Gino Capponi, *Il Conte V. Fossombroni*, A. von Reumont, *Geschichte Toscanas unter dem Hause Lothringen-Habsburg* (Gotha, 1877); Zobi, *Storia civile della Toscana* (Florence, 1850–1853); Galeotti, *Delle Leggi e dell' amministrazione della Toscana* (Florence, 1847); Baldasseroni, *Leopoldo II.* (Florence, 1871); see also under **CAPPONI**, **GINO**; **FERDINAND III.**, of Tuscany, and **LEOPOLD II.**, of Tuscany. (L. V. *)

FOSTER, SIR CLEMENT LE NEVE (1841–1904), English geologist and mineralogist, the second son of Peter Le Neve Foster (for many years secretary of the Society of Arts), was born at Camberwell on the 23rd of March 1841. After receiving his early education at Boulogne and Amiens, he studied successively at the Royal School of Mines in London and at the mining college of Freiburg in Saxony. In 1860 he joined the Geological Survey in England, working in the Wealden area and afterwards in Derbyshire. Conjointly with William Topley (1841–1894) he communicated to the Geological Society of London in 1865 the now classic paper “On the superficial deposits of the Valley of the Medway, with remarks on the Denudation of the Weald.” In this paper the sculpturing of the Wealden area by rain and rivers was ably advocated. Retiring from the Geological Survey in 1865, Foster devoted his attention to mineralogy and mining in Cornwall, Egypt and Venezuela. In 1872 he was appointed an inspector of mines under the home office for the S.W. of England, and in 1880 he was transferred to the N. Wales district. In 1890 he was appointed professor of mining at the Royal College of Science and he held this post until the close of his life. His later work is embodied largely in the reports of mines and quarries issued annually by the home office. He was distinguished for his extensive scientific and practical knowledge of metalliferous mining and stone quarrying. He was elected F.R.S. in 1892 and was knighted in 1903. While investigating the cause of a mining disaster in the Isle of Man in 1897 his constitution suffered much injury from carbonic oxide gas, and he never fully recovered from the effects. He died in London on the 19th of April 1904. He published *Ore and Stone Mining*, 1894 (ed. 5, 1904); and *The Elements of Mining and Quarrying*, 1903.

FOSTER, GEORGE EULAS (1847–), Canadian politician and financier, was born in New Brunswick on the 3rd of September 1847, of U.E. Loyalist descent. After a brilliant university career at the university of Brunswick, at Edinburgh and Heidelberg, he returned to Canada and taught in various local schools, eventually becoming professor of classics and

history in the local university. In 1882 he became Conservative member for King's County, N.B., in the Dominion parliament, and in 1885 entered the cabinet of Sir John Macdonald as minister of marine and fisheries; in 1888 he became minister of finance, which position he held till the defeat of his party in 1896. A careful and even brilliant financier, and a keen debater, he became known as a strong believer in protection for Canadian industries and in preferential trade within the British empire.

FOSTER, JOHN (1770–1843), English author and dissenting minister, generally known as the “Essayist,” was born in a small farmhouse near Halifax, Yorkshire, on the 17th of September 1770. Partly from constitutional causes, but partly also from the want of proper companions, as well as from the grave and severe habits of his parents, his earlier years were enshrouded in a somewhat gloomy and sombre atmosphere, which was never afterwards wholly dissipated. His youthful energy, finding no proper outlet, developed within him a tendency to morbid intensity of thought and feeling; and, according to his own testimony, before he was twelve years old he was possessed of a “painful sense of an awkward but entire individuality.”

The small income accruing to Foster's parents from their farm they supplemented by weaving, and at an early age he began to assist them by spinning wool by the hand wheel, and from his fourteenth year by weaving double stuffs. Even “when a child,” however, he had the “feelings of a foreigner in the place”; and though he performed his monotonous task with conscientious diligence, he succeeded so indifferently in fixing his wandering thoughts upon it that his work never without difficulty passed the ordeal of inspection. He had acquired a great taste for reading, to gratify which he sometimes shut himself up alone in a barn, afterwards working at his loom “like a horse,” to make up for lost time. He had also at this period “a passion for making pictures with a pen.” Shortly after completing his seventeenth year he became a member of the Baptist church at Hebden Bridge, with which his parents were connected; and with the view of preparing himself for the ministerial office he began about the same time to attend a seminary at Brearley Hall conducted by his pastor Dr Fawcett.

After remaining three years at Brearley Hall he was admitted to the Baptist College, Bristol, and on finishing his course of study at this institution he obtained an engagement at Newcastle-on-Tyne, where he preached to an audience of less than a hundred persons, in a small and dingy room situated near the river at the top of a flight of steps called Tuthill Stairs. At Newcastle he remained only three months. In the beginning of 1793 he proceeded to Dublin, where, after failing as a preacher, he attempted to revive a classical and mathematical school, but with so little success that he did not prosecute the experiment for more than eight or nine months. From 1797 to 1799 he was minister of a Baptist church at Chichester, but though he applied himself with more earnestness and perseverance than formerly to the discharge of his ministerial duties, his efforts produced little apparent impression, and the gradual diminution of his hearers necessitated his resignation. After employing himself for a few months at Battersea in the instruction of twenty African youths brought to England by Zachary Macaulay, with the view of having them trained to aid as missionaries to their fellow-countrymen, he in 1800 accepted the charge of a small congregation at Downend, Bristol, where he continued about four years. In 1804, chiefly through the recommendation of Robert Hall, he became pastor of a congregation at Frome, but a swelling in the thyroid gland compelled him in 1806 to resign his charge. In the same year he published the volume of *Essays* on which his literary fame most largely if not mainly rests. They were written in the form of letters addressed to the lady whom he afterwards married, and consist of four papers,—“On a Man writing Memoirs of himself”; “On Decision of Character”; “On the Application of the Epithet Romantic”; and “On some Causes by which Evangelical Religion has been rendered unacceptable to Men of Cultivated Taste.” The success of this work was immediate, and was so considerable that on resigning his charge he determined to adopt literature as his profession.

The *Eclectic Review* was the only periodical with which he established a connexion; but his contributions to that journal, which were begun in 1807, number no fewer than 185 articles. On his marriage in May 1808 he removed to Bourton-on-the-Water, a small village in Gloucestershire, where he remained till 1817, when he returned to Downend and resumed his duties to his old congregation. Here he published in 1820 his *Essay on Popular Ignorance*, which was the enlargement of a sermon originally preached on behalf of the British and Foreign School Society. In 1821 he removed to Stapleton near Bristol, and in 1822 he began a series of fortnightly lectures at Broadmead chapel, Bristol, which were afterwards published. On the settlement of Robert Hall at Bristol this service was discontinued, as in such circumstances it appeared to Foster to be "altogether superfluous and even bordering on impertinent." The health of Foster during the later years of his life was somewhat infirm, the result chiefly of the toil and effort of literary composition; and the death of his only son, his wife and the greater number of his most intimate friends combined with his bodily ailments to lend additional sombreness to his manner of regarding the events and arrangements of the present world—the "visage of death" being almost his "one remaining luminary." He died at Stapleton on the 15th of October 1843.

The cast of Foster's mind was meditative and reflective rather than logical or metaphysical, and though holding moderately Calvinistic views, his language even in preaching very seldom took the mould of theological forms. Though always retaining his connexion with the Baptist denomination, the evils resulting from organized religious communities seemed to him so great that he came to be "strongly of opinion that churches are useless and mischievous institutions, and the sooner they are dissolved the better." The only Christian observances which he regarded as of any importance were public worship and the Lord's Supper, and it so happened that he never administered the ordinance of baptism. His cast of thought is largely coloured by a constant reference to the "endless future." He was a firm believer in supernatural appearances, and cherished a longing hope that a ray of light from the other world might sometimes in this way be vouchsafed to mortals. As a writer he was most painstaking and laborious in his choice of diction, and his style has its natural consequent defects, though the result is eloquent in its way.

Besides the works already alluded to, Foster was the author of a *Discourse on Missions* (1818); "Introductory Essay" to Doddridge's *Rise and Progress of Religion* (1825); "Observations on Mr Hall's Character as a Preacher," prefixed to the collected edition of Hall's *Works* (1832); an "Introduction" to a pamphlet by Mr Marshman on the Serampore Missionaries; several political letters to the *Morning Chronicle*, and contributions to the *Eclectic Review*, published posthumously in 2 vols., 1844. *His Life and Correspondence*, edited by J. E. Ryland, was published in 1846.

FOSTER, SIR MICHAEL (1836–1907), English physiologist, was born at Huntingdon on the 8th of March 1836. After graduating in medicine at London University in 1859, he began to practise in his native town, but in 1867 he returned to London as teacher of practical physiology at University College, where two years afterwards he became professor. In 1870 he was appointed by Trinity College, Cambridge, to its praelectorship in physiology, and thirteen years later he became the first occupant of the newly-created chair of physiology in the university, holding it till 1903. He excelled as a teacher and administrator, and had a very large share in the organization and development of the Cambridge biological school. From 1881 to 1903 he was one of the secretaries of the Royal Society, and in that capacity exercised a wide influence on the study of biology in Great Britain. In 1899 he was created K.C.B., and served as president of the British Association at its meeting at Dover. In the following year he was elected to represent the university of London in parliament. Though returned as a Unionist, his political action was not to be dictated by party considerations, and he gravitated towards Liberalism; but he played no prominent part in parliament and at the election of 1906 was defeated. His chief writings were a *Textbook of Physiology*

(1876), which became a standard work, and *Lectures on the History of Physiology in the 16th, 17th and 18th Centuries* (1901), which consisted of lectures delivered at the Cooper Medical College, San Francisco, in 1900. He died suddenly in London on the 29th of January 1907.

FOSTER, MYLES BIRKET (1825–1899), English painter, was born at North Shields. At the age of sixteen he entered the workshop of Ebenezer Landells, a wood engraver, with whom he worked for six years as an illustrative draughtsman, devoting himself mainly to landscape. During the succeeding fifteen years he became famous as a prolific and accomplished illustrator, but about 1861 abandoned illustration for painting, and gained wide popularity by his pictures, chiefly in water colours, of landscapes and rustic subjects, with figures, mainly of children. He was elected in 1860 associate and in 1862 full member of the Royal Society of Painters in Water Colours. His work is memorable for its delicacy and minute finish, and for its daintiness and pleasantness of sentiment.

See *Birket Foster, his Life and Work* (extra number of the *Art Journal*) by Marcus B. Huish (1890), an interesting sketch; and *Birket Foster, R.W.S.*, by H. M. Cundall (London, 1906), a very complete and fully illustrated biography.

FOSTER, STEPHEN COLLINS (1826–1864), American song and ballad writer, was born near Pittsburg, Pennsylvania, on the 4th of July 1826. He was the youngest child of a merchant of Irish descent who became a member of the state legislature and was related by marriage to President Buchanan. Stephen early showed talent for music, and played upon the flageolet, the guitar and the banjo; he also acquired a fair knowledge of French and German. He was sent to school in Towanda, Pennsylvania, and later to Athens, Pennsylvania, and when thirteen years old he wrote the song "Sadly to Mine Heart Appealing." At sixteen he wrote "Open thy Lattice, Love"; at seventeen he entered his brother's business house, Cincinnati, Ohio, where he remained about three years, composing meanwhile such popular pieces as "Old Uncle Ned," "O Susannah!" and others. He then adopted song-writing as a profession. His chief successes were songs written for the negro melodists or Christy minstrels. Besides those mentioned the following attained great popularity: "Nelly was a Lady," "Old Kentucky Home," "Old Folks at Home," "Massa's in de Cold, Cold Ground," &c. For these and other songs the composer received considerable sums, "Old Folks at Home" bringing him, it is said, 15,000 dollars. For most of his songs Foster wrote both songs and music. In 1850 he married and moved to New York, but soon returned to Pittsburg. His reputation rests chiefly on his negro melodies, many of which have been popular on both sides of the Atlantic and sung in many tongues. "Old Black Joe," the last of these negro melodies, appeared in 1861. His later songs were sentimental ballads. Among these are "Old Dog Tray," "Gentle Annie," "Willie, we have missed you," &c. His "Come where my Love lies Dreaming" is a well known vocal quartet. Although as a musician and composer Foster has little claim to high rank, his song-writing gives him a prominent place in the modern developments of popular music. He died at New York on the 13th of January 1864.

FOSTORIA, a city, partly in Seneca, partly in Hancock, and partly in Wood county, Ohio, U.S.A., 35 m. S. by E. of Toledo. Pop. (1890) 7070; (1900) 7730 (584 foreign-born); (1910) 9597. It is served by the Baltimore & Ohio, the New York, Chicago & St Louis, the Ohio Central, the Lake Erie & Western, and the Hocking Valley railways, and by two interurban electric lines. The city is situated in an agricultural region, and oil abounds in the vicinity. Among the city's manufactures are glass, flour, planing mill products, brass and iron, carriages, barrels, incandescent lamps, carbons, wire nails and fences, automobile engines and parts, railway torpedoes and muslin underwear. The waterworks are owned and operated by the municipality. In 1832, upon the coming of the first settlers, two towns, Rome and Risdon, were laid out on the site of what is now Fostoria. A bitter rivalry arose between them, but they were finally united under one government, and the city thus formed was named in

honour of Charles W. Foster, whose son Charles Foster (1828-1904), governor of the state from 1880 to 1884 and secretary of the United States treasury from 1891 to 1893, did much to promote its growth. Fostoria was chartered as a city in 1854.

FOTHERGILL, JOHN (1712-1780), English physician, was born of a Quaker family on the 8th of March 1712 at Carr End in Yorkshire. He took the degree of M.D. at Edinburgh in 1736, and after visiting the continent of Europe he in 1740 settled in London, where he gained an extensive practice. In the epidemics of influenza in 1775 and 1776 he is said to have had sixty patients daily. In his leisure he made a study of conchology and botany; and at Upton, near Stratford, he had an extensive botanical garden where he grew many rare plants obtained from various parts of the world. He was the patron of Sidney Parkinson, the South Sea voyager. A translation of the Bible (1764 sq.) by Anthony Purver, a Quaker, was made and printed at his expense. His pamphlet entitled "Account of the Sore Throat attended with Ulcers" (1748) contains one of the first descriptions of diphtheria in English, and was translated into several languages. He died in London on the 26th of December 1780.

FOTHERINGHAY, a village of Northamptonshire, England, picturesquely situated on the left bank of the river Nene, $1\frac{1}{2}$ m. from Elton station on the Peterborough branch of the London & North-Western railway. The castle, of which nothing but the earthworks and foundations remain, is famous as the scene of the imprisonment of Mary queen of Scots from September 1586 to her trial and execution on the 8th of February 1587. The earthworks, commanding a ford of the river, are apparently of very early date, and probably bore a castle from Norman times. It became an important stronghold of the Plantagenets from the time of Edward III., and was the birthplace of Richard III. in 1452. The church of St Mary and All Saints, originally collegiate, is Perpendicular, and only the nave with aisles, and the tower surmounted by an octagon, remain; but the building is in the best style of its period. Edward, second duke of York, who was killed at the battle of Agincourt in 1415, Richard, the third duke, and his duchess, Cicely (d. 1495), also his son the earl of Rutland, who with Richard himself, fell at the battle of Wakefield in 1460, are buried in the church. Their monuments were erected by Queen Elizabeth, who found the choir and tombs in ruins.

FOUCAULT, JEAN BERNARD LÉON (1819-1868), French physicist, was the son of a publisher at Paris, where he was born on the 18th of September 1819. After an education received chiefly at home, he studied medicine, which, however, he speedily abandoned for physical science, the improvement of L. J. M. Daguerre's photographic processes being the object to which he first directed his attention. During three years he was experimental assistant to Alfred Donné (1801-1878) in his course of lectures on microscopic anatomy. With A. H. L. Fizeau he carried on a series of investigations on the intensity of the light of the sun, as compared with that of carbon in the electric arc, and of lime in the flame of the oxyhydrogen blowpipe; on the interference of heat rays, and of light rays differing greatly in lengths of path; and on the chromatic polarization of light. In 1849 he contributed to the *Comptes Rendus* a description of an electromagnetic regulator for the electric arc lamp, and, in conjunction with H. V. Regnault, a paper on binocular vision. By the use of a revolving mirror similar to that used by Sir Charles Wheatstone for measuring the rapidity of electric currents, he was enabled in 1850 to demonstrate the greater velocity of light in air than in water, and to establish that the velocity of light in different media is inversely as the refractive indices of the media. For his demonstration in 1851 of the diurnal motion of the earth by the rotation of the plane of oscillation of a freely suspended, long and heavy pendulum exhibited by him at the Pantheon in Paris, and again in the following year by means of his invention the gyroscope, he received the Copley medal of the Royal Society in 1855, and in the same year he was made physical assistant in the imperial observatory at Paris. In September of that year he discovered that the force required for the rotation of a copper disk becomes greater when

it is made to rotate with its rim between the poles of a magnet, the disk at the same time becoming heated by the eddy or "Foucault currents" induced in its metal. Foucault invented in 1857 the polarizer which bears his name, and in the succeeding year devised a method of giving to the speculum of reflecting telescopes the form of a spheroid or a paraboloid of revolution. With Wheatstone's revolving mirror he in 1862 determined the absolute velocity of light to be 298,000 kilometres (about 185,000 m.) a second, or 10,000 kilom. less than that obtained by previous experimenters. He was created in that year a member of the Bureau des Longitudes and an officer of the Legion of Honour, in 1864 a foreign member of the Royal Society of London, and next year a member of the mechanical section of the Institute. In 1865 appeared his papers on a modification of Watt's governor, upon which he had for some time been experimenting with a view to making its period of revolution constant, and on a new apparatus for regulating the electric light; and in the following year (*Compt. Rend.* lxxiii.) he showed how, by the deposition of a transparently thin film of silver on the outer side of the object glass of a telescope, the sun could be viewed without injuring the eye by excess of light. Foucault died of paralysis on the 11th of February 1868 at Paris. From the year 1845 he edited the scientific portion of the *Journal des Débats*. His chief scientific papers are to be found in the *Comptes Rendus*, 1847-1869.

See *Revue cours scient.* vi. (1869), pp. 484-489; *Proc. Roy. Soc.* xvii. (1869), pp. lxxxiii.-lxxxiv.; Lissajous, *Notice historique sur la vie et les travaux de Léon Foucault* (Paris, 1875).

FOUCHÉ, JOSEPH, DUKE OF OTRANTO (1763-1820), French statesman, was born in a small village near Nantes on the 21st of May 1763. His father, a seafaring man, destined him for the sea; but the weakness of his frame and the precocity of his talents soon caused this idea to be given up. He was educated at the college of the Oratorians at Nantes, and showed marked aptitude for studies both literary and scientific. Desiring to enter the teaching profession he was sent to an institution kept by brethren of the same order at Paris. There also he made rapid progress, and soon entered upon tutorial duties at the colleges of Niort, Saumur, Vendôme, Juilly and Arras. At Arras he had some dealings with Robespierre at the time of the beginning of the French Revolution (1789).

In October 1790 he was transferred by the Oratorians to their college at Nantes, owing to irregularities due to his zeal for revolutionary principles; but at Nantes he showed even more democratic fervour. His abilities and the zeal with which he espoused the most subversive notions brought him into favour with the populace at Nantes; he became a leading member of the local Jacobin club; and on the dissolution of the college of the Oratorians at Nantes in May 1792, Fouché gave up all connexion with the church, whose major vows he had not taken. After the downfall of the monarchy on the 10th of August 1792, he was elected as deputy for the department of the Lower Loire to the National Convention which met at the autumnal equinox and proclaimed the republic. The literary and pedagogic sympathies of Fouché at first brought him into touch with Condorcet and the party, or group, of the Girondists; but their vacillation at the time of the trial and execution of Louis XVI. (December 1792-January 21, 1793) led him to espouse the cause of the Jacobins, the less scrupulous and more thoroughgoing champions of revolutionary doctrine. On the question of the execution of the king, Fouché, after some preliminary hesitations, expressed himself with the utmost vigour in favour of immediate execution, and denounced those who "wavered before the shadow of a king."

The crisis which resulted from the declaration of war by the Convention against England and Holland (Feb. 1, 1793), and a little later against Spain, brought Fouché into notoriety as one of the fiercest of the Jacobinical fanatics who then held power at Paris. While the armies of the first coalition threatened the north-east of France, a revolt of the royalist peasants of Brittany and la Vendée menaced the Convention on the west. That body deputed Fouché with a colleague, Villers, to proceed

to the west as commissioners invested with almost dictatorial powers for the crushing of the revolt of "the whites." The vigour with which he carried out these duties earned him other work, and he soon held the post of commissioner of the republic in the department of the Nièvre. Together with Chaumette, he helped to initiate the atheistical movement, the founders of which in the autumn of 1793 began to aim at the extinction of Christianity in France. In the department of the Nièvre he ransacked the churches, sent their spoils to the treasury and established the cult of the goddess of Reason. Over the cemeteries, he ordered these words to be inscribed: "Death is an eternal sleep." He also waged war against luxury and wealth, and desired to abolish the use of money. The new cult was inaugurated at Paris at Notre Dame by the strange orgy known as "The Festival of Reason" (November 10, 1793).

Fouché then proceeded to Lyons to execute the vengeance of the Convention on that city, which had revolted against the new Jacobin tyranny. Preluding his work by a festival remarkable for its obscene parody of religious rites, he then, along with his colleague, Collot d'Herbois, set the guillotine and cannon to work with a rigour which made his name odious. Modern research, however, proves that at the close of those horrors Fouché exercised a moderating influence. Outwardly his conduct was marked by the utmost rigour, and on his return to Paris early in April 1794, he thus characterised his policy: "The blood of criminals fertilises the soil of liberty and establishes power on sure foundations." By that time Robespierre had struck down the other leaders of the atheistical party; but early in June 1794, at the time of the "Festival of the Supreme Being," Fouché ventured to mock at the theistic revival which Robespierre then inaugurated. Sharp passages of arms took place between them, and Robespierre procured the ejection of Fouché from the Jacobin Club (July 14, 1794). Fouché, however, was working with his customary skill and energy, and along with Tallien and others, managed to effect the overthrow of the theistic dictator on Thermidor 10 (July 28), 1794. The ensuing reaction in favour of more merciful methods of government threatened to sweep away the group of Terrorists who had been mainly instrumental in carrying through the *coup d'état* of Thermidor; but, thanks largely to the skill of Fouché in intrigue, they managed for a time to keep at the head of affairs. Discords, however, crept in which left him for a time almost isolated, and it needed all his ability to withstand the attacks of the moderates. A vigorous attack on him by Boissy d'Anglas, on the 9th of August 1795, caused him to be arrested, but the troubles which ensued in Vendémiaire averted the doom that seemed to be pending; and he owed his release to the amnesty which was passed on the proclamation of the new constitution of the year 1795.

In the ensuing period, known as that of the Directory (1795-1799), Fouché remained at first in obscurity, but the relations which he had with the communists, once headed by Chaumette and now by François N. ("Græchus") Babeuf (*q.v.*), helped him to rise once more. He is said to have betrayed to the director Barras the secret of the strange plot which Babeuf and a few accomplices hatched in the year 1796; but recent research has tended to throw doubt on the assertion. His rise from poverty was slow, but in 1797 he gained an appointment for the supply of military *matériel*, which offered opportunities direct and indirect. After offering his services to the royalists, whose movement was then gathering force, he again decided to support the Jacobins and the director Barras (*q.v.*). In the *coup d'état* of Fructidor 1797 he made himself serviceable to Barras, who in 1798 appointed him to be French ambassador to the Cisalpine republic. At Milan he carried matters with so high a hand against the Gallophobes of that government that his actions were disavowed and he himself was removed; but in the confused state in which matters then were, he was able for a time to hold his own and to intrigue successfully against his successor. Early in 1799 he returned to Paris, and after a brief tenure of office as ambassador at The Hague, he became minister of police at Paris (July 20, 1799). The newly elected director, Sieyès (*q.v.*),

was then in the ascendant and desired to curb the excesses of the Jacobins, who had recently reopened their club. Fouché, casting consistency to the winds, closed the Jacobins club in a manner at once daring and clever. Thereupon he hunted down the pamphleteers and editors, whether Jacobins or royalists, who were obnoxious to the government, so that at the time of the return of Bonaparte from Egypt (October 1799) the ex-Jacobin was one of the most powerful men in France.

Knowing well the unpopularity of the directors, Fouché lent himself to the schemes of Bonaparte and Sieyès for their overthrow. His activity in furthering the *coup d'état* of Brumaire 18-19 (November 9-10), 1799, procured him the favour of Bonaparte, who kept him in office (*v.* Napoleon I.). In the ensuing period of the Consulate (1799-1804) Fouché behaved with the utmost adroitness. While curbing the royalists and extreme Jacobins who at first alone opposed Bonaparte, Fouché was careful to temper as far as possible the arbitrary actions of the new master of France. In this difficult task he acquitted himself with so much skill as to earn at times the gratitude even of the royalists. Thus, while countermining a foolish intrigue of theirs in which the duchesse de Guiche was the chief agent, Fouché took care that she should escape. Equally skilful was his action in the affair of the so-called Aréna-Ceracchi plot, in which the *agents provocateurs* of the police were believed to have played a sinister part. The chief "conspirators" were easily ensnared and were executed when the affair of Nivôse (December 1800) enabled Bonaparte to act with rigour. This far more serious attempt (in which royalist conspirators exploded a bomb near the First Consul's carriage with results disastrous to the bystanders) was soon seen by Fouché to be the work of royalists; and when the First Consul, eager to entrap the still formidable Jacobins, sought to fasten the blame on them, Fouché firmly declared that he would not only assert but would prove that the outrage was the work of royalists. All his efforts, however, failed to avert the punishment which Bonaparte was resolved to inflict on the leading Jacobins. In other matters (especially in that known as the Plot of the Placards in the spring of 1802) Fouché was thought to have secured the Jacobins concerned from the vengeance of the First Consul. In any case the latter resolved to rid himself of a man who had too much power and too much skill in intrigue to be desirable as a subordinate. On the proclamation of Bonaparte as First Consul for life (August 1, 1802) Fouché was deprived of his office; but the blow was softened by the suppression of the ministry of police and by the attribution of most of its duties to an extended ministry of justice. Fouché also became a senator and received half of the reserve funds of the police which had accumulated during his tenure of office. He continued, however, to intrigue through his spies, whose information was so superior to that of the new minister of police as to render great services to Napoleon at the time of the Cadoudal-Pichegru conspiracy (February-March 1804).

As a result Napoleon, now emperor, brought back Fouché to the re-constituted ministry of police (July 1804); he also later on entrusted to him that of the interior. His work was no less important than at the time of the Consulate. His police agents were ubiquitous, and the terror which Napoleon and Fouché inspired, owing to their proven ability to benefit by plots, partly accounts for the absence of conspiracies after 1804. After Austerlitz (December 1805) Fouché uttered the *mot* of the occasion: "Sire, Austerlitz has shattered the old aristocracy; the boulevard St Germain no longer conspires."

That Napoleon retained some feeling of distrust, or even of fear, of Fouché was proved by his conduct in the early days of 1808. While engaged in the campaign of Spain, the emperor heard rumours that Fouché and Talleyrand, once bitter enemies, were having interviews at Paris in which Murat, king of Naples, was concerned. At once the sensitive autocrat hurried to Paris, but found nothing to incriminate Fouché. In that year Fouché received the title of duke of Otranto. During the absence of Napoleon in Austria in the campaign of 1809, the British Walcheren expedition threatened for a time the safety of

Antwerp. Fouché thereupon issued an order to the prefects of the northern departments of the empire for the mobilization of 60,000 National Guards. He added to the order a statement in which occurred the words: "Let us prove to Europe that although the genius of Napoleon can throw lustre on France, his presence is not necessary to enable us to repulse the enemy." The emperor's approval of the measure was no less marked than his disapproval of the words just quoted. The next months brought further causes of friction between emperor and minister. The latter, knowing the desire of his master for peace at the close of the year 1809, undertook on his own account to make secret overtures to the British ministry. A little later Napoleon opened negotiations and found that Fouché had forestalled him. His rage against his minister was extreme, and on the 3rd of June 1810 he dismissed him from his office. However, as it was not the emperor's custom completely to disgrace a man who might again be useful, Fouché received the governorship of Rome. He went thither, not as governor but as fugitive, for on receiving the emperor's order to give up certain important documents of his former ministry, he handed over only a few, declaring that the rest were destroyed. At this the emperor's anger burst forth again, and Fouché on learning, after his arrival at Florence, that the storm was still raging at Paris, prepared to sail to the United States. Compelled, however, by stress of weather and sickness to put back again, he found a mediator in Elisa Bonaparte, grand duchess of Tuscany, thanks to whom he was allowed to settle at Aix and finally to return to his domain of Point Carré. In 1812 he sought vainly to turn Napoleon from the projected invasion of Russia; and on the return of the emperor in haste from Smorgoni to Paris at the close of that year, the ex-minister of police was suspected of complicity in the conspiracy of General Malet, which came so strangely near to success. From this suspicion Fouché cleared himself and gave the emperor useful advice concerning internal affairs and the diplomatic situation. Nevertheless, the emperor, still distrustful of the arch-intriguer, ordered him to undertake the government of the Illyrian provinces. On the break-up of the Napoleonic system in Germany in October 1813 Fouché was ordered to repair to Rome and thence to Naples, in order to watch the movements of Murat. Before Fouché arrived at Naples Murat threw off the mask and invaded the Roman territory, whereupon Fouché received orders to return to France. He arrived at Paris on the 10th of April 1814 at the time when Napoleon was being constrained by his marshals to abdicate.

The conduct of Fouché at this crisis was characteristic. As senator he advised the senate to send a deputation to the comte d'Artois, brother of Louis XVIII., with a view to a reconciliation between the monarchy and the nation. A little later he addressed to Napoleon, then at Elba, a letter begging him in the interests of peace and of France to withdraw to the United States. To the new sovereign Louis XVIII. he sent an appeal in favour of liberty and recommending the adoption of measures which would conciliate all interests. It was not successful, but Fouché remained unmolested.

This was far from satisfying him, and when he found that there were no hopes of advancement, he entered into relations with conspirators who sought the overthrow of the Bourbons. Lafayette and Davout were concerned in the affair, but their refusal to take the course desired by Fouché and other bold spirits led to nothing being done. Soon Napoleon escaped from Elba and made his way in triumph to Paris. Shortly before his arrival at Paris (March 19, 1815) Louis XVIII. sent to Fouché an offer of the ministry of police, which he declined, saying, "It is too late; the only plan to adopt is to retreat." He then foiled an attempt of the royalists to arrest him, and on the arrival of Napoleon he received for the third time the portfolio of police. That, however, did not prevent him from entering into secret relations with Metternich at Vienna, his aim being then, as always, to prepare for all eventualities. Meanwhile he used all his powers to induce the emperor to popularise his rule, and he is said to have caused the insertion of the words "The sovereignty resides in the people; it is the source of

power" in the declaration of the council of state. But the autocratic tendencies of Napoleon could scarcely be held in check, and Fouché seeing the fall of the emperor to be imminent, took measures to expedite it and secure his own interests. On the 22nd of June Napoleon abdicated for the second time, and Fouché was next day elected president of the commission which provisionally governed France. Already he was in touch with Louis XVIII., then at Ghent, and now secretly received the overtures of his agent at Paris. While ostensibly working for the recognition of Napoleon II., he facilitated the success of the Bourbon cause, and thus procured for himself a place in the ministry of Louis XVIII. Even his skill, however, was unequal to the task of conciliating hot-headed royalists who remembered his vote as regicide and his fanaticism as terrorist. He resigned office, and after acting for a brief space as ambassador at Dresden, he retired to Prague. Finally he settled at Trieste, where he died on the 25th of December 1820. He had accumulated great wealth.

Marked at the outset by fanaticism, which, though cruel, was at least conscientious, Fouché's character deteriorated in and after the year 1794 into one of calculating cunning. The transition represented all that was worst in the life of France during the period of the Revolution and Empire. In Fouché the enthusiasm of the earlier period appeared as a cold, selfish and remorseless fanaticism; in him the bureaucracy of the period 1795-1799 and the autocracy of Napoleon found their ablest instrument. Yet his intellectual pride prevented him sinking to the level of a mere tool. His relations to Napoleon were marked by a certain aloofness. He multiplied the means of resistance even to that irresistible autocrat, so that though removed from office, he was never wholly disgraced. Despised by all for his tergiversations, he nevertheless was sought by all on account of his cleverness. He repaid the contempt of his superiors and the adulation of his inferiors by a mask of impenetrable reserve or scorn. He sought for power and neglected no means to make himself serviceable to the party whose success appeared to be imminent. Yet, while appearing to be the servant of the victors, present or prospective, he never gave himself to any one party. In this versatility he resembles Talleyrand, of whom he was a coarse replica. Both professed, under all their shifts and turns, to be desirous of serving France. Talleyrand certainly did so in the sphere of diplomacy; Fouché may occasionally have done so in the sphere of intrigue.

Bibliography.—Fouché wrote some political pamphlets and reports, the chief of which are *Réflexions sur le jugement de Louis Capet* (1793); *Réflexions sur l'éducation publique* (1793); *Rapport et projet de loi relatif aux collèges* (1793); *Rapport sur la situation de Commune-Affranchie [Lyons]* (1794); *Lettre aux préfets concernant les prêtres*, &c. (1801); also the letters of 1815 noted above, and a *Lettre au duc de Wellington* (1817). The best life of Fouché is that by L. Madelin, *Fouché* (2 vols., Paris, 1901). The so-called *Fouché Memoirs* are not genuine, but they were apparently compiled, at least in part, from notes written by Fouché, and are often valuable, though their account of events (e.g. of the negotiations of 1809-1810) is not seldom untrustworthy. For those negotiations see Coquelle, *Napoléon et l'Angleterre* (Paris, 1903, Eng. trans., London, 1904). For the plots with which Fouché had to deal see E. Daudet, *La Police et les Chouans sous le Consulat et l'Empire* (Paris, 1895); P. M. C. Desmarest, *Témoignages historiques, ou quinze ans de haute police* (Paris, 1833, 2nd ed., 1900); E. Picard, *Bonaparte et Moreau* (Paris, 1905); G. A. Thierry, *Conspireurs et gens de police; le complot de libelles* (Paris, 1903) (Eng. trans., London, 1903); H. Welschinger, *Le Duc d'Enghien* (Paris, 1888); E. Guillon, *Les Complots militaires sous le Consulat et l'Empire* (Paris, 1894). (J. H. L. R.)

FOUCHER, SIMON (1644-1696), French philosopher, was born at Dijon on the 1st of March 1644. He was the son of a merchant, and appears to have taken orders at a very early age. For some years he held the position of honorary canon at Dijon, but this he resigned in order to take up his residence in Paris. He graduated at the Sorbonne, and spent the remainder of his life in literary work in Paris, where he died on the 27th of April 1696. In his day Foucher enjoyed considerable repute as a keen opponent of Malebranche. His philosophical standpoint was one of scepticism in regard to external perception. He revived the old arguments of the Academy, and advanced them with much ingenuity against Malebranche's doctrine. Otherwise

his scepticism is subordinate to orthodox belief, the fundamental dogmas of the church seeming to him intuitively evident. His object was to reconcile his religious with his philosophical creed, and to remain a Christian without ceasing to be an academician. His writings against Malebranche were collected under the title *Dissertations sur la recherche de la vérité*, 1693.

See F. Rabbe, *L'Abbé Simon Foucher* (1867); C. Jourdain in *Dictionnaire des sciences philosophiques* (1875), pp. 557-559.

FOUCQUET, JEAN, of JEHAN (c. 1415-1485), French painter, born at Tours, is the most representative and national French painter of the 15th century. Of his life little is known, but it is certain that he was in Italy about 1437, where he executed the portrait of Pope Eugenius IV., and that upon his return to France, whilst retaining his purely French sentiment, he grafted the elements of the Tuscan style, which he had acquired during his sojourn in Italy, upon the style of the Van Eycks, which was the basis of early 15th-century French art, and thus became the founder of an important new school. He was court painter to Louis XI. Though his supreme excellence as an illuminator and miniaturist, of exquisite precision in the rendering of the finest detail, and his power of clear characterization in work on this minute scale, have long since procured him an eminent position in the art of his country, his importance as a painter was only realized when his portraits and altarpieces were for the first time brought together from various parts of Europe in 1904, at the exhibition of the French Primitives held at the Bibliothèque Nationale in Paris. One of Foucquet's most important paintings is the diptych, formerly at Notre Dame de Melun, of which one wing, depicting Agnes Sorel as the Virgin, is now at the Antwerp Museum and the other in the Berlin Gallery. The Louvre has his oil portraits of Charles VII., of Count Wilczek, and of Jouvénal des Ursins, besides a portrait drawing in crayon; whilst an authentic portrait from his brush is in the Liechtenstein collection. Far more numerous are his illuminated books and miniatures that have come down to us. The Brentano-Laroche collection at Frankfort contains forty miniatures from a Book of Hours, painted in 1461 for Etienne Chevalier who is portrayed by Foucquet on the Berlin wing of the Melun altarpiece. From Foucquet's hand again are eleven out of the fourteen miniatures illustrating a translation of Josephus at the Bibliothèque Nationale. The second volume of this MS., unfortunately with only one of the original thirteen miniatures, was discovered and bought in 1903 by Mr Henry Yates Thompson at a London sale, and restored by him to France. See *Œuvres de Jehan Foucquet* (Curmer, Paris, 1866-1867); A. de Champeaux and P. Gauchery, *Œuvres d'art exécutées pour le duc de Berry*; "Facsimiles of two histories by Jean Foucquet" from vols. i. and ii. of the *Anciennetés des Juifs* (London, 1902); Charles Blanc, *Histoire des peintres de toutes les écoles* (introduction); and Georges Lafenestre, *Jehan Fouquet* (Paris, 1902).

FOUGÈRES, a town of north-western France, capital of an arrondissement in the department of Ille-et-Vilaine, 30 m. N.E. of Rennes by rail. Pop. (1906) 21,847. Fougères is built on the summit and slopes of a hill on the left bank of the Nançon, a tributary of the Couesnon. It was formerly one of the strongest places on the frontier towards Normandy, and it still preserves some portions of its medieval fortifications, notably a gateway of the 15th century known as the Porte St Sulpice. The castle, which is situated in the lower part of the town, directly overlooking the Nançon, is now a picturesque ruin, but gives abundant evidence in its towers and outworks of its former strength and magnificence. The finest of the towers was erected in 1242 by Hugues of Lusignan, and named after Mélusine, the mythical foundress of the family. The churches of St Léonard and St Sulpice both date, at least in part, from the 15th century. An hôtel de ville and a belfry, both of the 15th century, are of architectural interest, and the town possesses many curious old houses. There is a statue of General B. de Lari Coisière (d. 1812), born in the town. Fougères is the seat of a subprefect, and has a tribunal of first instance, a chamber of commerce and a communal college. It is the chief industrial town of its department, being a centre for the manufacture of boots and shoes; tanning and leather-dressing and the manu-

facture of sail-cloth and other fabrics are also important industries. Trade is in dairy produce and in the granite of the neighbouring quarries. Fougères frequently figures in Breton history from the 11th to the 15th century. It was taken by the English in 1166, and again in 1448; and the name of Surienne, the captor on the second occasion, is still borne by one of the towers of the castle. In 1488 it was taken by the troops of Charles VIII. under la Trémoille. In the middle ages Fougères was a lordship of some importance, which in the 13th century passed into the possession of the family of Lusignan, and in 1307 was confiscated by the crown and afterwards changed hands many times. In 1793, during the wars of the Vendée, it was occupied by the insurgents.

FOUILLÉE, ALFRED JULES EMILE (1838-), French philosopher, was born at La Pouéze on the 18th of October 1838. He held several minor philosophical lectureships, and from 1864 was professor of philosophy at the lycées of Douai, Montpellier and Bordeaux successively. In 1867 and 1868 he was crowned by the Academy of Moral Science for his work on Plato and Socrates. In 1872 he was elected master of conferences at the École Normale, and was made doctor of philosophy in recognition of his two treatises, *Platonis Hippias Minor sive Socratica contra liberum arbitrium argumenta* and *La Liberté et le déterminisme*. The strain of the next three years' continuous work undermined his health and his eyesight, and he was compelled to retire from his professorship. During these years he had published works on Plato and Socrates and a history of philosophy (1875); but after his retirement he further developed his philosophical position, a speculative eclecticism through which he endeavoured to reconcile metaphysical idealism with the naturalistic and mechanical standpoint of science. In *L'Évolutionnisme des idées-forces* (1890), *La Psychologie des idées-forces* (1893), and *La Morale des idées-forces* (1907), is elaborated his doctrine of *idées-forces*, or of mind as efficient cause through the tendency of ideas to realize themselves in appropriate movement. Ethical and sociological developments of this theory succeed its physical and psychological treatment, the consideration of the antinomy of freedom being especially important. Fouillée's wife, who by a previous marriage was the mother of the poet and philosopher Jean Marie Guyau (1854-1888), is well known, under the pseudonym of "G. Bruno," as the author of educational books for children.

His other chief works are: *L'Idée moderne du droit en Allemagne, en Angleterre et en France* (Paris, 1878); *La Science sociale contemporaine* (1880); *La Propriété sociale et la démocratie* (1884); *Critique des systèmes de morale contemporains* (1883); *La Morale, l'art et la religion d'après Guyau* (1889); *L'Avenir de la métaphysique fondée sur l'expérience* (1889); *L'Enseignement au point de vue national* (1891); *Descartes* (1893); *Tempérament et caractère* (2nd ed., 1895); *Le Mouvement positiviste et la conception sociologique du monde* (1896); *Le Mouvement idéaliste et la réaction contre la science positive* (1896); *La Psychologie du peuple français* (2nd ed., 1898); *La France au point de vue moral* (1900); *L'Esquisse psychologique des peuples européens* (1903); *Nietzsche et l' "immoralisme"* (1903); *Le Moralisme de Kant* (1905).

FOULD, ACHILLE (1800-1867), French financier and politician, was born at Paris on the 17th of November 1800. The son of a rich Jewish banker, he was associated with and afterwards succeeded his father in the management of the business. As early as 1842 he entered political life, having been elected in that year as a deputy for the department of the Hautes Pyrénées. From that time to his death he actively busied himself with the affairs of his country. He readily acquiesced in the revolution of February 1848, and is said to have exercised a decided influence in financial matters on the provisional government then formed. He shortly afterwards published two pamphlets against the use of paper money, entitled, *Pas d'Assignats!* and *Observations sur la question financière*. During the presidency of Louis Napoleon he was four times minister of finance, and took a leading part in the economical reforms then made in France. His strong conservative tendencies led him to oppose the doctrine of free trade, and disposed him to hail the *coup d'état* and the new empire. On the 25th of January 1852, in consequence of the decree confiscating the property of the Orleans family,

he resigned the office of minister of finance, but was on the same day appointed senator, and soon after rejoined the government as minister of state and of the imperial household. In this capacity he directed the Paris exhibition of 1855. The events of November 1860 led once more to his resignation, but he was recalled to the ministry of finance in November of the following year, and retained office until the publication of the imperial letter of the 19th of January 1867, when Émile Ollivier became the chief adviser of the emperor. During his last tenure of office he had reduced the floating debt, which the Mexican war had considerably increased, by the negotiation of a loan of 300 millions of francs (1863). Fould, besides uncommon financial abilities, had a taste for the fine arts, which he developed and refined during his youth by visiting Italy and the eastern coasts of the Mediterranean. In 1857 he was made a member of the Academy of the Fine Arts. He died at Tarbes on the 5th of October 1867.

FOULIS, ANDREW (1712-1775) and **ROBERT** (1707-1776), Scottish printers and publishers, were the sons of a Glasgow maltman. Robert was apprenticed to a barber; but his ability attracted the attention of Dr Francis Hutcheson, who strongly recommended him to establish a printing press. After spending 1738 and 1739 in England and France in company with his brother Andrew, who had been intended for the church and had received a better education, he started business in 1741 in Glasgow, and in 1743 was appointed printer to the university. In this same year he brought out *Demetrius Phalereus de elocutione*, in Greek and Latin, the first Greek book ever printed in Glasgow; and this was followed in 1774 by the famous 12mo edition of Horace which was long but erroneously believed to be immaculate: though the successive sheets were exposed in the university and a reward offered for the discovery of any inaccuracy, six errors at least, according to T. F. Dibdin, escaped detection. Soon afterwards the brothers entered into partnership, and they continued for about thirty years to issue carefully corrected and beautifully printed editions of classical works in Latin, Greek, English, French and Italian. They printed more than five hundred separate publications, among them the small editions of Cicero, Tacitus, Cornelius Nepos, Virgil, Tibullus and Propertius, Lucretius and Juvenal; a beautiful edition of the Greek Testament, in small 4to; Homer (4 vols. fol., 1756-1758); Herodotus, Greek and Latin (9 vols. 12mo, 1761); Xenophon, Greek and Latin (12 vols. 12mo, 1762-1767); Gray's Poems; Pope's Works; Milton's Poems. The Homer, for which Flaxman's designs were executed, is perhaps the most famous production of the Foulis press. The brothers spared no pains, and Robert went to France to procure manuscripts of the classics, and to engage a skilled engraver and a copper-plate printer. Unfortunately it became their ambition to establish an institution for the encouragement of the fine arts; and though one of their chief patrons, the earl of Northumberland, warned them to "print for posterity and prosper," they spent their money in collecting pictures, pieces of sculpture and models, in paying for the education and travelling of youthful artists, and in copying the masterpieces of foreign art. Their countrymen were not ripe for such an attempt, and the "Academy" not only proved a failure but involved the projectors in ruin. Andrew died on the 18th of September 1775, and his brother went to London, hoping to realize a large sum by the sale of his pictures. They were sold for much less than he anticipated, and Robert returned broken-hearted to Scotland, where he died at Edinburgh on the 2nd of June 1776. Robert was the author of a *Catalogue of Paintings with Critical Remarks*. The business was afterwards carried on under the same name by Robert's son Andrew.

See W. J. Duncan, *Notices and Documents illustrative of the Literary History of Glasgow*, printed for the Maitland Club (1831), which *inter alia* contains a catalogue of the works printed at the Foulis press, and another of the pictures, statues and busts in plaster of Paris produced at the "Academy" in the university of Glasgow.

FOULLON, JOSEPH FRANÇOIS (1717-1789), French administrator, was born at Saumur. During the Seven Years' War he was intendant-general of the armies, and intendant of the army and navy under Marshal de Belle-Isle. In 1771 he was appointed

intendant of finances. In 1789, when Necker was dismissed, Foulon was appointed minister of the king's household, and was thought of by the reactionary party as a substitute. But he was unpopular on all sides. The farmers-general detested him on account of his severity, the Parisians on account of his wealth accumulated in utter indifference to the sufferings of the poor; he was reported, probably quite without foundation, to have said, "If the people cannot get bread, let them eat hay." After the taking of the Bastille on the 14th of July, he withdrew to his estate at Vitry and attempted to spread the news of his death; but he was recognized, taken to Paris, carried off with a bundle of hay tied to his back to the hôtel de ville, and, in spite of the intervention of Lafayette, was dragged out by the populace and hanged to a lamp-post on the 22nd of July 1789.

See Eugène Bonnemère, *Histoire des paysans* (4th ed., 1887), tome iii.; C. L. Chassin, *Les Élections et les cahiers de Paris en 1789*. (Paris, 1889), tomes iii. and iv.

FOUNDATION (Lat. *fundatio*, from *fundare*, to found), the act of building, constituting or instituting on a permanent basis; especially the establishing of any institution by endowing or providing it with funds for its continual maintenance. The word is thus applied also to the institutions so established, such as a college, monastery or hospital; and the terms "on the foundation," or "foundationer," are used of members of such a college or society who enjoy, as fellows, scholars, &c., the benefits of the endowment. Formerly "foundation" also meant the charter or incorporation of any such institution or society, and it is still applied to the funds used for the endowment of such institutions.

The terms "old foundation" and "new foundation" used in connexion with the organizing of English cathedral chapters have no reference to the age of the cathedrals. At the time of the Reformation under Henry VIII. the old college chapters were left unchanged, and are referred to as the "old foundations," but the monastic chapters were all suppressed, consequently new chapters had to be formed for their cathedrals and these constitute the "new foundations."

"Foundation" also means the base (natural or artificial) on which any erection is built up; generally made below the level of the ground (see FOUNDATIONS below). A foundation-stone is one of the stones at the base of a building, generally a corner-stone, frequently laid with a public ceremony to celebrate the commencement of the building. The term is also applied to the ground-work of any structure, such as, in dress-making, the underskirt over which the real skirt is hung, any material used for stiffening purposes, as "foundation muslin or net." In knitting or crochet the first stitches on to which all the rest are worked are called the "foundation chain." In gem-cutting the "foundation-square" is the first of eight squares round the edges of a brilliant made in bevel planes and from which the angles are all removed to form three-corner facets.

FOUNDATIONS, in building. The object of foundations is to distribute the weight of a structure equally over the ground. In the construction of a building the weights are concentrated at given points on piers, columns, &c., and these foundations require to be spread so as to reduce the weight to an average. In the preparation of a foundation care must be taken to prevent the lateral escape of the soil or the movement of a bed upon sloping ground, and it is also necessary to provide against any damage by the action of the atmosphere. The soils met with in ordinary practice, such as rock, gravel, chalk, clay and sand, vary as to their capabilities of bearing weight. There is no provision in any English building acts as to the load that may be placed on any of these soils, but under the New York Building Code it is provided that, where no test of the sustaining power of the soil is made, different soils, excluding mud, at the bottom of the footings shall be deemed to safely sustain the following loads to the superficial foot:

	per sq. ft.
Soft clay	1 ton.
Ordinary soft clay and sand, together in layers, wet and springy	2 tons.
Loam, clay or fine sand, firm and dry	3 tons.
Very firm coarse sand, stiff gravel or hard clay	4 tons.

A comparison of the pressure exerted on an ordinary foundation by the walls of the several thicknesses and heights provided for by the London Building Act of 1894, and a comparison of a few of the principal authorities, will be found useful in helping us to arrive at a decision as to what can safely be allowed. Take as an example a wall of the warehouse class, 70 ft. high, whose section at the base for a height of 27 ft. is 2½ bricks thick (or 22½ in.), and for the same distance in height again is 2 bricks thick (or 18 in.), the remainder to the top being 1½ bricks thick (or 14 in.). The weight of brickwork per foot run of such a wall is 4.05 tons on any area of 3.75 ft. super. of brickwork. According to the act the concrete is to project 4 in. on each side; we have then an additional area of .66 ft. super. to add, thus making the total foundation area of each foot run of wall 4.41 ft. super. to take a weight of 4.05 tons or nearly a ton per foot super. (viz. .9 ton.)

Another factor must, however, be taken into consideration, viz. the weight distributed from the loaded floor and from the roof. In this case there would be at least six floors, and the entire weight could hardly be taken at less than 6 tons, which would give a total weight of 10.05 tons on an area of 4.41 ft. super. or a load of 2.28 tons per foot super. This is on the assumption that no extra weight has been thrown on the foundations by openings or piers, or by girders, &c., in which case, in addition to the work being executed in cement, the foundations should be increased in area. Piers always involve a great increase of weight on the foundations, and in very many instances this increased weight, instead of being provided for by increasing the area of the foundations and so reducing the weight per foot super., is only partly met by the improper method of merely increasing the depth of the concrete, while keeping the same projection of concrete round the footings as for the walls. As an example take an iron column to carry a safe load of 80 tons, standing on a York stone template, and in turn supported by a brick pier 22½ in. square. In this case we should have, after allowing for the projection of concrete on either side, an area of 4 ft. 5 in. square, or 19.6 ft. super., and this would give a pressure of 4.1 tons per foot on the foundations, or almost twice as much as in the previous example of a warehouse wall. Here, instead of increasing the depth of the concrete, it would be necessary to increase its width; if it were made 6 ft. square, we should have an area of 36 ft. super. to take the 80 tons, and thus the pressure would only be 2.2 tons per foot, and the cost of the foundation be much the same.

If we compare a section of wall of the dwelling-house class, as prescribed by the London Building Act, we find that, taking a wall 50 ft. high and having a thickness at base of 22½ in. as for the warehouse wall to which we have referred, we have a wall weighing 3.75 tons per foot super. on an area of 4.41 feet super., or .85 ton per foot without weight of floors and roof as against the .9 ton in the warehouse example. To this must be added the weight of, say, 5 floors and roof at a total of 3 tons per foot run of wall, and we then have an aggregate of 6.75 tons per foot run and 1.50 tons per foot super. as against 2.28 tons in the warehouse class.

If we turn from the act to text-books we find that Colonel Seddon in the *Aide Memoir* gives the load which ordinary foundations will bear as a safe load per foot super. as follows:

	tons.
Rock, moderately hard	9
Rock of strength of good concrete	3
Rock, very soft	1.8
Firm earth	1 to 1½
Hard clay	1 to 1½
Clean dry gravel and clean sharp sand prevented from spreading sideways	1 to 1½

Most of the work in London may be classed under one of the latter heads, and according to this table we have, when we erect walls in accordance with the building act, to overload our foundations.

As to the possibility of spreading weights, we have as an example the chimney at Adkin's Soap Works in Birmingham,

312 ft. high, so arranged that its pressure on the foundations is only 1½ tons per foot super.; also the great St Rollox chimney at Glasgow, which has a pressure of 1¾ tons; the weight of the Eiffel Tower (7500 tons) is so spread over 4 bases, each 130 ft. square, that the pressure is only .117 ton, or 2½ cwt., per foot super. The Tower Bridge has a load of 16 tons per foot on the granite bed under the columns of towers, reduced by spreading to an actual pressure on the clay foundation of 4 tons. The piers under the Holborn Viaduct have a load of 2½ tons only, those of the Imperial Institute 2¼ tons, and those of the destructor cells and chimney shaft at Great Yarmouth 4 tons 6¾ cwt. per foot super. From these various examples it would appear that on sound clay or gravel foundation a load of from 2¼ to 4 tons may be employed with safety.

One of the first and most important requirements in preparing drawings for a large building is to ascertain the nature of the sub-soil and strata at different levels over the proposed site, so as to be able to arrange the footings accordingly at the various depths and to decide as to the various forms and methods to be employed. For this purpose trial holes or borings are sunk until a suitable bed or bottom is found, upon which the concrete foundation may safely be put. If no such solid bottom is found, as often happens near the water side, special foundations must be employed, such as dock, gridiron, cantilever and pile foundations, &c., all of which will be described hereafter. As examples of the varying subsoils we may mention the following, in which will be noticed the great depths dug before getting through the made ground: At the Bank of England there were 22 ft. of made ground resting on 4 ft. of gravel. Some of the made ground was of ancient date, and preserved relics of Roman occupation. In some parts the subsoils have been excavated for ballast or gravel, as at Kensington, or for brick earth, as at Highbury, and the pits filled in with rubbish. Rock, which forms an excellent and unchanging foundation in one situation, may prove a dangerous foundation in another. Thus chalk forms a good limestone foundation in certain positions, but when it dips towards a slope or a cliff with an outcrop of the gault or underlying clay, it is a very unsuitable foundation for any building, as the landslips in the Isle of Wight and on the Dorsetshire coast bear witness. A boring made in Tallis Street, near the Thames embankment, showed: (1) 18 in. ballast, dirty; (2) 6 in. greensand, wet and dirty; (3) 2 ft. peat clay; (4) 6 in. greensand; (5) 5½ ft. peaty bog; (6) 9 ft. running sand; and (7) 4 ft. clean ballast, resting at a depth of 23 ft. below the ground line upon blue clay. A boring at Highbury New Park gave: (1) 2 ft. made ground, (2) 18 ft. loam, (3) 9 ft. sand, (4) 4 ft. peat, and (5) 8 ft. gravel and sand. These examples show that while trial holes should always be made before designing a foundation, to ascertain the nature of the subsoil, care must be taken not to calculate upon uniformity. Thus at the block 2 of the admiralty extension new buildings (London), one of the trial holes upon the south-west side of the old buildings showed the clay to be about 29½ ft. below the surface of the ground, while actual excavation proved the dip of the clay to be such that in the execution of the new building it became necessary to underpin the north-west corner of the old building at the deepest part 42 ft. below the ground. The foundations of block 1 of the new admiralty buildings are placed in a dock, built upon the London clay at a depth of 30 ft. in solid concrete 6 ft. thick. At the Hotel Victoria, in Northumberland Avenue (London), the various subsoils are as follows: (1) 38½ ft. made ground clay and gravel mixed, (2) 4 ft. gravel and sand, (3) 6 ft. rising sand; (4) 2 ft. fine ballast, and at a depth of 50 ft. blue clay. At the south end the clay was 43 ft. down and at the north end 37 ft. The front wall was constructed on a concrete bed 9 ft. wide. The site was surrounded by a similar wall of concrete about 6 ft. wide, forming a species of boxes, and the whole was covered with a depth of 6 ft. of concrete upon which the walls were raised. The foundation for 53 Parliament Street, where running sand was encountered, was constructed with short piles, 7 or 8 ft. long and 6 in. diam., pointed and placed as close together as possible over the whole foundation, the tops were then sawn off level, and a concrete raft, 7 or 8 ft. thick, was built over the whole area. At the Institution of Civil Engineers, Great George Street, Westminster, the foundations to the two party walls upon each side of the building were carried down about 22 ft. below the pavement level, that on the west side being 22 ft. deep and that on the east side 24 ft.

The London Building Act and the model by-laws prohibit the erection of buildings on sites that have been used as "shoots" for faecal matter or vegetable refuse, and in such cases the objectionable material must be removed prior to the commencement of building operations, and the holes from which it was taken filled up with dry brick or other rubbish well rammed. Foundations are usually executed by excavators or navvies, and the tools and implements used are boning rods, level pegs, lines, spirit level, pickaxe, various shovels, wheel-barrow, rammer or punner, &c. In digging the ordinary trenches and

Trial borings.

Construction.

excavations, should the ground be loose, planking and strutting have to be employed. This consists of rough boarding put along the sides of the trenches and wedged tight with waling pieces and struts; this work is done by navvies. Figs. 1 and 2 show the general forms of planking and strutting for the different soils.

In very large works of excavation in soft soil a steam digger is used for the bulk of the work. It consists of a large steel bucket with a cutting edge; this is lowered by means of a crane into the excavation, and on being withdrawn cuts off a portion of soil which is hoisted and deposited in carts for removal to any desired position within the radius commanded by the crane. The work of trimming the excavation to a regular shape must always be done by manual labour.

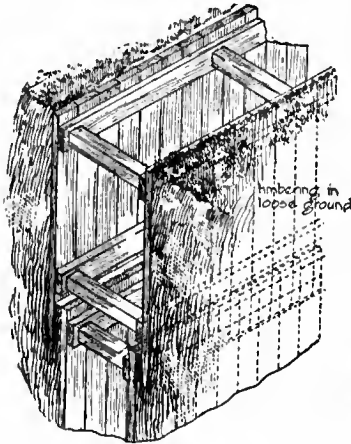

FIG. 1.

Concrete for filling into the foundations is usually mixed by navvies; for large works it is sometimes mixed by machinery.

In order that the work of excavating and constructing the foundations may proceed in a water-logged site, pumps have to be employed, and where the inrush of water is great it is usual to sink a sump hole lower than the depth required for the foundations, and to use a steam pump kept going day and night.

The foundation of a wall is required to be as follows in accordance with the London Building and Amendment Acts: "The projection of the bottom of the footings of every wall on each side of the wall shall be at least equal to half of the thickness of the wall at its base, unless an adjoining wall interferes, in which case the projection may be omitted where that wall adjoins, and the diminution of the footings of every wall shall be formed in regular offsets and the height from the bottom of such footing to the base of the wall shall be at least equal to two-thirds of the thickness of the wall at its base." (See BRICKWORK.) The base of a wall is the thickness above the footing; the footing is the brickwork built directly on the top of the concrete and diminishing in width in every course. Thus: "The projection of the bottom footing to be equal to one-half the thickness of wall on both sides" means that a 13½-in. wall would require to have three courses of footings, the bottom one being 27 in. wide. "The height from the bottom of such footing to the base of the wall shall be at least equal to two-thirds the thickness of wall at its base" means that in the case of a 13½-in. wall the height of footings would have to be 9 in., or three courses of brickwork, each measuring 3 in.

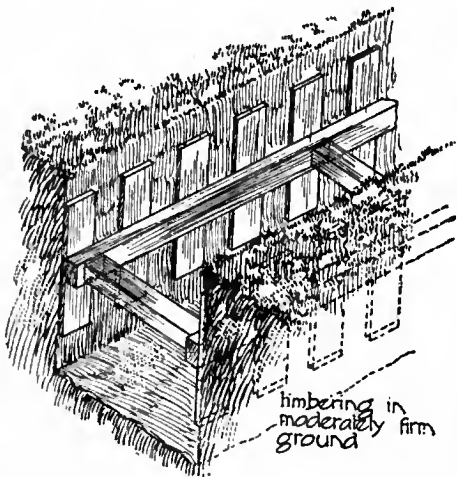

FIG. 2.

The New York Building Code enters more fully into the requirements for the foundation of walls as regards depth than that in use in London. Section 25, Part 5, requires that every building, except buildings erected upon solid rock, or upon wharves and piers on the water front, shall have foundations of brick, stone, iron or concrete laid not less than 4 ft. below the surface of the earth, on the solid ground or level surface of rock, or upon piles or ranging timbers when solid earth or rock is not found. Piles intended to sustain a wall, pier or post, shall be spaced not more than 36 in. nor less than 20 in. on centres; they must be driven to a solid bearing if practicable, and their number must be sufficient to support the superstructure proposed. No pile shall be used of less dimensions than 5 in. at the small end and 10 in. at the butt for short piles, or piles 20 ft. or less in length. No pile shall be weighted with a load exceeding 40,000 lb. When a pile is not driven to refusal, its safe sustaining

power shall be determined by the following formula: twice the weight of the hammer in tons multiplied by the height of the fall in feet divided by the least penetration of pile under the last blow in inches plus one. There are also further requirements as to piles, &c., and the commissioner of buildings must be notified when the piles are to be driven.

The New York Code, Section 26, further goes on to say that foundation walls shall be constructed to include all walls and piers built below the curb level or nearest tier of beams to the curb, to serve as supports for the walls, piers, columns, girders, posts or beams. Foundation walls shall be built of stone, brick, Portland cement concrete, iron or steel. If built of rubble stone or Portland cement concrete, they shall be at least 8 in. thicker than the wall above them to a depth of 12 ft. below the curb level, and for every additional 10 ft. or part thereof deeper, they shall be increased 4 in. in thickness. If built of brick, they shall be at least 4 in. thicker than the wall next above them to a depth of 12 ft. below the curb level, and for every additional 10 ft. or part thereof deeper, they shall be increased 4 in. in thickness. The footing or base course shall be of stone or concrete, or both, or of concrete and stepped up brickwork of sufficient thickness and area to bear safely the weight to be imposed thereon. If the footing or base course be of concrete, the concrete shall not be less than 12 in. thick; if of stone, the stones shall not be less than 2×3 ft. and at least 8 in. in thickness for walls, and not less than 10 in. in thickness if under piers, columns or posts. The footing or base course, whether formed of concrete or stone, shall be at least 12 in. wider than the bottom width of walls, and at least 12 in. wider on all sides than the bottom width of said piers, columns or posts. If the superimposed load is such as to cause undue transverse strain on a footing projecting 12 in., the thickness of such footing is to be increased so as to carry the load with safety. For small structures and for small piers sustaining light loads the commissioner of buildings having jurisdiction may, in his discretion, allow a reduction in the thickness and projection specified for footing or base courses. All base stones shall be bedded and laid crosswise, edge to edge. If stepped-up footing of brick is used in place of stone above the concrete, the offsets if laid in single courses shall each not exceed 1½ in., or, if laid in double courses, then each shall not exceed 3 in. offsetting the first course of brickwork back one-half the thickness of the concrete base, so as properly to distribute the load to be imposed thereon. It will be seen by the foregoing that the American acts are far more extensive than in London. The London Building Act mentions that the footings of a wall shall rest upon the solid ground or concrete or upon other solid substructure. The building act amendment says: "The foundations of the walls of every house or building shall be formed of a bed of good concrete not less than 9 in. thick, and projecting at least 4 in. on each side of the lowest course of footings."

Various Types of Foundations.—The most natural foundations for walls are those constructed where the walls are built directly upon the ground; this is only possible where the ground is very hard or consists of rock, and in either of these cases the ground is simply levelled and the building commenced.

The next and most universally recognized method, which might safely be said to be adopted in 95% of all modern buildings, is the system of placing a bed of concrete under the walls, digging trenches where the walls are to come until a solid bottom is reached, and in these laying the concrete. The London Building Act requires this concrete bed to be at least 4 in. wider than the bottom course of footings on each side of the wall, but it is generally made 6 in. wider on each side and in general circumstances the depth of the concrete is varied according to the weight placed upon it.

Where a site is in close proximity to a river or old water-course, &c., where deep basements are excavated, or where the ground lies low, naturally water is met with, and where water is the ground is soft. It is here that special foundations are required.

In certain cases it is necessary to use concrete legs or stilts. These are placed in such positions as to take the weights of the building, and sunk to depths of 40 ft. more or less as the case may require according to the nature of the ground; and on the tops of these stilts concrete arches or lintels are turned over (fig. 3). As an example of the stilt principle, mention may be made of some premises at Stratford and a church at South Bermondsey, London, in which concrete piers were sunk at 12 ft. centres apart and 4½ ft. square, in pot holes dug out of made ground; then concrete arches were formed over the intervening untrustworthy ground with a minimum thickness of 18 in. or the piers were connected by concrete lintels 3 ft. thick in which steel joists were embedded. At Sion College, Victoria Embankment, London, the foundations were formed with cement concrete stilts or piers 8 ft. square, and going down to the London clay; from the tops of these stilts brick arches were turned, spanning the spaces between the piers, and upon these arches the walls were built.

Pile foundations, used in the case of soft ground, for small works, consist either of stout scaffold poles or of timbers varying from 6 in. to 12 in. square according to requirements (fig. 4). The bottom ends of these timbers have an iron shoe with a point, so as to be easily driven into the ground, and the tops of the timbers have an iron band round, so that when the timbers are being driven in

Concrete piers, legs, or stilts.

the band prevents them from splitting (fig. 5). The methods of driving these piles are various. The usual plan is to erect a temporary structure, upon one side of which is a guide path faced with sheet-iron so as to give a smooth face. Up and down this guide path a heavy iron weight, called a monkey, is worked; the monkey is hoisted to the top of the guide path by means of a crab worked by hand or steam, and

Pile foundations.

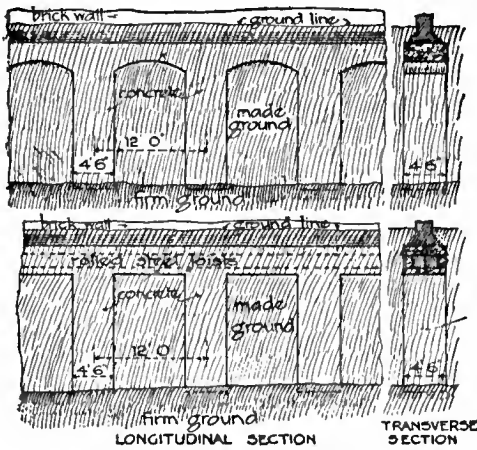

FIG. 3.

when released descends with a good force, and so drives the piles into the ground. The monkey usually weighs from 2 cwt. to 10 cwt. and is allowed a drop of 15 to 40 ft.

Piles are driven all round under the walls at varying intervals or under piers where the weights of a building are to be concentrated. In the erection of the Chicago public library four Norway pine piles, each with an average diameter of 13 in., were driven to a depth of 52½ ft. and loaded with a dead load of 50.7 tons per pile for a period of two weeks, and no settlement taking place 30 tons per pile was adopted as a safe load. The following are some examples of loads used in practice: passenger station, Harrison Street, Chicago, piles 50 ft.

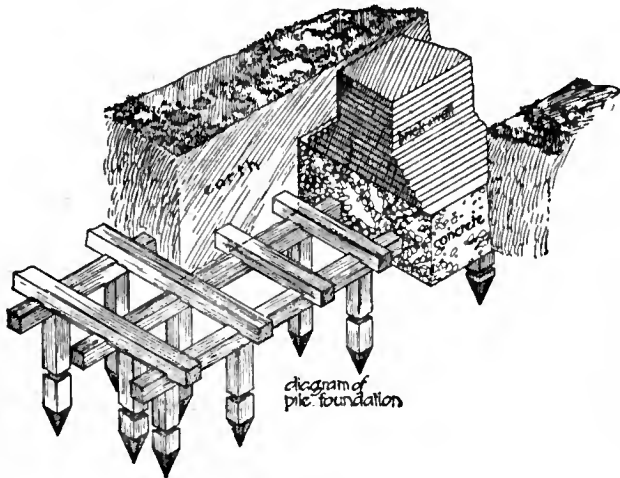

FIG. 4.

in length, each carrying 25 tons; elevator, Buffalo, N.Y., piles 20 ft. in length, weight 25 tons; Trinity church, Boston, 2 tons; Schiller building, Chicago, 55 tons per pile, but in this case the building settled considerably. All timber grillage and the tops of all piles should be kept below the lowest water level, and be capped with concrete or stone. In Boston it is obligatory to cap with blocks of granite.

Another form of foundation takes the shape of Portland cement concrete blocks, and is used chiefly for bridges and in marshy land, &c. In some cases cylinders of brickwork are built, and the centres are filled with blocks of concrete and grouted in. The Yarmouth destructor cells and chimney shaft were built in this way; the cylinders were constructed of 9 in. brickwork built in Portland cement, the lower 4 ft. being encased in a wooden drum with cutting edge sunk into the gravel and sand

Concrete piles.

at least 2 ft. The cylinders were sunk by the aid of a grab, the bottom being levelled and the concrete blocks laid by a diver. Use is also made of piles consisting of Portland cement concrete having steel rods embedded in it, and provided with iron shoes and head for driving (fig. 6).

Cast iron screw piles (fig. 7) used in very loose sandy soils, consist of large hollow cast iron columns with flat screw blades cast on the lower ends. The projection of this screw from the pile may vary from 9 in. to 18 in. with a pitch of from one-quarter to one-half of the projection, the blade making a little over one turn round the shaft. For most requirements a diameter of screw from 3½ to 4½ ft. will be found sufficient, a sandy foundation requiring the largest. The lower end of the tube is generally left open, the edge being

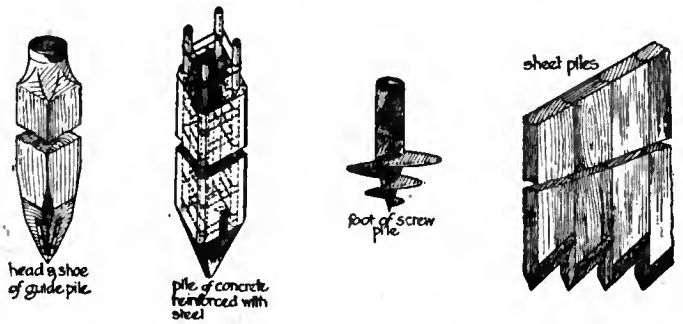

FIG. 5.

FIG. 6.

FIG. 7.

FIG. 8.

bevelled and occasionally provided with teeth to assist in cutting into and penetrating the soil.

Another system of piling known as sheet piling (fig. 8), consists in driving piles into the ground at intervals, and between these, also driven into the ground, are timbers measuring 3 in. by 9 in., which form a wall to keep the soft earth up under the building. In this way the earth is prevented from spreading out and so causing the building to settle unevenly.

Another kind of foundation, known as plank foundation (fig. 9), consists of elm planks, about 9 in. by 3 in. laid across the trench and spiked together; on the top of these are laid similar planks but at right angles to the last, and upon the platform thus formed the wall is built. This method is used in soft ground.

Plank foundations.

Caissons are usually employed by engineers for the construction of the foundations of bridge piers, but instances of their use in foundations for buildings are to be found in the American Surety and the Manhattan Life Insurance buildings, New York City. The latter building is 242 ft. high to the parapet, and the dome and tower rise 108 ft. higher. The building is carried

Caissons.

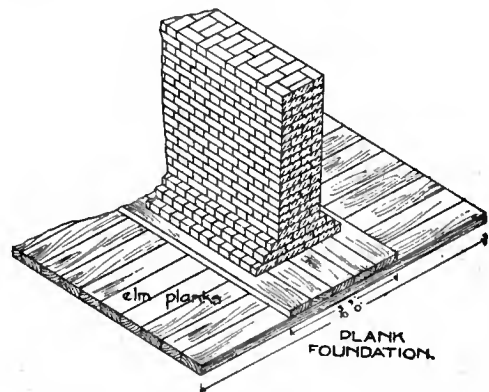

FIG. 9.

on 16 solid masonry piers, taken down 54 ft. below the street level to solid rock, and these piers support the 34 cast iron columns upon which the building is erected. The piers to each building were constructed by the pneumatic caisson process (see CAISSON).

A good plan for foundations when the ground is loose and sandy is to build upon wells of brickwork, a method which has been successfully practised in Madras. The wells are made circular, about 3 ft. in diameter and one brick thick. The first course is laid and cemented together on the surface of the ground when it is dry, and the earth is excavated inside and round about it to allow it to sink. Then another is laid over it and again sunk. The well is thus built downwards. The brickwork is sunk bodily to a depth of 10 ft. or more, according

Well foundations.

to building to be erected upon it, and the interior is filled up with rubble work. All the public buildings at Madras were erected upon foundations of this kind. Well foundations were employed under the city hall, Kansas City, and the Stock Exchange, Chicago.

Coffer dams are wooden structures used to keep back the water whilst putting in foundations on the waterside, and are constructed with two rows of timbers, 12 in. square as piles spaced about 6 ft. apart, and filled in between with a double row of 2 in. or 3 in. boards, the space between the rows being packed with clay puddle (fig. 10). The general rule for the thickness of a coffer dam is to make it equal to the depth of water. An interesting

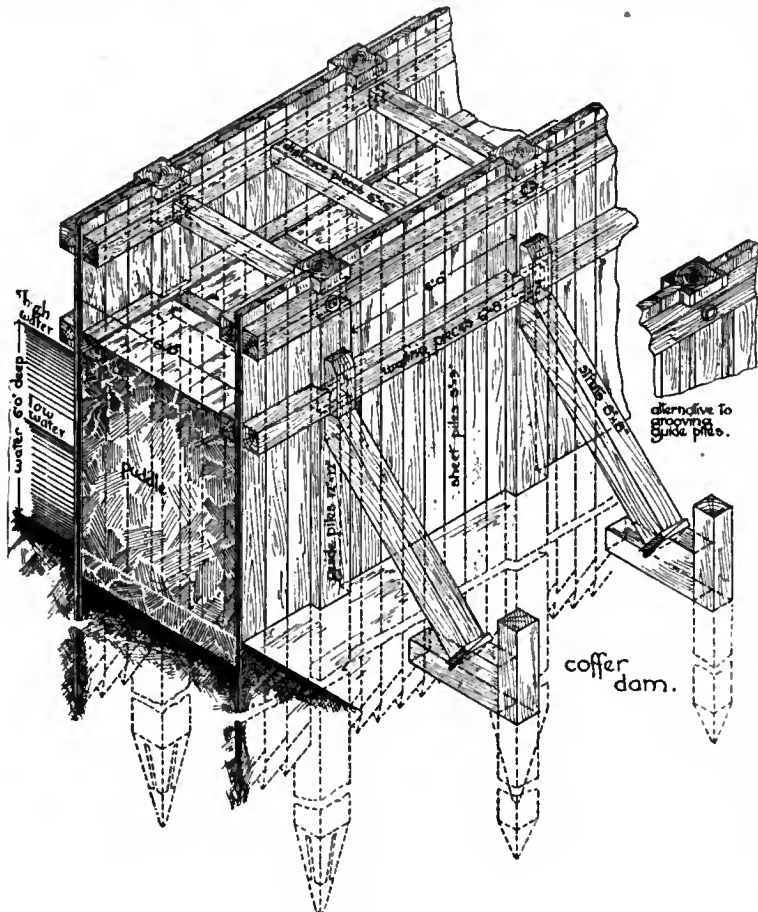

FIG. 10.

example of a coffer dam is that at the Keyham dock extension, where piles varied in length from 65 ft. to 85 ft. They were driven in a double row 5 ft. apart, and over 13,000 were used.

Dock foundations are constructed after the fashion of a large concrete tank, and are adapted to large sites where a difficulty arises as to the ingress of water. They are considered the best method of constructing a building on soft ground and of keeping a building dry (fig. 11). This type of foundation was used at the new colonial office, Whitehall, London, and the new admiralty buildings at St James's Park, London. A few buildings treated after the style of a dock, but in some instances without the enclosing walls, are the following:

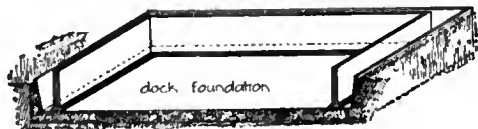

FIG. 11.

At the admiralty buildings already mentioned a concrete retaining wall completely surrounds the exterior below the ground, and is joined up to the underpinning work; the whole site being covered with concrete 6 ft. thick, a huge tank is formed of an average inside clear depth of 20 ft. in which the basements are built. The new "Old Bailey" buildings in Newgate Street, London, are constructed on a concrete table 5 ft. thick, as also are the Army and Navy Auxiliary Stores, Victoria Street. At Kennet's Wharf, near Southwark Bridge, a concrete table, 8 ft. thick, was spread all over the

site, with an extra thickness under the walls. Foundations formed similarly to dock foundations, but in addition having steel joists and rods inserted in the thickness of the concrete table, to tie the whole together, are known as *gridiron* foundations.

In the Hennebique concrete system, all beams, &c., are formed with small rods and then surrounded with concrete; it is designed for floors and for spreading the weight of a building over an extended foundation on soft ground.

Where a heavy wall is to be built against an old one and there is not sufficient room for the foundations, the plan is adopted of building pier foundations at some distance from the proposed new wall. On the top of these piers rest steel cantilevers over steel pin rockers upon cast iron bedplates; the cantilevers are secured at one end to a column, while the other ends go through the full thickness of the new wall. Upon these last ends is placed a steel girder upon which the wall is built. This construction (fig. 12) has been used in America, and in the Ritz Hotel, Piccadilly, London.

Cantilever foundations.

Another form of cantilever foundations was employed in the case of some premises at Carr's Lane, Birmingham, partly built over the Great Western railway tunnel (fig. 13). In this instance large piers were built below the ground at the side of the tunnel. From the tops of these piers large steel cantilevers were erected projecting over the crown of the tunnel, and on these steel girders were fixed and the building constructed upon them.

In modern Tunis, a section of which city is built on marshy ground, the subsoil is an oozy sediment, largely deposited by the sewage water from the ancient or Arab quarter of the city, which is situated on an adjacent hill. This semi-fluid mud has a depth of about 33 ft. To prepare the soil for supporting an ordinary house, pits from 8 ft. to 10 ft. square are excavated to a depth of about 10 ft., to the level of the ground water. A mixture is made of the excavated soil and powdered fat lime, procured from clinkers and unburnt stone from the lime-kilns, which soon crumbles to fine dust when exposed to the air. The mixture is thrown into pits in layers about 12 in. thick and rammed down for a very long time by specially trained labourers. A gang of 15 or 20 men will work at least 10 or 12 days ramming for the foundations of a moderate-sized house. An extremely hard bed is thus obtained, reaching to within 18 in. of the surface of the ground, and on this artificial bed the foundations of the building are laid. Although this method of construction is crude, it is stated that the practical results are superior to those obtained by using piles, concrete or other recognized methods, and in all cases the cost is much less, for labour is cheap.

Foundations in Tunis.

A novel and interesting foundation was designed for a signal station at Cape Henlopen, Delaware. This is built on top of the highest sandhill at Cape Henlopen, so that the observer may have an unobstructed view; it rises about 80 ft. above the level of the sea and is exposed to all winds and weather, while it is absolutely required that it shall stand firmly planted in such a way that even a hurricane shall not shake it or make it tremble, since that would affect the sight of the telescope in the observatory. The usual mode of securing such a building is by means of a foundation of screw piles or of heavy timbers sunk into the sand; this method, however, has the disadvantage that if

Building on sand.

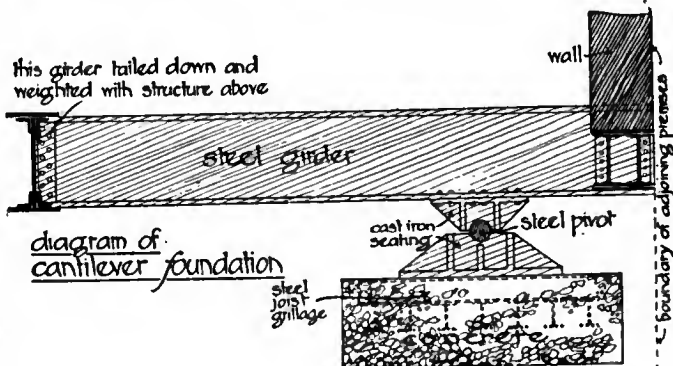

FIG. 12.

the wind shifts the sand away from around the foundation, it becomes undermined and its effect is destroyed. To avoid such an accident, recourse was had to the following design, which was considered to be cheap and at the same time to provide an effective anchorage. The building is entirely of wood; it has a cellar, above which are two rooms one above the other, and the whole is

surmounted by the observatory proper. First, the ground sill is a square of 20 ft., made of yellow pine sticks mortised together and pinned with stout trunnels. The sill of the observatory is made likewise of heavy timbers, 12 ft. long. The two sills are joined together by four stout yellow pine corner posts, which in turn are mortised into both sills. The posts are 26 ft. in length. Five feet above the lower sill is the sill which supports the floor of the first room. Ten feet above this is the sill which supports the upper room. Both these sills again are mortised into the corner posts. The structure is sheathed outside with German siding, and inside with rough boards covered with felt, and again by tongued and grooved yellow pine boards. The observatory proper, octagonal in shape, is securely mortised into the top sill and covered with a

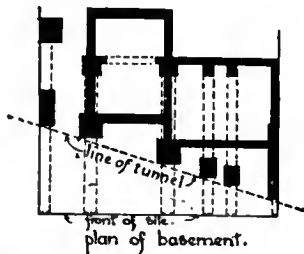
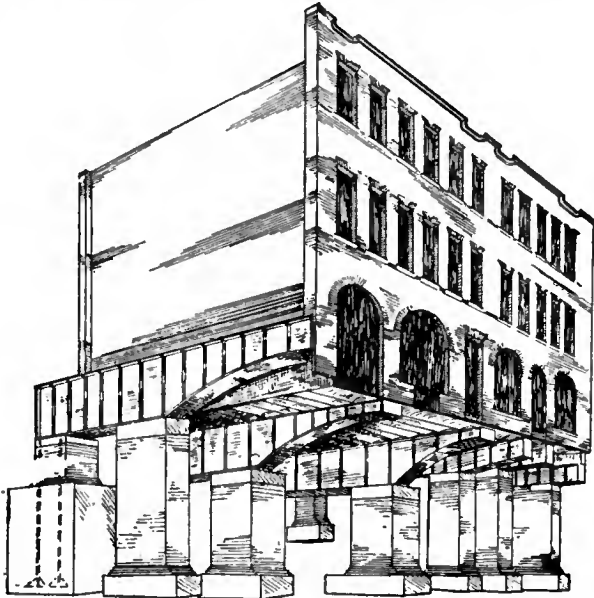

FIG. 13.—Cantilever Foundation over Railway Tunnel.

corrugated iron roof conical in shape. The cellar is floored with 3 in. wood, and boarded all round on the inside of the posts. A pit was first dug in the sand about 6 ft. deep and fully 20 ft. wide on the bottom. The cellar sill was laid on this bottom, and the structure built upon it; thus the whole depth of cellar is sunk below the top of the hill or the level of the sand. The cellar was then filled up with sand and packed solid all round, consequently the building is anchored in its place by the load in the cellar, about 100 tons in weight.

The subject of foundations, being naturally of the first importance, is one that calls for most careful study. It is not of so much importance that the ground be hard or even rocky as that it be compact and of similar consistency throughout. It is not always that a site answers to this description, and the problem of what will be the best form of foundation to use in placing a building, more especially if that building be of large dimensions and consequently great weight, on a site of soft yielding soil, is one that is often most difficult of solution. The foregoing article indicates in a brief manner some of the obstacles the architect or engineer is required to surmount before his work can even be started on its way to completion.

AUTHORITIES.—The principal books for reference on this subject are: *A Practical Treatise on Foundations*, by W. M. Patton, C. E.; *Building Construction and Superintendence*, part i., by F. E. Kidder; *Notes on Building Construction*, vols. i. ii. and iii.; *Aide Memoir*, vol. ii., by Colonel Seddon, R.E.; *Advanced Building Construction*, by C. F. Mitchell; *Modern House Construction*, by G. L. Sutcliffe; *Building Construction*, by Professor Henry Adams; *Practical Building Construction*, by J. P. Allen. (J. Br.)

FOUNDING (from Lat. *funderere*, to pour), the process of casting in metal, of making a reproduction of a given object by running molten metal into a mould taken in sand, loam or plaster from that object. To enable the founder to prepare a mould for the casting, he must receive a pattern similar to the casting required. Some few exceptions occur, to be noted presently, but the above statement is true of perhaps 98% of all castings produced. The construction of such patterns gives employment to a large number of highly skilled men, who can only acquire the necessary knowledge through an apprenticeship lasting from five to seven years. A knowledge of two trades at least is involved in the work of pattern construction—that of the craft itself and that of the moulder and founder. Patterns have to be constructed strongly. They are generally of wood, and they thus require skill in the use of woodworking tools and the making of timber joints, together with a knowledge of the behaviour of timber, &c. Some few patterns are made in iron, brass or white metal alloys. They have to be embedded in a matrix of sand by the founder, and being enclosed, they have to be withdrawn without inflicting any damage in the way of fracture in the sand. Since cast work involves shapes that are often very intricate, including projections and hollow spaces of all forms, it is obvious that the withdrawal of the patterns without entailing tearing up and fracture of the sand must involve many difficult problems that have to be as fully understood by the pattern-maker as by the moulder. It is from this point of view that the work of the pattern-maker should be approached in the first place. No closed mould can possibly be made without one or more joints, for if a pattern is wholly enclosed in a matrix of sand it cannot be withdrawn except by making a parting in the sand, and it is not difficult to conceive that the parting in the pattern might advantageously be made to coincide, either exactly or approximately, with that of the mould. Nor must obstacles exist to the free withdrawal of patterns. They must therefore not be wider or larger in the lower than in the upper parts; actually they are made a trifle smaller or "tapered." Nor may they have any lateral extensions into the lower sand, unless these can be made to withdraw separately from the main portion of the pattern. Finally, there are many internal spaces which cannot be formed by a pattern directly in the sand, but provision for which must be made by some means extraneous to the pattern, as by cores.

A single example must illustrate the main principles which have just been stated. The object selected is a bracket which involves questions of joints, of cores, of pattern construction and of moulding. The casting, the pattern, and its mould are illustrated. Fig. 1 illustrates in plan the casting of a double bracket, the end elevation of which is seen in fig. 2; the pattern of which presents obvious

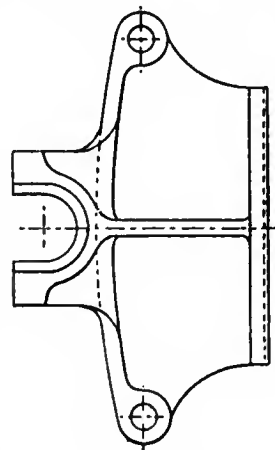

FIG. 1.

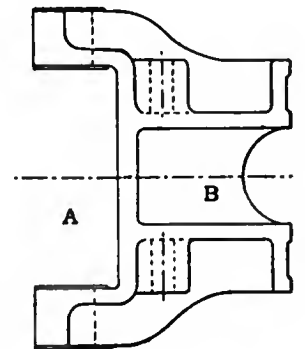

FIG. 2.

difficulties in the way of withdrawal from a mould, supposing it were made just like its casting. But if it be made as in fig. 3, with the open spaces A, B, in fig. 2, occupied with core prints, and the pieces A, A in fig. 3 left loosely skewered on, everything will "deliver" freely. Moreover the pattern might be made solidly as shown in fig. 3, or else jointed and dowelled in the plane a-a, as in fig. 4, or along the upper faces of the prints b-b, fig. 3. The

timber shadings in figs. 3 and 4 illustrate points in the most suitable arrangement of material. The prints are "boxed up." Fig. 4 shows a certain stage of the moulding, in which one half of the pattern has been "rammed" in sand, and turned over in the "bottom box," and the upper half is ready to be rammed in the "top box," with "runner pin" or "git stick" A, set in place. The lower loose piece has had its skewer removed during the ramming. Fig. 5 illustrates the mould completed and ready for pouring.

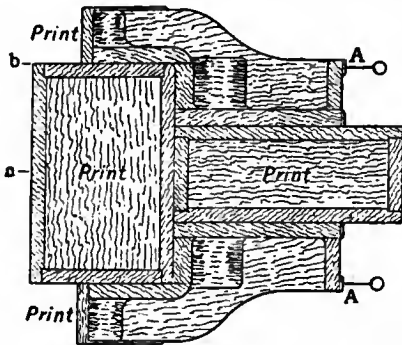

FIG. 3.

touch some of the great subdivisions of moulding and casting. There is a large volume of large and heavy work for which complete patterns and core boxes are never made, because of the great expense that would be involved in the pattern construction. There are also some cases in which the methods adopted would not permit of the use of patterns, as in that group of work in which the sand or loam is "swept" to the form required for the moulds and cores by means of striking boards, loam boards, core boards or strickles. In these classes of moulding the loose green sands and core sands are not much used; instead, loam—a wet and plastic sand mixture—is employed, supported against bricks (loam moulds) or against core bars and plates, and hay ropes (loam cores). All heavy marine engine cylinders are thus made by sweeping, and all massive cores for engine cylinders and large pipes, besides much large circular and cylindrical work, as foundation cylinders, soap pans, lead pans, mortar pans, large propeller blades, &c. In these cases the edge of the striking board is a counterpart of the profile of the work swept up. Joints also have to be made in such moulds, not of course in order to provide for the removal of a pattern, but for the exposure

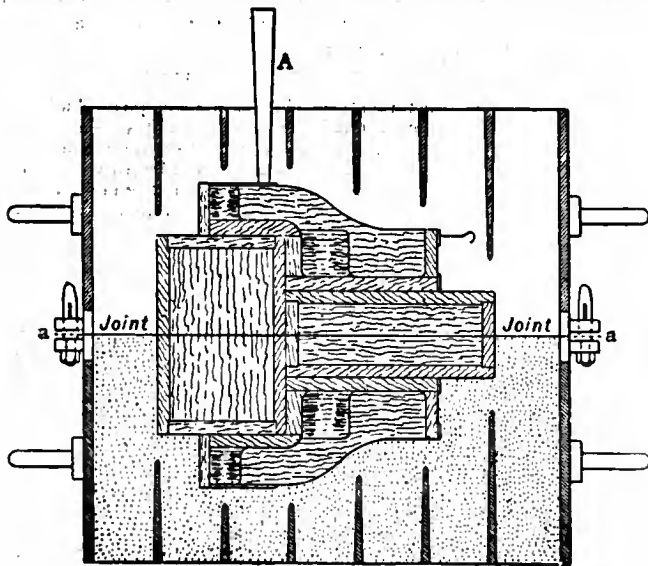

FIG. 4.

of the separate parts in course of construction, and for closing them up, or putting them together in their due relations. These joints also are swept by the boards, generally cut to produce suitable "checks," or "registers" to ensure that they accurately fit together. Fig. 6, showing a portion of a swept-up mould, illustrates the general arrangement. A plate, A, carries a quantity of bricks, B, which are embedded in loam, and break joint. To a striking bar, C, supported in a step, a striking board or sweeping board, D, is bolted, and is swept round against plastic loam, which is afterwards dried. The check on the board at A corresponds with a similar check on the board which strikes the interior of the pan, and by which top and bottom portions of the mould are registered together. This is indicated in dotted outline. Its mould also is swept on bricks, and

turned over into place, and the metal is poured into the space *b, b*, between the two moulds. There is also a large group of swept-up work which is not symmetrical about a centre of rotation. Then the movements of the sweeping boards are controlled by the edges of "core plates," or of "core irons" (fig. 7). Bend pipes, and the

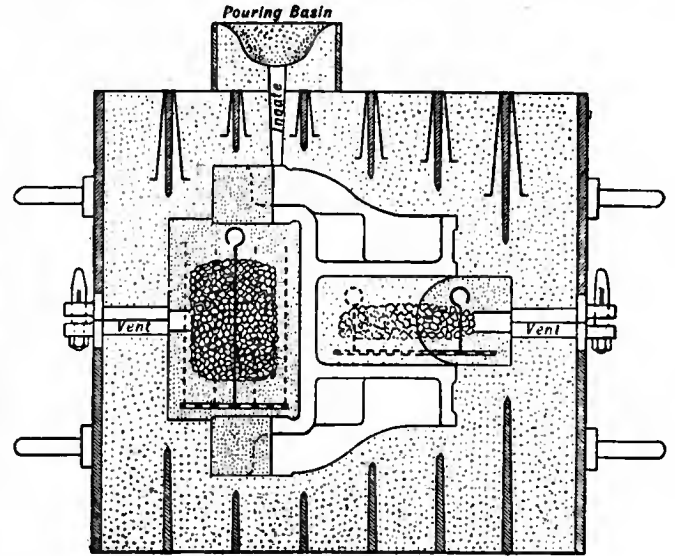

FIG. 5.

volute casings of centrifugal pumps and pipes, afford examples of this kind. In fig. 7, A is the core iron, held down by weights, and B the "strickle," sweeping up the half bend C, two such halves pasted together completing the core.

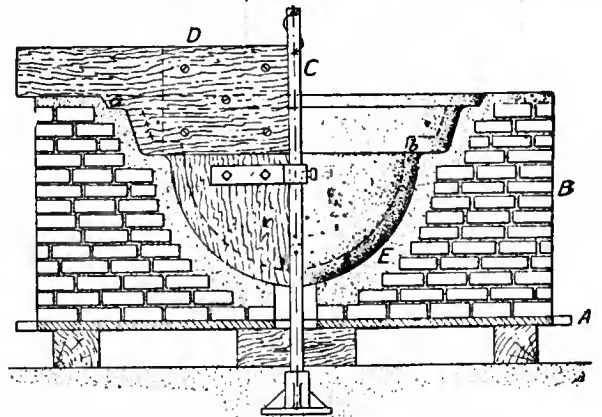

FIG. 6.

Core-making is a special department of foundry work, often involving as much detail as the construction and moulding of patterns. Two perfectly plain boxes are shown in figs. 8 and 9, in both of which provision exists for removing the box parts from the core after the latter has been rammed. Core boxes are jointed and tapered, and often have loose pieces within them, and also prints, into the impressions of which other cores are inserted.

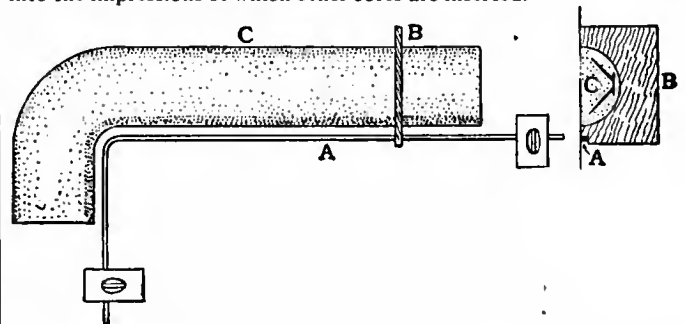

FIG. 7.

Machine-moulding.—There is a development of modern methods of founding which is effecting radical changes in some departments of foundry practice, namely, moulding by machines. The advantages of this method are manifold, and its limitations

are being lessened continually. There are two broad departments between which machine-moulding is divided. One, of less importance, is that of toothed wheels; the other is that of general work, except of a very massive character.

Gear-wheel moulding machines are essentially a special adaptation of the mechanism of the dividing engine, by means of which, instead of using a complete pattern of a toothed wheel, two or three pattern teeth are used, and the machine takes charge of the correct pitching or division of the teeth moulded therefrom, leaving to the moulder the

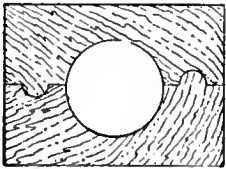

FIG. 8.

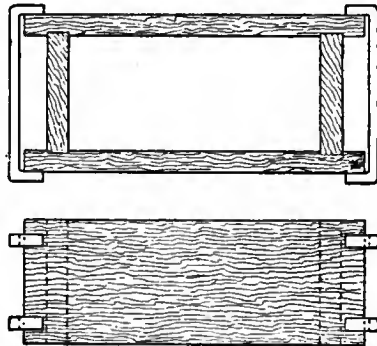

FIG. 9.

work only of turning the handle of the division plate, and ramming the sand around the pattern teeth. The result is accurate pitching, and the use of two or three teeth instead of a full pattern, together with any core boxes and striking boards that are necessary for the arms.

The other department of machine moulding includes nearly every conceivable class of work of small and medium dimensions. There are some dozens of distinct types of machines in use, for no one type is suitable for all classes of moulds, while some are designed specially for one or two kinds only.

The fundamental principles of operation are briefly these: The pattern parts constitute, by their method of attachment to a plate or table A (fig. 10), an integral portion of the machine, so that they

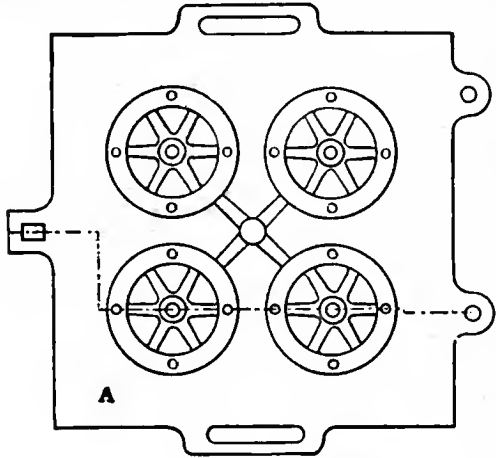
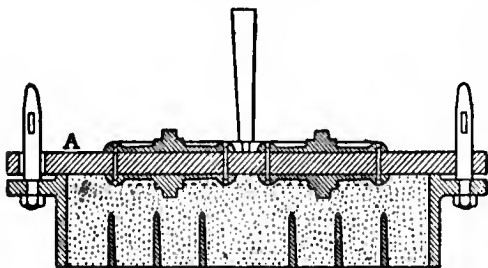

FIG. 10.



must partake of certain movements which are imparted to it. Often patterns mounted, as in fig. 10, are moulded by hand, without any aid from a machine, by methods of "plate-moulding." The delivery of the pattern from the sand is invariably accomplished by a perpendicular movement of a portion of the machine (fig. 11), withdrawing either the pattern from the mould or the mould from the pattern. The important point is that the perpendicular movement, being under the coercion of the vertical guides provided in the hand machines, or the hydraulic

ram in fig. 11, is free from the unsteadiness which is incidental to withdrawal by the hands of the moulder; and if the machine performed nothing more than this it would justify its existence. Little or no taper is required in the pattern, and the moulds are more nearly uniform in dimensions than hand-made moulds. But there are other advantages. In machine-moulding the joint

faces for parting moulds are produced by the faces of the plates on which the pattern is mounted (figs. 10 and 11), instead of by the hands and trowel of the moulder. When the joint face is of irregular outline, as it often is, this item alone saves a good deal of time, which again is multiplied by the number of moulds repeated, often amounting to thousands. Further, provision is generally made on machine plates for the ingates and runners (fig. 10) through which the metal enters the mould, the preparation of which in hand work occupies a considerable amount of time. Another great advantage applies especially to the case of deep moulds. These give much trouble in hand-moulding in consequence of the liability of the sand to become torn up during the withdrawal of the pattern. But in machine-moulding such patterns are encircled by a plate, termed a "stripping plate," which is pierced to allow the patterns to pass through, and which, being maintained firmly on the sand during the lifting of the pattern, prevents it from becoming torn up. This is not merely a matter of convenience, but is a necessity in numerous instances. The most familiar example is that of the teeth of gear wheels, in which even a very slight amount of taper interferes with accurate engagement, and this is representative of many other portions of mechanism. These stripping

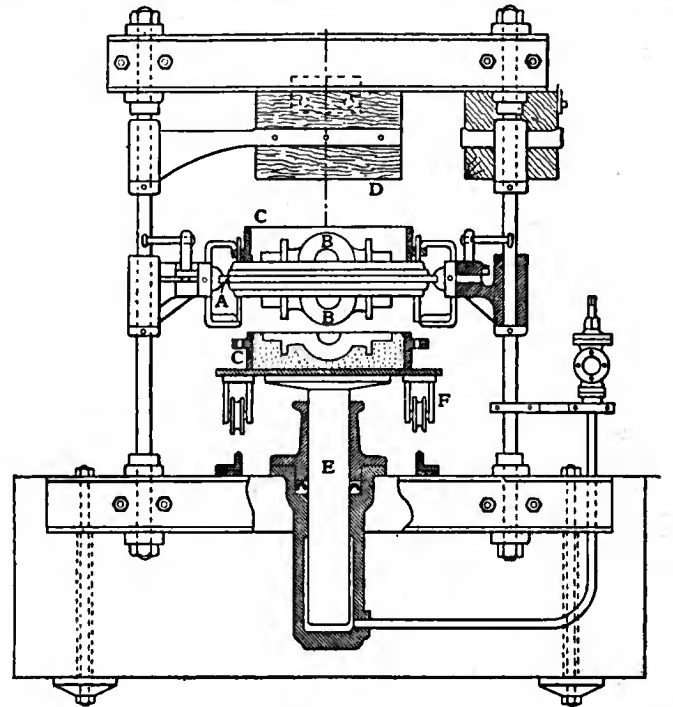

FIG. 11.

plates are of metal, but in order to save the cost of filing them in iron or steel, many are cheaply made by casting a white metal alloy round the actual pattern itself in the first place, the white metal being enclosed and retained in a plain iron frame which forms the body of the plate. Lastly, many machines, but not the majority, include provision for mechanically ramming the sand around the pattern by power instead of by hand. This is really the least valuable feature of a moulding machine, because it is not applicable to any but rather shallow moulds. It is commonly used for these, but the consistence and homogeneity of a mass of sand round a pattern having deep perpendicular sides can only be ensured by careful hand ramming.

The highest economies of machine-moulding are obtained when (1) several small patterns are mounted and moulded at once on a single plate (fig. 10); (2) when top and bottom parts of a mould are produced on different machines, carrying each its moiety of the pattern; (3) when the machine and pattern details are simplified so much that the labour of trained moulders is displaced by that of unskilled attendants who are taught in a month or two the few simple operations required. That is the direction in which repetitive casting is now rapidly tending.

In fig. 11 A is the plate, which in its essentials corresponds with the plate A in fig. 10, but which in the machine is made to swivel so as to bring each half of the pattern B, B in turn uppermost for ramming in the box parts C, C. The ramming is done by hand, the final squeeze being imparted against the presser D by the action of the hydraulic ram E pushing the plate, mould and box up against D. The plate being then lowered, and turned over, the further descent of the ram withdraws the bottom box from the pattern, which is the stage seen in the illustration. Then the half mould is run away on the carriage F, provided with wheels to run on rails.

Though casting in iron, steel, the bronzes, aluminium, &c., is

carried on by different men in distinct shops, yet the foregoing principles and methods apply to all alike. Work is done in green, *i.e.* moist sand, in dry sand (the moulds being dried before being used), and in plastic loam (which is subsequently dried). Hand and machine moulding are practised in each, the last-named excepted. The differences in working are those due to the various characteristics of the different metals and alloys, which involve differences in the sand mixtures used, in the dimensions of the pouring channels, of the temperature at which the metal or alloy must be poured, of the fluxing and cleansing of the metal, and other details of a practical character. Hence the practice which is suitable for one department must be modified in others. Many castings in steel would inevitably fracture if poured into moulds prepared for iron, many iron castings would fracture if poured into moulds suitable for brass, and neither brass nor steel would fill a mould having ingates proportioned suitably for iron.

A special kind of casting is that into "chill moulds," adopted in a considerable number of iron castings, such as the railway wheels in the United States, ordinary tramway wheels, the rolls of iron and steel rolling mills, the bores of cast wheel hubs, &c. The chill ranges in depth from $\frac{1}{4}$ in. to 1 in., and is produced by pouring a special mixture of mottled, or strong, iron against a cold iron surface, the parts of the casting which are not required to be chilled being surrounded by an ordinary mould of sand. The purpose of chill-casting is to produce a surface hardness in the metal.

The shrinkage of metal is a fact which has to be taken account of by the pattern-maker and moulder. A pattern and mould are made larger than the size of the casting required by the exact amount that the metal will shrink in cooling from the molten to the cold state. This amount varies from $\frac{1}{8}$ in. in 15 in., in thin iron castings, to $\frac{1}{4}$ in. in 12 in. in heavy ones. It ranges from $\frac{1}{16}$ in. to $\frac{1}{8}$ in. per foot in steel, brass and aluminium. Its variable amount has to be borne in mind in making light and heavy castings, and castings with or without cores, for massive cores retard shrinkage. It is also a fruitful cause of fracture in badly proportioned castings, particularly of those in steel. Brass is less liable to suffer in this respect than iron, and iron much less than steel.

(J. G. H.)

FOUNDLING HOSPITALS, originally institutions for the reception of "foundlings," *i.e.* children who have been abandoned or exposed, and left for the public to find and save. The early history of such institutions is connected with the practice of infanticide, and in western Europe where social disorder was rife and famine of frequent occurrence, exposure and extensive sales of children were the necessary consequences. Against these evils, which were noticed by several councils, the church provided a rough system of relief, children being deposited (*factati*) in marble shells at the church doors, and tended first by the *matricularii* or male nurses, and then by the *nutricarii* or foster-parents.¹ But it was in the 7th and 8th centuries that definite institutions for foundlings were established in such towns as Trèves, Milan and Montpellier. In the 15th century Garcias, archbishop of Valencia, was a conspicuous figure in this charitable work; but his fame is entirely eclipsed by that of St Vincent de Paul, who in the reign of Louis XIII., with the help of the countess of Joigny, Mme le Gras and other religious ladies, rescued the foundlings of Paris from the horrors of a primitive institution named La Couche (rue St Landry), and ultimately obtained from Louis XIV. the use of the Bicêtre for their accommodation. Letters patent were granted to the Paris hospital in 1670. The Hôtel-Dieu of Lyons was the next in importance. No provision, however, was made outside the great towns; the houses in the cities were overcrowded and administered with laxity; and in 1784 Necker prophesied that the state would yet be seriously embarrassed by this increasing evil.² From 1452 to 1789 the law had imposed on the *seigneurs de haute justice* the duty of succouring children found deserted on their territories. The first constitutions of the Revolution undertook as a state debt the support of every foundling. For a time premiums were given to the mothers of illegitimate children, the "enfants de la patrie." By the law of 12 Brumaire, An II. "Toute recherche de la paternité est interdite," while by art. 341 of the Code Napoléon, "la recherche de la maternité est admise."

France.—The laws of France relating to this part of what is called L'Assistance Publique are the decree of January 1811, the instruction of February 1823, the decree of the 5th of March 1852, the law of

the 5th of May 1869, the law of the 24th of July 1889 and the law of the 27th of June 1904. These laws carry out the general principles of the law of 7 Frimaire An V., which completely decentralized the system of national poor relief established by the Revolution. The *enfants assistés* include, besides (1) orphans and (2) foundlings proper, (3) children abandoned by their parents, (4) ill-treated, neglected or morally abandoned children whose parents have been deprived of their parental rights by the decision of a court of justice, (5) children, under sixteen years of age, of parents condemned for certain crimes, whose parental rights have been delegated by a tribunal to the state. Children classified under 1-5 are termed *pupilles de l'assistance*, "wards of public charity," and are distinguished by the law of 1904 from children under the protection of the state, classified as: (1) *enfants secourus*, *i.e.* children whose parents or relatives are unable, through poverty, to support them; (2) *enfants en dépôt*, *i.e.* children of persons undergoing a judicial sentence and children temporarily taken in while their parents are in hospital, and (3) *enfants en garde*, *i.e.* children who have either committed or been the victim of some felony or crime and are placed under state care by judicial authority. The asylum which receives all these children is a departmental (*établissement dépositaire*), and not a communal institution. The *établissement dépositaire* is usually the ward of an hospice, in which—with the exception of children *en dépôt*—the stay is of the shortest, for by the law of 1904, continuing the principle laid down in 1811, all children under thirteen years of age under the guardianship of the state, except the mentally or physically infirm, must be boarded out in country districts. They are generally apprenticed to some one engaged in the agricultural industry, and until majority they remain under the guardianship of the administrative commissioners of the department. The state pays the whole of the cost of inspection and supervision. The expenses of administration, the "home" expenses, for the nurse (*nourrice sédentaire*) or the wet nurse (*nourrice au sein*), the *prime de survie* (premium on survival), washing, clothes, and the "out-door" expenses, which include (1) temporary assistance to unmarried mothers in order to prevent desertion; (2) allowances to the foster-parents (*nourriciers*) in the country for board, school-money, &c.; (3) clothing; (4) travelling-money for nurses and children; (5) printing, &c.; (6) expenses in time of sickness and for burials and apprentice fees—are borne in the proportion of two-fifths by the state two-fifths by the department, and the remaining fifth by the communes. The following figures show the number of children (exclusive of *enfants secourus*) relieved at various periods:

Year.	Number relieved.
1890	95,701
1895	121,201
1900	138,308
1905	149,803

The *droit de recherche* is conceded to the parent on payment of a small fee. The decree of 1811 contemplated the repayment of all expenses by a parent reclaiming a child. The same decree directed a *tour* or revolving box (*Drehcylinder* in Germany) to be kept at each hospital. These have been discontinued. The "Assistance Publique" of Paris is managed by a "directeur" appointed by the minister of the interior, and associated with a representative *conseil de surveillance*. The Paris Hospice des Enfants-Assistés contains about 700 beds. There are also in Paris numerous private charities for the adoption of poor children and orphans. It is impossible here to give even a sketch of the long and able controversies which have occurred in France on the principles of management of foundling hospitals, the advantages of *tours* and the system of admission *à bureau ouvert*, the transfer of orphans from one department to another, the hygiene and service of hospitals and the inspection of nurses, the education and reclamation of the children and the rights of the state in their future. Reference may be made to the works noticed at the end of this article.

Belgium.—In this country the arrangements for the relief of foundlings and the appropriation of public funds for that purpose very much resemble those in France, and can hardly be usefully described apart from the general questions of local government and poor law administration. The Commissions des Hospices Civiles, however, are purely communal bodies, although they receive pecuniary assistance from both the departments and the state. A decree of 1811 directed that there should be an asylum and a wheel for receiving foundlings in every *arrondissement*. The last "wheel," that of Antwerp, was closed in 1860. (See *Des Institutions de bienfaisance et de prévoyance en Belgique*, 1850 à 1860, par M. P. Lentz.)

Italy is very rich in foundling hospitals, pure and simple, orphans and other destitute children being separately provided for. (See *Della carità preventiva in Italia*, by Signor Fano.) In Rome one branch of the Santo Spirito in Sassia (so called from the Schola Saxonum built in 728 by King Ina in the Borgo) has, since the time of Pope Sixtus IV., been devoted to foundlings. The average annual number of foundlings supported is about 3000. (See *The Charitable Institutions of Rome*, by Cardinal Morichini.) In Venice the Casa degli Esposti or foundling hospital, founded in 1346, and receiving 450 children annually, is under provincial administration. The splendid legacy of the last doge, Ludovico Manin, is applied to the

¹ See *Capitularia regum Francorum*, ii. 474.

² *De l'administration des finances*, iii. 136; see also the article "Enfant exposé" in Diderot's *Encyclopédie*, 1755, and Chamousset's *Mémoire politique sur les enfants*, 1757.

support of about 160 children by the "Congregazione di Carità" acting through 30 parish boards (*deputazione fraterne*).

Austria.—In Austria foundling hospitals occupied a very prominent place in the general instructions which, by rescript dated 16th of April 1781, the emperor Joseph II. issued to the charitable endowment commission. In 1818 foundling asylums and lying-in houses were declared to be state institutions. They were accordingly supported by the state treasury until the fundamental law of 20th October 1860 handed them over to the provincial committees. They are now local institutions, depending on provincial funds, and are quite separate from the ordinary parochial poor institute. Admission is gratuitous when the child is actually found on the street, or is sent by a criminal court, or where the mother undertakes to serve for four months as nurse or midwife in an asylum, or produces a certificate from the parish priest and "poor-father" (the parish inspector of the poor-law administration) that she has no money. In other cases payments of 30 to 100 florins are made. When two months old the child is sent for six or ten years to the houses in the neighbourhood of respectable married persons, who have certificates from the police or the poor-law authorities, and who are inspected by the latter and by a special medical officer. These persons receive a constantly diminishing allowance, and the arrangement may be determined by 14 days' notice on either side. The foster-parents may retain the child in their service or employment till the age of twenty-two, but the true parents may at any time reclaim the foundling on reimbursing the asylum and compensating the foster-parents.

Russia.—Under the old Russian system of Peter I. foundlings were received at the church windows by a staff of women paid by the state. But since the reign of Catherine II. the foundling hospitals have been in the hands of the provincial officer of public charity (*prykaz obshchestvennago pryzreniya*). The great central institutions (*Vospitatelnoi Dom*), at Moscow and St Petersburg (with a branch at Gatchina), were founded by Catherine. When a child is brought the baptismal name is asked, and a receipt is given, by which the child may be reclaimed up to the age of ten. The mother may nurse her child. After the usual period of six years in the country very great care is taken with the education, especially of the more promising children. The hospital is a valuable source of recruits for the public service. Malthus (*The Principles of Population*, vol. i. p. 434) has made a violent attack on these Russian charities. He argues that they discourage marriage and therefore population, and that the best management is unable to prevent a high mortality. He adds: "An occasional child murder from false shame is saved at a very high price if it can be done only by the sacrifice of some of the best and most useful feelings of the human heart in a great part of the nation." It does not appear, however, that the rate of illegitimacy in Russia is comparatively high; it is so in the two great cities. The rights of parents over the children were very much restricted, and those of the government much extended by a ukase issued by the emperor Nicholas in 1837. The most eminent Russian writer on this subject is M. Gourou. See his *Recherches sur les enfants trouvés*, and *Essai sur l'histoire des enfants trouvés* (Paris, 1829).

In *America*, foundling hospitals, which are chiefly private charities, exist in most of the large cities.

Great Britain.—The Foundling Hospital of London was incorporated by royal charter in 1739 "for the maintenance and education of exposed and deserted young children." The petition of Captain Thomas Coram, who is entitled to the whole credit of the foundation,¹ states as its objects "to prevent the frequent murders of poor miserable children at their birth, and to suppress the inhuman custom of exposing new-born infants to perish in the streets." At first no questions were asked about child or parent, but a distinguishing mark was put on each child by the parent. These were often marked coins, trinkets, pieces of cotton or ribbon, verses written on scraps of paper. The clothes, if any, were carefully recorded. One entry is, "Paper on the breast, clout on the head." The applications became too numerous, and a system of balloting with red, white and black balls was adopted. In 1756 the House of Commons came to a resolution that all children offered should be received, that local receiving places should be appointed all over the country, and that the funds should be publicly guaranteed. A basket was accordingly hung outside the hospital; the maximum age for admission was raised from two to twelve months, and a flood of children poured in from the country workhouses. In less than four years 14,934 children were presented, and a vile trade grew up among vagrants of undertaking to carry children from the country to the hospital,—an undertaking which, like the French *meneurs*, they often did not perform or performed with great cruelty. Of these 15,000 only 4400 lived to be apprenticed out. The total expense was about £500,000. This alarmed the House of Commons. After throwing out a bill which proposed to raise the necessary funds by fees from a general system of parochial registration, they came to the conclusion that the indiscriminate admission should be discontinued. The hospital, being thus thrown on its own resources, adopted a pernicious system of receiving children with considerable

sums (e.g. £100), which sometimes led to the children being reclaimed by the parent. This was finally stopped in 1801; and it is now a fundamental rule that no money is received. The committee of inquiry must now be satisfied of the previous good character and present necessity of the mother, and that the father of the child has deserted it and the mother, and that the reception of the child will probably replace the mother in the course of virtue and in the way of an honest livelihood. All the children at the Foundling hospital are those of unmarried women, and they are all first children of their mothers. The principle is in fact that laid down by Fielding in *Tom Jones*—"Too true I am afraid it is that many women have become abandoned and have sunk to the last degree of vice by being unable to retrieve the first slip." At present the hospital supports about 500 children up to the age of fifteen. The average annual number of applications is over 200, and of admissions between 40 and 50. The children used to be named after the patrons and governors, but the treasurer now prepares a list. Children are seldom taken after they are twelve months old. On reception they are sent down to the country, where they stay until they are about four or five years old. At sixteen the girls are generally apprenticed as servants for four years, and the boys at the age of fourteen as mechanics for seven years. There is a small benevolent fund for adults. The musical service, which was originally sung by the blind children only, was made fashionable by the generosity of Handel, who frequently had the "Messiah" performed there, and who bequeathed to the hospital a MS. copy (full score) of his greatest oratorio. The altar-piece is West's picture of Christ presenting a little child. In 1774 Dr Burney and Signor Giardini made an unsuccessful attempt to form in connexion with the hospital a public music school, in imitation of the Conservatorium of the Continent. In 1847, however, a successful "Juvenile Band" was started. The educational effects of music have been found excellent, and the hospital supplies many musicians to the best army and navy bands. The early connexion between the hospital and the eminent painters of the reign of George II. is one of extreme interest. The exhibitions of pictures at the Foundling, which were organized by the Dilettanti Club, undoubtedly led to the formation of the Royal Academy in 1768. Hogarth painted a portrait of Captain Coram for the hospital, which also contains his March to Finchley, and Roubillac's bust of Handel. (See *History and Objects of the Foundling Hospital, with Memoir of its Founder*, by J. Brownlow.)

In 1704 the Foundling hospital of Dublin was opened. No inquiry was made about the parents, and no money received. From 1500 to 2000 children were received annually. A large income was derived from a duty on coal and the produce of car licences. In 1822 an admission fee of £5 was charged on the parish from which the child came. This reduced the annual arrivals to about 500. In 1829 the select committee on the Irish miscellaneous estimates recommended that no further assistance should be given. The hospital had not preserved life or educated the foundlings. The mortality was nearly 4 in 5, and the total cost £10,000 a year. Accordingly in 1835 Lord Glenelg (then Irish Secretary) closed the institution.

Scotland never seems to have possessed a foundling hospital. In 1759 John Watson left funds which were to be applied to the pious and charitable purpose "of preventing child murder" by the establishment of a hospital for receiving pregnant women and taking care of their children as foundlings. But by an act of parliament in 1822, which sets forth "doubts as to the propriety" of the original purpose, the money was given to trustees to erect a hospital for the maintenance and education of destitute children.

AUTHORITIES.—*Histoire statistique et morale des enfants trouvés* by MM. Terme et Montfalcon (Paris, 1837) (the authors were eminent medical men at Lyons, connected with the administration of the foundling hospital); Remacle, *Des hospices d'enfants trouvés en Europe* (Paris, 1838); Hügel, *Die Findelhäuser und das Findelwesen Europas* (Vienna, 1863); Emminghaus, "Das Armenwesen und die Armengesetzgebung," in *Europäischen Staaten* (Berlin, 1870); Sennichon, *Histoire des enfants abandonnés* (Paris, 1880); the annual *Rapport sur le service des enfants assistés du département de la Seine*; Epstein, *Studien zur Frage der Findelanstalten* (Prague, 1882); Florence D. Hill, *Children of the State* (2nd ed., 1889). For United States, see H. Folks, *Care of Neglected and Dependent Children* (1901); A. G. Warner, *American Charities* (enlarged, 1908) and *Reports of Massachusetts State Board of Charities*. Information may also be got in the *Reports on Poor Laws in Foreign Countries*, communicated to the Local Government Board by the foreign secretary; *Accounts and Papers* (1875), vol. lxx. c. 1225; *Report of Committee on the Infant Life Protection Bill* (1890); *Report of Lords Committee on the Infant Life Protection Bill* (1896). (See also CHARITY AND CHARITIES.)

FOUNTAIN (Late Lat. *fontana*, from *fons*, a spring), a term applied in a restricted sense to such outlets of water as, whether fed by natural or artificial means, have contrivances of human art at a point where the water emerges. A very early existing example is preserved in the carved Babylonian basin (about 3000 B.C.) found at Tello, the ancient Lagash, and Layard mentions an Assyrian fountain, found by him in a gorge of the river Gomel,

¹ Addison had suggested such a charity (*Guardian*, No. 3).

which consists of a series of basins cut in the solid rock and descending in steps to the stream. The water had been originally led from one to the other by small conduits, the lowest of which was ornamented by two rampant lions in relief. The term is applied equally to the simpler arrangements for letting water gush into an ornamental basin or to the more elaborate ones by which water is mechanically forced into high jets; and a "fountain" may be either the ornamental receptacle or the jet of water itself. In modern times the examples of ornamental or useful fountains are legion, and it will suffice here to mention some of the more important facts of historical interest.

Among the Greeks fountains were very common in the cities. Springs being very plentiful in Greece, little engineering skill was required to convey the water from place to place. Receptacles of sufficient size were made for it at the springs; and to maintain its purity, structures were raised enclosing and covering the receptacle. In Greece they were dedicated to gods and goddesses, nymphs and heroes, and were frequently placed in or near temples. That of Pirene at Corinth (mentioned also by Herodotus) was formed of white stone, and contained a number of cells from which the pleasant water flowed into an open basin. Legend connects it with the nymph Pirene, who shed such copious tears, when bewailing her son who had been slain by Diana, that she was changed into a fountain. The city of Corinth possessed many fountains. In one near the statues of Diana and Bellephoron the water flowed through the hoofs of the horse Pegasus. The fountain of Glauce, enclosed in the Odeum, was dedicated to Glauce, because she was said to have thrown herself into it believing that its waters could counteract the poisons of Medea. Another Corinthian fountain had a bronze statue of Poseidon standing on a dolphin from which the water flowed. The fountain constructed by Theagenes at Megara was remarkable for its size and decorations, and for the number of its columns. One at Lerna was surrounded with pillars, and the structure contained a number of seats affording a cool summer retreat. Near Pharae was a grove dedicated to Apollo, and in it a fountain of water. Pausanias gives a definite architectural detail when he says that a fountain at Patrae was reached from without by descending steps. Mystical, medicinal, surgical and other qualities, as well as supernatural origin, were ascribed to fountains. One at Cyane in Lycia was said to possess the quality of endowing all persons descending into it with power to see whatever they desired to see; while the legends of fountains and other waters with strange powers to heal are numerous in many lands. The fountain Enneacrunus at Athens was called Callirrhoe before the time the water was drawn from it by the nine pipes from which it took its later name. Two temples were above it, according to Pausanias, one dedicated to Demeter and Persephone, and the other to Triptolemus. The fountain in the temple of Erechtheus at Athens was supplied by a spring of salt water, and a similar spring supplied that in the temple of Poseidon Hippios at Mantinea.

The water-supply of Rome and the works auxiliary to it were on a scale to be expected from a people of such great practical power. The remains of the aqueducts which stretched from the city across the Campagna are amongst the most striking monuments of Italy. Vitruvius (book viii.) gives minute particulars concerning the methods to be employed for the discovery, testing and distribution of water, and describes the properties of different waters with great care, proving the importance which was attached to these matters by the Romans. The aqueducts supplied the baths and the public fountains, from which last all the populace, except such as could afford to pay for a separate pipe to their houses, obtained their water. These fountains were therefore of large size and numerous. They were formed at many of the *castella* of the aqueducts. According to Vitruvius, each *castellum* should have three pipes,—one for public fountains, one for baths and the third for private houses. Considerable revenue was drawn from the possessors of private water-pipes. The Roman fountains were generally decorated with figures and heads. Fountains were often also the ornament of Roman villas and country houses; in those so situated the water gener-

ally fell from above into a large marble basin, with at times a second fall into a still lower receptacle. Two adjacent houses in Pompeii had very remarkable fountains. One, says Gell, "is covered with a sort of mosaic consisting of vitrified tesserae of different colours, but in which blue predominates. These are sometimes arranged in not inelegant patterns, and the grand divisions as well as the borders are entirely formed and ornamented with real sea-shells, neither calcined by the heat of the eruption nor changed by the lapse of so many centuries" (*Pompeiana*, i. 196). Another of large size was similarly decorated with marine shells, and is supposed to have borne two sculptured figures, one of which, a bronze, is in the museum at Naples. This fountain projects 5 ft. 7 in. from the wall against which it is placed, and is 7 ft. wide in front, while the height of the structure up to the eaves of the pediment is 7 ft. 7 in. On a central column in the piscina was a statue of Cupid, with a dove, from the mouth of which water issued. Cicero had, at his villa at Formiae, a fountain which was decorated with marine shells.

Fountains were very common in the open spaces and at the crossways in Pompeii. They were supplied by leaden pipes from the reservoirs, and had little ornament except a human or animal head, from the mouth of which it was arranged that the water should issue. Not only did simple running fountains exist, but the remains of *jets d'eau* have been found; and a drawing exists representing a vase with a double jet of water, standing on a pedestal placed in what is supposed to have been the impluvium of a house. There was also a *jet d'eau* at the eastern end of the peristyle of the Fullonica at Pompeii.

As among the Greeks, so with the early Celts, traces of superstitious beliefs and usages with relation to fountains can be traced in monumental and legendary remains. Near the village of Primalcon in Brittany was a very remarkable monument,—one possibly unique, as giving distinct proof of the existence of an ancient cult of fountains. Here is a dolmen composed of a horizontal table supported by two stones only, one at each end. All the space beneath this altar is occupied by a long square basin formed of large flat stones, which receives a fountain of water. At Lochrist is another vestige of the Celtic cult of fountains. Beneath the church, and at the foot of the hill upon which it is built, is a sacred fountain, near which is erected an ancient chapel, which with its ivy-covered walls has a most romantic appearance. A Gothic vault protects this fountain. Miraculous virtues are still attributed to its water, and on certain days the country people still come with offerings to draw it (see La Poix de Freminville, *Antiquités de la Bretagne*, i. p. 101). In the enchanted forest of Brochelande, so famous from its connexion with Merlin, was the fountain of Baranton, which was said to possess strange characteristics. Whoever drew water from it, and sprinkled the steps therewith, produced a tremendous storm of thunder and hail, accompanied with thick darkness.

Christianity transferred to its own uses the ancient religious feeling concerning fountains. Statues of the Virgin or of saints were erected upon the rude structures that collected the water and preserved its purity. There is some uniformity in the architectural characteristics of these structures during the middle ages. A very common form in rural districts was that in which the fountain was reached by descending steps (*fontaine grotte*). A large basin received the water, sometimes from a spout, but often from the spring itself. This basin was covered by a sort of porch or vault, with at times moulded arches and sculptured figures and escutcheons. On the bank of the Clain at Poitiers is a fountain of this kind, the Fontaine Joubert, which though restored in 1597 was originally a structure of the 14th century. This kind of fountain is frequently decorated with figures of the Virgin or of saints, or with the family arms of its founder; often, too, the water is the only ornament of the structure, which bears a simple inscription. A large number of these fountains are to be found in Brittany and indeed throughout France, and the great antiquity of some of them is proved by the superstitions regarding them which still exist amongst the peasantry. A form more common in populous districts was that of a large open basin, round, square, polygonal, or lobed in

form, with a columnar structure at the centre, from the lower part of which it was arranged that spouts should issue, playing into an open basin, and supplying vessels brought for the purpose in the cleanest and quickest manner. The columns take very various forms, from that of a simple regular geometrical solid, with only grotesque masks at the spouts, to that of an elaborate and ornate Gothic structure, with figures of virgins, saints and warriors, with mouldings, arches, crockets and finials. At Provins there is a fountain said to be of the 12th century, which is in form an hexagonal vase with a large column in the centre, the capital of which is pierced by three mouths, which are furnished with heads of bronze projecting far enough to cast the water into the basin. In the public market-place at Brunswick is a fountain of the 15th century, of which the central structure is made of bronze. Many fountains are still existing in France and Germany which, though their actual present structure may date no earlier than the 15th or 16th century, have been found on the place of, and perhaps may almost be considered as restorations of, pre-existing fountains. Except in Italy few fountains are of earlier date than the 14th century. Two of that date are at the abbey of Fontaine Daniel, near Mayenne, and another, of granite, is at Limoges. Some of these middle-age fountains are simple, open reservoirs enclosed in structures which, however plain, still carry the charm that belongs to the stone-work of those times. There is one of this kind at Cully, Calvados, walled on three sides, and fed from the spring by two circular openings. Its only ornamentation is a small empty niche with mouldings. At Lincoln is a fountain of the time of Henry VIII., in front of the church of St Mary Wickford. At Durham is one of octangular plan, which bears a statue of Neptune.

The decay of architectural taste in the later centuries is shown by the fountain of Limoges. It is in form a rock representing Mount Parnassus, upon which are carved in relief Apollo, the horse Pegasus, Philosophy and the Nine Muses. At the top Apollo, in the 16th-century costume, plays a harp. Rocks, grass and sheep fill up the scene.

Purely ornamental fountains and *jets d'eau* are found in or near many large cities, royal palaces and private seats. The celebrated Fontana di Trevi, at Rome, was erected early in the 18th century under Pope Clement XII., and has all the characteristics of decadence. La Fontana Paolina and those in the piazza of St Peter's are perhaps next in celebrity to that of Trevi, and are certainly in better taste. At Paris the Fontaine des Innocens (the earliest) and those of the Place Royal, of the Champs Elysées and of the Place de la Concorde are the most noticeable. The fountain of the lions and other fountains in the Alhambra palace are, with their surroundings, a very magnificent sight. The largest *jets d'eau* are those at Versailles, at the Sydenham Crystal Palace and at San Ildefonso.

About the earliest drawing of any drinking fountain in England occurs in Moxon's *Tutor to Astronomie and Geographie* (1650); it is "surmounted by a dial, which was made by Mr John Leak, and set upon a composite column at Leadenhall corner, in the majoralty of Sir John Dethick, Knight." The water springs from the top and base of the column, which stands upon a square pedestal and bears four female figures, one at least of which represents the costume of the period.

In the East the public drinking fountains are a very important institution. In Cairo alone there are three hundred. These "seehls" are not only to be seen in the cities, but are plentiful in the fields and villages.

The Metropolitan Drinking Fountain Association (1859) has done much to provide facilities in London for both man and beast to get water to drink in the streets. And in the United States liberal provision has also been made by private and public enterprise.

FOUNTAINS ABBEY, one of the most celebrated ecclesiastical ruins in England. It lies in the sequestered valley of the river Skell, 3 m. S.W. of the city of Ripon in Yorkshire. The situation is most beautiful. The little Skell descends from the uplands of Pateley Moor to the west a clear swift stream, traversing a valley clothed with woods, conspicuous among which are some

ancient yew trees which may have sheltered the monks who first sought retreat here. Steep rocky hills enclose the vale. Mainly on the north side of the stream, in an open glade, rise the picturesque and extensive ruins, the church with its stately tower, and the numerous remnants of domestic buildings which enable the great abbey to be almost completely reconstructed in the mind. The arrangements are typical of a Cistercian house (see **ABBAY**). Building began in earnest about 1135, and was continued steadily until the middle of the 13th century, after which the only important erection was Abbot Huby's tower (c. 1500). The demesne of Studley Royal (marquess of Ripon) contains the ruins. It is in part laid out in the formal Dutch style, the work of John Aislable, lord of the manor in the early part of the 18th century. Near the abbey is the picturesque Jacobean mansion of Fountains Hall.

In 1132 the prior and twelve monks of St Mary's abbey, York, being dissatisfied with the easy life they were living, left the monastery and with the assistance of Thurstan, archbishop of York, founded a house in the valley of the Skell, where they adopted the Cistercian rule. While building their monastery the monks are said to have lived at first under an elm and then under seven yew trees called the Seven Sisters. Two years later they were joined by Hugh, dean of St Peter's, York, who brought with him a large sum of money and a valuable collection of books. His example was followed by Serlo, a monk of St Mary's abbey, York, and by Tosti, a canon of York, and others. Henry I. and succeeding sovereigns granted them many privileges. During the reign of Edward I. the monks appear to have again suffered from poverty, partly no doubt owing to the invasion of the Scots, but partly also through their own "misconduct and extravagance." On account of this Edward I. in 1291 appointed John de Berwick custodian of the abbey so that he might pay their debts from the issues of their estates, allowing them enough for their maintenance, and Edward II. in 1319 granted them exemption from taxes. After the Dissolution Henry VIII. sold the manor and site of the monastery to Sir Richard Gresham, and from him after passing through several families it came to the marquess of Ripon.

See *Victoria County History, Yorkshire; Dugdale, Monasticon; Surtees Society, Memorials of the Abbey of St Mary of Fountains*, collected and edited by J. R. Walbran (1863-78).

FOUQUÉ, FERDINAND ANDRÉ (1828-1904), French geologist and petrologist, was born at Mortain, dept. of La Manche, on the 21st of June 1828. At the age of twenty-one he entered the *École Normale* in Paris, and from 1853 to 1858 he held the appointment of keeper of the scientific collections. In 1877 he became professor of natural history at the *Collège de France*, in Paris, and in 1881 he was elected a member of the Academy of Sciences. As a stratigraphical geologist he rendered much assistance on the Geological Survey of France, but in the course of time he gave his special attention to the study of volcanic phenomena and earthquakes, to minerals and rocks; and he was the first to introduce modern petrographical methods into France. His studies of the eruptive rocks of Corsica, Santorin and elsewhere; his researches on the artificial reproduction of eruptive rocks, and his treatise on the optical characters of felspars deserve special mention; but he was perhaps best known for the joint work which he carried on with his friend Michel Lévy. He died on the 7th of March 1904. His chief publications were: *Santorin et ses éruptions*, 1879; (with A. Michel Lévy) *Minéralogie micrographique, Roches éruptives françaises* (2 vols., 1879); and *Synthèse des minéraux et des roches* (1882).

FOUQUÉ, FRIEDRICH HEINRICH KARL DE LA MOTTE, BARON (1777-1843), German writer of the romantic movement, was born on the 12th of February 1777 at Brandenburg. His grandfather had been one of Frederick the Great's generals and his father was a Prussian officer. Although not originally intended for a military career, Friedrich de la Motte Fouqué ultimately gave up his university studies at Halle to join the army, and he took part in the Rhine campaign of 1794. The rest of his life was devoted mainly to literary pursuits. Like so many of the younger romanticists, Fouqué owed his introduction to

literature to A. W. Schlegel, who published his first book, *Dramatische Spiele von Pellegrin* in 1804. His next work, *Romanzen vom Tal Ronceval* (1805), showed more plainly his allegiance to the romantic leaders, and in the *Historie vom edlen Ritter Galmy* (1806) he versified a 16th-century romance of medieval chivalry. *Sigurd der Schlangentöler, ein Heldenspiel* (1808), the first modern German dramatization of the *Nibelungen* saga, attracted attention to him, and influenced considerably subsequent versions of the story, such as Hebbel's *Nibelungen* and Wagner's *Ring des Nibelungen*. These early writings indicate the lines which Fouqué's subsequent literary activity followed; his interests were divided between mediæval chivalry on the one hand and northern mythology on the other. In 1813, the year of the rising against Napoleon, he again fought with the Prussian army, and the new patriotism awakened in the German people left its mark upon his writings.

Between 1810 and 1815 Fouqué's popularity was at its height; the many romances and novels, plays and epics, which he turned out with extraordinary rapidity, appealed exactly to the mood of the hour. The earliest of these are the best—*Undine*, which appeared in 1811, being, indeed, one of the most charming of all German *Märchen* and the only work by which Fouqué's memory still lives to-day. A more comprehensive idea of his powers may, however, be obtained from the two romances *Der Zauberring* (1813) and *Die Fahrten Thiodulfs des Isländers* (1815). From 1820 onwards the quality of Fouqué's work rapidly degenerated, partly owing to the fatal ease with which he wrote, partly to his inability to keep pace with the changes in German taste. He remained the belated romanticist, who, as the reading world turned to new interests, clung the more tenaciously to the paraphernalia of romanticism; but in the cold, sober light of the post-romantic age, these appeared merely flimsy and theatrical. The vitalizing imaginative power of his early years deserted him, and the sobriquet of a "Don Quixote of Romanticism" which his enemies applied to him was not unjustified.

Fouqué's first marriage had been unhappy and soon ended in divorce. His second wife, Karoline von Briest (1773-1831) enjoyed some reputation as a novelist in her day. After her death Fouqué married a third time. Some consolation for the ebbing tide of popular favour was afforded him by the munificence of Frederick William IV. of Prussia, who granted him a pension which allowed him to spend his later years in comfort. He died in Berlin on the 23rd of January 1843.

Fouqué's *Ausgewählte Werke*, edited by himself, appeared in 12 vols. (Berlin, 1841); a selection, edited by M. Koch, will be found in Kürschner's *Deutsche Nationalliteratur*, vol. 146, part ii. (Stuttgart, 1893); *Undine, Sintram*, &c., in innumerable reprints. Bibliography in Goedeke's *Grundriss zur Geschichte der deutschen Dichtung* (2nd ed., vi. pp. 115 ff., Dresden, 1898). Most of Fouqué's works have been translated, and the English versions of *Aslauga's Knight* (by Carlyle), *Sintram and his Companions* and *Undine*, have been frequently republished. For Fouqué's life cp. *Lebensgeschichte des Baron Friedrich de la Motte Fouqué. Aufgezeichnet durch ihn selbst* (Halle, 1840), (only to the year 1813), and also the introduction to Koch's selections in the *Deutsche Nationalliteratur*. (J. G. R.)

FOUQUET (or **FOUCQUET**), **NICOLAS** (1615-1680), viscount of Melun and of Vaux, marquis of Belle-Isle, superintendent of finance in France under Louis XIV., was born at Paris in 1615. He belonged to an influential family of the *noblesse de la robe*, and after some preliminary schooling with the Jesuits, at the age of thirteen was admitted as *avocat* at the parlement of Paris. While still in his teens he held several responsible posts, and in 1636, when just twenty, he was able to buy the post of *maître des requêtes*. From 1642 to 1650 he held various intendantships at first in the provinces and then with the army of Mazarin, and, coming thus in touch with the court, was permitted in 1650 to buy the important position of *procurcur général* to the parlement of Paris. During Mazarin's exile Fouquet shrewdly remained loyal to him, protecting his property and keeping him informed of the situation at court.

Upon the cardinal's return, Fouquet demanded and received as reward the office of superintendent of the finances (1653), a position which, in the unsettled condition of the government, threw into his hands not merely the decision as to which funds

should be applied to meet the demands of the state's creditors, but also the negotiations with the great financiers who lent money to the king. The appointment was a popular one with the moneyed class, for Fouquet's great wealth had been largely augmented by his marriage in 1651 with Marie de Castille, who also belonged to a wealthy family of the legal nobility. His own credit, and above all his unflinching confidence in himself, strengthened the credit of the government, while his high position at the parlement (he still remained *procurcur général*) secured financial transactions from investigation. As minister of finance, he soon had Mazarin almost in the position of a suppliant. The long wars, and the greed of the courtiers, who followed the example of Mazarin, made it necessary at times for Fouquet to meet the demands upon him by borrowing upon his own credit, but he soon turned this confusion of the public purse with his own to good account. The disorder in the accounts became hopeless; fraudulent operations were entered into with impunity, and the financiers were kept in the position of clients by official favours and by generous aid whenever they needed it. Fouquet's fortune now surpassed even Mazarin's, but the latter was too deeply implicated in similar operations to interfere, and was obliged to leave the day of reckoning to his agent and successor Colbert. Upon Mazarin's death Fouquet expected to be made head of the government; but Louis XIV. was suspicious of his poorly dissembled ambition, and it was with Fouquet in mind that he made the well-known statement, upon assuming the government, that he would be his own chief minister. Colbert fed the king's displeasure with adverse reports upon the deficit, and made the worst of the case against Fouquet. The extravagant expenditure and personal display of the superintendent served to intensify the ill-will of the king. Fouquet had bought the port of Belle Isle and strengthened the fortifications, with a view to taking refuge there in case of disgrace. He had spent enormous sums in building a palace on his estate of Vaux, which in extent, magnificence, and splendour of decoration was a forecast of Versailles. Here he gathered the rarest manuscripts, the finest paintings, jewels and antiques in profusion, and above all surrounded himself with artists and authors. The table was open to all people of quality, and the kitchen was presided over by Vatel. Lafontaine, Corneille, Scarron, were among the multitude of his clients. In August 1661 Louis XIV., already set upon his destruction, was entertained at Vaux with a *fête* rivalled in magnificence by only one or two in French history, at which Molière's *Les Fâcheux* was produced for the first time. The splendour of the entertainment sealed Fouquet's fate. The king, however, was afraid to act openly against so powerful a minister. By crafty devices Fouquet was induced to sell his office of *procurcur général*, thus losing the protection of its privileges, and he paid the price of it into the treasury.

Three weeks after his visit to Vaux the king withdrew to Nantes, taking Fouquet with him, and had him arrested when he was leaving the presence chamber, flattered with the assurance of his esteem. The trial lasted almost three years, and its violation of the forms of justice is still the subject of frequent monographs by members of the French bar. Public sympathy was strongly with Fouquet, and Lafontaine, Madame de Sévigné and many others wrote on his behalf; but when Fouquet was sentenced to banishment, the king, disappointed, "commuted" the sentence to imprisonment for life. He was sent at the beginning of 1665 to the fortress of Pignerol, where he undoubtedly died on the 23rd of March 1680.¹ Louis acted throughout "as though he were conducting a campaign," evidently fearing that Fouquet would play the part of a Richelieu. Fouquet bore himself with manly fortitude, and composed several mediocre translations in prison. The devotional works bearing his name are apocryphal. A report of his trial was published in Holland, in 15 volumes, in 1665-1667, in spite of the remonstrances which Colbert addressed to the States-General. A second edition under the title of *Œuvres de M. Fouquet* appeared in 1696.

¹ Fouquet has been identified with the "Man with the Iron Mask" (see IRON MASK), but this theory is quite impossible.

See Chéruel, *Mémoires sur la vie publique et privée de Fouquet* . . . d'après ses lettres et des pièces inédites (2 vols., Paris, 1864); J. Lair, *Nicolas Fouquet, procureur général, surintendant des finances, ministre d'État de Louis XIV* (2 vols., Paris, 1890); U. V. Châtelain, *Le Surintendant Nicolas Fouquet, protecteur des lettres, des arts et des sciences* (Paris, 1905); R. Pfnor et A. France, *Le Château de Vaux-le-Vicomte dessiné et gravé* (Paris, 1888).

FOUQUIER-TINVILLE, ANTOINE QUENTIN (1746–1795), French revolutionist, was born at Hérouel, a village in the department of the Aisne. Originally a *procureur* attached to the Châtelet at Paris, he sold his office in 1783, and became a clerk under the lieutenant-general of police. He seems to have early adopted revolutionary ideas, but little is known of the part he played at the outbreak of the Revolution. When the Revolutionary Tribunal of Paris was established on the 10th of March 1793, he was appointed public prosecutor to it, an office which he filled until the 28th of July 1794. His activity during this time earned him the reputation of one of the most terrible and sinister figures of the Revolution. His function as public prosecutor was not so much to convict the guilty as to see that the proscriptions ordered by the faction for the time being in power were carried out with a due regard to a show of legality. He was as ruthless and as incorrupt as Robespierre himself; he could be moved from his purpose neither by pity nor by bribes; nor was there in his cruelty any of that quality which made the ordinary Jacobin *enragé* by turns ferocious and sentimental. It was this very quality of passionless detachment that made him so effective an instrument of the Terror. He had no forensic eloquence; but the cold obstinacy with which he pressed his charges was more convincing than any rhetoric, and he seldom failed to secure a conviction.

His horrible career ended with the fall of Robespierre and the terrorists on the 9th Thermidor. On the 1st of August 1794 he was imprisoned by order of the Convention and brought to trial. His defence was that he had only obeyed the orders of the Committee of Public Safety; but, after a trial which lasted forty-one days, he was condemned to death, and guillotined on the 7th of May 1795.

See *Mémoire pour A. Q. Fouquier ex-accusateur public près le tribunal révolutionnaire*, &c. (Paris, 1794); Domenget, *Fouquier-Tinville et le tribunal révolutionnaire* (Paris, 1878); H. Wallon, *Histoire du tribunal révolutionnaire de Paris* (1880–1882) (a work of general interest, but not always exact); George Lecocq, *Notes et documents sur Fouquier-Tinville* (Paris, 1885). See also the documents relating to his trial enumerated by M. Tourneux in *Bibliographie de l'histoire de Paris pendant la Révolution Française*, vol. i. Nos. 4445–4454 (1890).

FOURCHAMBAULT, a town of central France in the department of Nièvre, on the right bank of the Loire, $4\frac{1}{2}$ m. N.W. of Nevers, on the Paris-Lyon railway. Pop. (1906) 4591. It owes its importance to its extensive iron-works, established in 1821, which give employment to 2000 workmen and produce engineering material for railway, military and other purposes. Among the more remarkable *chefs-d'œuvre* which have been produced at Fourchambault are the metal portions of the Pont du Carrousel, the iron beams of the roof of the cathedral at Chartres, and the vast spans of the bridge over the Dordogne at Cubzac. A small canal unites the works to the Lateral canal of the Loire.

FOURCROY, ANTOINE FRANÇOIS, COMTE DE (1755–1809), French chemist, the son of an apothecary in the household of the duke of Orleans, was born at Paris on the 15th of June 1755. He took up medical studies by the advice of the anatomist Félix Vicq d'Azyr (1748–1794), and after many difficulties caused by lack of means finally in 1780 obtained his doctor's diploma. His attention was specially turned to chemistry by J. B. M. Bucquet (1746–1780), the professor of chemistry at the Medical School of Paris, and in 1784 he was chosen to succeed P. J. Macquer (1718–1784) as lecturer in chemistry at the college of the Jardin du Roi, where his lectures attained great popularity. He was one of the earliest converts to the views of Lavoisier, which he helped to promulgate by his voluminous writings, but though his name appears on a large number of chemical and also physiological and pathological memoirs, either alone or with others, he was rather a teacher and an organizer than an

original investigator. A member of the committees for public instruction and public safety, and later, under Napoleon, director general of instruction, he took a leading part in the establishment of schools for both primary and secondary education, scientific studies being especially provided for. Fourcroy died at Paris on the 16th of December 1809, the very day on which he had been created a count of the French empire. By his conduct as a member of the Convention he has been accused of contributing to the death of Lavoisier. Baron Cuvier in his *Éloge historique* of Fourcroy repels the charge, but he can scarcely be acquitted of time-serving indifference, if indeed active, though secret, participation be not proved against him.

The Royal Society's *Catalogue of Scientific Papers* enumerates 59 memoirs by Fourcroy himself, and 58 written jointly by him and others, mostly L. N. Vauquelin.

FOURIER, FRANÇOIS CHARLES MARIE (1772–1837), French socialist writer, was born at Besançon in Franche-Comté on the 7th of April 1772. His father was a draper in good circumstances, and Fourier received an excellent education at the college in his native town. After completing his studies there he travelled for some time in France, Germany and Holland. On the death of his father he inherited a considerable amount of property, which, however, was lost when Lyons was besieged by the troops of the Convention. Being thus deprived of his means of livelihood Fourier entered the army, but after two years' service as a *chasseur* was discharged on account of ill-health. In 1803 he published a remarkable article on European politics which attracted the notice of Napoleon, some of whose ideas were foreshadowed in it. Inquiries were made after the author, but nothing seems to have come of them. After leaving the army Fourier entered a merchant's office in Lyons, and some years later undertook on his own account a small business as broker. He obtained in this way just sufficient to supply his wants, and devoted all his leisure time to the elaboration of his first work on the organization of society.

During the early part of his life, and while engaged in commerce, he had become deeply impressed with the conviction that social arrangements resulting from the principles of individualism and competition were essentially imperfect and immoral. He proposed to substitute for these principles co-operation or united effort, by means of which full and harmonious development might be given to human nature. The scheme, worked out in detail in his first work, *Théorie des quatre mouvements* (2 vols., Lyons, 1808, published anonymously), has for foundation a particular psychological proposition and a special economical doctrine. Psychologically Fourier held what may with some laxity of language be called natural optimism,—the view that the full, free development of human nature or the unrestrained indulgence of human passion is the only possible way to happiness and virtue, and that misery and vice spring from the unnatural restraints imposed by society on the gratification of desire. This principle of harmony among the passions he regarded as his grandest discovery—a discovery which did more than set him on a level with Newton, the discoverer of the principle of attraction or harmony among material bodies. Throughout his works, in uncouth, obscure and often unintelligible language, he endeavours to show that the same fundamental fact of harmony is to be found in the four great departments,—society, animal life, organic life and the material universe. In order to give effect to this principle and obtain the resulting social harmony, it was needful that society should be reconstructed; for, as the social organism is at present constituted, innumerable restrictions are imposed upon the free development of human desire. As practical principle for such a reconstruction Fourier advocated co-operative or united industry. In many respects what he says of co-operation, in particular as to the enormous waste of economic force which the actual arrangements of society entail, still deserves attention, and some of the most recent efforts towards extension of the co-operative method, e.g. to house-keeping, were in essentials anticipated by him. But the full realization of his scheme demanded much more than the mere admission that co-operation is economically more

efficacious than individualism. Society as a whole must be organized on the lines requisite to give full scope to co-operation and to the harmonious evolution of human nature. The details of this reorganization of the social structure cannot be given briefly, but the broad outlines may be thus sketched. Society, on his scheme, is to be divided into departments or *phalanges*, each *phalange* numbering about 1600 persons. Each *phalange* inhabits a *phalanstère* or common building, and has a certain portion of soil allotted to it for cultivation. The *phalanstères* are built after a uniform plan, and the domestic arrangements are laid down very elaborately. The staple industry of the *phalanges* is, of course, agriculture, but the various *series* and *groupes* into which the members are divided may devote themselves to such occupations as are most to their taste; nor need any occupation become irksome from constant devotion to it. Any member of a group may vary his employment at pleasure, may pass from one task to another. The tasks regarded as menial or degrading in ordinary society can be rendered attractive if advantage is taken of the proper principles of human nature: thus children, who have a natural affinity for dirt, and a fondness for "cleaning up," may easily be induced to accept with eagerness the functions of public scavengers. It is not, on Fourier's scheme, necessary that private property should be abolished, nor is the privacy of family life impossible within the *phalanstère*. Each family may have separate apartments, and there may be richer and poorer members. But the rich and poor are to be locally intermingled, in order that the broad distinction between them, which is so painful a feature in actual society, may become almost imperceptible. Out of the common gain of the *phalange* a certain portion is deducted to furnish to each member the minimum of subsistence; the remainder is distributed in shares to labour, capital and talent,—five-twelfths going to the first, four-twelfths to the second and three-twelfths to the third. Upon the changes requisite in the private life of the members Fourier was in his first work more explicit than in his later writings. The institution of marriage, which imposes unnatural bonds on human passion, is of necessity abolished; a new and ingeniously constructed system of licence is substituted for it. Considerable offence seems to have been given by Fourier's utterances with regard to marriage, and generally the later advocates of his views are content to pass the matter over in silence or to veil their teaching under obscure and metaphorical language.

The scheme thus sketched attracted no attention when the *Théorie* first appeared, and for some years Fourier remained in his obscure position at Lyons. In 1812 the death of his mother put him in possession of a small sum of money, with which he retired to Bellay in order to perfect his second work. The *Traité de l'association agricole domestique* was published in 2 vols. at Paris in 1822, and a summary appeared in the following year. After its publication the author proceeded to Paris in the hope that some wealthy capitalist might be induced to attempt the realization of the projected scheme. Disappointed in this expectation he returned to Lyons. In 1826 he again visited Paris, and as a considerable portion of his means had been expended in the publication of his book, he accepted a clerkship in an American firm. In 1829 and 1830 appeared what is probably the most finished exposition of his views, *Le Nouveau Monde industriel*. In 1831 he attacked the rival socialist doctrines of Saint-Simon and Owen in the small work *Pièges et charlatanisme de deux sectes, St Simon et Owen*. His writings now began to attract some attention. A small body of adherents gathered round him, and the most ardent of them was Victor Considérant (*q.v.*). In 1832 a newspaper, *Le Phalanstère ou la réforme industrielle* was started to propagate the views of the school, but its success was not great. In 1833 it declined from a weekly to a monthly, and in 1834 it died of inanition. It was revived in 1836 as *Le Phalange*, and in 1843 became a daily paper, *La Démocratie pacifique*. In 1850 it was suppressed.

Fourier did not live to see the success of his newspaper, and the only practical attempt during his lifetime to establish a *phalanstère* was a complete failure. In 1832 M. Baudet Dulary,

deputy for Seine-et-Oise, who had become a convert, purchased an estate at Condé-sur-Vesgre, near the forest of Rambouillet, and proceeded to establish a socialist community. The capital supplied was, however, inadequate, and the community broke up in disgust. Fourier was in no way discouraged by this failure, and till his death, on the 10th of October 1837, he lived in daily expectation that wealthy capitalists would see the merits of his scheme and be induced to devote their fortunes to its realization. It may be added that subsequent attempts to establish the *phalanstère* have been uniformly unsuccessful.¹

Fourier seems to have been of an extremely retiring and sensitive disposition. He mixed little in society, and appeared, indeed, as if he were the denizen of some other planet. Of the true nature of social arrangements, and of the manner in which they naturally grow and become organized, he must be pronounced extremely ignorant. The faults of existing institutions presented themselves to him in an altogether distorted manner, and he never appears to have recognized that the evils of actual society are immeasurably less serious than the consequences of his arbitrary scheme. Out of the chaos of human passion he supposed harmony was to be evolved by the adoption of a few theoretically disputable principles, which themselves impose restraints even more irksome than those due to actual social facts. With regard to the economic aspects of his proposed new method, it is of course to be granted that co-operation is more effective than individual effort, but he has nowhere faced the question as to the probable consequences of organizing society on the abolition of those great institutions which have grown with its growth. His temperament was too ardent, his imagination too strong, and his acquaintance with the realities of life too slight to enable him justly to estimate the merits of his fantastic views. That this description of him is not expressed in over-strong language must be clear to any one who not only considers what is true in his works,—and the portion of truth is by no means a peculiar discovery of Fourier's,—but who takes into account the whole body of his speculations, the cosmological and historical as well as the economical and social. No words can adequately describe the fantastic nonsense which he pours forth, partly in the form of general speculation on the universe, partly in the form of prophetic utterances with regard to the future changes in humanity and its material environment. From these extraordinary writings it is no extreme conclusion that there was much of insanity in Fourier's mental constitution.

AUTHORITIES.—Ch. Pellarin, *Fourier, sa vie et sa théorie* (5th ed., 1872); Sargent, *Social Innovators* (1859); Reybaud, *Réformateurs modernes* (7th ed., 1864); Stein, *Sozialismus und Communismus des heutigen Frankreichs* (2nd ed., 1848); A. J. Booth, *Fortnightly Review*, N. S., vol. xii.; Czysnki, *Notice bibliographique sur C. Fourier* (1841); Ferraz, *Le Socialisme, le naturalisme et le positivisme* (1877); Considérant, *Exposition abrégée du système de Fourier* (1845); Transon, *Théorie sociétaire de Charles Fourier* (1832); Stein, *Geschichte der sozialen Bewegung in Frankreich* (1850); Marlo, *Untersuchungen über die Organisation der Arbeit* (1853); J. H. Noyes, *History of American Socialisms* (1870); Bebel, *Charles Fourier* (1888); Varschauer, *Geschichte des Sozialismus und Kommunismus im 19. Jahrhundert* (1903); Sambuc, *Le Socialisme de Fourier* (1900); M. Hillquit, *History of Socialism in the United States* (1903); H. Bourgin, *Fourier, contribution à l'étude de socialisme français* (1905). (R. AD.)

FOURIER, JEAN BAPTISTE JOSEPH (1768–1830), French mathematician, was born at Auxerre on the 21st of March 1768. He was the son of a tailor, and was left an orphan in his eighth year; but, through the kindness of a friend, admission was gained for him into the military school of his native town, which was then under the direction of the Benedictines of Saint-Maur. He soon distinguished himself as a student and made rapid progress, especially in mathematics. Debarred from entering the army on account of his lowliness of birth and poverty, he was appointed

¹ Several experiments were made to this end in the United States (see COMMUNISM) by American followers of Fourier, whose doctrines were introduced there by Albert Brisbane (1809–1890). Indeed, in the years between 1840 and 1850, during which the movement waxed and waned, no fewer than forty-one *phalanges* were founded, of which some definite record can be found. The most interesting of all the experiments, not alone from its own history, but also from the fact that it attracted the support of many of the most intellectual and cultured Americans was that of Brook Farm (*q.v.*).

professor of mathematics in the school in which he had been a pupil. In 1787 he became a novice at the abbey of St Benoît-sur-Loire; but he left the abbey in 1789 and returned to his college, where, in addition to his mathematical duties, he was frequently called to lecture on other subjects,—rhetoric, philosophy and history. On the institution of the École Normale at Paris in 1795 he was sent to teach in it, and was afterwards attached to the École Polytechnique, where he occupied the chair of analysis. Fourier was one of the savants who accompanied Bonaparte to Egypt in 1798; and during this expedition he was called to discharge important political duties in addition to his scientific ones. He was for a time virtually governor of half Egypt, and for three years was secretary of the Institut du Caire; he also delivered the funeral orations for Kléber and Desaix. He returned to France in 1801, and in the following year he was nominated prefect of Isère, and was created baron and chevalier of the Legion of Honour. He took an important part in the preparation of the famous *Description de l'Égypte* and wrote the historical introduction. He held his prefecture for fourteen years; and it was during this period that he carried on his elaborate and fruitful investigations on the conduction of heat. On the return of Napoleon from Elba, in 1815, Fourier published a royalist proclamation, and left Grenoble as Napoleon entered it. He was then deprived of his prefecture, and, although immediately named prefect of the Rhône, was soon after again deprived. He now settled at Paris, was elected to the Académie des Sciences in 1816, but in consequence of the opposition of Louis XVIII. was not admitted till the following year, when he succeeded the Abbé Alexis de Rochon. In 1822 he was made perpetual secretary in conjunction with Cuvier, in succession to Delambre. In 1826 Fourier became a member of the French Academy, and in 1827 succeeded Laplace as president of the council of the École Polytechnique. In 1828 he became a member of the government commission established for the encouragement of literature. He died at Paris on the 16th of May 1830.

As a politician Fourier achieved uncommon success, but his fame chiefly rests on his strikingly original contributions to science and mathematics. The theory of heat engaged his attention quite early, and in 1812 he obtained a prize offered by the Académie des Sciences with a memoir in two parts, *Théorie des mouvements de la chaleur dans les corps solides*. The first part was republished in 1822 as *La Théorie analytique de la chaleur*, which by its new methods and great results made an epoch in the history of mathematical and physical science (see below: FOURIER'S SERIES). An English translation has been published by A. Freeman (Cambridge, 1872), and a German by Weinstein (Berlin, 1884). His mathematical researches were also concerned with the theory of equations, but the question as to his priority on several points has been keenly discussed. After his death Navier completed and published Fourier's unfinished work, *Analyse des équations indéterminées* (1831), which contains much original matter. In addition to the works above mentioned, Fourier wrote many memoirs on scientific subjects, and *Éloges* of distinguished men of science. His works have been collected and edited by Gaston Darboux with the title *Œuvres de Fourier* (Paris, 1889-1890).

For a list of Fourier's publications see the *Catalogue of Scientific Papers of the Royal Society of London*. Reference may also be made to Arago, "Joseph Fourier," in the *Smithsonian Report* (1871).

FOURIER'S SERIES, in mathematics, those series which proceed according to sines and cosines of multiples of a variable, the various multiples being in the ratio of the natural numbers; they are used for the representation of a function of the variable for values of the variable which lie between prescribed finite limits. Although the importance of such series, especially in the theory of vibrations, had been recognized by D. Bernoulli, Lagrange and other mathematicians, and had led to some discussion of their properties, J. B. J. Fourier (see above) was the first clearly to recognize the arbitrary character of the functions which the series can represent, and to make any serious attempt to prove the validity of such representation; the series are

consequently usually associated with the name of Fourier. More general cases of trigonometrical series, in which the multiples are given as the roots of certain transcendental equations, were also considered by Fourier.

Before proceeding to the consideration of the special class of series to be discussed, it is necessary to define with some precision what is to be understood by the representation of an arbitrary function by an infinite series. Suppose a function of a variable x to be arbitrarily given for values of x between two fixed values a and b ; this means that, corresponding to every value of x such that $a \leq x \leq b$, a definite arithmetical value of the function is assigned by means of some prescribed set of rules. A function so defined may be denoted by $f(x)$; the rules by which the values of the function are determined may be embodied in a single explicit analytical formula, or in several such formulae applicable to different portions of the interval, but it would be an undue restriction of the nature of an arbitrarily given function to assume *a priori* that it is necessarily given in this manner, the possibility of the representation of such a function by means of a single analytical expression being the very point which we have to discuss. The variable x may be represented by a point at the extremity of an interval measured along a straight line from a fixed origin; thus we may speak of the point c as synonymous with the value $x=c$ of the variable, and of $f(c)$ as the value of the function assigned to the point c . For any number of points between a and b the function may be discontinuous, *i.e.* it may at such points undergo abrupt changes of value; it will here be assumed that the number of such points is finite. The only discontinuities here considered will be those known as ordinary discontinuities. Such a discontinuity exists at the point c if $f(c+\epsilon)$, $f(c-\epsilon)$ have distinct but definite limiting values as ϵ is indefinitely diminished; these limiting values are known as the limits on the right and on the left respectively of the function at c , and may be denoted by $f(c+0)$, $f(c-0)$. The discontinuity consists therefore of a sudden change of value of the function from $f(c-0)$ to $f(c+0)$, as x increases through the value c . If there is such a discontinuity at the point $x=0$, we may denote the limits on the right and on the left respectively by $f(+0)$, $f(-0)$.

Suppose we have an infinite series $u_1(x) + u_2(x) + \dots + u_n(x) + \dots$ in which each term is a function of x , of known analytical form; let any value $x=c$ ($a \leq c \leq b$) be substituted in the terms of the series, and suppose the sum of n terms of the arithmetical series so obtained approaches a definite limit as n is indefinitely increased; this limit is known as the sum of the series. If for every value of c such that $a \leq c \leq b$ the sum exists and agrees with the value of $f(c)$, the series $\sum u_n(x)$ is said to represent the function $f(x)$ between

the values a , b of the variable. If this is the case for all points within the given interval with the exception of a finite number, at any one of which either the series has no sum, or has a sum which does not agree with the value of the function, the series is said to represent "in general" the function for the given interval. If the sum of n terms of the series be denoted by $S_n(c)$, the condition that $S_n(c)$ converges to the value $f(c)$ is that, corresponding to any finite positive number δ as small as we please, a value n_1 of n can be found such that if $n \geq n_1$, $|f(c) - S_n(c)| < \delta$.

Functions have also been considered which for an infinite number of points within the given interval have no definite value, and series have also been discussed which at an infinite number of points in the interval cease either to have a sum, or to have one which agrees with the value of the function; the narrower conception above will however be retained in the treatment of the subject in this article, reference to the wider class of cases being made only in connexion with the history of the theory of Fourier's Series.

Uniform Convergence of Series.—If the series $u_1(x) + u_2(x) + \dots + u_n(x) + \dots$ converge for every value of x in a given interval a to b , and its sum be denoted by $S(x)$, then if, corresponding to a finite positive number δ , as small as we please, a finite number n_1 can be found such that the arithmetical value of $S(x) - S_n(x)$, where $n \geq n_1$ is less than δ , for every value of x in the given interval, the series is said to converge uniformly in that interval. It may however happen that as x approaches a particular value the number of terms of the series which must be taken so that $|S(x) - S_n(x)|$ may be $< \delta$, increases indefinitely; the convergence of the series is then infinitely slow in the neighbourhood of such a point, and the series is not uniformly convergent throughout the given interval, although it converges at each point of the interval. If the number of such points in the neighbourhood of which the series ceases to converge uniformly be finite, they may be excluded by taking intervals of finite magnitude as small as we please containing such points, and considering the convergence of the series in the given interval with such sub-intervals excluded; the convergence of the series is now uniform throughout the remainder of the interval. The series is said to be *in general* uniformly convergent within the given interval a to b if it can be made uniformly convergent by the exclusion of a finite number of portions of the interval, each such portion being arbitrarily small. It is known that the sum of an infinite series of continuous terms can be discontinuous only at points in the neighbourhood of which the convergence of the series is not

uniform, but non-uniformity of convergence of the series does not necessarily imply discontinuity in the sum.

Form of Fourier's Series.—If it be assumed that a function $f(x)$ arbitrarily given for values of x such that $0 \leq x \leq l$ is capable of being represented in general by an infinite series of the form

$$A_1 \sin \frac{\pi x}{l} + A_2 \sin \frac{2\pi x}{l} + \dots + A_n \sin \frac{n\pi x}{l} + \dots,$$

and if it be further assumed that the series is in general uniformly convergent throughout the interval 0 to l , the form of the coefficients A can be determined. Multiply each term of the series by $\sin \frac{n\pi x}{l}$, and integrate the product between the limits 0 and l ,

then in virtue of the property $\int_0^l \sin \frac{n\pi x}{l} \sin \frac{n'\pi x}{l} dx = 0$, or $\frac{1}{2}l$, according

as n' is not, or is, equal to n , we have $\frac{1}{2}lA_n = \int_0^l f(x) \sin \frac{n\pi x}{l} dx$, and

thus the series is of the form $\frac{2}{l} \sum \sin \frac{n\pi x}{l} \int_0^l f(x) \sin \frac{n\pi x}{l} dx \dots (1)$

This method of determining the coefficients in the series would not be valid without the assumption that the series is in general uniformly convergent, for in accordance with a known theorem the sum of the integrals of the separate terms of the series is otherwise not necessarily equal to the integral of the sum. This assumption being made, it is further assumed that $f(x)$ is such that $\int_0^l f(x) \sin \frac{n\pi x}{l} dx$ has a definite meaning for every value of n .

Before we proceed to examine the justification for the assumptions made, it is desirable to examine the result obtained, and to deduce other series from it. In order to obtain a series of the form

$$B_0 + B_1 \cos \frac{\pi x}{l} + B_2 \cos \frac{2\pi x}{l} + \dots + B_n \cos \frac{n\pi x}{l} + \dots$$

for the representation of $f(x)$ in the interval 0 to l , let us apply the series (1) to represent the function $f(x) \sin \frac{\pi x}{l}$; we thus find

$$\frac{2}{l} \sum \sin \frac{n\pi x}{l} \int_0^l f(x) \sin \frac{\pi x}{l} \sin \frac{n\pi x}{l} dx,$$

or

$$\frac{1}{l} \sum \sin \frac{n\pi x}{l} \int_0^l f(x) \left\{ \cos \frac{(n-1)\pi x}{l} - \cos \frac{(n+1)\pi x}{l} \right\} dx.$$

On rearrangement of the terms this becomes

$$\frac{1}{l} \sin \frac{\pi x}{l} \int_0^l f(x) dx + \frac{2}{l} \sum \sin \frac{\pi x}{l} \cos \frac{n\pi x}{l} \int_0^l f(x) \cos \frac{n\pi x}{l} dx.$$

hence $f(x)$ is represented for the interval 0 to l by the series of cosines

$$\frac{1}{l} \int_0^l f(x) dx + \frac{2}{l} \sum \cos \frac{n\pi x}{l} \int_0^l f(x) \cos \frac{n\pi x}{l} dx \dots (2)$$

We have thus seen, that with the assumptions made, the arbitrary function $f(x)$ may be represented, for the given interval, either by a series of sines, as in (1), or by a series of cosines, as in (2). Some important differences between the two series must, however, be noticed. In the first place, the series of sines has a vanishing sum when $x=0$ or $x=l$; it therefore does not represent the function at the point $x=0$, unless $f(0)=0$, or at the point $x=l$, unless $f(l)=0$, whereas the series (2) of cosines may represent the function at both these points. Again, let us consider what is represented by (1) and (2) for values of x which do not lie between 0 and l . As $f(x)$ is given only for values of x between 0 and l , the series at points beyond these limits have no necessary connexion with $f(x)$ unless we suppose that $f(x)$ is also given for such general values of x in such a way that the series continue to represent that function. If in (1) we change x into $-x$, leaving the coefficients unaltered, the series changes sign, and if x be changed into $x+2l$, the series is unaltered; we infer that the series (1) represents an odd function of x and is periodic of period $2l$; thus (1) will represent $f(x)$ in general for values of x between $-\infty$ and $+\infty$, only if $f(x)$ is odd and has a period $2l$. If in (2) we change x into $-x$, the series is unaltered, and it is also unaltered by changing x into $x+2l$; from this we see that the series (2) represents $f(x)$ for values of x between $-\infty$ and $+\infty$, only if $f(x)$ is an even function, and is periodic of period $2l$. In general a function $f(x)$ arbitrarily given for all values of x between $-\infty$ and $+\infty$ is neither periodic nor odd, nor even, and is therefore not represented by either (1) or (2) except for the interval 0 to l .

From (1) and (2) we can deduce a series containing both sines and cosines, which will represent a function $f(x)$ arbitrarily given in the interval $-l$ to l , for that interval. We can express by (1) the function $\frac{1}{2}\{f(x)-f(-x)\}$ which is an odd function, and thus this function is represented for the interval $-l$ to $+l$ by

$$\frac{2}{l} \sum \sin \frac{n\pi x}{l} \int_0^l \frac{1}{2}\{f(x)-f(-x)\} \sin \frac{n\pi x}{l} dx;$$

we can also express $\frac{1}{2}\{f(x)+f(-x)\}$, which is an even function, by means of (2), thus for the interval $-l$ to $+l$ this function is represented by

$$\frac{1}{l} \int_0^l \{f(x)+f(-x)\} dx + \frac{2}{l} \sum \cos \frac{n\pi x}{l} \int_0^l \frac{1}{2}\{f(x)+f(-x)\} \cos \frac{n\pi x}{l} dx.$$

It must be observed that $f(-x)$ is absolutely independent of $f(x)$,

the former being not necessarily deducible from the latter by putting $-x$ for x in a formula; both $f(x)$ and $f(-x)$ are functions given arbitrarily and independently for the interval 0 to l . On adding the expressions together we obtain a series of sines and cosines which represents $f(x)$ for the interval $-l$ to l . The integrals

$$\int_0^l f(-x) \cos \frac{n\pi x}{l} dx, \int_0^l f(-x) \sin \frac{n\pi x}{l} dx$$

are equivalent to

$$-\int_0^{-l} f(x) \cos \frac{n\pi x}{l} dx, + \int_0^{-l} f(x) \sin \frac{n\pi x}{l} dx,$$

thus the series is

$$\frac{1}{2l} \int_{-l}^l f(x) dx + \frac{1}{l} \sum \cos \frac{n\pi x}{l} \int_{-l}^l f(x) \cos \frac{n\pi x}{l} dx + \frac{1}{l} \sum \sin \frac{n\pi x}{l} \int_{-l}^l f(x) \sin \frac{n\pi x}{l} dx,$$

which may be written

$$\frac{1}{2l} \int_{-l}^l f(x') dx' + \frac{1}{l} \sum \int_{-l}^l f(x') \cos \frac{n\pi(x-x')}{l} dx' \dots (3)$$

The series (3), which represents a function $f(x)$ arbitrarily given for the interval $-l$ to l , is what is known as Fourier's Series; the expressions (1) and (2) being regarded as the particular forms which (3) takes in the two cases, in which $f(-x) = -f(x)$, or $f(-x) = f(x)$ respectively. The expression (3) does not represent $f(x)$ at points beyond the interval $-l$ to l , unless $f(x)$ has a period $2l$. For a value of x within the interval, at which $f(x)$ is discontinuous, the sum of the series may cease to represent $f(x)$, but, as will be seen hereafter, has the value $\frac{1}{2}\{f(x+0)+f(x-0)\}$, the mean of the limits at the points on the right and the left. The series represents the function at $x=0$, unless the function is there discontinuous, in which case the series is $\frac{1}{2}\{f(+0)+f(-0)\}$; the series does not necessarily represent the function at the points l and $-l$, unless $f(l)=f(-l)$. Its sum at either of these points is $\frac{1}{2}\{f(l)+f(-l)\}$.

Examples of Fourier's Series.—(a) Let $f(x)$ be given from 0 to l , by $f(x)=c$, when $0 \leq x < \frac{1}{2}l$, and by $f(x)=-c$ from $\frac{1}{2}l$ to l ; it is required to find a sine series, and also a cosine series, which shall represent the function in the interval.

We have

$$\int_0^l f(x) \sin \frac{n\pi x}{l} dx = c \int_0^{\frac{1}{2}l} \sin \frac{n\pi x}{l} dx - c \int_{\frac{1}{2}l}^l \sin \frac{n\pi x}{l} dx$$

$$= \frac{cl}{n\pi} (\cos n\pi - 2 \cos \frac{1}{2}n\pi + 1).$$

This vanishes if n is odd, and if $n=4m$, but if $n=4m+2$ it is equal to $4cl/n\pi$; the series is therefore

$$\frac{4c}{\pi} \left(\frac{1}{2} \sin \frac{2\pi x}{l} + \frac{1}{3} \sin \frac{6\pi x}{l} + \frac{1}{5} \sin \frac{10\pi x}{l} + \dots \right).$$

For unrestricted values of x , this series represents the ordinates of the series of straight lines in fig. 1, except that it vanishes at the points $0, \frac{1}{2}l, \frac{3}{2}l, \dots$

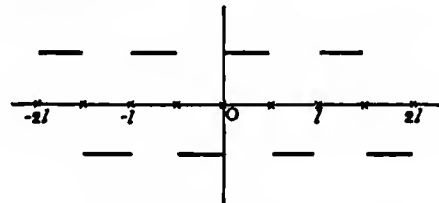

FIG. 1.

We find similarly that the same function is represented by the series

$$\frac{4c}{\pi} \left(\cos \frac{\pi x}{l} - \frac{1}{3} \cos \frac{3\pi x}{l} + \frac{1}{5} \cos \frac{5\pi x}{l} - \dots \right)$$

during the interval 0 to l ; for general values of x the series represents the ordinate of the broken line in fig. 2, except that it vanishes at the points $\frac{1}{2}l, \frac{3}{2}l, \dots$

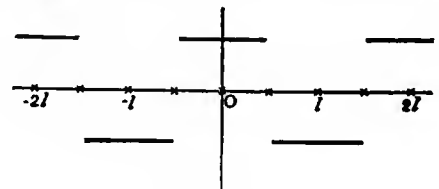

FIG. 2.

(b) Let $f(x)=x$ from 0 to $\frac{1}{2}l$, and $f(x)=l-x$, from $\frac{1}{2}l$ to l ; then

$$\int_0^l f(x) \sin \frac{n\pi x}{l} dx = \int_0^{\frac{1}{2}l} x \sin \frac{n\pi x}{l} dx + \int_{\frac{1}{2}l}^l (l-x) \sin \frac{n\pi x}{l} dx$$

$$= -\frac{l}{2n\pi} \cos \frac{n\pi}{2} + \frac{l}{n^2\pi^2} \sin \frac{n\pi}{2} + \frac{l}{n\pi} (\cos \frac{n\pi}{2} - \cos n\pi)$$

$$+ \frac{l}{n\pi} \cos n\pi - \frac{l}{2n\pi} \cos \frac{n\pi}{2} + \frac{l}{n^2\pi^2} \sin \frac{n\pi}{2} = \frac{2l}{n^2\pi^2} \sin \frac{n\pi}{2}$$

hence the sine series is

$$\frac{4l}{\pi^2} \left(\sin \frac{\pi x}{l} - \frac{1}{3^2} \sin \frac{3\pi x}{l} + \frac{1}{5^2} \sin \frac{5\pi x}{l} - \dots \right)$$

For general values of x , the series represents the ordinates of the row of broken lines in fig. 3.

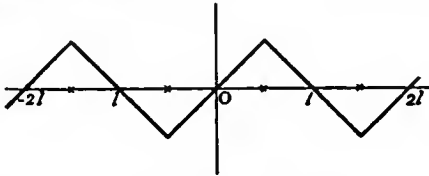

FIG. 3.

The cosine series, which represents the same function for the interval 0 to l , may be found to be

$$\frac{1}{4} - \frac{2l}{\pi^2} \left(\cos \frac{2\pi x}{l} + \frac{1}{3^2} \cos \frac{6\pi x}{l} + \frac{1}{5^2} \cos \frac{10\pi x}{l} + \dots \right)$$

This series represents for general values of x the ordinate of the set of broken lines in fig. 4.

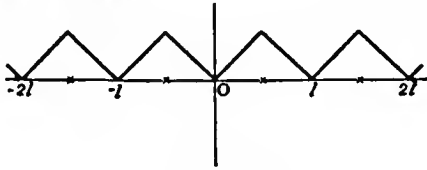

FIG. 4.

Dirichlet's Integral.—The method indicated by Fourier, but first carried out rigorously by Dirichlet, of proving that, with certain restrictions as to the nature of the function $f(x)$, that function is in general represented by the series (3), consists in finding the sum of $n+1$ terms of that series, and then investigating the limiting value of the sum, when n is increased indefinitely. It thus appears that the series is convergent, and that the value towards which its sum converges is $\frac{1}{2}\{f(x+0)+f(x-0)\}$, which is in general equal to $f(x)$. It will be convenient throughout to take $-\pi$ to π as the given interval; any interval $-l$ to l may be reduced to this by changing x into lx/π , and thus there is no loss of generality.

We find by an elementary process that

$$\frac{1}{2} + \cos(x-x') + \cos 2(x-x') + \dots + \cos n(x-x') = \frac{\sin \frac{2n+1}{2}(x-x')}{2 \sin \frac{1}{2}(x-x')}$$

Hence, with the new notation, the sum of the first $n+1$ terms of (3) is

$$\frac{1}{\pi} \int_{-\pi}^{\pi} f(x') \frac{\sin \frac{2n+1}{2}(x'-x)}{2 \sin \frac{1}{2}(x'-x)} dx'$$

If we suppose $f(x)$ to be continued beyond the interval $-\pi$ to π , in such a way that $f(x)=f(x+2\pi)$, we may replace the limits in this integral by $x+\pi$, $x-\pi$ respectively; if we then put $x'-x=2z$, and

let $f(x')=F(z)$, the expression becomes $\frac{1}{\pi} \int_{-\pi}^{\pi} F(z) \frac{\sin mz}{\sin z} dz$, where $m=2n+1$; this expression may be written in the form

$$\frac{1}{\pi} \int_0^{\pi} F(z) \frac{\sin mz}{\sin z} dz + \frac{1}{\pi} \int_0^{\pi} F(-z) \frac{\sin mz}{\sin z} dz \dots \dots (4)$$

We require therefore to find the limiting value, when m is indefinitely increased, of $\int_0^{\pi} F(z) \frac{\sin mz}{\sin z} dz$; the form of the second integral being essentially the same. This integral, or rather the slightly more general one $\int_0^h F(z) \frac{\sin mz}{\sin z} dz$, when $0 < h \leq \frac{1}{2}\pi$, is known as Dirichlet's integral. If we write $X(z)=F(z) \frac{z}{\sin z}$, the integral becomes $\int_0^h X(z) \frac{\sin mz}{z} dz$, which is the form in which the integral is frequently considered.

The Second Mean-Value Theorem.—The limiting value of Dirichlet's integral may be conveniently investigated by means of a theorem in the integral calculus known as the second mean-value theorem. Let a, b be two fixed finite numbers such that $a < b$, and suppose $f(x), \phi(x)$ are two functions which have finite and determinate values everywhere in the interval except for a finite number of points; suppose further that the functions $f(x), \phi(x)$ are integrable throughout the interval, and that as x increases from a to b the function $f(x)$ is monotone, i.e. either never diminishes or never increases; the theorem is that

$$\int_a^b f(x)\phi(x)dx = f(a+0) \int_a^{\xi} \phi(x)dx + f(b-0) \int_{\xi}^b \phi(x)dx$$

when ξ is some point between a and b , and $f(a), f(b)$ may be written for $f(a+0), f(b-0)$ unless a or b is a point of discontinuity of the function $f(x)$.

To prove this theorem, we observe that, since the product of two integrable functions is an integrable function, $\int_a^b f(x)\phi(x)dx$ exists,

and may be regarded as the limit of the sum of a series $f(x_0)\phi(x_0)(x_1-x_0) + f(x_1)\phi(x_1)(x_2-x_1) + \dots + f(x_{n-1})\phi(x_{n-1})(x_n-x_{n-1})$ where $x_0=a, x_n=b$ and x_1, x_2, \dots, x_{n-1} are $n-1$ intermediate points. We can express $\phi(x_r)(x_{r+1}-x_r)$ in the form $Y_{r+1}-Y_r$, by putting $Y_r = \sum_{k=1}^{K-r} \phi(x_{k-1})(x_k-x_{k-1}), Y_0=0$.

Writing X_r for $f(x_r)$, the series becomes $X_0(Y_1-Y_0) + X_1(Y_2-Y_1) + \dots + X_{n-1}(Y_n-Y_{n-1})$ or $Y_1(X_0-X_1) + Y_2(X_1-X_2) + \dots + Y_n(X_{n-1}-X_n) + Y_n X_n$.

Now, by supposition, all the numbers Y_1, Y_2, \dots, Y_n are finite, and all the numbers $X_{r-1}-X_r$ are of the same sign, hence by a known algebraical theorem the series is equal to $M(X_0-X_n) + Y_n X_n$ where M is a number intermediate between the greatest and the least of the numbers Y_1, Y_2, \dots, Y_n . This remains true however many partial intervals are taken, and therefore, when their number is increased indefinitely, and their breadths are diminished indefinitely according to any law, we have

$$\int_a^b f(x)\phi(x)dx = \{f(a)-f(b)\}M + f(b) \int_a^b \phi(x)dx$$

when M is intermediate between the greatest and least values which $\int_a^x \phi(x)dx$ can have, when x is in the given integral. Now

this integral is a continuous function of its upper limit x , and therefore there is a value of x in the interval, for which it takes any particular value between the greatest and least values that it has.

There is therefore a value ξ between a and b , such that $M = \int_a^{\xi} \phi(x)dx$, hence

$$\int_a^b f(x)\phi(x)dx = \{f(a)-f(b)\} \int_a^{\xi} \phi(x)dx + f(b) \int_a^b \phi(x)dx = f(a) \int_a^{\xi} \phi(x)dx + f(b) \int_{\xi}^b \phi(x)dx$$

If the interval contains any finite numbers of points of discontinuity of $f(x)$ or $\phi(x)$, the method of proof still holds good, provided these points are avoided in making the subdivisions; in particular if either of the ends be a point of discontinuity of $f(x)$, we write $f(a+0)$ or $f(b-0)$, for $f(a)$ or $f(b)$, it being assumed that these limits exist.

Functions, with Limited Variation.—The condition that $f(x)$, in the mean-value theorem, either never increases or never diminishes as x increases from a to b , places a restriction upon the applications of the theorem. We can, however, show that a function $f(x)$ which is finite and continuous between a and b , except for a finite number of ordinary discontinuities, and which only changes from increasing to diminishing or vice versa, a finite number of times, as x increases from a to b , may be expressed as the difference of two functions $f_1(x), f_2(x)$, neither of which ever diminishes as x passes from a to b , and that these functions are finite and continuous, except that one or both of them are discontinuous at the points where the given function is discontinuous. Let a, β be two consecutive points at which $f(x)$ is discontinuous, consider any point x_1 , such that $a \leq x_1 \leq \beta$, and suppose that at the points M_1, M_2, \dots, M_r between a and x_1 , $f(x)$ is a maximum, and at m_1, m_2, \dots, m_r it is a minimum; we will suppose, for example, that the ascending order of values is $a, M_1, m_1, M_2, m_2, \dots, M_r, m_r, x_1$; it will make no essential difference in the argument if m_1 comes before M_1 , or if M_r immediately precedes x_1, M_{r-1} being then the last minimum.

Let $\psi(x_1) = [f(M_1)-f(a+0)] + [f(M_2)-f(m_1)] + \dots + [f(M_r)-f(m_{r-1})] + [f(x_1)-f(m_r)]$;

now let x_1 increase until it reaches the value M_{r+1} at which $f(x)$ is again a maximum, then let

$$\psi(x_1) = [f(M_1)-f(a+0)] + [f(M_2)-f(m_1)] + \dots + [f(M_r)-f(m_{r-1})] + [f(M_{r+1})-f(m_r)]$$

and suppose as x increases beyond the value M_{r+1} , $\psi(x_1)$ remains constant until the next minimum m_{r+1} is reached, when it again becomes variable; we see that $\psi(x_1)$ is essentially positive and never diminishes as x increases.

Let $\chi(x_1) = [f(M_1)-f(m_1)] + [f(M_2)-f(m_1)] + \dots + [f(M_r)-f(m_r)]$, then let x_1 increase until it is beyond the next maximum M_{r+1} , and then let $\chi(x_1) = [f(M_1)-f(m_1)] + [f(M_2)-f(m_1)] + \dots + [f(M_r)-f(m_r)] + [f(M_{r+1})-f(x_1)]$

thus $\chi(x_1)$ never diminishes, and is alternately constant and variable. We see that $\psi(x_1)-\chi(x_1)$ is continuous as x_1 increases from a to β , and that $\psi(x_1)-\chi(x_1) = f(x_1)-f(a+0)$, and when x_1 reaches β , we have $\psi(\beta)-\chi(x_1) = f(\beta-0)-f(a+0)$. Hence it is seen that between a and $\beta, f(x) = [\psi(x)+f(a+0)]-\chi(x)$, where $\psi(x)+f(a+0), \chi(x)$ are continuous and never diminishes as x increases; the same reasoning

applies to every continuous portion of $f(x)$, for which the functions $\psi(x)$, $\chi(x)$ are formed in the same manner; we now take $f_1(x) = \psi(x) + f(a+0) + C$, $f_2(x) = \chi(x) + C$, where C is constant between consecutive discontinuities, but may have different values in the next interval between discontinuities; the C can be so chosen that neither $f_1(x)$ nor $f_2(x)$ diminishes as x increases through a value for which $f(x)$ is discontinuous. We thus see that $f(x) = f_1(x) - f_2(x)$, where $f_1(x)$, $f_2(x)$ never diminish as x increases from a to b , and are discontinuous only where $f(x)$ is so. The function $f(x)$ is a particular case of a class of functions defined and discussed by Jordan, under the name "functions with limited variation" (*fonctions à variation bornée*); in general such functions have not necessarily only a finite number of maxima and minima.

Proof of the Convergence of Fourier's Series.—It will now be assumed that a function $f(x)$ arbitrarily given between the values $-\pi$ and $+\pi$, has the following properties:—

(a) The function is everywhere numerically less than some fixed positive number, and continuous except for a finite number of values of the variable, for which it may be ordinarily discontinuous.

(b) The function only changes from increasing to diminishing or vice versa, a finite number of times within the interval; this is usually expressed by saying that the number of maxima and minima is finite.

These limitations on the nature of the function are known as Dirichlet's conditions; it follows from them that the function is integrable throughout the interval.

On these assumptions, we can investigate the limiting value of Dirichlet's integral; it will be necessary to consider only the case of a function $F(z)$ which does not diminish as z increases from 0 to $\frac{1}{2}\pi$, since it has been shown that in the general case the difference of two such functions may be taken. The following lemmas will be required:

1. Since

$$\int_0^{\frac{\pi}{2}} \frac{\sin mz}{\sin z} dz = \int_0^{\frac{\pi}{2}} \{1 + 2 \cos 2z + 2 \cos 4z + \dots + 2 \cos 2nz\} dz = \frac{\pi}{2};$$

this result holds however large the odd integer m may be.

2. If $0 < \alpha < \beta \leq \frac{\pi}{2}$,

$$\int_{\alpha}^{\beta} \frac{\sin mz}{\sin z} dz = \frac{1}{\sin \alpha} \int_{\alpha}^{\gamma} \sin mz dz + \frac{1}{\sin \beta} \int_{\gamma}^{\beta} \sin mz dz$$

where $\alpha < \gamma < \beta$, hence

$$\left| \int_{\alpha}^{\beta} \frac{\sin mz}{\sin z} dz \right| < \frac{2}{m} \left(\frac{1}{\sin \alpha} + \frac{1}{\sin \beta} \right) < \frac{4}{m \sin \alpha};$$

a precisely similar proof shows that $\left| \int_{\alpha}^{\beta} \frac{\sin mz}{z} dz \right| < \frac{4}{m\alpha}$,

hence the integrals $\int_{\alpha}^{\beta} \frac{\sin mz}{\sin z} dz$, $\int_{\alpha}^{\beta} \frac{\sin mz}{z} dz$, converge to the limit zero, as m is indefinitely increased.

3. If $\alpha > 0$, $\left| \int_{\alpha}^{\infty} \frac{\sin \theta}{\theta} d\theta \right|$ cannot exceed $\frac{1}{2}\pi$. For by the mean-value theorem $\left| \int_{\alpha}^h \frac{\sin \theta}{\theta} d\theta \right| < \frac{2}{\alpha} + \frac{2}{h}$,

hence $\left| \int_{\alpha}^{\infty} \frac{\sin \theta}{\theta} d\theta \right| \leq \frac{2}{\alpha}$;

in particular if $\alpha \geq \pi$, $\left| \int_{\alpha}^{\infty} \frac{\sin \theta}{\theta} d\theta \right| \leq \frac{2}{\pi} < \frac{\pi}{2}$.

Again $\frac{d}{d\alpha} \int_{\alpha}^{\infty} \frac{\sin \theta}{\theta} d\theta = -\frac{\sin \alpha}{\alpha}$, $\alpha > 0$,

therefore $\int_{\alpha}^{\infty} \frac{\sin \theta}{\theta} d\theta$ increases as α diminishes, when $\theta < \alpha < \pi$;

but $\lim_{\alpha \rightarrow 0} \int_{\alpha}^{\infty} \frac{\sin \theta}{\theta} d\theta = \frac{\pi}{2}$, hence $\left| \int_{\alpha}^{\infty} \frac{\sin \theta}{\theta} d\theta \right| < \frac{\pi}{2}$,

where $\alpha < \pi$, and $\frac{2}{\alpha} < \frac{\pi}{2}$ where $\alpha \geq \pi$. It follows that

$$\left| \int_{\alpha}^{\beta} \frac{\sin \theta}{\theta} d\theta \right| \leq \pi, \text{ provided } 0 \leq \alpha < \beta.$$

To find the limit of $\int_0^{\frac{\pi}{2}} F(z) \frac{\sin mz}{\sin z} dz$, we observe that it may be written in the form

$$F(0) \int_0^{\frac{\pi}{2}} \frac{\sin mz}{\sin z} dz + \int_0^{\mu} \{F(z) - F(0)\} \frac{\sin mz}{\sin z} dz + \int_{\mu}^{\frac{\pi}{2}} \{F(z) - F(0)\} \frac{\sin mz}{\sin z} dz$$

where μ is a fixed number as small as we please; hence if we use lemma (1), and apply the second mean-value theorem,

$$\int_0^{\frac{\pi}{2}} F(z) \frac{\sin mz}{\sin z} dz - \frac{\pi}{2} F(0) = \int_0^{\mu} \{F(z) - F(0)\} \frac{z}{\sin z} \frac{\sin mz}{z} dz$$

$$+ \{F(\mu+0) - F(0)\} \int_{\mu}^{\frac{\pi}{2}} \frac{\sin mz}{\sin z} dz + \{F(\frac{1}{2}\pi - 0) - F(0)\} \int_{\frac{1}{2}\pi}^{\frac{\pi}{2}} \frac{\sin mz}{\sin z} dz$$

when ξ lies between μ and $\frac{1}{2}\pi$. When m is indefinitely increased, the two last integrals have the limit zero in virtue of lemma (2). To evaluate the first integral on the right-hand side, let $G(z) = \{F(z) - F(0)\} \frac{z}{\sin z}$, and observe that $G(z)$ increases as z increases from 0 to μ , hence if we apply the mean-value theorem

$$\left| \int_0^{\mu} G(z) \frac{\sin mz}{z} dz \right| = \left| G(\mu) \int_{\xi}^{\mu} \frac{\sin mz}{z} dz \right| = \left| G(\mu) \int_{m\xi}^{m\mu} \frac{\sin \theta}{\theta} d\theta \right| < \pi G(\mu),$$

where $0 < \xi < \mu$, since $G(z)$ has the limit zero when $z = 0$. If ϵ be an arbitrarily chosen positive number, a fixed value of μ may be so

chosen that $\pi G(\mu) < \frac{1}{2}\epsilon$, and thus that $\left| \int_0^{\mu} G(z) \frac{\sin mz}{z} dz \right| < \frac{1}{2}\epsilon$. When μ has been so fixed, m may now be so chosen that

$$\left| \int_0^{\frac{1}{2}\pi} F(z) \frac{\sin mz}{\sin z} dz - \frac{\pi}{2} F(0) \right| < \epsilon.$$

It has now been shown that when m is indefinitely increased $\int_0^{\frac{\pi}{2}} F(z) \frac{\sin mz}{\sin z} dz - \frac{\pi}{2} F(0)$ has the limit zero.

Returning to the form (4), we now see that the limiting value of

$$\frac{1}{\pi} \int_0^{\frac{\pi}{2}} F(z) \frac{\sin mz}{\sin z} dz + \frac{1}{\pi} \int_0^{\frac{\pi}{2}} F(-z) \frac{\sin mz}{\sin z} dz$$

is $\frac{1}{2}\{F(+0) + F(-0)\}$;

hence the sum of $n+1$ terms of the series

$$\frac{1}{2l} \int_{-l}^l f(x) dx + \frac{1}{2} \sum_{i=1}^l f(x^i) \cos \frac{n\pi(x-x^i)}{l}$$

converges to the value $\frac{1}{2}\{f(x+0) + f(x-0)\}$, or to $f(x)$ at a point where $f(x)$ is continuous, provided $f(x)$ satisfies Dirichlet's conditions for the interval from $-l$ to l .

Proof that Fourier's Series is in General Uniformly Convergent.—

To prove that Fourier's Series converges uniformly to its sum for all values of x , provided that the immediate neighbourhoods of the points of discontinuity of $f(x)$ are excluded, we have

$$\left| \int_{\frac{1}{2}\pi}^{\pi} F(z) \frac{\sin mz}{\sin z} dz - \frac{\pi}{2} F(0) \right| < \pi G(\mu) + \frac{4}{m \sin \mu} \{F(\mu+0) - F(0)\} + \frac{4}{m \sin \frac{1}{2}\pi} \{F(\frac{1}{2}\pi - 0) - F(0)\} < \frac{\pi \mu}{\sin \mu} \{f(x+2\mu) - f(x)\} + \frac{4}{m \sin \mu} \{f(x+2\mu) - f(x)\} + \frac{4}{m \sin \frac{1}{2}\pi} \{f(x+\pi) - f(x)\}.$$

Using this inequality and the corresponding one for $F(-z)$, we have

$$|S_{2n+1}(x) - f(x)| < \mu \operatorname{cosec} \mu \{ |f(x+2\mu) - f(x)| + |f(x-2\mu) - f(x)| \} + A m \operatorname{cosec} \mu,$$

where A is some fixed number independent of m . In any interval (a, b) in which $f(x)$ is continuous, a value μ_1 of μ can be chosen such that, for every value of x in (a, b) , $|f(x+2\mu) - f(x)|$, $|f(x-2\mu) - f(x)|$ are less than an arbitrarily prescribed positive number ϵ , provided $\mu = \mu_1$. Also a value μ_2 of μ can be so chosen that $\epsilon \mu_2 \operatorname{cosec} \mu_2 < \frac{1}{2}\eta$, where η is an arbitrarily assigned positive number. Take for μ the lesser of the numbers μ_1, μ_2 , then $|S_{2n+1} - f(x)| < \eta + A m \operatorname{cosec} \mu$ for every value of x in (a, b) . It follows that, since η and m are independent of x , $|S_{2n+1} - f(x)| < 2\epsilon$, provided n is greater than some fixed value n_1 dependent only on ϵ . Therefore S_{2n+1} converges to $f(x)$ uniformly in the interval (a, b) .

Case of a Function with Infinities.—The limitation that $f(x)$ must be numerically less than a fixed positive number throughout the interval may, under a certain restriction, be removed. Suppose $F(z)$ is indefinitely great in the neighbourhood of the point $z=c$, and is

such that the limits of the two integrals $\int_c^{c+\epsilon} F(z) dz$ are both zero, as ϵ is indefinitely diminished, then

$$\int_0^{\frac{\pi}{2}} F(z) \frac{\sin mz}{\sin z} dz$$

denotes the limit when $\epsilon = 0$, $\epsilon' = 0$ of

$$\int_{c-\epsilon}^{c-\epsilon'} F(z) \frac{\sin mz}{\sin z} dz + \int_{c+\epsilon'}^{c+\epsilon} F(z) \frac{\sin mz}{\sin z} dz,$$

both these limits existing; the first of these integrals has $\frac{1}{2}\pi F(+0)$ for its limiting value when m is indefinitely increased, and the second has zero for its limit. The theorem therefore holds if $F(z)$ has an infinity up to which it is absolutely integrable; this will, for example, be the case if $F(z)$ near the point C is of the form $\chi(z)(z-c)^{-\mu} + \psi(z)$, where $\chi(c), \psi(c)$ are finite, and $0 < \mu < 1$. It is thus seen that $f(x)$ may have a finite number of infinities within the given interval, provided the function is integrable through any one of these points; the function is in that case still representable by Fourier's Series.

The Ultimate Values of the Coefficients in Fourier's Series.—If $f(x)$ is everywhere finite within the given interval $-\pi$ to $+\pi$, it can be shown that a_n, b_n , the coefficients of $\cos nx, \sin nx$ in the series which represent the function, are such that na_n, nb_n , however

great n is, are each less than a fixed finite quantity. For writing $f(x) = f_1(x) - f_2(x)$, we have

$$\int_{-\pi}^{\pi} f_1(x) \cos nx dx = f_1(-\pi+0) \int_{-\pi}^{\xi} \cos nx dx + f_1(\pi-0) \int_{\xi}^{\pi} \cos nx dx$$

hence

$$\int_{-\pi}^{\pi} f_1(x) \cos nx dx = f_1(-\pi+0) \frac{\sin n\xi}{n} + f_1(\pi-0) \frac{\sin n\xi}{n}$$

with a similar expression, with $f_2(x)$ for $f_1(x)$, ξ being between π and $-\pi$; the result then follows at once, and is obtained similarly for the other coefficient.

If $f(x)$ is infinite at $x=c$, and is of the form $\frac{\phi(x)}{(x-c)^K}$ near the point c , where $0 < K < 1$, the integral

$$\int_{-\pi}^{\pi} f(x) \cos nx dx$$

contains portions of the form $\int_c^{c+\epsilon} \frac{\phi(x)}{(x-c)^K} \cos nx dx$

$\int_{c-\epsilon}^c \frac{\phi(x)}{(x-c)^K} \cos nx dx$; consider the first of these, and put $x=c+u$, it thus becomes $\int_0^{\epsilon} \frac{\phi(c+u)}{u^K} \cos n(c+u) du$, which is of the form

$$\phi(c+\theta\epsilon) \int_0^{\epsilon} \frac{\cos n(c+u)}{u^K} du; \text{ now let } nu=v, \text{ the integral becomes}$$

$$\phi(c+\theta\epsilon) \left\{ \frac{\cos nc}{n^{1-K}} \int_0^{n\epsilon} \frac{\cos v}{v^K} dv - \frac{\sin nc}{n^{1-K}} \int_0^{n\epsilon} \frac{\sin v}{v^K} dv \right\};$$

hence $n^{1-K} \int_{-\pi}^{\pi} f(x) \cos nx dx$ becomes, as n is definitely increased,

$$\phi(c) \left\{ \cos nc \int_0^{\infty} \frac{\cos v}{v^K} dv - \sin nc \int_0^{\infty} \frac{\sin v}{v^K} dv \right\}$$

which is finite, both the integrals being convergent and of known value. The other integral has a similar property, and we infer that $n^{1-K} a_n, n^{1-K} b_n$ are less than fixed finite numbers.

The Differentiation of Fourier's Series.—If we assume that the differential coefficient of a function $f(x)$ represented by a Fourier's Series exists, that function $f'(x)$ is not necessarily representable by the series obtained by differentiating the terms of the Fourier's Series, such derived series being in fact not necessarily convergent. Stokes has obtained general formulæ for finding the series which represent $f'(x), f''(x)$ —the successive differential coefficients of a limited function $f(x)$. As an example of such formulæ, consider the sine series (1); $f(x)$ is represented by

$$\frac{2}{\pi} \sum \sin \frac{n\pi x}{l} \int_0^l f(x) \sin \frac{n\pi x}{l} dx;$$

on integration by parts we have $\int_0^l f(x) \sin \frac{n\pi x}{l} dx$

$$= \frac{l}{n\pi} \left[f(+0) - f(l-0) + \sum \cos \frac{n\pi a}{l} \{f(a+0) - f(a-0)\} \right] + \frac{l}{n\pi} \int_0^l f'(x) \cos \frac{n\pi x}{l} dx$$

where a represent the points where $f(x)$ is discontinuous. Hence if $f(x)$ is represented by the series $\sum a_n \sin \frac{n\pi x}{l}$, and $f'(x)$ by the series $\sum b_n \cos \frac{n\pi x}{l}$, we have the relation

$$b_n = \frac{n\pi}{l} a_n - \frac{2}{l} \left[f(+0) - f(l-0) + \sum \cos \frac{n\pi a}{l} \{f(a+0) - f(a-0)\} \right]$$

hence only when the function is everywhere continuous, and $f(+0), f(l-0)$ are both zero, is the series which represents $f'(x)$ obtained at once by differentiating that which represents $f(x)$. The form of the coefficient a_n discloses the discontinuities of the function and of its differential coefficients, for on continuing the integration by parts we find

$$a_n = \frac{2}{n\pi} \left[f(+0) - f(l-0) + \sum \cos \frac{n\pi a}{l} \{f(a+0) - f(a-0)\} \right] + \frac{2l}{n^2\pi^2} \left[f'(+0) - f'(l-0) + \sum \sin \frac{n\pi \beta}{l} \{f'(\beta+0) - f'(\beta-0)\} \right] + \&c.$$

where β are the points at which $f'(x)$ is discontinuous.

HISTORY AND LITERATURE OF THE THEORY

The history of the theory of the representation of functions by series of sines and cosines is of great interest in connexion with the progressive development of the notion of an arbitrary function of a real variable, and of the peculiarities which such a function may possess; the modern views on the foundations of the infinitesimal calculus have been to a very considerable extent formed in this connexion (see FUNCTION). The representation of functions by these series was first considered in the 18th century, in connexion with the problem of a vibrating cord, and led to a controversy as to the possibility of such expansions. In a memoir published in 1747 (*Memoirs of the Academy of Berlin*, vol. iii.) D'Alembert showed that the ordinate y at any time t of a vibrating cord satisfies a differential equation of the form $\frac{\delta^2 y}{\delta t^2} = a \frac{\delta^2 y}{\delta x^2}$, where x is measured along the undisturbed length of the cord, and that with the ends of the cord of length l fixed, the appropriate solution is $y = f(at+x) - f(at-x)$, where

f is a function such that $f(x) = f(x+2l)$; in another memoir in the same volume he seeks for functions which satisfy this condition. In the year 1748 (*Berlin Memoirs*, vol. iv.) Euler, in discussing the problem, gave $f(x) = a \sin \frac{\pi x}{l} + \beta \sin \frac{2\pi x}{l} + \dots$ as a particular solution, and maintained that every curve, whether regular or irregular, must be representable in this form. This was objected to by D'Alembert (1750) and also by Lagrange on the ground that irregular curves are inadmissible. D. Bernoulli (*Berlin Memoirs*, vol. ix., 1753) based a similar result to that of Euler on physical intuition; his method was criticized by Euler (1753). The question was then considered from a new point of view by Lagrange, in a memoir on the nature and propagation of sound (*Miscellanea Taurenslia*, 1759; *Œuvres*, vol. i.), who, while criticizing Euler's method, considers a finite number of vibrating particles, and then makes the number of them infinite; he did not, however, quite fully carry out the determination of the coefficients in Bernoulli's Series. These mathematicians were hampered by the narrow conception of a function, in which it is regarded as necessarily continuous; a discontinuous function was considered only as a succession of several different functions. Thus the possibility of the expansion of a broken function was not generally admitted. The first cases in which rational functions are expressed in sines and cosines were given by Euler (*Subsidium calculi sinuum*, *Novi Comm. Petrop.*, vol. v., 1754-1755), who obtained the formulæ

$$\frac{1}{2} \phi = \sin \phi - \frac{1}{2} \sin 2\phi + \frac{1}{3} \sin 3\phi \dots$$

$$\frac{\pi^2}{12} - \frac{\phi^2}{4} = \cos \phi - \frac{1}{2} \cos 2\phi + \frac{1}{3} \cos 3\phi \dots$$

In a memoir presented to the Academy of St Petersburg in 1777, but not published until 1798, Euler gave the method afterwards used by Fourier, of determining the coefficients in the expansions; he remarked that if Φ is expandible in the form

$$A + B \cos \phi + C \cos 2\phi + \dots, \text{ then } A = \frac{1}{\pi} \int_0^{\pi} \Phi d\phi, B = \frac{2}{\pi} \int_0^{\pi} \Phi \cos \phi d\phi, \&c.$$

The second period in the development of the theory commenced in 1807, when Fourier communicated his first memoir on the Theory of Heat to the French Academy. His exposition of the present theory is contained in a memoir sent to the Academy in 1811, of which his great treatise *Théorie analytique de la chaleur*, published in 1822, is, in the main, a reproduction. Fourier set himself to consider the representation of a function given graphically, and was the first fully to grasp the idea that a single function may consist of detached portions given arbitrarily by a graph. He had an accurate conception of the convergence of a series, and although he did not give a formally complete proof that a function with discontinuities is representable by the series, he indicated in particular cases the method of procedure afterwards carried out by Dirichlet. As an exposition of principles, Fourier's work is still worthy of careful perusal by all students of the subject. Poisson's treatment of the subject, which has been adopted in English works (see the *Journal de l'école polytechnique*, vol. xi., 1820, and vol. xii., 1823, and also his treatise, *Théorie de la chaleur*, 1835),

depends upon the equality $\int_{-\pi}^{\pi} f(a) \frac{1-h^2}{1-2h \cos(x-a) + h^2} da$

$$= \frac{1}{2\pi} \int_{-\pi}^{\pi} f(a) da + \frac{1}{\pi} \sum h^n \int_{-\pi}^{\pi} f(a) \cos n(x-a) da$$

where $0 < h < 1$; the limit of the integral on the left-hand side is evaluated when $h=1$, and found to be $\frac{1}{2} \{f(x+0) + f(x-0)\}$, the series on the right-hand side becoming Fourier's Series. The equality of the two limits is then inferred. If the series is assumed to be convergent when $h=1$, by a theorem of Abel's its sum is continuous with the sum for values of h less than unity, but a proof of the convergency for $h=1$ is requisite for the validity of Poisson's proof; as Poisson gave no such proof of convergency, his proof of the general theorem cannot be accepted. The deficiency cannot be removed except by a process of the same nature as that afterwards applied by Dirichlet. The definite integral has been carefully studied by Schwarz (see two memoirs in his collected

works on the integration of the equation $\frac{\delta^2 u}{\delta x^2} + \frac{\delta^2 u}{\delta y^2} = 0$), who showed that the limiting value of the integral depends upon the manner in which the limit is approached. Investigations of Fourier's Series were also given by Cauchy (see his "Mémoire sur les développements des fonctions en séries périodiques," *Mém. de l'Inst.*, vol. vi., also *Œuvres complètes*, vol. vii.); his method, which depends upon a use of complex variables, was accepted, with some modification, as valid by Riemann, but one at least of his proofs is no longer regarded as satisfactory. The first completely satisfactory investigation is due to Dirichlet; his first memoir appeared in *Crelle's Journal* for 1829, and the second, which is a model of clearness, in Dove's *Repertorium der Physik*. Dirichlet laid down certain definite sufficient conditions in regard to the nature of a function which is expandible, and found under these conditions the limiting value of the sum of n terms of the series. Dirichlet's determination of the sum of the series at a point of discontinuity has been criticized by Schläfli (see *Crelle's Journal*, vol. lxxii.) and by Du Bois-Reymond (*Mathem. Annalen*, vol. vii.), who maintained that the sum is really

indeterminate. Their objection appears, however, to rest upon a misapprehension as to the meaning of the sum of the series; if x_1 be the point of discontinuity, it is possible to make x approach x_1 , and n become indefinitely great, so that the sum of the series takes any assigned value in a certain interval, whereas we ought to make $x=x_1$ first and afterwards $n=\infty$, and no other way of going to the double limit is really admissible. Other papers by Diricksen (*Crelle*, vol. iv.) and Bessel (*Astronomische Nachrichten*, vol. xvi.), on similar lines to those by Dirichlet, are of inferior importance. Many of the investigations subsequent to Dirichlet's have the object of freeing a function from some of the restrictions which were imposed upon it in Dirichlet's proof, but no complete set of necessary and sufficient conditions as to the nature of the function has been obtained. Lipschitz ("De explicatione per series trigonometricas," *Crelle's Journal*, vol. lxxiii., 1864) showed that, under a certain condition, a function which has an infinite number of maxima and minima in the neighbourhood of a point is still expandible; his condition is that at the point of discontinuity β , $|f(\beta+\delta)-f(\beta)| < B\delta^a$ as δ converges to zero, B being a constant, and a a positive exponent. A somewhat wider condition is

$$f(\beta+\delta)-f(\beta) \log \delta = o, \\ \delta = 0$$

for which Lipschitz's results would hold. This last condition is adopted by Dini in his treatise (*Sopra la serie di Fourier*, &c., Pisa, 1880).

The modern period in the theory was inaugurated by the publication by Riemann in 1867 of his very important memoir, written in 1854, *Über die Darstellbarkeit einer Function durch eine trigonometrische Reihe*. The first part of his memoir contains a historical account of the work of previous investigators; in the second part there is a discussion of the foundations of the Integral Calculus, and the third part is mainly devoted to a discussion of what can be inferred as to the nature of a function respecting the changes in its value for a continuous change in the variable, if the function is capable of representation by a trigonometrical series. Dirichlet and probably Riemann thought that all continuous functions were everywhere representable by the series; this view was refuted by Du Bois-Reymond (*Abh. der Bayer. Akad.* vol. xii. 2). It was shown by Riemann that the convergence or non-convergence of the series at a particular point x depends only upon the nature of the function in an arbitrarily small neighbourhood of the point x . The first to call attention to the importance of the theory of uniform convergence of series in connexion with Fourier's Series was Stokes, in his memoir "On the Critical Values of the Sums of Periodic Series" (*Camb. Phil. Trans.*, 1847; *Collected Papers*, vol. i.). As the method of determining the coefficients in a trigonometrical series is invalid unless the series converges in general uniformly, the question arose whether series with coefficients other than those of Fourier exist which represent arbitrary functions. Heine showed (*Crelle's Journal*, vol. lxxi., 1870, and in his treatise *Kugelfunctionen*, vol. i.) that Fourier's Series is in general uniformly convergent, and that if there is a uniformly convergent series which represents a function, it is the only one of the kind. G. Cantor then showed (*Crelle's Journal*, vols. lxxii. lxxiii.) that even if uniform convergence be not demanded, there can be but one convergent expansion for a function, and that it is that of Fourier. In the *Math. Ann.* vol. v., Cantor extended his investigation to functions having an infinite number of discontinuities. Important contributions to the theory of the series have been published by Du Bois-Reymond (*Abh. der Bayer. Akademie*, vol. xii., 1875, two memoirs, also in *Crelle's Journal*, vols. lxxiv. lxxvi. lxxix.), by Kronecker (*Berliner Berichte*, 1885), by O. Hölder (*Berliner Berichte*, 1885), by Jordan (*Comptes rendus*, 1881, vol. xcii.), by Ascoli (*Math. Annal.*, 1873, and *Annali di matematica*, vol. vi.), and by Genocchi (*Atti della R. Acc. di Torino*, vol. x., 1875). Hamilton's memoir on "Fluctuating Functions" (*Trans. R.I.A.*, vol. xix., 1842) may also be studied with profit in this connexion. A memoir by Brodén (*Math. Annalen*, vol. lii.) contains a good investigation of some of the most recent results on the subject. The scope of Fourier's Series has been extended by Lebesgue, who introduced a conception of integration wider than that due to Riemann. Lebesgue's work on Fourier's Series will be found in his treatise, *Leçons sur les séries trigonométriques* (1906); also in a memoir, "Sur les séries trigonométriques," *Annales sc. de l'école normale supérieure*, series ii. vol. xx. (1903), and in a paper "Sur la convergence des séries de Fourier," *Math. Annalen*, vol. lxxiv. (1905).

AUTHORITIES.—The foregoing historical account has been mainly drawn from A. Sachse's work, "Versuch einer Geschichte der Darstellung willkürlicher Functionen einer Variablen durch trigonometrische Reihen," published in *Schlömilch's Zeitschrift für Mathematik*, Supp., vol. xxv. 1880, and from a paper by G. A. Gibson "On the History of the Fourier Series" (*Proc. Ed. Math. Soc.* vol. xi.). Reiff's *Geschichte der unendlichen Reihen* may also be consulted, and also the first part of Riemann's memoir referred to above. Besides Dini's treatise already referred to, there is a lucid treatment of the subject from an elementary point of view in C. Neumann's treatise, *Über die nach Kreis-, Kugel- und Cylinder-Functionen fortschreitenden Entwicklungen*. Jordan's discussion of the subject in his *Cours d'analyse* is worthy of attention; an account of functions with limited variation is given in vol. i.; see also a paper by Study

in the *Math. Annalen*, vol. xlvii. On the second mean-value theorem papers by Bonnet (*Brux. Mémoires*, vol. xxiii., 1849, *Lionville's Journal*, vol. xiv., 1849), by Du Bois-Reymond (*Crelle's Journal*, vol. lxxix., 1875), by Hankel (*Zeitschrift für Math. und Physik*, vol. xiv., 1869), by Meyer (*Math. Ann.*, vol. vi., 1872) and by Hölder (*Göttinger Anzeigen*, 1894) may be consulted; the most general form of the theorem has been given by Hobson (*Proc. London Math. Soc.*, Series II. vol. vii., 1909). On the theory of uniform convergence of series, a memoir by W. F. Osgood (*Amer. Journal of Math.* xix.) may be with advantage consulted. On the theory of series in general, in relation to the functions which they can represent, a memoir by Baire (*Annali di matematica*, Series III. vol. iii.) is of great importance. Bromwich's *Theory of Infinite Series* (1908) contains much information on the general theory of series. Bôcher's "Introduction to the Theory of Fourier's Series," *Annals of Math.*, Series II. vol. vii., 1906, will be found useful. See also Carslaw's *Introduction to the Theory of Fourier's Series and Integrals*, and the *Mathematical Theory of the Conduction of Heat* (1906). A full account of the theory will be found in Hobson's treatise *On the Theory of Functions of a Real Variable and on the Theory of Fourier's Series* (1907). (E. W. H.)

FOURMIES, a town of northern France, in the department of Nord, on an affluent of the Sambre, 39 m. S.E. of Valenciennes by rail. Pop. (1906) 13,308. It is one of the chief centres in France for wool combing and spinning, and produces a great variety of cloths. The glass-works of Fourmies date from 1599, and were the first established in the north of France. Iron is worked in the vicinity, and there are important forges and foundries. Enamel-ware is also manufactured. In 1891 labour troubles brought about military intervention and consequent bloodshed. A board of trade arbitration and a school of commerce and industry are among the public institutions.

FOURMONT, ÉTIENNE (1683-1745), French orientalist, was born at Herbelai, near Saint Denis, on the 23rd of June 1683. He studied at the Collège Mazarin, Paris, and afterwards in the Collège Montaigu, where his attention was attracted to Oriental languages. Shortly after leaving the college he published a *Traduction du commentaire du Rabbin Abraham Aben Esra sur l'ecclésiaste*. In 1711 Louis XIV. appointed Fourmont to assist a young Chinese, Hoan-ji, in compiling a Chinese grammar. Hoan-ji died in 1716, and it was not until 1737 that Fourmont published *Meditationes Sinicae* and in 1742 *Grammatica Sinica*. He also wrote *Réflexions critiques sur les histoires des anciens peuples* (1735), and several dissertations printed in the *Mémoires* of the Academy of Inscriptions. He became professor of Arabic in the Collège de France in 1715. In 1713 he was elected a member of the Academy of Inscriptions, in 1738 a member of the Royal Society of London, and in 1742 a member of that of Berlin. He died at Paris on the 19th of December 1745.

His brother, Michel Fourmont (1690-1746), was also a member of the Academy of Inscriptions, and professor of the Syriac language in the Royal College, and was sent by the government to copy inscriptions in Greece.

An account of Étienne Fourmont's life and a catalogue of his works will be found in the second edition (1747) of his *Réflexions critiques*.

FOURNET, JOSEPH JEAN BAPTISTE XAVIER (1801-1869), French geologist and metallurgist, was born at Strassburg on the 15th of May 1801. He was educated at the École des Mines at Paris, and after considerable experience as a mining engineer he was in 1834 appointed professor of geology at Lyons. He was a man of wide knowledge and extensive research, and wrote memoirs on chemical and mineralogical subjects, on eruptive rocks, on the structure of the Jura, the metamorphism of the Western Alps, on the formation of oolitic limestones, on kaolinization and on metalliferous veins. On metallurgical subjects also he was an acknowledged authority; and he published observations on the order of sulphurability of metals (*loi de Fournet*). He died at Lyons on the 8th of January 1869. His chief publications were: *Études sur les dépôts métallifères* (Paris, 1834); *Histoire de la dolomie* (Lyons, 1847); *De l'extension des terrains houillers* (1855); *Géologie lyonnaise* (Lyons, 1861).

FOURNIER, PIERRE SIMON (1712-1768), French engraver and typefounder, was born at Paris on the 15th of September 1712. He was the son of a printer, and was brought up to his father's business. After studying drawing under the painter

Colson, he practised for some time the art of wood-engraving, and ultimately turned his attention to the engraving and casting of types. He designed many new characters, and his foundry became celebrated not only in France, but in foreign countries. Not content with his practical achievements, he sought to stimulate public interest in his art by the production of various works on the subject. In 1737 he published his *Table des proportions qu'il faut observer entre les caractères*, which was followed by several other technical treatises. In 1758 he assailed the title of Gutenberg to the honour awarded him as inventor of printing, claiming it for Schöffer, in his *Dissertation sur l'origine et les progrès de l'art de graver en bois*. This gave rise to a controversy in which Schöpflin and Baer were his opponents. Fournier's contributions to this debate were collected and reprinted under the title of *Traité historique et critique sur l'origine de l'imprimerie*. His principal work, however, was the *Manuel typographique*, which appeared in 2 vols. 8vo in 1764, the first volume treating of engraving and type-founding, the second of printing, with examples of different alphabets. It was the author's design to complete the work in four volumes, but he did not live to execute it. He died at Paris on the 8th of October 1768.

FOURNIER L'HÉRITIER, CLAUDE (1745–1825), French revolutionist, called "l'Américain," was born at Auzon (Haute-Loire) on the 21st of December 1745, the son of a poor weaver. He went to America to seek his fortune, and started at San Domingo an establishment for making *tafia* (an inferior quality of rum), but lost his money in a fire. Returning to France he threw himself into the Revolution with enthusiasm, and specially distinguished himself by the active part he took in the organization of the popular armed force by means of which the most famous of the revolutionary *coups* were effected. His influence was principally manifested in the insurrections of the 5th and 6th of October 1789, the 17th of July 1791, and the 20th of June and the 10th of August 1792. He was on bad terms with the majority of the politicians, and particularly with Marat, and spent a great part of his time in prison, all the governments regarding him as an agitator and accusing him of inciting to insurrection. Arrested for the first time for trying to force an entrance into the club of the Cordeliers, from which he had been expelled, he was released, but was in prison from the 12th of December 1793 to the 21st of September 1794, and again from the 9th of March 1795 to the 26th of October 1795. After the attempt on the First Consul in the rue Sainte-Nicaise he was deported to Guiana, but was allowed to return to France in 1809. In 1811, while under surveillance at Auxerre, he was accused of having provoked an *émeute* against taxes known as the *droits réunis* (afterwards called *contributions indirectes*), and was imprisoned in the Château d'If, where he remained till 1814. On the second restoration of the Bourbons Fournier was confined for about nine months in the prison of La Force. After 1816 he was left unmolested, turned royalist, and passed his last years in importuning the Restoration government for compensation for his lost property in San Domingo. He died in obscurity.

For further details see preface to F. A. Aulard's edition of Fournier's *Mémoires secrets* (Paris, 1890), published by the Société de l'histoire de la Révolution.

FOURTOU, MARIE FRANÇOIS OSCAR BARDY DE (1836–1897), French politician, was born at Ribérac (Dordogne) on the 3rd of January 1836, and represented his native department in the National Assembly after the Franco-German War. There he proved a useful adherent to Thiers, who made him minister of public works in December 1872. He was minister of religion in the cabinet of May 18–24, 1873, being the only member of the Right included by Thiers in that short-lived ministry. As minister of education, religion and the fine arts in the reconstructed cabinet of the duc de Broglie he had used his administrative powers to further clerical ends, and as minister of the interior in Broglie's cabinet in 1877 he resumed the administrative methods of the Second Empire. With a well-known Bonapartist, Baron R. C. F. Reille, as his secretary, he replaced

republican functionaries by Bonapartist partisans, reserving a few places for the Legitimists. In the general elections of that year he used the whole weight of officialdom to secure a majority for the Right, to support a clerical and reactionary programme. He accompanied Marshal MacMahon in his tour through southern France, and the presidential manifesto of September, stating that the president would rely solely on the Senate should the elections prove unfavourable, was generally attributed to Fourtou. In spite of these efforts the cabinet fell, and a commission was appointed to inquire into their unconstitutional abuse of power. Fourtou was unseated in consequence of the revelations made in the report of the commission. In the Chamber of Deputies Gambetta gave the lie direct to Fourtou's allegation that the republican party opposed every republican principle that was not antiquated. A duel was fought in consequence, but neither party was injured. He was re-elected to the chamber in 1879 and entered the Senate the next year. Failing to secure re-election to the Senate in 1885 he again entered the popular chamber as Legitimist candidate in 1889, but he took no further active part in politics. He died in Paris in 1897.

His works include *Histoire de Louis XVI* (1840); *Histoire de Saint Pie V* (1845); *Mme Swetchine, sa vie et ses œuvres* (2 vols., 1859); *La Question italienne* (1860); *De la contre-révolution* (1876); and *Mémoires d'un royaliste* (2 vols., 1888).

FOUSSA, or FOSSA, the native name of *Cryptoprocta ferox*, a somewhat cat-like or civet-like mammal peculiar to Madagascar, where it is the largest carnivorous animal. It is about twice the size of a cat (5 ft. from nose to end of tail), with short close fur of nearly uniform pale brown. Little is known of its habits, except that it is nocturnal, frequently attacks and carries off goats, and especially kids, and shows great ferocity when wounded, on which account it is much dreaded by the natives. An example lived in the London zoological gardens for nearly fourteen years. See CARNIVORA.

FOWEY (usually pronounced *Foy*), a seaport and market-town in the Bodmin parliamentary division of Cornwall, England, on the Great Western railway, 25 m. by sea W. of Plymouth. Pop. (1901) 2258. It lies on the west shore of the picturesque estuary of the river Fowey, close to the water's edge, and sheltered by a screen of hills. Its church of St Nicholas is said to have been built in the 14th century, on the site of a still older edifice dedicated to St Finbar of Cork. It has a fine tower and late Norman doorway. Within are a priest's chamber over the porch, a handsome oak ceiling, a 15th-century pulpit, and some curious monuments and brasses. Place House, adjacent to the church, is a highly ornate Tudor building. A few ancient houses remain in the town. Deep-sea fishing is carried on; but the staple trade consists in the export of china clay and minerals, coal being imported. Fowey harbour, which is easy of access in clear weather, will admit large vessels at any state of the tide. St Catherine's Fort, dating from the days of Henry VIII. and now ruined, stands at the harbour's mouth, and once formed the main defence of the town. Opposite the town, and connected with it by Bodeneck Ferry, is the village of Polruan. Its main features are St Saviour's Chapel, with an ancient rood-stone, and the remains of Hall House, which was garrisoned during the civil wars of the 17th century.

Fowey (Fawy, Vawy, Fowyk) held a leading position amongst Cornish ports from the reign of Edward I. to the days of the Tudors. The numerous references to the privateering exploits of its ships in the Patent and Close Rolls and the extraordinary number of them at the siege of Calais in 1346 alike testify to its importance. During this period the king's mandates were addressed to the bailiffs or to the mayor and bailiffs, and no charter of incorporation appears to have been granted until the reign of James II. Under the second charter of 1690 the common council consisted of a mayor and eight aldermen and these with a recorder elected the free burgesses. A member for Fowey and Looe was summoned to a council at Westminster in 1340, but from that date until 1571, when it was entrusted with the privilege of returning two members, it had no parliamentary representation. By the Reform Act of 1832 it lost both its

members. It had ceased to exercise its municipal functions a few years previously. In 1316 the prior of Tywardreath, as lord of the manor, obtained the right to hold a Monday market and two fairs on the feasts of St Finbar and St Lucy, but by the charter of 1690 provision was made for a Saturday market and three fairs, on the 1st of May, 10th of September and Shrove Tuesday, and only these three continue to be held.

FOWL (Dan. *Fugl*, Ger. *Vogel*), a term originally used in the sense that bird¹ now is, but, except in composition,—as sea-fowl, wild-fowl and the like,—practically almost confined² at present to designate the otherwise nameless species which struts on our dunghills, gathers round our barn-doors, or stocks our poultry yards—the type of the genus *Gallus* of ornithologists, of which four well-marked species are known. The first of these is the red jungle-fowl of the greater part of India, *G. ferrugineus*,—called by many writers *G. bankiva*,—which is undoubtedly the parent stock of all the domestic races (cf. Darwin, *Animals and Plants under Domestication*, i. pp. 233-246). It inhabits northern India from Sind to Burma and Cochin China, as well as the Malay Peninsula and many of the islands as far as Timor, besides the Philippines. It occurs on the Himalayas up to the height of 4000 ft., and its southern limits in the west of India proper are, according to Jerdon, found on the Raj-peepla hills to the south of the Nerbudda, and in the east near the left bank of the Godavery, or perhaps even farther, as he had heard of its being killed at Cummum. This species resembles in plumage what is commonly known among poultry-fanciers as the "Black-breasted game" breed, and this is said to be especially the case with examples from the Malay countries, between which and examples from India some differences are observable—the latter having the plumage less red, the ear-lappets almost invariably white, and slate-coloured legs, while in the former the ear-lappets are crimson, like the comb and wattles, and the legs yellowish. If the Malayan birds be considered distinct, it is to them that the name *G. bankiva* properly applies. This species is said to be found in lofty forests and in dense thickets, as well as in ordinary bamboo-jungles, and when cultivated land is near its haunts, it may be seen in the fields after the crops are cut in straggling parties of from 10 to 20. The crow to which the cock gives utterance morning and evening is just like that of a bantam, never prolonged as in most domestic birds. The hen breeds from January to July, according to the locality; and lays from 8 to 12 creamy-white eggs, occasionally scraping together a few leaves or a little dry grass by way of a nest. The so-called *G. giganteus*, formerly taken by some ornithologists for a distinct species, is now regarded as a tame breed of *G. ferrugineus* or *bankiva*. The second good species is the grey jungle-fowl, *G. sonnerati*, whose range begins a little to the northward of the limits of the preceding, and it occupies the southern part of the Indian peninsula, without being found elsewhere. The cock has the end of the shaft of the neck-hackles dilated, forming a horny plate, like a drop of yellow sealing-wax. His call is very peculiar, being a broken and imperfect kind of crow, quite unlike that of *G. ferrugineus* and more like a cackle. The two species where their respective ranges overlap, occasionally interbreed in a wild state, and the present readily crosses in confinement with domestic poultry, but the hybrids are nearly always sterile. The third species is the Sinhalese jungle-fowl, *G. stanleyi* (the *G. lafayettii* of some authors), peculiar to Ceylon. This also greatly resembles in plumage some domestic birds, but the cock is red beneath, and has a yellow comb with a red edge and purplish-red cheeks and wattles. He has also a singularly different voice, his crow being dissyllabic. This bird crosses readily with tame hens, but the hybrids are believed to be infertile. The fourth species, *G. varius* (the *G. furcatus* of some authors), inhabits Java and the islands eastwards as far as Flores. This differs remarkably from the others in not possessing hackles, and

in having a large unserrated comb of red and blue and only a single chin wattle. The predominance of green in its plumage is another easy mark of distinction. Hybrids between this species and domestic birds are often produced, but they are most commonly sterile. Some of them have been mistaken for distinct species, as those which have received the names of *G. aeneus* and *G. temmincki*.

Several circumstances seem to render it likely that fowls were first domesticated in Burma or the countries adjacent thereto, and it is the tradition of the Chinese that they received their poultry from the West about the year 1400 B.C. By the Institutes of Manu, the tame fowl is forbidden, though the wild is allowed to be eaten—showing that its domestication was accomplished when they were written. The bird is not mentioned in the Old Testament nor by Homer, though he has Ἰλέκτωρ (cock) as the name of a man, nor is it figured on ancient Egyptian monuments. Pindar mentions it, and Aristophanes calls it the Persian bird, thus indicating it to have been introduced to Greece through Persia, and it is figured on Babylonian cylinders between the 6th and 7th centuries B.C. It is sculptured on the Lycian marbles in the British Museum (c. 600 B.C.), and E. Blyth remarks (*Ibis*, 1867, p. 157) that it is there represented with the appearance of a true jungle-fowl, for none of the wild *Galli* have the upright bearing of the tame breed, but carry their tail in a drooping position. For further particulars of these breeds see POULTRY.

(A. N.)

FOWLER, CHARLES (1792-1867), English architect, was born at Culmpton, Devon, on the 17th of May 1792. After serving an apprenticeship of five years at Exeter, he went to London in 1814, and entered the office of David Laing, where he remained till he commenced practice for himself. His first work of importance was the court of bankruptcy in Basinghall Street, finished in 1821. In the following year he gained the first premium for a design for the new London bridge, which, however, was ultimately built according to the design of another architect. Fowler's other designs for bridges include one constructed across the Dart at Totnes. He was also the architect for the markets of Covent Garden and Hungerford, the new market at Gravesend, and Exeter lower market, and besides several churches he designed Devon lunatic asylum (1845), the London fever hospital (1849), and the hall of the Wax Chandlers' Company, Gresham Street (1853). For some years he was honorary secretary of the institute of British architects, and he was afterwards created vice-president. He retired from his profession in 1853, and died at Great Marlow, Bucks, on the 26th of September 1867.

FOWLER, EDWARD (1632-1714), English divine, was born in 1632 at Westerleigh, Gloucestershire, and was educated at Corpus Christi College, Oxford, afterwards migrating to Trinity College, Cambridge. He was successively rector of Norhill, Bedfordshire (1656) and of All Hallows, Bread Street, London (1673), and in 1676 was elected a canon of Gloucester, his friend Henry More, the Cambridge Platonist, resigning in his favour. In 1681 he became vicar of St Giles, Cripplegate, but after four years was suspended for Whiggism. When the Declaration of Indulgence was published in 1687 he successfully influenced the London clergy against reading it. In 1691 he was consecrated bishop of Gloucester and held the see until his death on the 26th of August 1714. Fowler was suspected of Pelagian tendencies, and his earliest book was a *Free Discourse* in defence of *The Practices of Certain Moderate Divines called Latitudinarians* (1670). *The Design of Christianity*, published by him in the following year, in which he laid stress on the moral design of revelation, was criticized by Baxter in his *How far Holiness is the Design of Christianity* (1671) and by Bunyan in his *Defence of the Doctrine of Justification by Faith* (1672), the latter describing the *Design* as "a mixture of Popery, Socinianism and Quakerism," a horrid accusation to which Fowler replied in a scurrilous pamphlet entitled *Dirt Wip'd Off*. He also published, in 1693, *Twenty-Eight Propositions, by which the Doctrine of the Trinity is endeavoured to be explained*, challenging with some success the Socinian position.

¹ Bird (cognate with *breed* and *brood*) was originally the young of any animal, and an early Act of the Scottish parliament speaks of "Wolf-birds," i.e. Wolf-cubs.

² Like *Deer* (Dan. *Dyr*. Ger. *Tier*). *Beast*, too, with some men has almost attained as much specialization.

FOWLER, JOHN (1826–1864), English inventor, was born at Melksham, Wilts, on the 11th of July 1826. He learned practical engineering at Middlesborough-on-Tees, and about 1850 invented a mechanical system for the drainage of land. In 1852 he began experiments in steam cultivation, and in 1858 the Royal Agricultural Society awarded him the prize of £500 which it had offered for a steam-cultivator that should be an economic substitute for the plough or the spade. In 1860 he founded at Hunslet, Leeds, the firm of Fowler & Co., manufacturers of agricultural machinery, traction engines, &c. He died at Ackworth, Yorkshire, on the 4th of December 1864.

FOWLER, SIR JOHN (1817–1898), English civil engineer, was born on the 15th of July 1817 at Wadsley Hall, near Sheffield, where his father was a land-surveyor. At the age of sixteen he became a pupil of John Towlerton Leather, the engineer of the Sheffield water-works. The latter's uncle, George Leather, was engineer of the Great Aire and Calder Navigation Company, of the Goole Docks, and other similar works, and Fowler passed occasionally into his employment, in which he acquired a thorough knowledge of hydraulic engineering. The era of railway construction soon swept both Fowler and his employers into its service, and one of his first employments was to oppose the route of the Midland railway, chosen by the Stephensons, which left Sheffield on a branch line, and was therefore strongly resented by the inhabitants. The prestige of the Stephensons carried all before it, but in later life Sir John Fowler had the satisfaction of seeing the opposition of his clients justified, and Sheffield placed on the main line. In 1838 he went into the office of John Urpeth Rastrick, one of the leading railway engineers of the day, where he was employed in designing bridges for the line from London to Brighton, and also in surveying for railways in Lancashire. In 1839 he went as representative of Mr Leather to take charge of the construction of the Stockton & Hartlepool railway and remained as manager of the line after it was finished. In 1844 he began his independent career as an engineer, and from the first was largely employed, more particularly in laying out the small railway systems which eventually were amalgamated under the title of the Manchester, Sheffield & Lincolnshire. In the course of this work he designed a bridge known as Torksey Bridge, which was disallowed by the Board of Trade inspector, Captain (afterwards Field-Marshal Sir) Lintorn Simmons. The engineering profession espoused Fowler's side in the controversy which followed, and as a result the verdict of the Board of Trade was modified. The episode was the beginning of a warm friendship between these distinguished representatives of civil and military engineering. Fowler was engineer of the London Metropolitan railway, the pioneer of underground railways, and noteworthy in that it was mostly made not by tunnelling, but by excavating from the surface and then covering in the permanent way; and he lived to be one of the engineers officially connected with the deep tunnelling "tube" system extensively adopted for electric railways in London. He was also engaged in the making of railways in Ireland, and in 1867 he was selected by Disraeli to serve on a commission to advise the government in respect of a proposal for a state-purchase of the Irish railway system. He also carried out considerable works in relation to the Nene Valley drainage and the reclamation of land at the Norfolk estuary.

In 1865 he was elected president of the Institution of Civil Engineers, the youngest president who had ever sat in the chair. He was strongly opposed to the project of a Channel tunnel to France, and in 1872 he endeavoured to obtain the consent of parliament to a Channel ferry scheme, whereby trains were to be transported across the strait in large ferry steamers. The proposal involved the making of enlarged harbours at Dover and Audresselles on the French coast, and the bill, after passing the Commons, was thrown out by the casting vote of the chairman of a committee of the House of Lords. In 1875 he was enabled to render, in his private capacity, a signal service to the Italian government, which was much embarrassed by impracticable proposals pressed on it by Garibaldi for a rectification of the course of the Tiber and other engineering works. He had

several interviews with the Italian patriot, and persuaded him of the impracticable nature of his plan, thereby obtaining for the government leisure to devise a more reasonable scheme. For eight years from 1871 he acted as general engineering adviser in Egypt to the Khedive Ismail. He projected a railway to the Sudan, and also the reparation of the barrage. These and many other plans came to an end owing to financial reasons. But the maps and surveys for the railway were given to the war office, and proved most useful to Lord Wolseley in his Nile expedition. For his service Fowler was made K.C.M.G. (1885). He was created a baronet in 1890 on the completion of the Forth bridge, of which with his partner Sir Benjamin Baker he was joint engineer. He died at Bournemouth on the 20th of November 1898.

FOWLER, WILLIAM (c. 1560–1614), Scottish poet, was born about the year 1560. He attended St Leonard's college, St Andrews, between 1574 and 1578, and in 1581 he was in Paris studying civil law. In 1581 he issued a pamphlet against John Hamilton and other Catholics, who had, he said, driven him from his country. He subsequently (about 1590) became private secretary and Master of Requests to Anne of Denmark, wife of James VI., and was renominated to these offices when the queen went to England. In 1609 his services were rewarded by a grant of 2000 acres in Ulster. His sister Susannah Fowler married Sir John Drummond, and was mother of the poet William Drummond of Hawthornden. On the title-page of *The Triumphs of Petrarke*, Fowler styles himself "P. of Hawick," which has been held to mean that he was parson of Hawick, but this is doubtful. A MS. collection of seventy-two sonnets, entitled *The Tarantula of Love*, and a translation (1587) from the Italian of the *Triumphs of Petrarke* are preserved in the library of the university of Edinburgh, in the collection bequeathed by his nephew, William Drummond. Two other volumes of his manuscript notes, scrolls of poems, &c., are preserved among the Drummond MSS., now in the library of the Society of Antiquaries of Scotland. Specimens of Fowler's verses were published in 1803 by John Leyden in his *Scottish Descriptive Poems*. Fowler contributed a prefatory sonnet to James VI.'s *Furies*; and James, in return, commended, in verse, Fowler's *Triumphs*.

FOX, CHARLES JAMES (1749–1806), British statesman and orator, was the third son of Henry Fox, 1st Lord Holland, and his wife, Lady Caroline Lennox, eldest daughter of Charles Lennox, 2nd duke of Richmond. He was born at 9 Conduit Street, Westminster, on the 24th of January 1749. The father, who treated his children with extreme indulgence, allowed him to choose his school, and he elected to go to one kept at Wandsworth by a French refugee, named Pampelonne. In a very short time he asked to be sent to Eton, where he went in 1757. At Eton he did no more work than was acceptable to him, but he had an inborn love of literature, and he laid the foundation of that knowledge of the classic languages which in after years was the delight of his life. The vehemence of his temper was controlled by an affectionate disposition. When quite a boy he checked his own tendency to fits of passion on learning that his father trusted him to cure his defects.

That he learnt anything, and that he grew up an amiable and magnanimous man, were solely due to his natural worth, for no one ever owed less to education or to family example. The relations of Lord Holland to his sons would be difficult to parallel. He not only treated them, and in particular Charles, as friends and companions in pleasure from the first, but he did his best to encourage them in dissipation. In 1763 he took Charles for a tour on the continent, introduced him to the most immoral society of the time and gave him money with which to gamble. The boy came back to Eton a precocious rake. It was his good fortune that he did go back, for he was subjected to a wholesome course of ridicule by the other boys, and was flogged by Dr Barnard, the headmaster. In 1764 Charles proceeded to Hertford College, Oxford. At Oxford, as at Eton, he read literature from natural liking, and he paid some attention to mathematics. His often quoted saying that he found mathematics entertaining was probably meant as a jest at the expense

of Sir G. Macartney, to whom he was writing, and who was known to maintain that it was useless. His own account of his school and college training, given in a letter to the same correspondent (6th August 1767), is: "I employed almost my whole time at Oxford in the mathematical and classical knowledge, but more particularly in the latter, so that I understand Latin and Greek tolerably well. I am totally ignorant in every part of useful knowledge. I am more convinced every day how little advantage there is in being what at school and the university is called a good scholar: one receives a good deal of amusement from it, but that is all. At present I read nothing but Italian, which I am immoderately fond of, particularly of the poetry. . . . As for French, I am far from being so thorough a master of it as I could wish, but I know so much of it that I could perfect myself in it at any time with very little trouble, especially if I pass three or four months in France." The passage is characteristic. It shows at once his love of good literature and his thoroughness. Fox's youth was disorderly, but it was never indolent. He was incapable of half doing anything which he did at all. He did perfect himself in French, and he showed no less determination to master mere sports. At a later period when he had grown fat he accounted for his skill in taking "cut balls" at tennis by saying that he was a very "painstaking man." He was all his life a great and steady walker.

The disorders of his early years were notorious, and were a common subject of gossip. In the spring of 1767 he left Oxford and joined his father on the continent during a tour in France and Italy. In 1768 Lord Holland bought the pocket borough of Midhurst for him, and he entered on his parliamentary career, and on London society, in 1769. Within the next few years Lord Holland reaped to the full the reward for all that was good, and whatever was evil, in the training he had given his son. The affection of Charles Fox for his father was unbounded, but the passion for gambling which had been instilled in him as a boy proved the ruin of the family fortune. He kept racehorses, and bet on them largely. On the racecourse he was successful, and it is another proof of his native thoroughness that he gained a reputation as a handicapper. It is said that he won more than he lost on the course. At the gambling table he was unfortunate, and there can be little question that he was fleeced both in London and in Paris by unscrupulous players of his own social rank, who took advantage of his generosity and whose worthlessness he knew. In the ardour of his passion Fox took his losses and their consequences with an attractive gaiety. He called the room in which he did business with the Jew money-lenders his "Jerusalem chamber." When his elder brother had a son, and his prospects were injured, he said that the boy was a second Messiah, who had appeared for the destruction of the Jews. "He had his jest, and they had his estate." In 1774 Lord Holland had to find £140,000 to pay the gambling debts of his sons. For years Charles lived in pecuniary embarrassment, and during his later years, when he had given up gambling, he was supported by the contributions of wealthy friends, who in 1793 formed a fund of £70,000 for his benefit.

His public career did not supply him with a check on habits of dissipation in the shape of the responsibilities of office. He began, as was to be expected in his father's son, by supporting the court; and in 1770, when only twenty-one, he was appointed a junior lord of the admiralty with Lord North. During the violent conflict over the Middlesex election (see WILKES, JOHN) he took the unpopular side, and vehemently asserted the right of the House of Commons to exclude Wilkes. In 1772 during the proceedings against Crosby and Oliver—a part of the "Wilkes and liberty" agitation—he and Lord North were attacked by a mob and rolled in the mud. But Fox's character was incompatible with ministerial service under King George III. The king, himself a man of orderly life, detested him as a gambler and a rake. And Fox was too independent to please a master who expected obedience. In February 1772 he threw up his place to be free to oppose the Royal Marriage Act, on which the king's heart was set. He returned to office as junior lord of the treasury in December. But he was insubordinate; his

sympathy with the American colonies, which were now beginning to resist the claims of the mother country to tax them, made him intolerable to the king and he was dismissed in February 1774. The death of his father on the 1st of July of that year removed an influence which tended to keep him subordinate to the court, and his friendship for Burke drew him into close alliance with the Rockingham Whigs. From the first his ability had won him admiration in the House of Commons. He had prepared to distinguish himself as an orator by the elaborate cultivation of his voice, which was naturally harsh and shrill. His argumentative force was recognized at once, but the full scope of his powers was first shown on the 2nd of February 1775, when he spoke on the disputes with the colonies. The speech is unfortunately lost, but Gibbon, who heard it, told his friend Holroyd (afterwards Earl of Sheffield) that Fox, "taking the vast compass of the question before us, discovered powers for regular debate which neither his friends hoped nor his enemies dreaded."

His great political career dates from that day. It is unique among the careers of British statesmen of the first rank, for it was passed almost wholly in opposition. Except for a few months in 1782 and 1783, and again for a few months before his death in 1806, he was out of office. If he was absolutely sincere in the statement he made to his friend Fitzpatrick, in a letter of the 3rd of February 1778, his life was all he could have wished. "I am," he wrote, "certainly ambitious by nature, but I really have, or think I have, totally subdued that passion. I have still as much vanity as ever, which is a happier passion by far, because great reputation I think I may acquire and keep, great situation I never can acquire, nor if acquired keep, without making sacrifices that I never will make." His words show that he judged himself and read the future accurately. Yet it was certainly a cause of bitter disappointment to him that he had to stand by while the country was in his opinion not only misgoverned, but led to ruin. His reputation as an orator and a political critic, which was great from the first and grew as he lived, most assuredly did not console him for his impotence as a statesman. Of the causes which rendered his brilliant capacity useless for the purpose of obtaining practical success the most important, perhaps the only one of real importance, was his personal character. Lord John Russell (afterwards Earl Russell), his friendly biographer, has to confess that Fox might have joined in the confession of Mirabeau: "The public cause suffers for the immoralities of my youth." His reputation as a rake and gambler was so well established at the very beginning of his career that when he was dismissed from office in 1774 there was a general belief among the vulgar that he had been detected in actual theft. His perfect openness, the notoriety of his bankruptcies and of the seizure of his books and furniture in execution, kept him before the world as a model of dissipation. In 1776, when he was leading the resistance to Lord North's colonial policy, he "neither abandoned gaming nor his rakish life. He was seldom in bed before five in the morning nor out of it before two at noon." At the most important crisis of his life in 1783, he almost made an ostentation of disorder and of indifference not only to appearances, but even to decency. Horace Walpole has drawn a picture of him at that time which Lord Holland, Fox's beloved and admiring nephew, speaking from his early recollections of his uncle, confesses has "some justification." Coming from such an authority the certificate may be held to confirm the substantial accuracy of Walpole. "Fox lodged in St James's Street, and as soon as he rose, which was very late, had a levée of his followers and of the gaming club at Brooks's—all his disciples. His bristly black person, and shagged breast quite open and rarely purified by any ablutions, was wrapped in a foul linen nightgown and his bushy hair dishevelled. In these cynic weeds and with Epicurean good humour did he dictate his politics, and in this school did the heir of the empire attend his lessons and imbibe them." That this cynic manner, and Epicurean speech, were only the outside of a manly and generous nature was well known to the personal friends of Fox, and is now universally allowed. But by the bulk of his contemporaries,

who could not fail to see the weaknesses he ostentatiously displayed, Fox was, not unnaturally, suspected as being immoral and untrustworthy. Therefore when he came into collision with the will of the king he failed to secure the confidence of the nation which was his only support. Nor ought any critical admirer of Fox to deny that George III. was not wholly wrong when he said that the great orator "was totally destitute of discretion and sound judgment." Fox made many mistakes, due in some cases to vehemence of temperament, and in others only to be ascribed to want of sagacity. That he fought unpopular causes is a very insufficient explanation of his failure as a practical statesman. He could have profited by the reaction which followed popular excitement but for his bad reputation and his want of discretion.

During the eight years between his expulsion from office in 1774 and the fall of Lord North's ministry in March 1782 he may indeed be said to have done one very great thing in politics. He planted the seed of the modern Liberal party as opposed to the pure Whigs. In political allegiance he became a member of the Rockingham party and worked in alliance with the marquis and with Burke, whose influence on him was great. In opposing the attempt to coerce the American colonists, and in assailing the waste and corruption of Lord North's administration, as well as the undue influence of the crown, he was at one with the Rockingham Whigs. During the agitation against corruption, and in favour of honest management of the public money, which was very strong between 1779 and 1782, he and they worked heartily together. It had a considerable effect, and prepared the way for the reforms begun by Burke and continued by Pitt. But if Fox learnt much from Burke he learnt with originality. He declined to accept the revolution settlement as final, or to think with Burke that the constitution of the House of Commons could not be bettered. Fox acquired the conviction that, if the House was to be made an efficient instrument for restraining the interference of the king and for securing good government, it must cease to be filled to a very large extent by the nominees of boroughmongers and the treasury. He became a strong advocate for parliamentary reform. In all ways he was the ardent advocate of what have in later times been known as "Liberal causes," the removal of all religious disabilities and tests, the suppression of private interests which hampered the public good, the abolition of the slave trade, and the emancipation of all classes and races of men from the strict control of authority.

A detailed account of his activity from 1774 to 1782 would entail the mention of every crisis of the American War of Independence and of every serious debate in parliament. Throughout the struggle Fox was uniformly opposed to the coercion of the colonies and was the untiring critic of Lord North. While the result must be held to prove that he was right, he prepared future difficulties for himself by the fury of his language. He was the last man in the world to act on the worldly-wise maxim that an enemy should always be treated as if he may one day be a friend, and a friend as if he might become an enemy. On the 29th of November 1779 Fox was wounded in a duel with Mr William Adam, a supporter of Lord North's whom he had savagely denounced. He assailed Lord North with unmeasured invective, directed not only at his policy but at his personal character, though he well knew that the prime minister was an amiable though pliable man, who remained in office against his own wish, in deference to the king who appealed to his loyalty. When the disasters of the American war had at last made a change of ministry necessary, and the king applied to the Whigs, through the intermediary of Lord Shelburne, Fox made a very serious mistake in persuading the marquis of Rockingham not to insist on dealing directly with the sovereign. The result was the formation of a cabinet belonging, in Fox's own words, partly to the king and partly to the country—that is to say, partly of Whigs who wished to restrain the king, and partly of the king's friends, represented by Lord Shelburne, whose real function was to baffle the Whigs. Dissensions began from the first, and were peculiarly acute between Shelburne

and Fox, the two secretaries of state. The old division of duties by which the southern secretary had the correspondence with the colonies and the western powers of Europe, and the northern secretary with the others, had been abolished on the formation of the Rockingham cabinet. All foreign affairs were entrusted to Fox. Lord Shelburne meddled in the negotiations for the peace at Paris. He also persuaded his colleagues to grant some rather scandalous pensions, and Fox's acquiescence in this abuse after his recent agitation against Lord North's waste did him injury. When the marquis of Rockingham died on the 1st of July 1782, and the king offered the premiership to Shelburne, Fox resigned, and was followed by a part of the Rockingham Whigs.

In refusing to serve under Shelburne he was undoubtedly consistent, but his next step was ruinous to himself and his party. On the 14th of February 1783 he formed a coalition with Lord North, based as they declared on "mutual goodwill and confidence." Plausible excuses were made for the alliance, but to the country at large this union, formed with a man whom he had denounced for years, had the appearance of an unscrupulous conspiracy to obtain office on any terms. In the House of Commons the coalition was strong enough to drive Shelburne from office on the 24th of February. The king made a prolonged resistance to the pressure put on him to accept Fox and North as his ministers (see PITT, WILLIAM). On the 2nd of April he was constrained to submit to the formation of a new ministry, in which the duke of Portland was prime minister and Fox and North were secretaries of state. The new administration was ill liked by some of the followers of both. Fox increased its unpopularity both in the House and in the country by consenting against the wish of most of his colleagues to ask for the grant of a sum of £100,000 a year to the prince of Wales. The act had the appearance of a deliberate offence to the king, who was on bad terms with his son. The magnitude of the sum, and his acquiescence in the grant of pensions by the Shelburne ministry, convinced the country that his zeal for economy was hypocritical. The introduction of the India Bill in November 1783 alarmed many vested interests, and offended the king by the provision which gave the patronage of India to a commission to be named by the ministry and removable only by parliament. The coalition, and Fox in particular, were assailed in a torrent of most telling invective and caricature. Encouraged by the growing unpopularity of his ministers, George III. gave it to be understood that he would not look upon any member of the House of Lords who voted for the India Bill as his friend. The bill was thrown out in the upper House on the 17th of December, and next day the king dismissed his ministers.

Fox now went into opposition again. The remainder of his life may be divided into four portions—his opposition to Pitt during the session of 1784; his parliamentary activity till his secession in 1797; his retirement till 1800; his return to activity and his short tenure of office before his death in 1806. During the first of these periods he deepened his unpopularity by assailing the undoubted prerogatives of the crown, by claiming for the House of Commons the right to override not only the king and the Lords but the opinion of the country, and by resisting a dissolution. This last pretension came very ill from a statesman who in 1780 had advocated yearly elections. He lost ground daily before the steady good judgment and unblemished character of Pitt. When parliament was dissolved at the end of the session of 1784, the country showed its sentiments by unseating 180 of the followers of Fox and North. Immense harm was done to both by the publication of a book called *The Beauties of Fox, North and Burke*, a compilation of their abuse of one another in recent years.

Fox himself was elected for Westminster with fewer votes than Admiral Lord Hood, but with a majority over the ministerial candidate, Sir Cecil Wray. The election was marked by an amazing outflow of caricatures and squibs, by weeks of rioting in which Lord Hood's sailors fought pitched battles in St James's Street with Fox's hackney coachmen, and by the intrepid canvassing of Whig ladies. The beautiful duchess of Devonshire

(Georgiana Spencer) is said to have won at least one vote for Fox by kissing a shoemaker who had a romantic idea of what constituted a desirable bribe. The high bailiff refused to make a return, and the confirmation of Fox's election was delayed by the somewhat mean action of the ministry. He had, however, been chosen for Kirkwall, and could fight his cause in the House. In the end he recovered damages from the high bailiff. In his place in parliament he sometimes supported Pitt and sometimes opposed him with effect. His criticism on the ministers' bill for the government of India was sound in principle, though the evils he foresaw did not arise. Little excuse can be made for his opposition to Pitt's commercial policy towards Ireland. But as Fox on this occasion aided the vested interests of some English manufacturers he secured a certain revival of popularity. His support of Pitt's Reform Bill was qualified by a just dislike of the ministers' proposal to treat the possession of the franchise by a constituency as a property and not as a trust. His unsuccessful opposition to the commercial treaty with France in 1787 was unwise and most injurious to himself. He committed himself to the proposition that France was the natural enemy of Great Britain, a saying often quoted against him in coming years. It has been excused on the ground that when he said France he meant the aggressive house of Bourbon. A statesman whose words have to be interpreted by an esoteric meaning cannot fairly complain if he is often misunderstood. In 1788 he travelled in Italy, but returned in haste on hearing of the illness of the king. Fox supported the claim of the prince of Wales to the regency as a right, a doctrine which provoked Pitt into declaring that he would "unwhig the gentleman for the rest of his life." The friendship between him and the prince of Wales (see GEORGE IV.) was always injurious to Fox. In 1787 he was misled by the prince's ambiguous assurances into denying the marriage with Mrs Fitzherbert. On discovering that he had been deceived he broke off all relations with the prince for a year, but their alliance was renewed. During these years he was always in favour of whatever measures could be described as favourable to emancipation and to humanity. He actively promoted the impeachment of Warren Hastings, which had the support of Pitt. He was always in favour of the abolition of the slave trade (which he actually effected during his short tenure of office in 1806), of the repeal of the Test Acts, and of concessions to the Roman Catholics, both in Great Britain and in Ireland.

The French Revolution affected Fox profoundly. Together with almost all his countrymen he welcomed the meeting of the states-general in 1789 as the downfall of a despotism hostile to Great Britain. But when the development of the Revolution caused a general reaction, he adhered stoutly to his opinion that the Revolution was essentially just and ought not to be condemned for its errors or even for its crimes. As a natural consequence he was the steady opponent of Pitt's foreign policy, which he condemned as a species of crusade against freedom in the interest of despotism. Between 1790 and 1800 his unpopularity reached its height. He was left almost alone in parliament, and was denounced as the enemy of his country. On the 6th of May 1791 occurred the painful scene in the House of Commons, in which Burke renounced his friendship. In 1792 there was some vague talk of a coalition between him and Pitt, which came to nothing. It should be noted that the scene with Burke took place in the course of the debate on the Quebec Bill, in which Fox displayed real statesmanship by criticizing the division of Upper from Lower Canada, and other provisions of the bill, which in the end proved so injurious as to be unworkable. In this year he carried the Libel Bill. In 1792 his ally, the duke of Portland, and most of his party left him. In 1797 he withdrew from parliament, and only came forward in 1798 to reaffirm the doctrine of the sovereignty of the people at a great Whig dinner. On the 9th of May he was dismissed from the privy council.

The interval of secession was perhaps the happiest in his life. In 1783 he formed a connexion with Elizabeth Bridget Cane, commonly known as Mrs Armistead or Armistead, an amiable

and well-mannered woman to whom he was passionately attached. In company with her he established himself at St Anne's Hill near Chertsey in Surrey. In 1795 he married her privately, but did not avow his marriage till 1802. In his letters he spoke of her always as Mrs Armistead, and some of his friends—Mr Coke of Holkham, afterwards Lord Leicester, with whom he stayed every year, being one of them—would not invite her to their houses. It is hard to explain this solitary instance of shabby conduct in a thoroughly generous man towards a person to whom he was unalterably attached and who fully deserved his affection. Fox's time at St Anne's was largely spent in gardening, in the enjoyment of the country, and in correspondence on literary subjects with his nephew, the 3rd Lord Holland, and with Gilbert Wakefield, the editor of Euripides. His letters show that he had a very sincere love for, and an enlightened appreciation of, good literature. Greek and Italian were his first favourites, but he was well read in English literature and in French, and acquired some knowledge of Spanish. His favourite authors were Euripides, Virgil and Racine, whom he defends against the stock criticisms of the admirers of Corneille with equal zeal and insight.

Fox reappeared in parliament to take part in the vote of censure on ministers for declining Napoleon's overtures for a peace. The fall of Pitt's first ministry and the formation of the Addington cabinet, the peace of Amiens, and the establishment of Napoleon as first consul with all the powers of a military despot, seemed to offer Fox a chance of resuming power in public life. The struggle with Jacobinism was over, and he could have no hesitation in supporting resistance to a successful general who ruled by the sword, and who pursued a policy of perpetual aggression. During 1802 he visited Paris in company with his wife. An account of his journey was published in 1811 by his secretary, Mr Trotter, in an otherwise poor book of reminiscence. It gives an attractive picture of Fox's good-humour, and of his enjoyment of the "species of minor comedy which is constantly exhibited in common life." His main purpose in visiting Paris was to superintend the transcription of the correspondence of Barillon, which he needed for his proposed life of James II. The book was never finished, but the fragment he completed was published in 1808, and was translated into French by Armand Carrel in 1846. Fox was not favourably impressed by Napoleon. He saw a good deal of French society, and was himself much admired for his hearty defence of his rival Pitt against a foolish charge of encouraging plots for Napoleon's assassination. On his return he resumed his regular attendance in the House of Commons. The history of the renewal of the war, of the fall of Addington's ministry, and of the formation of Pitt's second administration is so fully dealt with in the article on Pitt (*q.v.*) that it need not be repeated here.

The death of Pitt left Fox so manifestly the foremost man in public life that the king could no longer hope to exclude him from office. The formation of a ministry was entrusted by the king to Lord Grenville, but when he named Fox as his proposed secretary of state for foreign affairs George III. accepted him without demur. Indeed his hostility seems to a large extent to have died out. A long period of office might now have appeared to lie before Fox, but his health was undermined. Had he lived it may be considered as certain that the war with Napoleon would have been conducted with a vigour which was much wanting during the next few years. In domestic politics Fox had no time to do more than insist on the abolition of the slave trade. He, like Pitt, was compelled to bow to the king's invincible determination not to allow the emancipation of the Roman Catholics. When a French adventurer calling himself Guillet de la Gevriillière, whom Fox at first "did the honour to take for a spy," came to him with a scheme for the murder of Napoleon, he sent a warning on the 20th of February to Talleyrand. The incident gave him an opportunity for reopening negotiations for peace. A correspondence ensued, and British envoys were sent to Paris. But Fox was soon convinced that the French ministers were playing a false game. He was resolved not to treat apart from Russia, then the ally of Great Britain,

nor to consent to the surrender of Sicily, which Napoleon insisted upon, unless full compensation could be obtained for King Ferdinand. The later stages of the negotiation were not directed by Fox, but by colleagues who took over his work at the foreign office when his health began to fail in the summer of 1806. He showed symptoms of dropsy, and operations only procured him temporary relief. After carrying his motion for the abolition of the slave trade on the 10th of June, he was forced to give up attendance in parliament, and he died in the house of the duke of Devonshire, at Chiswick, on the 13th of September 1806. His wife survived him till the 8th of July 1842. No children were born of the marriage. Fox is buried in Westminster Abbey by the side of Pitt.

The striking personal appearance of Fox has been rendered very familiar by portraits and by innumerable caricatures. The latter were no doubt deliberately exaggerated, and yet a comparison between the head of Fox in Sayer's plate "Carlo Khan's triumphal entry into Leadenhall," and in Abbot's portrait, shows that the caricaturist did not depart from the original. Fox was twice painted by Sir Joshua Reynolds, once when young in a group with Lady Sarah Bunbury and Lady Susan Strangeways, and once at full length. A half-length portrait by the German painter, Karl Anton Hickel, is in the National Portrait Gallery, where there is also a terra-cotta bust by Nollekens.

AUTHORITIES.—The materials for a life of Fox were first collected by his nephew, Lord Holland, and were then revised and rearranged by Mr Allen and Lord John Russell. These materials appear as *Memoirs and Correspondence of C. J. Fox* (London, 1853-1857). On them Lord John Russell based his *Life and Times of C. J. Fox* (London, 1859-1866); Sir G. O. Trevelyan's *Early History of C. J. Fox* (London, 1880) brings new evidence; *Charles James Fox, a Political Study*, by J. L. Le B. Hammond (London, 1903), is a series of studies written by an extreme admirer. His *Speeches* were collected and published in 1815. The newspaper articles (e.g. in *The Times*) published on the occasion of the centenary of his death contain interesting appreciations. See also Lloyd Sanders, *The Holland House Circle* (1908). (D. H.)

FOX, EDWARD (c. 1496-1538), bishop of Hereford, was born about 1496 at Dursley in Gloucestershire; he is said on very doubtful authority to have been related to Richard Fox (*q.v.*). From Eton he proceeded to King's College, Cambridge, and after graduating was made secretary to Wolsey. In 1528 he was sent with Gardiner to Rome to obtain from Clement VII. a decretal commission for the trial and decision of the case between Henry VIII. and Catherine of Aragon. On his return he was elected provost of King's College, and in August 1529 was the means of conveying to the king Cranmer's historic advice that he should apply to the universities of Europe rather than to the pope. This introduction led eventually to Cranmer's promotion over Fox's head to the archbishopric of Canterbury. After a brief mission to Paris in October 1529, Fox in January 1530 befriended Latimer at Cambridge and took an active part in persuading that university and Oxford to decide in the king's favour. He was sent to employ similar methods of persuasion at the French universities in 1530-1531, and was also engaged in negotiating a closer league between England and France. In April 1533 he was prolocutor of convocation when it decided against the validity of Henry's marriage with Catherine, and in 1534 published his treatise *De vera differentia regiae potestatis et ecclesiae* (second ed. 1538, English transl. 1548). Various ecclesiastical preferments were now granted him, including the archdeaconry of Leicester (1531) and the bishopric of Hereford (1535). In 1535-1536 he was sent to Germany to discuss the basis of a political and theological understanding with the Lutheran princes and divines, and had several interviews with Luther, who could not be persuaded of the justice of Henry VIII.'s divorce. The principal result of the mission was the Wittenberg articles of 1536, which had no slight influence on the English Ten Articles of the same year. Bucer dedicated to him in 1536 his *Commentaries on the Gospels*, and Fox's Protestantism was also illustrated by his patronage of Alexander Aless, whom he defended before Convocation. Fox is credited with the authorship of several proverbial sayings, such as "the surest way to peace is a constant preparedness for war" and "time and I will challenge

any two in the world." The former at any rate is only a variation of the Latin *si vis pacem, para bellum*, and probably the latter is not more original in Fox than in Philip II., to whom it is usually ascribed. Fox died on the 8th of May 1538 and was buried in the church of St Mary Mounthaw, London. His chief distinction is perhaps that he was the most Lutheran of Henry VIII.'s bishops, and was largely responsible for the Ten Articles of 1536.

See *Letters and Papers of Henry VIII.*, vols. iv.-xiv.; Cooper's *Athenae Cantabrigienses*; *Dict. Nat. Biogr.*; R. W. Dixon's *Church History*; G. Mentz, *Die Wittenberger Artikel von 1536* (1905). (A. F.P.)

FOX, GEORGE (1624-1691), the founder of the "Society of Friends" or "Quakers," was born at Drayton, Leicestershire, in July 1624. His father, Christopher Fox, called by the neighbours "Righteous Christer," was a weaver by occupation; and his mother, Mary Lago, "an upright woman and accomplished above most of her degree," was "of the stock of the martyrs." George from his childhood "appeared of another frame than the rest of his brethren, being more religious, inward, still, solid and observing beyond his years"; and he himself declares: "When I came to eleven years of age I knew pureness and righteousness; for while a child I was taught how to walk to be kept pure." Some of his relations wished that he should be educated for the ministry; but his father apprenticed him to a shoemaker, who also dealt in wool and cattle. In this service he remained till his nineteenth year. According to Penn, "he took most delight in sheep," but he himself simply says: "A good deal went through my hands. . . . People had generally a love to me for my innocency and honesty." In 1643, being upon business at a fair, and having accompanied some friends to the village public-house, he was troubled by a proposal to "drink healths," and withdrew in grief of spirit. "When I had done what business I had to do I returned home, but did not go to bed that night, nor could I sleep, but sometimes walked up and down, and sometimes prayed and cried to the Lord, who said unto me, 'Thou seest how young people go together into vanity and old people into the earth; thou must forsake all, both young and old, and keep out of all, and be a stranger unto all.' Then, at the command of God, on the ninth day of the seventh month, 1643, I left my relations and broke off all familiarity or fellowship with old or young."

Thus briefly he describes what appears to have been the greatest moral crisis in his life. The four years which followed were a time of great perplexity and distress, though sometimes "I had intermissions, and was sometimes brought into such a heavenly joy that I thought I had been in Abraham's bosom." He would go from town to town, "travelling up and down as a stranger in the earth, which way the Lord inclined my heart; taking a chamber to myself in the town where I came, and tarrying sometimes a month, more or less, in a place"; and the reason he gives for this migratory habit is that he was "afraid both of professor and profane, lest, being a tender young man, he should be hurt by conversing much with either." The same fear often led him to shun all society for days at a time; but frequently he would apply to "professors" for spiritual direction and consolation. These applications, however, never proved successful; he invariably found that his advisers "possessed not what they professed." Some recommended marriage, others enlistment as a soldier in the civil wars; one "ancient priest" bade him take tobacco and sing psalms; another of the same fraternity, "in high account," advised physic and blood-letting.

About the beginning of 1646 his thoughts began to take more definite shape. One day, approaching Coventry, "the Lord opened to him" that none were true believers but such as were born of God and had passed from death unto life; and this was soon followed by other "openings" to the effect that "being bred at Oxford or Cambridge was not enough to fit and qualify men to be ministers of Christ," and that "God who made the world did not dwell in temples made with hands." He also experienced deeper manifestations of Christ within his own soul. "When I myself was in the deep, shut up under all [the burden of corruptions], I could not believe that I should ever

overcome; my troubles, my sorrows and my temptations were so great that I thought many times I should have despaired, I was so tempted. But when Christ opened to me how He was tempted by the same devil, and overcame him and bruised his head, and that through Him, and His power, light, grace and spirit, I should overcome also, I had confidence in Him; so He it was that opened to me, when I was shut up and had no hope nor faith. Christ, who had enlightened me, gave me His light to believe in; He gave me hope which He himself revealed in me; and He gave me His spirit and grace, which I found sufficient in the deeps and in weakness." In 1647 he records that at a time when all outward help had failed "I heard a voice which said, 'There is one, even Christ Jesus, that can speak to thy condition.' And when I heard it my heart did leap for joy." In the same year he first openly declared his message in the neighbourhood of Dukinfield and Manchester (see FRIENDS, SOCIETY OF).

In 1649, as he was walking towards Nottingham, he heard the bell of the "steeple house" of the city, and was admonished by an inward voice to go forward and cry against the great idol and the worshippers in it. Entering the church he found the preacher engaged in expounding the words, "We have also a more sure word of prophecy," from which the ordinary Protestant doctrine of the supreme authority of Scripture was being enforced in a manner which appeared to Fox so defective or erroneous as to call for his immediate and most energetic protest. Lifting up his voice against the preacher's doctrine, he declared that it is not by the Scripture alone, but by the divine light by which the Scriptures were given, that doctrines ought to be judged. He was carried off to prison, where he was detained for some time, and from which he was released only by the favour of the sheriff, whose sympathies he had succeeded in enlisting. In 1650 he was imprisoned for about a year at Derby on a charge of blasphemy. On his release, overwrought and weakened by six months spent "in the common gaol and dungeon," he performed what was almost the only and certainly the most pronounced act of his life which had the appearance of wild fanaticism. Through the streets of Lichfield, on market day, he walked barefoot, crying, "Woe to the bloody city of Lichfield." His own explanation of the act, connecting it with the martyrdom of a thousand Christians in the time of Diocletian, is not convincing. His proceeding was probably due to a horror of the city arising from a subconscious memory of what he must have heard in childhood from his mother ("of the stock of the martyrs") concerning a martyr, a woman, burnt in the reign of Mary at Lichfield, who had been taken thither from Mancetter, a village two miles from his home in which he had worked as a journeyman shoemaker (see *The Martyrs Glover and Lewis of Mancetter*, by the Rev. B. Richings). He must also have heard of the burning of Edward Wightman in the same city in 1612, the last person burned for heresy in England.

It would be here out of place to follow with any minuteness the details of his subsequent imprisonments, such as that at Carlisle in 1653; London 1654; Launceston 1656; Lancaster 1660, and again in 1663, whence he was taken to Scarborough in 1665; and Worcester 1673. During these terms of imprisonment his pen was not idle, as is amply shown by the very numerous letters, pastorals and exhortations which have been preserved; while during his intervals of liberty he was unwearied in the work of "declaring truth" in all parts of the country. In 1669 he married Margaret, widow of Judge Fell, of Swarthmoor, near Ulverston, who, with her family, had been among his earliest converts. In 1671 he visited Barbados, Jamaica, and the American continent, and shortly after his return in 1673 he was, as has been already noted, apprehended in Worcestershire for attending meetings that were forbidden by the law. At Worcester he suffered a captivity of nearly fourteen months. In 1677 he visited Holland along with Barclay, Penn and seven others; and this visit he repeated (with five others) in 1684. The later years of his life were spent mostly in London, where he continued to speak in public, comparatively unmolested,

until within a few days of his death, which took place on the 13th of January 1691 (1690 o.s.).

William Penn has left on record an account of Fox from personal knowledge—a *Brief Account of the Rise and Progress of the People called Quakers*, written as a preface to Fox's *Journal*. Although a man of large size and great bodily strength, he was "very temperate, eating little and sleeping less." He was a man of strong personality, of measured utterance, "civil" (says Penn) "beyond all forms of breeding." From his *Journal* we gather that he had piercing eyes and a very loud voice, and wore good clothes. Unlike the Roundheads, he wore his hair long. Even before his marriage with Margaret Fell he seems to have been fairly well off; he does not appear to have worked for a living after he was nineteen, and yet he had a horse, and speaks of having money to give to those who were in need. He had much practical common-sense, and keen sympathy for all who were in distress and for animals. The mere fact that he was able to attract to himself so considerable a body of respectable followers, including such men as Ellwood, Barclay, Penington and Penn, is sufficient to prove that he possessed in a very eminent degree the power of conviction, persuasion, and moral ascendancy; while of his personal uprightness, single-mindedness and sincerity there can be no question.

The writings of Fox are enumerated in Joseph Smith's *Catalogue of Friends' Books*. The *Journal* is especially interesting; of it Sir James Mackintosh has said that "it is one of the most extraordinary and instructive narratives in the world, which no reader of competent judgment can peruse without revering the virtue of the writer." The *Journal* was originally published in London in 1694; the edition known as the Bicentenary Edition, with notes biographical and historical (reprint of 1901 or later), will be found the most useful in practice. An exact transcript of the *Journal* has been issued by the Cambridge University Press. A *Life of George Fox*, by Dr Thomas Hodgkin; *The Fells of Swarthmoor Hall*, by Maria Webb; and *The Life and Character of George Fox*, by John Stephenson Rowntree, are valuable. For a mention of other works, and for details of the principles and history of the Society of Friends, together with some further information about Fox, see the article FRIENDS, SOCIETY OF. (A. N. B.)

FOX, RICHARD (c. 1448–1528), successively bishop of Exeter, Bath and Wells, Durham, and Winchester, lord privy seal, and founder of Corpus Christi College, Oxford, was born about 1448 at Ropesley near Grantham, Lincolnshire. His parents belonged to the yeoman class, and there is some obscurity about Fox's early career. It is not known at what school he was educated, nor at what college, though the presumption is in favour of Magdalen, Oxford, whence he drew so many members of his subsequent foundation, Corpus Christi. He also appears to have studied at Cambridge, but nothing definite is known of the first thirty-five years of his career. In 1484 he was in Paris, whether merely for the sake of learning or because he had rendered himself obnoxious to Richard III. is a matter of speculation. At any rate he was brought into contact with the earl of Richmond, who was then beginning his quest for the English throne, and was taken into his service. In January 1485 Richard intervened to prevent Fox's appointment to the vicarage of Stepney on the ground that he was keeping company with the "great rebel, Henry ap Tudor."

The important offices conferred on Fox immediately after the battle of Bosworth imply that he had already seen more extensive political service than can be traced in records. Doubtless Henry VII. had every reason to reward his companions in exile, and to rule like Ferdinand of Aragon by means of lawyers and churchmen rather than trust nobles like those who had made the Wars of the Roses. But without an intimate knowledge of Fox's political experience and capacity he would hardly have made him his principal secretary, and soon afterwards lord privy seal and bishop of Exeter (1487). The ecclesiastical preferment was merely intended to provide a salary not at Henry's expense; for Fox never saw either Exeter or the diocese of Bath and Wells to which he was translated in 1492. His activity was confined to political and especially diplomatic channels; so long as Morton lived, Fox was his subordinate, but after the archbishop's death he was second to none in Henry's confidence, and he had an important share in all the diplomatic

work of the reign. In 1487 he negotiated a treaty with James III. of Scotland, in 1491 he baptized the future Henry VIII., in 1492 he helped to conclude the treaty of Etaples, and in 1497 he was chief commissioner in the negotiations for the famous commercial agreement with the Netherlands which Bacon seems to have been the first to call the *Magnus Intercursus*.

Meanwhile in 1494 Fox had been translated to Durham, not merely because it was a richer see than Bath and Wells but because of its political importance as a palatine earldom and its position with regard to the Borders and relations with Scotland. For these reasons rather than from any ecclesiastical scruples Fox visited and resided in his new diocese; and he occupied Norham Castle, which he fortified and defended against a Scottish raid in Perkin Warbeck's interests (1497). But his energies were principally devoted to pacific purposes. In that same year he negotiated Perkin's retirement from the court of James IV., and in 1498-1499 he completed the negotiations for that treaty of marriage between the Scottish king and Henry's daughter Margaret which led ultimately to the union of the two crowns in 1603 and of the two kingdoms in 1707. The marriage itself did not take place until 1503, just a century before the accession of James I.

This consummated Fox's work in the north, and in 1501 he was once more translated to Winchester, then reputed the richest bishopric in England. In that year he brought to a conclusion marriage negotiations not less momentous in their ultimate results, when Prince Arthur was betrothed to Catherine of Aragon. His last diplomatic achievement in the reign of Henry VII. was the betrothal of the king's younger daughter Mary to the future emperor Charles V. In 1500 he was elected chancellor of Cambridge University, an office not confined to noble lords until a much more democratic age, and in 1507 master of Pembroke Hall in the same university. The Lady Margaret Beaufort made him one of her executors, and in this capacity as well as in that of chancellor, he had the chief share with Fisher in regulating the foundation of St John's College and the Lady Margaret professorships and readerships. His financial work brought him a less enviable notoriety, though a curious freak of history has deprived him of the credit which is his due for "Morton's fork." The invention of that ingenious dilemma for extorting contributions from poor and rich alike is ascribed as a tradition to Morton by Bacon; but the story is told in greater detail of Fox by Erasmus, who says he had it from Sir Thomas More, a well-informed contemporary authority. It is in keeping with the somewhat malicious saying about Fox reported by Tyndale that he would sacrifice his father to save his king, which after all is not so damning as Wolsey's dying words.

The accession of Henry VIII. made no immediate difference to Fox's position. If anything, the substitution of the careless pleasure-loving youth for Henry VII. increased the power of his ministry, the personnel of which remained unaltered. The Venetian ambassador calls Fox "alter rex" and the Spanish ambassador Carroz says that Henry VIII. trusted him more than any other adviser, although he also reports Henry's warning that the bishop of Winchester was, as his name implied, "a fox indeed." He was the chief of the ecclesiastical statesmen who belonged to the school of Morton, believed in frequent parliaments, and opposed the spirited foreign policy which laymen like Surrey are supposed to have advocated. His colleagues were Warham and Ruthal, but Warham and Fox differed on the question of Henry's marriage, Fox advising the completion of the match with Catherine while Warham expressed doubts as to its canonical validity. They also differed over the prerogatives of Canterbury with regard to probate and other questions of ecclesiastical jurisdiction.

Wolsey's rapid rise in 1511 put an end to Fox's influence. The pacific policy of the first two years of Henry VIII.'s reign was succeeded by an adventurous foreign policy directed mainly against France; and Fox complained that no one durst do anything in opposition to Wolsey's wishes. Gradually Warham and Fox retired from the government; the occasion of Fox's

resignation of the privy seal was Wolsey's ill-advised attempt to drive Francis I. out of Milan by financing an expedition led by the emperor Maximilian in 1516. Tunstall protested, Wolsey took Warham's place as chancellor, and Fox was succeeded by Ruthal, who, said the Venetian ambassador, "sang treble to Wolsey's bass." He bore Wolsey no ill-will, and warmly congratulated him two years later when warlike adventures were abandoned at the peace of London. But in 1522 when war was again declared he emphatically refused to bear any part of the responsibility, and in 1523 he opposed in convocation the financial demands which met with a more strenuous resistance in the House of Commons.

He now devoted himself assiduously to his long-neglected episcopal duties. He expressed himself as being as anxious for the reformation of the clergy as Simeon for the coming of the Messiah; but while he welcomed Wolsey's never-realized promises, he was too old to accomplish much himself in the way of remedying the clerical and especially the monastic depravity, licence and corruption he deplored. His sight failed during the last ten years of his life, and there is no reason to doubt Matthew Parker's story that Wolsey suggested his retirement from his bishopric on a pension. Fox replied with some warmth, and Wolsey had to wait until Fox's death before he could add Winchester to his archbishopric of York and his abbey of St Albans, and thus leave Durham vacant as he hoped for the illegitimate son on whom (aged 18) he had already conferred a deanery, four archdeaconries, five prebends and a chancellorship.

The crown of Fox's career was his foundation of Corpus Christi College, which he established in 1515-1516. Originally he intended it as an Oxford house for the monks of St Swithin's, Winchester; but he is said to have been dissuaded by Bishop Oldham, who denounced the monks and foretold their fall. The scheme adopted breathed the spirit of the Renaissance; provision was made for the teaching of Greek, Erasmus lauded the institution and Pole was one of its earliest fellows. The humanist Vives was brought from Italy to teach Latin, and the reader in theology was instructed to follow the Greek and Latin Fathers rather than the scholastic commentaries. Fox also built and endowed schools at Taunton and Grantham, and was a benefactor to numerous other institutions. He died at Wolsey on the 5th of October 1528; Corpus possesses several portraits and other relics of its founder.

See *Letters and Papers of Henry VII. and Henry VIII.*, vols. i.-iv.; *Spanish and Venetian Calendars of State Papers*; Gairdner's *Lollardy and the Reformation and Church History 1485-1558*; Pollard's *Henry VIII.*; Longman's *Political History*, vol. v.; other authorities cited in the article by Dr T. Fowler (formerly president of Corpus) in the *Dict. Nat. Biog.* (A. F. P.)

FOX, ROBERT WERE (1789-1877), English geologist and natural philosopher, was born at Falmouth on the 26th of April 1789. He was a member of the Society of Friends, and was descended from members who had long settled in Cornwall, although he was not related to George Fox who had introduced the community into the county. He was distinguished for his researches on the internal temperature of the earth, being the first to prove that the heat increased definitely with the depth; his observations being conducted in Cornish mines from 1815 for a period of forty years. In 1829 he commenced a series of experiments on the artificial production of miniature metalliferous veins by means of the long-continued influence of electric currents, and his main results were published in *Observations on Mineral Veins (Rep. Royal Cornwall Polytech. Soc., 1836)*. He was one of the founders in 1833 of the Royal Cornwall Polytechnic Society. He constructed in 1834 an improved form of deflector dipping needle. In 1848 he was elected F.R.S. His garden at Penjerrick near Falmouth became noted for the number of exotic plants which he had naturalized. He died on the 25th of July 1877. (See *A Catalogue of the Works of Robert Were Fox, F.R.S., with a Sketch of his Life*, by J. H. Collins, 1878.)

His daughter, CAROLINE FOX (1819-1871), born at Falmouth on the 24th of May 1819, is well known as the authoress of a

diary, recording memories of many distinguished people, such as John Stuart Mill, John Sterling and Carlyle. Selections from her diary and correspondence (1835-1871) were published under the title of *Memories of Old Friends* (ed. by H. N. Pym, 1881; 2nd ed., 1882). She died on the 12th of January 1871.

FOX, SIR STEPHEN (1627-1716), English statesman, born on the 27th of March 1627, was the son of William Fox, of Farley, in Wiltshire, a yeoman farmer. At the age of fifteen he first obtained a situation in the household of the earl of Northumberland; then he entered the service of Lord Percy, the earl's brother, and was present with the royalist army at the battle of Worcester as Lord Percy's deputy at the ordnance board. Accompanying Charles II. in his flight to the continent, he was appointed manager of the royal household, on Clarendon's recommendation as "a young man bred under the severe discipline of Lord Percy . . . very well qualified with languages, and all other parts of clerkship, honesty and discretion." The skill with which he managed the exiguous finances of the exiled court earned him further confidence and promotion. He was employed on several important missions, and acted eventually as intermediary between the king and General Monk. Honours and emolument were his reward after the Restoration; he was appointed to the lucrative offices of first clerk of the board of green cloth and paymaster-general of the forces. In November 1661 he became member of parliament for Salisbury. In 1665 he was knighted, was returned as M.P. for Westminster on the 27th of February 1679, and succeeded the earl of Rochester as a commissioner of the treasury, filling that office for twenty-three years and during three reigns. In 1680 he resigned the paymastership and was made first commissioner of horse. In 1684 he became sole commissioner of horse. He was offered a peerage by James II., on condition of turning Roman Catholic, but refused, in spite of which he was allowed to retain his commissionerships. In 1685 he was again M. P. for Salisbury, and opposed the bill for a standing army supported by the king. During the Revolution he maintained an attitude of decent reserve, but on James's flight, submitted to William III., who confirmed him in his offices. He was again elected for Westminster in 1691 and 1695, for Cricklade in 1698, and finally in 1713 once more for Salisbury. He died on the 28th of October 1716. It is his distinction to have founded Chelsea hospital, and to have contributed £13,000 in aid of this laudable public work. Though his place as a statesman is in the second or even the third rank, yet he was a useful man in his generation, and a public servant who creditably discharged all the duties with which he was entrusted. Unlike other statesmen of his day, he grew rich in the service of the nation without being suspected of corruption, and without forfeiting the esteem of his contemporaries.

He was twice married (1651 and 1703); by his first wife, Elizabeth Whittle, he had seven sons, who predeceased him, and three daughters; by his second, Christian Hopes, he had two sons and two daughters. The elder son by the second marriage, Stephen (1704-1776), was created Lord Ilchester and Stavordale in 1747 and earl of Ilchester in 1756; in 1758 he took the additional name of Strangways, and his descendants, the family of Fox-Strangways, still hold the earldom of Ilchester. The younger son, Henry, became the 1st Lord Holland (*q.v.*).

FOX, SIR WILLIAM (1812-1893), New Zealand statesman, third son of George Townshend Fox, deputy-lieutenant for Durham county, was born in England on the 9th of June 1812, and educated at Wadham College, Oxford, where he took his degree in 1832. Called to the bar in 1842, he emigrated immediately thereafter to New Zealand, where, on the death of Captain Arthur Wakefield, killed in 1843 in the Wairau massacre, he became the New Zealand Company's agent for the South Island. While holding this position he made a memorable exploring march on foot from Nelson to Canterbury, through Cannibal Gorge, in the course of which he discovered the fertile pastoral country of Amuri. In 1848 Governor Grey made Fox attorney-general, but he gave up the post almost at once in order to join the agitation, then at its height, for a free constitu-

tion. As the political agent of the Wellington settlers he sailed to London in 1850 to urge their demands in Downing Street. The colonial office, however, refused to recognize him, and, after publishing a sketch of the New Zealand settlements, *The Six Colonies of New Zealand*, and travelling in the United States, he returned to New Zealand and again threw himself with energy into public affairs. When government by responsible ministers was at last initiated, in 1856, Fox ousted the first ministry and formed a cabinet, only to be himself beaten in turn after holding office but thirteen days. In 1861 he regained office, and was somewhat more fortunate, for he remained premier for nearly thirteen months. Again, in the latter part of 1863 he took office: this time with Sir Frederick Whitaker as premier, an arrangement which endured for another thirteen months. Fox's third premiership began in 1869 and lasted until 1872. His fourth, which was a matter of temporary convenience to his party, lasted only five weeks in March and April 1873. Soon afterwards he left politics, and, though he reappeared after some years and led the attack which overthrew Sir George Grey's ministry in 1879, he lost his seat in the dissolution which followed in that year and did not again enter parliament. He was made K.C.M.G. in 1880.

For the thirty years between 1850 and 1880 Sir William Fox was one of the half-dozen most notable public men in the colony. Impulsive and controversial, a fluent and rousing speaker, and a ready writer, his warm and sympathetic nature made him a good friend and a troublesome foe. He was considered for many years to be the most dangerous leader of the Opposition in the colony's parliament, though as premier he was at a disadvantage when measured against more patient and more astute party managers. His activities were first devoted to secure self-government for the New Zealand colonists. Afterwards his sympathies made him prominent among the champions of the Maori race, and he laboured indefatigably for their rights and to secure permanent peace with the tribes and a just settlement of their claims. It was during his third premiership that this peace, so long deferred, was at last gained, mainly through the influence and skill of Sir Donald M'Lean, native minister in the Fox cabinet. Finally, after Fox had left parliament he devoted himself, as joint-commissioner with Sir Francis Dillon Bell, to the adjustment of the native land-claims on the west coast of the North Island. The able reports of the commissioners were his last public service, and the carrying out of their recommendations gradually removed the last serious native trouble in New Zealand. When, however, in the course of the native wars from 1860 to 1870 the colonists of New Zealand were exposed to cruel and unjust imputations in England, Fox zealously defended them in a book, *The War in New Zealand* (1866), which was not only a spirited vindication of his fellow-settlers, but a scathing criticism of the generalship of the officers commanding the imperial troops in New Zealand. Throughout his life Fox was a consistent advocate of total abstinence. It was he who founded the New Zealand Alliance, and he undoubtedly aided the growth of the prohibition movement afterwards so strong in the colony. He died on the 23rd of June 1893, exactly twelve months after his wife, Sarah, daughter of William Halcombe. (W. P. R.)

FOX, a name (female, "vixen"¹) properly applicable to the single wild British representative of the family *Canidae* (see *CARNIVORA*), but in a wider sense used to denote fox-like species from all parts of the world, inclusive of many from South America which do not really belong to the same group. The fox was included by Linnaeus in the same genus with the dog and the wolf, under the name of *Canis vulpes*, but at the present day is regarded by most naturalists as the type of a separate genus, and should then be known as *Vulpes alopec* or *Vulpes vulpes*. From

¹ The word is common to the Teutonic languages, cf. Dutch *vos*, Ger. *Fuchs*; the ultimate origin is unknown, but a connexion has been suggested with Sanskrit *puccha*, tail. The feminine "vixen" represents the O. Eng. *fyxen*, due to the change from *o* to *y*, and addition of the feminine termination *-en*, cf. O. Eng. *gyden*, goddess, and Ger. *Füchsin*, vixen. The *v*, for *f*, is common in southern English pronunciation; *vox*, for fox, is found in the *Ancien Riwele*, c. 1230.

dogs, wolves, jackals, &c., which constitute the genus *Canis* in its more restricted sense, foxes are best distinguished by the circumstance that in the skull the (postorbital) projection immediately behind the socket for the eye has its upper surface concave, with a raised ridge in front, in place of regularly convex. Another character is the absence of a hollow chamber, or sinus, within the frontal bone of the forehead. Foxes are likewise distinguished by their slighter build, longer and bushy tail, which always exceeds half the length of the head and body, sharper muzzle, and relatively longer body and shorter limbs. Then again, the ears are large in proportion to the head, the pupil of the eye is elliptical and vertical when in a strong light, and the female has six pairs of teats, in place of the three to five pairs found in dogs, wolves and jackals. From the North American grey foxes, constituting the genus or subgenus *Urocyon*, the true foxes are distinguished by the absence of a crest of erectile long hairs along the middle line of the upper surface of the tail, and also of a projection (subangular process) to the postero-inferior angle of the lower jaw. With the exception of certain South African species, foxes differ from wolves and jackals in that they do not associate in packs, but go about in pairs or are solitary.

From the Scandinavian peninsula and the British Islands the range of the fox extends eastwards across Europe and central and northern Asia to Japan, while to the south it embraces northern Africa and Arabia, Persia, Baluchistan, and the north-western districts of India and the Himalaya. On the North American side of the Atlantic the fox reappears. With such an enormous geographical range the species must of necessity present itself under a considerable number of local phases, differing from one another to a greater or less degree in the matters of size and colouring. By some naturalists many of these local forms are regarded as specifically distinct, but it seems better and simpler to class them all as local phases or races of a single species primarily characterized by the white tip to the tail and the black or dark-brown hind surface of the ear. The "foxy red" colouring of the typical race of north-western Europe is too well known to require description. From this there is a more or less nearly complete gradation on the one hand to pale-coloured forms like the white-footed fox (*V. alopecurus leucopus*) of Persia, N.W. India and Arabia, and on the other to the silver or black fox (*V. a. argentatus*) of North America which yields the valuable silver-tipped black fur. Silver foxes apparently also occur in northern Asia.

To mention all the other local races would be superfluous, and it will suffice to note that the North African fox is known as *V. a. niloticus*, the Himalayan as *V. a. montanus*, the Tibetan as *V. a. wadelli*, the North American red or cross fox as *V. a. pennsylvanicus*, and the Alaskan as *V. a. harrimani*; the last named, like several other animals from Alaska, being the largest of its kind.

The cunning and stratagem of the fox have been proverbial for many ages, and he has figured as a central character in fables from the earliest times, as in Aesop, down to "Uncle Remus," most notably as Reynard (*Raginohardus*, strong in counsel) in the great medieval beast-epic "Reynard the Fox" (*q.v.*). It is not unlikely that, owing to the conditions under which it now lives, these traits are even more developed in England than elsewhere. In habits the fox is to a great extent solitary, and its home is usually a burrow, which may be excavated by its own labour, but is more often the usurped or deserted tenement of a badger or a rabbit. Foxes will, however, often take up their residence in woods, or even in water-meadows with large tussocks of grass, remaining concealed during the day and issuing forth on marauding expeditions at night. Rabbits, hares, domesticated poultry, game-birds, and, when these run short, rats, mice and even insects, form the chief diet of the fox. When living near the coast foxes will, however, visit the shore at low water in search of crabs and whelks; and the old story of the fox and the grapes seems to be founded upon a partiality on the part of the creature for that fruit. Flesh that has become tainted appears to be specially acceptable; but it is a curious fact that on no account will a fox eat any kind of bird of prey.

After a gestation of from 60 to 65 days, the vixen during the month of April gives birth to cubs, of which from five to eight usually go to form a litter. When first born these are clothed with a uniform slaty-grey fur, which in due course gives place to a coat of more tawny hue than the adult livery. In a year and a half the cubs attain their full development; and from observations on captive specimens it appears that the duration of life ought to extend to some thirteen or fourteen years. In the care and defence of her young the vixen displays extraordinary solicitude and boldness, altogether losing on such occasions her accustomed timidity and caution. Like most other young animals, fox-cubs are exceedingly playful, and may be seen chasing one another in front of the mouth of the burrow, or even running after their own tails.

Young foxes can be tamed to a certain extent, and do not then emit the well-known odour to any great degree unless excited. The species cannot, however, be completely domesticated, and never displays the affectionate traits of the dog. It was long believed that foxes and dogs would never interbreed; but several instances of such unions have been recorded, although they are undoubtedly rare. When suddenly confronted in a situation where immediate escape is impossible, the fox, like the wolf, will not hesitate to resort to the death-feigning instinct. Smartness in avoiding traps is one of the most distinctive traits in the character of the species; but when a trap has once claimed its victim, and is consequently no longer dangerous, the fox is always ready to take advantage of the gratuitous meal.

Red fox-skins are largely imported into Europe for various purposes, the American imports alone formerly reaching as many as 60,000 skins annually. Silver fox is one of the most valuable of all furs, as much as £480 having been given for an unusually fine pair of skins in 1902.

Of foxes certainly distinct specifically from the typical representative of the group, one of the best known is the Indian *Vulpes bengalensis*, a species much inferior in point of size to its European relative, and lacking the strong odour of the latter, from which it is also distinguished by the black tip to the tail and the pale-coloured backs of the ears. The corsac fox (*V. corsac*), ranging from southern Russia and the Caspian provinces across Asia to Amurland, may be regarded as a northern representative of the Indian species; while the pale fox (*V. pallidus*), of the Suakin and Dongola deserts, may be regarded as the African representative of the group. Possibly the kit-fox (*V. velox*), which has likewise a black tail-tip and pale ears, may be the North American form of the same group. The northern fennec (*V. famelicus*), whose range extends apparently from Egypt and Somaliland through Palestine and Persia into Afghanistan, seems to form a connecting link between the more typical foxes and the small African species properly known as fennecs. The long and bushy tail in the northern species has a white tip and a dark gland-patch near the root, but the backs of the ears are fawn-coloured. The enormous length of the ears and the small bodily size (inferior to that of any other member of the family) suffice to distinguish the true fennec (*V. zerda*) of Algeria and Egypt, in which the general colour is pale and the tip of the relatively short tail black. South of the Zambezi the group reappears in the shape of the asse-fox or fennec (*V. cama*), a dark-coloured species, with a black tip to the long, bushy tail and reddish-brown ears.

Passing from South Africa to the north polar regions of both the Old and the New World, inclusive of Iceland, we enter the domain of the Arctic fox (*V. lagopus*), a very distinct species characterized by the hairy soles of its feet, the short, blunt ears, the long, bushy tail, and the great length of the fur in winter. The upper parts in summer are usually brownish and the under parts white; but in winter the whole coat, in this phase of the species, turns white. In a second phase of the species, the colour, which often displays a slaty hue (whence the name of blue fox), remains more or less the same throughout the year, the winter coat being, however, recognizable by the great length of the fur. Many at least of the "blue fox" skins of the fur-trade are white skins dyed. About 2000 blue fox-skins were

annually imported into London from Alaska some five-and-twenty years ago. Arctic foxes feed largely on sea-birds and lemmings, laying up hidden stores of the last-named rodents for winter use.

The American grey fox, or Virginian fox, is now generally ranged as a distinct genus (or a subgenus of *Canis*) under the name of *Urocyon cinereo-argentatus*, on account of being distinguished, as already mentioned, by the presence of a ridge of long erectile hairs along the upper surface of the tail and of a projection to the postero-inferior angle of the lower jaw. The prevailing colour of the fur of the upper parts is iron-grey.

The so-called foxes of South America, such as the crab-eating fox (*C. thous*), Azara's fox (*C. azarae*), and the colpeo (*C. magellanicus*), are aberrant members of the typical genus *Canis*. On the other hand, the long-eared fox or Delalande's fox (*Otocyon megalotis*) of south and east Africa represents a totally distinct genus.

See St George Mivart, *Dogs, Jackals, Wolves and Foxes* (London, 1890); R. I. Pocock, "Ancestors and Relatives of the Dog," in *The Kennel Encyclopaedia* (London, 1907). For fox-hunting, see HUNTING. (R. L.*)

FOXE, JOHN (1516-1587), the author of the famous *Book of Martyrs*, was born at Boston, in Lincolnshire, in 1516. At the age of sixteen he is said to have entered Brasenose College, Oxford, where he was the pupil of John Harding or Hawarden, and had for room-mate Alexander Nowell, afterwards dean of St. Paul's. His authenticated connexion at the university is, however, with Magdalen College. He took his B.A. degree in 1537 and his M.A. in 1543. He was lecturer on logic in 1540-1541. He wrote several Latin plays on Scriptural subjects, of which the best, *De Christo triumphante*, was repeatedly printed, (London, 1551; Basel, 1556, &c.), and was translated into English by Richard Day, son of the printer. He became a fellow of Magdalen College in 1539, resigning in 1545. It is said that he refused to conform to the rules for regular attendance at chapel, and that he protested both against the enforced celibacy of fellows and the obligation to take holy orders within seven years of their election. The customary statement that he was expelled from his fellowship is based on the untrustworthy biography attributed to his son Samuel Foxe, but the college records state that he resigned of his own accord and *ex honesta causa*. The letter in which he protests to President Oglethorpe against the charges of irreverence, &c., brought against him is printed in Pratt's edition (vol. i. Appendix, pp. 58-61).

On leaving Oxford he acted as tutor for a short time in the house of the Lucys of Charlecote, near Stratford-on-Avon, where he married Agnes Randall. Late in 1547 or early in the next year he went to London. He found a patron in Mary Fitzroy, duchess of Richmond, and having been ordained deacon by Ridley in 1550, he settled at Reigate Castle, where he acted as tutor to the duchess's nephews, the orphan children of Henry Howard, earl of Surrey. On the accession of Queen Mary, Foxe was deprived of his tutorship by the boys' grandfather, the duke of Norfolk, who was now released from prison. He retired to Strassburg, and occupied himself with a Latin history of the Christian persecutions which he had begun at the suggestion of Lady Jane Grey. He had assistance from two clerics of widely differing opinions—from Edmund Grindal, who was later, as archbishop of Canterbury, to maintain his Puritan convictions in opposition to Elizabeth; and from John Aylmer, afterwards one of the bitterest opponents of the Puritan party. This book, dealing chiefly with Wycliffe and Huss, and coming down to 1500, formed the first outline of the *Actes and Monuments*. It was printed by Wendelin Richelius with the title of *Commentarii rerum in ecclesia gestarum* (Strasburg, 1554). In the year of its publication Foxe removed to Frankfort, where he found the English colony of Protestant refugees divided into two camps. He made a vain attempt to frame a compromise which should be accepted by the extreme Calvinists and by the partisans of the Anglican doctrine. He removed (1555) to Basel, where he worked as printer's reader to Johann Herbst or Oporinus. He made steady progress with his great book as he received

reports from England of the religious persecutions there, and he issued from the press of Oporinus his pamphlet *Ad inclytos ac praepotentes Angliae proceres . . . supplicatio* (1557), a plea for toleration addressed to the English nobility. In 1559 he completed the Latin edition¹ of his martyrology and returned to England. He lived for some time at Aldgate, London, in the house of his former pupil, Thomas Howard, now duke of Norfolk, who retained a sincere regard for his tutor and left him a small pension in his will. He became associated with John Day the printer, himself once a Protestant exile. Foxe was ordained priest by Edmund Grindal, bishop of London, in 1560, and besides much literary work he occasionally preached at Paul's Cross and other places. His work had rendered great service to the government, and he might have had high preferment in the Church but for the Puritan views which he consistently maintained. He held, however, the prebend of Shipton in Salisbury cathedral, and is said to have been for a short time rector of Cripplegate.

In 1563 was issued from the press of John Day the first English edition of the *Actes and Monuments of these latter and perillous Dayes, touching matters of the Church, whercin are comprehended and described the great Persecution and horrible Troubles that have been wrought and practised by the Romishe Prelates, speciallye in this Realme of England and Scotland, from the yeare of our Lorde a thousande to the time now present. Gathered and collected according to the true Copies and Wrytinges certificatorie as well of the Parties themselves that Suffered, as also out of the Bishop's Registers, which were the Doers thereof, by John Foxe*, commonly known as the *Book of Martyrs*. Several gross errors which had appeared in the Latin version, and had been since exposed, were corrected in this edition. Its popularity was immense and signal. The Marian persecution was still fresh in men's minds, and the graphic narrative intensified in its numerous readers the fierce hatred of Spain and of the Inquisition which was one of the master passions of the reign. Nor was its influence transient. For generations the popular conception of Roman Catholicism was derived from its bitter pages. Its accuracy was immediately attacked by Catholic writers, notably in the *Dialogi sex* (1566), nominally from the pen of Alan Cope, but in reality by Nicholas Harpsfield and by Robert Parsons in *Three Conversions of England* (1570). These criticisms induced Foxe to produce a second corrected edition, *Ecclesiastical History, containyng the Actes and Monuments of things passed in every kynges tyme . . .* in 1570, a copy of which was ordered by Convocation to be placed in every collegiate church. Foxe based his accounts of the martyrs partly on authentic documents and reports of the trials, and on statements received direct from the friends of the sufferers, but he was too hasty a worker and too violent a partisan to produce anything like a correct or impartial account of the mass of facts with which he had to deal. Anthony à Wood says that Foxe "believed and reported all that was told him, and there is every reason to suppose that he was purposely misled, and continually deceived by those whose interest it was to bring discredit on his work," but he admits that the book is a monument of his industry, his laborious research and his sincere piety. The gross blunders due to carelessness have often been exposed, and there is no doubt that Foxe was only too ready to believe evil of the Catholics, and he cannot always be exonerated from the charge of wilful falsification of evidence. It should, however, be remembered in his honour that his advocacy of religious toleration was far in advance of his day. He pleaded for the despised Dutch Anabaptists, and remonstrated with John Knox on the rancour of his *First Blast of the Trumpet*. Foxe was one of the earliest students of Anglo-Saxon, and he and Day published an edition of the Saxon gospels under the patronage of Archbishop Parker. He died on the 18th of April 1587 and was buried at St Giles's, Cripplegate.

¹ Printed by Oporinus and Nicolaus Brylinger. The title is *Rerum in ecclesia gestarum . . . pars prima, in qua primum de rebus per Angliam et Scotiam gestis atque in primis de horrenda sub Maria nuper regina persecutione narratio continetur*.

A list of his Latin tracts and sermons is given by Wood, and others, some of which were never printed, appear in Bale. Four editions of the *Actes and Monuments* appeared in Foxe's lifetime. The eighth edition (1641) contains a memoir of Foxe purporting to be by his son Samuel, the MS. of which is in the British Museum (Lansdowne MS. 388). Samuel Foxe's authorship is disputed, with much show of reason, by Dr S. R. Maitland in *On the Memoirs of Foxe ascribed to his Son* (1841). The best-known modern edition of the Martyrology is that (1837-1841) by the Rev. Stephen R. Cattley, with an introductory life by Canon George Townsend. The numerous inaccuracies of this life and the frequent errors of Foxe's narrative were exposed by Dr Maitland in a series of tracts (1837-1842), collected (1841-1842) as *Notes on the Contributions of the Rev. George Townsend, M.A. . . . to the New Edition of Fox's Martyrology*. The criticism lavished on Cattley and Townsend's edition led to a new one (1846-1849) under the same editorship. A new text prepared by the Rev. Josiah Pratt was issued (1870) in the "Reformation Series" of the *Church Historians of England*, with a revised version of Townsend's *Life* and appendices giving copies of original documents. Later edition by W. Grinton Berry (1907).

Foxe's papers are preserved in the Harleian and Lansdowne collections in the British Museum. Extracts from these were edited by J. G. Nichols for the Camden Society (1859). See also W. Winters, *Biographical Notes on John Foxe* (1876); James Gairdner, *History of the English Church in the Sixteenth Century*.

FOXGLOVE, a genus of biennial and perennial plants of the natural order Scrophulariaceae. The common or purple foxglove,

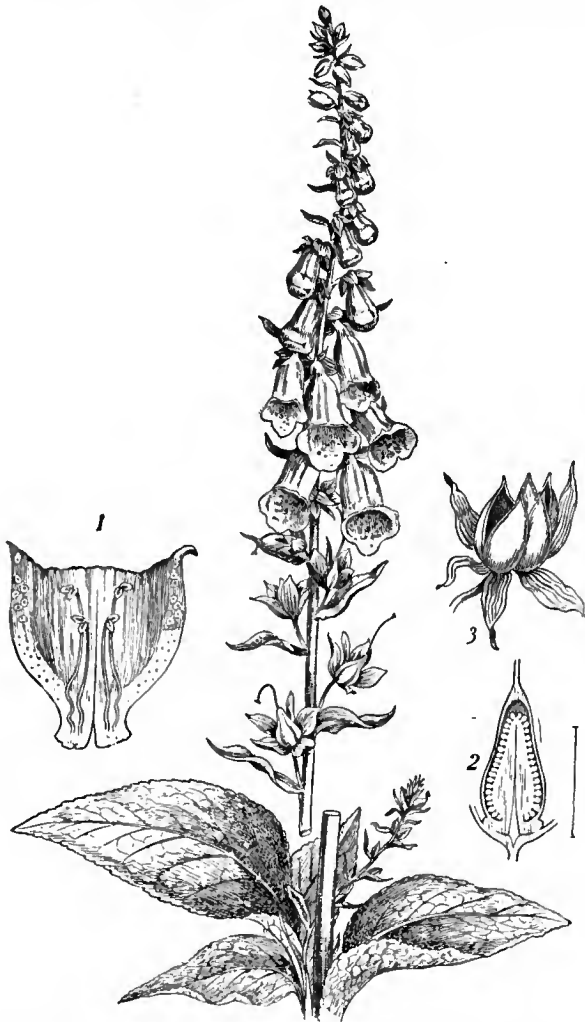

Foxglove (*Digitalis purpurea*), one-third nat. size.

1. Corolla cut open showing the four stamens; rather more than half nat. size.
2. Unripe fruit cut lengthwise,
3. Ripe capsule split open, showing the thick axial placenta bearing numerous small seeds.

D. purpurea, is common in dry hilly pastures and rocky places and by road-sides in various parts of Europe; it ranges in Great Britain from Cornwall and Kent to Orkney, but it does not occur in Shetland or in some of the eastern counties of England.

It flourishes best in siliceous soils, and is not found in the Jura and Swiss Alps. The characters of the plant are as follows: stem erect, roundish, downy, leafy below, and from 18 in. to 5 ft. or more in height; leaves alternate, crenate, rugose, ovate or elliptic oblong, and of a dull green, with the under surface downy and paler than the upper; radical leaves together with their stalks often a foot in length; root of numerous, slender, whitish fibres; flowers $1\frac{3}{4}$ - $2\frac{1}{2}$ in. long, pendulous, on one side of the stem, purplish crimson, and hairy and marked with eye-like spots within; segments of calyx ovate, acute, cleft to the base; corolla bell-shaped with a broadly two-lipped obtuse mouth, the upper lip entire or obscurely divided; stamens four, two longer than the other two (*didynamous*); anthers yellow and bilobed; capsule bivalved, ovate and pointed; and seeds numerous, small, oblong, pitted and of a pale brown. As Parkinson remarks of the plant, "It flowreth seldome before July, and the seed is ripe in August"; but it may occasionally be found in blossom as late as September. Many varieties of the common foxglove have been raised by cultivation, with flowers varying in colour from white to deep rose and purple; in the variety *gloxinioides* the flowers are almost regular, suggesting those of the cultivated gloxinia. Other species of foxglove with variously coloured flowers have been introduced into Britain from the continent of Europe. The plants may be propagated by unflowered off-sets from the roots, but being biennials are best raised from seed.

The foxglove, probably from folks'-glove, that is fairies' glove, is known by a great variety of popular names in Britain. In the south of Scotland it is called bloody fingers; farther north, dead-men's-bells; and on the eastern borders, ladies' thimbles, wild mercury and Scotch mercury. In Ireland it is generally known under the name of fairy thimble. Among its Welsh synonyms are *menyg-cllyllon* (elves' gloves), *menyg y llwynog* (fox's gloves), *bysedd cochion* (redfingers) and *bysedd y cwn* (dog's fingers). In France its designations are *gants de notre dame* and *doigts de la Vierge*. The German name *Fingerhut* (thimble) suggested to Fuchs, in 1542, the employment of the Latin adjective *digitalis* as a designation for the plant. Other species of foxglove or *Digitalis* although found in botanical collections are not generally grown. For medicinal uses see DIGITALIS.

FOX INDIANS, the name, from one of their clans, of an Algonquian tribe, whose former range was central Wisconsin. They call themselves Muskwakiuk, "red earth people." Owing to heavy losses in their wars with the Ojibways and the French, they allied themselves with the Sauk tribe about 1780, the two tribes being now practically one.

FOX MORCILLO, SEBASTIAN (1526?-1559?), Spanish scholar and philosopher, was born at Seville between 1526 and 1528. About 1548 he studied at Louvain, and, following the example of the Spanish Jew, Judas Abarbanel, published commentaries on Plato and Aristotle in which he endeavoured to reconcile their teaching. In 1559 he was appointed tutor to Don Carlos, son of Philip II., but did not live to take up the duties of the post, as he was lost at sea on his way to Spain. His most original work is the *De imitatione, seu de informandi styli ratione libri II.* (1554), a dialogue in which the author and his brother take part under the pseudonyms of Gaspar and Francisco Enuesia. Among Fox Morcillo's other publications are: (1) *In Topica Ciceronis paraphrasis et scholia* (1550); (2) *In Platonis Timaeum commentarii* (1554); (3) *Compendium ethices philosophiae ex Platone, Aristotele, aliisque philosophis collectum*; (4) *De historiae institutione dialogus* (1557), and (5) *De naturae philosophia*.

He is the subject of an excellent monograph by Urbano Gonzalez de Calle, *Sebastián Fox Morcillo: estudio histórico-crítico de sus doctrinas* (Madrid, 1903).

FOY, MAXIMILIEN SÉBASTIEN (1775-1825), French general and statesman, was born at Ham in Picardy on the 3rd of February 1775. He was the son of an old soldier who had fought at Fontenoy and had become post-master of the town in which he lived. His father died in 1780, and his early instruction was given by his mother, a woman of English origin and of

superior ability. He continued his education at the college of Soissons, and thence passed at the age of fifteen to the artillery school of La Fère. After eighteen months' successful study he entered the army, served his first campaign in Flanders (1791-92), and was present at the battle of Jemmapes. He soon attained the rank of captain, and served successively under Dampierre, Jourdan, Pichegru and Houchard. In 1794, in consequence of having spoken freely against the violence of the extreme party at Paris, he was imprisoned by order of the commissioner of the Convention, Joseph Lebon, at Cambrai, but regained his liberty soon after the fall of Robespierre. He served under Moreau in the campaigns of 1796 and 1797, distinguishing himself in many engagements. The leisure which the treaty of Campo Formio gave him he devoted to the study of public law and modern history, attending the lectures of Christoph Wilhelm von Koch (1737-1813), the famous professor of public law at Strassburg. He was recommended by Desaix to the notice of General Bonaparte, but declined to serve on the staff of the Egyptian expedition. In the campaign of Switzerland (1798) he distinguished himself afresh, though he served only with the greatest reluctance against a people which possessed republican institutions. In Masséna's brilliant campaign of 1799 Foy won the rank of *chef de brigade*. In the following year he served under Moncey in the Marengo campaign and afterwards in Tirol.

Foy's republican principles caused him to oppose the gradual rise of Napoleon to the supreme power and at the time of Moreau's trial he escaped arrest only by joining the army in Holland. Foy voted against the establishment of the empire, but the only penalty for his independence was a long delay before attaining the rank of general. In 1806 he married a daughter of General Baraguay d'Hilliers. In the following year he was sent to Constantinople, and there took part in the defence of the Dardanelles against the English fleet. He was next sent to Portugal, and thenceforward he served in the Peninsular War from first to last. Under Junot he won at last his rank of general of brigade, under Soult he held a command in the pursuit of Sir John Moore's army, and under Masséna he fought in the third invasion of Portugal (1810). Masséna reposed the greatest confidence in Foy, and employed him after Busaco in a mission to the emperor. Napoleon now made Foy's acquaintance for the first time, and was so far impressed with his merits as to make him a general of division at once. The part played by General Foy at the battle of Salamanca won him new laurels, but above all he distinguished himself when the disaster of Vittoria had broken the spirit of the army. Foy rose to the occasion; his resistance in the Pyrenees was steady and successful, and only a wound (at first thought mortal) which he received at Orthez prevented him from keeping the field to the last. At the first restoration of the Bourbons he received the grand cross of the Legion of Honour and a command, and on the return of Napoleon from Elba he declined to join him until the king had fled from the country. He held a divisional command in the Waterloo campaign, and at Waterloo was again severely wounded at the head of his division (see WATERLOO CAMPAIGN). After the second restoration he returned to civil life, devoting his energies for a time to his projected history of the Peninsular War, and in 1819 was elected to the chamber of deputies. For this position his experience and his studies had especially fitted him, and by his first speech he gained a commanding place in the chamber, which he never lost, his clear, manly eloquence being always employed on the side of the liberal principles of 1789. In 1823 he made a powerful protest against French intervention in Spain, and after the dissolution of 1824 he was re-elected for three constituencies. He died at Paris on the 28th of November 1825, and his funeral was attended, it is said, by 100,000 persons. His early death was regarded by all as a national calamity. His family was provided for by a general subscription.

The *Histoire de la guerre de la Péninsule sous Napoléon* was published from his notes in 1827, and a collection of his speeches (with memoir by Tissot) appeared in 1826 soon after his death. See Cuisin, *Vie militaire, politique, &c., du général Foy*; Vidal, *Vie militaire et politique du général Foy*.

FRAAS, KARL NIKOLAS (1810-1875), German botanist and agriculturist, was born at Rattelsdorf, near Bamberg, on the 8th of September 1810. After receiving his preliminary education at the gymnasium of Bamberg, he in 1830 entered the university of Munich, where he took his doctor's degree in 1834. Having devoted great attention to the study of botany, he went to Athens in 1835 as inspector of the court garden; and in April 1836 he became professor of botany at the university. In 1842 he returned to Germany and became teacher at the central agricultural school at Schleissheim. In 1847 he was appointed professor of agriculture at Munich, and in 1851 director of the central veterinary college. For many years he was secretary of the Agricultural Society of Bavaria, but resigned in 1861. He died at his estate of Neufreimann, near Munich, on the 9th of November 1875.

His principal works are: *Στοιχεία τῆς Βοτανικῆς* (Athens, 1835); *Synopsis florae classicae* (Munich, 1845); *Klima und Pflanzenwelt in der Zeit* (Landsh., 1847); *Histor.-encyklopädi. Grundriss der Landwirthschaftslehre* (Stuttgart, 1848); *Geschichte der Landwirthschaft* (Prague, 1851); *Die Schule des Landbaues* (Munich, 1852); *Baierns Rinderrassen* (Munich, 1853); *Die künstliche Fischerzeugung* (Munich, 1854); *Die Natur der Landwirthschaft* (Munich, 1857); *Buch der Natur für Landwirthe* (Munich, 1860); *Die Ackerbauweisen und ihre Heilmittel* (Munich, 1866); *Das Wurzelleben der Culturpflanzen* (Berlin, 1872); and *Geschichte der Landbau und Forstwissenschaft seit dem 16^{ten} Jahrh.* (Munich, 1865). He also founded and edited a weekly agricultural paper, the *Schranne*.

FRACASTORO [FRACASTORIUS], GIROLAMO [HIERONYMUS] (1483-1553), Italian physician and poet, was born at Verona in 1483. It is related of him that at his birth his lips adhered so closely that a surgeon was obliged to divide them with his incision knife, and that during his infancy his mother was killed by lightning, while he, though in her arms at the moment, escaped unhurt. Fracastoro became eminently skilled, not only in medicine and belles-lettres, but in most arts and sciences. He studied at Padua, and became professor of philosophy there in 1502, afterwards practising as a physician in Verona. It was by his advice that Pope Paul III., on account of the prevalence of a contagious distemper, removed the council of Trent to Bologna. He was the author of many works, both poetical and medical, and was intimately acquainted with Cardinal Bembo, Julius Scaliger, Gianbattista Ramusio (*q.v.*), and most of the great men of his time. In 1517, when the builders of the citadel of San Felice (Verona) found fossil mussels in the rocks, Fracastoro was consulted about the marvel, and he took the same view—following Leonardo da Vinci, but very advanced for those days—that they were the remains of animals once capable of living in the locality. He died of apoplexy at Casi, near Verona, on the 8th of August 1553; and in 1559 the town of Verona erected a statue in his honour.

The principal work of Fracastoro is a kind of medical poem entitled *Syphilidis, sive Morbi Gallici, libri tres* (Verona, 1530), which has been often reprinted and also translated into French and Italian. Among his other works (all published at Venice) are *De vini temperatura* (1534); *Homocentricorum* (1535); *De sympathia et antipathia rerum* (1546); and *De contagionibus* (1546). His complete works were published at Venice in 1555, and his poetical productions were collected and printed at Padua in 1728.

FRAGONARD, JEAN-HONORÉ (1732-1806), French painter, was born at Grasse, the son of a glover. He was articled to a Paris notary when his father's circumstances became straitened through unsuccessful speculations, but he showed such talent and inclination for art that he was taken at the age of eighteen to Boucher, who, recognizing the youth's rare gifts but disinclined to waste his time with one so inexperienced, sent him to Chardin's atelier. Fragonard studied for six months under the great luminaist, and then returned more fully equipped to Boucher, whose style he soon acquired so completely that the master entrusted him with the execution of replicas of his paintings. Though not a pupil of the Academy, Fragonard gained the Prix de Rome in 1752 with a painting of "Jeroboam sacrificing to the Idols," but before proceeding to Rome he continued to study for three years under Van Loo. In the year preceding his departure he painted the "Christ washing the Feet of the Apostles" now at Grasse cathedral. In 1755 he took up his abode at the French Academy in Rome, then presided over by Natoire. There he

benefited from the study of the old masters whom he was set to copy—always remembering Boucher's parting advice not to take Raphael and Michelangelo too seriously. He successively passed through the studios of masters as widely different in their aims and technique as Chardin, Boucher, Van Loo and Natoire, and a summer sojourn at the Villa d'Este in the company of the abbé de Saint-Non, who engraved many of Fragonard's studies of these entrancing gardens, did more towards forming his personal style than all the training at the various schools. It was in these romantic gardens, with their fountains, grottos, temples and terraces, that he conceived the dreams which he was subsequently to embody in his art. Added to this influence was the deep impression made upon his mind by the florid sumptuousness of Tiepolo, whose works he had an opportunity of studying in Venice before he returned to Paris in 1761. In 1765 his "Corésus et Callirhoé" secured his admission to the Academy. It was made the subject of a pompous eulogy by Diderot, and was bought by the king, who had it reproduced at the Gobelins factory. Hitherto Fragonard had hesitated between religious, classic and other subjects; but now the demand of the wealthy art patrons of Louis XV.'s pleasure-loving and licentious court turned him definitely towards those scenes of love and voluptuousness with which his name will ever be associated, and which are only made acceptable by the tender beauty of his colour and the virtuosity of his facile brushwork—such works as the "Serment d'amour" (Love Vow), "Le Verrou" (The Bolt), "La Culbute" (The Tumble), "La Chemise enlevée" (The Shift Withdrawn), and "The Swing" (Wallace collection), and his decorations for the apartments of Mme du Barry and the dancer Marie Guimard.

The Revolution made an end to the *ancien régime*, and Fragonard, who was so closely allied to its representatives, left Paris in 1793 and found shelter in the house of his friend Maubert at Grasse, which he decorated with the series of decorative panels known as the "Roman d'amour de la jeunesse," originally painted for Mme du Barry's pavilion at Louvreciennes. The panels in recent years came into the possession of Mr Pierpont Morgan. Fragonard returned to Paris early in the 19th century, where he died in 1806, neglected and almost forgotten. For half a century or more he was so completely ignored that Lübke, in his history of art (1873), omits the very mention of his name. But within the last thirty years he has regained the position among the masters of painting to which he is entitled by his genius. If the appreciation of his art by the modern collector can be expressed in figures, it is significant that the small and sketchy "Billet Doux," which appeared at the Cronier sale in Paris in 1905 and was subsequently exhibited by Messrs Duveen in London (1906), realized close on £19,000 at the Hôtel Drouot.

Besides the works already mentioned, there are four important pictures by Fragonard in the Wallace collection: "The Fountain of Love," "The Schoolmistress," "A Lady carving her Name on a Tree" (usually known as "Le Chiffre d'amour") and "The Fair-haired Child." The Louvre contains thirteen examples of his art, among them the "Corésus," "The Sleeping Bacchante," "The Shift Withdrawn," "The Bathers," "The Shepherd's Hour" ("L'Heure du berger"), and "Inspiration." Other works are in the museums of Lille, Besançon, Rouen, Tours, Nantes, Avignon, Amiens, Grenoble, Nancy, Orleans, Marseilles, &c., as well as at Chantilly. Some of Fragonard's finest work is in the private collections of the Rothschild family in London and Paris.

See R. Portalis, *Fragonard* (Paris, 1899), fully illustrated; Felix Naquet, *Fragonard* (Paris, 1890); Virgile Jozs, *Fragonard—mœurs du XVIII^e siècle* (Paris, 1901); E. and J. de Goncourt, *L'Art du dix-huitième siècle—Fragonard* (Paris, 1883). (P. G. K.)

FRAHN, CHRISTIAN MARTIN (1782-1851), German numismatist and historian, was born at Rostock. He began his Oriental studies under Tychem at the university of Rostock, and afterwards prosecuted them at Göttingen and Tübingen. He became a Latin master in Pestalozzi's famous institute in 1804, returned home in 1806, and in the following year was chosen to fill the chair of Oriental languages in the Russian university of Kazan. Though in 1815 he was invited to succeed Tychem at

Rostock, he preferred to go to St Petersburg, where he became director of the Asiatic museum and councillor of state. He died at St Petersburg.

Frahn wrote over 150 works. Among the more important are: *Numophylacium orientale Pototianum* (1813); *De numorum Bulgharicorum fonte antiquissimo* (1816); *Das muhammedanische Münzkabinett des asiatischen Museum der kaiserl. Akademie der Wissenschaften zu St Petersburg* (1821); *Numi cufici ex variis museis selecti* (1823); *Notice d'une centaine d'ouvrages arabes, &c., qui manquent en grande partie aux bibliothèques de l'Europe* (1834); and *Nova supplementa ad recensioem Num. Muham. Acad. Imp. Sci. Petropolitanae* (1855). His description of some medals struck by the Samanid and Buidid princes (1804) was composed in Arabic because he had no Latin types.

FRAME, a word employed in many different senses, signifying something joined together or shaped. It is derived ultimately from O.E. *fram*, from, in its primary meaning "forward." In constructional work it connotes the union of pieces of wood, metal or other material for purposes of enclosure as in the case of a picture or mirror frame. Frames intended for these uses are of great artistic interest but comparatively modern origin. There is no record of their existence earlier than the 16th century, but the decorative opportunities which they afforded caused speedy popularity in an artistic age, and the Renaissance found in the picture frame a rich and attractive means of expression. The impulses which made frames beautiful have long been extinct or dormant, but fine work was produced in such profusion that great numbers of examples are still extant. Frames for pictures or mirrors are usually square, oblong, round or oval, and, although they have usually been made of wood or composition overlaid upon wood, the richest and most costly materials have often been used. Ebony, ivory and tortoiseshell; crystal, amber and mother-of-pearl; lacquer, gold and silver, and almost every other metal have been employed for this purpose. The domestic frame has in fact varied from the simplest and cheapest form of a plain wooden moulding to the most richly carved examples. The introduction in the 17th century of larger sheets of glass gave the art of frame-making a great *essor*, and in the 18th century the increased demand for frames, caused chiefly by the introduction of cheaper forms of mirrors, led to the invention of a composition which could be readily moulded into stereotyped patterns and gilded. This was eventually the deathblow of the artistic frame, and since the use of composition moulding became normal, no important school of wood-carving has turned its attention to frames. The carvers of the Renaissance, and down to the middle of the 18th century, produced work which was often of the greatest beauty and elegance. In England nothing comparable to that of Grinling Gibbons and his school has since been produced. Chippendale was a great frame maker, but he not only had recourse to composition, but his designs were often extravagantly rococo. Even in France there has been no return of the great days when Oeben enclosed the looking-glasses which mirrored the Pompadour in frames that were among the choicest work of a gorgeous and artificial age. In the decoration of frames as in so many other respects France largely followed the fashions of Italy, which throughout the 16th and 17th centuries produced the most elaborate and grandiose, the richest and most palatial, of the mirror frames that have come down to us. English art in this respect was less exotic and more restrained, and many of the mirrors of the 18th century received frames the grace and simplicity of which have ensured their constant reproduction even to our own day.

FRAMINGHAM, a township of Middlesex county, Massachusetts, U.S.A., having an area of 27 sq. m. of hilly surface, dotted with lakes and ponds. Pop. (1890) 9239; (1900) 11,302, of whom 2391 were foreign-born; (1910 census) 12,948. It is served by the Boston & Albany, and the New York, New Haven & Hartford railways. Included within the township are three villages, Framingham Center, Saxonville and South Framingham, the last being much the most important. Framingham Academy was established in 1792, and in 1851 became a part of the public school system. A state normal school (the first normal school in the United States, established at Lexington

in 1839, removed to Newton in 1844 and to Framingham in 1853) is situated here; and near South Framingham, in the township of Sherborn, is the state reformatory prison for women. South Framingham has large manufactories of paper tags, shoes, boilers, carriage wheels and leather board; formerly straw braid and bonnets were the principal manufactures. Saxonville manufactures worsted cloth. The value of the township's factory products increased from \$3,007,301 in 1900 to \$4,173,579 in 1905, or 38·8%. Framingham was first settled about 1640, and was named in honour of the English home (Framlingham) of Governor Thomas Danforth (1622–1699), to whom the land once belonged. In 1700 it was incorporated as a township. The "old Connecticut path," the Boston-to-Worcester turnpike, was important to the early fortunes of Framingham Center, while the Boston & Worcester railway (1834) made the greater fortune of South Framingham.

See J. H. Temple, *History of Framingham . . . 1640–1880* (Framingham, 1887).

FRAMLINGHAM, a market town in the Eye parliamentary division of Suffolk, 91 m. N.E. from London by a branch of the Great Eastern railway. Pop. (1901) 2526. The church of St Michael is a fine Perpendicular and Decorated building of black flint, surmounted by a tower 96 ft. high. In the interior there are a number of interesting monuments, among which the most noticeable are those of Thomas Howard, 3rd duke of Norfolk, and of Henry Howard, the famous earl of Surrey, who was beheaded by Henry VIII. The castle forms a picturesque ruin, consisting of the outer walls 44 ft. high and 8 ft. thick, 13 towers about 58 ft. high, a gateway and some outworks. About half a mile from the town is the Albert Memorial Middle Class College, opened in 1865, and capable of accommodating 300 boys. A bronze statue of the Prince Consort by Joseph Durham adorns the front terrace.

Framlingham (Frendlingham, Framalingaham) in early Saxon times was probably the site of a fortified earthwork to which St Edmund the Martyr is said to have fled from the Danes in 870. The Danes captured the stronghold after the escape of the king, but it was won back in 921, and remained in the hands of the crown, passing to William I. at the Conquest. Henry I. in 1100 granted it to Roger Bigod, who in all probability raised the first masonry castle. Hugh, son of Roger, created earl of Norfolk in 1141, succeeded his father, and the manor and castle remained in the Bigod family until 1306, when in default of heirs it reverted to the crown, and was granted by Edward II. to his half-brother Thomas de Brotherton, created earl of Norfolk in 1312. On an account roll of Framlingham Castle of 1324 there is an entry of "rent received from the borough," also of "rent from those living outside the borough," and in all probability burghal rights had existed at a much earlier date, when the town had grown into some importance under the shelter of the castle. Town and castle followed the vicissitudes of the dukedom of Norfolk, passing to the crown in 1405, and being alternately restored and forfeited by Henry V., Richard III., Henry VII., Edward VI., Mary, Elizabeth and James I., and finally sold in 1635 to Sir Robert Hitcham, who left it in 1636 to the master and fellows of Pembroke Hall, Cambridge.

In the account roll above mentioned reference is made to a fair and a market, but no early grant of either is to be found. In 1792 two annual fairs were held, one on Whit Monday, the other on the 10th of October; and a market was held every Saturday. The market day is still Saturday, but the fairs are discontinued.

See Robert Hawes, *History of Framlingham in the County of Suffolk*, edited by R. Loder (Woodbridge, 1798).

FRANC, a French coin current at different periods and of varying values. The first coin so called was one struck in gold by John II. of France in 1360. On it was the legend *Johannes Dei gracia Francorum rex*; hence, it is said, the name. It also bore an effigy of King John on horseback, from which it was called a *franc à cheval*, to distinguish it from another coin of the same value, issued by Charles V., on which the king was represented standing upright under a Gothic dais; this

coin was termed a *franc à pied*. As a coin it disappeared after the reign of Charles VI., but the name continued to be used as an equivalent for the *livre tournois*, which was worth twenty sols. French writers would speak without distinction of so many livres or so many francs, so long as the sum mentioned was an even sum; otherwise livre was the correct term, thus "*trois livres*" or "*trois francs*," but "*trois livres cinq sols*." In 1795 the livre was legally converted into the franc, at the rate of 81 livres to 80 francs, the silver franc being made to weigh exactly five grammes. The franc is now the unit of the monetary system and also the money of account in France, as well as in Belgium and Switzerland. In Italy the equivalent is the lira, and in Greece the drachma. The franc is divided into 100 centimes, the lira into 100 centesimi and the drachma into 100 lepta. Gold is now the standard, the coins in common use being ten and twenty franc pieces. The twenty franc gold piece weighs 6·4516 grammes, ·900 fine. The silver coins are five, two, one, and half franc pieces. The five franc silver piece weighs 25 grammes, ·900 fine, while the franc piece weighs 5 grammes, ·835 fine. See also MONEY.

FRANÇAIS, ANTOINE, COUNT (1756–1836), better known as FRANÇAIS OF NANTES, French politician and author, was born at Beaurepaire, in the department of Isère. In 1791 he was elected to the legislative assembly by the department of Loire Inférieure, and was noted for his violent attacks upon the farmers general, the pope and the priests; but he was not re-elected to the Convention. During the Terror, as he had belonged to the Girondin party, he was obliged to seek safety in the mountains. In 1798 he was elected to the council of Five Hundred by the department of Isère, and became one of its secretaries; and in the following year he voted against the Directory. He took office under the consulate as prefect of Charente Inférieure, rose to be a member of the council of state, and in 1804 obtained the important post of director-general of the indirect taxes (*droits réunis*). The value of his services was recognized by the titles of count of the empire and grand officer of the Legion of Honour. On the second restoration he retired into private life; but from 1819 to 1822 he was representative of the department of Isère, and after the July revolution he was made a peer of France. He died at Paris on the 7th of March 1836.

Français wrote a number of works, but his name is more likely to be preserved by the eulogies of the literary men to whom he afforded protection and assistance. It is sufficient to mention *Le Manuscrit de feu M. Jérôme* (1825); *Recueil de fadaises composé sur la montagne à l'usage des habitants de la plaine* (1826); *Voyage dans la vallée des originaux* (1828); *Tableau de la vie rurale, ou l'agriculture enseignée d'une manière dramatique* (1829).

FRANÇAIS, FRANÇOIS LOUIS (1814–1897), French painter, was born at Plombières (Vosges), and, on attaining the age of fifteen, was placed as office-boy with a bookseller. After a few years of hard struggle, during which he made a precarious living by drawing on stone and designing woodcut vignettes for book illustration, he studied painting under Gigoux, and subsequently under Corot, whose influence remained decisive upon Français's style of landscape painting. He generally found his subjects in the neighbourhood of Paris, and though he never rivalled his master in lightness of touch and in the lyric poetry which is the principal charm of Corot's work, he is still counted among the leading landscape painters of his country and period. He exhibited first at the Salon in 1837 and was elected to the Académie des Beaux-Arts in 1890. Comparatively few of his pictures are to be found in public galleries, but his painting of "An Italian Sunset" is at the Luxembourg Museum in Paris. Other works of importance are "Daphnis et Chloé" (1872), "Bas Meudon" (1861), "Orpheus" (1863), "Le Bois sacré" (1864), "Le Lac de Nemi" (1868).

FRANCATELLI, CHARLES ELMÉ (1805–1876), Anglo-Italian cook, was born in London, of Italian extraction, in 1805, and was educated in France, where he studied the art of cookery. Coming to England, he was employed successively by various noblemen, subsequently becoming manager of Crockford's club. He left Crockford's to become chief cook to Queen Victoria, and afterwards he was chef at the Reform Club. He was the

author of *The Modern Cook* (1845), which has since been frequently republished; of a *Plain Cookery Book for the Working Classes* (1861), and of *The Royal English and Foreign Confectionery Book* (1862). Francatelli died at Eastbourne on the 10th of August 1876.

FRANCAVILLA FONTANA, a town and episcopal see of Apulia, Italy, in the province of Lecce, 22 m. by rail E. by N. of Taranto, 460 ft. above sea-level. Pop. (1901) 17,759 (town); 20,510 (commune). It is in a fine situation, and has a massive square castle of the Umperiali family, to whom, with Oria, it was sold by S. Carlo Borromeo in the 16th century for 40,000 ounces of gold, which he distributed in one day to the poor.

FRANCE, ANATOLE (1844-), French critic, essayist and novelist (whose real name was Jacques Anatole Thibault), was born in Paris on the 16th of April 1844. His father was a bookseller, one of the last of the booksellers, if we are to believe the Goncourts, into whose establishment men came, not merely to order and buy, but to dip, and turn over pages and discuss. As a child he used to listen to the nightly talks on literary subjects which took place in his father's shop. Nurtured in an atmosphere so essentially bookish, he turned naturally to literature. In 1868 his first work appeared, a study of Alfred de Vigny, followed in 1873 by a volume of verse, *Les Poèmes dorés*, dedicated to Leconte de Lisle, and, as such a dedication suggests, an outcome of the "Parnassian" movement; and yet another volume of verse appeared in 1876, *Les Noces corinthiennes*. But the poems in these volumes, though unmistakably the work of a man of great literary skill and cultured taste, are scarcely the poems of a man with whom verse is the highest form of expression.

He was to find his richest vein in prose. He himself, avowing his preference for a simple, or seemingly simple, style as compared with the *artistique* style, vaunted by the Goncourts—a style compounded of neologisms and "rare" epithets, and startling forms of expression—observes: "A simple style is like white light. It is complex, but not to outward seeming. In language, a beautiful and desirable simplicity is but an appearance, and results only from the good order and sovereign economy of the various parts of speech." And thus one may say of his own style that its beautiful translucency is the result of many qualities—felicity, grace, the harmonious grouping of words, a perfect measure. Anatole France is a sceptic. The essence of his philosophy, if a spirit so light, evanescent, elusive, can be said to have a philosophy, is doubt. He is a doubter in religion, metaphysics, morals, politics, aesthetics, science—a most genial and kindly doubter, and not at all without doubts even as to his own negative conclusions. Sometimes his doubts are expressed in his own person—as in the *Jardin d'épicure* (1894) from which the above extracts are taken, or *Le Livre de mon ami* (1885), which may be accepted, perhaps, as partly autobiographical; sometimes, as in *La Rôtisserie de la reine Pédauque* (1893) and *Les Opinions de M. Jérôme Coignard* (1893), or *L'Orme du mail* (1897), *Le Mannequin d'osier* (1897), *L'Anneau d'améthyste* (1899), and *M. Bergeret à Paris* (1901), he entrusts the expression of his opinions, dramatically, to some fictitious character—the abbé Coignard, for instance, projecting, as it were, from the 18th century some very effective criticisms on the popular political theories of contemporary France—or the M. Bergeret of the four last-named novels, which were published with the collective title of *Histoire contemporaine*. This series deals with some modern problems, and particularly, in *L'Anneau d'améthyste* and *M. Bergeret à Paris*, with the humours and follies of the anti-Dreyfusards. All this makes a piquant combination. Neither should reference be omitted to his *Crime de Sylvestre Bonnard* (1881), crowned by the Institute, nor to works more distinctly of fancy, such as *Balthazar* (1889), the story of one of the Magi or *Thaïs* (1890), the story of an actress and courtesan of Alexandria, whom a hermit converts, but with the loss of his own soul. His ironic comedy, *Crainquebille* (Renaissance theatre, 1903), was founded on his novel (1902) of the same year. His more recent work includes his anti-clerical *Vie de Jeanne d'Arc* (1908); his pungent satire the *Île des péguins* (1908); and a volume of stories, *Les Sept Femmes de la Barbe-Bleue* (1909).

Lightly as he bears his erudition, it is very real and extensive, and is notably shown in his utilization of modern archaeological and historical research in his fiction (as in the stories in *Sur une pierre blanche*). As a critic—see the *Vie littéraire* (1888–1892), reprinted mainly from *Le Temps*—he is graceful and appreciative. Academic in the best sense, he found a place in the French Academy, taking the seat vacated by Lesseps, and was received into that body on the 24th of December 1896. In the *affaire Dreyfus* he sided with M. Zola.

For studies of M. Anatole France's talent see Maurice Barrès, *Anatole France* (1885); Jules Lemaitre, *Les Contemporains* (2nd series, 1886); and G. Brandes, *Anatole France* (1908). In 1908 Frederic Chapman began an edition of *The works of Anatole France in an English translation* (John Lane).

FRANCE, a country of western Europe, situated between 51° 5' and 42° 20' N., and 4° 42' W. and 7° 39' E. It is hexagonal in form, being bounded N.W. by the North Sea, the Strait of Dover (*Pas de Calais*) and the English Channel (*La Manche*), W. by the Atlantic Ocean, S.W. by Spain, S.E. by the Mediterranean Sea, E. by Italy, Switzerland and Germany, N.E. by Germany, Luxemburg and Belgium. From north to south its length is about 600 m., measured from Dunkirk to the Col de Falguères; its breadth from east to west is 528 m., from the Vosges to Cape Saint Mathieu at the extremity of Brittany. The total area is estimated¹ at 207,170 sq. m., including the island of Corsica, which comprises 3367 sq. m. The coast-line of France extends for 384 m. on the Mediterranean, 700 on the North Sea, the Strait of Dover and the Channel, and 865 on the Atlantic. The country has the advantage of being separated from its neighbours over the greater part of its frontier by natural barriers of great strength, the Pyrenees forming a powerful bulwark on the south-west, the Alps on the south-east, and the Jura and the greater portion of the Vosges Mountains on the east. The frontier generally follows the crest line of these ranges. Germany possesses both slopes of the Vosges north of Mont Donon, from which point the north-east boundary is conventional and unprotected by nature.

France is geographically remarkable for its possession of great natural and historical highways between the Mediterranean and the Atlantic Ocean. The one, following the depression between the central plateau and the eastern mountains by way of the valleys of the Rhône and Saône, traverses the Côte d'Or hills and so gains the valley of the Seine; the other, skirting the southern base of the Cévennes, reaches the ocean by way of the Garonne valley. Another natural highway, traversing the lowlands to the west of the central plateau, unites the Seine basin with that of the Garonne.

Physiography.—A line drawn from Bayonne through Agen, Poitiers, Troyes, Reims and Valenciennes divides the country roughly into two dissimilar physical regions—to the west and north-west a country of plains and low plateaus; in the centre, east and south-east a country of mountains and high plateaus with a minimum elevation of 650 ft. To the west of this line the only highlands of importance are the granitic plateaus of Brittany and the hills of Normandy and Perche, which, uniting with the plateau of Beauce, separate the basins of the Seine and Loire. The highest elevations of these ranges do not exceed 1400 ft. The configuration of the region east of the dividing line is widely different. Its most striking feature is the mountainous and eruptive area known as the Massif Central, which covers south-central France. The central point of this huge tract is formed by the mountains of Auvergne comprising the group of Cantal, where the Plomb du Cantal attains 6096 ft., and that of Mont Dore, containing the Puy de Sancy (6188 ft.), the culminating point of the Massif, and to the north the lesser elevations of the Monts Dôme. On the west the downward slope is gradual by way of lofty plateaus to the heights of Limousin and Marche and the table-land of Quercy, thence to the plains of Poitou, Angoumois and Guienne. On the east only river valleys divide the Auvergne mountains from those of Forez and Margeride, western spurs of the Cévennes. On the south the Aubrac mountains and the barren plateaus known as the Causses intervene between them and the Cévennes. The main range of the Cévennes (highest point Mont Lozère, 5584 ft.) sweeps in a wide curve from the granitic table-land of Morvan in the north along the right banks of the Saône and Rhône to the Montagne Noire in the south, where it is separated from the Pyrenean system by the river Aude. On the south-western border of France the Pyrenees include

¹ By the *Service géographique de l'armée*.



several peaks over 10,000 ft. within French territory; the highest elevation therein, the Vignemale, in the centre of the range, reaches 10,820 ft. On the north their most noteworthy offshoots are, in the centre, the plateau of Lannemezan from which rivers radiate fanwise to join the Adour and Garonne; and in the east the Corbière. On the south-eastern frontier the French Alps, which include Mont Blanc (15,800 ft.), and, more to the south, other summits over 11,000 ft. in height, cover Savoy and most of Dauphiné and Provence, that is to say, nearly the whole of France to the south and east of the Rhône. North of that river the parallel chains of the Jura form an arc of a circle with its convexity towards the north-west. In the southern and most elevated portion of the range there are several summits exceeding 5500 ft. Separated from the Jura by the defile of Belfort (Trouée de Belfort) the Vosges extend northward parallel to the course of the Rhine. Their culminating points in French territory, the Ballon d'Alsace and the Hühneck in the southern portion of the chain, reach 4100 ft. and 4480 ft. The Vosges are buttressed on the west by the Faucilles, which curve southwards to meet the plateau of Langres, and by the plateaus of Haute-

Marne, united to the Ardennes on the north-eastern frontier by the wooded highlands of Argonne.

Seaboard.—The shore of the Mediterranean encircling the Gulf of the Lion (Golfe du Lion) from Cape Cerbera to Martigues is low-lying and unbroken, and characterized chiefly by lagoons separated from the sea by sand-dunes. The coast, constantly encroaching on the sea by reason of the alluvium washed down by the rivers of the Pyrenees and Cévennes, is without important harbours saving that of Cette, itself continually invaded by the sand. East of Martigues the coast is rocky and of greater altitude, and is broken by projecting capes (Couronne, Croisette, Sicié, the peninsula of Giens and Cape Antibes), and by deep gulfs forming secure roadsteads such as those of Marseilles, which has the chief port in France, Toulon, with its great naval harbour, and Hyères, to which may be added the Gulf of St Tropez.

Along the Atlantic coast from the mouth of the Adour to the

¹ The etymology of this name (sometimes wrongly written Golfe de Lyon) is unknown.

estuary of the Gironde there stretches a monotonous line of sand-dunes bordered by lagoons on the land side, but towards the sea harbourless and unbroken save for the Bay of Arcachon. To the north as far as the rocky point of St Gildas, sheltering the mouth of the Loire, the shore, often occupied by salt marshes (marshes of Poitou and Brittany), is low-lying and hollowed by deep bays sheltered by large islands, those of Oléron and Ré lying opposite the ports of Rochefort and La Rochelle, while Noirmoutier closes the Bay of Bourgneuf.

Beyond the Loire estuary, on the north shore of which is the port of St Nazaire, the peninsula of Brittany projects into the ocean and here begins the most rugged, wild and broken portion of the French seaboard; the chief of innumerable indentations are, on the south the Gulf of Morbihan, which opens into a bay protected to the west by the narrow peninsula of Quiberon, the Bay of Lorient with the port of Lorient, and the Bay of Concarneau; on the west the dangerous Bay of Audierne and the Bay of Douarnenez separated from the spacious roadstead of Brest, with its important naval port, by the peninsula of Crozon, and forming with it a great indentation sheltered by Cape St Mathieu on the north and by Cape Raz on the south; on the north, opening into the English Channel, the Morlaix roads, the Bay of St Brieuc, the estuary of the Rance, with the port of St Malo and the Bay of St Michel. Numerous small archipelagoes and islands, of which the chief are Belle Île, Groix and Ushant, fringe the Breton coast. North of the Bay of St Michel the peninsula of Cotentin, terminating in the promontories of Hague and Barfleur, juts north into the English Channel and closes the bay of the Seine on the west. Cherbourg, its chief harbour, lies on the northern shore between the two promontories. The great port of Le Havre stands at the mouth of the Seine estuary, which opens into the bay of the Seine on the east. North of that point a line of high cliffs, in which occur the ports of Fécamp and Dieppe, stretches nearly to the sandy estuary of the Somme. North of that river the coast is low-lying and bordered by sand-dunes, to which succeed on the Strait of Dover the cliffs in the neighbourhood of the port of Boulogne and the marshes and sand-dunes of Flanders, with the ports of Calais and Dunkirk, the latter the principal French port on the North Sea.

To the maritime ports mentioned above must be added the river ports of Bayonne (on the Adour), Bordeaux (on the Garonne), Nantes (on the Loire), Rouen (on the Seine). On the whole, however, France is inadequately provided with natural harbours; her long tract of coast washed by the Atlantic and the Bay of Biscay has scarcely three or four good seaports, and those on the southern shore of the Channel form a striking contrast to the spacious maritime inlets on the English side.

Rivers.—The greater part of the surface of France is divided between four principal and several secondary basins.

The basin of the Rhône, with an area (in France) of about 35,000 sq. m., covers eastern France from the Mediterranean to the Vosges, from the Cévennes and the Plateau de Langres to the crests of the Jura and the Alps. Alone among French rivers, the Rhône, itself Alpine in character in its upper course, is partly fed by Alpine rivers (the Arve, the Isère and the Durance) which have their floods in spring at the melting of the snow, and are maintained by glacier-water in summer. The Rhône, the source of which is in Mont St Gothard, in Switzerland, enters France by the narrow defile of L'Écluse, and has a somewhat meandering course, first flowing south, then north-west, and then west as far as Lyons, whence it runs straight south till it reaches the Mediterranean, into which it discharges itself by two principal branches, which form the delta or island of the Camargue. The Ain, the Saône (which rises in the Faucilles and in the lower part of its course skirting the regions of Bresse and Dombes, receives the Doubs and joins the Rhone at Lyons), the Ardèche and the Gard are the affluents on the right; on the left it is joined by the Arve, the Isère, the Drôme and the Durance. The small independent river, the Var, drains that portion of the Alps which fringes the Mediterranean.

The basin of the Garonne occupies south-western France with the exception of the tracts covered by the secondary basins of the Adour, the Aude, the Hérault, the Orb and other smaller rivers, and the low-lying plain of the Landes, which is watered by numerous coast rivers, notably by the Leyre. Its area is nearly 33,000 sq. m., and extends from the Pyrenees to the uplands of Saintonge, Périgord and Limousin. The Garonne rises in the valley of Aran (Spanish Pyrenees), enters France near Bagnères-de-Luchon, has first a north-west course, then bends to the north-east, and soon resumes its first direction. Joining the Atlantic between Royan and the Pointe de Grave, opposite the tower of Cordouan. In the lower part of its course, from the Bec-d'Ambez, where it receives the Dordogne, it becomes considerably wider, and takes the name of Gironde. The principal affluents are the Ariège, the Tarn with the Aveyron and the Agout, the Lot and the Dordogne, which descends from Mont Dore-les-Bains, and joins the Garonne at Bec-d'Ambez, to form the Gironde. All these affluents are on the right, and with the exception of the Ariège, which descends from the eastern Pyrenees, rise in the mountains of Auvergne and the southern Cévennes, their sources often lying close to those of the rivers of the Loire and Rhone basins. The Neste, a Pyrenean torrent, and the Save, the Gers and the Baise, rising on the plateau of Lannemezan, are the principal left-hand

tributaries of the Garonne. North of the basin of the Garonne an area of over 3800 sq. m. is watered by the secondary system of the Charente, which descends from Chéronnac (Haute-Vienne), traverses Angoulême and falls into the Atlantic near Rochefort. Farther to the north a number of small rivers, the chief of which is the Sèvre Niortaise, drain the coast region to the south of the plateau of Gâtine.

The basin of the Loire, with an area of about 47,000 sq. m., includes a great part of central and western France or nearly a quarter of the whole country. The Loire rises in Mont Gerbier de Jonc, in the range of the Vivarais mountains, flows due north to Nevers, then turns to the north-west as far as Orléans, in the neighbourhood of which it separates the marshy region of the Sologne (*q.v.*) on the south from the wheat-growing region of Beauce and the Gâtinais on the north. Below Orléans it takes its course towards the south-west, and lastly from Saumur runs west, till it reaches the Atlantic between Paimbœuf and St Nazaire. On the right the Loire receives the waters of the Furens, the Arroux, the Nièvre, the Maine (formed by the Mayenne and the Sarthe with its affluent the Loir), and the Erdre, which joins the Loire at Nantes; on the left, the Allier (which receives the Dore and the Sioule), the Loiret, the Cher, the Indre, the Vienne with its affluent the Creuse, the Thouet, and the Sèvre-Nantaise. The peninsula of Brittany and the coasts of Normandy on both sides of the Seine estuary are watered by numerous independent streams. Amongst these the Vilaine, which passes Rennes and Redon, waters, with its tributaries, an area of 4200 sq. m. The Orne, which rises in the hills of Normandy and falls into the Channel below Caen, is of considerably less importance.

The basin of the Seine, though its area of a little over 30,000 sq. m. is smaller than that of any of the other main systems, comprises the finest network of navigable rivers in the country. It is by far the most important basin of northern France, those of the Somme and Scheldt in the north-west together covering less than 5000 sq. m., those of the Meuse and the Rhine in the north-east less than 7000 sq. m. The Seine descends from the Langres plateau, flows north-west down to Méry, turns to the west, resumes its north-westerly direction at Montereau, passes through Paris and Rouen and discharges itself into the Channel between Le Havre and Honfleur. Its affluents are, on the right, the Aube; the Marne, which joins the Seine at Charenton near Paris; the Oise, which has its source in Belgium and is enlarged by the Aisne; and the Epte; on the left the Yonne, the Loing, the Essonne, the Eure and the Rille.

Lakes.—France has very few lakes. The Lake of Geneva, which forms 32 m. of the frontier, belongs to Switzerland. The most important French lake is that of Grand-Lieu, between Nantes and Paimbœuf (Loire-Inférieure), which presents a surface of 17,300 acres. There may also be mentioned the lakes of Bourget and Annecy (both in Savoy), St Point (Jura), Paladru (Isère) and Nantua (Ain). The marshy districts of Sologne, Brenne, Landes and Dombes still contain large undrained tracts. The coasts present a number of maritime inlets, forming inland bays, which communicate with the sea by channels of greater or less width. Some of these are on the south-west coast, in the Landes, as Carcans, Lacanau, Biscarosse, Cazau, Sanguinet; but more are to be found in the south and south-east, in Languedoc and Provence, as Leucate, Sigean, Thau, Vaccarès, Berre, &c. Their want of depth prevents them from serving as roadsteads for shipping, and they are useful chiefly for fishing or for the manufacture of bay-salt.

Climate.—The north and north-west of France bear a great resemblance, both in temperature and produce, to the south of England, rain occurring frequently, and the country being consequently suited for pasture. In the interior the rains are less frequent, but when they occur are far more heavy, so that there is much less difference in the annual rainfall there as compared with the rest of the country than in the number of rainy days. The annual rainfall for the whole of France averages about 32 in. The precipitation is greatest on the Atlantic seaboard and in the elevated regions of the interior. It attains over 60 in. in the basin of the Adour (71 in. at the western extremity of the Pyrenees), and nearly as much in the Vosges, Morvan, Cévennes and parts of the central plateau. The zone of level country extending from Reims and Troyes to Angers and Poitiers, with the exception of the Loire valley and the Brie, receives less than 24 in. of rain annually (Paris about 23 in.), as also does the Mediterranean coast west of Marseilles. The prevailing winds, mild and humid, are west winds from the Atlantic; continental climatic influence makes itself felt in the east wind, which is frequent in winter and in the east of France, while the *mistral*, a violent wind from the north-west, is characteristic of the Mediterranean region. The local climates of France may be grouped under the following seven designations: (1) Sequan climate, characterizing the Seine basin and northern France, with a mean temperature of 50° F., the winters being cold, the summers mild; (2) Breton climate, with a mean temperature of 51·8° F., the winters being mild, the summers temperate, it is characterized by west and south-west winds and frequent fine rains; (3) Girondin climate (characterizing Bordeaux, Agen, Pau, &c.), having a mean of 53·6° F., with mild winters and hot summers, the prevailing wind is from the north-west, the average rainfall about 28 in.; (4) Auvergne climate, comprising the Cévennes, central plateau, Clermont, Limoges and Rodez, mean temperature 51·8° F., with cold

winters and hot summers; (5) Vosges climate (comprehending Epinal, Mézières and Nancy), having a mean of 48.2° F., with long and severe winters and hot and rainy summers; (6) Rhône climate (experienced by Lyons, Chalon, Mâcon, Grenoble) mean temperature 51.8° F., with cold and wet winters and hot summers, the prevailing winds are north and south; (7) Mediterranean climate, ruling at Valence, Nîmes, Nice and Marseilles, mean temperature, 57.5° F., with mild winters and hot and almost rainless summers.

Flora and Fauna.—The flora of southern France and the Mediterranean is distinct from that of the rest of the country, which does not differ in vegetation from western Europe generally. Evergreens predominate in the south, where grow subtropical plants such as the myrtle, arbutus, laurel, holm-oak, olive and fig; varieties of the same kind are also found on the Atlantic coast (as far north as the Cotentin), where the humidity and mildness of the climate favour their growth. The orange, date-palm and eucalyptus have been acclimatized on the coast of Provence and the Riviera. Other trees of southern France are the cork-oak and the Aleppo and maritime pines. In north and central France the chief trees are the oak, the beech, rare south of the Loire, and the hornbeam; less important varieties are the birch, poplar, ash, elm and walnut. The chestnut covers considerable areas in Périgord, Limousin and Béarn; resinous trees (firs, pines, larches, &c.) form fine forests in the Vosges and Jura.

The indigenous fauna include the bear, now very rare but still found in the Alps and Pyrenees, the wolf, harbouring chiefly in the Cévennes and Vosges, but in continually decreasing areas; the fox, marten, badger, weasel, otter, the beaver in the extreme south of the Rhône valley, and in the Alps the marmot; the red deer and roe deer are preserved in many of the forests, and the wild boar is found in several districts; the chamois and wild goat survive in the Pyrenees and Alps. Hares, rabbits and squirrels are common. Among birds of prey may be mentioned the eagle and various species of hawk, and among game-birds the partridge and pheasant. The reptiles include the ringed-snake, slow-worm, viper and lizard. (R. TR.)

Geology.—Many years ago it was pointed out by Elie de Beaumont and Dufrénoy that the Jurassic rocks of France form upon the map an incomplete figure of 8. Within the northern circle of the 8 lie the Mesozoic and Tertiary beds of the Paris basin, dipping inwards; within the southern circle lie the ancient rocks of the Central Plateau, from which the later beds dip outwards. Outside the northern circle lie on the west the folded Palaeozoic rocks of Brittany, and on the north the Palaeozoic *massif* of the Ardennes. Outside the southern circle lie on the west the Mesozoic and Tertiary beds of the basin of the Garonne, with the Pyrenees beyond, and on the east the Mesozoic and Tertiary beds of the valley of the Rhône, with the Alps beyond.

In the geological history of France there have been two great periods of folding since Archean times. The first of these occurred towards the close of the Palaeozoic era, when a great mountain system was raised in the north running approximately from E. to W., and another chain arose in the south, running from S.W. to N.E. Of the former the remnants are now seen in Brittany and the Ardennes; of the latter the Cévennes and the Montagne Noire are the last traces visible on the surface. The second great folding took place in Tertiary times, and to it was due the final elevation of the Jura and the Western Alps and of the Pyrenees. No great mountain chain was ever raised by a single effort, and folding went on to some extent in other periods besides those mentioned. There were, moreover, other and broader oscillations which raised or lowered extensive areas without much crumpling of the strata, and to these are due some of the most important breaks in the geological series.

The oldest rocks, the gneisses and schists of the Archean period, form nearly the whole of the Central Plateau, and are also exposed in the axes of the folds in Brittany. The Central Plateau has probably been a land mass ever since this period, but the rest of the country was flooded by the Palaeozoic sea. The earlier deposits of that sea now rise to the surface in Brittany, the Ardennes, the Montagne Noire and the Cévennes, and in all these regions they are intensely folded. Towards the close of the Palaeozoic era France had become a part of a great continent; in the north the Coal Measures of the Boulonnais and the Nord were laid down in direct connexion with those of Belgium and England, while in the Central Plateau the Coal Measures were deposited in isolated and scattered basins. The Permian and Triassic deposits were also, for the most part, of continental origin; but with the formation of the Rhaetic beds the sea again began to spread, and throughout the greater part of the Jurassic period it covered nearly the whole of the country except the Central Plateau, Brittany and the Ardennes. Towards the end of the period, however, during the deposition of the Portlandian beds, the sea again retreated, and in the early part of the Cretaceous period was limited (in France) to the catchment basins of the Saône and Rhône—in the Paris basin the contemporaneous deposits were chiefly estuarine and were confined to the northern and eastern rim. Beginning with the Aptian and Albian the sea again gradually spread over the country and attained its maximum in the early part of the Senonian epoch, when once more the ancient massifs of the Central Plateau, Brittany and the Ardennes, alone rose above the waves. There was still, however, a well-marked difference between the deposits of the northern and the southern parts of France, the

former consisting of chalk, as in England, and the latter of sandstones and limestones with Hippurites. During the later part of the Cretaceous period the sea gradually retreated and left the whole country dry.

During the Tertiary period arms of the sea spread into France—in the Paris basin from the north, in the basins of the Loire and the Garonne from the west, and in the Rhône area from the south. The changes, however, were too numerous and complex to be dealt with here.

In France, as in Great Britain, volcanic eruptions occurred during several of the Palaeozoic periods, but during the Mesozoic era the

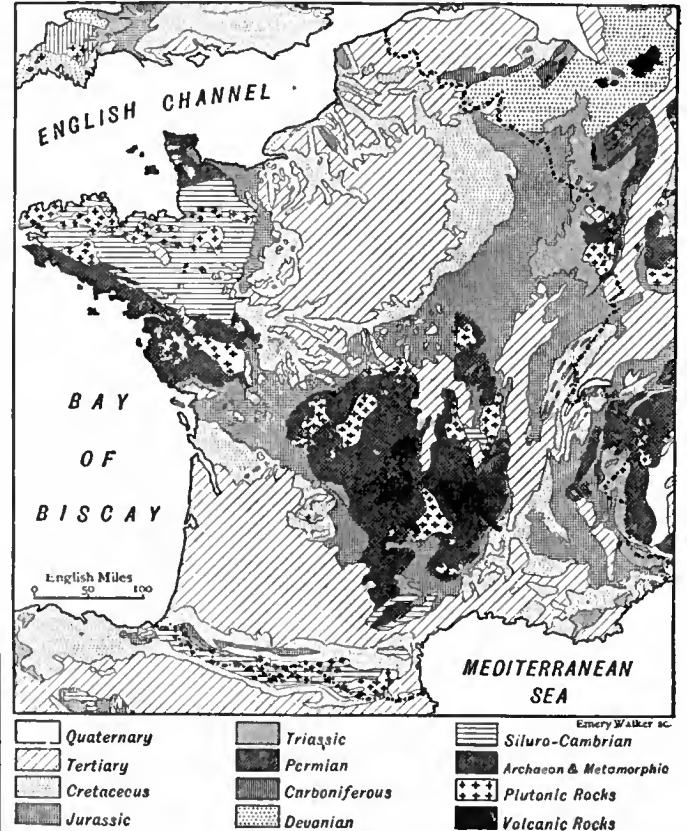

country was free from outbursts, except in the regions of the Alps and Pyrenees. In Tertiary times the Central Plateau was the theatre of great volcanic activity from the Miocene to the Pleistocene periods, and many of the volcanoes remain as nearly perfect cones to the present day. The rocks are mainly basalts and andesites, together with trachytes and phonolites, and some of the basaltic flows are of enormous extent.

On the geology of France see the classic *Explication de la carte géologique de la France* (Paris, vol. i. 1841, vol. ii. 1848), by Dufrénoy and Elie de Beaumont; a more modern account, with full references, is given by A. de Lapparent, *Traité de géologie* (Paris, 1906).

(J. A. H.)

Population.

The French nation is formed of many different elements. Iberian influence in the south-west, Ligurian on the shores of the Mediterranean, Germanic immigrations from east of the Rhine and Scandinavian immigrations in the north-west have tended to produce ethnographical diversities which ease of intercommunication and other modern conditions have failed to obliterate. The so-called Celtic type, exemplified by individuals of rather less than average height, brown-haired and brachycephalic, is the fundamental element in the nation and peoples the region between the Seine and the Garonne; in southern France a different type, dolichocephalic, short and with black hair and eyes, predominates. The tall, fair and blue-eyed individuals who are found to the north-east of the Seine and in Normandy appear to be nearer in race to the Scandinavian and Germanic invaders; a tall and darker type with long faces and aquiline noses occurs in some parts of Franche-Comté and Champagne, the Vosges and the Perche. From the Celts has been derived the gay, brilliant and adventurous temperament easily moved to extremes of enthusiasm and depression, which

FRANCE

Scale: 1:3,000,000
English Miles

- Capitals of Countries.....
- Capitals of Departments.....
- Railways.....
- Canals.....
- Glaciers.....
- Fortifications.....

ENGLISH CHANNEL

Channel Islands

ATLANTIC OCEAN

Continuation North

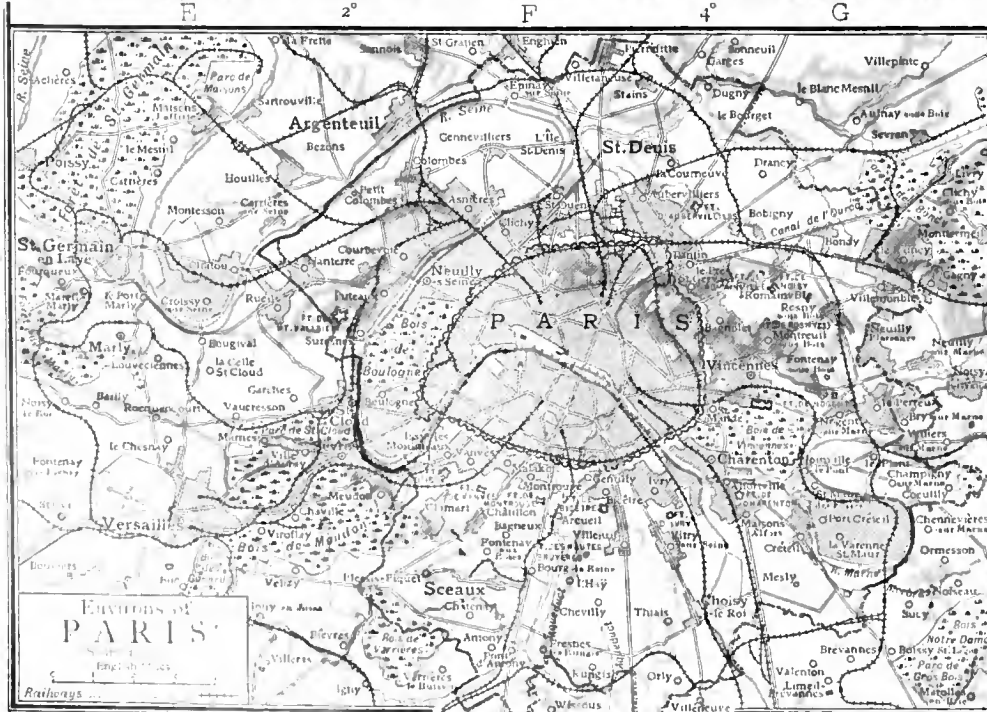
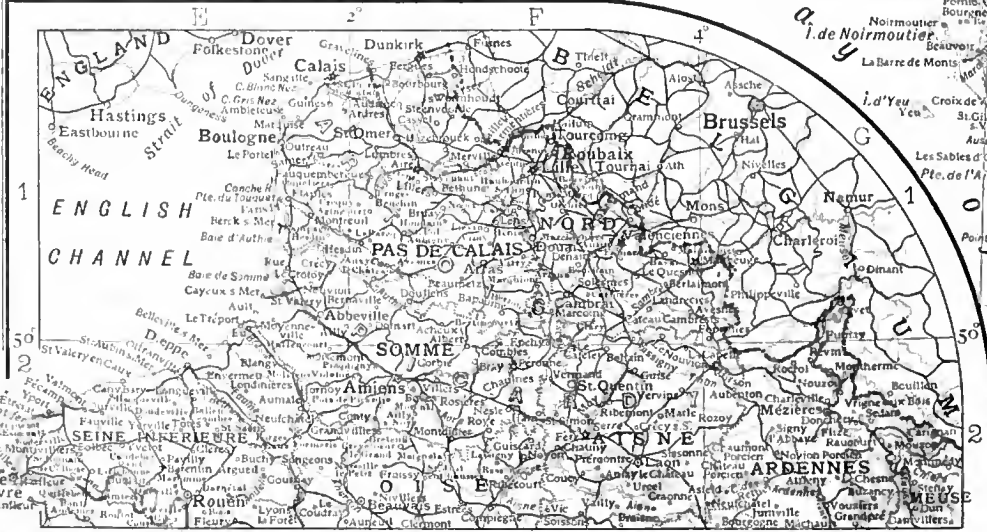

Environs of PARIS

Longitude West 6° of Greenwich

Meridian of

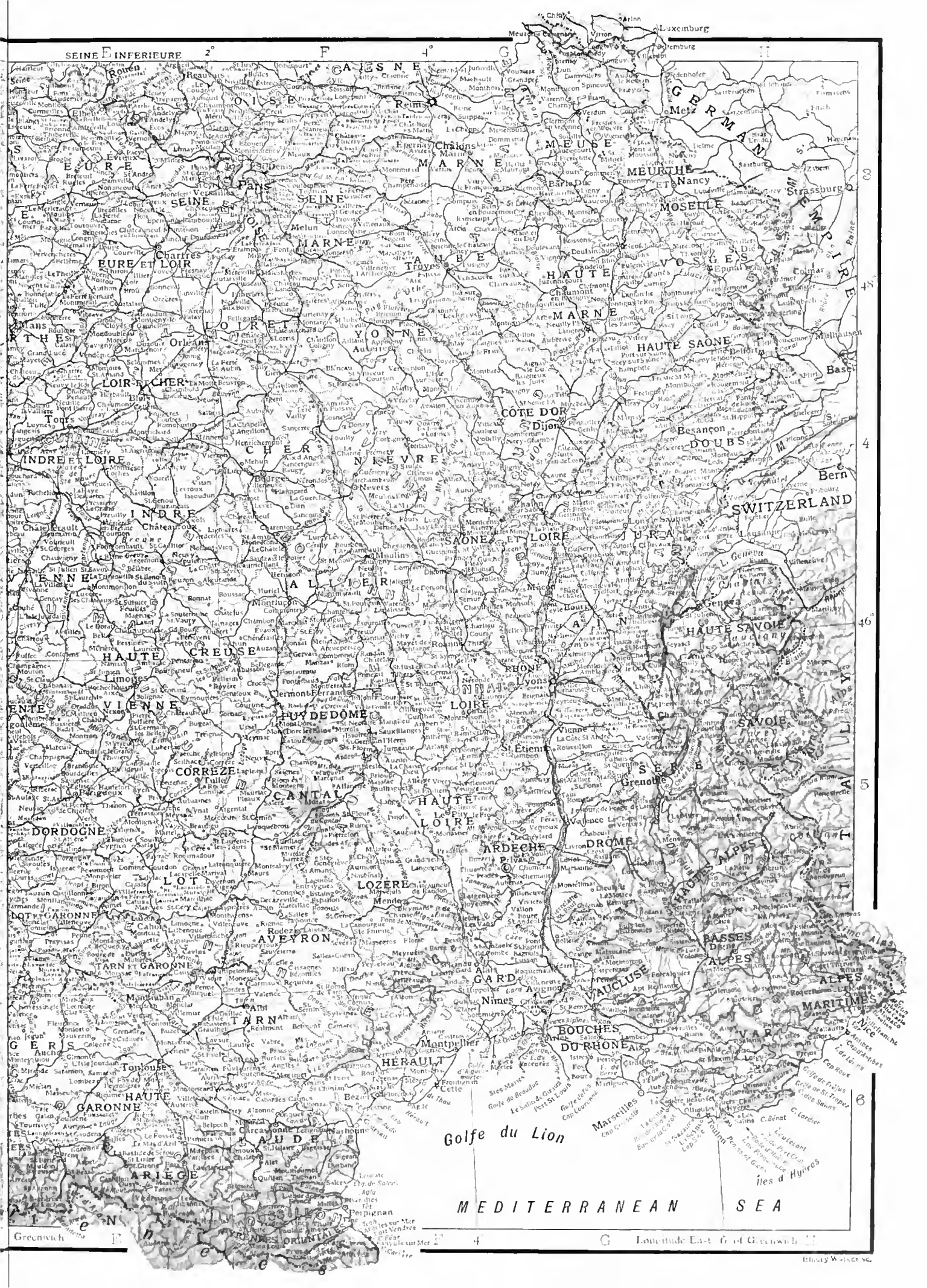

SEINE INFÉRIEURE

PARIS

SEINE

SEINE

SEINE

SEINE

SEINE

SEINE

SEINE

SEINE

SEINE

SEINE

SEINE

SEINE

SEINE

SEINE

SEINE

SEINE

SEINE

SEINE

SEINE

SEINE

SEINE

SEINE

SEINE

SEINE

SEINE

SEINE

SEINE

SEINE

SEINE

SEINE

SEINE

SEINE

SEINE

SEINE

SEINE

SEINE

SEINE

SEINE

SEINE

SEINE

SEINE

SEINE

SEINE

SEINE

SEINE

SEINE

SEINE

SEINE

Golfe du Lion

MEDITERRANEAN SEA

Longitude East of Greenwich

Library of Congress

combined with logical and organizing faculties of a high order, the heritage from the Latin domination, and with the industry, frugality and love of the soil natural in an agricultural people go to make up the national character. The Bretons, who most nearly represent the Celts, and the Basques, who inhabit parts of the western versant of the Pyrenees, have preserved their distinctive languages and customs, and are ethnically the most interesting sections of the nation; the Flemings of French Flanders where Flemish is still spoken are also racially distinct. The immigration of Belgians into the northern departments and of Italians into those of the south-east exercise a constant modifying influence on the local populations.

During the 19th century the population of France increased to a less extent than that of any other country (except Ireland) for which definite data exist, and during the last twenty years of that period it was little more than stationary. The following table exhibits the rate of increase as indicated by the censuses from 1876 to 1906. Population.

1876	36,905,788
1881	37,672,048
1886	38,218,903
1891	38,342,948
1896	38,517,975
1901	38,961,945
1906	39,252,245

Thus the rate of increase during the decade 1891-1901 was .16%, whereas during the same period the population of England increased 1.08%. The birth-rate markedly decreased during the 19th century; despite an increase of population between 1801 and 1901 amounting to 40%, the number of births in the former was 904,000, as against 857,000 in the latter year, the diminution being accompanied by a decrease in the annual number of deaths.¹ In the following table the decrease in births and deaths for the decennial periods during the thirty years ending 1900 are compared.

Births.	
1871-1880	935,000 or 25.4 per 1000
1881-1890	909,000 ,, 23.9 ,,
1891-1900	853,000 ,, 22.2 ,,
Deaths.	
1871-1880	870,900 or 23.7 per 1000
1881-1890	841,700 ,, 22.1 ,,
1891-1900	829,000 ,, 21.5 ,,

About two-thirds of the French departments, comprising a large proportion of those situated in mountainous districts and in the basin of the Garonne, where the birth-rate is especially feeble, show a decrease in population. Those which show an increase usually possess large centres of industry and are already thickly populated, e.g. Seine and Pas-de-Calais. In most departments the principal cause of decrease of population is the attraction of great centres. The average density of population in France is about 190 to the square mile, the tendency being for the large towns to increase at the expense of the small towns as well as the rural communities. In 1901 37% of the population lived in centres containing more than 2000 inhabitants, whereas in 1861 the proportion was 28%. Besides the industrial districts the most thickly populated regions include the coast of the department of Seine-Inférieure and Brittany, the wine-growing region of the Bordelais and the Riviera.²

¹ In 1907 deaths were superior in number to births by nearly 20,000.

² The following list comprises the three most densely populated and the three most sparsely populated departments in France:

Inhabitants to the Square Mile.	
Seine	20,803
Nord	850
Rhône	778
Basses-Alpes	42
Hauts-Alpes	49
Lozère	64

In the quinquennial period 1901-1905, out of the total number of births the number of illegitimate births to every 1000 inhabitants was 2.0, as compared with 2.1 in the four preceding periods of like duration.

In 1906 the number of foreigners in France was 1,009,415 as compared with 1,027,491 in 1896 and 1,115,214 in 1886. The departments with the largest population of foreigners were Nord (191,678), in which there is a large proportion of Belgians; Bouches-du-Rhône (123,497), Alpes-Maritimes (93,554), Var (47,475), Italians being numerous in these three departments; Seine (153,647), Meurthe-et-Moselle (44,595), Pas-de-Calais (21,436) and Ardennes (21,401).

The following table gives the area in square miles of each of the eighty-seven departments with its population according to the census returns of 1886, 1896 and 1906:

Departments.	Area, sq. m.	Population.		
		1886.	1896.	1906.
Ain	2,249	364,408	351,569	345,856
Aisne	2,867	555,925	541,613	534,495
Allier	2,849	424,582	424,378	417,961
Alpes-Maritimes	1,442	238,057	265,155	334,007
Ardèche	2,145	375,472	363,501	347,140
Ardennes	2,028	332,759	318,865	317,505
Ariège	1,893	237,619	219,641	205,684
Aube	2,326	257,374	251,435	243,670
Aude	2,448	332,080	310,513	308,327
Aveyron	3,386	415,826	389,464	377,299
Basses-Alpes	2,698	129,494	118,142	113,126
Basses-Pyrénées	2,977	432,999	423,572	426,817
Belfort, Territoire de	235	79,758	88,047	95,421
Bouches-du-Rhône	2,026	604,857	673,820	765,918
Calvados	2,197	437,267	417,176	403,431
Cantal	2,231	241,742	234,382	228,690
Charente	2,305	366,408	356,236	351,733
Charente-Inférieure	2,791	462,803	453,455	453,793
Cher	2,819	355,349	347,725	343,484
Corrèze	2,273	326,494	322,393	317,430
Corse (Corsica)	3,367	278,501	290,168	291,160
Côte-d'Or	3,392	381,574	368,168	357,959
Côtes-du-Nord	2,786	628,256	616,074	611,506
Creuse	2,164	284,942	279,366	274,094
Deux-Sèvres	2,337	353,766	346,694	339,466
Dordogne	3,561	492,205	464,822	447,052
Doubs	2,030	310,963	302,046	298,438
Drôme	2,533	314,615	303,491	297,270
Eure	2,330	358,829	340,652	330,140
Eure-et-Loir	2,293	283,719	280,469	273,823
Finistère	2,713	707,820	739,648	795,103
Gard	2,270	417,099	416,036	421,166
Gers	2,428	274,391	250,472	231,088
Gironde	4,140	775,845	809,902	823,925
Haute-Garonne	2,458	481,169	459,377	442,065
Haute-Loire	1,931	320,063	316,699	314,770
Haute-Marne	2,415	247,781	232,057	221,724
Hauts-Alpes	2,178	122,924	113,229	107,498
Haute-Saône	2,075	290,954	272,801	263,890
Haute-Savoie	1,775	275,018	265,872	260,617
Hauts-Pyrénées	1,750	234,825	218,973	209,397
Haute-Vienne	2,144	363,182	375,724	385,732
Hérault	2,403	439,044	469,684	482,799
Ille-et-Vilaine	2,699	621,384	622,039	611,805
Indre	2,666	296,147	289,206	290,216
Indre-et-Loire	2,377	340,921	337,064	337,916
Isère	3,179	581,680	568,933	562,315
Jura	1,951	281,292	266,143	257,725
Landes	3,615	302,266	292,884	293,397
Loir-et-Cher	2,479	279,214	278,153	276,019
Loire	1,853	603,384	625,336	643,943
Loire-Inférieure	2,694	643,884	646,172	666,748
Loiret	2,629	374,875	371,019	364,999
Lot	2,017	271,514	240,403	216,611
Lot-et-Garonne	2,079	307,437	286,377	274,610
Lozère	1,999	141,264	132,151	128,016
Maine-et-Loire	2,706	527,680	514,870	513,490
Manche	2,475	520,865	500,052	487,443
Marne	3,167	429,494	439,577	434,157
Mayenne	2,012	340,063	321,187	305,457
Meurthe-et-Moselle	2,038	431,693	466,417	517,508
Meuse	2,409	291,971	290,384	280,220
Morbihan	2,738	535,256	552,028	573,152
Nièvre	2,659	347,645	333,899	313,972
Nord	2,229	1,670,184	1,811,868	1,895,861

Departments.	Area, sq. m.	Population.		
		1886.	1896.	1906.
Oise	2,272	403,146	404,511	410,049
Orne	2,372	367,248	339,162	315,993
Pas-de-Calais	2,606	853,526	906,249	1,012,466
Puy-de-Dôme	3,094	570,964	555,078	535,419
Pyrénées-Orientales	1,599	211,187	208,387	213,171
Rhône	1,104	772,912	839,329	858,907
Saône-et-Loire	3,330	625,885	621,237	613,377
Sarthe	2,410	436,111	425,077	421,470
Savoie	2,389	267,428	259,790	253,297
Seine	185	2,961,089	3,340,514	3,848,618
Seine-Inférieure	2,448	833,386	837,824	863,879
Seine-et-Marne	2,289	355,136	359,044	361,939
Seine-et-Oise	2,184	618,089	669,098	749,753
Somme	2,423	548,982	543,279	532,567
Tarn	2,231	358,757	339,827	330,533
Tarn-et-Garonne	1,440	214,046	200,390	188,553
Var	2,325	283,689	309,191	324,638
Vaucluse	1,381	241,787	236,313	239,178
Vendée	2,708	434,808	441,735	442,777
Vienne	2,719	342,785	338,114	333,621
Vosges	2,279	413,707	421,412	429,812
Yonne	2,880	355,364	332,656	315,199
Total	207,076	38,218,903	38,517,975	39,252,245

The French census uses the commune as the basis of its returns, and employs the following classifications in respect to communal population: (1) Total communal population. (2) *Population comptée à part*, which includes soldiers and sailors, inmates of prisons, asylums, schools, members of religious communities, and workmen temporarily engaged in public works. (3) Total *municipal* population, *i.e.* communal population minus the *population comptée à part*. (4) *Population municipale agglomérée au chef-lieu de la commune*, which embraces the urban population as opposed to the rural population. The following tables, showing the growth of the largest towns in France, are drawn up on the basis of the fourth classification, which is used throughout this work in the articles on French towns, except where otherwise stated.

In 1906 there were in France twelve towns with a population of over 100,000 inhabitants. Their growth or decrease from 1886 to 1906 is shown in the following table:

	1886.	1896.	1906.
Paris	2,294,108	2,481,223	2,711,931
Lyons	344,124	398,867	430,186
Marseilles	249,938	332,515	421,116
Bordeaux	225,281	239,806	237,707
Lille	143,135	160,723	196,624
St Étienne	103,229	120,300	130,940
Le Havre	109,199	117,009	129,403
Toulouse	123,040	124,187	125,856
Roubaix	89,781	113,899	119,955
Nantes	110,638	107,137	118,244
Rouen	100,043	106,825	111,402
Reims	91,130	99,001	102,800

In the same years the following eighteen towns, now numbering from 50,000 to 100,000 inhabitants, each had:

	1886.	1896.	1906.
Nice	61,464	69,140	99,556
Nancy	69,463	83,668	98,302
Toulon	53,941	70,843	87,997
Amiens	68,177	74,808	78,407
Limoges	56,699	64,718	75,906
Angers	65,152	69,484	73,585
Brest	59,352	64,144	71,163
Nîmes	62,198	66,905	70,708
Montpellier	45,930	62,717	65,983
Dijon	50,684	58,355	65,516
Tourcoing	41,183	55,705	62,694
Rennes	52,614	57,249	62,024
Tours	51,467	56,706	61,507
Calais	52,839	50,818	59,623
Grenoble	43,260	50,084	58,641
Orléans	51,208	56,915	57,544
Le Mans	46,991	49,665	54,907
Troyes	44,864	50,676	51,228

Of the population in 1901, 18,916,889 were males and 19,533,899 females, an excess of females over males of 617,010, *i.e.* 1.6% or about 508 females to every 492 males. In 1881 the proportion was 501 females to every 499 males, since when the disparity has been slightly more marked at every census. Below is a list of the departments in which the number of women to every thousand men was (1) greatest and (2) least.

(1)	(2)
Creuse	Belfort
Côtes-du-Nord	Basses-Alpes
Seine	Var
Calvados	Meuse
Cantal	Hautes-Alpes
Seine-Inférieure	Meurthe-et-Moselle
Basses-Pyrénées	Haute-Savoie

Departments from which the adult males emigrate regularly either to sea or to seek employment in towns tend to fall under the first head, those in which large bodies of troops are stationed under the second.

The annual number of emigrants from France is small. The Basques of Basses-Pyrénées go in considerable numbers to the Argentine Republic, the inhabitants of Basses Alpes to Mexico and the United States, and there are important French colonies in Algeria and Tunisia.

The following table shows the distribution of the active population of France according to their occupations in 1901.

Occupation.	Males.	Females.	Total.
Forestry and agriculture	5,517,617	2,658,952	8,176,569
Manufacturing industries	3,695,213	2,124,642	5,819,855
Trade	1,132,621	689,999	1,822,620
Domestic service	223,861	791,176	1,015,037
Transport	617,849	212,794	830,643
Public service	1,157,835	139,734	1,297,569
Liberal professions	226,561	173,278	399,839
Mining, quarries	261,320	5,031	266,351
Fishing	63,372	4,400	67,772
Unclassed	14,316	4,504	18,820
Grand Total	12,910,565	6,804,510	19,715,075

Religion.

Great alterations were made with regard to religious matters in France by a law of December 1905, supplemented by a law of January 1907 (see below, *Law and Institutions*). Before that time three religions (*cultes*) were recognized and supported by the state—the Roman Catholic, the Protestant (subdivided into the Reformed and Lutheran) and the Hebrew. In Algeria the Mahommedan religion received similar recognition. By the law of 1905 all the churches ceased to be recognized or supported by the state and became entirely separated therefrom, while the adherents of all creeds were permitted to form associations for public worship (*associations cultuelles*), upon which the expenses of maintenance were from that time to devolve. The state, the departments, and the communes were thus relieved from the payment of salaries and grants to religious bodies, an item of expenditure which amounted in the last year of the old system to £1,101,000 paid by the state and £302,200 contributed by the departments and communes. Before these alterations the relations between the state and the Roman Catholic communion, by far the largest and most important in France, were chiefly regulated by the provisions of the Concordat of 1801, concluded between the first consul, Bonaparte, and Pope Pius VII. and by other measures passed in 1802.

France is divided into provinces and dioceses as follows:

Archbishoprics.	Bishoprics.
PARIS	Chartres, Meaux, Orléans, Blois, Versailles.
AIX	Marseilles, Fréjus, Digne, Gap, Nice, Ajaccio.
ALBI	Rodez, Cahors, Mende, Perpignan.
AUCH	Aire, Tarbes, Bayonne.
AVIGNON	Nîmes, Valence, Viviers, Montpellier.
BESANÇON	Verdun, Bellay, St Dié, Nancy.
BORDEAUX	Agen, Angoulême, Poitiers, Périgueux, La Rochelle, Luçon.
BOURGES	Clermont, Limoges, Le Puy, Tulle, St Flour.
CAMBRAI	Arras.
CHAMBERY	Annecy, Tarentaise, St Jean-de-Maurienne.
LYONS	Autun, Langres, Dijon, St Claude, Grenoble.

Archbishopsrics.	Bishoprics.
REIMS . . . Soissons, Châlons-sur-Marne, Beauvais, Amiens.	
RENNES . . . Quimper, Vannes, St Briuc.	
ROUEN . . . Bayeux, Evreux, Sées, Coutances.	
SENS . . . Troyes, Nevers, Moulins.	
TOULOUSE . . . Montauban, Pamiers, Carcassonne.	
TOURS . . . Le Mans, Angers, Nantes, Laval.	

The dioceses are divided into parishes each under a parish priest known as a *curé* or *desservant* (incumbent). The bishops and archbishops, formerly nominated by the government and canonically confirmed by the pope, are now chosen by the latter. The appointment of curés rested with the bishops and had to be confirmed by the government, but this confirmation is now dispensed with. The archbishops used to receive an annual salary of £600 each and the bishops £400.

The archbishops and bishops are assisted by vicars-general (at salaries previously ranging from £100 to £180), and to each cathedral is attached a chapter of canons. A *curé*, in addition to his regular salary, received fees for baptisms, marriages, funerals and special masses, and had the benefit of a free house called a *presbytère*. The total personnel of state-paid Roman Catholic clergy amounted in 1903 to 36,169. The Roman priests are drawn from the seminaries, established by the church for the education of young men intending to join its ranks, and divided into lower and higher seminaries (*grands et petits séminaires*), the latter giving the same class of instruction as the *lycées*.

The number of Protestants may be estimated at about 600,000 and the Jews at about 70,000. The greatest number of Jews is to be found at Paris, Lyons and Bordeaux, while the departments of the centre and of the south along the range of the Cévennes, where Calvinism flourishes, are the principal Protestant localities, Nîmes being the most important centre. Considerable sprinklings of Protestants are also to be found in the two Charentes, in Dauphiné, in Paris and in Franche-Comté. The two Protestant bodies used to cost the state about £60,000 a year and the Jewish Church about £600.

Both Protestant churches have a parochial organization and a presbyterian form of church government. In the Reformed Church (far the more numerous of the two bodies) each parish has a council of presbyters, consisting of the pastor and lay-members elected by the congregation. Several parishes form a consistorial circumscription, which has a consistorial council consisting of the council of presbyters of the chief town of the circumscription, the pastor and one delegate of the council of presbyters from each parish and other elected members. There are 103 circumscriptions (including Algeria), which are grouped into 21 provincial synods composed of a pastor and lay delegate from each consistory. All the more important questions of church discipline and all decisions regulating the doctrine and practice of the church are dealt with by the synods. At the head of the whole organization is a General Synod, sitting at Paris. The organization of the Lutheran Church (*Eglise de la confession d'Augsburg*) is broadly similar. Its consistories are grouped into two special synods, one at Paris and one at Montbéliard (for the department of Doubs and Haute-Saône and the territory of Belfort, where the churches of this denomination are principally situated). It also has a general synod—composed of 2 inspectors,¹ 5 pastors elected by the synod of Paris, and 6 by that of Montbéliard, 22 laymen and a delegate of the theological faculty at Paris—which holds periodical meetings and is represented in its relations with the government by a permanent executive commission.

The Jewish parishes, called *synagogues*, are grouped into departmental consistories (Paris, Bordeaux, Nancy, Marseilles, Bayonne, Lille, Vesoul, Besançon and three in Algeria). Each synagogue is served by a rabbi assisted by an officiating minister, and in each consistory is a grand rabbi. At Paris is the central consistory, controlled by the government and presided over by the supreme grand rabbi.

Agriculture.

Of the population of France some 17,000,000 depend upon agriculture for their livelihood, though only about 6,500,000 are engaged in work on the land. The cultivable land of the country occupies some 195,000 sq. m. or about 94% of the total area; of this 171,000 sq. m. are cultivated. There are besides 12,300 sq. m. of uncultivable area covered by lakes, rivers, towns, &c. Only the roughest estimate is possible as to the

¹ Inspectors are placed at the head of the synodal circumscriptions; their functions are to consecrate candidates for the ministry, install the pastors, &c.

sizes of holdings, but in general terms it may be said that about 3 million persons are proprietors of holdings under 25 acres in extent amounting to between 15 and 20% of the cultivated area, the rest being owned by some 750,000 proprietors, of whom 150,000 possess half the area in holdings averaging 400 acres in extent. About 80% of holdings (amounting to about 60% of the cultivated area) are cultivated by the proprietor; of the rest approximately 13% are let on lease and 7% are worked on the system known as *métayage* (*q.v.*).

The capital value of land, which greatly decreased during the last twenty years of the 19th century, is estimated at £3,120,000,000, and that of stock, buildings, implements, &c., at £340,000,000. The value per acre of land, which exceeds £48 in the departments of Seine, Rhône and those fringing the north-west coast from Nord to Manche inclusive, is on the average about £29, though it drops to £16 and less in Morbihan, Landes, Basses-Pyrénées, and parts of the Alps and the central plateau.

While wheat and wine constitute the staples of French agriculture, its distinguishing characteristic is the variety of its products. *Cereals* occupy about one-third of the cultivated area. For the production of *wheat*, in respect of which France is self-supporting, French Flanders, the Seine basin, notably the Beauce and the Brie, and the regions bordering on the lower course of the Loire and the upper course of the Garonne, are the chief areas. Rye, on the other hand, one of the least valuable of the cereals, is grown chiefly in the poor agricultural territories of the central plateau and western Brittany. Buckwheat is cultivated mainly in Brittany. Oats and barley are generally cultivated, the former more especially in the Parisian region, the latter in Mayenne and one or two of the neighbouring departments. Meslin, a mixture of wheat and rye, is produced in the great majority of French departments, but to a marked extent in the basin of the Sarthe. Maize covers considerable areas in Landes, Basses-Pyrénées and other south-western departments.

	Average Acreage (Thousands of Acres).		Average Production (Thousands of Bushels).		Average Yield per Acre (Bushels).	
	1886-1895.	1896-1905.	1886-1895.	1896-1905.	1886-1895.	1896-1905.
Wheat	17,004	16,580	294,564	317,707	17.3	19.1
Meslin	720	491	12,193	8,826	16.9	17.0
Rye	3,888	3,439	64,651	56,612	16.6	16.4
Barley	2,303	1,887	47,197	41,066	20.4	21.0
Oats	9,507	9,601	240,082	253,799	25.2	26.4
Buckwheat	1,484	1,392	26,345	23,136	17.7	16.6
Maize	1,391	1,330	25,723	24,459	18.4	18.4

Forage Crops.—The mangold-wurzel, occupying four times the acreage of swedes and turnips, is by far the chief root-crop in France. It is grown largely in the departments of Nord and Pas-de-Calais and in those of the Seine basin, the southern limit of its cultivation being roughly a line drawn from Bordeaux to Lyons. The average area occupied by it in the years from 1896 to 1905 was 1,043,000 acres, the total average production being 262,364,000 cwt. and the average production per acre 10½ tons. Clover, lucerne and sainfoin make up the bulk of artificial pasturage, while vetches, crimson clover and cabbage are the other chief forage crops.

Vegetables.—*Potatoes* are not a special product of any region, though grown in great quantities in the Bresse and the Vosges. Early potatoes and other vegetables (*primeurs*) are largely cultivated in the districts bordering the English Channel. Market-gardening is an important industry in the regions round Paris, Amiens and Angers, as it is round Toulouse, Montauban, Avignon and in southern France generally. The market-gardeners of Paris and its vicinity have a high reputation for skill in the forcing of early vegetables under glass.

Potatoes: Decennial Averages.

	Acreage.	Total Yield (Tons).	Average Yield per Acre (Tons).
1886-1895	3,690,000	11,150,000	3.02
1896-1905	3,735,000	11,594,000	3.1

Industrial Plants.—The manufacture of sugar from beetroot, owing to the increased use of sugar, became highly important during

² *Cultures industrielles*—Under this head the French grow beetroot, hemp, flax and other plants, the products of which pass through some process of manufacture before they reach the consumer.

the latter half of the 19th century, the industry both of cultivation and manufacture being concentrated in the northern departments of Aisne, Nord, Pas-de-Calais, Somme and Oise, the first named supplying nearly a quarter of the whole amount produced in France.

Flax and hemp showed a decreasing acreage from 1881 onwards. Flax is cultivated chiefly in the northern departments of Nord, Seine-Inférieure, Pas-de-Calais, Côtes-du-Nord, hemp in Sarthe, Morbihan and Maine-et-Loire.

Colza, grown chiefly in the lower basin of the Seine (Seine-Inférieure and Eure), is the most important of the oil-producing plants, all of which show a diminishing acreage. The three principal regions for the production of tobacco are the basin of the Garonne (Lot-et-Garonne, Dordogne, Lot and Gironde), the basin of the Isère (Isère and Savoie) and the department of Pas-de-Calais. The state controls its cultivation, which is allowed only in a limited number of departments. Hops cover only about 7000 acres, being almost confined to the departments of Nord, Côte d'Or and Meurthe-et-Moselle.

Decennial Averages 1896-1905.

	Acreage.	Production (Tons).	Average Yield per Acre (Tons).
Sugar beet . . .	672,000	6,868,000	10.2
Hemp	64,856	18,451 ¹	.28 ¹
Flax	57,893	17,857 ¹	.30 ¹
Colza	102,454	47,697	.46
Tobacco	41,564	22,453	.54

Vineyards (see WINE).—The vine grows generally in France, except in the extreme north and in Normandy and Brittany. The great wine-producing regions are:

1. The country fringing the Mediterranean coast and including Hérault (240,822,000 gals. in 1905), and Aude (117,483,000 gals. in 1905), the most productive departments in France in this respect.

2. The department of Gironde (95,559,000 gals. in 1905), whence come Médoc and the other wines for which Bordeaux is the market.

3. The lower valley of the Loire, including Touraine and Anjou, and the district of Saumur.

4. The valley of the Rhône.

5. The Burgundian region, including Côte d'Or and the valley of the Saône (Beaujolais, Mâconnais).

6. The Champagne.

7. The Charente region, the grapes of which furnish brandy, as do those of Armagnac (department of Gers).

The decennial averages for the years 1896-1905 were as follows:

Acreage of productive vines	4,056,725
Total production in gallons	1,072,622,000
Average production in gallons per acre	260

Fruit.—Fruit-growing is general all over France, which, apart from bananas and pine-apples, produces in the open air all the ordinary species of fruit which its inhabitants consume. Some of these may be specially mentioned. The cider apple, which ranks first in importance, is produced in those districts where cider is the habitual drink, that is to say,

chiefly in the region north-west of a line drawn from Paris to the mouth of the Loire. The average annual production of cider during the years 1896 to 1905 was 304,884,000 gallons. Dessert apples and pears are grown there and in the country on both banks of the lower Loire, the valley of which abounds in orchards wherein many varieties of fruit flourish and in nursery-gardens. The hilly regions of Limousin, Périgord and the Cévennes are the home of the chestnut, which in some places is still a staple food; walnuts grow on the lower levels of the central plateau and in lower Dauphiné and Provence, figs and almonds in Provence, oranges and citrons on the Mediterranean coast, apricots in central France, the olive in Provence and the lower valleys of the Rhône and Durance. Truffles are found under

Silk Cocoons.	1891-1895.	1896-1900.	1901-1905.
Annual average production over quinquennial periods in lb.	19,587,000	17,696,000	16,566,000

the oaks of Périgord, Comtat-Venaissin and lower Dauphiné. The mulberry grows in the valleys of the Rhône and its tributaries, the Isère, the Drôme, the Ardèche, the Gard and the Durance, and also

¹ Fibre only. In the years 1896-1905, 8130 tons of hemp-seed and 12,137 tons of flax-seed was the average annual production in addition to fibre.

along the coast of the Mediterranean. Silk-worm rearing, which is encouraged by state grants, is carried on in the valleys mentioned and on the Mediterranean coast east of Marseilles. The numbers of growers decreased from 139,000 in 1891 to 124,000 in 1905. The decrease in the annual average production of cocoons is shown in the preceding table.

Snails are reared in some parts of the country as an article of food, those of Burgundy being specially esteemed.

Stock-raising.—From this point of view the soil of France may be divided into four categories:

1. The rich pastoral regions where dairy-farming and the fattening of cattle are carried on with most success, viz. (a) Normandy, Perche, Cotentin and maritime Flanders, where horses are bred in great numbers; (b) the strip of coast between the Gironde and the mouth of the Loire; (c) the Morvan including the Nivernais and the Charolais, from which the famous Charolais breed of oxen takes its name; (d) the central region of the central plateau including the districts of Cantal and Aubrac, the home of the famous beef-breeds of Salers and Aubrac.² The famous *pré-salé* sheep are also reared in the Vendée and Cotentin.

2. The poorer grazing lands on the upper levels of the Alps, Pyrenees, Jura and Vosges, the Landes, the more outlying regions of the central plateau, southern Brittany, Sologne, Berry, Champagne-Pouilleuse, the Crau and the Camargue, these districts being given over for the most part to sheep-raising.

3. The plain of Toulouse, which with the rest of south-western France produces good draught oxen, the Parisian basin, the plains of the north to the east of the maritime region, the lower valley of the Rhône and the Bresse, where there is little or no natural pasturage, and forage is grown from seed.

4. West, west-central and eastern France outside these areas, where meadows are predominant and both dairying and fattening are general. Included therein are the dairying and horse-raising district of northern Brittany and the dairying regions of Jura and Savoy.

In the industrial regions of northern France cattle are stall-fed with the waste products of the beet-sugar factories, oil-works and distilleries. *Swine*, bred all over France, are more numerous in Brittany, Anjou (whence comes the well-known breed of Craon), Poitou, Burgundy, the west and north of the central plateau and Béarn. Upper Poitou and the zone of south-western France to the north of the Pyrenees are the chief regions for the breeding of mules. Asses are reared in Béarn, Corsica, Upper Poitou, the Limousin, Berry and other central regions. Goats are kept in the mountainous regions (Auvergne, Provence, Corsica). The best poultry come from the Bresse, the district of Houdan (Seine-et-Oise), the district of Le Mans and Crèvecœur (Calvados).

The *prés naturels* (meadows) and *herbages* (unmown pastures) of France, i.e. the grass-land of superior quality as distinguished from *paturages et pacages*, which signifies pasture of poorer quality, increased in area between 1895 and 1905 as is shown below:

	1895 (Acres).	1905 (Acres).
Prés naturels	10,852,000	11,715,000
Herbages	2,822,000	3,022,000

The following table shows the number of live stock in the country at intervals of ten years since 1885.

	Cattle.			Sheep and Lambs.	Pigs.	Horscs.	Mules.	Asses.
	Cows.	Other Kinds.	Total.					
1885	6,414,487	6,690,483	13,104,970	22,616,547	5,881,088	2,911,392	238,620	387,227
1895	6,359,795	6,874,033	13,233,828	21,163,767	6,306,019	2,812,447	211,479	357,778
1905	7,515,564	6,799,988	14,315,552	17,783,209	7,558,779	3,169,224	198,865	365,181

Agricultural Organization.—In France the interests of agriculture are entrusted to a special ministry, comprising the following divisions: (1) forests, (2) breeding-studs (*haras*); (3) agriculture, a department which supervises agricultural instruction and the distribution of grants and premiums; (4) agricultural improvements, draining, irrigation, &c.; (5) an intelligence department which prepares statistics, issues information as to prices and markets, &c. The minister is assisted by a superior council of agriculture, the members of which, numbering a hundred, include senators, deputies and prominent agriculturists. The ministry employs inspectors, whose duty it is to visit the different parts of the country and to report on their respective position and wants. The reports which they furnish help to determine the distribution of the moneys dispensed by the state in the form of subventions to agricultural

² The chief breeds of horses are the *Boulonnais* (heavy draught), the *Percheron* (light and heavy draught), the *Anglo-Norman* (light draught and heavy cavalry) and the *Tarbaïs* of the western Pyrenees (saddle horses and light cavalry). Of cattle besides the breeds named the *Norman* (beef and milk), the *Limousin* (beef), the *Montbéliard*, the *Basadaïs*, the *Flamand*, the *Breton* and the *Parthenais* breeds may be mentioned.

societies and in many other ways. The chief type of agricultural society is the *comice agricole*, an association for the discussion of agricultural problems and the organization of provincial shows. There are besides several thousands of local syndicates, engaged in the purchase of materials and sale of produce on the most advantageous terms for their members, credit banks and mutual insurance societies (see CO-OPERATION). Three societies demand special mention: the *Union centrale des agriculteurs de France*, to which the above syndicates are affiliated; the *Société nationale d'agriculture*, whose mission is to further agricultural progress and to supply the government with information on everything appertaining thereto and the *Société des agriculteurs de France*.

Among a variety of premiums awarded by the state are those for the best cultivated estates and for irrigation works, and to the owners of the best stallions and brood-mares. *Haras* or stallion stables containing in all over 3000 horses are established in twenty-two central towns, and annually send stallions, which are at the disposal of private individuals in return for a small fee, to various stations throughout the country. Other institutions belonging to the state are the national sheep-fold of Rambouillet (Seine-et-Oise) and the cow-house of Vieux-Pin (Orne) for the breeding of Durham cows. Four different grades of institution for agricultural instruction are under state direction: (1) farm-schools and schools of apprenticeship in dairying, &c., to which the age of admission is from 14 to 16 years; (2) practical schools, to which boys of from 13 to 18 years of age are admitted. These number forty-eight, and are intended for sons of farmers of good position; (3) national schools, which are established at Grignon (Seine-et-Oise), Rennes and Montpellier, candidates for which must be 17 years of age; (4) the National Agronomic Institute at Paris, which is intended for the training of estate agents, professors, &c. There are also departmental chairs of agriculture, the holders of which give instruction in training-colleges and elsewhere and advise farmers.

Forests.—In relation to its total extent, France presents but a very limited area of forest land, amounting to only 36,700 sq. m. or about 18% of the entire surface of the country. Included under the denomination of "forest" are lands—*surfaces boisées*—which are *bush* rather than *forest*. The most wooded parts of France are the mountains and plateaus of the east and of the north-east, comprising the pine-forests of the Vosges and Jura (including the beautiful Forest of Chauv), the Forest of Haye, the Forest of Ardennes, the Forest of Argonne, &c.; the Landes, where replanting with maritime pines has transformed large areas of marsh into forest; and the departments of Var and Ariège. The Central Mountains and the Morvan also have considerable belts of wood. In the Parisian region there are the Forests of Fontainebleau (66 sq. m.), of Compiègne (56 sq. m.), of Rambouillet, of Villers-Cotterets, &c. The Forest of Orléans, the largest in France, covers about 145 sq. m. The Alps and Pyrenees are in large part deforested, but reforestation with a view to minimizing the effects of avalanches and sudden floods is continually in progress.

Of the forests of the country approximately one-third belongs to the state, communes and public institutions. The rest belongs to private owners who are, however, subject to certain restrictions. The Department of Waters¹ and Forests (Administration des Eaux et Forêts) forms a branch of the ministry of agriculture. It is administered by a director-general, who has his headquarters at Paris, assisted by three administrators who are charged with the working of the forests, questions of rights and law, finance and plantation works. The establishment consists of 32 conservators, each at the head of a district comprising one or more departments, 200 inspectors, 215 sub-inspectors and about 300 *gardes généraux*. These officials form the higher grade of the service (*agents*). There are besides several thousand forest-rangers and other employes (*préposés*). The department is supplied with officials of the higher class from the National School of Waters and Forests at Nancy, founded in 1824.

Industries.

In France, as in other countries, the development of machinery,

¹The department is also entrusted with surveillance over river-fishing, pisciculture and the amelioration of pasture.

whether run by steam, water-power or other motive forces, has played a great part in the promotion of industry; the increase in the amount of steam horse-power employed in industrial establishments is, to a certain degree, an index to the activity of the country as regards manufactures.

The appended table shows the progress made since 1850 with regard to steam power. Railway and marine locomotives are not included.

Years.	No. of Establishments.	No. of Steam-Engines.	Total Horse-Power.
1852	6,543	6,080	76,000
1861	14,153	15,805	191,000
1871	22,192	26,146	316,000
1881	35,712	44,010	576,000
1891	46,828	58,967	916,000
1901	58,151	75,866	1,907,730
1905	61,112	79,203	2,232,263

With the exception of Loire, Bouches-du-Rhône and Rhône, the chief industrial departments of France are to be found in the north and north-east of the country. In 1901 and 1896 those in which the working inhabitants of both sexes were engaged in industry as opposed to agriculture to the extent of 50% (approximately) or over, numbered eleven, viz.:—

Departments.	Total Working Population (1901).	Industrial Population (1901).	Percentage engaged in Industry.	
			1901.	1896.
Nord	848,306	544,177	64.15	63.45
Territoire de Belfort	40,703	24,470	60.10	58.77
Loire	292,808	167,693	57.27	54.73
Seine	2,071,344	1,143,809	55.22	53.54
Bouches-du-Rhône	341,823	187,801	54.94	51.00
Rhône	449,121	243,571	54.23	54.78
Meurthe-et-Moselle	215,501	115,214	53.46	50.19
Ardennes	139,270	73,250	52.60	52.42
Vosges	208,142	107,547	51.67	51.05
Pas-de-Calais	404,153	200,402	49.58	46.55
Seine-Inférieure	428,591	206,612	48.21	49.85

The department of Seine, comprising Paris and its suburbs, which has the largest manufacturing population, is largely occupied with the manufacture of dress, millinery and articles of luxury (perfumery, &c.), but it plays the leading part in almost every great branch of industry with the exception of

Groups.	Basins.	Departments.	Average Production (Thousands of Metric Tons) 1901-1905.
Nord and Pas-de-Calais	Valenciennes Le Boulonnais	Nord, Pas-de-Calais Pas-de-Calais	20,965
Loire	St Étienne and Rive-de-Gier Communay Ste Foy l'Argentière Roannais	Loire Isère Rhône Loire	3,601
Gard	Alais Aubenas Le Vigan	Gard, Ardèche Ardèche Gard	1,954
Bourgogne and Nivernais	Decize La Chapelle-sous-Dun Bert Sincey ¹	Nièvre Saône-et-Loire Allier Côte-d'Or	1,881
Tarn and Aveyron	Aubin Carmaux and Albi Rodez St Perdox	Aveyron Tarn Aveyron Lot	1,770
Bourbonnais	Commentry and Doyet St Eloi L'Aumance La Queune	Allier Puy-de-Dôme Allier Allier	994

spinning and weaving. The typically industrial region of France is the department of Nord, the seat of the woollen industry, but also prominently concerned in other textile industries, in metal working, and in a variety of other manufactures, fuel for which is supplied by its coal-fields. The following sketch of the manufacturing industry of France takes account chiefly of those of its branches which are capable in some degree of localization. Many of the great industries of the country, e.g. tanning, brick-making, the manufacture of garments, &c., are evenly distributed throughout it, and are to be found in or near all larger centres of population.

Coal.—The principal mines of France are coal and iron mines. The production of coal and lignite averaging 33,465,000 metric tons¹ in the years 1901–1905 represents about 73% of the total consumption of the country; the surplus is supplied from Great Britain, Belgium and Germany. The preceding table shows the average output of the chief coal-groups for the years 1901–1905 inclusive. The Flemish coal-basin, employing over 100,000 hands, produces 60% of the coal mined in France.

French lignite comes for the most part from the department of Bouches-du-Rhône (near Fuveau).

The development of French coal and lignite mining in the 19th century, together with records of prices, which rose considerably at the end of the period, is set forth in the table below:

Years.	Average Yearly Production (Thousands of Metric Tons).	Average Price per Ton at Pit Mouth (Francs).
1821–1830	1,495	10·23
1831–1840	2,571	9·83
1841–1850	4,078·5	9·69
1851–1860	6,857	11·45
1861–1870	11,831	11·61
1871–1880	16,774	14·34
1881–1890	21,542	11·55
1891–1900	29,190	11·96
1901–1905	33,465	14·18

Iron.—The iron-mines of France are more numerous than its coal-mines, but they do not yield a sufficient quantity of ore for the needs of the metallurgical industries of the country; as will be seen in the table below the production of iron in France gradually increased during the 19th century; on the other hand, a decline in prices operated against a correspondingly marked increase in its annual value.

Years.	Average Annual Production (Thousands of Metric Tons).	Price per Metric Ton (Francs).
1841–1850	1247	6·76
1851–1860	2414·5	5·51
1861–1870	3035	4·87
1871–1880	2514	5·39
1881–1890	2934	3·99
1891–1900	4206	3·37
1901–1905	6072	3·72

The department of Meurthe-et-Moselle (basins of Nancy and Longwy-Briey) furnished 84% of the total output during the quinquennial period 1901–1905, may be reckoned as one of the principal iron-producing regions of the world. The other chief producers were Pyrénées-Orientales, Calvados, Haute-Marne (Vassy) and Saône-et-Loire (Mazenay and Change).

Other Ores.—The mining of zinc, the chief deposits of which are at Malines (Gard), Les Bormettes (Var) and Planioles (Lot), and of lead, produced especially at Chaliac (Ardèche), ranks next in importance to that of iron. Iron-pyrites come almost entirely from

Sain-Bel (Rhône), manganese chiefly from Ariège and Saône-et-Loire, antimony from the departments of Mayenne, Haute-Loire and Cantal. Copper and mispickel are mined only in small quantities. The table below gives the average production of zinc, argentiferous lead, iron-pyrites and other ores during the quinquennial period 1901–1905.

	Production (Thousands of Metric Tons).	Value £
Zinc . . .	60·3	206,912
Lead . . .	18·5	100,424
Iron-pyrites . . .	297·2	170,312
Other ores . . .	36·0	68,376

Salt, &c.—Rock-salt is worked chiefly in the department of Meurthe-et-Moselle, which produces more than half the average annual product of salt. For the years 1896–1905 this was 1,010,000 tons, including both rock- and sea-salt. The salt-marshes of the Mediterranean coast, especially the Étang de Berre and those of Loire-Inférieure, are the principal sources of sea-salt. Sulphur is obtained near Apt (Vaucluse) and in a few other localities of south-eastern France; bituminous schist near Autun (Saône-et-Loire) and Buxières (Allier). The most extensive peat-workings are in the valleys of the Somme; asphalt comes from Seyssel (Ain) and Puy-de-Dôme.

The mineral springs of France are numerous, of varied character and much frequented. Leading resorts are: in the Pyrenean region, Amélie-les-Bains, Bagnères-de-Luchon, Bagnères-de-Bigorre, Barèges, Cauterets, Eaux-Bonnes, Eaux-Chaudes and Dax; in the Central Plateau, Mont-Dore, La Bourboule, Bourbon l'Archambault, Vichy, Royat, Chaudes-Aigues, Vals, Lamalou; in the Alps, Aix-les-Bains and Evian; in the Vosges and Faucilles, Plombières, Luxeuil, Contrexéville, Vittel, Martigny and Bourbonne-les-Bains. Outside these main groups St Amand-les-Eaux and Foyes-les-Eaux may be mentioned.

Quarry-Products.—Quarries of various descriptions are numerous all over France. Slate is obtained in large quantities from the departments of Maine-et-Loire (Angers), Ardennes (Fumay) and Mayenne (Renazé). Stone-quarrying is specially active in the departments round Paris, Seine-et-Oise employing more persons in this occupation than any other department. The environs of Creil (Oise) and Château-Landon (Seine-et-Marne) are noted for their freestone (*Pierre de taille*), which is also abundant at Euville and Lérerville in Meuse; the production of plaster is particularly important in the environs of Paris, of kaolin of fine quality at Yrieix (Haute-Vienne), of hydraulic lime in Ardèche (Le Teil), of lime phosphates in the department of Somme, of marble in the departments of Haute-Garonne (St Bât), Hautes-Pyrénées (Campan, Sarrancolin), Isère and Pas-de-Calais, and of cement in Pas-de-Calais (vicinity of Boulogne) and Isère (Grenoble). Paving-stone is supplied in large quantities by Seine-et-Oise, and brick-clay is worked chiefly in Nord, Seine and Pas-de-Calais. The products of the quarries of France for the five years 1901–1905 averaged £9,311,000 per annum in value, of which building material brought in over two-thirds.

Metallurgy.—The average production and value of iron and steel manufactured in France in the last four decades of the 19th century is shown below:

Years.	Cast Iron.		Wrought Iron and Steel.	
	Product (Thousands of Metric Tons).	Value (Thousands of £).	Product (Thousands of Metric Tons).	Value (Thousands of £).
1861–1870	1191·5	5012	844	8,654
1871–1880	1391	5783	1058·5	11,776
1881–1890	1796	5119	1376	11,488
1891–1900	2267	5762	1686	14,540
1901–1905	2841	7334	1896	15,389

Taking the number of hands engaged in the industry as a basis of comparison, the most important departments as regards iron and steel working in 1901 were:

Department.	Chief Centres.	Hands engaged in Production of Pig-Iron and Steel.	Hands engaged in Production of Engineering Material and Manufactured Goods.
Seine		600	102,500
Nord	Lille, Anzin, Denain, Douai, Hautmont, Maubeuge	14,000	45,000
Loire	Rive-de-Gier, Firminy, St Étienne, St Chamond	9,500	17,500
Meurthe-et-Moselle	Pont-à-Mousson, Frouard, Longwy, Nancy	16,500	6,500
Ardennes	Charleville, Nouzon	800	23,000

¹ The metric ton = 1000 kilogrammes or 2204 lb.

Rhône (Lyons), Saône-et-Loire (Le Creusot, Chalon-sur-Saône) and Loire-Inférieure (Basse-Indre, Indret, Couëron, Trignac) also play a considerable part in this industry.

The chief centres for the manufacture of cutlery are Châtelleraut (Vienne), Langres (Haute-Marne) and Thiers (Puy-de-Dôme); for that of arms St Étienne, Tulle and Châtelleraut; for that of watches and clocks, Besançon (Doubs) and Montbéliard (Doubs); for that of optical and mathematical instruments Paris, Morez (Jura) and St Claude (Jura); for that of locksmiths' ware the region of Vimeu (Pas-de-Calais).

There are important zinc works at Auby and St Amand (Nord) and Viviez (Aveyron) and Noyelles-Godault (Pas-de-Calais); there are lead works at the latter place, and others of greater importance at Couëron (Loire-Inférieure). Copper is smelted in Ardennes and Pas-de-Calais. The production of these metals, which are by far the most important after iron and steel, increased steadily during the period 1890-1905, and reached its highest point in 1905, details for which year are given below:

	Zinc.	Lead.	Copper.
Production (in metric tons)	43,200	24,100	7,600
Value	£1,083,000	£386,000	£526,000

Wool.—In 1901, 161,000 persons were engaged in the spinning and other preparatory processes and in the weaving of wool. The woollen industry is carried on most extensively in the department of Nord (Roubaix, Tourcoing, Fourmies). Of second rank are Reims and Sedan in the Champagne group; Elbeuf, Louviers and Rouen in Normandy; and Mazamet (Tarn).

Cotton.—In 1901, 166,000 persons were employed in the spinning and weaving of cotton, French cotton goods being distinguished chiefly for the originality of their design. The cotton industry is distributed in three principal groups. The longest established is that of Normandy, having its centres at Rouen, Havre, Evreux, Falaise and Flers. Another group in the north of France has its centres at Lille, Tourcoing, Roubaix, St Quentin and Amiens. That of the Vosges, which has experienced a great extension since the loss of Alsace-Lorraine, comprises Epinal, St Dié, Remiremont and Belfort. Other groups of less importance are situated in the Lyonnais (Roanne and Tarare) and Mayenne (Laval and Mayenne).

Silk.—The silk industry occupied 134,000 hands in 1901. The silk fabrics of France hold the first place, particularly the more expensive kinds. The industry is concentrated in the departments bordering the river Rhône, the chief centres being Lyons (Rhône), Voiron (Isère), St Étienne and St Chamond (Loire) (the two latter being especially noted for their ribbons and trimmings) and Annonay (Ardèche) and other places in the departments of Ain, Gard and Drôme.

Flax, Hemp, Jute, &c.—The preparation and spinning of these materials and the manufacture of nets and rope, together with the weaving of linen and other fabrics, give occupation to 112,000 persons chiefly in the departments of Nord (Lille, Armentières, Dunkirk), Somme (Amiens) and Maine-et-Loire (Angers, Cholet).

Hosiery, the manufacture of which employs 55,000 hands, has its chief centre in Aube (Troyes). The production of lace and guipure, occupying 112,000 persons, is carried on mainly in the towns and villages of Haute-Loire and in Vosges (Mirecourt), Rhône (Lyons), Pas-de-Calais (Calais) and Paris.

Leather.—Tanning and leather-dressing are widely spread industries, and the same may be said of the manufacture of boots and shoes, though these trades employ more hands in the department of Seine than elsewhere; in the manufacture of gloves Isère (Grenoble) and Aveyron (Millau) hold the first place amongst French departments.

Sugar.—The manufacture of sugar is carried on in the departments of the north, in which the cultivation of beetroot is general—Aisne, Nord, Somme, Pas-de-Calais, Oise and Seine-et-Marne, the three first being by far the largest producers. The increase in production in the last twenty years of the 19th century is indicated in the following table:—

Years.	Annual Average of Men employed.	Average Annual Production in Metric Tons.
1881-1891	43,108	415,786
1891-1901	42,841	696,938
1901-1906	43,061	820,553

Alcohol.—The distillation of alcohol is in the hands of three classes of persons. (1) Professional distillers (*bouilleurs et distillateurs de profession*); (2) private distillers (*bouilleurs de cru*) under state control; (3) small private distillers, not under state control, but giving notice to the state that they distil. The two last classes number over 400,000 (1903), but the quantity of alcohol distilled by them is small. Beetroot, molasses and grain are the chief sources of spirit. The department of Nord produces by far the greatest quantity, its average annual output in the decade 1895-1904

being 13,117,000 gallons, or about 26% of the average annual production of France during the same period (49,945,000 gallons). Aisne, Pas-de-Calais and Somme rank next to Nord.

Glass is manufactured in the departments of Nord (Aiche, &c.), Seine, Loire (Rive-de-Gier) and Meurthe-et-Moselle, Baccarat in the latter department being famous for its table-glass. Limoges is the chief centre for the manufacture of porcelain, and the artistic products of the national porcelain factory of Sèvres have a world-wide reputation.

The manufacture of paper and cardboard is largely carried on in Isère (Voiron), Seine-et-Oise (Essonnes), Vosges (Epinal) and of the finer sorts of paper in Charente (Angoulême). That of oil, candles and soap has its chief centre at Marseilles. Brewing and malting are localized chiefly in Nord. There are well-known chemical works at Dombasle (close to Nancy) and Chauny (Aisne) and in Rhône.

Occupations.—The following table, which shows the approximate numbers of persons engaged in the various manufacturing industries of France, who number in all about 5,820,000, indicates their relative importance from the point of view of employment:

Occupation.	1901.	1866.
Baking	163,500	..
Milling	99,400	..
Charcuterie	39,600	..
Other alimentary industries	161,500	..
Alimentary industries: total	464,000	308,000
Gas-works	26,000	..
Tobacco factories	16,000	..
Oil-works	10,000	..
Other "chemical" industries	58,000	..
Chemical industries: total	110,000	49,000
Rubber factories	9,000	} 25,000
Paper factories	61,000	
Typographic and lithographic printing	76,000	..
Other branches of book production	23,000	..
Book production: total	99,000	38,000
Spinning and weaving	892,000	1,072,000
Clothing, millinery and making up of fabrics generally	1,484,000	} 761,000
Basket work, straw goods, feathers	39,000	
Leather and skin	338,000	286,000
Joinery	153,000	..
Builder's carpentering	94,900	..
Wheelwright's work	82,700	..
Cooperage	46,600	..
Wooden shoes	52,400	..
Other wood industries	280,400	..
Wood industries: total	710,000	671,000
Metallurgy and metal working	783,000	345,000
Goldsmiths' and jewellers' work	35,000	55,000
Stone-working	56,000	12,000
Construction, building, decorating	572,000	443,000
Glass manufacture	43,000	..
Tiles	29,000	..
Porcelain and faïence	27,000	..
Bricks	17,000	..
Other kiln industries	45,000	..
Kiln industries: total	161,000	110,000
Some 9000 individuals were engaged in unclassified industries.		

Fisheries.—The fishing population of France is most numerous in the Breton departments of Finistère, Côtes-du-Nord and Morbihan and in Pas-de-Calais. Dunkirk, Gravelines, Boulogne and Paimpol send considerable fleets to the Icelandic cod-fisheries, and St Malo, Fécamp, Granville and Cancale to those of Newfoundland. The Dogger Bank is frequented by numbers of French fishing-boats.

¹ Includes manufactories of gluc, tallow, soap, perfumery, fertilizers, soda, &c.

Besides the above, Boulogne, the most important fishing port in the country, Calais, Dieppe, Concarneau, Douarnenez, Les Sables d'Olonne, La Rochelle, Marennes and Arcachon are leading ports for the herring, sardine, mackerel and other coast-fisheries of the ocean, while Cette, Agde and other Mediterranean ports are engaged in the tunny and anchovy fisheries. Sardine preserving is an important industry at Nantes and other places on the west coast. Oysters are reared chiefly at Marennes, which is the chief French market for them, and at Arcachon, Vannes, Oléron, Auray, Cancale and Courseulles. The total value of the produce of fisheries increased from £4,537,000 in 1892 to £5,259,000 in 1902. In 1902 the number of men employed in the home fisheries was 144,000 and the number of vessels 25,481 (tonnage 127,000); in the deep-sea fisheries 10,500 men and 450 vessels (tonnage 51,000) were employed.

Communications.

Roads.—Admirable highways known as *routes nationales* and kept up at the expense of the state radiate from Paris to the great towns of France. Averaging 52½ ft. in breadth, they covered in 1905 a distance of nearly 24,000 m. The *École des Ponts et Chaussées* at Paris is maintained by the government for the training of the engineers for the construction and upkeep of roads and bridges. Each department controls and maintains the *routes départementales*, usually good macadamized roads connecting the chief places within its limits and extending in 1903 over 9700 m. The *routes nationales* and the *routes départementales* come under the category of *la grande voirie* and are under the supervision of the Ministry of Public Works. The urban and rural district roads, covering a much greater mileage and classed as *la petite voirie*, are maintained chiefly by the communes under the supervision of the Minister of the Interior.

Waterways.—The waterways of France, 7543 m. in length, of which canals cover 3031 m., are also classed under *la grande voirie*; they are the property of the state, and for the most part are free of tolls. They are divided into two classes. Those of the first class, which comprise rather less than half the entire system, have a minimum depth of 6½ ft., with locks 126 ft. long and 17 ft. wide; those of the second class are of smaller dimensions. Water traffic, which is chiefly in heavy merchandise, as coal, building materials, and agriculture and food produce, more than doubled in volume between 1881 and 1905. The canal and river system attains its greatest utility in the north, north-east and north-centre of the country; traffic is thickest along the Seine below Paris; along the rivers and small canals of the rich departments of Nord and Pas-de-Calais and along the Oise and the canal of St Quentin whereby they communicate with Paris; along the canal from the Marne to the Rhine and the succession of waterways which unite it with the Oise; along the Canal de l'Est (departments of Meuse and Ardennes); and along the waterways uniting Paris with the Saône at Chalon (Seine, Canal du Loing, Canal de Briare, Lateral canal of the Loire and Canal du Centre) and along the Saône between Chalon and Lyons.

In point of length the following are the principal canals:

	Miles.
Est (uniting Meuse with Moselle and Saône)	270
From Nantes to Brest	225
Berry (uniting Montluçon with the canalized Cher and the Loire canal)	163
Midi (Toulouse to Mediterranean via Béziers); see CANAL	175
Burgundy (uniting the Yonne and Saône)	151
Lateral canal of Loire	137
From Marne to Rhine (on French territory)	131
Lateral canal of Garonne	133
Rhône to Rhine (on French territory)	119
Nivernais (uniting Loire and Yonne)	111
Canal de la Somme	97
Centre (uniting Saône and Loire)	81
Canal de l'Ourcq	67
Ardennes (uniting Aisne and Canal de l'Est)	62
From Rhône to Cette	77
Canal de la Haute Marne	60
St Quentin (uniting Scheldt with Somme and Oise)	58

¹ See the *Guide officiel de la navigation intérieure* issued by the ministry of public works (Paris, 1903).

The chief navigable rivers are:

	Total navigated Length.	First Class Navigability.
	Miles.	Miles.
Seine	339	293
Aisne	37	37
Marne	114	114
Oise	99	65
Yonne	67	53
Rhône	309	30
Saône	234	234
Adour	72	21
Garonne	289	96
Dordogne	167	26
Loire	452	35
Charente	106	16
Vilaine	91	31
Escaut (in France)	39	39
Scarpe	41	41
Lys	45	45
Aa	18	18

Railways.—The first important line in France, from Paris to Rouen, was constructed through the instrumentality of Sir Edward Blount (1809–1905), an English banker in Paris, who was afterwards for thirty years chairman of the Ouest railway. After the rejection in 1838 of the government's proposals for the construction of seven trunk lines to be worked by the state, he obtained a concession for that piece of line on the terms that the French treasury would advance one-third of the capital at 3% if he would raise the remaining two-thirds, half in France and half in England. The contract for building the railway was put in the hands of Thomas Brassey; English navvies were largely employed on the work, and a number of English engine-drivers were employed when traffic was begun in 1843. A law passed in 1842 laid the foundation of the plan under which the railways have since been developed, and mapped out nine main lines, running from Paris to the frontiers and from the Mediterranean to the Rhine and to the Atlantic coast. Under it the cost of the necessary land was to be found as to one-third by the state and as to the residue locally, but this arrangement proved unworkable and was abandoned in 1845, when it was settled that the state should provide the land and construct the earthworks and stations, the various companies which obtained concessions being left to make the permanent way, provide rolling stock and work the lines for certain periods. Construction proceeded under this law, but not with very satisfactory results, and new arrangements had to be made between 1852 and 1857, when the railways were concentrated in the hands of six great companies, the Nord, the Est, the Ouest, the Paris-Lyon-Méditerranée, the Orléans and the Midi. Each of these companies was allotted a definite sphere of influence, and was granted a concession for ninety-nine years from its date of formation, the concessions thus terminating at various dates between 1950 and 1960. In return for the privileges granted them the companies undertook the construction out of their own unaided resources of 1500 m. of subsidiary lines, but the railway expenditure of the country at this period was so large that in a few years they found it impossible to raise the capital they required. In these circumstances the state agreed to guarantee the interest on the capital, the sums it paid in this way being regarded as advances to be reimbursed in the future with interest at 4%. This measure proved successful and the projected lines were completed. But demands for more lines were constantly arising, and the existing companies, in view of their financial position, were disinclined to undertake their construction. The government therefore found itself obliged to inaugurate a system of direct subventions, not only to the old large companies, but also to new small ones, to encourage the development of branch and local lines, and local authorities were also empowered to contribute a portion of the required capital. The result came to be that many small lines were begun by companies that had not the means to complete them, and again the state had to come to the rescue. In 1878 it agreed to spend £20,000,000 in purchasing and completing a number of

these lines, some of which were handed over to the great companies, while others were retained in the hands of the government, forming the system known as the Chemins de Fer de l'État. Next year a large programme of railway expansion was adopted, at an estimated cost to the state of £140,000,000, and from 1880 to 1882 nearly £40,000,000 was expended and some 1800 m. of line constructed. Then there was a change in the financial situation, and it became difficult to find the money required. In these circumstances the conventions of 1883 were concluded, and the great companies partially relieved the government of its obligations by agreeing to contribute a certain proportion of the cost of the new lines and to provide the rolling stock for working them. In former cases when the railways had had recourse to state aid, it was the state whose contributions were fixed, while the railways were left to find the residue; but on this occasion the position was reversed. The state further guaranteed a minimum rate of interest on the capital invested, and this guarantee, which by the convention of 1859 had applied to "new" lines only, was now extended to cover both "old" and "new" lines, the receipts and expenditure from both kinds being lumped together. As before, the sums paid out in respect of guaranteed dividend were to be regarded as advances which were to be paid back to the state out of the profits made, when these permitted, and when the advances were wiped out, the profits, after payment of a certain dividend, were to be divided between the state and the railway, two-thirds going to the former and one-third to the latter. All the companies, except the Nord, have at one time or another had to take advantage of the guarantee, and the fact that the Ouest had been one of the most persistent and heavy borrowers in this respect was one of the reasons that induced the government to take it over as from the 1st of January 1909. By the 1859 conventions the state railway system obtained an entry into Paris by means of running powers over the Ouest from Chartres, and its position was further improved by the exchange of certain lines with the Orléans company.

The great railway systems of France are as follows:

1. The Nord, which serves the rich mining, industrial and farming districts of Nord, Pas-de-Calais, Aisne and Somme, connecting with the Belgian railways at several points. Its main lines run from Paris to Calais, via Creil, Amiens and Boulogne, from Paris to Lille, via Creil and Arras, and from Paris to Maubeuge via Creil, Tergnier and St Quentin.
2. The Ouest-État, a combination of the West and state systems. The former traversed Normandy in every direction and connected Paris with the towns of Brittany. Its chief lines ran from Paris to Le Havre via Mantes and Rouen, to Dieppe via Rouen, to Cherbourg, to Granville and to Brest. The state railways served a large portion of western France, their chief lines being from Nantes via La Rochelle to Bordeaux, and from Bordeaux via Saintes, Niort and Saumur to Chartres.
3. The Est, running from Paris via Châlons and Nancy to Avricourt (for Strassburg), via Troyes and Langres to Belfort and on via Basel to the Saint Gotthard, and via Reims and Mezières to Longwy.
4. The Orléans, running from Paris to Orléans, and thence serving Bordeaux via Tours, Poitiers and Angoulême, Nantes via Tours and Angers, and Montauban and Toulouse via Vierzon and Limoges.
5. The Paris-Lyon-Méditerranée, connecting Paris with Marseilles via Moret, Laroche, Dijon, Mâcon and Lyons, and with Nîmes via Moret, Nevers and Clermont-Ferrand. It establishes communication between France and Switzerland and Italy via Mâcon and Culoz (for the Mt. Cenis Tunnel) and via Dijon and Pontarlier (for the Simplon), and also has a direct line along the Mediterranean coast from Marseilles to Genoa via Toulon and Nice.
6. The Midi (Southern) has lines radiating from Toulouse to Bordeaux via Agen, to Bayonne via Tarbes and Pau, and to Cette via Carcassonne, Narbonne and Béziers. From Bordeaux there is also a direct line to Bayonne and Irun (for Madrid), and at the other end of the Pyrenees a line leads from Narbonne to Perpignan and Barcelona.

The following table, referring to lines "of general interest," indicates the development of railways after 1885:

Year.	Mileage.	Receipts in Thousands of £.	Expenses in Thousands of £.	Passengers carried (1000's).	Goods carried (1000 Metric Tons).
1885	18,650	42,324	23,508	214,451	75,192
1890	20,800	46,145	24,239	241,119	92,506
1895	22,650	50,542	27,363	348,852	100,834
1900	23,818	60,674	32,966	453,193	126,830
1904	24,755	60,589	31,477	433,913	130,144

Narrow gauge and normal gauge railways "of local interest" covered 3905 m. in 1904.

Commerce.

After entering on a régime of free trade in 1860 France gradually reverted towards protection; this system triumphed in the Customs Law of 1892, which imposed more or less considerable duties on imports—a law associated with the name of M. Méline. While raising the taxes both on agricultural products and manufactured goods, this law introduced, between France and all the powers trading with her, relations different from those in the past. It left the government free either to apply to foreign countries the general tariff or to enter into negotiations with them for the application, under certain conditions, of a minimum tariff. The policy of protection was further accentuated by raising the impost on corn from 5 to 7 francs per hectolitre (2½ bushels). This system, however, which is opposed by a powerful party, has at various times undergone modifications. On the one hand it became necessary, in face of an inadequate harvest, to suspend in 1898 the application of the law on the import of corn. On the other hand, in order to check the decline of exports and neutralize the harmful effects of a prolonged customs war, a commercial treaty was in 1896 concluded with Switzerland, carrying with it a reduction, in respect of certain articles, of the imposts which had been fixed by the law of 1892. An accord was likewise in 1898 effected with Italy, which since 1886 had been in a state of economic rupture with France, and in July 1899 an accord was concluded with the United States of America. Almost all other countries, moreover, share in the benefit of the minimum tariff, and profit by the modifications it may successively undergo.

Being in the main a self-supporting country France carries on most of her trade within her own borders, and ranks below

Commerce, in Millions of Pounds Sterling.

	General			Special		
	Imports.	Exports.	Total.	Imports.	Exports.	Total.
1876-1880	210.1	175.3	385.4	171.7	135.1	306.8
1881-1885	224.1	177.8	401.9	183.4	135.3	318.7
1886-1890	208.2	179.4	387.6	168.8	137.6	306.4
1891-1895	205.9	178.6	384.5	163.0	133.8	296.8
1896-1900	237.8	201.0	438.8	171.9	150.8	322.7
1901-1905	233.3	227.5	460.8	182.8	174.7	357.5

Great Britain, Germany and the United States in volume of exterior trade. The latter is subdivided into *general* commerce, which includes all goods entering or leaving the country, and *special* commerce which includes imports for home use and exports of home produce. The above table shows the developments of French trade during the years from 1876 to 1905 by means of quinquennial averages. A permanent body (the *commission permanente des valeurs*) fixes the average prices of the

	Imports.		Exports.	
	Value (Thousands of £).	Per cent of Total Value.	Value (Thousands of £).	Per cent of Total Value.
Articles of Food—				
1886-1890	58,856	34.9	30,830	22.4
1891-1895	50,774	30.9	28,287	21.1
1896-1900	42,488	24.9	27,838	18.6
1901-1905	33,631	18.4	28,716	16.5
Raw Materials ¹				
1886-1890	85,778	50.8	33,848	24.6
1891-1895	88,211	54.3	32,557	24.4
1896-1900	101,727	59.2	40,060	26.6
1901-1905	116,580	63.8	47,385	27.1
Manufactured Articles ²				
1886-1890	24,125	14.3	72,917	53.0
1891-1895	24,054	14.8	72,906	54.5
1896-1900	27,330	15.9	82,270	54.8
1901-1905	32,554	17.8	98,582	56.4

¹ Includes horses, mules and asses.

² Except certain manufactures which come under the category of articles of food.

articles in the customs list; this value is estimated at the end of the year in accordance with the variations that have taken place and is applied provisionally to the following year.

Amongst imports raw materials (wool, cotton and silk, coal, oil-seeds, timber, &c.) hold the first place, articles of food (cereals, wine, coffee, &c.) and manufactured goods (especially machinery) ranking next. Amongst exports manufactured goods (silk, cotton and woollen goods, fancy wares, apparel, &c.) come before raw materials and articles of food (wine and dairy products bought chiefly by England).

Divided into these classes the imports and exports (special trade) for quinquennial periods from 1886 to 1905 averaged as shown in the preceding table.

The decline both in imports and in exports of articles of food, which is the most noteworthy fact exhibited in the preceding table, was due to the almost prohibitive tax in the Customs Law of 1892, upon agricultural products.

The average value of the principal articles of import and export (special trade) over quinquennial periods following 1890 is shown in the two tables below.

Principal Imports (Thousands of £).

	1891-1895.	1896-1900.	1901-1905.
Coal, coke, &c.	7,018	9,883	10,539
Coffee	6,106	4,553	3,717
Cotton, raw	7,446	7,722	11,987
Flax	2,346	2,435	3,173
Fruit and seeds (oleaginous)	7,175	6,207	8,464
Hides and skins, raw	6,141	5,261	6,369
Machinery	2,181	3,632	4,614
Silk, raw	9,488	10,391	11,765
Timber	6,054	6,284	6,760
Wheat	10,352	5,276	1,995
Wine	9,972	10,454	5,167
Wool, raw	13,372	16,750	16,395

Principal Exports (Thousands of £).

	1891-1895.	1896-1900.	1901-1905.
Apparel	4,726	4,513	5,079
Brandy and other spirits	2,402	1,931	1,678
Butter	2,789	2,783	2,618
Cotton manufactures	4,233	5,874	7,965
Haberdashery ¹	5,830	6,039	6,599
Hides, raw	2,839	3,494	4,813
Hides, tanned or curried	4,037	4,321	4,753
Iron and steel, manufactures of	..	2,849	4,201
Millinery	1,957	3,308	4,951
Motor cars and vehicles	..	160	2,147
Paper and manufactures of	2,095	2,145	2,551
Silk, raw, thrown, waste and cocoons	4,738	4,807	6,090
Silk and waste silk, manufactures of	9,769	10,443	11,463
Wine	8,824	9,050	9,139
Wool, raw	5,003	7,813	9,159
Wool, manufactures of	11,998	10,190	8,459

The following were the countries sending the largest quantities of goods (special trade) to France (during the same periods as in previous table).

Trade with Principal Countries. Imports (Thousands of £).

	1891-1895.	1896-1900.	1901-1905.
Germany	13,178	13,904	17,363
Belgium	15,438	13,113	13,057
United Kingdom	20,697	22,132	22,725
Spain	10,294	10,560	6,525 ²
United States	15,577	18,491	19,334
Argentine Republic	7,119	10,009	10,094

Other countries importing largely into France are Russia, Algeria and British India, whose imports in each case averaged over £9,000,000 in value in the period 1901-1905; China (average value £7,000,000); and Italy (average value £6,000,000).

The following are the principal countries receiving the exports of France (special trade), with values for the same periods.

Trade with Principal Countries. Exports (Thousands of £).

	1891-1895.	1896-1900.	1901-1905.
Germany	13,712	16,285	21,021
Belgium	19,857	22,135	24,542
United Kingdom	39,310	45,203	49,156
United States	9,337	9,497	10,411
Algeria	7,872	9,434	11,652

The other chief customers of France were Switzerland and Italy, whose imports from France averaged in 1901-1905 nearly £10,000,000 and over £7,200,000 respectively in value. In the same period Spain received exports from France averaging £4,700,000.

The trade of France was divided between foreign countries and her colonies in the following proportions (imports and exports combined).

	General Trade.		Special Trade.	
	Foreign Countries.	Colonies.	Foreign Countries.	Colonies.
1891-1895	92.00	8.00	90.89	9.11
1896-1900	91.18	8.82	89.86	10.14
1901-1905	90.41	9.59	88.78	11.22

The respective shares of the leading customs in the trade of the country is approximately shown in the following table, which gives the value of their exports and imports (general trade) in 1905 in millions sterling.

	£	£	
Marseilles	88.8	Boulogne	17.5
Le Havre	79.5	Calais	14.1
Paris	42.8	Dieppe	13.5
Dunkirk	34.8	Rouen	11.3
Bordeaux	27.4	Belfort-Petit-Croix	10.7

In the same year the other chief customs in order of importance were Tourcoing, Jeumont, Cette, St Nazaire and Avricourt.

The chief local bodies concerned with commerce and industry are the *chambres de commerce* and the *chambres consultatives d'arts et manufactures*, the members of which are elected from their own number by the traders and industrialists of a certain standing. They are established in the chief towns, and their principal function is to advise the government on measures for improving and facilitating commerce and industry within their circumscription. See also BANKS AND BANKING; SAVINGS BANKS; POST AND POSTAL SERVICE.

Shipping.—The following table shows the increase in tonnage of sailing and steam shipping engaged in foreign trade entered and cleared at the ports of France over quinquennial periods from 1890.

	Entered.		Cleared.	
	French.	Foreign.	French.	Foreign.
1891-1895	4,277,967	9,947,893	4,521,928	10,091,000
1896-1900	4,665,268	12,037,571	5,005,563	12,103,358
1901-1905	4,782,101	14,744,626	5,503,463	14,823,217

The increase of the French mercantile marine (which is fifth in importance in the world) over the same period is traced in the following table. Vessels of 2 net tons and upwards are enumerated.

	Sailing.		Steam.		Total.	
	Number of Vessels.	Tonnage.	Number of Vessels.	Tonnage.	Number of Vessels.	Tonnage.
1891-1895	14,183	402,982	1182	502,363	15,365	905,345
1896-1900	14,327	437,468	1231	504,674	15,558	942,142
1901-1905	14,867	642,562	1388	617,536	16,255	1,260,098

At the beginning of 1908 the total was 17,193 (tonnage, 1,402,647); of these 13,601 (tonnage, 81,833) were vessels of less than 20 tons, while 502 (tonnage, 1,014,506) were over 800 tons.

The increase in the tonnage of sailing vessels, which in other countries tends to decline, was due to the bounties voted by parliament to its merchant sailing fleet with the view of increasing the number of skilled seamen. The prosperity of the French shipping trade is hampered by the costliness of shipbuilding and by the scarcity of outward-bound cargo. Shipping has been fostered by paying bounties for vessels constructed in France and sailing under the French flag, and by reserving the coasting trade, traffic between France and Algeria, &c., to French vessels. Despite these monopolies, three-fourths of the shipping in French ports is foreign, and France is without shipping companies comparable in importance to those of other great maritime nations. The three chief companies are the *Messageries Maritimes* (Marseilles and Bordeaux), the *Compagnie Générale Transatlantique* (Le Havre, St Nazaire and Marseilles) and the *Chargeurs Réunis* (Le Havre).

¹ Includes small fancy wares, toys, also wooden wares and furniture, brushes, &c.

² Decrease largely due to Spanish-American War (1898).

Government and Administration.

Central Government.—The principles upon which the French constitution is based are representative government (by two chambers), manhood suffrage, responsibility of ministers and irresponsibility of the head of the state. Alterations or modifications of the constitution can only be effected by the National Assembly, consisting of both chambers sitting together *ad hoc*. The legislative power resides in these two chambers—the Senate and the Chamber of Deputies; the executive is vested in the president of the republic and the ministers. The members of both chambers owe their election to universal suffrage; but the Senate is not elected directly by the people and the Chamber of Deputies is.

The Chamber of Deputies, consisting of 584 members, is elected by the *scrutin d'arrondissement* (each elector voting for one deputy) for a term of four years, the conditions of election being as follows: Each *arrondissement* sends one deputy if its population does not exceed 100,000, and an additional deputy for every additional 100,000 inhabitants or fraction of that number. Every citizen of twenty-one years of age, unless subject to some legal disability, such as actual engagement in military service, bankruptcy or condemnation to certain punishments, has a vote, provided that he can prove a residence of six months' duration in any one town or commune. A deputy must be a French citizen, not under twenty-five years old. Each candidate must make, at least five days before the elections, a declaration setting forth in what constituency he intends to stand. He may only stand for one, and all votes given for him in any other than that specified in the declaration are void. To secure election a candidate must at the first voting poll an absolute majority and a number of votes equal to one-fourth of the number of electors. If a second poll is necessary a relative majority is sufficient.

The Senate (see below, *Law and Institutions*) is composed of 300 members who must be French citizens at least forty years of age. They are elected by the "*scrutin de liste*" for a period of nine years, and one-third of the body retires every three years. The department which is to elect a senator when a vacancy occurs is settled by lot.

Both senators and deputies receive a salary of £600 per annum. No member of a family that has reigned in France is eligible for either chamber.

Bills may be proposed either by ministers (in the name of the president of the republic), or by private members, and may be initiated in either chamber, but money-bills must be submitted in the first place to the Chamber of Deputies. Every bill is first examined by a committee, a member of which is chosen to "report" on it to the chamber, after which it must go through two readings (*délibérations*), before it is presented to the other chamber. Either house may pass a vote of no confidence in the government, and in practice the government resigns in face of the passing of such a vote by the deputies, but not if it is passed by the Senate only. The chambers usually assemble in January each year, and the ordinary session lasts not less than five months; usually it continues till July. There is an extraordinary session from October till Christmas.

The president (see below, *Law and Institutions*) is elected for

seven years, by a majority of votes, by the Senate and Chamber of Deputies sitting together as the National Assembly. Any French citizen may be chosen president, no fixed age being required. The only exception to this rule is that no member of a royal family which has once reigned in France can be elected. The president receives 1,200,000 francs (£48,000) a year, half as salary, half for travelling expenses and the charges incumbent upon the official representative of the country. Both the chambers are summoned by the president, who has the power of dissolving the Chamber of Deputies with the assent of the Senate. When a change of Government occurs the president chooses a prominent parliamentarian as premier and president of the council. This personage, who himself holds a portfolio, nominates the other ministers, his choice being subject to the ratification of the chief of the state. The ministerial council (*conseil des ministres*) is presided over by the president of the republic; less formal meetings (*conseils de cabinet*) under the presidency of the premier, or even of some other minister, are also held.

The ministers, whether members of parliament or not, have the right to sit in both chambers and can address the house whenever they choose, though a minister may only vote in the chamber of which he happens to be a member. There are twelve ministries¹ comprising those of justice; finance; war; the interior; marine; colonies; public instruction and fine arts; foreign affairs; commerce and industry; agriculture; public works; and labour and public thrift. Individual ministers are responsible for all acts done in connexion with their own departments, and the body of ministers collectively is responsible for the general policy of the government.

The council of state (*conseil d'état*) is the principal council of the head of the state and his ministers, who consult it on various legislative problems, more particularly on questions of administration. It is divided for despatch of business into four sections, each of which corresponds to a group of two or three ministerial departments, and is composed of (1) 32 councillors "*en service ordinaire*" (comprising a vice-president and sectional presidents), and 19 councillors "*en service extraordinaire*," i.e. government officials who are deputed to watch the interests of the ministerial departments to which they belong, and in matters not concerned with those departments have a merely consultative position; (2) 32 *maîtres des requêtes*; (3) 40 auditors.

The presidency of the council of state belongs *ex officio* to the minister of justice.

The theory of "*droit administratif*" lays down the principle that an agent of the government cannot be prosecuted or sued for acts relating to his administrative functions before the ordinary tribunals. Consequently there is a special system of administrative jurisdiction for the trial of "*le contentieux administratif*" or disputes in which the administration is concerned. The council of state is the highest administrative tribunal, and includes a special "*Section du contentieux*" to deal with judicial work of this nature.

Local Government.—France is divided into 86 administrative departments (including Corsica) or 87 if the Territory of Belfort, a remnant of the Haut Rhin department, be included. These departments are subdivided into 362 *arrondissements*, 2911 cantons and 36,222 communes.

Departments.	Capital Towns.	Ancient Provinces. ²
AIN	Bourg	Bourgogne (Bresse, Bugey, Valromey, Dombes).
AISNE	Laon	Île-de-France; Picardie.
ALLIER	Moulins	Bourbonnais.
ALPES-MARITIMES	Nice	
ARDÈCHE	Privas	Languedoc (Vivarais).
AROENNES	Mézières	Champagne.
ARIÈGE	Foix	Foix; Gascogne (Cousérans).
AUBE	Troyes	Champagne; Bourgogne.
AUDE	Carcassonne	Languedoc.
AVEYRON	Rodez	Guienne (Rouergue).

¹ The administration of posts, telegraphs and telephones is assigned to the ministry of commerce and industry or to that of public works.

² The province or provinces named are those out of which the department was chiefly formed.

Departments.	Capital Towns.	Ancient Provinces.
BASSES-ALPES	Digne	Provence.
BASSES-PYRÉNÉES	Pau	Béarn; Gascogne (Basse-Navarre, Soule, Labourd).
BELFORT, TERRITOIRE DE	Belfort	Alsace.
BOUCHES-DU-RHÔNE	Marseilles	Provence.
CALVADOS	Caen	Normandie (Bessin, Bocage).
CANTAL	Aurillac	Auvergne.
CHARENTE	Angoulême	Angoumois; Saintonge.
CHARENTE-INFÉRIEURE	La Rochelle	Aunis; Saintonge.
CHER	Bourges	Berry; Bourbonnais.
CORRÈZE	Tulle	Limousin.
CÔTE-D'OR	Dijon	Bourgogne (Dijonnais, Auxois).
CÔTES-DU-NORD	St Brienc	Bretagne.
CREUSE	Guéret	Marche.
DEUX-SÈVRES	Niort	Poitou.
DORDOGNE	Périgueux	Guienne (Périgord).
DOUBS	Besançon	Franche-Comté; Montbéliard.
DRÔME	Valence	Dauphiné.
EURE	Évreux	Normandie; Perche.
EURE-ET-LOIR	Chartres	Orléanais; Normandie.
FINISTÈRE	Quimper	Bretagne.
GARD	Nîmes	Languedoc.
GERS	Auch	Gascogne (Astarac, Armagnac).
GIRONDE	Bordeaux	Guienne (Bordelais, Bazadais).
HAUTE-GARONNE	Toulouse	Languedoc; Gascogne (Comminges).
HAUTE-LOIRE	Le Puy	Languedoc (Velay); Auvergne; Lyonnais.
HAUTE-MARNE	Chaumont	Champagne (Bassigny, Vallage).
HAUTES-ALPES	Gap	Dauphiné.
HAUTE-SAÔNE	Vesoul	Franche-Comté.
HAUTE-SAVOIE	Annecy	
HAUTES-PYRÉNÉES	Tarbes	Gascogne.
HAUTE-VIENNE	Limoges	Limousin; Marche.
HÉRAULT	Montpellier	Languedoc.
ILLE-ET-VILAINE	Rennes	Bretagne.
INDRE	Châteauroux	Berry.
INDRE-ET-LOIRE	Tours	Touraine.
ISÈRE	Grenoble	Dauphiné.
JURA	Lons-le-Saunier	Franche-Comté.
LANDES	Mont-de-Marsan	Gascogne (Landes, Chalosse).
LOIRE	St-Étienne	Lyonnais.
LOIRE-INFÉRIEURE	Nantes	Bretagne.
LOIRET	Orléans	Orléanais (Orléanais proper, Gâtinais, Dunois).
LOIR-ET-CHER	Blois	Orléanais.
LOT	Cahors	Guienne (Quercy).
LOT-ET-GARONNE	Agen	Guienne; Gascogne.
LOZÈRE	Mende	Languedoc (Gévaudan).
MAINE-ET-LOIRE	Angers	Anjou.
MANCHE	St-Lô	Normandie (Cotentin).
MARNE	Châlons-sur-Marne	Champagne.
MAYENNE	Laval	Maine; Anjou.
MEURTHE-ET-MOSELLE	Nancy	Lorraine; Trois-Évêchés.
MEUSE	Bar-le-Duc	Lorraine (Barrois, Verdunois).
MORBIHAN	Vannes	Bretagne.
NIÈVRE	Nevers	Nivernais; Orléanais.
NORD	Lille	Flandre; Hainaut.
OISE	Beauvais	Île-de-France.
ORNE	Alençon	Normandie; Perche.
PAS-DE-CALAIS	Arras	Artois; Picardie.
PUY-DE-DÔME	Clermont-Ferrand	Auvergne.
PYRÉNÉES-ORIENTALES	Perpignan	Roussillon; Languedoc.
RHÔNE	Lyon	Lyonnais; Beaujolais.
SAÔNE-ET-LOIRE	Mâcon	Bourgogne.
SARTHE	Le Mans	Maine; Anjou.
SAVOIE	Chambéry	
SEINE	Paris	Île-de-France.
SEINE-ET-MARNE	Melun	Île-de-France; Champagne.
SEINE-ET-OISE	Versailles	Île-de-France.
SEINE-INFÉRIEURE	Rouen	Normandie.
SOMME	Amiens	Picardie.
TARN	Albi	Languedoc (Albigeois).
TARN-ET-GARONNE	Montauban	Guienne; Gascogne; Languedoc.
VAR	Draguignan	Provence.
VAUCLUSE	Avignon	Comtat; Venaissin; Provence; Principauté d'Orange.
VENDÉE	La Roche-sur-Yon	Poitou.
VIENNE	Poitiers	Poitou; Touraine.
VOSGES	Épinal	Lorraine.
YONNE	Auxerre	Bourgogne; Champagne.
CORSE (CORSIKA)	Ajaccio	Corse.

Before 1790 France was divided into thirty-three great and seven small military governments, often called provinces, which are, however, to be distinguished from the provinces formed under the feudal system. The great governments were: Alsace, Saintonge and Angoumois, Anjou, Artois, Aunis, Auvergne, Béarn and Navarre, Berry, Bourbonnais, Bourgogne (Burgundy), Bretagne (Brittany), Champagne, Dauphiné, Flandre, Foix, Franche-Comté, Guienne and Gascogne (Gascony), Île-de-France, Languedoc, Limousin, Lorraine, Lyonnais, Maine, Marche, Nivernais, Normandie, Orléanais, Picardie,

Poitou, Provence, Roussillon, Touraine and Corse. The eight small governments were: Paris, Boulogne and Boulonnais, Le Havre, Sedan, Toulous, Pays Messin and Verdunois and Saumurois.

At the head of each department is a prefect, a political official nominated by the minister of the interior and appointed by the president, who acts as general agent of the government and representative of the central authority. To aid him the prefect

has a general secretary and an advisory body (*conseil de préfecture*), the members of which are appointed by the president, which has jurisdiction in certain classes of disputes arising out of administration and must, in certain cases, be consulted, though the prefect is not compelled to follow its advice. The prefect supervises the execution of the laws; has wide authority in regard to policing, public hygiene and relief of pauper children; has the nomination of various subordinate officials; and is in correspondence with the subordinate functionaries in his department, to whom he transmits the orders and instructions of the government. Although the management of local affairs is in the hands of the prefect his power with regard to these is checked by a deliberative body known as the general council (*conseil général*). This council, which consists for the most part of business and professional men, is elected by universal suffrage, each canton in the department contributing one member. The general council controls the departmental administration of the prefect, and its decisions on points of local government are usually final. It assigns its quota of taxes (*contingent*) to each *arrondissement*, authorizes the sale, purchase or exchange of departmental property, superintends the management thereof, authorizes the construction of new roads, railways or canals, and advises on matters of local interest. Political questions are rigorously excluded from its deliberations. The general council, when not sitting, is represented by a permanent delegation (*commission départementale*).

As the prefect in the department, so the sub-prefect in the *arrondissement*, though with a more limited power, is the representative of the central authority. He is assisted, and in some degree controlled, in his work by the district council (*conseil d'arrondissement*), to which each canton sends a member, chosen by universal suffrage. As the *arrondissement* has neither property nor budget, the principal business of the council is to allot to each commune its share of the direct taxes imposed on the *arrondissement* by the general council.

The canton is purely an administrative division, containing, on an average, about twelve communes, though some exceptional communes are big enough to contain more than one canton. It is the seat of a justice of the peace, and is the electoral unit for the general council and the district council.

The communes, varying greatly in area and population, are the administrative units in France. The chief magistrate of the commune is the mayor (*maire*), who is (1) the agent of the central government and charged as such with the local promulgation and execution of the general laws and decrees of the country; (2) the executive head of the municipality, in which capacity he supervises the police, the revenue and public works of the commune, and acts as the representative of the corporation in general. He also acts as registrar of births, deaths and marriages, and officiates at civil marriages. Mayors are usually assisted by deputies (*adjoints*). In a commune of 2500 inhabitants or less there is one deputy; in more populous communes there may be more, but in no case must the number exceed twelve, except at Lyons, where as many as seventeen are allowed. Both mayors and deputy mayors are elected by and from among members of the municipal council for four years. This body consists, according to the population of the commune, of from 10 to 36 members, elected for four years on the principle of the *scrutin de liste* by Frenchmen who have reached the age of twenty-one years and have a six months' residence qualification.

The local affairs of the commune are decided by the municipal council, and its decisions become operative after the expiration of a month, save in matters which involve interests transcending those of the commune. In such cases the prefect must approve them, and in some cases the sanction of the general council or even ratification by the president is necessary. The council also chooses communal delegates to elect senators; and draws up the list of *répartiteurs*, whose function is to settle how the commune's share of direct taxes shall be allotted among the taxpayers. The sub-prefect then selects from this list ten of whom he approves for the post. The meetings of the council are open to the public.

Justice.

The ordinary judicial system of France comprises two classes of courts: (1) civil and criminal, (2) special, including courts dealing only with purely commercial cases; in addition there are the administrative courts, including bodies, the Conseil d'État and the Conseils de Préfecture, which deal, in their judicial capacity, with cases coming under the *droit administratif*. Mention may also be made of the Tribunal des Conflits, a special court whose function it is to decide which is the competent tribunal when an administration and a judicial court both claim or refuse to deal with a given case.

Taking the first class of courts, which have both civil and criminal jurisdiction, the lowest tribunal in the system is that of the *juge de paix*.

In each canton is a *juge de paix*, who in his capacity as a civil judge takes cognizance, without appeal, of disputes where the amount sought to be recovered does not exceed £12 in value. Where the amount exceeds £12 but not £24 an appeal lies from his decision to the court of first instance. In some particular cases where special promptitude or local knowledge is necessary, as disputes between hotelkeepers and travellers, and the like, he has jurisdiction (subject to appeal to the court of first instance) up to £60. He has also a criminal jurisdiction in *contraventions*, i.e. breaches of law punishable by a fine not exceeding 12s. or by imprisonment not exceeding five days. If the sentence be one of imprisonment or the fine exceeds 4s., appeal lies to the court of first instance. It is an important function of the *juge de paix* to endeavour to reconcile disputants who come before him, and no suit can be brought before the court of first instance until he has endeavoured without success to bring the parties to an agreement.

Tribunaux de première instance, also called *tribunaux d'arrondissement*, of which there is one in every *arrondissement* (with few exceptions), besides serving as courts of appeal from the *juges de paix* have an original jurisdiction in matters civil and criminal. The court consists of a president, one or more vice-presidents and a variable number of judges. A *procureur*, or public prosecutor, is also attached to each court. In civil matters the tribunal takes cognizance of actions relating to personal property to the value of £60, and actions relating to land to the value of 60 fr. (£2: 8s.) per annum. When it deals with matters involving larger sums an appeal lies to the courts of appeal. In penal cases its jurisdiction extends to all offences of the class known as *délits*—offences punishable by a more serious penalty than the "contraventions" dealt with by the *juge de paix*, but not entailing such heavy penalties as the code applies to *crimes*, with which the assize courts (see below) deal. When sitting in its capacity as a criminal court it is known as the *tribunal correctionnel*. Its judgments are invariably subject in these matters to appeal before the court of appeal.

There are twenty-six courts of appeal (*cours d'appel*), to each of which are attached from one to five departments.

Cours d'Appel.	Departments depending on them.
PARIS . . .	Seine, Aube, Eure-et-Loir, Marne, Seine-et-Marne, Seine-et-Oise, Yonne.
AGEN . . .	Gers, Lot, Lot-et-Garonne.
AIX . . .	Basses-Alpes, Alpes-Maritimes, Bouches-du-Rhône, Var.
AMIENS . . .	Aisne, Oise, Somme.
ANGERS . . .	Maine-et-Loire, Mayenne, Sarthe.
BASTIA . . .	Corse.
BESANÇON . . .	Doubs, Jura, Haute-Saône, Territoire de Belfort.
BORDEAUX . . .	Charente, Dordogne, Gironde.
BOURGES . . .	Cher, Indre, Nièvre.
CAEN . . .	Calvados, Manche, Orne.
CHAMBERY . . .	Savoie, Haute-Savoie.
DIJON . . .	Côte-d'Or, Haute-Marne, Saône-et-Loire.
DOUAI . . .	Nord, Pas-de-Calais.
GRENOBLE . . .	Hautes-Alpes, Drôme, Isère.
LIMOGES . . .	Corrèze, Creuse, Haute-Vienne.
LYONS . . .	Ain, Loire, Rhône.
MONTPELLIER . . .	Aude, Aveyron, Hérault, Pyrénées-Orientales.
NANCY . . .	Meurthe-et-Moselle, Meuse, Vosges, Ardennes.
NÎMES . . .	Ardeche, Gard, Lozère, Vaucluse.

Cours d'Appel.	Departments depending on them.
ORLÉANS . . .	Indre-et-Loire, Loir-et-Cher, Loiret.
PAU . . .	Landes, Basses-Pyrénées, Hautes-Pyrénées.
POITIERS . . .	Charente-Inférieure, Deux-Sèvres, Vendée, Vienne.
RENNES . . .	Côtes-du-Nord, Finistère, Ille-et-Vilaine, Loire-Inférieure, Morbihan.
RIOM . . .	Allier, Cantal, Haute-Loire, Puy-de-Dôme.
ROUEN . . .	Eure, Seine-Inférieure.
TOULOUSE . . .	Ariège, Haute-Garonne, Tarn, Tarn-et-Garonne.

At the head of each court, which is divided into sections (*chambres*), is a *premier président*. Each section (*chambre*) consists of a *président de chambre* and four judges (*conseillers*). *Procureurs-généraux* and *avocats-généraux* are also attached to the *parquet*, or permanent official staff, of the courts of appeal. The principal function of these courts is the hearing of appeals both civil and criminal from the courts of first instance; only in some few cases (e.g. discharge of bankrupts) do they exercise an original jurisdiction. One of the sections is termed the *chambre des mises en accusation*. Its function is to examine criminal cases and to decide whether they shall be referred for trial to the lower courts or the *cours d'assises*. It may also dismiss a case on grounds of insufficient evidence.

The *cours d'assises* are not separate and permanent tribunals. Every three months an assize is held in each department, usually at the chief town, by a *conseiller*, appointed *ad hoc*, of the court of appeal upon which the department depends. The *cour d'assises* occupies itself entirely with offences of the most serious type, classified under the penal code as *crimes*, in accordance with the severity of the penalties attached. The president is assisted in his duties by two other magistrates, who may be chosen either from among the *conseillers* of the court of appeal or the presidents or judges of the local court of first instance. In this court and in this court alone there is always a jury of twelve. They decide, as in England, on facts only, leaving the application of the law to the judges. The verdict is given by a simple majority.

In all criminal prosecutions, other than those coming before the *juge de paix*, a secret preliminary investigation is made by an official called a *juge d'instruction*. He may either dismiss the case at once by an order of "non-lieu," or order it to be tried, when the prosecution is undertaken by the *procureur* or *procureur-général*. This process in some degree corresponds to the manner in which English magistrates dismiss a case or commit the prisoner to quarter sessions or assizes, but the powers of the *juge d'instruction* are more arbitrary and absolute.

The highest tribunal in France is the *cour de cassation*, sitting at Paris, and consisting of a first president, three sectional presidents and forty-five *conseillers*, with a ministerial staff (*parquet*) consisting of a *procureur-général* and six *avocates-généraux*. It is divided into three sections: the *Chambre des Requetes*, or court of petitions, the civil court and the criminal court. The *cour de cassation* can review the decision of any other tribunal, except administrative courts. Criminal appeals usually go straight to the criminal section, while civil appeals are generally taken before the *Chambre des Requetes*, where they undergo a preliminary examination. If the demand for re-hearing is refused such refusal is final; but if it is granted the case is then heard by the civil chamber, and after argument *cassation* (annulment) is granted or refused. The Court of Cassation does not give the ultimate decision on a case; it pronounces, not on the question of fact, but on the legal principle at issue, or the competence of the court giving the original decision. Any decision, even one of a *cour d'assises*, may be brought before it in the last resort, and may be *cassé*—annulled. If it pronounces *cassation* it remits the case to the hearing of a court of the same order.

Commercial courts (*tribunaux de commerce*) are established in all the more important commercial towns to decide as expeditiously as possible disputed points arising out of business transactions. They consist of judges, chosen, from among the leading merchants, and elected by *commerçants patentés depuis cinq ans*, i.e. persons who have held the licence to trade (see FINANCE) for

five years and upwards. In the absence of a *tribunal de commerce* commercial cases come before the ordinary *tribunal d'arrondissement*.

In important industrial towns tribunals called *conseils de prud'hommes* are instituted to deal with disputes between employers and employees, actions arising out of contracts of apprenticeship and the like. They are composed of employers and workmen in equal numbers and are established by decree of the council of state, advised by the minister of justice. The minister of justice is notified of the necessity for a *conseil de prud'hommes* by the prefect, acting on the advice of the municipal council and the Chamber of Commerce or the Chamber of Arts and Manufactures. The judges are elected by employers and workmen of a certain standing. When the amount claimed exceeds £12 appeal lies to the *tribunaux d'arrondissement*.

Police.—Broadly, the police of France may be divided into two great branches—administrative police (*la police administrative*) and judicial police (*la police judiciaire*), the former having for its object the maintenance of order, and the latter charged with tracing out offenders, collecting the proofs, and delivering the presumed offenders to the tribunals charged by law with their trial and punishment. Subdivisions may be, and often are, named according to the particular duties to which they are assigned, as *la police politique*, *police des mœurs*, *police sanitaire*, &c. The officers of the judicial police comprise the *juge de paix* (equivalent to the English police magistrate), the *maire*, the *commissaire de police*, the *gendarmerie* and, in rural districts, the *gardes champêtres* and the *gardes forestiers*. *Gardiens de la paix* (sometimes called *sergents de ville*, *gardes de ville* or *agents de police*) are not to be confounded with the *gendarmerie*, being a branch of the administrative police and corresponding more or less nearly with the English equivalent "police constables," which the *gendarmerie* do not, although both perform police duty. The *gendarmerie*, however, differ from the *agents* or *gardes* both in uniform and in the fact that they are for the most part country patrols. The organization of the Paris police, which is typical of that in other large towns, may be outlined briefly. The central administration (*administration centrale*) comprises three classes of functions which together constitute *la police*. First there is the office or *cabinet* of the prefect for the general police (*la police générale*), with bureaux for various objects, such as the safety of the president of the republic, the regulation and order of public ceremonies, theatres, amusements and entertainments, &c.; secondly, the judicial police (*la police judiciaire*), with numerous bureaux also, in constant communication with the courts of judicature; thirdly, the administrative police (*la police administrative*) including bureaux, which superintend navigation, public carriages, animals, public health, &c. Concurrently with these divisions there is the municipal police, which comprises all the agents in enforcing police regulations in the streets or public thoroughfares, acting under the orders of a chief (*chef de la police municipale*) with a central bureau. The municipal police is divided into two principal branches—the service in uniform of the *agents de police* and the service out of uniform of *inspecteurs de police*. In Paris the municipal police are divided among the twenty *arrondissements*, which the uniform police patrol (see further PARIS and POLICE).

Prisons.—The prisons of France, some of them attached to the ministry of the interior, are complex in their classification. It is only from the middle of the 19th century that close attention has been given to the principle of individual separation. Cellular imprisonment was, however, partially adopted for persons awaiting trial. Central prisons, in which prisoners lived and worked in association, had been in existence from the commencement of the 19th century. These prisons received all sentenced to short terms of imprisonment, the long-term convicts going to the *bagues* (the great convict prisons at the arsenals of Rochefort, Brest and Toulon), while in 1851 transportation to penal colonies was adopted. In 1869 and 1871 commissions were appointed to inquire into prison discipline, and as a consequence of the report of the last commission, issued in 1874, the principle of cellular

confinement was put in operation the following year. There were, however, but few prisons in France adapted for the cellular system, and the process of reconstruction has been slow. In 1898 the old Paris prisons of Grande-Roquette, Saint-Pélagie and Mazas were demolished, and to replace them a large prison with 1500 cells was erected at Fresnes-lès-Rungis. There are (1) the *maison d'arrêt*, temporary places of duration in every arrondissement for persons charged with offences, and those sentenced to more than a year's imprisonment who are awaiting transfer to a *maison centrale*; (2) the *maison de justice*, often part and parcel of the former, but only existing in the assize court towns for the safe custody of those tried or condemned at the assizes; (3) departmental prisons, or *maisons de correction*, for summary convictions, or those sentenced to less than a year, or, if provided with sufficient cells, those amenable to separate confinement; (4) *maisons centrales* and *pénitenciers agricoles*, for all sentenced to imprisonment for more than a year, or to hard labour, or to those condemned to *travaux forcés* for offences committed in prison. There are eleven *maisons centrales*, nine for men (Loos, Clairvaux, Beaulieu, Poissy, Melun, Fontevault, Thouars, Riom and Nîmes); two for women (Rennes and Montpellier). The *pénitenciers agricoles* only differ from the *maisons centrales* in the matter of régime; there are two—at Castelluccio and at Chiavari (Corsica). There are also reformatory establishments for juvenile offenders, and *dépôts de sûreté* for prisoners who are travelling, at places where there are no other prisons. For the penal settlements at a distance from France see DEPORTATION.

Finance.

At the head of the financial organization of France, and exercising a general jurisdiction, is the minister of finance, who co-ordinates in one general budget the separate budgets prepared by his colleagues and assigns to each ministerial department the sums necessary for its expenses.

The financial year in France begins on the 1st of January, and the budget of each financial year must be laid on the table of the Chamber of Deputies in the course of the ordinary session of the preceding year in time for the discussion upon it to begin in October and be concluded before the 31st of December. It is then submitted to a special commission of the Chamber of Deputies, elected for one year, who appoint a general reporter and one or more special reporters for each of the ministries. When the Chamber of Deputies has voted the budget it is submitted to a similar course of procedure in the Senate. When the budget has passed both chambers it is promulgated by the president under the title of *Loi des finances*. In the event of its not being voted before the 31st of December, recourse is had to the system of "provisional twelfths" (*douzièmes provisoires*), whereby the government is authorized by parliament to incur expenses for one, two or three months on the scale of the previous year. The expenditure of the government has several times been regulated for as long as six months upon this system.

In each department an official collector (*Trésorier payeur général*) receives the taxes and public revenue collected therein and accounts for them to the central authority in Paris. In view of his responsibilities he has, before appointment, to pay a large deposit to the treasury. Besides receiving taxes, they pay the creditors of the state in their departments, conduct all operations affecting departmental loans, buy and sell government stock (*rentes*) on behalf of individuals, and conduct certain banking operations. The *trésorier* nearly always lives at the chief town of the department, and is assisted by a *receveur particulier des finances* in each arrondissement (except that in which the *trésorier* himself resides). From the *receveur* is demanded a security equal to five times his total income. The direct taxes are actually collected by *percepteurs*. In the commune an official known as the *receveur municipal* receives all moneys due to it, and, subject to the authorization of the mayor, makes all payments due from it. In communes with a revenue of less than £2400 the *percepteur* fulfils the functions of *receveur municipal*, but a special official may be appointed in communes with large incomes.

The direct taxes fall into two classes. (1) *Impôts de répartition* (apportionment), the amount to be raised being fixed in advance annually and then apportioned among the departments. They

include the land tax,¹ the personal and habitation tax (*contribution personnelle-mobilière*), and door and window tax. (2) *Impôts de quotité*, which are levied directly on the individual, who pays his quota according to a fixed tariff. These comprise the tax on buildings¹ and the trade-licence tax (*impôt des patentes*). Besides these, certain other taxes (*taxes assimilées aux contributions directes*) are included under the heading of direct taxation, e.g. the tax on property in mortmain, dues for the verification of weights and measures, the tax on royalties from mines, on horses, mules and carriages, on cycles, &c.

The land tax falls upon land not built upon in proportion to its net yearly revenue. It is collected in accordance with a register of property (*cadastre*) drawn up for the most part in the first half of the 19th century, dealing with every piece of property in France, and giving its extent and value and the name of the owner. The responsibility of keeping this register accurate and up to date is divided between the state, the departments and the communes, and involves a special service and staff of experts. The building tax consists of a levy of 3-20% of the rental value of the property, and is charged upon the owner.

The personal and habitation tax consists in fact of two different taxes, one imposing a fixed capitation charge on all citizens alike of every department, the charge, however, varying according to the department from 1 fr. 50 c. (1s. 3d.) to 4 frs. 50 c. (3s. 9d.), the other levied on every occupier of a furnished house or of apartments in proportion to its rental value.

The tax on doors and windows is levied in each case according to the number of apertures, and is fixed with reference to population, the inhabitants of the more populous paying more than those of the less populous communes.

The trade-licence tax (*impôt des patentes*) is imposed on every person carrying on any business whatever; it affects professional men, bankers and manufacturers, as well as wholesale and retail traders, and consists of (1) a fixed duty levied not on actual profits but with reference to the extent of a business or calling as indicated by number of employés, population of the locality and other considerations. (2) An assessment on the letting value of the premises in which a business or profession is carried on.

The administrative staff includes, for the purpose of computing the individual quotas of the direct taxes, a director assisted by *contrôleurs* in each department and subordinate to a central authority in Paris, the *direction générale des contributions directes*.

The indirect taxes comprise the charges on registration; stamps; customs; and a group of taxes specially described as "indirect taxes."

Registration (*enregistrement*) duties are charged on the transfer of property in the way of business (*à titre onéreux*); on changes in ownership effected in the way of donation or succession (*à titre gratuit*), and on a variety of other transactions which must be registered according to law. The revenue from stamps includes as its chief items the returns from stamped paper, stamps on goods traffic, securities and share certificates and receipts and cheques.

The *Direction générale de l'enregistrement, des domaines et du timbre*, comprising a central department and a director and staff of agents in each department, combines the administration of state property (not including forests) with the exaction of registration and stamp duties.

The Customs (*douane*), at one time only a branch of the administration of the *contributions indirectes*, were organized in 1869 as a special service. The central office at Paris consists of a *directeur général* and two *administrateurs*, nominated by the president of the republic. These officials form a council of administration presided over by the minister of finance. The service in the departments comprises *brigades*, which are actually engaged in guarding the frontiers, and a clerical staff (*service de bureau*) entrusted with the collection of the duties. There are twenty-four districts, each under the control of a *directeur*, assisted by inspectors, sub-inspectors and other officials. The chief towns of these districts are Algiers, Bayonne, Besançon, Bordeaux, Boulogne, Brest, Chambéry, Charleville, Dunkirk, Épinal, La Rochelle, Le Havre, Lille, Lyons, Marseilles, Montpellier, Nancy, Nantes, Nice, Paris, Perpignan, Rouen, St-Malo, Valenciennes. There is also an official performing the functions of a director at Bastia, in Corsica.

The group specially described as indirect taxes includes those on alcohol, wine, beer, cider and other alcoholic drinks, on passenger and goods traffic by railway, on licences to distillers, spirit-sellers, &c., on salt and on sugar of home manufacture. The collection of these excise duties as well as the sale of matches, tobacco and gunpowder to retailers, is assigned to a special service in each department subordinated to a central administration. To the above taxes must be added the tax on Stock Exchange transactions and the tax of 4% on dividends from stocks and shares (other than state loans).

Other main sources of revenue are: the domains and forests managed by the state; government monopolies, comprising tobacco, matches, gunpowder; posts, telegraphs, telephones; and *lata*

¹ The tax on land (*propriétés non bâties*) and that on buildings (*propriétés bâties*) are included under the head of *contribution foncière*.

railways. An administrative tribunal called the *cour des comptes* subjects the accounts of the state's financial agents (*trésoriers-payeurs, receveurs* of registration fees, of customs, of indirect taxes, &c.) and of the communes¹ to a close investigation, and a vote of definitive settlement is finally passed by parliament. The *Cour des Comptes*, an ancient tribunal, was abolished in 1791, and reorganized by Napoleon I. in 1807. It consists of a president and 110 other officials, assisted by 25 auditors. All these are nominated for life by the president of the republic. Besides the accounts of the state and of the communes, those of charitable institutions¹ and training colleges¹ and a great variety of other public establishments are scrutinized by the *Cour des Comptes*.

The following table shows the rapid growth of the state revenue of France during the period 1875-1905, the figures for the specified years representing millions of pounds.

1875.	1880.	1885.	1890.	1895.	Average 1896-1900.	Average 1901-1905.
108	118	122	129	137	144	147

Of the revenue in 1905 (150½ million pounds) the four direct taxes produced approximately 20 millions. Other principal items of revenue were: Registration 25 millions, stamps 7½ millions, customs 18 millions, inland revenue on liquors 16½ millions, receipts from the tobacco monopoly 18 millions, receipts from post office 10½ millions.

Since 1875 the expenditure of the state has passed through considerable fluctuations. It reached its maximum in 1883, descended in 1888 and 1889, and since then has continuously increased. It was formerly the custom to divide the credits voted for the discharge of the public services into two heads—the ordinary and extraordinary budget. The ordinary budget of expenditure was that met entirely by the produce of the taxes, while the extraordinary budget of expenditure was that which had to be incurred either in the way of an immediate loan or in aid of the funds of the floating debt. The policy adopted after 1890 of incorporating in the ordinary budget the expenditure on war, marine and public works, each under its own head, rendered the "extraordinary budget" obsolete, but there are still, besides the ordinary budget, *budgets annexes*, comprising the credits voted to certain establishments under state supervision, e.g. the National Savings Bank, state railways, &c. The growth of the expenditure of France is shown in the following summary figures, which represent millions of pounds.

1875.	1880.	1885.	1890.	1895.	Average 1896-1900.	Average 1901-1905.
117	135	139	132	137	143	147

The chief item of expenditure (which totalled 148 million pounds in 1905) is the service of the public debt, which in 1905 cost 48½ million pounds sterling. Of the rest of the sum assigned to the ministry of finance (59½ millions in all) 8½ millions went in the expense of collection of revenue. The other ministries with the largest outgoings were the ministry of war (the expenditure of which rose from 25½ millions in 1895 to over 30 millions in 1905), the ministry of marine (10½ millions in 1895, over 12½ millions in 1905), the ministry of public works (with an expenditure in 1905 of over 20 millions, 10 millions of which was assigned to posts, telegraphs and telephones) and the ministry of public instruction, fine arts and public worship, the expenditure on education having risen from 7½ millions in 1895 to 9½ millions in 1905.

Public Debt.—The national debt of France is the heaviest of any country in the world. Its foundation was laid early in the 15th century, and the continuous wars of succeeding centuries, combined with the extravagance of the monarchs, as well as deliberate disregard of financial and economic conditions, increased it at an alarming rate. The duke of Sully carried out a revision in 1604, and other attempts were made by Mazarin and Colbert, but the extravagances of Louis XV. swelled it again heavily. In 1764 the national debt amounted to 2,360,000,000 livres, and the annual charge to 93,000,000 livres. A consolidation was effected in 1793, but the lavish issue of assignats (*q.v.*) destroyed whatever advantage might have accrued, and the debt was again dealt with by a law of the 9th of Vendémiaire year VI. (27th of September 1797), the annual interest paid yearly to creditors then amounting to 40,216,000 francs (£1,600,000). During the Directory a sum of £250,000 was added to the interest charge, and by 1814 this annual charge had risen to £2,530,000. This large increase is to be accounted for by the fact that during the Napoleonic régime the government steadily refused to issue inconvertible paper currency or to meet war expenditure by borrowing. The following table shows the increase of the funded debt since 1814.²

Date.	Nominal Capital (Millions of £.).	Interest (Millions of £.).
April 1, 1814	50½	2½
April 1, 1830	177	8
March 1, 1848	238½	9
January 1, 1852	220½	9½
" 1871	498½	15½
" 1876	796½	30
" 1887	986½	34½
" 1895	1038½	32½
" 1905	1037½	31

The French debt as constituted in 1905 was made up of funded debt and floating debt as follows:

<i>Funded Debt.</i>	
Perpetual 3% <i>rentes</i>	£888,870,400
Terminable 3% <i>rentes</i>	148,490,400
Total of funded debt	<u>£1,037,360,800</u>
Guarantees to railway companies, &c. (in capital)	£89,724,080
Other debt in capital	46,800,840
<i>Floating Debt.</i>	
Exchequer bills	£9,923,480
Liabilities on behalf of communes and public establishments, including departmental services	17,366,520
Deposit and current accounts of Caisse des dépôts, &c., including savings banks	15,328,840
Caution money of Trésoriers payeurs-généraux	1,431,680
Other liabilities	6,456,200
Total of floating debt	<u>£50,506,720</u>

Departmental Finances.—Every department has a budget of its own, which is prepared and presented by the prefect, voted by the departmental council and approved by decree of the president of the republic. The ordinary receipts include the revenues from the property of the department, the produce of *additional centimes*, which are levied in conjunction with the direct taxes for the maintenance of both departmental and communal finances, state subventions and contributions of the communes towards certain branches of poor relief and to maintenance of roads. The chief expenses of the departments are the care of pauper children and lunatics, the maintenance of high-roads and the service of the departmental debt.

Communal Finances.—The budget of the commune is prepared by the mayor, voted by the municipal council and approved by the prefect. But in communes the revenues of which exceed £120,000, the budget is always submitted to the president of the republic. The ordinary revenues include the produce of "additional centimes" allocated to communal purposes, the rents and profits of communal property, sums produced by municipal taxes and dues, concessions to gas, water and other companies, and by the *octroi (q.v.)* or duty on a variety of articles imported into the commune for local consumption. The repairing of highways, the upkeep of public buildings, the support of public education, the remuneration of numerous officials connected with the collection of state taxes, the keeping of the *cadastre*, &c., constitute the principal objects of communal expenditure.

Both the departments and the communes have considerable public debts. The departmental debt in 1904 stood at 24 million pounds, and the communal debt at 153 million pounds. (R. Tr.)

Army.

Recruiting and Strength.—Universal compulsory service was adopted after the disasters of 1870-1871, though in principle it had been established by Marshal Niel's reforms a few years before that date. The most important of the recruiting laws passed since 1870 are those of 1872, 1889 and 1905, the last the "loi de deux ans" which embodies the last efforts of the French war department to keep pace with the ever-growing numbers of the German empire. Compulsory service with the colours is in Germany no longer universal, as there are twice as many able-bodied men presented by the recruiting commissions as the active army can absorb. France, with a greatly inferior population, now trains every man who is physically capable. This law naturally made a deep impression on military Europe, not merely because the period of colour service was reduced—Germany had taken this step years before—but because of the almost entire absence of the usual exemptions.

³ In 1894 the *rentes* then standing at 4½% were reduced to 3½%, and in 1902 to 3%.

¹ With revenues of over £1200.

² For a history of the French debt, see C. F. Bastable, *Public Finance* (1903).

Even bread-winners are required to serve, the state pensioning their dependants (75 centimes per diem, up to 10% of the strength) during their period of service. Dispensations, and also the one-year voluntariat, which had become a short cut for the so-called "intellectual class" to employment in the civil service rather than a means of training reserve officers, were abolished. Every Frenchman therefore is a member of the army practically or potentially from the age of twenty to the age of forty-five. Each year there is drawn up in every commune a list of the young men who attained the age of twenty during the previous year. These young men are then examined by a revising body (*Conseil de révision cantonal*) composed of civil and military officials. Men physically unfit are wholly exempted, and men who have not, at the time of the examination, attained the required physical standard are put back for re-examination after an interval. Men who, otherwise suitable, have some slight infirmity are drafted into the non-combatant branches. The minimum height for the infantry soldier is 1.54 m., or 5 ft. $\frac{1}{2}$ in., but men of special physique are taken below this height. In 1904, under the old system of three-years' service with numerous total and partial exemptions, 324,253 men became liable to incorporation, of whom 25,432 were rejected as unfit, 55,265 were admitted as one-year volunteers, 62,160 were put back, 27,825 had already enlisted with a view to making the army a career, 5257 were taken for the navy, and thus, with a few extra details and casualties, the contingent for full service dwindled to 147,549 recruits. In 1906, 326,793 men had to present themselves, 25,348 had already enlisted, 4923 went to the navy, 68,526 were put back, 33,777 found unfit, which, deducting 3128 details, gives an actual incorporated contingent of 191,091 young men of twenty-one to serve for two full years (in each case, for the sake of comparison, men put back from former years who were enrolled are omitted). In theory a two-years' contingent of course should be half as large again as a three-years' one, but in practice, France has not men enough for so great an increase. Still the law of 1905 provides a system whereby there is room with the colours for every available man, and moreover ensures his services. The net gain in the 1906 class is not far short of 50,000, and the proportion of the new contingent to the old is practically 5:4. The *loi des cadres* of 1907 introduced many important changes of detail supplementary to the *loi de deux ans*. Important changes were also made in the provisions and administration of military law. The active army, then, at a given moment, say November 1, 1908, is composed of all the young men, not legally exempted, who have reached the age of twenty in the years 1906 and 1907. It is at the disposal of the minister of war, who can decree the recall of all men discharged to the reserve the previous year and all those whose time of service has for any reason been shortened. The reserves of the active army are composed of those who have served the legal period in the active army. These are recalled twice, in the eleven years during which they are members of the reserve, for refresher courses. The active army and its reserve are not localized, but drawn from and distributed over the whole of France. The advantages of a purely territorial system have tempted various War Ministers to apply it, but the results were not good, owing to the want of uniformity in the military qualities and the political subordination of the different districts. One result of this is that mobilization and concentration are much slower processes than they are in Germany.

The Territorial Army and its reserve (members of which undergo two short periods of training) are, however, allocated to local service. The soldier spends six years in the Territorial Army, and six in the reserve of the Territorial Army. The reserves of the active army and the Territorial Army and its reserve can only be recalled to active service in case of emergency and by decree of the head of the state.

The total service rendered by the individual soldier is thus twenty-five years. He is registered at the age of twenty, is called to the colours on the 1st of October of the next year, discharged to the active army reserve on the 30th of September of the second year thereafter, to the Territorial Army at the

same date thirteen complete years after his incorporation, and finally discharged from the reserve of the Territorial Army on the twenty-fifth anniversary of his entry into the active army. On November 1, 1908, then the active army was composed of the classes registered 1906 and 1907, the reserve of the classes 1895-1905, the Territorial Army of those of 1889-1894 and the Territorial Army reserve of those of 1883-1888.

In 1906 the peace strength of the army in France was estimated at 532,593 officers and men; in Algeria 54,580; in Tunis 20,320; total 607,493. Deducting vacancies, sick and absent, the effective strength of the active army in 1906 was 540,563; of the gendarmerie and Garde Républicaine 24,512; of colonial troops in the colonies 58,568. The full number of persons liable to be called upon for military service and engaged in such service is calculated (1908) as 4,800,000, of whom 1,350,000 of the active army and the younger classes of army reserve would constitute the field armies set on foot at the outbreak of war. 150,000 horses and mules are maintained on a peace footing and 600,000 on a war footing.

Organization.—The general organization of the French army at home is based on the system of permanent army corps, the headquarters of which are as follows: I. Lille, II. Amiens, III. Rouen, IV. Le Mans, V. Orléans, VI. Châlons-sur-Marne, VII. Besançon, VIII. Bourges, IX. Tours, X. Rennes, XI. Nantes, XII. Limoges, XIII. Clermont-Ferrand, XIV. Lyons, XV. Marseilles, XVI. Montpellier, XVII. Toulouse, XVIII. Bordeaux, XIX. Algiers and XX. Nancy. Each army corps consists in principle of two infantry divisions, one cavalry brigade, one brigade of horse and field artillery, one engineer battalion and one squadron of train. But certain army corps have a special organization. The VI. corps (Châlons) and the VII. (Besançon) consist of three divisions each, and the XIX. (Algiers) has three divisions of its own as well as the division occupying Tunis. In addition to these corps there are eight permanent cavalry divisions with headquarters at Paris, Lunéville, Meaux, Sedan, Reims, Lyons, Melun and Dôle. The military government of Paris is independent of the army corps system and comprises, besides a division of the colonial army corps (see below), 3½ others detached from the II., III., IV. and V. corps, as well as the 1st and 3rd cavalry divisions and many smaller bodies of troops. The military government of Lyons is another independent and special command; it comprises practically the XIV. army corps and the 6th cavalry division. The infantry division consists of 2 brigades, each of 2 regiments of 3 or 4 battalions (the 4 battalion regiments have recently been reduced for the most part to 3), with 1 squadron cavalry and 12 batteries, attached from the corps troops, in war a proportion of the artillery would, however, be taken back to form the corps artillery (see ARTILLERY and TACTICS). The cavalry division consists of 2 or 3 brigades, each of 2 regiments or 8 squadrons, with 2 horse artillery batteries attached. The army corps consists of headquarters, 2 (or 3) infantry divisions, 1 cavalry brigade, 1 artillery brigade (2 regiments, comprising 21 field and 2 horse batteries), 1 engineer battalion, &c. In war a group of "Rimailho" heavy howitzers (see ORDNANCE: *Heavy Field and Light Siege Units*) would be attached. It is proposed, and accepted in principle, to increase the number of guns in the army corps by converting the horse batteries in 18 army corps to field batteries, which, with other measures, enables the number of the latter to be increased to 36 (144 guns).

The organization of the "metropolitan troops" by regiments is (a) 163 regiments of line infantry, some of which are affected to "regional" duties and do not enter into the composition of their army corps for war, 31 battalions of *chasseurs à pied*, mostly stationed in the Alps and the Vosges, 4 regiments of Zouaves, 4 regiments of Algerian tirailleurs (natives, often called Turcos¹), 2 foreign legion regiments, 5 battalions of African light infantry (disciplinary regiments), &c.; (b) 12

¹ Algerian native troops are recruited by voluntary enlistment. But in 1908, owing to the prevailing want of trained soldiers in France, it was proposed to set free the white troops in Algeria by applying the principles of universal service to the natives, as in Tunis.

regiments of cuirassiers, 32 of dragoons, 21 of *chasseurs à cheval*, 14 of hussars, 6 of *chasseurs d'Afrique* and 4 of Spahis (Algerian natives); (c) 40 regiments of artillery, comprising 445 field batteries, 14 mountain batteries and 52 horse batteries (see, however, above), 18 battalions of garrison artillery, with in addition 13 companies of artificers, &c.; (d) 6 regiments of engineers forming 22 battalions, and 1 railway regiment; (e) 20 squadrons of train, 27 legions of gendarmerie and the Paris Garde Républicaine, administrative and medical units.

Colonial Troops.—These form an expeditionary army corps in France to which are attached the actual corps of occupation to the various colonies, part white, part natives. The colonial army corps, headquarters at Paris, has three divisions, at Paris, Toulon and Brest.

The French colonial (formerly marine) infantry, recruited by voluntary enlistment, comprises 18 regiments and 5 independent battalions (of which 12 regiments are at home), 74 batteries of field, fortress and mountain artillery (of which 32 are at home), with a few cavalry and engineers, &c., and other services in proportion. The native troops include 13 regiments and 8 independent battalions. The strength of this army corps is 28,700 in France and 61,300 in the colonies.

Command.—The commander-in-chief of all the armed forces is the president of the Republic, but the practical direction of affairs lies in the hand of the minister of war, who is assisted by the *Conseil supérieur de la guerre*, a body of senior generals who have been selected to be appointed to the higher commands in war. The vice-president is the destined commander-in-chief of the field armies and is styled the generalissimo. The chief of staff of the army is also a member of the council. In war the latter would probably remain at the ministry of war in Paris, and the generalissimo would have his own chief of staff. The ministry of war is divided into branches for infantry, cavalry, &c.—and services for special subjects such as military law, explosives, health, &c. The general staff (*état major de l'armée*) has its functions classed as follows: personnel; material and finance; 1st bureau (organization and mobilization), 2nd (intelligence), 3rd (military operations and training) and 4th (communications and transport); and the famous historical section. The president of the Republic has a military household, and the minister a cabinet, both of which are occupied chiefly with questions of promotion, patronage and decorations.

The general staff and also the staff of the corps and divisions are composed of certificated (*brevetés*) officers who have passed all through the *École de Guerre*. In time of peace an officer is attached to the staff for not more than four years. He must then return to regimental duty for at least two years.

The officers of the army are obtained partly from the old-established military schools, partly from the ranks of the non-commissioned officers, the proportion of the latter being about one-third of the total number of officers. Artillery and engineer officers come from the *École Polytechnique*, infantry and cavalry from the *École spéciale militaire de St-Cyr*. Other important training institutions are the staff college (*École supérieure de Guerre*) which trains annually 70 to 90 selected captains and lieutenants; the musketry school of Châlons, the gymnastic school at Joinville-le-Pont and the schools of St Maixent, Saumur and Versailles for the preparation of non-commissioned officers for commissions in the infantry, cavalry, artillery and engineers respectively. The non-commissioned officers are, as usual in universal service armies, drawn partly from men who voluntarily enlist at a relatively early age, and partly from men who at the end of their compulsory period of service are re-engaged. Voluntary enlistments in the French army are permissible, within certain limits, at the age of eighteen, and the *engagés* serve for at least three years. The law further provides for the re-engagement of men of all ranks, under conditions varying according to their rank. Such re-engagements are for one to three years' effective service but may be extended to fifteen. They date from the time of the legal expiry of each man's compulsory active service. *Rengagés* receive a bounty, a higher rate of pay and a pension at the conclusion of their service.

The total number of men who had re-enlisted stood in 1903 at 8594.

Armament.—The field artillery is armed with the 75 mm. gun, a shielded quick-firer (see *ORDNANCE: Field Equipments*, for illustration and details); this weapon was the forerunner of all modern models of field gun, and is handled on tactical principles specially adapted for it, which gives the French field artillery a unique position amongst the military nations. The infantry, which was the first in Europe to be armed with the magazine rifle, still carries this, the Lebel, rifle which dates from 1886. It is believed, however, that a satisfactory type of automatic rifle (see *RIFLE*) has been evolved and is now (1908) in process of manufacture. Details are kept strictly secret. The cavalry weapons are a straight sword (that of the heavy cavalry is illustrated in the article *SWORD*), a bamboo lance and the Lebel carbine.

It is convenient to mention in this place certain institutions attached to the war department and completing the French military organization. The *Hôtel des Invalides* founded by Louis XIV. and Louvois is a house of refuge for old and infirm soldiers of all grades. The number of the inmates is decreasing; but the institution is an expensive one. In 1875 the "Invalides" numbered 642, and the hôtel cost the state 1,123,053 francs. The order of the Legion of Honour is treated under *KNIGHTHOOD AND CHIVALRY*. The *médaille militaire* is awarded to private soldiers and non-commissioned officers who have distinguished themselves or rendered long and meritorious services. This has been introduced in 1852, carries a yearly pension of 100 frs. and has been granted occasionally to officers.

Fortifications.—After 1870 France embarked upon a policy of elaborate frontier and inner defences, with the object of ensuring, as against an unexpected German invasion, the time necessary for the effective development of her military forces, which were then in process of reorganization. Some information as to the types of fortification adopted in 1870-1875 will be found in *FORTIFICATION AND SIEGECRAFT*. The general lines of the scheme adopted were as follows: On the Meuse, which forms the principal natural barrier on the side of Lorraine, Verdun (*q.v.*) was fortified as a large entrenched camp, and along the river above this were constructed a series of *forts d'arrêt* (see *MEUSE LINE*) ending in another entrenched camp at Toul (*q.v.*). From this point a gap (the *trouée d'Épinal*) was left, so as "in some sort to canalize the flow of invasion" (General Bonnal), until the upper Moselle was reached at Épinal (*q.v.*). Here another entrenched camp was made and from it the "Moselle line" (*q.v.*) of *forts d'arrêt* continues the barrier to Belfort (*q.v.*), another large entrenched camp, beyond which a series of fortifications at Montbéliard and the Lomont range carries the line of defence to the Swiss border, which in turn is protected by works at Pentarlier and elsewhere. In rear of these lines Verdun-Toul and Épinal-Belfort, respectively, lie two large defended areas in which under certain circumstances the main armies would assemble preparatory to offensive movements. One of these areas is defined by the three fortresses, La Fère, Laon and Reims, the other by the triangle, Langres—Dijon—Besançon. On the side of Belgium the danger of irruption through neutral territory, which has for many years been foreseen, is provided against by the fortresses of Lille, Valenciennes and Maubeuge, but (with a view to tempting the Germans to attack through Luxemburg, as is stated by German authorities) the frontier between Maubeuge and Verdun is left practically undefended. The real defence of this region lies in the field army which would, if the case arose, assemble in the area La Fère-Reims-Laon. On the Italian frontier the numerous *forts d'arrêt* in the mountains are strongly supported by the entrenched camps of Besançon, Grenoble and Nice. Behind all this huge development of fixed defences lie the central fortresses of Paris and Lyons. The defences of the Spanish frontier consist of the entrenched camps of Bayonne and Perpignan and the various small *forts d'arrêt* of the Pyrenees. Of the coast defences the principal are Toulon, Antibes, Rochefort, Lorient, Brest, Oléron, La Rochelle, Belle-Isle, Cherbourg, St-Malo, Havre, Calais, Gravelines and Dunkirk.

A number of the older fortresses, dating for the most part from Louis XIV.'s time, are still in existence, but are no longer of military importance. Such are Arras, Longwy, Mézières and Montmédy.

Navy.

Central Administration.—The head of the French navy is the Minister of Marine, who like the other ministers is appointed by decree of the head of the state, and is usually a civilian. He selects for himself a staff of civilians (the *cabinet du ministre*), which is divided into bureaux for the despatch of business. The head of the cabinet prepares for the consideration of the minister all the business of the navy, especially questions of general importance. His chief professional assistant is the *chef d'état-major général* (chief of the general staff), a vice-admiral, who is responsible for the organization of the naval forces, the mobilization and movements of the fleet, &c.

The central organization also comprises a number of departments (*services*) entrusted with the various branches of naval administration, such as administration of the active fleet, construction of ships, arsenals, recruiting, finance, &c. The minister has the assistance of the *Conseil supérieur de la Marine*, over which he presides, consisting of three vice-admirals, the chief of staff and some other members. The *Conseil supérieur* devotes its attention to all questions touching the fighting efficiency of the fleet, naval bases and arsenals and coast defence. Besides the *Conseil supérieur* the minister is advised on a very wide range of naval topics (including pay, quarters and recruiting) by the *Comité consultatif de la Marine*. Advisory committees are also appointed to deal with special subjects, e.g. the *commissions de classement* which attend to questions of promotion in the various branches of the navy, the naval works council and others.

The French coast is divided into five naval arrondissements, which have their headquarters at the five naval ports, of which Cherbourg, Brest, and Toulon are the most important, Lorient and Rochefort being of lesser degree. All are building and fitting-out yards. Each arrondissement is divided into sous-arrondissements, having their centres in the great commercial ports, but this arrangement is purely for the embodiment of the men of the Inscription Maritime, and has nothing to do with the dockyards as naval arsenals. In each arrondissement the vice-admiral, who is naval prefect, is the immediate representative of the minister of marine, and has full direction and command of the arsenal, which is his headquarters. He is thus commander-in-chief, as also governor-designate for time of war, but his authority does not extend to ships belonging to organized squadrons or divisions. The naval prefect is assisted by a rear-admiral as chief of the staff (except at Lorient and Rochefort, where the office is filled by a captain), and a certain number of other officers, the special functions of the chief of the staff having relation principally to the efficiency and *personnel* of the fleet, while the "major-general," who is usually a rear-admiral, is concerned chiefly with the *matériel*. There are also directors of stores, of naval construction, of the medical service, and of the submarine defences (which are concerned with torpedoes, mines and torpedo-boats), as well as of naval ordnance and works. The prefect directs the operations of the arsenal, and is responsible for its efficiency and for that of the ships which are there in reserve. In regard to the constitution and maintenance of the naval forces, the administration of the arsenals is divided into three principal departments, the first concerned with naval construction, the second with ordnance, including gun-mountings and small-arms, and the third with the so-called submarine defences, dealing with all torpedo *matériel*.

The French navy is manned partly by voluntary enlistment, partly by the transference to the navy of a certain proportion of each year's recruits for the army, but mainly by a system known as *inscription maritime*. This system, devised and introduced by Colbert in 1681, has continued, with various modifications, ever since. All French sailors between the ages of eighteen and fifty must be enrolled as members of the *armée de mer*. The term sailor is used in a very wide sense and includes

all persons earning their living by navigation on the sea, or in the harbours or roadsteads, or on salt lakes or canals within the maritime domain of the state, or on rivers and canals as far as the tide goes up or sea-going ships can pass. The inscript usually begins his service at the age of twenty and passes through a period of obligatory service lasting seven years, and generally comprising five years of active service and two years furlough.

Besides the important harbours already referred to, the French fleet has naval bases at Oran in Algeria, Bizerta in Tunisia, Saigon in Cochin China and Hongaj in Tongking, Diégo-Suarez in Madagascar, Dakar in Senegal, Fort de France in Martinique, Nouméa in New Caledonia.

The ordnance department of the navy is carried on by a large detachment of artillery officers and artificers provided by the war office for this special duty.

The fleet is divided into the Mediterranean squadron, the Northern squadron, the Atlantic division, the Far Eastern division, the Pacific division, the Indian Ocean division, the Cochin China division.

The chief naval school is the *École navale* at Brest, which is devoted to the training of officers; the age of admission is from fifteen to eighteen years, and pupils after completing their course pass a year on a frigate school. At Paris there is a more advanced school (*École supérieure de la Marine*) for the supplementary training of officers. Other schools are the school of naval medicine at Bordeaux with annexes at Toulon, Brest and Rochefort; schools of torpedoes and mines and of gunnery at Toulon, &c., &c. The *écoles d'hydrographie* established at various ports are for theoretical training for the higher grades of the merchant service. (See also NAVY.)

The total personnel of the *armée de mer* in 1909 is given as 56,800 officers and men. As to the number of vessels, which fluctuates from month to month, little can be said that is wholly accurate at any given moment, but, very roughly, the French navy in 1909 included 25 battleships, 7 coast defence ironclads, 19 armoured cruisers, 36 protected cruisers, 22 sloops, gunboats, &c., 45 destroyers, 319 torpedo boats, 71 submersibles and submarines and 8 auxiliary cruisers. It was stated that, according to proposed arrangements, the principal fighting elements of the fleet would be, in 1919, 34 battleships, 36 armoured cruisers, 6 smaller cruisers of modern type, 109 destroyers, 170 torpedo boats and 171 submersibles and submarines. The budgetary cost of the navy in 1908 was stated as 312,000,000 fr. (£12,480,000). (C. F. A.)

Education.

The burden of public instruction in France is shared by the communes, departments and state, while side by side with the public schools of all grades are private schools subjected to a state supervision and certain restrictions. At the head of the whole organization is the minister of public instruction. He is assisted and advised by the superior council of public instruction, over which he presides.

France is divided into sixteen *académies* or educational districts, having their centres at the seats of the universities. The capitals of these *académies*, together with the departments included in them, are tabulated below:

Académies.	Departments included in them.
PARIS	Seine, Cher, Eure-et-Loir, Loir-et-Cher, Loiret, Marne, Oise, Seine-et-Marne, Seine-et-Oise.
AIX	Bouches-du-Rhône, Basses-Alpes, Alpes-Maritimes, Corse, Var, Vaucluse.
BESANÇON	Doubs, Jura, Haute-Saône, Territoire de Belfort.
BORDEAUX	Gironde, Dordogne, Landes, Lot-et-Garonne, Basses-Pyrénées.
CAEN	Calvados, Eure, Manche, Orne, Sarthe, Seine-Inférieure.
CHAMBÉRY	Savoie, Haute-Savoie.
CLERMONT-FERRAND	Puy-de-Dôme, Allier, Cantal, Corrèze, Creuse, Haute-Loire.
DIJON	Côte-d'Or, Aube, Haute-Marne, Nièvre, Yonne.
GRENOBLE	Isère, Hautes-Alpes, Ardèche, Drôme.
LILLE	Nord, Aisne, Ardennes, Pas-de-Calais, Somme.
LYONS	Rhône, Ain, Loire, Saône-et-Loire.

	Departments included in them.
Académies.	
MONTPELLIER	Hérault, Aude, Gard, Lozère, Pyrénées-Orientales.
NANCY	Meurthe-et-Moselle, Meuse, Vosges.
POITIERS	Vienne, Charente, Charente-Inférieure, Indre, Indre-et-Loire, Deux-Sèvres, Vendée, Haute-Vienne.
RENNES	Ille-et-Vilaine, Côtes-du-Nord, Finistère, Loire-Inférieure, Maine-et-Loire, Mayenne, Morbihan.
TOULOUSE	Haute-Garonne, Ariège, Aveyron, Gers, Lot, Hautes-Pyrénées, Tarn, Tarn-et-Garonne.

There is also an *académie* comprising Algeria.

For the administrative organization of education in France see EDUCATION.

Any person fulfilling certain legal requirements with regard to capacity, age and character may set up privately an educational establishment of any grade, but by the law of 1904 all religious congregations are prohibited from keeping schools of any kind whatever.

Primary Instruction.—All primary public instruction is free and compulsory for children of both sexes between the ages of six and thirteen, but if a child can gain a certificate of primary studies at the age of eleven or after, he may be excused the rest of the period demanded by law. A child may receive instruction in a public or private school or at home. But if the parents wish him to be taught in a private school they must give notice to the mayor of the commune of their intention and the school chosen. If educated at home, the child (after two years of the compulsory period has expired) must undergo a yearly examination, and if it is unsatisfactory the parents will be compelled to send him to a public or private school.

Each commune is in theory obliged to maintain at least one public primary school, but with the approval of the minister, the departmental council may authorize a commune to combine with other communes in the upkeep of a school. If the number of inhabitants exceed 500, the commune must also provide a special school for girls, unless the Departmental Council authorizes it to substitute a mixed school. Each department is bound to maintain two primary training colleges, one for masters, the other for mistresses of primary schools. There are two higher training colleges of primary instruction at Fontenay-aux-Roses and St Cloud for the training of mistresses and masters of training colleges and higher primary schools.

The Laws of 1882 and 1886 "laicized" the schools of this class, the former suppressing religious instruction, the latter providing that only laymen should be eligible for masterships. There were also a great many schools in the control of various religious congregations, but a law of 1904 required that they should all be suppressed within ten years from the date of its enactment.

Public primary schools include (1) *écoles maternelles*—infant schools for children from two to six years old; (2) elementary primary schools—these are the ordinary schools for children from six to thirteen; (3) higher primary schools (*écoles primaires supérieures*) and "supplementary courses"; these admit pupils who have gained the certificate of primary elementary studies (*certificat d'études primaires*), offer a more advanced course and prepare for technical instruction; (4) primary technical schools (*écoles manuelles d'apprentissage, écoles primaires supérieures professionnelles*) kept by the communes or departments. Primary courses for adults are instituted by the prefect on the recommendation of the municipal council and academy inspector.

Persons keeping private primary schools are free with regard to their methods, programmes and books employed, except that they may not use books expressly prohibited by the superior council of public instruction. Before opening a private school the person proposing to do so must give notice to the mayor, prefect and academy inspector, and forward his diplomas and other particulars to the latter official.

Secondary Education.—Secondary education is given by the state in *lycées*, by the communes in *collèges* and by private individuals and associations in private secondary schools. It is not compulsory, nor is it entirely gratuitous, but the fees are small and the state offers a great many scholarships, by means of which a clever child can pay for its own instruction. Cost of tuition (simply) ranges from £2 to £16 a year. The lycées also take boarders—the cost of boarding ranging from £22 to £52 a year. A lycée is founded in a town by decree of the president of the republic, with the advice of the superior council of public instruction. The municipality has to pay the cost of building, furnishing and upkeep. At the head of the lycée is the principal (*proviseur*), an official nominated by the minister, and assisted by a teaching staff of professors and *chargés de cours* or teachers of somewhat lower standing. To become professor in a lycée it is necessary to pass an examination known as the "agrégation," candidates for which must be licentiates of a faculty (or have passed through the *École normale supérieure*).

The system of studies—reorganized in 1902—embraces a full

curriculum of seven years, which is divided into two periods. The first lasts four years, and at the end of this the pupil may obtain (after examination) the "certificate of secondary studies." During the second period the pupil has a choice of four courses: (1) Latin and Greek; (2) Latin and sciences; (3) Latin and modern languages; (4) sciences and modern languages. At the end of this period he presents himself for a degree called the *Baccalauréat de l'enseignement secondaire*. This is granted (after two examinations) by the faculties of letters and sciences jointly (see below), and in most cases it is necessary for a student to hold this general degree before he may be enrolled in a particular faculty of a university and proceed to a Baccalauréat in a particular subject, such as law, theology or medicine.

The collèges, though of a lower grade, are in most respects similar to the lycées, but they are financed by the communes: the professors may have certain less important qualifications in lieu of the "agrégation." Private secondary schools are subjected to state inspection. The teachers must not belong to any congregation, and must have a diploma of aptitude for teaching and the degree of "licencié." The establishment of lycées for girls was first attempted in 1880. They give an education similar to that offered in the lycées for boys—with certain modifications—in a curriculum of five or six years. There is a training-college for teachers in secondary schools for girls at Sèvres.

Higher education is given by the state in the universities, and in special higher schools; and, since the law of 1875 established the freedom of higher education, by private individuals and bodies in private schools and "faculties" (*facultés libres*). The law of 1880 reserved to the state "faculties" the right to confer degrees, and the law of 1896 established various universities each containing one or more faculties. There are five kinds of faculties: medicine, letters, science, law and Protestant theology. The faculties of letters and sciences, besides granting the *Baccalauréat de l'enseignement secondaire*, confer the degrees of licentiate and doctor (*la Licence, le Doctorat*). The faculties of medicine confer the degree of doctor of medicine. The faculties of theology confer the degrees of bachelor, licentiate and doctor of theology. The faculties of law confer the same degrees in law and also grant "certificates of capacity," which enable the holder to practise as an *avoué*; a *licence* is necessary for the profession of barrister. Students of the private faculties have to be examined by and take their degrees from the state faculties. There are 2 faculties of Protestant theology (Paris and Montauban); 12 faculties of law (Paris, Aix, Bordeaux, Caen, Grenoble, Lille, Lyons, Montpellier, Nancy, Poitiers, Rennes, Toulouse); 3 faculties of medicine (Paris, Montpellier and Nancy), and 4 joint faculties of medicine and pharmacy (Bordeaux, Lille, Lyons, Toulouse); 15 faculties of sciences (Paris, Besançon, Bordeaux, Caen, Clermont, Dijon, Grenoble, Lille, Lyons, Marseilles, Montpellier, Nancy, Poitiers, Rennes, Toulouse); 15 faculties of letters (at the same towns, substituting Aix for Marseilles). The private faculties are at Paris (the Catholic Institute with a faculty of law); Angers (law, science and letters); Lille (law, medicine and pharmacy, science, letters); Lyons (law, science, letters); Marseilles (law); Toulouse (Catholic Institute with faculties of theology and letters). The work of the faculties of medicine and pharmacy is in some measure shared by the *écoles supérieures de pharmacie* (Paris, Montpellier, Nancy), which grant the highest degrees in pharmacy, and by the *écoles de plein exercice de médecine et de pharmacie* (Marseilles, Rennes and Nantes) and the more numerous *écoles préparatoires de médecine et de pharmacie*; there are also *écoles préparatoires à l'enseignement supérieur des sciences et des lettres* at Chambéry, Rouen and Nantes.

Besides the faculties there are a number of institutions, both state-supported and private, giving higher instruction of various special kinds. In the first class must be mentioned the Collège de France, founded 1530, giving courses of highest study of all sorts, the Museum of Natural History, the École des Chartes (palaeography and archives), the School of Modern Oriental Languages, the École Pratique des Hautes Études (scientific research), &c. All these institutions are in Paris. The most important free institution in this class is the École des Sciences Politiques, which prepares pupils for the civil services and teaches a great number of political subjects, connected with France and foreign countries, not included in the state programmes.

Commercial and technical instruction is given in various institutions comprising national establishments such as the *écoles nationales professionnelles* of Armentières, Vierzon, Voiron and Nantes for the education of working men; the more advanced *écoles d'arts et métiers* of Châlons, Angers, Aix, Lille and Cluny; and the Central School of Arts and Manufactures at Paris; schools depending on the communes and state in combination, e.g. the *écoles pratiques de commerce et d'industrie* for the training of clerks and workmen; private schools controlled by the state, such as the *écoles supérieures de commerce*; certain municipal schools, such as the Industrial Institute of Lille; and private establishments, e.g. the school of watch-making at Paris. At Paris the École Supérieure des Mines and the École des Ponts et Chaussées are controlled by the minister of public works, the École des Beaux-Arts, the École des Arts Décoratifs and the Conservatoire National de Musique et de Déclamation by the under-secretary for fine arts, and other schools

mentioned elsewhere are attached to several of the ministries. In the provinces there are national schools of fine art and of music and other establishments and free subventioned schools.

In addition to the educational work done by the state, communes and private individuals, there exist in France a good many societies which disseminate instruction by giving courses of lectures and holding classes both for children and adults. Examples of such bodies are the Society for Elementary Instruction, the Polytechnic Association, the Philotechnic Association and the French Union of the Young at Paris; the Philomathic Society of Bordeaux; the Popular Education Society at Havre; the Rhone Society of Professional Instruction at Lyons; the Industrial Society of Amiens and others.

The highest institution of learning is the *Institut de France*, founded and kept up by the French government on behalf of science and literature, and composed of five academies: the *Académie française*, the *Académie des Inscriptions et Belles-Lettres*, the *Académie des Sciences*, the *Académie des Beaux-Arts* and the *Académie des Sciences Morales et Politiques* (see ACADEMIES). The *Académie de Médecine* is a separate body.

Poor Relief (Assistance publique).—In France the pauper, *as such*, has no legal claim to help from the community, which however, is bound to provide for destitute children (see FOUNDLING HOSPITALS) and pauper lunatics (both these being under the care of the department), aged and infirm people without resources and victims of incurable illness, and to furnish medical assistance gratuitously to those without resources who are afflicted with curable illness. The funds for these purposes are provided by the department, the commune and the central authority.

There are four main types of public benevolent institutions, all of which are communal in character: (1) The *hôpital*, for maternity cases and cases of curable illness; (2) the *hospice*, where the aged poor, cases of incurable malady, orphans, foundlings and other children without means of support, and in some cases lunatics, are received; (3) the *bureau de bien-faisance*, charged with the provision of out-door relief (*secours à domicile*) in money or in kind, to the aged poor or those who, though capable of working, are prevented from doing so by illness or strikes; (4) the *bureau d'assistance*, which dispenses free medical treatment to the destitute.

These institutions are under the supervision of a branch of the ministry of the interior. The hospices and *hôpitaux* and the *bureaux de bien-faisance*, the foundation of which is optional for the commune, are managed by committees consisting of the mayor of the municipality and six members, two elected by the municipal council and four nominated by the prefect. The members of these committees are unpaid, and have no concern with ways and means which are in the hands of a paid treasurer (*receveur*). The *bureaux de bien-faisance* in the larger centres are aided by unpaid workers (*commissaires* or *dames de charité*), and in the big towns by paid inquiry officers. *Bureaux d'assistance* exist in every commune, and are managed by the combined committees of the hospices and the *bureaux de bien-faisance* or by one of these in municipalities, where only one of those institutions exists.

No poor-rate is levied in France. Funds for *hôpitaux*, hospices and *bureaux de bien-faisance* comprise:

1. A 10% surtax on the fees of admission to places of public amusement.
2. A proportion of the sums payable in return for concessions of land in municipal cemeteries.
3. Profits of the communal *Monts de Piété* (pawn-shops).
4. Donations, bequests and the product of collections in churches.
5. The product of certain fines.
6. Subventions from the departments and communes.
7. Income from endowments.

(R. TR.)

Colonies.

In the extent and importance of her colonial dominion France is second only to Great Britain. The following table gives the name, area and population of each colony and protectorate as well as the date of acquisition or establishment of a protectorate. It should be noted that the figures for area and population are, as a rule, only estimates, but in most instances they probably approximate closely to accuracy. Detailed notices of the separate countries will be found under their several heads:

Colony.	Date of Acquisition.	Area in sq. m.	Population.
In Asia—			
Establishments in India	1683-1750	200	273,000
In Indo-China—			
Annam	1883	60,000	6,000,000
Cambodia	1863	65,000	1,500,000
Cochin-China	1862	22,000	3,000,000
Tongking	1883	46,000	6,000,000
Laos	1893	100,000	600,000
Kwang-Chow-Wan	1898	325	189,000
Total in Asia	293,525	17,562,000
In Africa and the Indian Ocean—			
Algeria	1830-1847	185,000	5,231,850
Algerian Sahara	1872-1890	760,000	..
Tunisia	1881	51,000	2,000,000
West Africa—			
Senegal	1626	74,000	1,800,000
Upper Senegal and Niger (including part of Sahara)	1880	1,580,000	4,000,000
Guinea	1848	107,000	2,500,000
Ivory Coast	1842	129,000	2,000,000
Dahomey	1863-1894	40,000	1,000,000
Congo (French Equatorial Africa)—			
Gabon	1839	..	376,000
Mid. Congo	1882	700,000	259,000
Ubangi-Chad	1885-1899	..	3,015,000
Madagascar	1885-1896
Nossi-be Island	1840	228,000	2,664,000
Ste Marie Island	1750
Comoro Islands	1843-1886	760	82,000
Somali Coast	1862-1884	12,000	50,000
Réunion	1643	965	173,315
St Paul	1892	3	..
Amsterdam	1892	19	..
Kerguelen ¹	1893	1,400	uninhabited
Total in Africa and Indian Ocean.		3,869,147	25,151,165
In America—			
Guiana	1626	51,000	30,000
Guadeloupe	1634	619	182,112
Martinique	1635	380	182,024
St Pierre and Miquelon	1635	92	6,500
Total in America		52,092	400,636
In Oceania—			
New Caledonia and Dependencies	1854-1887	7,500	72,000
Establishments in Oceania	1841-1881	1,641	34,300
Total in Oceania		9,141	106,300
Grand Total		4,223,905	43,220,101

It will be seen that nearly all the colonies and protectorates lie within the tropics. The only countries in which there is a considerable white population are Algeria, Tunisia and New Caledonia. The "year of acquisition" in the table, when one date only is given, indicates the period when the country or some part of it first fell under French influence, and does not imply continuous possession since.

Government.—The principle underlying the administration of the French possessions overseas, from the earliest days until the close of the 19th century, was that of "domination" and "assimilation," notwithstanding that after the loss of Canada and the sale of Louisiana France ceased to hold any considerable colony in which Europeans could settle in large numbers. With

¹ Kerguelen lies in the Great Southern Ocean, but is included here for the sake of convenience.

the vast extension of the colonial empire in tropical countries in the last quarter of the 19th century the evils of the system of assimilation, involving also intense centralization, became obvious. This, coupled with the realization of the fact that the value to France of her colonies was mainly commercial, led at length to the abandonment of the attempt to impose on a great number of diverse peoples, some possessing (as in Indo-China and parts of West Africa) ancient and highly complex civilizations, French laws, habits of mind, tastes and manners. For the policy of assimilation there was substituted the policy of "association," which had for aim the development of the colonies and protectorates upon natural, *i.e.* national, lines. Existing civilizations were respected, a considerable degree of autonomy was granted, and every effort made to raise the moral and economic status of the natives. The first step taken in this direction was in 1900 when a law was passed which laid down that the colonies were to provide for their own civil expenditure. This law was followed by further measures tending to decentralization and the protection of the native races.

The system of administration bears nevertheless many marks of the "assimilation" era. None of the French possessions is self-governing in the manner of the chief British colonies. Several colonies, however, elect members of the French legislature, in which body is the power of fixing the form of government and the laws of each colony or protectorate. In default of legislation the necessary measures are taken by decree of the head of the state; these decrees having the force of law. A partial exception to this rule is found in Algeria, where all laws in force in France before the conquest of the country are also (in theory, not in practice) in force in Algeria. In all colonies Europeans preserve the political rights they held in France, and these rights have been extended, in whole or in part, to various classes of natives. Where these rights have not been conferred, native races are *subjects* and not *citizens*. To this rule Tunisia presents an exception, Tunisians retaining their nationality and laws.

In addition to Algeria, which sends three senators and six deputies to Paris and is treated in many respects not as a colony but as part of France, the colonies represented in the legislature are: Martinique, Guadeloupe and Réunion (each electing one senator and two deputies), French India (one senator and one deputy), Guiana, Senegal and Cochin-China (one deputy each). The franchise in the three first-named colonies is enjoyed by all classes of inhabitants, white, negro and mulatto, who are all French citizens. In India the franchise is exercised without distinction of colour or nationality; in Senegal the electors are the inhabitants (black and white) of the communes which have been given full powers. In Guiana and Cochin-China the franchise is restricted to citizens, in which category the natives (in those colonies) are not included.¹ The inhabitants of Tahiti though accorded French citizenship have not been allotted a representative in parliament. The colonial representatives enjoy equal rights with those elected for constituencies in France.

The oversight of all the colonies and protectorates save Algeria and Tunisia is confided to a minister of the colonies (law of March 20, 1894)² whose powers correspond to those exercised in France by the minister of the interior. The colonial army is nevertheless attached (law of 1900) to the ministry of war. The colonial minister is assisted by a number of organizations of which the most important is the superior council of the colonies (created by decree in 1883), an advisory body which includes the senators and deputies elected by the colonies, and delegates elected by the universal suffrage of all citizens in the colonies and protectorates which do not return members to parliament. To the ministry appertains the duty of fixing the duties on foreign produce in those colonies which have not been, by law, subjected to the same tariff as in France. (Nearly all the colonies save those

of West Africa and the Congo have been, with certain modifications, placed under the French tariff.) The budget of all colonies not possessing a council general (see below) must also be approved by the minister. Each colony and protectorate, including Algeria, has a separate budget. As provided by the law of 1900 all local charges are borne by the colonies—supplemented at need by grants in aid—but the military expenses are borne by the state. In all the colonies the judicature has been rendered independent of the executive.

The colonies are divisible into two classes, (1) those possessing considerable powers of local self-government, (2) those in which the local government is autocratic. To this second class may be added the protectorates (and some colonies) where the native form of government is maintained under the supervision of French officials.

Class (1) includes the American colonies, Réunion, French India, Senegal, Cochin-China and New Caledonia. In these colonies the system of assimilation is carried to great lengths. At the head of the administration is a governor under whom is a secretary-general, who replaces him at need. The governor is aided by a privy council, an advisory body to which the governor nominates a minority of unofficial members, and a council general, to which is confided the control of local affairs, including the voting of the budget. The councils general are elected by universal suffrage of all citizens and those who, though not citizens, have been granted the political franchise. In Cochin-China, in place of a council general, there is a colonial council which fulfils the functions of a council general.

In the second class of colonies the governor, sometimes assisted by a privy council, on which non-official members find seats, sometimes simply by a council of administration, is responsible only to the minister of the colonies. In Indo-China, West Africa, French Congo and Madagascar, the colonies and protectorates are grouped under governors-general, and to these high officials extensive powers have been granted by presidential decree. The colonies under the governor-general of West Africa are ruled by lieutenant-governors with restricted powers, the budget of each colony being fixed by the governor-general, who is assisted by an advisory government council comprising representatives of all the colonies under his control. In Indo-China the governor-general has under his authority the lieutenant-governor of the colony of Cochin-China, and the residents superior at the courts of the kings of Cambodia and Annam and in Tongking (nominally a viceroyalty of Annam). There is a superior council for the whole of Indo-China on which the natives and the European commercial community are represented, while in Cochin-China a privy council, and in the protectorates a council of the protectorate, assists in the work of administration. In each of the governments general there is a financial controller with extensive powers who corresponds directly with the metropolitan authorities (decree of March 22, 1907). Details and local differences in form of government will be found under the headings of the various colonies and protectorates.

Colonial Finance.—The cost of the extra-European possessions, other than Algeria and Tunisia, to the state is shown in the expenses of the colonial ministry. In the budget of 1885 these expenses were put at £1,380,000; in 1895 they had increased to £3,200,000 and in 1900 to £5,100,000. In 1905 they were placed at £4,431,000. Fully three-fourths of the state contributions is expenditure on military necessities; in addition there are subventions to various colonies and to colonial railways and cables, and the expenditure on the penitentiary establishments; an item not properly chargeable to the colonies. In return the state receives the produce of convict labour in Guiana and New Caledonia. Save for the small item of military expenditure Tunisia is no charge to the French exchequer. The similar expenses of Algeria borne by the state are not separately shown, but are estimated at £2,000,000.

The colonial budgets totalled in 1907 some £16,760,000, being divisible into six categories: Algeria £4,120,000; Tunisia £3,640,000; Indo-China³ about £5,000,000; West Africa £1,600,000; Madagascar £960,000; all other colonies combined £1,440,000.

¹ In 1906 the number of registered electors in these colonies was 199,055, of whom 106,695 exercised their suffrage.

² In the case of Madagascar by decree of the 11th of December 1895.

³ The Indo-China budget is reckoned in piastres, a silver coin of fluctuating value (1s. 10d. to 2s.). The budget of 1907 balanced at 50,000,000 piastres.

The authorized colonial loans, omitting Algeria and Tunisia, during the period 1884-1904 amounted to £19,200,000, the sums paid for interest and sinking funds on loans varying from £600,000 to £800,000 a year. The amount of French capital invested in French colonies and protectorates, including Algeria and Tunisia, was estimated in 1905 at £120,000,000, French capital invested in foreign countries at the same date being estimated at ten times that amount (see *Qués. Dip. et Col.*, February 16, 1905).

Commerce.—The value of the external trade of the French possessions, exclusive of Algeria and Tunisia, increased in the ten years 1896-1905 from £18,784,060 to £34,957,479. In the last-named year the commerce of Algeria amounted to £24,506,020 and that of Tunisia to £5,969,248, making a grand total for French colonial trade in 1905 of £65,432,746. The figures were made up as follows:

	Imports.	Exports.	Total.
Algeria	£15,355,500	£9,150,520	£24,506,020
Tunisia	3,638,185	2,331,063	5,969,248
Indo-China	10,182,411	6,750,306	16,932,717
West Africa	3,874,698	2,248,317	6,123,015
Madagascar	1,247,936	914,024	2,161,960
All other colonies	4,258,134	5,481,652	9,739,786
Total	£38,556,864	£26,875,882	£65,432,746

Over three-fourths of the trade of Algeria and Tunisia is with France and other French possessions. In the other colonies and protectorates more than half the trade is with foreign countries. The foreign countries trading most largely with the French colonies are, in the order named, British colonies and Great Britain, China and Japan, the United States and Germany. The value of the trade with British colonies and Great Britain in 1905 was over £7,200,000. (F. R. C.)

BIBLIOGRAPHY.—P. Joanne, *Dictionnaire géographique et administrative de la France* (8 vols., Paris, 1890-1905); C. Brossard, *La France et ses colonies* (6 vols., Paris, 1900-1906); O. Reclus, *Le Plus Beau Royaume sous le ciel* (Paris, 1899); Vidal de La Blache, *La France. Tableau géographique* (Paris, 1908); V. E. Ardouin-Dumazet, *Voyage en France* (Paris, 1894); H. Havard, *La France artistique et monumentale* (6 vols., Paris, 1892-1895); A. Lebon and P. Pelet, *France as it is*, tr. Mrs W. Arnold (London, 1888); articles on "Local Government in France" in the *Stock Exchange Official Intelligence Annuals* (London, 1908 and 1909); M. Bloek, *Dictionnaire de l'administration française*, the articles in which contain full bibliographies (2 vols., Paris, 1905); E. Levasseur, *La France et ses colonies* (3 vols., Paris, 1890); M. Fallex and A. Mairey, *La France et ses colonies au début du XX^e siècle*, which has numerous bibliographies (Paris, 1909); J. du Plessis de Grenédan, *Géographie agricole de la France et du monde* (Paris, 1903); F. de St Genis, *La Propriété rurale en France* (Paris, 1902); H. Baudrillart, *Les Populations agricoles de la France* (3 vols., Paris, 1885-1893); J. E. C. Bodley, *France* (London, 1899); A. Girault, *Principes de colonisation et de législation coloniale* (3 vols., Paris, 1907-1908); *Les Colonies françaises*, an encyclopaedia edited by M. Petit (2 vols., Paris, 1902). Official statistical works: *Annuaire statistique de la France* (a summary of the statistical publications of the government), *Statistique agricole annuelle*, *Statistique de l'industrie minérale et des appareils de vapeur*, *Tableau général du commerce et de la navigation*, Reports on the various colonies issued annually by the British Foreign Office, &c. Guide Books: Karl Baedeker, *Northern France, Southern France*; P. Joanne, *Nord, Champagne et Ardenne; Normandie*; and other volumes dealing with every region of the country.

HISTORY

The identity of the earliest inhabitants of Gaul is veiled in obscurity, though philologists, anthropologists and archaeologists are using the glimmer of traditions collected by ancient historians to shed a faint twilight upon that remote past. The subjugation of those primitive tribes did not mean their annihilation: their blood still flows in the veins of Frenchmen; and they survive also on those megalithic monuments (see **STONE MONUMENTS**) with which the soil of France is dotted, in the drawings and sculptures of caves hollowed out along the sides of the valleys, and in the arms and ornaments yielded by sepulchral tumuli, while the names of the rivers and mountains of France probably perpetuate the first utterances of those nameless generations.

The first peoples of whom we have actual knowledge are the Iberians and Ligurians. The Basques who now inhabit both sides of the Pyrenean range are probably the last representatives of the Iberians, who came from Spain to settle between the Mediterranean and the Bay of Biscay. The Ligurians, who exhibited the hard cunning characteristic of the Genoese Riviera,

must have been descendants of that Indo-European vanguard who occupied all northern Italy and the centre and south-east of France, who in the 7th century B.C. received the Phocæan immigrants at Marseilles, and who at a much later period were encountered by Hannibal during his march to Rome, on the banks of the Rhône, the frontier of the Iberian and Ligurian territories. Upon these peoples it was that the conquering minority of Celts or Gauls imposed themselves, to be succeeded at a later date by the Roman aristocracy.

Iberians and Ligurians.

When Gaul first enters the field of history, Rome has already laid the foundation of her freedom, Athens dazzles the eastern Mediterranean with her literature and her art, while in the west Carthage and Marseilles are lining opposite shores with their great houses of commerce. Coming from the valley of the Danube in the 6th century, the Celts or Gauls had little by little occupied central and southern Europe long before they penetrated into the plains of the Saône, the Seine, and the Loire as far as the Spanish border, driving out the former inhabitants of the country. A century later their political hegemony, extending from the Black Sea to the Strait of Gibraltar, began to disintegrate, and the Gauls then embarked on more distant migrations, from the Columns of Hercules to the plateaux of Asia Minor, taking Rome on their way. Their empire in Gaul, encroached upon in the north by the Belgæ, a kindred race, and in the south by the Iberians, gradually contracted in area and eventually crumbled to pieces. This process served the turn of the Romans, who little by little had subjugated first the Cisalpine Gauls and afterwards those inhabiting the south-east of France, which was turned into a Roman province in the 2nd century. Up to this time Hellenism and the mercantile spirit of the Jews had almost exclusively dominated the Mediterranean littoral, and at first the Latin spirit only won foothold for itself in various spots on the western coast—as at Aix in Provence (123 B.C.) and at Narbonne (118 B.C.). A refuge of Italian pauperism in the time of the Gracchi, after the triumph of the oligarchy the Narbonnaise became a field for shameless exploitation, besides providing, under the proconsulate of Caesar, an excellent point of observation whence to watch the intestine quarrels between the different nations of Gaul.

Empire of the Celts.

The Roman Conquest.

These are divided by Caesar in his *Commentaries* into three groups: the Aquitanians to the south of the Garonne; the Celts, properly so called, from the Garonne to the Seine and the Marne; and the Belgæ, from the Seine to the Rhine. But these ethnological names cover a very great variety of half-savage tribes, differing in speech and in institutions, each surrounded by frontiers of dense forests abounding in game. On the edges of these forests stood isolated dwellings like sentinel outposts; while the inhabitants of the scattered hamlets, caves hollowed in the ground, rude circular huts or lake-dwellings, were less occupied with domestic life than with war and the chase. On the heights, as at Bibracte, or on islands in the rivers, as at Lutetia, or protected by marshes, as at Avaricum, *oppida*—at once fortresses and places of refuge, like the Greek Acropolis—kept watch and ward over the beaten tracks and the rivers of Gaul.

Political divisions of Gaul.

These primitive societies of tall, fair-skinned warriors, blue-eyed and red-haired, were gradually organized into political bodies of various kinds—kingdoms, republics and federations—and divided into districts or *pagi* (*pays*) to which divisions the minds of the country folk have remained faithfully attached ever since. The victorious aristocracy of the kingdom dominated the other classes, strengthened by the prestige of birth, the ownership of the soil and the practice of arms. Side by side with this martial nobility the Druids constituted a priesthood unique in ancient times; neither hereditary as in India, nor composed of isolated priests as in Greece, nor of independent colleges as at Rome, it was a true corporation, which at first possessed great moral authority, though by Caesar's time it had lost both strength and prestige. Beneath these were the common people attached to the soil,

Political institutions of Gaul.

who did not count for much, but who reacted against the insufficient protection of the regular institutions by a voluntary subordination to certain powerful chiefs.

This impotence of the state was a permanent cause of those discords and revolts, which in the 1st century B.C. were so singularly favourable to Caesar's ambition. Thus after eight years of incoherent struggles, of scattered revolts, and then of more and more energetic efforts, Gaul, at last aroused by Vercingetorix, for once concentrated her strength, only to perish at Alesia, vanquished by Roman discipline and struck at from the rear by the conquest of Britain (58-50 B.C.).

This defeat completely altered the destiny of Gaul, and she became one of the principal centres of Roman civilization.

Of the vast Celtic empire which had dominated Europe nothing now remained but scattered remnants in the farthest corners of the land, refuges for all the vanquished Gaels, Picts or Gauls; and of its civilization there lingered only idioms and dialects—Gaelic, Pict and Gallic—which gradually dropped out of use. During five centuries Gaul was unflinchingly loyal to her conquerors; for to conquer is nothing if the conquered be not assimilated by the conqueror, and Rome was a past-mistress of this art. The personal charm of Caesar and the prestige of Rome are not of themselves sufficient to explain this double conquest. The generous and enlightened policy of the imperial administration asked nothing of the people of Gaul but military service and the payment of the tax; in return it freed individuals from patronal domination, the people from oligarchic greed or Druidic excommunication, and every one in general from material anxiety. Petty tyrannies gave place to the great *Pax Romana*. The Julio-Claudian dynasty did much to attach the Gauls to the empire; they always occupied the first place in the mind of Augustus, and the revolt of the Aeduan Julius Sacrovir, provoked by the census of A.D. 21, was easily repressed by Tiberius. Caligula visited Gaul and founded literary competitions at Lyons, which had become the political and intellectual capital of the country. Claudius, who was a native of Lyons, extended the right of Roman citizenship to many of his fellow-townsmen, gave them access to the magistracy and to the senate, and supplemented the annexation of Gaul by that of Britain. The speech which he pronounced on this occasion was engraved on tables of bronze at Lyons, and is the first authentic record of Gaul's admission to the citizenship of Rome. Though the crimes of Nero and the catastrophes which resulted from his downfall, provoked the troubles of the year A.D. 70, the revolt of Sabinus was in the main an attempt by the Germans to pillage Gaul and the prelude to military insurrections. The government of the Flavians and the Antonines completed a definite reconciliation. After the extinction of the family of Augustus in the 1st century Gaul had made many emperors—Galba, Otho, Vitellius, Vespasian and Domitian; and in the 2nd century she provided Gauls to rule the empire—Antoninus (138-161) came from Nîmes and Claudius from Lyons, as did also Caracalla later on (211-217).

The romanization of the Gauls, like that of the other subject nations, was effected by slow stages and by very diverse means, furnishing an example of the constant adaptability of Roman policy. It was begun by establishing a network of roads with Lyons as the central point, and by the development of a prosperous urban life in the increasingly wealthy Roman colonies; and it was continued by the disintegration into independent cities of nearly all the Gaulish states of the Narbonnaise, together with the substitution of the Roman collegial magistracy for the isolated magistracy of the Gauls. This alteration came about more quickly in the north-east in the Rhine-land than in the west and the centre, owing to the near neighbourhood of the legions on the frontiers. Rome was too tolerant to impose her own institutions by force; it was the conquered peoples who collectively and individually solicited as a favour the right of adopting the municipal system, the magistracy, the sacerdotal

and aristocratic social system of their conquerors. The edict of Caracalla, at the beginning of the 3rd century, by conferring the right of citizenship on all the inhabitants of the empire, completed an assimilation for which commercial relations, schools, a taste for officialism, and the adaptability and quick intelligence of the race had already made preparation. The Gauls now called themselves Romans and their language Romance. There was neither oppression on the one hand nor servility on the other to explain this abandonment of their traditions. Thanks to the political and religious unity which a common worship of the emperor and of Rome gave them, thanks to administrative centralization tempered by a certain amount of municipal autonomy, Gaul prospered throughout three centuries.

But this stability of the Roman peace had barely been realized when events began to threaten it both from within and without. The *Pax Romana* having rendered any armed force unnecessary amid a formerly very bellicose people, only eight legions mounted guard over the Rhine to protect it from the barbarians who surrounded the empire. The raids made by the Germans on the eastern frontiers, the incessant competitions for the imperial power, and the repeated revolts of the Pretorian guard, gradually undermined the internal cohesion of Gaul; while the insurrections of the Bagaudae aggravated the destruction wrought by a grasping treasury and by barbarian incursions; so that the anarchy of the 3rd century soon aroused separatist ideas. Under Postumus Gaul had already attempted to restore an independent though short-lived empire (258-267); and twenty-eight years later the tetrarchy of Diocletian proved that the blood now circulated with difficulty from the heart to the extremities of an empire on the eve of disintegration. Rome was to see her universal dominion gradually menaced from all sides. It was in Gaul that the decisive revolutions of the time were first prepared; Constantine's crusades to overthrow the altars of paganism, and Julian's campaigns to set them up again. After Constantine the emperors of the East in the 4th century merely put in an occasional appearance at Rome; they resided at Milan or in the prefectorial capitals of Gaul—at Arles, at Treves (Trier), at Reims or in Paris. The ancient territorial divisions—Belgium, Gallia Lugdunensis (Lyonnaise), Gallia Narbonensis (Narbonnaise)—were split up into seventeen little provinces, which in their turn were divided into two dioceses. Thus the great historic division was made between southern and northern France. Roman nationality persisted, but the administrative system was tottering.

Upon ground that had been so well levelled by Roman legislation aristocratic institutions naturally flourished. From the 4th century onward the balance of classes was disturbed by the development of a landed aristocracy that grew more powerful day by day, and by the corresponding ruin of the small proprietors and industrial and commercial corporations. The members of the *curia* who assisted the magistrates in the cities, crushed by the burden of taxes, now evaded as far as possible public office or senatorial honours. The vacancies left in this middle class by this continual desertion were not compensated for by the progressive advance of a lower class destitute of personal property and constantly unsettled in their work. The peasants, no less than the industrial labourers, suffered from the absence of any capital laid by, which alone could have enabled them to improve their land or to face a time of bad harvests. Having no credit they found themselves at the mercy of their neighbours, the great landholders, and by degrees fell into the position of tenants, or into servitude. The *curia* was thus emptied both from above and from below. It was in vain that the emperors tried to rivet the chains of the *curia* in this hereditary bondage, by attaching the small proprietor to his glebe, like the artisan to his guild and the soldier to his legion. To such a miserable pretence of freedom they all preferred servitude, which at least ensured them a livelihood; and the middle class of freemen thus became gradually extinct.

Caesar in Gaul.

Roman Gaul.

Decline of the Imperial authority in Gaul.

Social disorganization of Gaul.

Material and political transformation of Roman Gaul.

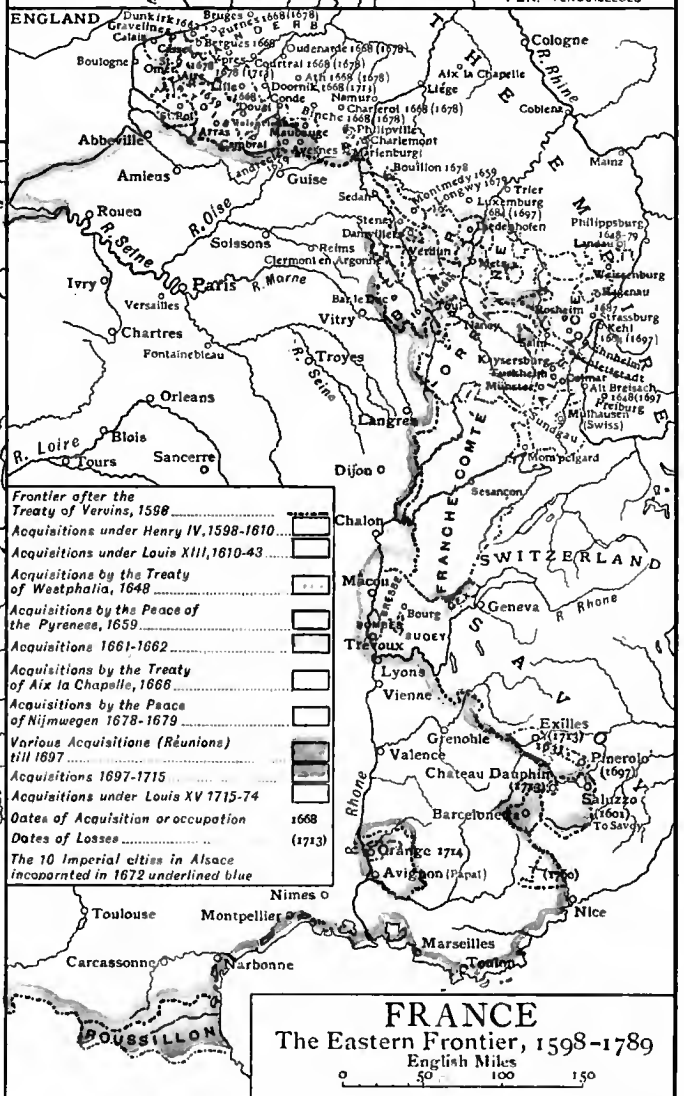
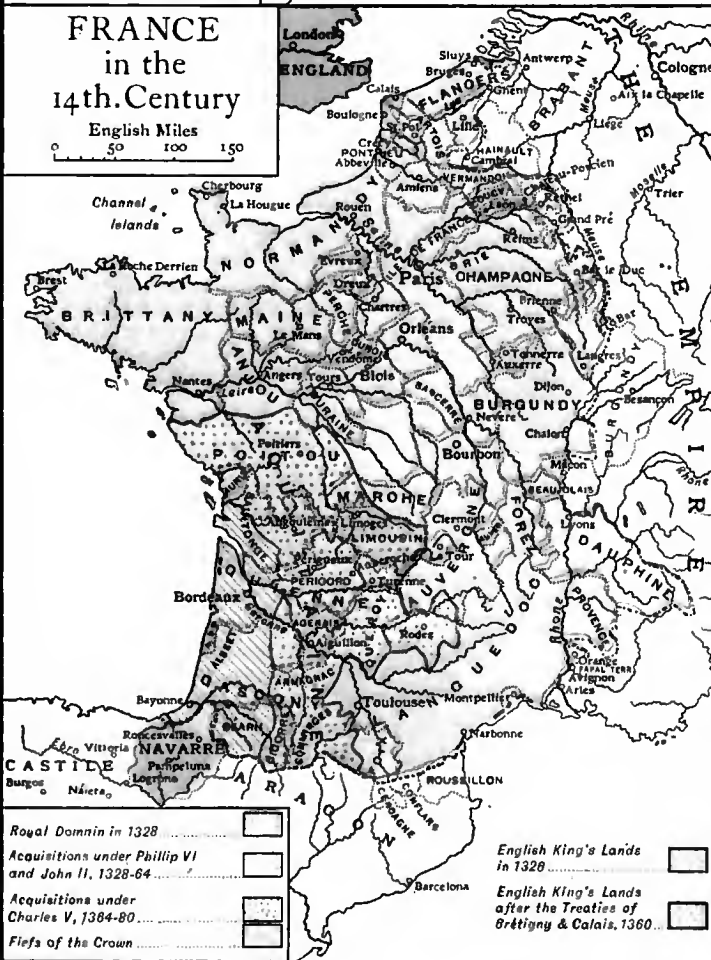
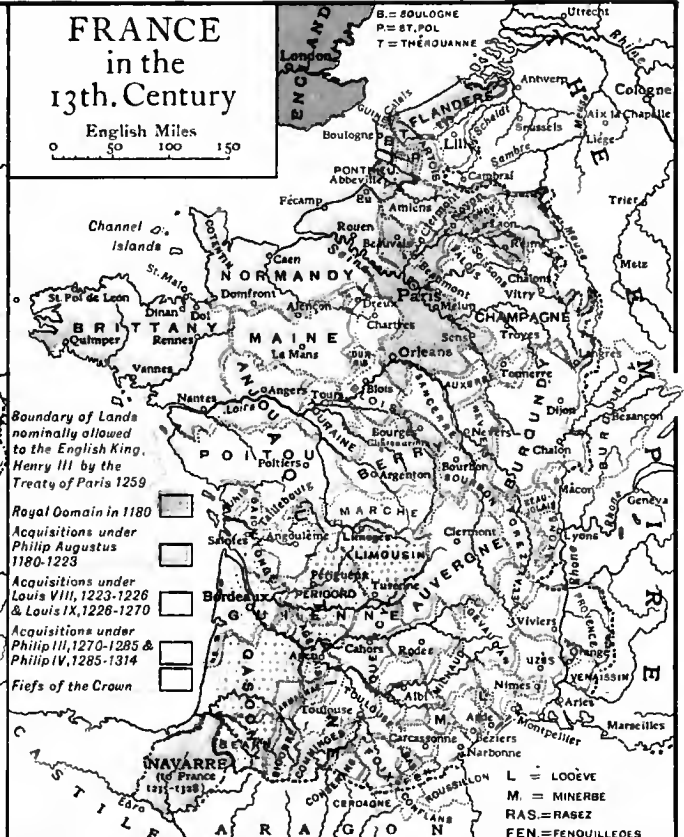
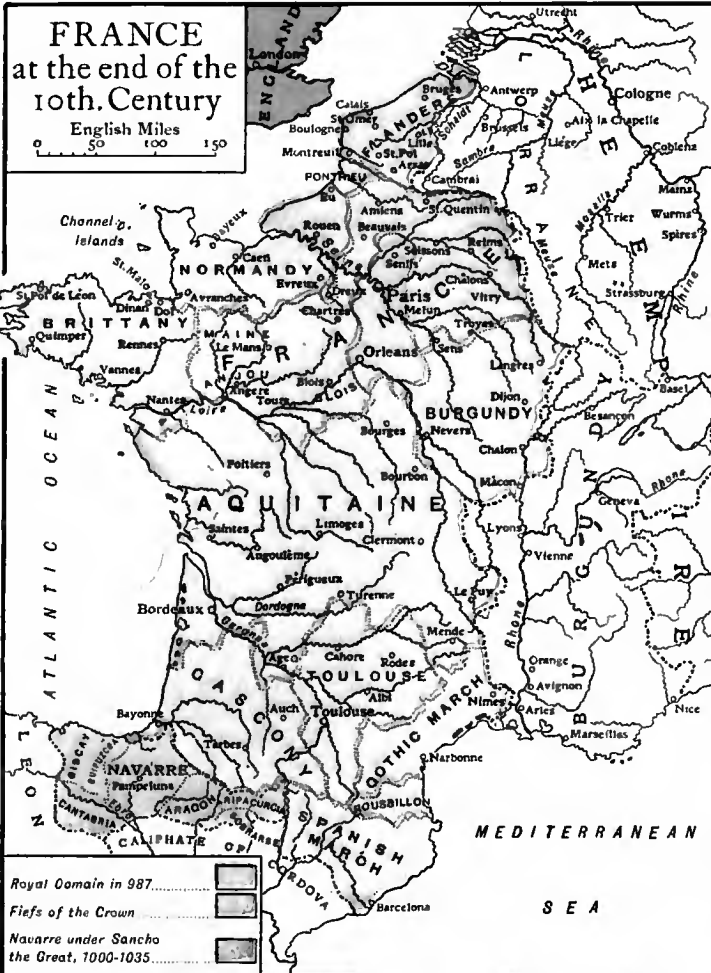

The aristocracy, on the contrary, went on increasing in power, and eventually became masters of the situation. It was through them that the emperor, theoretically absolute, practically carried on his administration; but he was no longer either strong or a divinity, and possessed nothing but the semblance of omnipotence. His official despotism was opposed by the passive but invincible competition of an aristocracy, more powerful than himself because it derived its support from the revived relation of patron and dependants. But though the aristocracy administered, yet they did not govern. They suffered, as did the Empire, from a general state of lassitude. Like their private life, their public life, no longer stimulated by struggles and difficulties, had become sluggish; their power of initiative was enfeebled. Feeling their incapacity they no longer embarked on great political schemes; and the army, the instrument by which such schemes were carried on, was only held together by the force of habit. In this society, where there was no traffic in anything but wealth and ideas, the soldier was nothing more than an agitator or a parasite. The egoism of the upper classes held military duty in contempt, while their avarice depopulated the countryside, whence the legions had drawn their recruits. And now come the barbarians! A prey to perpetual alarm, the people entrenched themselves behind those high walls of the *oppida* which Roman security had razed to the ground, but imperial impotence had restored, and where life in the middle ages was destined to vegetate in unrestful isolation.

Amidst this general apathy, intellectual activity alone persisted.

In the 4th century there was a veritable renaissance in Gaul, the last outburst of a dying flame, which yet bore witness also to the general decadence. The agreeable versification of an amateur like Ausonius, the refined panegyrics of a Eumenius, disguising nullity of thought beneath elegance of form, already foretold the perilous sterility of scholasticism. Art, so widespread in the wealthy villas of Gaul, contented itself with imitation, produced nothing original and remained mediocre. Human curiosity, no longer concerned with philosophy and science, seemed as though stifled, religious polemics alone continuing to hold public attention. Disinclination for the self-sacrifice of active life and weariness of the things of the earth lead naturally to absorption in the things of heaven. After bringing about the success of the Asiatic cults of Mithra and Cybele, these same factors now assured the triumph over exhausted paganism of yet another oriental religion—Christianity—after a duel which had lasted two centuries.

This new faith had appeared to Constantine likely to infuse young and healthy blood into the Empire. In reality Christianity,

which had contributed not a little to stimulate the political unity of continental Gaul, now tended to dissolve it by destroying that religious unity which had heretofore been its complement. Before this there had been complete harmony between Church and State; but afterwards came indifference and then disagreement between political and religious institutions, between the City of God and that of Caesar. Christianity, introduced into Gaul during the 1st century of the Christian era by those foreign merchants who traded along the coasts of the Mediterranean, had by the middle of the 2nd century founded communities at Vienne, at Autun and at Lyons. Their propagandizing zeal soon exposed them to the wrath of an ignorant populace and the contempt of the educated; and thus it was that in A.D. 177, under Marcus Aurelius, the Church of Lyons, founded by St Pothinus, suffered those persecutions which were the effective cause of her ultimate victory. These Christian communities, disguised under the legally authorized name of burial societies, gradually formed a vast secret cosmopolitan association, superimposed upon Roman society but incompatible with the Empire. Christianity had to be either destroyed or absorbed. The persecutions under Aurelian and Diocletian almost succeeded in accomplishing the former; the Christian churches were saved by the instability of the existing authorities, by military anarchy and by the incursions of the barbarians. Despite tortures and martyrdoms, and thanks

to the seven apostles sent from Rome in 250, during the 3rd century their branches extended all over Gaul.

The emperors had now to make terms with these churches, which served to group together all sorts of malcontents, and this was the object of the edict of Milan (313), by which the Church, at the outset simply a Jewish institution, was naturalized as Roman; while in 325 the Council of Nicaea endowed her with unity. But for the security and the power thus attained she had to pay with her independence. On the other hand, pagan and Christian elements in society existed side by side without intermingling, and even openly antagonistic to each other—one aristocratic and the other democratic. In order to induce the masses of the people once more to become loyal to the imperial form of government the emperor Julian tried by founding a new religion to give its functionaries a religious prestige which should impress the popular mind. His plan failed; and the emperor Theodosius, aided by Ambrose, bishop of Milan, preferred to make the Christian clergy into a body of imperial and conservative officials; while in return for their adhesion he abolished the Arian heresy and paganism itself, which could not survive without his support. Thenceforward it was in the name of Christ that persecutions took place in an Empire now entirely won over to Christianity.

In Gaul the most famous leader of this first merciless, if still perilous crusade, was a soldier-monk, Saint Martin of Tours. Thanks to him and his disciples in the middle of the 4th century and the beginning of the 5th many of the towns possessed well-established churches; but the militant ardour of monks and centuries of labour were needed to conquer the country districts, and in the meantime both dogma and internal organization were subjected to important modifications. As regards the former the Church adopted a course midway between metaphysical explanations and historical traditions, and reconciled the more extreme theories; while with the admission of pagans a great deal of paganism itself was introduced. On the other hand, the need for political and social order involved the necessity for a disciplined and homogeneous religious body; the exercise of power, moreover, soon transformed the democratic Christianity of the earlier churches into a federation of little conservative monarchies. The increasing number of her adherents, and her inexperience of government on such a vast and complicated scale, obliged her to comply with political necessity and to adopt the system of the state and its social customs. The Church was no longer a fraternity, on a footing of equality, with freedom of belief and tentative as to dogma, but an authoritative aristocratic hierarchy. The episcopate was now recruited from the great families in the same way as the imperial and the municipal public services. The Church called on the emperor to convoke and preside over her councils and to combat heresy; and in order more effectually to crush the latter she replaced primitive independence and local diversity by uniformity of doctrine and worship, and by the hierarchy of dioceses and ecclesiastical provinces. The heads of the Church, her bishops, her metropolitans, took the titles of their pagan predecessors as well as their places, and their jurisdiction was enforced by the laws of the state. Rich and powerful chiefs, they were administrators as much as priests: Germanus (German), bishop of Auxerre (d. 448), St Eucherius of Lyons (d. 450), Apollinaris Sidonius of Clermont (d. c. 490) assumed the leadership of society, fed the poor, levied tithes, administered justice, and in the towns where they resided, surrounded by priests and deacons, ruled both in temporal and spiritual matters.

But the humiliation of Theodosius before St Ambrose proved that the emperor could never claim to be a pontiff, and that the dogma of the Church remained independent of the sovereign as well as of the people; if she sacrificed her liberty it was but to claim it again and maintain it more effectively amid the general languor. The Church thus escaped the unpopularity of this decadent empire, and during the 5th century she provided a refuge for all those who, wishing to preserve the Roman unity, were terrified

Absorption of land and power by the aristocracy of Gaul.

Triumph of Christianity in Gaul.

Organization of the Church.

Intellectual decadence of Gaul.

Christianity in Gaul.

The Church's independence of the Empire.

by the blackness of the horizon. In fact, whilst in the Eastern Church the metaphysical ardour of the Greeks was spending itself in terrible combats in the oecumenical councils over the interpretation of the Nicene Creed, the clergy of Gaul, more simple and strict in their faith, abjured these theological logomachies; from the first they had preferred action to criticism and had taken no part in the great controversy on free-will raised by Pelagius. Another kind of warfare was about to absorb their whole attention; the barbarians were attacking the frontiers of the Empire on every side, and their advent once again modified Gallo-Roman civilization.

For centuries they had been silently massing themselves around ancient Europe, whether Iberian, Celtic or Roman.

The barbarian invasion.

Many times already during that evening of a decadent civilization, their threatening presence had seemed like a dark cloud veiling the radiant sky of the peoples established on the Mediterranean seaboard. The cruel lightning of the sword of Brennus had illumined the night, setting Rome or Delphi on fire. Sometimes the storm had burst over Gaul, and there had been need of a Marius to stem the torrent of Cimbri and Teutons, or of a Caesar to drive back the Helvetians into their mountains. On the morrow the western horizon would clear again, until some such disaster as that which befell Varus would come to mortify cruelly the pride of an Augustus. The Romans had soon abandoned hope of conquering Germany, with its fluctuating frontiers and nomadic inhabitants. For more than two centuries they had remained prudently entrenched behind the earthworks that extended from Cologne to Ratisbon (Regensburg); but the intestine feuds which prevailed among the barbarians and were fostered by Rome, the organization under bold and turbulent chiefs of the bands greedy for booty, the pressing forward on populations already settled of tribes in their rear; all this caused the Germanic invasion to filter by degrees across the frontier. It was the work of several generations and took various forms, by turns and simultaneously colonization and aggression; but from this time forward the *pax romana* was at an end. The emperors Probus, Constantine, Julian and Valentinian, themselves foreigners, were worn out with repulsing these repeated assaults, and the general enervation of society did the rest. The barbarians gradually became part of the Roman population; they permeated the army, until after Theodosius they recruited it exclusively; they permeated civilian society as colonists and agriculturists, till the command of the army and of important public duties was given over to a Stilicho or a Crocus. Thus Rome allowed the wolves to mingle with the dogs in watching over the flock, just at a time when the civil wars of the 4th century had denuded the Rhenish frontier of troops, whose numbers had already been diminished by Constantine. Then at the beginning of the 5th century, during a furious irruption of Germans fleeing before Huns, the *limes* was carried away (406-407); and for more than a hundred years the torrent of fugitives swept through the Empire, which retreated behind the Alps, there to breathe its last.

Whilst for ten years Alaric's Goths and Stilicho's Vandals were drenching Italy with blood, the Vandals and the Alani from the steppes of the Black Sea, dragging in their wake the reluctant German tribes who had been allies of Rome and who had already settled down to the cultivation of their lands, invaded the now abandoned Gaul, and having come as far as the Pyrenees, crossed over them. After the passing of this torrent the Visigoths, under their kings Ataulphus, Wallia and Theodoric, still dazzled by the splendours of this immense empire, established themselves like submissive vassals in Aquitaine, with Toulouse as their capital. About the same time the Burgundians settled even more peaceably in Rhenish Gaul, and, after 456, to the west of the Jura in the valleys of the Saône and the Rhone. The original Franks of Germany, already established in the Empire, and pressed upon by the same Huns who had already forced the Goths across the Danube, passed beyond the Rhine and occupied north-eastern Gaul; Ripuarians of the Rhine establishing themselves on the Sambre and the Meuse, and

Salian in Belgium, as far as the great fortified highroad from Bavai to Cologne. Accepted as allies, and supported by Roman prestige and by the active authority of the general Aetius, all these barbarians rallied round him and the Romans of Gaul, and in 451 defeated the hordes of Attila, who had advanced as far as Orleans, at the great battle of the Catalaunian plains.

Thus at the end of the 5th century the Roman empire was nothing but a heap of ruins, and fidelity to the empire was now only maintained by the Catholic Church; she alone survived, as rich, as much honoured as ever, and more powerful, owing to the disappearance of the imperial officials for whom she had found substitutes, and the decadence of the municipal bodies into whose inheritance she had entered. Owing to her the City of God gradually replaced the Roman imperial polity and preserved its civilization; while the Church allied herself more closely with the new kingdoms than she had ever done with the Empire. In the Gothic or Burgundian states of the period the bishops, after having for a time opposed the barbarian invaders, sought and obtained from their chief the support formerly received from the emperor. Apollinaris Sidonius paid court to Euric, since 476 the independent king of the Visigoths, against whom he had defended Auvergne; and Avitus, bishop of Vienne, was graciously received by Gundibald, king of the Burgundians. But these princes were Arians, *i.e.* foreigners among the Catholic population; the alliance sought for by the Church could not reach her from that source, and it was from the rude and pagan Franks that she gained the material support which she still lacked. The conversion of Clovis was a master-stroke; it was fortunate both for himself and for the Franks. Unity in faith brought about unity in law.

Clovis was king of the Sicambrians, one of the tribes of the Salian Franks. Having established themselves in the plains of Northern Gaul, but driven by the necessity of finding new land to cultivate, in the days of their king Childeric they had descended into the fertile valleys of the Somme and the Oise. Clovis's victory at Soissons over the last troops left in the service of Rome (486) extended their settlements as far as the Loire. By his conversion, which was due to his wife Clotilda and to Remigius, bishop of Reims, more than to the victory of Tolbiac over the Alamanni, Clovis made definitely sure of the Roman inhabitants and gave the Church an army (496). Thenceforward he devoted himself to the foundation of the Frankish monarchy by driving the exhausted and demoralized heretics out of Gaul, and by putting himself in the place of the now enfeebled emperor. In 500 he conquered Gundibald, king of the Burgundians, reduced him to a kind of vassalage, and forced him into reiterated promises of conversion to orthodoxy. In 507 he conquered and killed Alaric II., king of the Arian Visigoths, and drove the latter into Spain. Legend adorned his campaign in Aquitaine with miracles; the bishops were the declared allies of both him and his son Theuderich (Thierry) after his conquest of Auvergne. At Tours he received from the distant emperor at Constantinople the diploma and insignia of *patricius* and Roman consul, which legalized his military conquests by putting him in possession of civil powers. From this time forward a great historic transformation was effected in the eyes of the bishops and of the Gallo-Romans; the Frankish chief took the place of the ancient emperors. Instead of blaming him for the murder of the lesser kings of the Franks, his relatives, by which he had accomplished the union of the Frankish tribes, they saw in this the hand of God rewarding a faithful soldier and a converted pagan. He became their king, their new David, as the Christian emperors had formerly been; he built churches, endowed monasteries, protected St Vaast (Vedastus, d. 540), first bishop of Arras and Cambrai, who restored Christianity in northern Gaul. Like the emperors before him Clovis, too, reigned over the Church. Of his own authority he called together a council at Orleans in 511, the year of his death. He was already the grand distributor of ecclesiastical benefices, pending the time when his successors were to confirm the episcopal elections, and his power began to take

The clergy and the barbarians.

Clovis, the Frankish chief.

Clovis as a Roman officer.

The Germans in Gaul.

The Franks before Clovis.

on a more and more absolute character. But though he felt the ascendant influence of Christian teaching, he was not really penetrated by its spirit; a professing Christian, and a friend to the episcopate, Clovis remained a barbarian, crafty and ruthless. The bloody tragedies which disfigured the end of his reign bear sad witness to this; they were a fit prelude to that period during the course of which, as Gregory of Tours said, "barbarism was let loose."

The conquest of Gaul, begun by Clovis, was finished by his sons: Theuderich, Chlodomer, Childebert and Clotaire. In three successive campaigns, from 523 to 532, they annihilated the Burgundian kingdom, which had maintained its independence, and had endured for nearly a century. Favoured by the war between Justinian, the East Roman emperor, and Theodoric's Ostrogoths, the Frankish kings divided Provence among them as they had done in the case of Burgundy. Thus the whole of Gaul was subjected to the sons of Clovis, except Septimania in the south-east, where the Visigoths still maintained their power. The Frankish armies then overflowed into the neighbouring countries and began to pillage them. Their disorderly cohorts made an attack upon Italy, which was repulsed by the Lombards, and another on Spain with the same want of success; but beyond the Rhine they embarked upon the conquest of Germany, where Clovis had already reduced to submission the country on the banks of the Maine, later known as Franconia. In 531 the Thuringians in the centre of Germany were brought into subjection by his eldest son, King Theuderich, and about the same time the Bavarians were united to the Franks, though preserving a certain autonomy. The Merovingian monarchy thus attained the utmost limits of its territorial expansion, bounded as it was by the Pyrenees, the Alps and the Rhine; it exercised influence over the whole of Germany, which it threw open to the Christian missionaries, and its conquests formed the first beginnings of German history.

But to these wars of aggrandizement and pillage succeeded those fratricidal struggles which disgraced the whole of the sixth century and arrested the expansion of the Merovingian power. When Clotaire, the last surviving son of Clovis, died in 561, the kingdom was divided between his four sons like some piece of private property, as in 511, and according to the German method. The capitals of these four kings—Charibert, who died in 567, Guntram, Sigebert and Chilperic—were Paris, Orleans, Reims and Soissons—all near one another and north of the Loire, where the Germanic inhabitants predominated; but their respective boundaries were so confused that disputes were inevitable. There was no trace of a political idea in these disputes; the mutual hatred of two women aggravated jealousy to the point of causing terrible civil wars from 561 to 613, and these finally created a national conflict which resulted in the dismemberment of the Frankish empire. Recognized, in fact, already as separate provinces were Austrasia, or the eastern kingdom, Neustria, or north-west Gaul and Burgundy; Aquitaine alone was as yet undifferentiated.

Sigebert had married Brunhilda, the daughter of a Visigoth king; she was beautiful and well educated, having been brought up in Spain, where Roman civilization still flourished. Chilperic had married Galswintha, one of Brunhilda's sisters, for the sake of her wealth; but despite this marriage he had continued his amours with a waiting-woman named Fredegond, who pushed ambition to the point of crime, and she induced him to get rid of Galswintha. In order to avenge her sister, Brunhilda incited Sigebert to begin a war which terminated in 575 with the assassination of Sigebert by Fredegond at the very moment when, thanks to the help of the Germans, he had gained the victory, and with the imprisonment of Brunhilda at Rouen. Fredegond subsequently caused the death of Merovech (Mérové), the son of Chilperic, who had been secretly married to Brunhilda, and that of Bishop Praetextatus, who had solemnized their union. After this, Fredegond endeavoured to restore imperial finance to a state of solvency, and to set up a more regular form of government in her Neustria, which was less romanized and less wealthy than Burgundy,

where Guntram was reigning, and less turbulent than the eastern kingdom, where most of the great warlike chiefs with their large landed estates were somewhat impatient of royal authority. But the accidental death of two of her children, the assassination of her husband in 584, and the advice of the Church, induced her to make overtures to her brother-in-law Guntram. A lover of peace through sheer cowardice, and as depraved in his morals as Chilperic, Guntram had played a vacillating and purely self-interested part in the family tragedy. He declared himself the protector of Fredegond, but his death in 593 delivered up Burgundy and Neustria to Brunhilda's son Childebert, king of Austrasia, in consequence of the treaty of Andelot, made in 587. An ephemeral triumph, however; for Childebert died in 596, followed a year later by Fredegond.

The whole of Gaul was now handed over to three children: Childebert's two sons, Theudebert and Theuderich (Thierry), and the son of Fredegond, Clotaire II. The latter, having vanquished the two former at Latofao in 596, was in turn beaten by them at Dormelles in 600, and a year later a fresh fratricidal struggle broke out between the two grandsons of the aged Brunhilda. Theuderich joined with Clotaire against Theodobert, and invaded his brother's kingdom, conquering first an army of Austrasians and then one composed of Saxons and Thuringians. Strife began again in 613 in consequence of Theuderich's desire to join Austrasia to Neustria, but his death delivered the kingdoms into the hands of Clotaire II. This weak king leant for support upon the nobles of Burgundy and Austrasia, impatient as they were of obedience to a woman and the representative of Rome. The ecclesiastical party also abandoned Brunhilda because of her persecution of their saints, after which Clotaire, having now got the upper hand, thanks to the defection of the Austrasian nobles, of Arnulf, bishop of Metz, with his brother Pippin, and of Warnachaire, mayor of the palace, made a terrible end of Brunhilda in 613. Her long reign had not lacked intelligence and even greatness; she alone, amid all these princes, warped by self-indulgence or weakened by discord, had behaved like a statesman, and she alone understood the obligations of the government she had inherited. She wished to abolish the fatal tradition of dividing up the kingdom, which so constantly prevented any possible unity; in opposition to the nobles she used her royal authority to maintain the Roman principles of order and regular administration. Towards the Church she held a courteous but firm policy, renewing relations between the Frankish kingdom and the pope; and she so far maintained the greatness of the Empire that tradition associated her name with the Roman roads in the north of France, entitling them "les chaussées de Brunehaut."

Like his grandfather, Clotaire II. reigned over a once more united Gaul of Franks and Gallo-Romans, and like Clovis he was not too well obeyed by the nobles; moreover, his had been a victory more for the aristocracy than for the crown, since it limited the power of the latter. Not that the permanent constitution of the 18th of October 614 was of the nature of an anti-monarchic revolution, for the royal power still remained very great, decking itself with the pompous titles of the Empire, and continuing to be the dominant institution; but the reservations which Clotaire II. had to make in conceding the demands of the bishops and great laymen show the extent and importance of the concessions these latter were already aiming at. The bishops, the real inheritors of the imperial idea of government, had become great landowners through enormous donations made to the Church, and allied as they were to the aristocracy, whence their ranks were continually recruited, they had gradually identified themselves with the interests of their class and had adopted its customs; while thanks to long minorities and civil wars the aristocracy of the high officials had taken an equally important social position. The treaty of Andelot in 587 had already decided that the benefices or lands granted to them by the kings should be held for life. In the 7th century the Merovingian kings adopted the custom of summoning them all, and not merely the officials of their *Palatium*, to discuss political affairs; they began, moreover,

The sons of Clovis.

Civil wars.

Fredegond and Brunhilda.

The fall of Brunhilda.

Clotaire II.

to choose their counts or administrators from among the great landholders. This necessity for approval and support points to yet another alteration in the nature of the royal power, absolute as it was in theory.

The Mayoralty of the Palace aimed a third and more serious blow at the royal authority. By degrees, the high officials of the *Palatium*, whether secular or ecclesiastical, and also the provincial counts, had rallied round the mayors of the palace as their real leaders. As under the Empire, the *Palatium* was both royal court and centre of government, with the same bureaucratic hierarchy and the same forms of administration; and the mayor of the palace was premier official of this itinerant court and ambulatory government. Moreover, since the palace controlled the whole of each kingdom, the mayors gradually extended their official authority so as to include functionaries and agents of every kind, instead of merely those attached immediately to the king's person. They suggested candidates for office for the royal selection, often appointed office-holders, and, by royal warrant, supported or condemned them. Mere subordinates while the royal power was strong, they had become, owing to the frequent minorities, and to civil wars which broke the tradition of obedience, the all-powerful ministers of kings nominally absolute but without any real authority. Before long they ceased to claim an even greater degree of independence than that of Warnachaire, who forced Clotaire II. to swear that he should never be deprived of his mayoralty of Burgundy; they wished to take the first place in the kingdoms they governed, and to be able to attack neighbouring kingdoms on their own account. A struggle, motived by self-interest, no doubt; but a struggle, too, of opposing principles. Since the Frankish monarchy was now in their power some of them tried to re-establish the unity of that monarchy in all its integrity, together with the superiority of the State over the Church; others, faithless to the idea of unity, saw in the disintegration of the state and the supremacy of the nobles a warrant for their own independence. These two tendencies were destined to strive against one another during an entire century (613-714), and to occasion two periods of violent conflict, which, divided by a kind of renaissance of royalty, were to end at last in the triumphant substitution of the Austrasian mayors for royalty and aristocracy alike.

The first struggle began on the accession of Clotaire II., when Austrasia, having had a king of her own ever since 561, demanded one now. In 623 Clotaire was obliged to send her his son Dagobert and even to extend his territory. But in Dagobert's name two men ruled, representing the union of the official aristocracy and the Church. One, Pippin of Landen, derived his power from his position as mayor of the palace, from great estates in Aquitaine and between the Meuse and the Rhine, and from the immense number of his supporters; the other, Arnulf, bishop of Metz, sprang from a great family, probably of Roman descent, and was besides immensely wealthy in worldly possessions. By the union of their forces Pippin and Arnulf were destined to shape the future. They had already, in 613, treated with Clotaire and betrayed the hopes of Brunhilda, being consequently rewarded with the guardianship of young Dagobert. Burgundy followed the example of Austrasia, demanded the abolition of the mayoralty, and in 627 succeeded in obtaining her independence of Neustria and Austrasia and direct relations with the king.

The death of Clotaire (629) was the signal for a revival of the royal power. Dagobert deprived Pippin of Landen of his authority and forced him to fly to Aquitaine; but still he had to give the Austrasians his son Sigebert III. for their king (634). He made administrative progresses through Neustria and Burgundy to recall the nobles to their allegiance, but again he was forced to designate his second son Clovis as king of Neustria. He did subdue Aquitaine completely, thanks to his brother Charibert, with whom he had avoided dividing the kingdom, and he tried to restore his own demesne, which had been despoiled

by the granting of benefices or by the pious frauds of the Church. In short, this reign was one of great conquests, impossible except under a strong government. Dagobert's victories over Samo, king of the Slavs along the Elbe, and his subjugation of the Bretons and the Basques, maintained the prestige of the Frankish empire; while the luxury of his court, his taste for the fine arts (ministered to by his treasurer Eloi¹), his numerous achievements in architecture—especially the abbey of St Denis, burial-place of the kings of France—the brilliance and the power of the churchmen who surrounded him and his revision of the Salic law, ensured for his reign, in spite of the failure of his plans for unity, a fame celebrated in folksong and ballad.

But for barbarous nations old-age comes early, and after Dagobert's death (639), the monarchy went swiftly to its doom. The mayors of the palace again became supreme, and the kings not only ceased to appoint them, but might not even remove them from office. Such mayors were Aega and Erchinoald, in Neustria, Pippin and Otto in Austrasia, and Flaochat in Burgundy. One of them, Grimoald, son of Pippin, actually dared to take the title of king in Austrasia (640). This was a premature attempt and barren of result, yet it was significant; and not less so is the fact that the palace in which these mayors bore rule was a huge association of great personages, laymen and ecclesiastics who seem to have had much more independence than in the 6th century. We find the dukes actually raising troops without the royal sanction, and even against the king. In 641 the mayor Flaochat was forced to swear that they should hold their offices for life; and though these offices were not yet hereditary, official dynasties, as it were, began to be established permanently within the palace. The crown lands, the governorships, the different offices, were looked upon as common property to be shared between themselves. Organized into a compact body they surrounded the king and were far more powerful than he. In the general assembly of its members this body of officials decided the selection of the mayor; it presented Flaochat to the choice of Queen Nanthilda, Dagobert's widow; after long discussion it appointed Ebroïn as mayor; it submitted requests that were in reality commands to the Assembly of Bonneuil in 616 and later to Childeric in 670. Moreover, the countries formerly subdued by the Franks availed themselves of this opportunity to loosen the yoke; Thuringia was lost by Sigebert in 641, and the revolt of Alamannia in 643 set back the frontier of the kingdom from the Elbe to Austrasia. Aquitaine, hitherto the common prey of all the Frankish kings, having in vain tried to profit by the struggles between Fredegond and Brunhilda, and set up an independent king, Gondibald, now finally burst her bonds in 670. Then came a time when the kings were mere children, honoured with but the semblance of respect, under the tutelage of a single mayor, Ebroïn of Neustria.

This representative of royalty, chief minister for four-and-twenty years (656-681), attempted the impossible, endeavouring to re-establish unity in the midst of general dissolution and to maintain intact a royal authority usurped everywhere by the hereditary power of the great palatine families. He soon stirred up against himself all the dissatisfied nobles, led by Léger (Leodegarius), bishop of Autun and his brother Gerinus. Clotaire III.'s death gave the signal for war. Ebroïn's enemies set up Childeric II. in opposition to Theuderich, the king whom he had chosen without summoning the great provincial officials. Despite a temporary triumph, when Childeric was forced to recognize the principle of hereditary succession in public offices, and when the mayoralties of Neustria and Burgundy were alternated to the profit of both, Léger soon fell into disgrace and was exiled to that very monastery of Luxeuil to which Ebroïn had been relegated. Childeric having regained the mastery restored the mayor's office, which was immediately disputed by the two rivals; Ebroïn was successful and established himself as mayor of the palace in the room of Leudesius, a partisan of Léger (675),

¹ St Eligius, bishop of Noyon, apostle of the Belgians and Frisians (d. 659?).

The mayors of the palace.

The "Rois fainéants" might not even remove them from office. Such mayors were Aega and Erchinoald, in Neustria, Pippin and Otto in Austrasia, and Flaochat in Burgundy. One of them, Grimoald, son of Pippin, actually dared to take the title of king in Austrasia (640). This was a premature attempt and barren of result, yet it was significant; and not less so is the fact that the palace in which these mayors bore rule was a huge association of great personages, laymen and ecclesiastics who seem to have had much more independence than in the 6th century. We find the dukes actually raising troops without the royal sanction, and even against the king. In 641 the mayor Flaochat was forced to swear that they should hold their offices for life; and though these offices were not yet hereditary, official dynasties, as it were, began to be established permanently within the palace. The crown lands, the governorships, the different offices, were looked upon as common property to be shared between themselves. Organized into a compact body they surrounded the king and were far more powerful than he. In the general assembly of its members this body of officials decided the selection of the mayor; it presented Flaochat to the choice of Queen Nanthilda, Dagobert's widow; after long discussion it appointed Ebroïn as mayor; it submitted requests that were in reality commands to the Assembly of Bonneuil in 616 and later to Childeric in 670. Moreover, the countries formerly subdued by the Franks availed themselves of this opportunity to loosen the yoke; Thuringia was lost by Sigebert in 641, and the revolt of Alamannia in 643 set back the frontier of the kingdom from the Elbe to Austrasia. Aquitaine, hitherto the common prey of all the Frankish kings, having in vain tried to profit by the struggles between Fredegond and Brunhilda, and set up an independent king, Gondibald, now finally burst her bonds in 670. Then came a time when the kings were mere children, honoured with but the semblance of respect, under the tutelage of a single mayor, Ebroïn of Neustria.

First struggle between monarchy and mayoralty.

Struggle between Ebroïn and Léger.

Renaissance of monarchy under Dagobert, 629-639.

following this up by a distribution of offices and dignities right and left among his adherents. Léger was put to death in 678, and the Austrasians, commanded by the Carolingian Pippin II., with whom many of the chief Neustrians had taken refuge, were dispersed near Laon (680). But Ebroïn was assassinated next year in the midst of his triumph, having like Fredegond been unable to do more than postpone for a quarter of a century the victory of the nobles and of Austrasia; for his successor, Berthar, was unfitted to carry on his work, having neither his gifts and energy nor the powerful personality of Pippin. Berthar met his death at the battle of Tertry (687), which gave the king into the hands of Pippin, as also the royal treasure and the mayoralty, and by thus enabling him to reward his followers made him supreme over the Merovingian dynasty. Thenceforward the degenerate descendants of Clovis offered no further resistance to his claims, though it was not until 752 that their line became extinct.

In that year the Merovingian dynasty gave place to the rule of Pippin II. of Heristal, who founded a Carolingian empire fated to be as ephemeral as that of the Merovingians. This political victory of the aristocracy was merely the consummation of a slow subterranean revolution which by innumerable reiterated blows had sapped the structure of the body politic, and was about to transfer the people of Gaul from the Roman monarchical and administrative government to the sway of the feudal system.

The Merovingian kings, mere war-chiefs before the advent of Clovis, had after the conquest of Gaul become absolute hereditary monarchs, thanks to the disappearance of the popular assemblies and to the perpetual state of warfare. They concentrated in their own hands all the powers of the empire, judicial, fiscal and military; and even the so-called "rois fainéants" enjoyed this unlimited power, in spite of the general disorder and the civil wars. To make their authority felt in the provinces they had an army of officials at their disposal—a legacy, this, from imperial Rome—who represented them in the eyes of their various peoples. They had therefore only to keep up this established government, but they could not manage even this much; they allowed the idea of the common interests of kings and their subjects gradually to die out, and forgetting that national taxes are a necessary impost, a charge for service rendered by the state, they had treated these as though they were illicit and unjustifiable spoils. The taxpayers, with the clergy at their head, adopted the same idea, and every day contrived fresh methods of evasion. Merovingian justice was on the same footing as Merovingian finance: it was arbitrary, violent and self-seeking. The Church, too, never failed to oppose it—at first not so much on account of her own ambitions as in a more Christian spirit—and proceeded to weaken the royal jurisdiction by repeated interventions on behalf of those under sentence, afterwards depriving it of authority over the clergy, and then setting up ecclesiastical tribunals in opposition to those held by the dukes and counts. At last, just as the kingdom had become the personal property of the king, so the officials—dukes, counts, royal vicars, tribunes, *centenarii*—who had for the most part bought their unpaid offices by means of presents to the monarch, came to look upon the public service rather as a mine of official wealth than as an administrative organization for furthering the interests, material or moral, of the whole nation. They became petty local tyrants, all the more despotic because they had nothing to fear save the distant authority of the king's *missi*, and the more rapacious because they had no salary save the fines they inflicted and the fees that they contrived to multiply. Gregory of Tours tells us that they were robbers, not protectors of the people, and that justice and the whole administrative apparatus were merely engines of insatiable greed. It was the abuses thus committed by the kings and their agents, who did not understand the art of gloving the iron hand, aided by the absolutely unfettered licence of conduct and the absence of any popular liberty, that occasioned the gradual increase of charters of immunity.

Immunity was the direct and personal privilege which forbade any royal official or his agents to decide cases, to levy taxes, or to exercise any administrative control on the domains of a bishop, an abbot, or one of the great secular nobles. On thousands of estates the royal government gradually allowed the law of the land to be superseded by local law, and public taxation to change into special contributions; so that the duties of the lower classes towards the state were transferred to the great landlords, who thus became loyal adherents of the king but absolute masters on their own territory. The Merovingians had no idea that they were abdicating the least part of their authority, nevertheless the deprivations acquiesced in by the feebler kings led of necessity to the diminution of their authority and their judicial powers, and to the abandonment of public taxation. They thought that by granting immunity they would strengthen their direct control; in reality they established the local independence of the great landowners, by allowing royal rights to pass into their hands. Then came confusion between the rights of the sovereign and the rights of property. The administrative machinery of the state still existed, but it worked in empty air: its taxpayers disappeared, those who were amenable to its legal jurisdiction slipped from its grasp, and the number of those whose affairs it should have directed dwindled away. Thus the Merovingians had shown themselves incapable of rising above the barbarous notion that royalty is a personal asset to the idea that royalty is of the state, a power belonging to the nation and instituted for the benefit of all. They represented in society nothing more than a force which grew feebler and feebler as other forces grew strong; they never stood for a national magistracy.

Society no less than the state was falling asunder by a gradual process of decay. Under the Merovingians it was a hierarchy wherein grades were marked by the varied scale of the *wergild*, a man being worth anything from thirty to six hundred gold pieces. The different degrees were those of slave, freedman, tenant-farmer and great landowner. As in every social scheme where the government is without real power, the weakest sought protection of the strongest; and the system of patron, client and journeyman, which had existed among the Romans, the Gauls and the Germans, spread rapidly in the 6th and 7th centuries, owing to public disorder and the inadequate protection afforded by the government. The Church's patronage provided some with a refuge from violence; others ingratiated themselves with the rich for the sake of shelter and security; others again sought place and honour from men of power; while women, churchmen and warriors alike claimed the king's direct and personal protection.

This hierarchy of persons, these private relations of man to man, were recognized by custom in default of the law, and were soon strengthened by another and territorial hierarchy. The large estate, especially if it belonged to the Church, very soon absorbed the few fields of the freeman. In order to farm these, the Church and the rich landowners granted back the holdings on the temporary and conditional terms of tenancy-at-will or of the *beneficium*, thus multiplying endlessly the land subject to their overlordship and the men who were dependent upon them as tenants. The kings, like private individuals and ecclesiastical establishments, made use of the *beneficium* to reward their servants; till finally their demesne was so reduced by these perpetual grants that they took to distributing among their champion lands owning the overlordship of the Church, or granted their own lands for single lives only. These various "benefactions" were, as a rule, merely the indirect methods which the great landowners employed in order to absorb the small proprietor. And so well did they succeed, that in the 6th and 7th centuries the provincial hierarchy consisted of the cultivator, the holder of the *beneficium* and the owner; while this dependence of one man upon another affected the personal liberty of a large section of the community, as well as the condition of the land. The great landowner tended to become not only lord over his tenants, but also himself a vassal of the king.

Immunity.

Disruption of the social framework.

The beneficium.

Thus by means of immunities, of the *beneficium* and of patronage, society gradually organized itself independently of the state, since it required further security. Such extra security was first provided by the conqueror of Tertry; for Pippin II. represented the two great families of Pippin and of Arnulf, and consequently the two interests then paramount, *i.e.* land and religion, while he had at his back a great company of followers and vast landed estates. For forty years (615-655) the office of mayor of Austrasia had gone down in his family almost continuously in direct descent from father to son. The death of Grimoald had caused the loss of this post, yet Ansegisus (Ansegisel), Arnulf's son and Pippin's son-in-law, had continued to hold high office in the Austrasian palace; and about 680 his son, Pippin II., became master of Austrasia, although he had held no previous office in the palace. His dynasty was destined to supplant that of the Merovingian house.

Pippin of Heristal was a pioneer; he it was who began all that his descendants were afterwards to carry through. Thus he gathered the nobles about him not by virtue of his position, but because of his own personal prowess, and because he could assure them of justice and protection; instead of being merely the head of the royal palace he was the absolute lord of his own followers. Moreover, he no longer bore the title of mayor, but that of duke or prince of the Franks; and the mayoralty, like the royal power now reduced to a shadow, became an hereditary possession which Pippin could bestow upon his sons. The reigns of Theuderich III., Clovis III. or Childebert III. are of no significance except as serving to date charters and diplomas. Pippin it was who administered justice in Austrasia, appointed officials and distributed dukedoms; and it was Pippin, the military leader, who defended the frontiers threatened by Frisians, Alamanni and Bavarians. Descended as he was from Arnulf, bishop of Metz, he was before all things a churchman, and behind his armies marched the missionaries to whom the Carolingian dynasty, of which he was the founder, were to subject all Christendom. Pippin it was, in short, who governed, who set in order the social confusions of Neustria, who, after long wars, put a stop to the malpractices of the dukes and counts, and summoned councils of bishops to make good regulations. But at his death in 714 the child-king Dagobert III. found himself subordinated to Pippin's two grandsons, who, being minors, were under the wardship of their grandmother Plectrude.

Pippin's work was almost undone—a party among the Neustrians under Raginfrid, mayor of the palace, revolted against Pippin II.'s adherents, and Radbod, duke of the Frisians, joined them. But the Austrasians appealed to an illegitimate son of Pippin, Charles Martel (715-741). Martel, who had escaped from the prison to which Plectrude, alarmed at his prowess, had consigned him, and took him for their leader. With Charles Martel begins the great period of Austrasian history. Faithful to the traditions of the Austrasian mayors, he chose kings for himself—Clotaire IV., then Chilperic II. and lastly Theuderich IV. After Theuderich's death (737) he left the throne vacant until 742, but he himself was king in all but name; he presided over the royal tribunals, appointed the royal officers, issued edicts, disposed of the funds of the treasury and the churches, conferred immunities upon adherents, who were no longer the king's nobles but his own, and even appointed the bishops, though there was nothing of the ecclesiastic about himself. He decided questions of war and peace, and re-established unity in Gaul by defeating the Neustrians and the Aquitanian followers of Duke Odo (Eudes) at Vincy in 717. When Odo, brought to bay, appealed for help to the Arab troops of Abd-ar-Rahman, who after conquering Spain had crossed the Pyrenees, Charles, like a second Clovis, saved Catholic Christendom in its peril by crushing the Arabs at Tours (732). The retreat of the Arabs, who were further weakened by religious disputes, enabled him to restore Frankish rule in Aquitaine in spite of Hunald, son of Odo. But Charles's longest expeditions were made into Germany, and in these he sought the support of the Church, then

the greatest of all powers since it was the depository of the Roman imperial tradition.

No less unconscious of his mission than Clovis had been, Charles Martel also was a soldier of Christ. He protected the missionaries who paved the way for his militant invasions. Without him the apostle of Germany, the English monk Boniface, would never have succeeded in preserving the purity of the faith and keeping the bishops submissive to the Holy See. The help given by Charles had two very far-reaching results. Boniface was the instrument of the union of Rome and Germany, of which union the Holy Roman Empire in Germany was in the 10th century to become the most perfect expression, continuing up to the time of Luther. And Boniface also helped on the alliance between the papacy and the Carolingian dynasty, which, more momentous even than that between Clovis and the bishops of Gaul, was to sanctify might by right.

This union was imperative for the bishops of Rome if they wished to establish their supremacy, and their care for orthodoxy by no means excluded all desire of domination. Mere religious authority did not secure to them the obedience of either the faithful or the clergy; moreover, they had to consider the great secular powers, and in this respect their temporal position in Italy was growing unbearable. Their relations with the East Roman emperor (sole lord of the world after the Roman Senate had sent the imperial insignia to Constantinople in 476) were confined to receiving insults from him or suspecting him of heresy. Even in northern Italy there was no longer any opposition to the progress of the Lombards, the last great nation to be established towards the end of the 6th century within the ancient Roman empire—their king Liudprand clearly intended to seize Italy and even Rome itself. Meanwhile from the south attacks were being made by the rebel dukes of Spoleto and Beneventum. Pope Gregory III. cherished dreams of an alliance with the powerful duke of the Franks, as St Remigius before him had thought of uniting with Clovis against the Goths. Charles Martel had protected Boniface on his German missions: he would perhaps lend Gregory the support of his armies. But the warrior, like Clovis aforetime, hesitated to put himself at the disposal of the priest. When it was a question of winning followers or keeping them, he had not scrupled to lay hands on ecclesiastical property, nor to fill the Church with his friends and kinsfolk, and this alliance might embarrass him. So if he loaded the Roman ambassadors with gifts in 739, he none the less remembered that the Lombards had just helped him to drive the Saracens from Provence. However, he died soon after this, on the 22nd of October 741, and Gregory III. followed him almost immediately.

Feeling his end near, Charles, before an assembly of nobles, had divided his power between his two sons, Carloman and Pippin III. The royal line seemed to have been forgotten for six years, but in 742 Pippin brought a son of Chilperic II. out of a monastery and made him king. This Childeric III. was but a shadow—and knew it. He made a phantom appearance once every spring at the opening of the great annual national convention known as the Campus Martius (Champ de Mars): a dumb idol, his chariot drawn in leisurely fashion by oxen, he disappeared again into his palace or monastery. An unexpected event re-established unity in the Carolingian family. Pippin's brother, the pious Carloman, became a monk in 747, and Pippin, now sole ruler of the kingdom, ordered Childeric also to cut off his royal locks; after which, being king in all but name, he adopted that title in 752. Thus ended the revolution which had been going on for two centuries. The disappearance of Grippio, Pippin's illegitimate brother, who, with the help of all the enemies of the Franks—Alamanni, Aquitanians' and Bavarians—had disputed his power, now completed the work of centralization, and Pippin had only to maintain it. For this the support of the Church was indispensable, and Pippin understood the advantages of such an alliance better than Charles Martel. A son of the Church, a protector of bishops, a president of councils, a collector of relics, devoted to Boniface

Pippin of Heristal.

Charles Martel and the Church.

Charles Martel and Gregory III.

The Carolingian dynasty.

Pippin the Short, 752-768.

(whom he invited, as papal legate, to reform the clergy of Austrasia), he astutely accepted the new claims of the vicar of St Peter to the headship of the Church, perceiving the value of an alliance with this rising power.

Prudent enough to fear resistance if he usurped the Merovingian crown, Pippin the Short made careful preparations for his accession, and discussed the question of the dynasty with Pope Zacharias. Receiving a favourable opinion, he had himself anointed and crowned by Boniface in the name of the bishops, and was then proclaimed king in an assembly of nobles, counts and bishops at Soissons in November 751. Still, certain disturbances made him see that aristocratic approval of his kingship might be strengthened if it could claim a divine sanction which no Merovingian had ever received. Two years later, therefore, he demanded a consecration of his usurpation from the pope, and in St Denis on the 28th of July 754 Stephen II. crowned and anointed not only Pippin, but his wife and his two sons as well.

The political results of this custom of coronation were all-important for the Carolingians, and later for the first of the

Capets. Pippin was hereby invested with new dignity, and when Boniface's anointing had been confirmed by that of the pope, he became the head of the Frankish Church, the equal of the pope. Moreover, he astutely

contrived to extend his priestly prestige to his whole family; his royalty was no longer merely a military command or a civil office, but became a Christian priesthood. This sacred character was not, however, conferred gratuitously. On the very day of his coronation Pippin allowed himself to be proclaimed patrician of the Romans by the pope, just as Clovis had been made consul. This title of the imperial court was purely honorary, but it attached him still more closely to Rome, though without lessening his independence. He had besides given a written promise to defend the Church of Rome, and that not against the Lombards only. Qualified by letters of the papal chancery as "liberator and defender of the Church," his armies twice (754-756) crossed the Alps, despite the opposition of the Frankish aristocracy, and forced Aistulf, king of the Lombards, to cede to him the exarchate of Ravenna and the Pentapolis. Pippin gave them back to Pope Stephen II., and by this famous donation founded that temporal power of the popes which was to endure until 1870. He also dragged the Western clergy into the pope's quarrel with the emperor at Constantinople, by summoning the council of Gentilly, at which the iconoclastic heresy was condemned (767). Matters being thus settled with Rome, Pippin again took up his wars against the Saxons, against the Arabs (whom he drove from Narbonne in 758), and above all against Waifer, duke of Aquitaine, and his ally, duke Tassilo of Bavaria. This last war was carried on systematically from 760 to 768, and ended in the death of Waifer and the definite establishment of the Frankish hold on Aquitaine. When Pippin died, aged fifty-four, on the 24th of September 768, the whole of Gaul had submitted to his authority.

Pippin left two sons, and before he died he had, with the consent of the dignitaries of the realm, divided his kingdom between them, making the elder, Charles (Charlemagne), king of Austrasia, and giving the younger, Carloman, Burgundy, Provence, Septimania, Alsace and Alamannia, and half of Aquitaine to each. On the 9th of October 768 Charles was enthroned at Noyon in solemn assembly, and Carloman at Soissons. The Carolingian sovereignty was thus neither hereditary nor elective, but was handed down by the will of the reigning king, and by a solemn acceptance of the future king on the part of the nobles. In 771 Carloman, with whom Charles had had disputes, died, leaving sons; but bishops, abbots and counts all declared for Charles, save a few who took refuge in Italy with Desiderius, king of the Lombards. Desiderius, whose daughter Bertha or Desiderata Charles, despite the pope, had married at the instance of his mother Bertrade, supported the rights of Carloman's sons, and threatened Pope Adrian in Rome itself after he had despoiled him of Pippin's territorial gift. At the pope's appeal Charles crossed the Alps, took

Verona and Pavia after a long siege, assumed the iron crown of the Lombard kings (June 774), and made a triumphal entry into Rome, which had not formed part of the pope's desires. Pippin's donation was restored, but the protectorate was no longer so distant, respectful and intermittent as the pope liked. After the departure of the imperious conqueror, a fresh revolt of the Lombards of Beneventum under Arichis, Desiderius's son-in-law, supported by a Greek fleet, obliged Pope Adrian to write fresh entreaties to Charlemagne; and in two campaigns (776-777) the latter conquered the whole Lombard kingdom. But another of Desiderius's daughters, married to the powerful duke Tassilo of Bavaria, urged her husband to avenge her father, now imprisoned in the monastery of Corbie. After endless intrigues, however, the duke, hemmed in by three different armies, had in his turn to submit (788), and all Italy was now subject to Charlemagne. These wars in Italy, even the fall of the Lombard kingdom and the recapture of the duchy of Bavaria, were merely episodes: Charlemagne's great war was against the Saxons and lasted thirty years (772-804).

The work of organizing the three great Carolingian conquests—Aquitaine, Italy and Saxony—had yet to be done. Charlemagne approached it with a moderation equal to the vigour which he had shown in the war. But by multiplying its advance-posts, the Frankish kingdom came into contact with new peoples, and each new neighbour meant a new enemy. Aquitaine bordered upon Mussulman Spain; the Avars of Hungary threatened Bavaria with their tireless horsemen; beyond the Elbe and the Saal the Slavs were perpetually at war with the Saxons, and to the north of the Eider were the Danes. All were pagans; all enemies of Charlemagne, defender of Christ's Church, and hence the appointed conqueror of the world.

Various causes—the weakening of the Arabs by the struggle between the Omayyads and the Abbasids just after the battle of Tours; the alliance of the petty Christian kings of the Spanish peninsula; an appeal from the northern amirs who had revolted against the new caliphate of Cordova (755)—made Charlemagne resolve to cross the Pyrenees. He penetrated as far as the Ebro, but was defeated before Saragossa; and in their retreat the Franks were attacked by Vascons, losing many men as they came through the passes. This defeat of the rear-guard, famous for the death of the great Roland and the treachery of Ganelo, induced the Arabs to take the offensive once more and to conquer Septimania. Charlemagne had created the kingdom of Aquitaine especially to defend Septimania, and William, duke of Toulouse, from 790 to 806, succeeded in restoring Frankish authority down to the Ebro, thus founding the Spanish March with Barcelona as its capital. For two centuries and a half the Avars, a remnant of the Huns entrenched in the Hungarian Mesopotamia, had made descents alternately upon the Germans and upon the Greeks of the Eastern empire. They had overrun Bavaria in the very year of its subjugation by Charlemagne (788), and it took an eight-years' struggle to destroy the robber stronghold. The empire thus pushed its frontier-line on from the Elbe to the Oder, ever as it grew menaced by increasing dangers. The sea came to the help of the depopulated land, and Danish pirates, Widukind's old allies, came in their leathern boats to harry the coasts of the North Sea and the Channel. Permanent armies and walls across isthmuses were alike useless; Charlemagne had to build fleets to repulse his elusive foes (808-810), and even after forty years of war the danger was only postponed.

Meanwhile Pippin's Frankish kingdom, vast and powerful as it had been, was doubled. All nations from the Oder to the Elbe and from the Danube to the Atlantic were subject or tributary, and Charlemagne's power even crossed these frontiers. At his summons Christian princes and Mussulman amirs flocked to his palaces. The kings of Northumbria and Sussex, the kings of the Basques and of Galicia, Arab amirs of Spain and Fez, and even the caliph of Bagdad came to visit him in person or sent gifts by the hands of ambassadors. A great warrior and an upright ruler, his

Sacred character of the new monarchy.

Pippin and the Papacy.

Organization of the conquests.

Wars with the Arabs, Slavs and Danes.

Charlemagne.

Charlemagne's empire.

conquests recalled those of the great Christian emperors, and the Church completed the parallel by training him in her lore. This still barely civilized German literally went to school to the English Alcuin and to Peter of Pisa, who, between two campaigns, taught him history, writing, grammar and astronomy, satisfying also his interest in sacred music, literature (religious literature especially), and the traditions of Rome and Constantinople. Why should he not be the heir of their Caesars? And so, little by little, this man of insatiable energy was possessed by the ambition of restoring the Empire of the West in his own favour.

There were, however, two serious obstacles in the way: first, the supremacy of the emperor of the East, which though nominal

Charlemagne emperor (800).

rather than real was upheld by peoples, princes, and even by popes; secondly, the rivalry of the bishops of Rome, who since the early years of Adrian's pontificate had claimed the famous "Donation of Constantine" (*q.v.*). According to that apocryphal document, the emperor after his baptism had ceded to the sovereign pontiff his imperial power and honours, the purple chlamys, the golden crown, "the town of Rome, the districts and cities of Italy and of all the West." But in 797 the empress of Constantinople had just deposed her son Constantine VI. after putting out his eyes, and the throne might be considered vacant; while on the other hand, Pope Leo III., who had been driven from Rome by a revolt in 799, and had only been restored by a Frankish army, counted for little beside the Frankish monarch, and could not but submit to the wishes of the Carolingian court. So when next year the king of the Franks went to Rome in person, on Christmas Eve of the year 800 and in the basilica of St Peter the pope placed on his head the imperial crown and did him reverence "after the established custom of the time of the ancient emperors." The Roman ideal, handed down in tradition through the centuries, was here first revived.

This event, of capital importance for the middle ages, was fertile in results both beneficial and the reverse. It brought about the rupture between the West and Constantinople. Then Charlemagne raised the papacy on the ruins of Lombardy to the position of first political power in Italy; and the universal Church, headed by the pope, made common cause with the Empire, which all the thinkers of that day regarded as the ideal state. Confusion between these powers was inevitable, but at this time neither Charles, the pope, nor the people had a suspicion of the troubles latent in the ceremony that seemed so simple. Thirdly, Charlemagne's title of emperor strengthened his other title of king of the Franks, as is proved by the fact that at the great assembly of Aix-la-Chapelle in 802 he demanded from all, whether lay or spiritual, a new oath of allegiance to himself as Caesar. His increased power came rather from moral value, from the prestige attaching to one who had given proof of it, than from actual authority over men or centralization; this is shown by the division between the Empire and feudalism. Universal sovereignty claimed as a heritage from Rome had a profound influence upon popular imagination, but in no way modified that tendency to separation of the various nations which was already manifest. Charles himself in his government preferred to restore the ancient Empire by vigorous personal action, rather than to follow old imperial traditions; he introduced cohesion into his "palace," and perfect centralization into his official administration, inspiring his followers and servants, clerical and lay, with a common and determined zeal. The system was kept in full vigour by the *missi dominici*, who regularly reported or reformed any abuses of administration, and by the courts, military, judicial or political, which brought to Charlemagne the strength of the wealth of his subjects, carrying his commands and his ideas to the farthest limits of the Empire. Under him there was in fact a kind of early renaissance after centuries of barbarism and ignorance.

The Carolingian Renaissance.

This emperor, who assumed so high a tone with his subjects, his bishops and his counts, who undertook to uphold public order in civil life, held himself no less responsible for the eternal salvation of men's souls in the other world. Thanks to Charlemagne, and through the

restoration of order and of the schools, a common civilization was prepared for the varied elements of the Empire. By his means the Church was able to concentrate in the palatine academy all the intellectual culture of the middle ages, having preserved some of the ancient traditions of organization and administration and guarded the imperial ideal. Charlemagne apparently wished, like Theodoric, to use German blood and Christian unity to bring back life to the great body of the Empire. Not the equal of Caesar or Augustus in genius or in the lastingness of his work, he yet recalls them in his capitularies, his periodic courts, his official hierarchy, his royal emissaries, his ministers, his sole right of coinage, his great public works, his campaigns against barbarism and heathenry, his zeal for learning and literature, and his divinity as emperor. Once more there existed a great public entity such as had not been seen for many years; but its duration was not to be a long one.

Charlemagne had for the moment succeeded in uniting western Europe under his sway, but he had not been able to arrest its evolution towards feudal dismemberment. He had, doubtless conscientiously, laboured for the reconstitution of the Empire; but it often happens that individual wills produce results other than those at which they aimed, sometimes results even contrary to their wishes, and this was what happened in Charlemagne's case. He had restored the superstructure of the imperial monarchy, but he had likewise strengthened and legalized methods and institutions till then private and insecure, and these, passing from custom into law, undermined the foundations of the structure he had thought himself to be repairing. A quarter of a century after his death his Empire was in ruins.

The practice of giving land as a *beneficium* to a grantee who swore personal allegiance to the grantor had persisted, and by his capitularies Charlemagne had made these personal engagements, these contracts of immunity—hitherto not transferable, nor even for life, but quite conditional—regular, legal, even obligatory and almost indissoluble. The *beneficium* was to be as practically irrevocable as the oath of fidelity. He submitted to the yoke of the social system and feudal institutions at the very moment when he was attempting to revive royal authority; he was ruler of the state, but ruler of vassals also. The monarchical principle no longer sufficed to ensure social discipline; the fear of forfeiting the grant became the only powerful guarantee of obedience, and as this only applied to his personal vassals, Charlemagne gave up his claim to direct obedience from the rest of the people, accepting the mediation of the counts, lords and bishops, who levied taxes, adjudicated and administered in virtue of the privileges of patronage, not of the right of the state. The very multiplication of offices, so noticeable at this time, furthered this triumph of feudalism by multiplying the links of personal dependence, and neutralizing more and more the direct action of the central authority. The frequent convocations of military assemblies, far from testifying to political liberty, was simply a means of communicating the emperor's commands to the various feudal groups.

Thus Charlemagne, far from opposing, systematized feudalism, in order that obedience and discipline might pass from one man to another down to the lowest grades of society, and he succeeded for his own lifetime. No authority was more weighty or more respected than that of this feudal lord of Gaul, Italy and Germany; none was more transient, because it was so purely personal.

When the great emperor was buried at Aix-la-Chapelle in 814, his work was entombed with him. The fact was that his successors were incapable of maintaining it. Twenty-nine years after his death the Carolingian Empire had been divided into three kingdoms; forty years later one alone of these kingdoms had split into seven; while when a century had passed France was a litter of tiny states each practically independent. This disintegration was caused neither by racial hate nor by linguistic patriotism. It was the weakness of princes, the discouragement of freemen and landholders confronted by an inexorable system of financial

Dissolution of the Frankish Empire.

Causes for the dissolution of the Empire.

and military tyranny, and the incompatibility of a vast empire with a too primitive governmental system, that wrecked the work of Charlemagne.

The Empire fell to Louis the Pious, sole survivor of his three sons. At the Aix assembly in 813 his father had crowned him

Louis the Pious (814-840).

with his own hand, thus avoiding the papal sanction that had been almost forced upon himself in 800. Louis was a gentle and well-trained prince, but weak and prone to excessive devotion to the Church. He had only reigned a few years when dissensions broke out on all sides, as under the Merovingians. Charlemagne had assigned their portions to his three sons in 781 and again in 806; like Charles Martel and Pippin the Short before him, however, what he had divided was not the imperial authority, nor yet countries, but the whole system of fiefs, offices and adherents which had been his own patrimony. The division that Louis the Pious made at Aix in 817 among his three sons, Lothair, Pippin and Louis, was of like character, since he reserved the supreme authority for himself, only associating Lothair, the eldest, with him in the government of the empire. Following the advice of his ministers Walla and Agobard, supporters of the policy of unity, Louis the Pious put Bernard of Italy, Charlemagne's grandson, to death for refusing to acknowledge Lothair as co-emperor; crushed a revolt in Brittany; and carried on among the Danes the work of evangelization begun among the Slavs. A fourth son, Charles, was born to him by his second wife, Judith of Bavaria. Jealousy arose between the children of the two marriages. Louis tried in vain to satisfy his sons and their followers by repeated divisions—at Worms (829) and at Aix (831)—in which there was no longer question of either unity or subordination. Yet his elder sons revolted against him in 831 and 832, and were supported by Walla and Agobard and by their followers, weary of all the contradictory oaths demanded of them. Louis was deposed at the assembly of Compiègne (833), the bishops forcing him to assume the garb of a penitent; but he was re-established on his throne in St Etienne at Metz, the 28th of February 835, from which time until his death in 840 he fell more and more under the influence of his ambitious wife, and thought only of securing an inheritance for Charles, his favourite son.

Hardly was Louis buried in the basilica of Metz before his sons flew to arms. The first dynastic war broke out between Lothair, who by the settlement of 817 claimed the whole monarchy with the imperial title, and his brothers Louis and Charles. Lothair wanted, with the Empire, the sole right of patronage over the adherents of his house, but each of these latter chose his own lord according to individual interests, obeying his fears or his preferences. The three brothers finished their discussion by fighting for a whole day (June 25th, 841) on the plain of Fontanet by Auxerre; but the battle decided nothing, so Charles and Louis, in order to get the better of Lothair, allied themselves and their vassals by an oath taken in the plain of Strassburg (Feb. 14th, 842).

This, the first document in the vulgar tongue in the history of France and Germany, was merely a mutual contract of protection for the two armies, which nevertheless did not risk another battle. An amicable division of the imperial succession was arranged, and after an assessment of the empire which took almost a year, an agreement was signed at Verdun in August 843.

This was one of the important events in history. Each brother received an equal share of the dismembered empire.

Partition of the Empire at Verdun (843).

Louis had the territory on the right bank of the Rhine, with Spire, Worms and Mainz "because of the abundance of wine." Lothair took Italy, the valleys of the Rhone, the Saône and the Meuse, with the two capitals of the empire, Aix-la-Chapelle and Rome, and the title of emperor. Charles had all the country watered by the Scheldt, the Seine, the Loire and the Garonne, as far as the Atlantic and the Ebro. The partition of Verdun separated once more, and definitively, the lands of the eastern and western Franks. The former became modern Germany, the latter

France, and each from this time forward had its own national existence. However, as the boundary between the possessions of Charles the Bald and those of Louis was not strictly defined, and as Lothair's kingdom, having no national basis, soon disintegrated into the kingdoms of Italy, Burgundy and Arles, in Lotharingia, this great undefined territory was to serve as a tilting-ground for France and Germany on the very morrow of the treaty of Verdun and for ten centuries after.

Charles the Bald was the first king of western France. Anxious as he was to preserve Charlemagne's traditions of government, he was not always strong enough to do so, and warfare within his own dominions was often forced on him. The Norse pirates who had troubled Charlemagne showed a preference for western France, justified by the easy access afforded by river estuaries with rich monasteries on their shores. They began in 841 with the sack of Rouen; and from then until 912, when they made a settlement in one part of the country, though few in numbers they never ceased attacking Charles's kingdom, coming in their ships up the Loire as far as Auvergne, up the Garonne to Toulouse, and up the Seine and the Scheldt to Paris, where they made four descents in forty years, burning towns, pillaging treasure, destroying harvests and slaughtering the peasants or carrying them off into slavery. Charles the Bald thus spent his life sword in hand, fighting unsuccessfully against the Bretons, whose two kings, Nomenoë and Erispoë, he had to recognize in turn; and against the people of Aquitaine, who, in full revolt, appealed for help to his brother, Louis the German. He was beaten everywhere and always: by the Bretons at Ballon (845) and Juvardcil (851); by the people of Aquitaine near Angoulême (845); and by the Northmen, who several times extorted heavy ransoms from him. Before long, too, Louis the German actually allied himself with the people of Brittany and Aquitaine, and invaded France at the summons of Charles the Bald's own vassals. Though the treaty of Coblenz (860) seemed to reconcile the two kings for the moment, no peace was ever possible in Charles the Bald's kingdom. His own son Charles, king of Aquitaine, revolted, and Salomon proclaimed himself king of Brittany in succession to Erispoë, who had been assassinated. To check the Bretons and the Normans, who were attacking from the Atlantic and the Mediterranean, Charles the Bald found himself obliged to entrust the defence of the country to Robert the Strong, ancestor of the house of Capet and duke of the lands between Loire and Seine. Robert the Strong, however, though many times victorious over the incorrigible pirates, was killed by them in a fight at Brissarthe (866).

Charles the Bald (843-877).

Despite all this, Charles spoke authoritatively in his capitularies, and though incapable of defending western France, coveted other crowns and looked obstinately eastwards. He managed to become king of Lorraine on the death of his nephew Lothair II., and emperor and king of Germany on that of his other nephew Louis II. (875); though only by breaking the compact of the year 800.

Division of the kingdom into large fiefs.

In 876, the year before his death, he took a third crown, that of Italy, though not without a fresh defeat at Andernach by Louis the German's troops. His titles increased, indeed, but not his power; for while his kingdom was thus growing in area it was falling to pieces. The duchy with which he rewarded Robert the Strong was only a military command, but became a powerful fief. Baldwin I. (d. 879), count of Flanders, turned the country between the Scheldt, the Somme and the sea into another feudal principality. Aquitaine and Brittany were almost independent, Burgundy was in full revolt, and within thirty years Rollo, a Norman leader, was to be master of the whole of the lower Seine from the Cotentin to the Somme. The fact was that between the king's inability to defend the kingdom, and the powerlessness of nobles and peasants to protect themselves from pillage, every man made it his business to seek new protectors, and the country, in spite of Charles the Bald's efforts, began to be covered with strongholds, the peasant learning to live beneath the shelter of the donjon keeps. Such vassals gave themselves utterly to the lord who guarded them, working for him sword

or pickaxe in hand. The king was far away, the lord close at hand. Hence the sixty years of terror and confusion which came between Charlemagne and the death of Charles the Bald suppressed the direct authority of the king in favour of the nobles, and prepared the way for a second destruction of the monarchy at the hands of a stronger power (see FEUDALISM).

Before long Charles the Bald's followers were dictating to him; and in the disaffection caused by his feebleness and cowardice prelates and nobles allied themselves against him. If they acknowledged the king's authority at the assemblies of Yütz (near Thionville) in 844, they forced from him a promise that they should keep their fiefs and their dignities; and while establishing a right of control over all his actions they deprived him of his right of jurisdiction over them. Despite Charles's resistance his royal power dwindled steadily: an appeal to Hincmar, archbishop of Reims, entailed concessions to the Church. In 856 some of his vassals deserted him and went over to Louis the German. To win them back Charles had to sign a new charter, by the terms of which loyalty was no longer a one-sided engagement but a reciprocal contract between king and vassal. He gave up his personal right of distributing the fiefs and honours which were the price of adherence, and thus lost for the Carolingians the free disposal of the immense territories they had gradually usurped; they retained the over-lordship, it is true, but this over-lordship, without usufruct and without choice of tenant, was but a barren possession.

Like their territories public authority little by little slipped from the grasp of the Carolingians, largely because of their abuse of their too great power. They had concentrated the entire administration in their own hands. Like Charlemagne, Louis the Pious and Charles the Bald were omnipotent. There were no provincial assemblies, no municipal bodies, no merchant-gilds, no autonomous churches; the people had no means of making themselves heard; they had no place in an administration which was completely in the hands of a central hierarchy of officials of all ranks, from dukes to *scabini*, with counts, viscounts and *centenarii* in between. However, these dukes and counts were not merely officials: they too had become lords of *fideles*, of their own *advocati*, *centenarii* and *scabini*, whom they nominated, and of all the free men of the county, who since Charlemagne's time had been first allowed and then commanded to "commend" themselves to a lord, receiving feudal benefices in return. Any deprivation or supersession of the count might impoverish, dispossess or ruin the vassals of the entire county; so that all, vassals or officials, small and great, feeling their danger, united their efforts, and lent each other mutual assistance against the permanent menace of an overweening monarchy. Hence, at the end of the 9th century, the heredity of offices as well as of fiefs. In the disordered state of society official stability was a valuable warrant of peace, and the administrative hierarchy, lay or spiritual, thus formed a mould for the hierarchy of feudalism. There was no struggle with the king, simply a cessation of obedience; for without strength or support in the kingdom he was powerless to resist. In vain Charles the Bald affirmed his royal authority in the capitularies of Quierzy-sur-Oise (857), Reims (860), Pistes (864), Gondreville (872) and Quierzy-sur-Oise (877); each time in exchange for assent to the royal will and renewal of oaths he had to acquiesce in new safeguards against himself and by so much to diminish that power of protection against violence and injustice for which the weak had always looked to the throne. Far from forbidding the relation of lord and vassal, Charles the Bald imposed it upon every man in his kingdom, himself proclaiming the real incapacity and failure of that theoretic royal power to which he laid claim. Henceforward royalty had no servants, since it performed no service. There was no longer the least hesitation over the choice between liberty with danger and subjection with safety; men sought and found in vassalage the right to live, and willingly bartered away their liberty for it.

The degeneration of the monarchy was clearly apparent on the death of Charles the Bald, when his son, Louis the Stammerer, was only assured of the throne, which had passed by right of birth under the Merovingians and been hereditary under the earlier Carolingians, through his election by nobles and bishops under the direction of Hugh the Abbot, successor of Robert the Strong, each voter having been won over by gift of abbeys, counties or manors. When Louis died two years later (879), the same nobles met, some at Creil, the rest at Meaux, and the first party chose Louis of Germany, who preferred Lorraine to the crown; while the rest anointed Louis III. and Carloman, sons of the late king, themselves deciding how the kingdom was to be divided between the two princes. Thus the king no longer chose his own vassals; but vassals and fief-holders actually elected their king according to the material advantages they expected from him. Louis III. and Carloman justified their election by their brilliant victories over the Normans at Saucourt (881) and near Epernay (883); but at their deaths (882-884), the nobles, instead of taking Louis's boy-son, Charles the Simple, as king, chose Charles the Fat, king of Germany, because he was emperor and seemed powerful. He united once more the dominions of Charlemagne; but he disgraced the imperial throne by his feebleness, and was incapable of using his immense army to defend Paris when it was besieged by the Normans. Expelled from Italy, he only came to France to buy a shameful peace. When he died in January 888 he had not a single faithful vassal, and the feudal lords resolved never again to place the sceptre in a hand that could not wield the sword.

The death-struggle of the Carolingians lasted for a century of uncertainty and anarchy, during which time the bishops, counts and lords might well have suppressed the monarchy had they been hostile to it. Such, however, was not their policy; on the contrary, they needed a king to act as agent for their private interests, since he alone could invest their rank and dignities with an official and legitimate character. They did not at once agree on Charles's successor; for some of them chose Eudes (Odo), son of Robert the Strong, for his brilliant defence of Paris against the Normans in 885; others Guy, duke of Spoleto in Italy, who had himself crowned at Langres; while many wished for Arnulf, illegitimate son of Carloman, king of Germany and emperor. Eudes was victor in the struggle, and was crowned and anointed at Compiègne on the 29th of February 888; but five years later, meeting with defeat after defeat at the hands of the Normans, his followers deserted from him to Charles the Simple, grandson of Charles the Bald, who was also supported by Fulc, archbishop of Reims.

This first Carolingian restoration took place on the 28th of January 893, and thenceforward throughout this warlike period from 888 to 936 the crown passed from one dynasty to the other according to the interests of the nobles. After desperate strife, an agreement between the two rivals, Arnulf's support, and the death of Odo, secured it for Charles III., surnamed the Simple. His subjects remained faithful to him for a good while, as he put an end to the Norman invasions which had desolated the kingdom for two centuries, and cowed those barbarians, much to the benefit of France. By the treaty of St Clair-sur-Epte (911) their leader Rolf (Rollo) obtained one of Charles's daughters in marriage and the district of the Lower Seine which the Normans had long occupied, on condition that he and his men ceased their attacks and accepted Christianity. Having thus tranquillized the west, Charles took advantage of Louis the Child's death, and conquered Lorraine, in spite of opposition from Conrad, king of Germany (921). But his preference for his new conquest, and for a Lorrainer of low birth named Hagano, aroused the jealousy and discontent of his nobles. They first elected Robert, count of Paris (923), and then after his death in a successful battle near Soissons against Charles the

Louis the Stammerer (877-879).

Louis III. and Carloman (879-884).

Charles the Fat. (884-888.)

Death-struggle of the Carolingians (888-987).

King Odo (888-893).

Charles the Simple (893-929).

Simple, Rudolph of Burgundy, his son-in-law. But Herbert of Vermandois, one of the successful combatants at Soissons, coveted the countship of Laon, which Rudolph refused him; and he thereupon proclaimed Charles the Simple, who had confided his cause to him, as king once more. Seeing his danger Rudolph ceded the countship to Herbert, and Charles was relegated to his prison until his death in 929. After unsuccessful wars against the nobles of the South, against the Normans, who asserted that they were bound to no one except Charles the Simple, and against the Hungarians (who, now the Normans were pacified, were acting their part in the East), Rudolph had a return of good fortune in the years between 930 and 936, despite the intrigues of Herbert of Vermandois. Upon his death the nobles assembled to elect a king; and Hugh the Great, Rudolph's brother-in-law, moved by irresolution as much as by prudence, instead of taking the crown, preferred to restore the Carolingians once more in the person of Charles the Simple's son, Louis d'Outremer, himself claiming numerous privileges and enjoying the exercise of power unencumbered by a title which carried with it the jealousy of the nobles.

This restoration was no more peaceful than its predecessor. The Carolingians had as it were a fresh access of energy, and the struggle against the Robertinians went on relentlessly. Both sides employed similar methods: one was supported by Normandy, the other by Germany; the archbishop of Reims was for the Carolingians, the Robertinians had to be content with the less influential bishop of Sens. Louis soon proved to Hugh the Great, who was trying to play the part of a mayor of the palace, that he was by no means a *roi fainéant*; and the powerful duke of the Franks, growing uneasy, allied himself with Herbert of Vermandois, William of Normandy and his brother-in-law Otto I. king of Germany, who resented the loss of Lorraine. Louis defended himself with energy, aided chiefly by the nobles of the South, by his relative Edmund, king of the English, and then by Otto himself, whose brother-in-law he also had become. A peace advantageous to him was made in 942, and on the deaths of his two opponents, Herbert of Vermandois and William of Normandy, all seemed to be going well for him; but his guardianship of Richard, son of the duke of Normandy, aroused fresh strife, and on the 13th of July 945 he fell into an ambush and suffered a captivity similar to his father's of twenty-two years before. No one had befriended Charles the Simple, but Louis had his wife Gerberga, who won over to his cause the kings of England and Germany and even Hugh. Hugh set him free, insisting, as payment for his aid, on the cession of Laon, the capital of the kingdom and the last fortified town remaining to the Carolingians (946). Louis was hardly free before he took vengeance, harried the lands of his rival, restored to the archiepiscopal throne of Reims Artald, his faithful adviser, in place of the son of Herbert of Vermandois, and managed to get Hugh excommunicated by the council of Ingelheim (948) and by the pope. A two years' struggle wearied the rivals, and they made peace in 950. Louis once more held Laon, and in the following year further strengthened his position by a successful expedition into Burgundy. Still his last years were not peaceful; for besides civil wars there were two Hungarian invasions of France (951 and 954).

Louis's sudden death in 954 once more placed the Carolingian line in peril, since he had not had time to have his son Lothair crowned. For a third time Hugh had the disposal of the crown, and he was no more tempted to take it himself in 954 than in 923 or 936: it was too profitless a possession. Thanks to Hugh's support and to the good offices of Otto and his brother Bruno, archbishop of Cologne and duke of Lorraine, Lothair was chosen king and crowned at Reims. Hugh exacted, as payment for his disinterestedness and fidelity, a renewal of his sovereignty over Burgundy with that of Aquitaine as well; he was in fact the viceroy of the kingdom, and others imitated him by demanding indemnities, privileges and confirmation of rights, as was customary at the beginning of a reign.

Hugh strengthened his position in Burgundy, Lorraine and Normandy by means of marriages; but just as his power was at its height he died (956). His death and the minority of his sons, Hugh Capet and Eudes, gave the Carolingian dynasty thirty years more of life.

For nine years (956-965) Bruno, archbishop of Cologne, was regent of France, and thanks to him there was a kind of *entente cordiale* between the Carolingians and the Robertinians and Otto. Bruno made Lothair recognize Hugh as duke of France and Eudes as duke of Burgundy; but the sons preserved the father's enmity towards king Louis, despite the archbishop's repeated efforts. His death deprived Lothair of a wise and devoted guardian, even if it did set him free from German influence; and the death of Odalric, archbishop of Reims, in 969, was another fatal loss for the Carolingians, succeeded as he was by Adalbero, who, though learned, pious and highly intelligent, was none the less ambitious. On the death of Otto I. (973) Lothair wished to regain Lorraine; but his success was small, owing to his limited resources and the uncertain support of his vassals. In 980, regretting his fruitless quarrel with Otto II., who had ravaged the whole country as far as Paris, and fearing that even with the support of the house of Vermandois he would be crushed like his father Louis IV. between the duke of France and the emperor, who could count on the archbishop of Reims, Lothair made peace with Otto—a great mistake, which cost him the prestige he had gained among his nobles by his fairly successful struggle with the emperor, drawing down upon him, moreover, the swift wrath of Hugh, who thought himself tricked. Otto, meanwhile, whom he was unwise enough to trust, made peace secretly with Hugh, as it was his interest to play off his two old enemies one against the other. However, Otto died first (983), leaving a three-year-old son, Otto III., and Lothair, hoping for Lorraine, upheld the claims of Henry of Bavaria, who wished to oust Otto. This was a war-signal for Archbishop Adalbero and his adviser Gerbert, devoted to the idea of the Roman empire, and determined that it should still be vested in the race of Otto, which had always been beneficent to the Church.

They decided to set the Robertinians against the Carolingians, and on their advice Hugh Capet dispersed the assembly of Compiègne which Lothair had commissioned to examine Adalbero's behaviour. On Lothair's death in 986, Hugh surrounded his son and successor, Louis V., with intrigues. Louis was a weak-minded and violent young man with neither authority nor prestige, and Hugh tried to have him placed under tutelage. After Louis V.'s sudden death, aged twenty, in 987, Adalbero and Gerbert, with the support of the reformed Cluniac clergy, at the Assembly of Senlis eliminated from the succession the rightful heir, Charles of Lorraine, who, without influence or wealth, had become a stranger in his own country, and elected Hugh Capet, who, though rich and powerful, was superior neither in intellect nor character. Thus the triple alliance of Adalbero's bold and adroit imperialism with the cautious and vacillating ambition of the duke of the Franks, and the impolitic hostility towards Germany of the ruined Carolingians, resulted in the unlooked-for advent of the new Capetian dynasty.

This event completed the evolution of the forces that had produced feudalism, the basis of the medieval social system. The idea of public authority had been replaced by one that was simpler and therefore better fitted for a half-civilized society—that of dependence of the weak on the strong, voluntarily entered on by means of mutual contract. Feudalism had gained ground in the 8th century; feudalism it was which had raised the first Carolingian to the throne as being the richest and most powerful person in Austrasia; and Charlemagne with all his power had been as utterly unable as the Merovingians to revive the idea of an abstract and impersonal state. Charlemagne's vassals, however, had needed him; while from Charles the Bald onward it was the king who needed the vassals—a change more marked with each successive prince. The feudal system had in fact turned against the throne, the vassals using it to secure a permanent hold upon offices and

Rudolph of Burgundy (923-936).

Louis IV. the Foreigner (936-954.)

Louis V. (986-987).

Lothair (954-986).

Dismemberment of the kingdom.

fiefs, and to get possession of estates and of power. After Charles the Bald's death royalty had only, so to speak, a shell—administrative officialdom. No longer firmly rooted in the soil, the monarchy was helpless before local powers which confronted it, seized upon the land, and cut off connexion between throne and people. The king, the supreme lord, was the only lord without lands, a nomad in his own realms, merely lingering there until starved out. Feudalism claimed its new rights in the capitulary of Quierzy-sur-Oise in 857; the rights of the monarchy began to dwindle in 877.

But vassalage could only be a cause of disintegration, not of unity, and that this disintegration did not at once spread indefinitely was due to the dozen or so great military commands—Flanders, Burgundy, Aquitaine, &c.—which Charles the Bald had been obliged to establish on a strong territorial basis. One of these great vassals, the duke of France, was amply provided with estates and offices, in contrast to the landless Carolingian, and his power, like that of the future kings of Prussia and Austria, was based on military authority, for he had a frontier—that of Anjou. Then the inevitable crisis had come. For a hundred years the great feudal lords had disposed of the crown as they pleased, handing it back and forward from one dynasty to another. At the same time the contrast between the vast proportions of the Carolingian empire and its feeble administrative control over a still uncivilized community became more and more accentuated. The Empire crumbled away by degrees. Each country began to lead its own separate existence, stammering its own tongue; the different nations no longer understood one another, and no longer had any general ideas in common. The kingdoms of France and Germany, still too large, owed their existence to a series of dispossessions imposed on sovereigns too feeble to hold their own, and consisted of a great number of small states united by a very slight bond. At the end of the 10th century the duchy of France was the only central part of the kingdom which was still free and without organization. The end was bound to come, and the final struggle was between Laon, the royal capital, and Reims, the ecclesiastical capital, the former carrying with it the soil of France, and the latter the crown. The Capets captured the first in 985 and the other in 987. Thenceforth all was over for the Carolingians, who were left with no heritage save their great name.

Was the day won for the House of Capet? In the 11th century the kings of that line possessed meagre domains scattered about in the Ile de France among the seigniorial possessions of Brie, Beauce, Beauvaisis and Valois. They were hemmed in by the powerful duchy of Normandy, the counties of Blois, Flanders and Champagne, and the duchy of Burgundy. Beyond these again stretched provinces practically impenetrable to royal influence: Brittany, Gascony, Toulouse, Septimania and the Spanish March. The monarchy lay stifling in the midst of a luxuriant feudal forest which surrounded its only two towns of any importance: Paris, the city of the future, and Orleans, the city of learning. Its power, exercised with an energy tempered by prudence, ran to waste like its wealth in a suzerainty over turbulent vassals devoid of common government or administration, and was undermined by the same lack of social discipline among its vassals which had sapped the power of the Carolingians. The new dynasty was thus the poorest and weakest of the great civil and ecclesiastical lordships which occupied the country from the estuary of the Scheldt to that of the Llobregat, and bounded approximately by the Meuse, the Saône and the ridge of the Cévennes; yet it cherished a great ambition which it revealed at times during its first century (987-1108)—a determination not to repeat the Carolingian failure. It had to wait two centuries after the revolution of 987 before it was strong enough to take up the dormant tradition of an authority like that of Rome; and until then it cunningly avoided unequal strife in which, victory being impossible, reverses might have weakened those titles, higher than any due to feudal rights, conferred by the heritage of the Caesars and the coronation at Reims, and held in reserve for the future.

The new dynasty thus at first gave the impression rather of decrepitude than of youth, seeming more a continuation of the Carolingian monarchy than a new departure. Hugh Capet's reign was one of disturbance and danger; behind his dim personality may be perceived the struggle of greater forces—royalty and feudalism, the French clergy and the papacy, the kingdom of France and the Empire. Hugh Capet needed more than three years and the betrayal of his enemy into his hands before he could parry the attack of a quite second-rate adversary, Charles of Lorraine (990), the last descendant of Charlemagne. The insubordination of several great vassals—the count of Vermandois, the duke of Burgundy, the count of Flanders—who treated him as he had treated the Carolingian king; the treachery of Arnulf, archbishop of Reims, who let himself be won over by the empress Theophano; the papal hostility inflamed by the emperor against the claim of feudal France to independence,—all made it seem for a time as though the unity of the Roman empire of the West would be secured at Hugh's expense and in Otto's favour; but as a matter of fact this papal and imperial hostility ended by making the Capet dynasty a national one. When Hugh died in 996, he had succeeded in maintaining his liberty mainly, it is true, by diplomacy, not force, despite opposing powers and his own weakness. Above all, he had secured the future by associating his son Robert with him on the throne; and although the nobles and the archbishop of Reims were disturbed by this suspension of the feudal right of election, and tried to oppose it, they were unsuccessful.

Robert the Pious, a crowned monk, resembled his father in eschewing great schemes, whether from timidity or prudence; yet from 996 to 1031 he preserved intact the authority he had inherited from Hugh, despite many domestic disturbances. He maintained a defiant attitude towards Germany; increased his heritage; strengthened his royal title by the addition of that of duke of Burgundy after fourteen years of pillage; and augmented the royal domain by adding several countships on the south-east and north-west. Limited in capacity, he yet understood the art of acquisition.

Henry I., his son, had to struggle with a powerful vassal, Eudes, count of Chartres and Troyes, and was obliged for a time to abandon his father's anti-German policy. Eudes, who was rash and adventurous, in alliance with the queen-mother, supported the second son, Robert, and captured the royal town of Sens. In order to retake it Henry ceded the beautiful valley of the Saône and the Rhône to the German emperor Conrad, and henceforth the kingdom of Burgundy was, like Lorraine, to follow the fortunes of Germany. Henry had besides to invest his brother with the duchy of Burgundy—a grave error which hampered French politics during three centuries. Like his father, he subsequently managed to retrieve some of the crown lands from William the Bastard, the too-powerful duke of Normandy; and he made a praiseworthy though fruitless attempt to regain possession of Lorraine for the French crown. Finally, by the coronation of his son Philip (1059) he confirmed the hereditary right of the Capets, soon to be superior to the elective rights of the bishops and great barons of the kingdom. The chief merit of these early Capets, indeed, was that they had sons, so that their dynasty lasted on without disastrous minorities or quarrels over the division of inheritance.

Philip I. achieved nothing during his long reign of forty-eight years except the necessary son, Louis the Fat. Unsuccessful even in small undertakings he was utterly incapable of great ones; and the two important events of his reign took place, the one against his will, the other without his help. The first, which lessened Norman aggression in his kingdom, was William the Bastard's conquest of England (1066); the second was the First Crusade preached by the French pope Urban II. (1095). A few half-hearted campaigns against recalcitrant vassals and a long and obstinate quarrel with the papacy over his adulterous union with Bertrade de Montfort, countess of Anjou, represented the total activity

Hugh Capet
(987-996).

Robert the Pious
(996-1031).

Henry I.
(1031-1060).

Philip I.
(1060-1108).

The House of Capet.

of Philip's reign; he was greedy and venal, by no means disdaining the petty profits of brigandage, and he never left his own domains.

After a century's lethargy the house of Capet awoke once more with Louis VI. and began the destruction of the feudal polity.

Louis VI. the Fat (1108-1137). For thirty-four years of increasing warfare this active and energetic king, this brave and persevering soldier, never spared himself, energetically policing the royal demesne against such pillagers as Hugh of Le Puiset or Thomas of Marle. There was, however, but little difference yet between a count of Flanders or of Chartres and Louis VI., the possessor of a but small and perpetually disturbed realm, who was praised by his minister, the monk Suger, for making his power felt as far as distant Berri! This was clearly shown when he attempted to force the great feudal lords to recognize his authority. His bold endeavour to establish William Clito in Flanders ended in failure; and his want of strength was particularly humiliating in his unfortunate struggle with Henry I., king of the English and duke of Normandy, who was powerful and well served, the real master of a comparatively weak baronage. Louis only escaped being crushed because he remembered, as did his successors for long after him, that his house owed its power to the Church.

The Church has never loved weakness; she has always had a secret sympathy for power, whatever its source, when she could hope to capture it and make it serve her ends. Louis VI. defended her against feudal robbers; and she supported him in his struggles against the nobles, making him, moreover, by his son's marriage with the heiress of Aquitaine, the greatest and richest landholder of the kingdom. But Louis was not the obedient tool she wished for. With equal firmness and success he vindicated his rights, whether against the indirect attacks of the papacy on his independence, or the claims of the ecclesiastical courts which, in principle, he made subordinate to the jurisdiction of the crown; whether in episcopal elections, or in ecclesiastical reforms which might possibly imperil his power or his revenues. The prestige of this energetic king, protector of the Church, of the infant communes in the towns, and of the peasants as against the constant oppressions of feudalism, became still greater at the end of his reign, when an invasion of the German emperor Henry V. in alliance with Henry Beauclerk of Normandy (Henry I. of England), rallied his subjects round the oriflamme of St Denis, awakening throughout northern France the unanimous and novel sentiment of national danger.

Unfortunately his successor, Louis VII., almost destroyed his work by a colossal blunder, although circumstances seemed much in his favour. Germany and England, the two powers especially to be dreaded, were busy with internal troubles and quarrels of succession. On the other hand, thanks to his marriage with Eleanor of Aquitaine, Louis's own domains had been increased

by the greater part of the country between the Loire and the Pyrenees; while his father's minister, the monk Suger, continued to assist him with his moderation and prudence. His first successes against Theobald of Champagne, who for thirty years had been the most dangerous of the great French barons and had refused a vassal's services to Louis VI., as well as the adroit diplomacy with which he wrested from Geoffrey the Fair, count of Anjou, a part of the Norman Vexin long claimed by the French kings, in exchange for permitting him to conquer Normandy, augured well for his boldness and activity, had he but confined them to serving his own interests. The second crusade, undertaken to expiate his burning of the church of Vitry, inaugurated a series of magnificent but fruitless exploits; while his wife was the cause of domestic quarrels still more disastrous. Piety and a thirst for glory impelled Louis to take the lead in this

fresh expedition to the Holy Land, despite the opposition of Suger, and the hesitation of the pope, Bernard of Clairvaux and the barons. The alliance with the German king Conrad III. only enhanced the difficulties of an enterprise already made hazardous by the misunderstandings between Greeks and Latins. The Crusade

ended in the double disaster of military defeat and martial dishonour (1147-1149); and Suger's death in 1151 deprived Louis of a counsellor who had exercised the regency skillfully and with success, just at the very moment when his divorce from Eleanor was to jeopardize the fortunes of the Capets.

For the proud and passionate Eleanor married, two months later (May 1152), the young Henry, count of Anjou and duke of Normandy, who held, besides these great fiefs, the whole of the south-west of France, and in two years' time the crown of England as well. Henry and Louis at once engaged in the first Capet-Angevin duel, destined to last a hundred years (1152-1242). When France and England thus entered European history, their conditions were far from being equal. In England royal power was strong; the size of the Angevin empire was vast, and the succession assured. It was only abuse of their too-great powers that ruined the early Angevin kings. France in the 12th century was merely a federation of separate states, jealously independent, which the king had to negotiate with rather than rule; while his own possessions, shorn of the rich heritage of Aquitaine, were, so to speak, swamped by those of the English king. For some time it was feared that the French kingdom would be entirely absorbed in consequence of the marriage between Louis's daughter and Henry II.'s eldest son. The two rivals were typical of their states, Henry II. being markedly superior to Louis in political resource, military talent and energy. He failed, however, to realize his ambition of shutting in the Capet king and isolating him from the rest of Europe by crafty alliances, notably that with the emperor Frederick Barbarossa—while watching an opportunity to supplant him upon the French throne. It is extraordinary that Louis should have escaped final destruction, considering that Henry had subdued Scotland, retaken Anjou from his brother Geoffrey, won a hold over Brittany, and schemed successfully for Languedoc. But the Church once more came to the rescue of her devoted son. The retreat to France of Pope Alexander III., after he had been driven from Rome by the emperor Frederick in favour of the anti-pope Victor, revived Louis's moral prestige. Henry II.'s quarrel with Thomas Becket, archbishop of Canterbury, which ran its course in France (1164-1171) as a struggle for the independence and reform of the Church, both threatened by the Constitutions of Clarendon, and ended with the murder of Becket in 1172, gave Louis yet another advantage over his rival. Finally the birth of Philip Augustus (1165), after thirty years of childless wedlock, saved the kingdom from a war of succession just at the time when the powerful Angevin sway, based entirely upon force, was jeopardized by the rebellion of Henry II.'s sons against their father. Louis naturally joined the coalition of 1173, but showed no more vigour in this than in his other wars; and his fate would have been sealed had not the pope checked Henry by the threat of an interdict, and reconciled the combatants (1177). Louis had still time left to effect the coronation of his son Philip Augustus (1179), and to associate him with himself in the exercise of the royal power for which he had grown too old and infirm.

Philip Augustus, who was to be the bitterest enemy of Henry II. and the Angevins, was barely twenty before he revealed the full measure of his cold energy and unscrupulous ambition. In five years (1180-1186) he rid himself of the overshadowing power of Philip of Alsace, count of Flanders, and his own uncles, the counts of Champagne; while the treaty of May 20th, 1186, was his first rough lesson to the feudal leagues, which he had reduced to powerlessness, and to the subjugated duke of Burgundy and count of Flanders. Northern and eastern France recognized the suzerainty of the Capet, and Philip Augustus was now bold enough to attack Henry II., the master of the west, whose friendly neutrality (assured by the treaty of Gisors) had made possible the successive defeats of the great French barons. Like his father, Philip understood how to make capital out of the quarrels of the aged and ailing Henry II. with his sons, especially with Richard, who claimed his French heritage in his father's lifetime, and raised up enemies for the disunited Angevins even

Rivalry of Capets and Angevins.

Phillip Augustus (1180-1223).

The second crusade.

in Germany. After two years of constant defeat, Henry's capitulation at Azai proved once more that fortune is never with the old. The English king had to submit himself to "the advice and desire of the king of France," doing him homage for all continental fiefs (1187-1189).

The defection of his favourite son John gave Henry his death-blow, and Philip Augustus found himself confronted by a new king of England, Richard Cœur de Lion, as powerful, besides being younger and more energetic. Philip's ambition could not rest satisfied with the petty principalities of Amiens, Vermandois and Valois, which he had added to the royal demesne. The third crusade, undertaken, sorely against Philip's will, in alliance with Richard, only increased the latent hostility between the two kings; and in 1191 Philip abandoned the enterprise in order to return to France and try to plunder his absent rival. Despite his solemn oath no scruples troubled him: witness the large sums of money he offered to the emperor Henry VI. if he would detain Richard, who had been made prisoner by the duke of Austria on his return from the crusade; and his negotiations with his brother John Lackland, whom he acknowledged king of England in exchange for the cession of Normandy. But Henry VI. suddenly liberated Richard, and in five years that "devil set free" took from Philip all the profit of his trickery, and shut him off from Normandy by the strong fortress of Château-Gaillard (1194-1199).

Happily an accident which caused Richard's death at the siege of Chalus, and the evil imbecility of his brother and successor, John Lackland, brilliantly restored the fortunes of the Capets. The quarrel between John and his nephew Arthur of Brittany gave Philip Augustus one of those opportunities of profiting by family discord which, coinciding with discontent among the various peoples subject to the house of Anjou, had stood him in such good stead against Henry II. and Richard. He demanded renunciation on John's part, not of Anjou only, but of Poitou and Normandy—of all his French-speaking possessions, in fact—in favour of Arthur, who was supported by William des Roches, the most powerful lord of the region of the Loire. Philip's divorce from Ingeborg of Denmark, who appealed successfully to Pope Innocent III., merely delayed the inevitable conflict. John of England, moreover, was a past-master in the art of making enemies of his friends, and his conduct towards his vassals of Aquitaine furnished a judicial pretext for conquest. The royal judges at Paris condemned John, as a felon, to death and the forfeiture of his fiefs (1203), and the murder of Arthur completed his ruin. Philip Augustus made a vigorous onslaught on Normandy in right of justice and of superior force, took the formidable fortress of Château-Gaillard on the Seine after several months' siege, and invested Rouen, which John abandoned, fleeing to England. In Anjou, Touraine, Maine and Poitou, lords, towns and abbeys made their submission, won over by Philip's bribes despite Pope Innocent III.'s attempts at intervention. In 1208 John was obliged to own the Plantagenet continental power as lost. There were no longer two rival monarchies in France; the feudal equilibrium was destroyed, to the advantage of the duchy of France.

But Philip in his turn nearly allowed himself to be led into an attempt at annexing England, and so reversing for his own benefit the work of the Angevins (1213); but, happily for the future of the dynasty, Pope Innocent III. prevented this. Thanks to the ecclesiastical sanction of his royalty, Philip had successfully braved the pope for twenty years, in the matter of Ingeborg and again in that of the German schism, when he had supported Philip of Swabia against Otto of Brunswick, the pope's candidate. In 1213, John Lackland, having been in conflict with Innocent regarding the archiepiscopal see of Canterbury, had made submission and done homage for his kingdom, and Philip wished to take vengeance for this at the expense of the rebellious vassals of the north-west, and of Renaud and Ferrand, counts of Boulogne and Flanders, thus combating English influence in those quarters.

This was a return to the old Capet policy; but it was also menacing to many interests, and sure to arouse energetic resistance. John seized the opportunity to consolidate against Philip a European coalition, which included most of the feudal lords in Flanders, Belgium and Lorraine, and the emperor Otto IV. So dangerous did the French monarchy already seem! John began operations with an attack from Anjou, supported by the notably capricious nobles of Aquitaine, and was routed by Philip's son at La Roche aux Moines, near Angers, on the 2nd of July 1214. Twenty-five days later the northern allies, intending to surprise the smaller French army on its passage over the bridge at Bouvines, themselves sustained a complete defeat. This first national victory had not only a profound effect on the whole kingdom, but produced consequences of far-reaching importance: in Germany it brought about Otto's fall before Frederick II.; in England it introduced the great drama of 1215, the first act of which closed with Magna Carta—John Lackland being forced to acknowledge the control of his barons, and to share with them the power he had abused and disgraced. In France, on the contrary, the throne was exalted beyond rivalry, raised far above a feudalism which never again ventured on acts of independence or rebellion. Bouvines gave France the supremacy of the West. The feudalism of Languedoc was all that now remained to conquer.

The whole world, in fact, was unconsciously working for Philip Augustus. Anxious not to risk his gains, but to consolidate them by organization, Philip henceforth until his death in 1223 operated through diplomacy alone, leaving to others the toil and trouble of conquests, the advantages of which were not for them. When his son Louis wished to wrest the English crown from John, now crushed by his barons, Philip intervened without seeming to do so, first with the barons, then with Innocent III., supporting and disowning his son by turns; until the latter, held in check by Rome, was forced to sign the treaty of Lambeth (1217). When the Church and the needy and fanatical nobles of northern and central France destroyed the feudal dynasty of Toulouse and the rich civilization of the south in the Albigensian crusade, it was for Philip Augustus that their leader, Simon de Montfort, all unknowing, conquered Languedoc. At last, instead of the two Frances of the *langue d'oc* and the *langue d'oïl*, there was but one royal France comprising the whole kingdom.

Philip Augustus was not satisfied with the destruction of a turbulent feudalism; he wished to substitute for it such unity and peace as had obtained in the Roman Empire; and just as he had established his supremacy over the feudal lords, so now he managed to extend it over the clergy, and to bend them to his will. He took advantage of their weakness in the midst of an age of violence. By contracts of "pariage" the clergy claimed and obtained the king's protection even in places beyond the king's jurisdiction, to their common advantage. Philip thus set the feudal lords one against the other; and against them all, first the Church, then the communes. He exploited also the townspeople's need for security and the instinct of independence which made them claim a definite place in the feudal hierarchy. He was the actual creator of the communes, although an interested creator, since they made a breach in the fortress of feudalism and extended the royal authority far beyond the king's demesne. He did even more: he gave monarchy the instruments of which it still stood in need, gathering round him in Paris a council of men humble in origin, but wise and loyal; while in 1190 he instituted *baillis* and *seneschals* throughout his enlarged dominions, all-powerful over the nobles and subservient to himself. He filled his treasury with spoils harshly wrung from all classes; thus inaugurating the monarchy's long and patient labours at enlarging the crown lands bit by bit through taxes on private property. Finally he created an army, no longer the temporary feudal *ost*, but a more or less permanent royal force. By virtue of all these organs of government the throne guaranteed peace, justice and a secure future, having routed

Coalition against Philip Augustus. (1214).

Philip Augustus and Richard Cœur de Lion.

Philip Augustus and John Lackland.

Admission of Philip Augustus.

feudalism with sword and diplomacy. Philip's son was the first of the Capets who was not crowned during his father's lifetime; a fact clearly showing that the principle of heredity had now been established beyond discussion.

Louis VIII.'s short reign was but a prolongation of Philip's in its realization of his two great designs: the recovery from Henry III. of England of Poitou as far as the Garonne; and the crusade against the Albigenses, which with small pains procured him the succession of Amaury de Montfort, and the Languedoc of the counts of Toulouse, if not the whole of Gascony. Louis VIII. died on his return from this short campaign without having proved his full worth.

But the history of France during the 11th and 12th centuries does not entirely consist of these painful struggles of the Capet dynasty to shake off the fetters of feudalism. France, no longer split up into separate fragments, now began to exercise both intellectual and military influence over Europe. Everywhere her sons gave proof of rejuvenated activity. The Christian missions which others were reviving in Prussia and beginning in Hungary were undertaken on a vaster scale by the Capets. These "elder sons of the Church" made themselves responsible for carrying out the "work of God," and French pilgrims in the Holy Land prepared the great movement of the Crusades against the infidels. Religious faith, love of adventure, the hope of making advantageous conquests, anticipations of a promised paradise—all combined to force this advance upon the Orient, which though failing to rescue the sepulchre of Christ, the ephemeral kingdoms of Jerusalem and Cyprus, the dukedom of Athens, or the Latin empire of Constantinople, yet gained for France that prestige for military glory and religious piety which for centuries constituted her strength in the Levant (see CRUSADES). At the call of the pope other members of the French chivalry also made victorious expeditions against the Mussulmans, and founded the Christian kingdom of Portugal. Obeying that enterprising spirit which was to take them to England half a century later, Normans descended upon southern Italy and wrested rich lands from Greeks and Saracens.

In the domain of intellect the advance of the French showed a no less dazzling and a no less universal activity; they sang as well as they fought, and their epics were worthy of their swordsmanship, while their cathedrals were hymns in stone as ardent as their soaring flights of devotion. In this period of intense religious life France was always in the vanguard. It was the ideas of Cluniac monks that freed the Church from feudal supremacy, and in the 11th century produced a Pope Gregory VII.; the spirit of free investigation shown by the heretics of Orleans inspired the rude Breton, Abelard, in the 12th century; and with Gerbert and Fulbert of Chartres the schools first kindled that brilliant light which the university of Paris, organized by Philip Augustus, was to shed over the world from the heights of Sainte-Geneviève. In the quarrels of the priesthood under the Empire it was St Bernard, the great abbot of Clairvaux, who tried to arrest the papacy on the slippery downward path of theocracy; finally, it was in Suger's church of St Denis that French art began that struggle between light against darkness which, culminating in Notre-Dame and the Sainte-Chapelle, was to teach the architects of the world the delight of building with airiness of effect. The old basilica which contains the history of the monarchy sums up the whole of Gothic art to this day, and it was Suger who in the domain of art and politics brought forward once more the conception of unity. The courteous ideal of French chivalry, with its "delectable" language, was adopted by all seigniorial Europe, which thus became animated, as it were, by the life-blood of France. Similarly, in the universal movement of those forces which made for freedom, France began the age-long struggle to maintain the rights of civil society and continually to enlarge the social categories. The townsman enriched by commerce and the emancipated peasant tried more or less valiantly to shake off

the yoke of the feudal system, which had been greatly weakened, if not entirely broken down, by the crusades. Grouped around their belfry-towers and organized within their guilds, they made merry in their free jocular language over their own hardships, and still more over the vices of their lords. They insinuated themselves into the counsels of their ignorant masters, and though still sitting humbly at the feet of the barons, these upright and well-educated servitors were already dreaming of the great deeds they would do when their tyrants should have vacated their high position, and when royalty should have summoned them to power.

By the beginning of the 13th century the Capet monarchy was so strong that the crisis occasioned by the sudden death of Louis VIII. was easily surmounted by the foreign woman and the child whom he left behind him. It is true that that woman was Blanche of Castile, and that child the future Louis IX. A virtuous and very devout Spanish princess, Blanche assumed the regency of the kingdom and the tutelage of her child, and carried them on for nine years with so much force of character and capacity for rule that she soon impressed the clamorous and disorderly leaders of the opposition (1226-1235). By the treaty of Meaux (1229), her diplomacy combined with the influence of the Church to prepare effectually for the annexation of Languedoc to the kingdom, supplementing this again by a portion of Champagne; and the marriage of her son to Margaret of Provence definitely broke the ties which held the country within the orbit of the German empire. She managed also to keep out of the great quarrel between Frederick II. and the papacy which was convulsing Germany. But her finest achievement was the education of her son; she taught him that lofty religious morality which in his case was not merely a rule for private conduct, but also a political programme to which he remained faithful even to the detriment of his apparent interests. With Louis IX. morality for the first time permeated and dominated politics; he had but one end: to do justice to every one and to reconcile all Christendom in view of a general crusade.

The oak of Vincennes, under which the king would sit to mete out justice, cast its shade over the whole political action of Louis IX. He was the arbiter of townspeople, of feudal lords and of kings. The interdiction of the judicial duel, the "quarantaine le roi," i.e. "the king's truce of forty days" during which no vengeance might be taken for private wrongs, and the *assurancement*,¹ went far to diminish the abuses of warfare by allowing his mediation to make for a spirit of reconciliation throughout his kingdom. When Thibaud (Theobald), count of Champagne, attempted to marry the daughter of Pierre Mauclerc, duke of Brittany, without the king's consent, Louis IX., who held the county of Champagne at his mercy, contented himself with exacting guarantees of peace. Beyond the borders of France, at the time of the emperor Frederick II.'s conflict with a papacy threatened in its temporal powers, though he made no response to Frederick's appeal to the civil authorities urging them to present a solid front against the pretensions of the Church, and though he energetically supported the latter, yet he would not admit her right to place kingdoms under interdict, and refused the imperial crown which Gregory IX. offered him for one of his brothers. He always hoped to bring about an honourable agreement between the two adversaries, and in his estimation

¹ The *assurancement* (*assecuratio*, *assecuramentum*) differed from the truce, which was a suspension of hostilities by mutual consent, in so far as it was a peace forced by judicial authority on one of the parties at the request of the other. The party desiring protection applied for the *assurancement*, either before or during hostilities, to any royal, seigniorial or communal judge, who thereupon cited the other party to appear and take an oath that he would assure the person, property and dependents of his adversary (*qu'il l'assurera, elle et les siens*). This custom, which became common in the 13th century, of course depended for its effectiveness on the degree of respect inspired in the feudal nobles by the courts. It was difficult, for instance, to refuse or to violate an *assurancement* imposed by a royal *bailli* or by the parlement itself. See A. Luchaire, *Manuel des institutions françaises* (Paris, 1892), p. 233.—(W. A. P.)

Louis VIII.
(1223-
1226).

Universal
French
activity.

Intel-
lectual
develop-
ment.

Louis IX.
(1226-
1270).

Blanche of
Castile.

Louis IX.'s
policy of
arbitra-
tion.

the advantages of peace outweighed personal interest. In matters concerning the succession in Flanders, Hainaut and Navarre; in the quarrels of the princes regarding the Empire, and in those of Henry III. of England with his barons; it was because of his justice and his disinterestedness that he was appealed to as a trusted mediator. His conduct towards Henry III. was certainly a most characteristic example of his behaviour.

The king of England had entered into the coalition formed by the nobility of Poitou and the count of Toulouse to prevent the execution of the treaty of 1229 and the enfeoffment of Poitou to the king's brother Alphonse. Louis IX. defeated Henry III. twice within two days, at Taillebourg and at Saintes, and obliged him to demand a truce (1242). It was forbidden that any lord should be a vassal both of the king of France and of the king of England. After this Louis IX. had set off upon his first crusade in Egypt (1248-54), and on his return he wanted to make this truce into a definite treaty and to "set love" between his children and those of the English king. By a treaty signed at Paris (1259), Henry III. renounced all the conquests of Philip Augustus, and Louis IX. those of his father Louis VIII.—an example unique in history of a victorious king spontaneously giving up his spoil solely for the sake of peace and justice, yet proving by his act that honesty is the best policy; for monarchy gained much by that moral authority which made Louis IX. the universal arbitrator.

But his love of peace and concord was not always "sans grands despens" to the kingdom. In 1258, by renouncing his rights over Roussillon and the countship of Barcelona, conquered by Charlemagne, he made an advantageous bargain because he kept Montpellier; but he committed a grave fault in consenting to accept the offers regarding Sicily made by Pope Urban IV. to his brother the count of Anjou and Provence. That was the origin of the expeditions into Italy on which the house of Valois was two centuries later to squander the resources of France unavailingly, compromising beyond the Alps its interests in the Low Countries and upon the Rhine. But Louis IX.'s worst error was his obsession with regard to the crusades, to which he sacrificed everything. Despite the signal failure of the first crusade, when he had been taken prisoner; despite the protests of his mother, of his counsellors, and of the pope himself, he flung himself into the mad adventure of Tunis. Nowhere was his blind faith more plainly shown, combined as it was with total ignorance of the formidable migrations that were convulsing Asia, and of the complicated game of politics just then proceeding between the Christian nations and the Moslems of the Mediterranean. At Tunis he found his death, on the 25th of August 1270.

The death of Louis IX. and that of his brother Alphonse of Poitiers, heir of the count of Toulouse, made Philip III., the Bold, legitimate master of northern France and undisputed sovereign of southern France. From the latter he detached the *comtat* Venaissin in 1274 and gave it to the papacy, which held it until 1791. But he had not his father's great soul nor disinterested spirit. Urged by Pope Martin IV. he began the fatal era of great international wars by his unlucky crusade against the king of Aragon, who, thanks to the massacre of the Sicilian Vespers, substituted his own predominance in Sicily for that of Charles of Anjou. Philip returned from Spain only to die at Perpignan, ending his insignificant reign as he had begun it, amid the sorrows of a disastrous retreat (1270-1285). His reign was but a halting-place of history between those of Louis IX. and Philip the Fair, just when the transition was taking place from the last days of the middle ages to the modern epoch.

The middle ages had been dominated by four great problems. The first of these had been to determine whether there should be a universal empire exercising tutelage over the nations; and if so, to whom this empire should belong, to pope or emperor. The second had been the extension to the East of that Catholic unity which reigned in the West. Again, for more than a century, the question had also been debated whether the English kings were

to preserve and increase their power over the soil of France. And, finally, two principles had been confronting one another in the internal life of all the European states: the feudal and the monarchical principles. France had not escaped any of these conflicts; but Philip the Fair was the initiator or the instrument (it is difficult to say which) who was to put an end to both imperial and theocratic dreams, and to the international crusades; who was to remove the political axis from the centre of Europe, much to the benefit of the western monarchies, now definitely emancipated from the feudal yoke and firmly organized against both the Church and the barons. The hour had come for Dante, the great Florentine poet, to curse the man who was to dismember the empire, precipitate the fall of the papacy and discipline feudalism.

Modern in his practical schemes and in his calculated purpose, Philip the Fair was still more so in his method, that of legal procedure, and in his agents, the lawyers. With him the French monarchy defined its ambitions, and little by little forsook its feudal and ecclesiastical character in order to clothe itself in juridical forms. His aggressive and litigious policy and his ruthless financial method were due to those lawyers of the south and of Normandy who had been nurtured on Roman law in the universities of Bologna or Montpellier, had practised chicanery in the provincial courts, had gradually thrust themselves into the great arena of politics, and were now leading the king and filling his parlement. It was no longer upon religion or morality, it was upon imperial and Roman rights that these *chevaliers ès lois* based the prince's omnipotence; and nothing more clearly marks the new tradition which was being elaborated than the fact that all the great events of Philip the Fair's reign were lawsuits.

The first of these was with the papacy. The famous quarrel between the priesthood and the Empire, which had culminated at Canossa under Gregory VII., in the apotheosis of the Lateran council under Innocent III., and again in the fall of the house of Hohenstaufen under Innocent IV., was reopened with the king of France by Boniface VIII. The quarrel began in 1294 about a question of money. In his bull *Clericis laicos* the pope protested against the taxes levied upon the French clergy by the king, whose expenses were increasing with his conquests. But he had not insisted; because Philip, between feudal vassals ruined by the crusades and lower classes fleeced by everybody, had threatened to forbid the exportation from France of any ecclesiastical gold and silver. In 1301 and 1302 the arrest of Bernard Saisset, bishop of Pamiers, by the officers of the king, and the citation of this cleric before the king's tribunal for the crime of *lèse-majesté*, revived the conflict and led Boniface to send an order to free Saisset, and to put forward a claim to reform the kingdom under the threat of excommunication. In view of the gravity of the occasion Philip made an unusually extended appeal to public opinion by convoking the states-general at Notre-Dame in Paris (1302). Whatever were their views as to the relations between ecclesiastical and secular jurisdiction, the French clergy, ruined by the dues levied by the papal court, ranged themselves on the national side with the nobility and the *bourgeoisie*; whereupon the king, with a bold stroke far ahead of his time, gave tit for tat. His chancellor, Nogaret, went to Anagni to seize the pope and drag him before a council; but Boniface died without confessing himself vanquished. As a matter of fact the king and his lawyers triumphed, where the house of Swabia had failed. After the death of Boniface the splendid fabric of the medieval theocracy gave place to the rights of civil society, the humiliation of Avignon, the disruption of the great schism, the vain efforts of the councils for reform, and the radical and heretical solutions of Wycliffe and Huss.

The affair of the Templars was another legal process carried out by the same Nogaret. Of course this military religious order had lost utility and justification when the Holy Land had been evacuated and the crusades were over. Their great mistake had lain in becoming rich, and rich to excess, through serving as bankers to princes, kings and popes; for great financial powers soon became

Louis IX.
and
Henry III.

The
crusade of
Tunis.

Philip III.,
the Bold
(1270-
1285).

Philip IV.
the Fair
(1285-
1314).

Litigious
character
of Philip
the Fair's
reign.

Philip the
Fair and
the
Papacy.

Philip the
Fair and
the
Templars.

unpopular. Philip took advantage of this hatred of the lower classes and the cowardice of his creature, Pope Clement V., to satisfy his desire for money. The trial of the order (1307-1313) was a remarkable example of the use of the religious tribunal of the Inquisition as a political instrument. There was a dramatic completeness about this unexpected result of the crusades. A general arbitrary arrest of the Templars, the sequestration of their property, examination under torture, the falsifying of procedure, extortion of money from the pope, the *auto-da-fé* of innocent victims, the dishonest pillaging of their goods by the joint action of the king and the pope: such was the outcome of this vast process of secularization, which foreshadowed the events of the 16th and 18th centuries.

External policy had the same litigious character. Philip the Fair instituted suits against his natural enemies, the king of England and the count of Flanders, foreign princes holding possessions within his kingdom; and against the emperor, whose ancient province of Lorraine and kingdom of Arles constantly changed hands between Germany and France. Philip began by interfering in the affairs of Sicily and Aragon, his father's inheritance; after which, on the pretext of a quarrel between French and English sailors, he set up his customary procedure: a citation of the king of England before the parlement of Paris, and in case of default a decree of forfeiture; the whole followed by execution—that is to say by the unimportant war of 1295. A truce arranged by Boniface VIII. restored Guienne to Edward I., gave him the hand of Philip's sister for himself and that of the king's daughter for his son (1298).

A still more lengthy and unfortunate suit was the attempt of Philip the Fair and his successors to incorporate the Flemish fief like the English one (1300-1326), thus coming into conflict with proud and turbulent republics composed of wool and cloth merchants, weavers, fullers and powerful counts. Guy de Dampierre, count of Namur, who had become count of Flanders on the death of his mother Margaret II. in 1279—an ambitious, greedy and avaricious man—was arrested at the Louvre on account of his attempt to marry his daughter to Edward I.'s eldest son without the consent of his suzerain Philip. Released after two years, he sided definitely with the king of England when the latter was in arms against Philip; and being only weakly supported by Edward, he was betrayed by the nobles who favoured France, and forced to yield up not only his personal liberty but the whole of Flanders (1300). The Flemings, however, soon wearying of the oppressive administration of the French governor, Jacques de Châtillon, and the recrudescence of patrician domination, rose and overwhelmed the French chivalry at Courtrai (1302)—a prelude to the coming disasters of the Hundred Years' War. Philip's double revenge, on sea at Zierikzee and on land at Mons-en-Pévèle (1304), led to the signing of a treaty at Athis-sur-Orge (1305).

The efforts of Philip the Fair to expand the limits of his kingdom on the eastern border were more fortunate. His marriage had gained him Champagne; and he afterwards extended his influence over Franche Comté, Bar and the bishoprics of Lorraine, acquiring also Viviers and the important town of Lyons—all this less by force of arms than by the expenditure of money. Disdaining the illusory dream of the imperial crown, still cherished by his legal advisers, he pushed forward towards that fluctuating eastern frontier, the line of least resistance, which would have yielded to him had it not been for the unfortunate interruption of the Hundred Years' War.

His three sons, Louis X., Philip V. the Tall, and Charles IV., continued his work. They increased the power of the monarchy politically by destroying the feudal reaction excited in 1314 by the tyrannical conduct of the jurists, like Enguerrand de Marigny, and by the increasing financial extortions of their father; and they also—notably Philip V., one of the most hard-working of the Capets—increased it on the administrative side by specializing the services

Philip the Fair and Edward I.

Philip the Fair and Flanders.

Eastern policy of Philip the Fair.

The sons of Philip the Fair (1314-1328).

of justice and of finance, which were separated from the king's council. Under these mute self-effacing kings the progress of royal power was only the more striking. With them the senior male line of the house of Capet became extinct.

During three centuries and a half they had effected great things: they had founded a kingdom, a royal family and civil institutions. The land subject to Hugh Capet in 987, barely representing two of the modern departments of France, in 1328 covered a space equal to fifty-nine of them. The political unity of the kingdom was only fettered by the existence of four large isolated fiefs: Flanders on the north, Brittany on the west, Burgundy on the east and Guienne on the south. The capital, which for long had been movable, was now established in the Louvre at Paris, fortified by Philip Augustus. Like the fiefs, feudal institutions at large had been shattered. The Roman tradition which made the will of the sovereign law, gradually propagated by the teaching of Roman law—the law of servitude, not of liberty—and already proclaimed by the jurist Philippe de Beaumanoir as superior to the customs, had been of immense support to the interest of the state and the views of the monarchs; and finally the Capets, so humble of origin, had created organs of general administration common to all in order to effect an administrative centralization. In their grand council and their domains they would have none but silent, servile and well-disciplined agents. The royal exchequer, which was being painfully elaborated in the *chambre des comptes*, and the treasury of the crown lands at the Louvre, together barely sufficed to meet the expenses of this more complicated and costly machinery. The uniform justice exercised by the parlement spread gradually over the whole kingdom by means of *cas royaux* (royal suits), and at the same time the royal coinage became obligatory. Against this exaltation of their power two adversaries might have been formidable; but one, the Church, was a captive in Babylon, and the second, the people, was deprived of the communal liberties which it had abused, or humbly effaced itself in the states-general behind the declared will of the king. This well-established authority was also supported by the revered memory of "Monseigneur Saint Louis"; and it is this prestige, the strength of this ideal superior to all other, that explains how the royal prerogative came to survive the mistakes and misfortunes of the Hundred Years' War.

On the extinction of the direct line of the Capets the crown passed to a younger branch, that of the Valois. Its seven representatives (1328-1498) were on the whole very inferior to the Capets, and, with the exception of Charles V. and Louis XI., possessed neither their political sense nor even their good common sense; they cost France the loss of her great advantage over all other countries. During this century and a half France passed through two very severe crises; under the first five Valois the Hundred Years' War imperilled the kingdom's independence; and under Louis XI. the struggle against the house of Burgundy endangered the territorial unity of the monarchy that had been established with such pains upon the ruins of feudalism.

Charles the Fair having died and left only a daughter, the nation's rights, so long in abeyance, were once more regained. An assembly of peers and barons, relying on two precedents under Philip V. and Charles IV., declared that "no woman, nor therefore her son, could in accordance with custom succeed to the monarchy of France." This definite decision, to which the name of the Salic law was given much later, set aside Edward III., king of England, grandson of Philip the Fair, nephew of the late kings and son of their sister Isabel. Instead it gave the crown to the feudal chief, the hard and coarse Philip VI. of Valois, nephew of Philip the Fair. This at once provoked war between the two monarchies, English and French, which, including periods of truce, lasted for a hundred and sixteen years. Of active warfare there were two periods, both disastrous to begin with, but ending favourably: one lasted from 1337 to 1378 and the other from 1413 to 1453, thirty-three years of distress and folly coming in between.

The royal house of Capet.

Advent of the Valois.

Philip VI. (1328-1350).

However, the Hundred Years' War was not mainly caused by the pretensions of Edward III. to the throne of the Capets; since after having long hesitated to do homage to Philip VI. for his possessions in Guienne, Edward at last brought himself to it—though certainly only after lengthy negotiations, and even threats of war in 1331. It is true that six years later he renounced his homage and again claimed the French inheritance; but this was on the ground of personal grievances, and for economic and political reasons. There was a natural rivalry between Edward III. and Philip VI., both of them young, fond of the life of chivalry, festal magnificence, and the "belles apertises d'armes." This rivalry was aggravated by the enmity between Philip VI. and Robert of Artois, his brother-in-law, who, after having warmly supported the disinheriting of Edward III., had been convicted of deceit in a question of succession, had revenged himself on Philip by burning his waxen effigy, and had been welcomed with open arms at Edward's court. Philip VI. had taken reprisals against him in 1336 by making his parlement declare the forfeiture of Edward's lands and castles in Guienne; but the Hundred Years' War, at first simply a feudal quarrel between vassal and suzerain, soon became a great national conflict, in consequence of what was occurring in Flanders.

The communes of Flanders, rich, hard-working, jealous of their liberties, had always been restive under the authority of their counts and the influence of their suzerain, the king of France. The affair at Cassel, where Philip VI. had avenged the injuries done by the people of Bruges in 1325 to their count, Louis of Nevers, had also compromised English interests. To attack the English through their colonies, Guienne and Flanders, was to injure them in their most vital interests—cloth and claret; for England sold her wool to Bruges in order to pay Bordeaux for her wine. Edward III. had replied by forbidding the exportation of English wool, and by threatening the great industrial cities of Flanders with the transference to England of the cloth manufacture—an excellent means of stirring them up against the French, as without wool they could do nothing. Workless, and in desperation, they threw themselves on Edward's mercy, by the advice of a rich citizen of Ghent, Jacob van Artevelde (*q.v.*); and their last scruples of loyalty gave way when Edward decided to follow the counsels of Robert of Artois and of Artevelde, and to claim the crown of France.

The war began, like every feudal war of that day, with a solemn defiance, and it was soon characterized by terrible disasters. The destruction of the finest French fleet that had yet been seen, surprised in the port of Sluys, closed the sea to the king of France; the struggle was continued on land, but with little result.

Flanders tired of it, but fortunately for Edward III. Brittany now took fire, through a quarrel of succession, analogous to that in France, between Charles of Blois (who had married the daughter of the late duke and was a nephew of Philip VI., by whom he was supported) and John of Montfort, brother of the old duke, who naturally asked assistance from the king of England. But here, too, nothing important was accomplished; the capture of John of Montfort at Nantes deprived Edward of Brittany at the very moment when he finally lost Flanders by the death of Artevelde, who was killed by the people of Ghent in 1345. Under the influence of Godefroi d'Harcourt, whom Philip VI. had wished to destroy on account of his ambitions with regard to the duchy of Normandy, Edward III. now invaded central France, ravaged Normandy, getting as near to Paris as Saint-Germain; and profiting by Philip VI.'s hesitation and delay, he reached the north with his spoils by dint of forced marches. Having been pursued and encountered at

Crécy, Edward gained a complete victory there on the 26th of April 1346. The seizure of Calais in 1347, despite heroic resistance, gave the English a port where they could always find entry into France, just when the queen of England had beaten David of Scotland, the ally of France, at Neville's Cross, and when Charles of Blois, made prisoner in his turn, was held captive

in London. The Black Death put the finishing touch to the military disasters and financial upheavals of this unlucky reign; though before his death in 1350 Philip VI. was fortunate enough to augment his territorial acquisitions by the purchase of the rich port of Montpellier, as well as by that of Dauphiné, which extended to the Alpine frontier, and was to become the appanage of the eldest son of the king of France (see DAUPHINÉ and DAUPHIN).

Philip VI.'s successor was his son John the Good—or rather, the stupid and the spendthrift. This noble monarch was unspeakably brutal (as witness the murders, simply on suspicion, of the constable Raoul de Brienne, count of Eu, and of the count of Harcourt) and incredibly extravagant. His need of money led him to debase the currency eighty-one times between 1350 and 1355. And this money, so necessary for the prosecution of the war with England, which had been interrupted for a year, thanks to the pope's intervention, was lavished by him upon his favourite, Charles of La Cerda. The latter was murdered in 1354 by order of Charles of Navarre, the king's son-in-law, who also prevented the levying of the taxes voted by the states in 1355 with the object of replenishing the treasury. The Black Prince took this opportunity to ravage the southern provinces, and then marched to join the duke of Lancaster and Charles of Navarre in Normandy. John the Good managed to bring the English army to bay at Maupertuis, not far from Poitiers; but the battle was conducted with such a want of intelligence on his part that the French army was overwhelmed, though very superior in numbers, and King John was made prisoner, after a determined resistance, on the 19th of September 1356.

The disaster at Poitiers almost led to the establishment in France of institutions analogous to those which England owed to Bouvines. The king a prisoner, the dauphin discredited and deserted, and the nobility decimated, the people—that is to say, the states-general—could raise their voice. Philip the Fair had never regarded the states-general as a financial institution, but merely as a moral support. Now, however, in order to obtain substantial help from taxes instead of mere dribbles, the Valois needed a stronger lever than cunning or force. War against the English assured them the support of the nation. Exactions, debasement of the currency and extortionate taxation were ruinous palliatives, and insufficient to supply a treasury which the revenue from crown lands and various rights taken from the nobles could not fill even in times of peace. By the 14th century the motto "*N'impose qui ne veut*" (*i.e.* no taxation without consent) was as firmly established in France as in England. After Crécy Philip VI. called the states together regularly, that he might obtain subsidies from them, as an assistance, an "aid" which subjects could not refuse their suzerain. In return for this favour, which the king could not claim as a right, the states, favouring their power, began to bargain, and at the session of November 1355 demanded the participation of all classes in the tax voted, and obtained guarantees both for its levy and the use to be made of it. A similar situation in England had given birth to political liberty; but in France the great crisis of the early 15th century stifled it. It was with this money that John the Good got himself beaten and taken prisoner at Poitiers. Once more the states-general had to be convoked. Confronted by a pale weakly boy like the dauphin Charles and the remnants of the discredited council, the situation of the states was stronger than ever. Predominant in influence were the deputies from the towns, and above all the citizens of the capital, led by Robert le Coq, bishop of Laon, and Étienne Marcel, provost of the merchants of Paris.

Having no cause for confidence in the royal administration, the states refused to treat with the dauphin's councillors, and proposed to take him under their own tutelage. He himself hesitated whether to sacrifice the royal authority, or else, without resources or support, to resist an assembly backed by public opinion. He decided for resistance. Under pretext of

John the Good (1350).

Defeat at Poitiers.

The states of 1355-1356.

Robert le Coq and Étienne Marcel.

grave news received from his father, and of an interview at Metz with his uncle, the emperor Charles IV., he begged the states to adjourn till the 3rd of November 1356. This was a political *coup d'état*, and when the time had expired he attempted a financial *coup d'état* by debasing the currency. An uprising obliged him to call the states-general together again in February 1357, when they transformed themselves into a deliberative, independent and permanent assembly by means of the *Grande Ordonnance*.

In order to make this great French charter really effective resistance to the royal authority should have been collective, national and even popular, as in the case of the charters of 1215 and 1258 in England. But the lay and ecclesiastical feudal lords continued to show themselves in France, as everywhere else except across the Straits of Dover, a cause of division and oppression. Moreover, the states were never really general; those of the Langue d'oc and the Langue d'oïl sometimes acted together; but there was never a common understanding between them and always two Frances within the kingdom. Besides, they only represented the three classes who alone had any social standing at that period: the nobles, the clergy, and the burghesses of important towns. Étienne Marcel himself protested against councillors "*de petit état*." Again, the states, intermittently convoked according to the king's good pleasure, exercised neither periodical rights nor effective control, but fulfilled a duty which was soon felt as onerous. Indifference and satiety spread speedily; the bourgeoisie forsook the reformers directly they had recourse to violence (February 1358), and the Parisians became hostile when Étienne Marcel complicated his revolutionary work by intrigues with Navarre, releasing from prison the grandson of Louis X., the Headstrong, an ambitious, fine-spoken courtier of popularity, covetous of the royal crown. The dauphin's flight from Paris excited a wild outburst of monarchist loyalty and anger against the capital among the nobility and in the states-general of Compiègne. Marcel, like the dauphin, was not a man to turn back. But neither the support of the peasant insurgents—the "Jacques"—who were annihilated in the market of Meaux, nor a last but unheeded appeal to the large towns, nor yet the uncertain support of Charles the Bad, to whom Marcel in despair proposed to deliver up Paris, saved him from being put to death by the royalist party of Paris on the 31st of July 1358.

Isolated as he was, Étienne Marcel had been unable either to seize the government or to create a fresh one. In the reaction which followed his downfall royalty inherited the financial administration which the states had set up to check extravagance. The "*élus*" and the superintendents, instead of being delegates of the states, became royal functionaries like the *baillis* and the provosts; imposts, hearth-money (*fouage*), salt-tax (*gabelle*), sale-dues (*droits de vente*), voted for the war, were levied during the whole of Charles V.'s reign and added to his personal revenue. The opportunity of founding political liberty upon the vote and the control of taxation, and of organizing the administration of the kingdom so as to ensure that the entire military and financial resources should be always available, was gone beyond recall.

Re-establishing the royal authority in Paris was not enough; an end had to be put to the war with England and Navarre, and this was effected by the treaty of Brétigny (1360). King John ceded Poitou, Saintonge, Agenais, Périgord and Limousin to Edward III., and was offered his liberty for a ransom of three million gold crowns; but, unable to pay that enormous sum, he returned to his agreeable captivity in London, where he died in 1364.

Yet through the obstinacy and selfishness of John the Good, France, in stress of suffering, was gradually realizing herself.

More strongly than her king she felt the shame of defeat. Local or municipal patriotism waxed among peasants and townfolk, and combined with hatred of the English to develop national sentiment. Many of the conquered repeated that proud, sad answer of the men

of Rochelle to the English: "We will acknowledge you with our lips; but with our hearts, never!"

The peace of Brétigny brought no repose to the kingdom. War having become a congenial and very lucrative industry, its cessation caused want of work, with all the evils that entails. For ten years the remnants of the armies of England, Navarre and Brittany—the "*Grandes Compagnies*," as they were called—ravaged the country; although Charles V., "*durement subtil et sage*," succeeded in getting rid of them, thanks to du Guesclin, one of their chiefs, who led them to any place where fighting was going on—to Brittany, Alsace, Spain. Charles also had all towns and large villages fortified; and being a man of affairs he set about undoing the effect of the treaty of Brétigny by alliances with Flanders, whose heiress he married to his brother Philip, duke of Burgundy; with Henry, king of Castile, and Ferdinand of Portugal, who possessed fine navies; and, finally, with the emperor Charles IV. Financial and military preparations were made no less seriously when the harsh administration of the Black Prince, to whom Edward III. had given Guienne in fief, provoked the nobles of Gascony to complain to Charles V. Cited before the court of Paris, the Black Prince refused to attend, and war broke out in Gascony, Poitou and Normandy, but with fresh tactics (1369). Whilst the English adhered to the system of wide circuits, under Chandos or Robert Knolles, Charles V. limited himself to defending the towns and exhausting the enemy without taking dangerous risks. Thanks to the prudent constable du Guesclin, sitting quietly at home he reconquered bit by bit what his predecessors had lost upon the battlefield, helm on head and sword in hand; and when he died in 1380, after the decease of both Edward III. and the Black Prince, the only possessions of England in a liberated but ruined France were Bayonne, Bordeaux, Brest, Cherbourg and Calais.

The death of Charles V. and dynastic revolutions in England stopped the war for thirty-five years. Then began an era of internal disorder and misery. The men of that period, coarse, violent and simple-minded, with few political ideas, loved brutal and noisy pleasures—witness the incredible festivities at the marriage of Charles VI., and the assassinations of the constable de Clisson, the duke of Orleans and John the Fearless. It would have needed an energetic hand to hold these passions in check; and Charles VI. was a gentle-natured child, twelve years of age, who attained his majority only to fall into a second childhood. Thence arose a question which remained without reply during the whole of his reign. Who should have possession of the royal person, and, consequently, of the royal power? Should it be the uncles of the king, or his followers Clisson and Bureau de la Rivière, whom the nobles called in mockery the *Marmousets*? His uncles first seized the government, each with a view to his own particular interests, which were by no means those of the kingdom at large. The duke of Anjou emptied the treasury in conquering the kingdom of Naples, at the call of Queen Joanna of Sicily. The duke of Berry seized upon Languedoc and the wine-tax. The duke of Burgundy, heir through his wife to the countship of Flanders, wanted to crush the democratic risings among the Flemings. Each of them needed money, but Charles V., pricked by conscience on his death-bed, forbade the levying of the hearth-tax (1380). His brother's attempt to re-establish it set Paris in revolt. The *Maillotins* of Paris found imitators in other great towns; and in Auvergne and Vivarais the *Tuchins* renewed the Jacquerie. Revolutionary attempts between 1380 and 1385 to abolish all taxes were echoed in England, Florence and Flanders. These isolated rebellions, however, were crushed by the ever-ready coalition of royal and feudal forces at Roosebeke (1382). Taxes and subsidies were maintained and the hearth-money re-established.

The death of the duke of Anjou at Bari (1384) gave preponderant influence to Philip the Bold, duke of Burgundy, who increased the large and fruitless expenses of his Burgundian

The Grande Ordonnance of 1357.

The "Grandes Compagnies."

Charles VI. (1380-1422).

The king's uncles and the Marmousets.

The treaty of Brétigny.

The revolt of the Maillotins.

Charles V. (1364-1380).

policy to such a point that on the return of a last unfortunate expedition into Gelderland Charles VI., who had been made by him to marry Isabel of Bavaria, took the government from his uncles on the 3rd of May 1389, and recalled the *Marmousets*. But this young king, aged only twenty, very much in love with his young wife and excessively fond of pleasure, soon wrecked the delicate poise of his mental faculties in the festivities of the Hôtel Saint-Paul; and a violent attack of Pierre de Craon on the constable de Clisson having led to an expedition against his accomplice, the duke of Brittany, Charles was seized by insanity on the road. The *Marmousets* were deposed, the king's brother, the duke of Orleans, set aside, and the old condition of affairs began again (1392).

The struggle was now between the two branches of the royal family, the Orleanist and the Burgundian, between the aristocratic south and the democratic north; while the deposition of Richard II. of England in favour of Henry of Lancaster permitted them to vary civil war by war against the foreigner. Philip the Bold, duke of Burgundy, the king's uncle, had certain advantages over his rival Louis of Orleans, Charles VI.'s brother: superiority in age, relations with the Lancastrians and with Germany, and territorial wealth and power. The two adversaries had each the same scheme of government: each wanted to take charge of Charles VI., who was intermittently insane, and to exclude his rival from the pillage of the royal exchequer; but this rivalry of desires brought them into opposition on all the great questions of the day—the war with England, the Great Schism and the imperial election. The struggle became acute when John the Fearless of Burgundy succeeded his father in 1404. Up to this time the queen, Isabel of Bavaria, had been held in a kind of dependency upon Philip of Burgundy, who had brought about her marriage; but less eager for influence than for money, since political questions were unintelligible to her and her situation was a precarious one, she suddenly became favourable to the duke of Orleans. Whether due to passion or caprice this cost the duke his life, for John the Fearless had him assassinated in 1407, and thus let loose against one another the Burgundians and the Armagnacs, so-called because the son of the murdered duke was the son-in-law of the count of Armagnac (see ARMAGNAC). Despite all attempts at reconciliation the country was divided into two parties. Paris, with her tradesmen—the butchers in particular—and her university, played an important part in this quarrel; for to be master of Paris was to be master of the king. In 1413 the duke of Burgundy gained the upper hand there, partly owing to the rising of the *Cabochiens*, i.e. the butchers led by the skinner Simon Caboche, partly to the hostility of the university to the Avignon pope and partly to the Parisian bourgeoisie.

Amid this reign of terror and of revolt the university, the only moral and intellectual force, taking the place of the impotent states-general and of a parlement carefully restricted to the judiciary sphere, vainly tried to re-establish a firm monarchical system by means of the *Ordonnance Cabochienne*; but this had no effect, the government being now at the mercy of the mob, themselves at the mercy of incapable hot-headed leaders. The struggle ended in becoming one between factions of the townsmen, led respectively by the *hûchier* Cirasse and by Jean Caboche. The former overwhelmed John the Fearless, who fled from Paris; and the Armagnacs, re-entering on his exit, substituted white terror for red terror, from the 12th of December 1413 to the 28th of July 1414. The butchers' organization was suppressed and all hope of reform lost. Such disorders allowed Henry V. of England to take the offensive again.

The Armagnacs were in possession of Paris and the king when Henry V. crushed them at Agincourt on the 25th of October 1415. It was as at Crécy and Poitiers; the French chivalry, accustomed to mere playing at battle in the tournaments, no longer knew how to fight. Charles of Orleans being a captive and his father-in-law, the count of

Armagnac, highly unpopular, John the Fearless, hitherto prudently neutral, re-entered Paris, amid scenes of carnage, on the invitation of the citizen Perrinet le Clerc.

Secure from interference, Henry V. had occupied the whole of Normandy and destroyed in two years the work of Philip Augustus. The duke of Burgundy, feeling as incapable of coming to an understanding with the masterful Englishman as of resisting him unaided, tried to effect a reconciliation with the Armagnacs, who had with them the heir to the throne, the dauphin Charles; but his assassination at Montreuil in 1419 nearly caused the destruction of the kingdom, the whole Burgundian party going over to the side of the English. By the treaty of Troyes (1420) the son of John the Fearless, Philip the Good, in order to avenge his father recognized Henry V. (now married to Catherine, Charles VI.'s daughter) as heir to the crown of France, to the detriment of the dauphin Charles, who was disavowed by his mother and called in derision "the soi-disant dauphin of Viennois." When Henry V. and Charles VI. died in 1422, Henry VI.—son of Henry V. and Catherine—was proclaimed at Paris king of France and of England, with the concurrence of Philip the Good, duke of Burgundy. Thus in 1428 the English occupied all eastern and northern France, as far as the Loire; while the two most important civil powers of the time, the parlement and the university of Paris, had acknowledged the English king.

But the cause of greatest weakness to the French party was still Charles VII. himself, the king of Bourges. This youth of nineteen, the ill-omened son of a madman and of a Bavarian of loose morals, was a symbol of France, timorous and mistrustful. The châteaux of the Loire, where he led a restless and enervating existence, held an atmosphere little favourable to enthusiasm and energy. After his victories at Cravant (1423) and Verneuil (1424), the duke of Bedford, appointed regent of the kingdom, had given Charles VII. four years' respite, and these had been occupied in violent intrigues between the constable de Richemont¹ and the sire de la Trémoille, the young king's favourites, and solely desirous of enriching themselves at his expense. The king, melancholy spectacle as he was, seemed indeed to suit that tragic hour when Orleans, the last bulwark of the south, was besieged by the earl of Salisbury, now roused from inactivity (1428). He had neither taste nor capacity like Philip VI. or John the Good for undertaking "belles apertises d'armes"; but then a lack of chivalry combined with a temporizing policy had not been particularly unsuccessful in the case of his grandfather Charles V.

Powerful aid now came from an unexpected quarter. The war had been long and cruel, and each successive year naturally increased feeling against the English. The damage done to Burgundian interests by the harsh yet impotent government of Bedford, disgust at the iniquitous treaty of Troyes, the monarchist loyalty of many of the warriors, the still deeper sentiment felt by men like Alain Chartier towards "Dame France," and the "great misery that there was in the kingdom of France"; all these suddenly became incarnate in the person of Joan of Arc, a young peasant of Domrémy in Lorraine. Determined in her faith and proud in her meekness, in opposition to the timid counsels of the military leaders, to the interested delays of the courtiers, to the scruples of the experts and the quarrelling of the doctors, she quoted her "voices," who had, she said, commissioned her to raise the siege of Orleans and to conduct the gentle dauphin to Reims, there to be crowned. Her sublime folly turned out to be wiser than their wisdom; in two months, from May to July 1429, she had freed Orleans, destroyed the prestige of the English army at Patay, and dragged the doubting and passive king against his will to be crowned at Reims. All this produced a marvellous revulsion of political feeling throughout France, Charles VII. now becoming incontestably "him to whom the kingdom of France ought to belong." After Reims Joan's first thought was for Paris, and to achieve the final overthrow

¹ Earl of Richmond; afterwards Arthur, duke of Brittany (q.v.).

Madness of Charles VI.

Struggle between the Armagnacs and the Burgundians.

The treaty of Troyes, 1420.

Charles VII. (1422-1461).

Joan of Arc.

of the English; while Charles VII. was already sighing for the easy life of Touraine, and recurring to that policy of truce which was so strongly urged by his counsellors, and so keenly irritating to the clear-sighted Joan of Arc. A check before Paris allowed the jealousy of La Trémoille to waste the heroine for eight months on operations of secondary importance, until the day when she was captured by the Burgundians under the walls of Compiègne, and sold by them to the English. The latter incontinently prosecuted her as a heretic; they had, indeed, a great interest in seeing her condemned by the Church, which would render her conquests sacrilegious. After a scandalous four months' duel between this simple innocent girl and a tribunal of crafty malevolent ecclesiastics and doctors of the university of Paris, Joan was burned alive in the old market-place of Rouen, on the 30th of May 1431 (see JOAN OF ARC).

On Charles VII.'s part this meant oblivion and silence until the day when in 1450, more for his own sake than for hers, he caused her memory to be rehabilitated; but Joan had given the country new life and heart. From 1431 to 1454 the struggle against the English went on energetically; and the king, relieved in 1433 of his evil genius, La Trémoille, then became a man once more, playing a kingly part under the guidance of Dunois, Richemont, La Hire and Saintrailles, leaders of worth on the field of battle. Moreover, the English territory, a great triangle, with the Channel for base and Paris for apex, was not a really solid position. Yet the war seemed interminable; until at last Philip of Burgundy, for long embarrassed by his English alliance, decided in 1435 to become reconciled with Charles VII. This was in consequence of the death of his sister, who had been married to Bedford, and the return of his brother-in-law Richemont into the French king's favour. The treaty of Arras, which made him a sovereign prince for life, though harsh, at all events gave a united France the opportunity of expelling the English from the east, and allowed the king to re-enter Paris in 1436. From 1436 to 1439 there was a terrible repetition of what happened after the Peace of Brétigny; famine, pestilence, extortions and, later, the aristocratic revolt of the Praguerie, completed the ruin of the country. But thanks to the permanent tax of the *taille* during this time of truce Charles VII. was able to effect the great military reform of the Compagnies d'Ordonnance, of the Franks-Archers, and of the artillery of the brothers Bureau. From this time forward the English, ruined, demoralized and weakened both by the death of the duke of Bedford and the beginnings of the Wars of the Roses, continued to lose territory on every recurrence of conflict. Normandy was lost to them at Formigny (1450), and Guienne, English since the 12th century, at Castillon (1453). They kept only Calais; and now it was their turn to have a madman, Henry VI., for king.

France issued from the Hundred Years' War victorious, but terribly ruined and depopulated. It is true she had definitely freed her territory from the stranger, and through the sorrows of defeat and the menace of disruption had fortified her national solidarity, and defined her patriotism, still involved in and not yet dissociated from loyalty to the monarchy. A happy awakening, although it went too far in establishing royal absolutism; and a victory too complete, in that it enervated all the forces of resistance. The nation, worn out by the long disorders consequent on the captivity of King John and the insanity of Charles VI., abandoned itself to the joys of peace. Preferring the solid advantage of orderly life to an unstable liberty, it acquiesced in the abdication of 1439, when the States consented to taxation for the support of a permanent army without any periodical renewal of their authorization. No doubt by the prohibition to levy the smallest *taille* the feudal lords escaped direct taxation; but from the day when the privileged classes selfishly allowed the taxing of the third estate, provided that they themselves were exempt, they opened the door to monarchic absolutism. The principle of autocracy triumphed everywhere over the remnants of local or provincial authority, in the sphere of industry as in that of administration;

while the gild system became much more rigid. A loyal bureaucracy, far more powerful than the phantom administration of Bourges or of Poitiers, gradually took the place of the court nobility; and thanks to this the institutions of control which the war had called into power—the provincial states-general—were nipped in the bud, withered by the people's poverty of political idea and by the blind worship of royalty. Without the nation's concurrence the king's creatures were now to endow royalty with all the organs necessary for the exertion of authority; by which imprudent compliance, and above all thanks to Jacques Cœur (*q.v.*), the financial independence of the provinces disappeared little by little, and all the public revenues were left at the discretion of the king alone (1436-1440). By this means, too, and chiefly owing to the constable de Richemont and the brothers Bureau, the first permanent royal army was established (1445).

Henceforward royalty, strengthened by victory and organized for the struggle, was able to reduce the centrifugal social forces to impotence. The parlement of Paris saw its monopoly encroached upon by the court of Toulouse in 1443, and by the parlement of Grenoble in 1453. The university of Paris, compromised with the English, like the parlement, witnessed the institution and growth of privileged provincial universities. The Church of France was isolated from the papacy by the Pragmatic Sanction of Bourges (1438) only to be exploited and enslaved by royalty. Monarchic centralization, interrupted for the moment by the war, took up with fresh vigour its attacks upon urban liberties, especially in the always more independent south. It caused a slackening of that spirit of communal initiative which had awakened in the midst of unprecedented disasters. The decimated and impoverished nobility proved their impotence in the coalitions they attempted between 1437 and 1442, of which the most important, the Praguerie, fell to pieces almost directly, despite the support of the dauphin himself.

The life of society, now alarmingly unstable and ruthlessly cruel, was symbolized by the *danse macabre* painted on the walls of the cemeteries; the sombre and tragic art of the 15th century, having lost the fine balance shown by that of the 13th, gave expression in its mournful realism to the general state of exhaustion. The favourite subject of the mysteries and of other artistic manifestations was no longer the triumphant Christ of the middle ages, nor the smiling and teaching Christ of the 13th century, but the Man of sorrows and of death, the naked bleeding Jesus, lying on the knees of his mother or crowned with thorns. France, like the Christ, had known all the bitterness and weakness of a Passion.

The war of independence over, after a century of fatigue, regrets and doubts, royalty and the nation, now more united and more certain of each other, resumed the methodic and utilitarian war of widening boundaries. Leaving dreams about crusades to the poets, and to a papacy delivered from schism, Charles VII. turned his attention to the ancient appanage of Lothair, Alsace and Lorraine, those lands of the north and the east whose frontiers were constantly changing, and which seemed to invite aggression. But the chance of annexing them without great trouble was lost; by the fatal custom of appanages the Valois had set up again those feudal institutions which the Capets had found such difficulty in destroying, and Louis XI. was to make sad experience of this.

To the north and east of the kingdom extended a wide territory of uncertain limits; countries without a chief like Alsace; principalities like Lorraine, ecclesiastical lordships like the bishopric of Liège; and, most important of all, a royal appanage, that of the duchy of Burgundy, which dated back to the time of John the Good. Through marriages, conquests and inheritance, the dukes of Burgundy had enormously increased their influence; while during the Hundred Years' War they had benefited alternately by their criminal alliance with the English and by their self-interested reconciliation with their sovereign. They soon

Monarchic centralization.

Social life.

Consequences of the Hundred Years' War.

The House of Burgundy.

appeared the most formidable among the new feudal chiefs so imprudently called into being by Louis XI.'s predecessors. Fleeing from the paternal wrath which he had drawn down upon himself by his ambition and by his unauthorized marriage with Charlotte of Savoy, the future Louis XI. had passed five years of voluntary exile at the court of the chief of the House of Burgundy, Philip the Good; and he was able to appreciate the territorial power of a duchy which extended from the Zuyder Zee to the Somme, with all the country between the Saône and the Loire in addition, and its geographical position as a commercial intermediary between Germany, England and France. He had traversed the fertile country of Flanders; he had visited the rich commercial and industrial republics of Bruges and Ghent, which had escaped the disasters of the Hundred Years' War; and, finally, he had enjoyed a hospitality as princely as it was self-interested at Brussels and at Dijon, the two capitals, where he had seen the brilliancy of a court unique in Europe for the ideal of chivalric life it offered.

But the dauphin Louis, although a bad son and impatient for the crown, was not dazzled by all this. With very simple tastes, an inquiring mind, and an imagination always at work, he combined a certain easy good-nature which inspired confidence, and though stingy in spending money on himself, he could be lavish in buying men either dangerous or likely to be useful. More inclined to the subtleties of diplomacy than to the risks of battle, he had recognized and speedily grasped the disadvantages of warfare. The duke of Burgundy, however rich and powerful, was still the king's vassal; his wide but insecure authority, of too rapid growth and unpopular, lacked sovereign rights. Hardly, therefore, had Louis XI. heard of his father's death than he made his host aware of his perfectly independent spirit, and his very definite intention to be master in his own house.

But by a kind of poetic justice, Louis XI. had for seven years, from 1465 to 1472, to struggle against fresh Pragueries, called *The Leagues of the Public Weal* (presumably from their disregard of it), composed of the most powerful French nobles, to whom he had set the example of revolt. His first proceedings had indeed given no promise of the moderation and prudence afterwards to characterize him; he had succeeded in exasperating all parties; the officials of his father, "the well-served," whom he dismissed in favour of inferiors like Jean Balue, Oliver le Daim and Tristan Lermite; the clergy, by abrogating the Pragmatic Sanction; the university of Paris, by his ill-treatment of it; and the nobles, whom he deprived of their hunting rights, among them being those whom Charles VII. had been most careful to conciliate in view of the inevitable conflict with the duke of Burgundy—in particular, Francis II., duke of Brittany. The repurchase in 1463 of the towns of the Somme (to which Philip the Good, now grown old and engaged in a quarrel with his son, the count of Charolais, had felt obliged to consent on consideration of receiving four hundred thousand gold crowns), and the intrigues of Louis XI. during the periodical revolts of the Liégois against their prince-bishop, set the powder alight. On three different occasions (in 1465, 1467 and 1472), Louis XI.'s own brother, the duke of Berry, urged by the duke of Brittany, the count of Charolais, the duke of Bourbon, and the other feudal lords, attempted to set up six kingdoms in France instead of one, and to impose upon Louis XI. a regency which should give them enormous pensions. This was their idea of Public Weal.

Louis XI. won by his favourite method, diplomacy rather than arms. At the time of the first league, the battle of Monthéry (16th of July 1465) having remained undecided between the two equally badly organized armies, Louis XI. conceded everything in the treaties of Conflans and Saint-Maur—promises costing him little, since he had no intention of keeping them. But during the course of the second league, provoked by the recapture of Normandy, which he had promised to his brother in exchange for Berry, he was nearly caught in his own trap. On the 15th of June 1467 Philip the Good died, and the accession of the count of

Charolais was received with popular risings. In order to embarrass him Louis XI. had secretly encouraged the people of Liège to revolt; but preoccupied with the marriage of Charles the Bold with Margaret of York, sister of Edward IV. of England, he wished to negotiate personally with him at Péronne, and hardly had he reached that place when news arrived there of the revolt of Liège amid cries of "Vive France." Charles the Bold, proud, violent, pugnacious, as treacherous as his rival, a hardier soldier, though without his political sagacity, imprisoned Louis in the tower where Charles the Simple had died as a prisoner of the count of Vermandois. He only let him depart when he had sworn in the treaty of Péronne to fulfil the engagements made at Conflans and Saint-Maur to assist in person at the subjugation of rebellious Liège, and to give Champagne as an appanage to his ally the duke of Berry.

Louis XI., supported by the assembly of notables at Tours (1470), had no intention of keeping this last promise, since the duchy of Champagne would have made a bridge between Burgundy and Flanders—the two isolated branches of the house of Burgundy. He gave the duke of Berry distant Guienne. But death eventually rid him of the duke in 1472, just when a third league was being organized, the object of which was to make the duke of Berry king with the help of Edward IV., king of England. The duke of Brittany, Francis II., was defeated; Charles the Bold, having failed at Beauvais in his attempt to recapture the towns of the Somme which had been promised him by the treaty of Conflans, was obliged to sign the peace of Senlis (1472). This was the end of the great feudal coalitions, for royal vengeance soon settled the account of the lesser vassals; the duke of Alençon was condemned to prison for life; the count of Armagnac was killed; and "the Germans" were soon to disembarass Louis of Charles the Bold.

Charles had indeed only signed the peace so promptly because he was looking eastward towards that royal crown and territorial cohesion of which his father had also dreamed. The king, he said of Louis XI., is always ready. He wanted to provide his future sovereignty with organs analogous to those of France; a permanent army, and a judiciary and financial administration modelled on the French parlement and exchequer. Since he could not dismember the kingdom of France, his only course was to reconstitute the ancient kingdom of Lotharingia; while the conquest of the principality of Liège and of the duchy of Gelderland, and the temporary occupation of Alsace, pledged to him by Sigismund of Austria, made him greedy for Germany. To get himself elected king of the Romans he offered his daughter Mary, his eternal candidate for marriage, to the emperor Frederick III. for his son. Thus either he or his son-in-law Maximilian would have been emperor.

But the Tarpeian rock was a near neighbour of the Capitol. Frederick—distrustful, and in the pay of Louis XI.—evaded a meeting arranged at Trier, and Burgundian influence in Alsace was suddenly brought to a violent end by the putting to death of its tyrannical agent, Peter von Hagenbach. Charles thought to repair the rebuff of Trier at Cologne, and wasted his resources in an attempt to win over its elector by besieging the insignificant town of Neuss. But the "universal spider"—as he called Louis XI.—was weaving his web in the darkness, and was eventually to entangle him in it. First came the reconciliation, in his despite, of those irreconcilables, the Swiss and Sigismund of Austria; and then the union of both with the duke of Lorraine, who was also disturbed at the duke of Burgundy's ambition. In vain Charles tried to kindle anew the embers of former feudal intrigues; the execution of the duke of Nemours and the count of Saint Pol cooled all enthusiasm. In vain did he get his dilatory friends, the English Yorkists, to cross the Channel; on the 20th of August 1475, at Picquigny, Louis XI. bribed them with a sum of seventy-five thousand crowns to forsake him, Edward further undertaking to guarantee the loyalty of the duke of Brittany. Exasperated, Charles attacked and took Nancy,

The interview at Péronne.

Ruin of the feudal coalitions.

Charles the Bold's imperial dreams.

Fall of Charles the Bold.

Louis XI. (1461-1483).

The Leagues of the Public Weal.

Charles the Bold.

wishing, as he said, "to skin the Bernese bear and wear its fur." To the hanging of the brave garrison of Granson the Swiss responded by terrible reprisals at Granson and at Morat (March to June 1476); while the people of Lorraine finally routed Charles at Nancy on the 5th of January 1477, the duke himself falling in the battle.

The central administration of Burgundy soon disappeared, swamped by the resurgence of ancient local liberties; the army fell to pieces; and all hope of joining the two limbs of the great eastern duchy was definitely lost. As for the remnants that were left, French provinces and imperial territory, Louis XI. claimed the whole. He seized everything, alleging different rights in each place; but he displayed such violent haste and such trickery that he threw the heiress of Burgundy, in despair, into the arms of Maximilian of Austria. At the treaty of Arras (December 1482) Louis XI. received only Picardy, the Boulonnais and Burgundy; by the marriage of Charles the Bold's daughter the rest was annexed to the Empire, and later to Spain. Thus by Louis XI.'s short-sighted error the house of Austria established itself in the Low Countries. An age-long rivalry between the houses of France and Austria was the result of this disastrous marriage; and as the son who was its issue espoused the heiress of a now unified Spain, France, hemmed in by the Spaniards and by the Empire, was thenceforward to encounter them everywhere in her course. The historical progress of France was once more endangered.

The reasons of state which governed all Louis XI.'s external policy also inspired his internal administration. If they justified him in employing lies and deception in international affairs, in his relations with his subjects they led him to regard as lawful everything which favoured his authority; no question of right could weigh against it. The army and taxation, as the two chief means of domination within and without the kingdom, constituted the main bulwarks of his policy. As for the nobility, his only thought was to diminish their power by multiplying their number, as his predecessors had done; while he reduced the rebels to submission by his iron cages or the axe of his gossip Tristan Lermite. The Church was treated with the same unconcerned cynicism; he held her in strict tutelage, accentuating her moral decadence still further by the manner in which he set aside or re-established the Pragmatic Sanction, according to the fluctuations of his financial necessities or his Italian ambitions. It has been said that on the other hand he was a king of the common people, and certainly he was one of them in his simple habits, in his taste for rough pleasantries, and above all in his religion, which was limited to superstitious practices and small devoutnesses. But in the states of Tours in 1468 he evinced the same mistrust for fiscal control by the people as for the privileges of the nobility. He inaugurated that autocratic rule which was to continue gaining strength until Louis XV.'s time. Louis XI. was the king of the bourgeoisie; he exacted much from them, but paid them back with interest by allowing them to reduce the power of all who were above them and to lord it over all who were below. As a matter of fact Louis XI.'s most faithful ally was death. Saint-Pol, Nemours, Charles the Bold, his brother the duke of Berry, old René of Anjou and his nephew the count of Maine, heir to the riches of Provence and to rights over Naples—the skeleton hand mowed down all his adversaries as though it too were in his pay; until the day when at Plessisles-Tours it struck a final blow, claimed its just dues from Louis XI., and carried him off despite all his relics on the 30th of August 1483.

There was nothing noble about Louis XI. but his aims, and nothing great but the results he attained; yet however different he might have been he could not have done better, for what he achieved was the making of France. This was soon seen after his death in the reaction which menaced his work and those who had served him; but thanks to himself and to his true successor, his eldest daughter Anne, married to the sire de Beaujeu, a

younger member of the house of Bourbon, the set-back was only partial. Strife began immediately between the numerous malcontents and the Beaujeu party, who had charge of the little Charles VIII. These latter prudently made concessions: reducing the *taille*, sacrificing some of Louis XI.'s creatures to the rancour of the parlement, and restoring a certain number of offices or lands to the hostile princes (chief of whom was the duke of Orleans), and even consenting to a convocation of the states-general at Tours (1484). But the elections having been favourable to royalty, the Beaujeu family made the states reject the regency desired by the duke of Orleans, and organize the king's council after their own views. When they subsequently eluded the conditions imposed by the states, the deputies—nobles, clergy and burgesses—showed their incapacity to oppose the progress of despotism. In vain did the malcontent princes attempt to set up a new League of Public Weal, the *Guerre folle* (Mad War), in which the duke of Brittany, Francis II., played the part of Charles the Bold, dragging in the people of Lorraine and the king of Navarre. In vain did Charles VIII., his majority attained, at once abandon in the treaty of Sablé the benefits gained by the victory of Saint-Aubin du Cormier (1488). In vain did Henry VII. of England, Ferdinand the Catholic, and Maximilian of Austria try to prevent the annexation of Brittany by France; its heiress Anne, deserted by every one, made peace and married Charles VIII. in 1491. There was no longer a single great fief in France to which the malcontents could fly for refuge.

It now remained to consolidate the later successes attained by the policy of the Valois—the acquisition of the duchies of Burgundy and Brittany; but instead there was a sudden change and that policy seemed about to be lost in dreams of recapturing the rights of the Angevins over Naples, and conquering Constantinople. Charles VIII., a prince with neither intelligence nor resolution, his head stuffed with chivalric romance, was scarcely freed from his sister's control when he sought in Italy a fatal distraction from the struggle with the house of Austria. By this "war of magnificence" he caused an interruption of half a century in the growth of national sentiment, which was only revived by Henry II.; and he was not alone in thus leaving the bone for the shadow: his contemporaries, Ferdinand the Catholic when delivered from the Moors, and Henry VII. from the power of the English nobles, followed the same superficial policy, not taking the trouble to work for that real strength which comes from the adhesion of willing subjects to their sovereign. They only cared to aggrandize themselves, without thought of national feeling or geographical conditions. The great theorist of these "conquistadores" was Machiavelli. The regent, Anne of Beaujeu, worked in her daughter's interest to the detriment of the kingdom, by means of a special treaty destined to prevent the property of the Bourbons from reverting to the crown; while Anne of Brittany did the like for her daughter Claude. Louis XII., the next king of France, thought only of the Milanese; Ferdinand the Catholic all but destroyed the Spanish unity at the end of his life by his marriage with Germaine de Foix; while the house of Austria was for centuries to remain involved in this petty course of policy. Ministers followed the example of their self-seeking masters, thinking it no shame to accept pensions from foreign sovereigns. The preponderating consideration everywhere was direct material advantage; there was disproportion everywhere between the means employed and the poverty of the results, a contradiction between the interests of the sovereigns and those of their subjects, which were associated by force and not naturally blended. For the sake of a morsel of Italian territory every one forgot the permanent necessity of opposing the advance of the Turkish crescent, the two horns of which were impinging upon Europe on the Danube and on the Mediterranean.

Italy and Germany were two great tracts of land at the mercy of the highest bidder, rich and easy to dominate, where these coarse and alien kings, still reared on medieval traditions, were for fifty years to gratify their love of conquest. Italy was their

The Mad War, 1485.

A policy of "magnificence."

Charles VIII. and Brittany (1483-1498).

Rule of the house of Burgundy.

The administration of Louis XI.

first battlefield; Charles VIII. was summoned thither by Lodovico II Moro, tyrant of Milan, involved in a quarrel with his rival, Ferdinand II. of Aragon. The Aragonese had snatched the kingdom of Naples from the French house of Anjou, whose claims Louis XI. had inherited in 1480. To safeguard himself in the rear Charles VIII. handed over Roussillon and Cerdagne (Cerdeña) to Ferdinand the Catholic (that is to say, all the profits of Louis XI.'s policy); gave enormous sums of money to Henry VII. of England; and finally, by the treaty of Senlis ceded Artois and Franche-Comté to Maximilian of Austria. After these fool's bargains the paladin set out for Naples in 1494. His journey was long and triumphant, and his return precipitate; indeed it very nearly ended in a disaster at Fornovo, owing to the first of those Italian holy leagues which at the least sign of friction were ready to turn against France. At the age of twenty-eight, however, Charles VIII. died without issue (1498).

The accession of his cousin, Louis of Orleans, under the title of Louis XII., only involved the kingdom still further in this Italian imbroglio. Louis did indeed add the fief of Orleans to the royal domain and hastened to divorce Jeanne of France in order to marry Anne, the widow of his predecessor, so that he might keep Brittany.

But he complicated the Naples affair by claiming Milan in consideration of the marriage of his grandfather, Louis of Orleans, to Valentina, daughter of Gian Galeazzo Visconti, duke of Milan. In 1499, appealed to by Venice, and encouraged by his favourite, Cardinal d'Amboise (who was hoping to succeed Pope Alexander VI.), and also by Cesare Borgia, who had lofty ambitions in Italy, Louis XII. conquered Milan in seven months and held it for fourteen years; while Lodovico Sforza, betrayed by his Swiss mercenaries, died a prisoner in France. The kingdom of Naples was still left to recapture; and fearing to be thwarted by Ferdinand of Aragon, Louis XII. proposed to this master of roguery that they should divide the kingdom according to the treaty of Granada (1500). But no sooner had Louis XII. assumed the title of king of Naples than Ferdinand set about despoiling him of it, and despite the bravery of a Bayard and a Louis d'Ars, Louis XII., being also betrayed by the pope, lost Naples for good in 1504. The treaties of Blois occasioned a vast amount of diplomacy, and projects of marriage between Claude of France and Charles of Austria, which came to nothing but served as a prelude to the later quarrels between Bourbons and Habsburgs.

It was Pope Julius II. who opened the gates of Italy to the horrors of war. Profiting by Louis XII.'s weakness and the emperor Maximilian's strange capricious character, this martial pope sacrificed Italian and religious interests alike in order to re-establish the temporal power of the papacy. Jealous of Venice, at that time the Italian state best provided with powers of expansion, and unable to subjugate it single-handed, Julius succeeded in obtaining help from France, Spain and the Empire. The league of Cambrai (1508) was his finest diplomatic achievement. But he wanted to be sole master of Italy; so in order to expel the French "barbarians" whom he had brought in, he appealed to other barbarians who were far more dangerous—Spaniards, Germans and Swiss—to help him against Louis XII., and stabbed him from behind with the Holy League of 1511.

Weakened by the death of Cardinal d'Amboise, his best counsellor, Louis XII. tried vainly in the assembly of Tours and in the unsuccessful council of Pisa to alienate the French clergy from a papacy which was now so little worthy of respect. But even the splendid victories of Gaston de Foix could not shake that formidable coalition; and despite the efforts of Bayard, La Palice and La Trémoille, it was the Church that triumphed. Julius II. died in the hour of victory; but Louis XII. was obliged to evacuate Milan, to which he had sacrificed everything, even France itself, with that political stupidity characteristic of the first Valois. He died almost immediately after this, on the 1st of January 1515, and his subjects, recognizing his thrift, his justice and the secure prosperity of the kingdom, forgot the

seventeen years of war in which they had not been consulted, and rewarded him with the fine title of Father of his People.

As Louis XII. left no son, the crown devolved upon his cousin and son-in-law the count of Angoulême, Francis I. No sooner king, Francis, in alliance with Venice, renewed the chimerical attempts to conquer Milan and Naples; also cherishing dreams of his own election as emperor and of a partition of Europe. The heroic episode of Marignano, when he defeated Cardinal Schinner's Swiss troops (13-15 of September 1515), made him master of the duchy of Milan and obliged his adversaries to make peace. Leo X., Julius II.'s successor, by an astute volte-face exchanged Parma and the Concordat for a guarantee of all the Church's possessions, which meant the defeat of French plans (1515). The Swiss signed the permanent peace which they were to maintain until the Revolution of 1789; while the emperor and the king of Spain recognized Francis II.'s very precarious hold upon Milan. Once more the French monarchy was pulled up short by the indignation of all Italy (1518).

The question now was how to occupy the military activity of a young, handsome, chivalric and gallant prince, "ondoyant et divers," intoxicated by his first victory and his tardy accession to fortune. This had been hailed with joy by all who had been his comrades in his days of difficulty; by his mother, Louise of Savoy, and his sister Marguerite; by all the rough young soldiery; by the nobles, tired of the bourgeois ways of Louis XI. and the patriarchal simplicity of Louis XII.; and finally by all the aristocracy who expected now to have the government in their own hands. So instead of heading the crusade against the Turks, Francis threw himself into the electoral contest at Frankfort, which resulted in the election of Charles V., heir of Ferdinand the Catholic, Spain and Germany thus becoming united. Pope Leo X., moreover, handed over three-quarters of Italy to the new emperor in exchange for Luther's condemnation, thereby kindling that rivalry between Charles V. and the king of France which was to embroil the whole of Europe throughout half a century (1519-1559), from Pavia to St Quentin.

The territorial power of Charles V., heir to the houses of Burgundy, Austria, Castile and Aragon, which not only arrested the traditional policy of France but hemmed her in on every side; his pretensions to be the head of Christendom; his ambition to restore the house of Burgundy and the Holy Roman Empire; his grave and forceful intellect all rendered rivalry both inevitable and formidable. But the scattered heterogeneity of his possessions, the frequent crippling of his authority by national privileges or by political discords and religious quarrels, his perpetual straits for money, and his cautious calculating character, almost outweighed the advantages which he possessed in the terrible Spanish infantry, the wealthy commerce of the Netherlands, and the inexhaustible mines of the New World. Moreover, Francis I. stirred up enmity everywhere against Charles V., and after each defeat he found fresh support in the patriotism of his subjects. Immediately after the treaty of Madrid (1526), which Francis I. was obliged to sign after the disaster at Pavia and a period of captivity, he did not hesitate between his honour as a gentleman and the interests of his kingdom. Having been unable to win over Henry VIII. of England at their interview on the Field of the Cloth of Gold, he joined hands with Suleiman the Magnificent, the conqueror of Mohács; and the Turkish cavalry, crossing the Hungarian *Puszta*, made their way as far as Vienna, while the mercenaries of Charles V., under the constable de Bourbon, were reviving the saturnalia of Alaric in the sack of Rome (1527). In Germany, Francis I. assisted the Catholic princes to maintain their political independence, though he did not make the capital he might have made of the reform movement. Italy remained faithful to the vanquished in spite of all, while even Henry VIII. of England, who only needed bribing, and Wolsey, accessible to flattery, took part in the temporary coalition. Thus did France, menaced with disruption, embark upon a course of action imposed

*The wars
in Italy.*

*Louis XII.
(1498-
1515).*

*Francis I.
(1515-
1547).*

*Character
of
Francis I.*

*Rivalry of
Francis I.
and
Charles V.*

*Defeat at
Pavia and
treaty of
Madrid.*

upon her by the harsh conditions of the treaty of Madrid—otherwise little respected—and later by those of Cambrai (1529); but it was not till later, too late indeed, that it was defined and became a national policy.

After having, despite so many reverses and mistakes, saved Burgundy, though not Artois nor Flanders, and joined to the crown lands the domains of the constable de Bourbon who had gone over to Charles V., Francis I. should have had enough of defending other people's independence as well as his own, and should have thought more of his interests in the north and east than of Milan.

Yet between 1531 and 1547 he manifested the same regrets and the same invincible ambition for that land of Italy which Charles V., on his side, regarded as the basis of his strength. Their antagonism, therefore, remained unabated, as also the contradiction of an official agreement with Charles V., combined with secret intrigues with his enemies. Anne de Montmorncy, now head of the government in place of the headstrong chancellor Duprat, for four years upheld a policy of reconciliation and of almost friendly agreement between the two monarchs (1531–1535). The death of Francis I.'s mother, Louise of Savoy (who had been partly instrumental in arranging the peace of Cambrai), the replacement of Montmorncy by the bellicose Chabot, and the advent to power of a Burgundian, Granvella, as Charles V.'s prime minister, put an end to this double-faced policy, which attacked the Calvinists of France while supporting the Lutherans of Germany; made advances to Clement VII. while pretending to maintain the alliance with Henry VIII. (just then consummating the Anglican schism); and sought an alliance with Charles V. without renouncing the possession of Italy. The death of the duke of Milan provoked a third general war (1536–1538);

The truce at Nice.

but after the conquest of Savoy and Piedmont and a fruitless invasion of Provence by Charles V., it resulted in another truce, concluded at Nice, in the interview at Aigues-mortes, and in the old contradictory policy of the treaty of Cambrai. This was confirmed by Charles V.'s triumphal journey through France (1539).

Rivalry between Madame d'Etampes, the imperious mistress of the aged Francis I., and Diane de Poitiers, whose ascendancy over the dauphin was complete, now brought court intrigues and constant changes in those who held office, to complicate still further this wearisome policy of ephemeral "combinazioni" with English, Germans, Italians and Turks, which urgent need of money always brought to naught. The disillusionment of Francis I., who had hitherto hoped that Charles V. would be generous enough to give Milan back to him, and then the assassination of Rincon, his ambassador at Constantinople, led to a fourth war (1544–1546); in the course of which the king of England went over to the side of Charles V.

Unable in the days of his youth to make Italy French, when age began to come upon him, Francis tried to make France Italian. In his château at Blois he drank greedily of the cup of Renaissance art; but he found the exciting draughts of diplomacy which he imbibed from Machiavelli's *Prince* even more intoxicating, and he headed the ship of state straight for the rock of absolutism. He had been the first king "*du bon plaisir*" ("of his own good pleasure")—a "Caesar," as his mother Louise of Savoy proudly hailed him in 1515—and to a man of his gallant and hot-headed temperament love and war were schools little calculated to teach moderation in government. Italy not only gave him a taste for art and letters, but furnished him with an arsenal of despotic maxims. Yet his true masters were the jurists of the southern universities, passionately addicted to centralization and autocracy, men like Duprat and Poyet, who revived the persistent tradition of Philip the Fair's legists. Grouped together on the council of affairs, they managed to control the policy of the common council, with its too mixed and too independent membership. They successfully strove to separate "the grandeur and superexcellence of the king" from the rest of the nation; to isolate the nobility amid the seductions of a court lavish in

promises of favour and high office; and to win over the bourgeoisie by the buying and selling and afterwards by the hereditary transmission of offices. Thanks to their action, feudalism was attacked in its landed interest in the person of the constable de Bourbon; feudalism in its financial aspect by the execution of superintendent Semblançay and the special privileges of towns and provinces by administrative centralization. The bureaucracy became a refuge for the nobles, and above all for the bourgeois, whose fixed incomes were lowered by the influx of precious metals from the New World, while the wages of artisans rose. All those time-worn medieval institutions which no longer allowed free scope to private or public life were demolished by the legists in favour of the monarchy.

Their masterstroke was the Concordat of 1516, which meant an immense stride in the path towards absolutism. While Germany and England, where ultramontane doctrines had been allowed to creep in, were seeking a remedy against the economic exactions of the papacy in a reform of dogma or in schism, France had supposed herself to have found this in the Pragmatic Sanction of Bourges. But to the royal jurists the right of the churches and abbeys to make appointments to all vacant benefices was a guarantee of liberties valuable to the clergy, but detestable to themselves because the clergy thus retained the great part of public wealth and authority. By giving the king the ecclesiastical patronage they not only made a docile instrument of him, but endowed him with a mine of wealth, even more productive than the sale of offices, and a power of favouring and rewarding that transformed a needy and ill-obeyed king into an absolute monarch. To the pope they offered a mess of pottage in the shape of *annates* and the right of canonical institution, in order to induce him to sell the Church of France to the king. By this royal reform they completely isolated the monarchy, in the presumptuous pride of omnipotence, upon the ruins of the Church and the aristocracy, despite both the university and the parlement of Paris.

The concordat of 1516.

Thus is explained Francis I.'s preoccupation with Italian adventures in the latter part of his reign, and also the inordinate squandering of money, the *autos-da-fé* in the provinces and in Paris, the harsh repression of reform and free thought, and the sale of justice; while the nation became impoverished and the state was at the mercy of the caprices of royal mistresses—all of which was to become more and more pronounced during the twelve years of Henry II.'s government.

Henry II. shone but with a reflected light—in his private life reflected from his old mistress, Diane de Poitiers, and in his political action reflected from the views of Montmorncy or the Guises. He only showed his own personality in an egoism more narrow-minded, in hatred yet bitterer than his father's; or in a haughty and jealous insistence upon an absolute authority which he never had the wit to maintain.

Henry II. (1547–1559.)

The struggle with Charles V. was at first delayed by differences with England. The treaty of Ardres had left two bones of contention: the cession of Boulogne to England and the exclusion of the Scotch from the terms of peace. At last the regent, the duke of Somerset, endeavoured to arrange a marriage between Edward VI., then a minor, and Mary Stuart, who had been offered in marriage to the dauphin Francis by her mother, Marie of Lorraine, a Guise who had married the king of Scotland. The transference of Mary Stuart to France, and the treaty of 1550 which restored Boulogne to France for a sum of 400,000 crowns, suspended the state of war; and then Henry II.'s opposition to the imperial policy of Charles V. showed itself everywhere: in Savoy and Piedmont, occupied by the French and claimed by Philibert Emmanuel, Charles V.'s ally; in Navarre, unlawfully conquered by Ferdinand the Catholic and claimed by the family of Albret; in Italy, where, aided and abetted by Pope Paul III., Henry II. was trying to regain support; and, finally, in Germany, where after the victory of Charles V. at Mühlberg (1547) the Protestant princes called Henry II. to their aid, offering to

Henry II. and Charles V.

Royal absolutism under Francis I.

subsidize him and cede to him the towns of Metz, Toul and Verdun. The Protestant alliance was substituted for the Turkish alliance, and Henry II. hastened to accept the offers made to him (1552); but this was rather late in the day, for the reform movement had produced civil war and evoked fresh forces. The Germans, in whom national feeling got the better of imperialistic ardour, as soon as they saw the French at Strassburg, made terms with the emperor at Passau and permitted Charles to use all his forces against Henry II. The

**Defence
of Metz.**

defence of Metz by Francis of Guise was admirable and successful; but in Picardy operations continued their course without much result, owing to the incapacity of the constable de Montmorency. Fortunately, despite the marriage of Charles V.'s son Philip to Mary Tudor, which gave him the support of England (1554), and despite the religious pacification of Germany through the peace of

**Truce of
Vaucelles.**

Augsburg (1555), Charles V., exhausted by illness and by thirty years of intense activity, in the truce of Vaucelles abandoned Henry II.'s conquests—Piedmont and the Three Bishoprics. He then abdicated the government of his kingdoms, which he divided between his son Philip II. and his brother Ferdinand (1556). A double victory, this, for France.

Henry II.'s resumption of war, without provocation and without allies, was a grave error; but more characterless than ever, the king was urged to it by the Guises, whose influence since the defence of Metz had been supreme at court and who were perhaps hoping to obtain

**Henry II.
and
Philip II.**

Naples for themselves. On the other hand, Pope Paul IV. and his nephew Carlo Caraffa embarked upon the struggle, because as Neapolitans they detested the Spaniards, whom they considered as "barbarous" as the Germans or the

**Peace of
Cateau-
Cambrésis.**

French. The constable de Montmorency's disaster at Saint Quentin (August 1557), by which Philip II. had not the wit to profit, was successfully avenged by Guise, who was appointed lieutenant-general of the kingdom. He took Calais by assault in January 1558, after the English had held it for two centuries, and occupied Luxemburg. The treaty of Cateau-Cambrésis (August 1559) finally put an end to the Italian follies, Naples, Milan and Piedmont; but it also lost Savoy, making a gap in the frontier for a century. The question of Burgundy was definitely settled, too; but the Netherlands had still to be conquered. By the possession of the three bishoprics and the recapture of Calais an effort towards a natural line of frontier and towards a national policy seemed indicated; but while the old soldiers could not forget Marignano, Ceresole, nor Italy perishing with the name of France on her lips, the secret alliance between the cardinal of Lorraine and Granvella against the Protestant heresy foretold the approaching subordination of national questions to religious differences, and a decisive attempt to purge the kingdom of the new doctrines.

The origin and general history of the religious reformation in the 16th century are dealt with elsewhere (see CHURCH

**The Re-
formation.**

HISTORY and REFORMATION). In France it had originally no revolutionary character whatever; it proceeded from traditional Gallican theories and from the innovating principle of humanism, and it began as a protest against Roman decadence and medieval scholasticism. It found its first adherents and its first defenders among the clerics and learned men grouped around Faber (Lefèvre) of Étampes at Meaux; while Marguerite of Navarre, "des Roynes la non pareille," was the indefatigable Maecenas of these innovators, and the incarnation of the Protestant spirit at its purest. The reformers shook off the yoke of systems in order boldly to renovate both knowledge and faith; and, instead of resting on the abstract *a priori* principles within which man and nature had been imprisoned, they returned to the ancient methods of observation and analysis. In so doing, they separated intellectual from popular life; and acting in this spirit, through the need of a moral renaissance, they reverted to primitive Christianity, substituting the inner and individual authority of conscience for the general and external authority of the Church. Their

efforts would not, however, have sufficed if they had not been seconded by events; pure doctrine would not have given birth to a church, nor that church to a party; in France, as in Germany, the religious revolution was conditioned by an economic and social revolution.

The economic renaissance due to the great maritime discoveries had the consequence of concentrating wealth in the hands of the bourgeoisie. Owing to their mental qualities, their tendencies and their resources, the bourgeoisie had been, if not alone, at least most apt in profiting by the development of industry, by the extension of commerce, and by the formation of a new and mobile means of enriching themselves. But though the bourgeois had acquired through capitalism certain sources of influence, and gradually monopolized municipal and public functions, the king and the peasants had also benefited by this revolution. After a hundred and fifty years of foreign war and civil discord, at a period when order and unity were ardently desired, an absolute monarchy had appeared the only power capable of realizing such aspirations. The peasants, moreover, had profited by the reduction of the idle landed aristocracy; serfdom had decreased or had been modified; and the free peasants were more prosperous, had reconquered the soil, and were selling their produce at a higher rate while they everywhere paid less exorbitant rents. The victims of this process were the urban proletariat, whose treatment by their employers in trade became less and less protective and beneficent, and the nobility, straitened in their financial resources, uprooted from their ancient strongholds, and gradually despoiled of their power by a monarchy based on popular support. The unlimited sovereignty of the prince was established upon the ruins of the feudal system; and the capitalism of the merchants and bankers upon the closing of the trade-gilds to workmen, upon severe economic pressure and upon the exploitation of the artisans' labour.

Though reform originated among the educated classes it speedily found an echo among the industrial classes of the 16th century, further assisted by the influence of German and Flemish journeymen. The popular reform-movement was essentially an urban movement; although under Francis I. and Henry II. it had already begun to spread into the country. The artisans, labourers and small shop-keepers who formed the first nucleus of the reformed church were numerous enough to provide an army of martyrs, though too few to form a party. Revering the monarchy and established institutions, they endured forty years of persecution before they took up arms. It was only during the second half of Henry II.'s reign that Protestantism, having achieved its religious evolution, became a political party. Weary of being trodden under foot, it now demanded much more radical reform, quitting the ranks of peaceable citizens to pass into the only militant class of the time and adopt its customs. Men like Coligny, d'Andelot and Condé took the place of the timid Lefèvre of Étampes and the harsh and bitter Calvin; and the reform party, in contradiction to its doctrines and its doctors, became a political and religious party of opposition, with all the compromises that presupposes. The struggle against it was no longer maintained by the university and the parlement alone, but also by the king, whose authority it menaced.

With his intrepid spirit, his disdain for ecclesiastical authority and his strongly personal religious feeling, Francis I. had for a moment seemed ready to be a reformer himself; but deprived by the Concordat of all interest in the confiscation of church property, aspiring to political alliance with the pope, and as mistrustful of popular forces as desirous of absolute power and devoted to Italy, he paused and then drew back. Hence came the revocation in 1540 of the edict of tolerance of Coucy (1535), and the massacre of the Vaudois (1545). Henry II., a fanatic, went still further in his edict of Châteaubriant (1551), a code of veritable persecution, and in the *coup d'état* carried out in the parlement against Antoine du Bourg and his colleagues (1559). At the same time the pastors of the reformed religion,

**Trans-
formation
of religious
reform into
party
politics.**

**Royal per-
secution
under
Francis I.
and
Henry II.**

met in synod at Paris, were setting down their confession of faith founded upon the Scriptures, and their ecclesiastical discipline founded upon the independence of the churches. Thenceforward Protestantism adopted a new attitude, and refused obedience to the orders of a persecuting monarchy when contrary to its faith and its interests. After the saints came men. Hence those wars of religion which were to hold the monarchy in check for forty years and even force it to come to terms.

In slaying Henry II. Montgomery's lance saved the Protestants for the time being. His son and successor, Francis II., was but a nervous sickly boy, banded between two women: his mother, Catherine de' Medici, hitherto kept in the background, and his wife, Mary Stuart, queen of Scotland, who being a niece of the Guises brought her uncles, the constable Francis and the cardinal of Lorraine, into power. These ambitious and violent men took the government out of the hands of the constable de Montmorency and the princes of the blood: Antoine de Bourbon, king of Navarre, weak, credulous, always playing a double game on account of his preoccupation with Navarre; Condé, light-hearted and brave, but not fitted to direct a party; and the cardinal de Bourbon, a mere nonentity. The only plan which these princes could adopt in the struggle, once they had lost the king, was to make a following for themselves among the Calvinist malcontents and the gentlemen disbanded after the Italian wars. The Guises, strengthened by the failure of the conspiracy of Amboise, which had been aimed at them, abused the advantage due to their victory. Despite the edict of Romorantin, which by giving the bishops the right of cognizance of heresy prevented the introduction of the Inquisition on the Spanish model into France; despite the assembly of Fontainebleau, where an attempt was made at a compromise acceptable to both Catholics and moderate Calvinists; the reform party and its Bourbon leaders, arrested at the states-general of Orleans, were in danger of their lives. The death of Francis II. in December 1560 compromised the influence of the Guises and again saved Protestantism.

Charles IX. also was a minor, and the regent should legally have been the first prince of the blood, Antoine de Bourbon; but cleverly flattered by the queen-mother, Catherine de' Medici, he let her take the reins of government. Hitherto Catherine had been merely the resigned and neglected wife of Henry II., and though eloquent, insinuating and ambitious, she had been inactive. She had attained the age of forty-one when she at last came into power amidst the hopes and anxieties aroused by the fall of the Guises and the return of the Bourbons to fortune. Indifferent in religious matters, she had a passion for authority, a characteristically Italian adroitness in intrigue, a fine political sense, and the feeling that the royal authority might be endangered both by Calvinistic passions and Catholic violence. She decided for a system of tolerance; and Michel de l'Hôpital, the new chancellor, was her spokesman at the states of Orleans (1560). He was a good and honest man, moderate, conciliatory and temporizing, anxious to lift the monarchy above the strife of parties and to reconcile them; but he was so little practical that he could believe in a reformation of the laws in the midst of all the violent passions which were now to be let loose. These two, Catherine and her chancellor, attempted, like Charles V. at Augsburg, to bring about religious pacification as a necessary condition for the maintenance of order; but they were soon overwhelmed by the different factions.

On one side was the Catholic triumvirate of the constable de Montmorency, the duke of Guise, and the marshal de St André; and on the other the Huguenot party of Condé and Coligny, who, having obtained liberty of worship in January 1561, now demanded liberty of conscience in January 1561, now demanded liberty of worship. The colloquy at Poissy between the cardinal of Lorraine and Theodore Beza (September 1561), did not end in the agreement hoped for, and the duke of Guise so far abused its spirit as to embroil the French Calvinists with the German

Lutherans. The rupture seemed irremediable when the assembly of Poissy recognized the order of the Jesuits, which the French church had held in suspicion since its foundation. However, yielding to the current which was carrying the greater part of the nation towards reform, and despite the threats of Philip II. who dreaded Calvinistic propaganda in his Netherlands, Michel de l'Hôpital promulgated the edict of January 17, 1562—a true charter of enfranchisement for the Protestants. But the pressure of events and of parties was too strong; the policy of toleration which had mis-carried at the council of Trent had no chance of success in France.

The triumvirate's relations with Spain and Rome were very close; they had complete ascendancy over the king and over Catherine; and now the massacre of two hundred Protestants at Vassy on the 1st of March 1562 made the cup overflow. The duke of Guise had either ordered this, or allowed it to take place, on his return from an interview with the duke of Württemberg at Zabern, where he had once more demanded the help of his Lutheran neighbours against the Calvinists; and the Catholics having celebrated this as a victory the signal was given for the commencement of religious wars. When these eight fratricidal wars first began, Protestants and Catholics rivalled one another in respect for royal authority; only they wished to become its masters so as to get the upper hand themselves. But in course of time, as the struggle became embittered, Catholicism itself grew revolutionary; and this twofold fanaticism, Catholic and Protestant, even more than the ambition of the leaders, made the war a ferocious one from the very first. Beginning with surprise attacks, if these failed, the struggle was continued by means of sieges and by terrible exploits like those of the Catholic Montluc and the Protestant des Adrets in the south of France. Neither of these two parties was strong enough to crush the other, owing to the apathy and continual desertions of the gentlemen-cavaliers who formed the élite of the Protestant army and the insufficient numbers of the Catholic forces. Allies from outside were therefore called in, and this it was that gave a European character to these wars of religion; the two parties were parties of foreigners, the Protestants being supported by German *Landsknechts* and Elizabeth of England's cavalry, and the royal army by Italian, Swiss or Spanish auxiliaries. It was no longer patriotism but religion that distinguished the two camps. There were three principal theatres of war: in the north Normandy and the valley of the Loire, where Orleans, the general centre of reform, ensured communications between the south and Germany; in the south-west Gascony and Guienne; in the south-east Lyonnais and Vivarais.

In the first war, which lasted for a year (1562-1563), the triumvirs wished to secure Orleans, previously isolated. The threat of an English landing decided them to lay siege to Rouen, and it was taken by assault; but this cost the life of the versatile Antoine de Bourbon. On the 19th of December 1562 the duke of Guise barred the way to Dreux against the German reinforcements of d'Andelot, who after having threatened Paris were marching to join forces with the English troops for whom Coligny and Condé had paid by the cession of Havre. The death of marshal de St André, and the capture of the constable de Montmorency and of Condé, which marked this indecisive battle, left Coligny and Guise face to face. The latter's success was of brief duration; for on the 18th of February 1563 Poltrot de Méré assassinated him before Orleans, which he was trying to take once and for all. Catherine, relieved by the loss of an inconvenient preceptor, and by the disappearance of the other leaders, became mistress of the Catholic party, of whose strength and popularity she had now had proof, and her idea was to make peace at once on the best terms possible. The egoism of Condé, who got himself made lieutenant-general of the kingdom, and bargained for freedom of worship for the Protestant nobility only, compromised the future of both his church and his party, though rendering possible the peace of Amboise, concluded the 19th of March

Francis II.
(1559-1560).

Charles IX.
(1560-1574).

The parties.

Edict of toleration.

Character of the religious wars.

First religious war.

1563. All now set off together to recapture Havre from the English.

The peace, however, satisfied no one; neither Catholics (because of the rupture of religious unity) nor the parlements; the pope, the emperor and king of Spain alike protested against it. Nor yet did it satisfy the Protestants, who considered its concessions insufficient, above all for the people. It was, however, the maximum of

Peace of Amboise (1563).

tolerance possible just then, and had to be reverted to; Catherine and Charles IX. soon saw that the times were not ripe for a third party, and that to enforce real toleration would require an absolute power which they did not possess. After three years the Guises reopened hostilities against Coligny, whom they accused of having plotted the murder of their chief; while the Catholics, egged on by the Spaniards, rose against the Protestants, who had been made uneasy by an interview between Catherine and her daughter Elizabeth, wife of Philip II. of Spain, at Bayonne, and by the duke of Alva's persecutions of the reformed church of the Netherlands—a daughter-church of Geneva, like their own. The second civil war began like the

Second civil war.

first with a frustrated attempt to kidnap the king, at the castle of Montceaux, near Meaux, in September 1567; and with a siege of Paris, the general centre of Catholicism, in the course of which the constable de Montmorency was killed at Saint-Denis. Condé, with the men-at-arms of John Casimir, son of the Count Palatine, tried to starve out the capital; but once more the defection of the nobles obliged him to sign a treaty of peace at Longjumeau on the 23rd of March 1568, by which the conditions of Amboise were re-established. After

Peace of Longjumeau.

the attempt at Montceaux the Protestants had to be contented with Charles IX.'s word.

This peace was not of long duration. The fall of Michel de l'Hôpital, who had so often guaranteed the loyalty of the Huguenots, ruined the moderate party (May 1568).

Third war.

Catholic propaganda, revived by the monks and the Jesuits, and backed by the armed confraternities and

by Catherine's favourite son, the duke of Anjou, now entrusted with a prominent part by the cardinal of Lorraine; Catherine's complicity in the duke of Alva's terrible persecution in the Netherlands; and her attempt to capture Coligny and Condé at Noyers all combined to cause a fresh outbreak of hostilities in the west. Thanks to Tavannes, the duke of Anjou gained easy victories at Jarnac over the prince of Condé, who was killed, and at Moncontour over Coligny, who was wounded (March-October 1569); but these successes were rendered fruitless by the jealousy of Charles IX. Allowing the queen of Navarre to shut herself up in La Rochelle, the citadel of the reformers, and the king to loiter over the siege of Saint Jean d'Angély, Coligny pushed boldly forward towards Paris and, having reached Burgundy, defeated the royal army at Arnay-le-duc. Catherine had exhausted all her resources; and having failed in her project of remarrying Philip II. to one of her daughters, and of betrothing Charles IX. to the eldest of the Austrian archduchesses, exasperated also by the presumption of the Lorraine family, who

aspired to the marriage of their nephew with Charles IX.'s sister, she signed the peace of St Germain on the 8th of August 1570. This was the culminating point of Protestant liberty; for Coligny exacted and obtained, first, liberty of conscience and of worship, and then, as a guarantee of the king's word, four fortified places: La Rochelle, a key to the sea; La Charité, in the centre; Cognac and Montauban in the south.

Peace of St Germain (1570.)

The Guises set aside, Coligny, supported as he was by Jeanne d'Albret, queen of Navarre, now received all Charles IX.'s favour. Catherine de' Medici, an inveterate match-maker, and also uneasy at Philip II.'s increasing power, made advances to Jeanne, proposing to marry her own daughter, Marguerite de Valois, to Jeanne's son, Henry of Navarre, now chief of the Huguenot party. Coligny was a Protestant, but he was a Frenchman before all; and wishing to reconcile all parties in a national struggle, he

Colligoy and the Netherlands.

"trumpeted war" (*cornait la guerre*) against Spain in the Netherlands—despite the lukewarmness of Elizabeth of England and the Germans, and despite the counter-intrigues of the pope and of Venice. He succeeded in getting French troops sent to the Netherlands, but they suffered defeat. None the less Charles IX. still seemed to see only through the eyes of Coligny; till Catherine, fearing to be supplanted by the latter, dreading the results of the threatened war with Spain, and egged on by a crowd of Italian adventurers in the pay of Spain—men like Gondi and Birague, reared like herself in the political theories and customs of their native land—saw no hope but in the assassination of this rival in her son's esteem. A murderous attack upon Coligny, who had opposed the candidature of Catherine's favourite son, the duke of Anjou, for the throne of Poland, having only succeeded in wounding him and in exciting the Calvinist leaders, who were congregated in Paris for the occasion of Marguerite de Valois' marriage with the king of Navarre, Catherine and the Guises resolved together to put them all to death. There followed the wholesale massacre of St Bartholomew's

Eve, in Paris and in the provinces; a natural consequence of public and private hatreds which had poisoned the entire social organism. This massacre had the effect of preventing the expedition into Flanders, and destroying Francis I.'s policy of alliance with the Protestants against the house of Austria.

St Bartholomew, August 24, 1572.

Catherine de' Medici soon perceived that the massacre of St Bartholomew had settled nothing. It had, it is true, dealt a blow to Calvinism just when, owing to the reforms of the council of Trent, the religious ground had been crumbling beneath it. Moreover, within the party itself a gulf had been widening between the pastors, supported by the Protestant democracy and the political nobles.

The party of the politiques.

The reformers had now no leaders, and their situation seemed as perilous as that of their co-religionists in the Netherlands; while the sieges of La Rochelle and Leiden, the enforced exile of the prince of Orange, and the conversion under pain of death of Henry of Navarre and the prince of Condé, made the common danger more obvious. Salvation came from the very excess of the repressive measures. A third party was once more formed, composed of moderates from the two camps, and it was recruited quite as much by jealousy of the Guises and by ambition as by horror at the massacres. There were the friends of the Montmorency party—Damville at their head; Coligny's relations; the king of Navarre; Condé; and a prince of the blood, Catherine de' Medici's third son, the duke of Alençon, tired of being kept in the background. This party took shape at the end of the fourth war, followed by the edict of Boulogne (1573), forced from Charles IX. when the Catholics were deprived of their leader by the election of his brother, the duke of Anjou, as king of Poland.

Fourth War. Edict of Boulogne (1573.)

A year later the latter succeeded his brother on the throne of France as Henry III. This meant a new lease of power for the queen-mother.

The *politiques*, as the supporters of religious tolerance and an energetic repression of faction were called, offered their alliance to the Huguenots, but these, having formed themselves, by means of the Protestant Union, into a sort of republic within the kingdom, hesitated to accept. It is, however, easy to bring about an understanding between people in whom religious fury has been extinguished either by patriotism or by ambition, like that of the duke of Alençon, who had now escaped from the Louvre where he had been confined on account of his intrigues. The compact was concluded at Millau; Condé becoming a Protestant once more in order to treat with Damville, Montmorency's brother. Henry of Navarre escaped from Paris. The new king, Henry III., vacillating and vicious, and Catherine herself, eager for war as she was, had no means of separating the Protestants and the *politiques*. Despite the victory of Guise at Dormans, the agreement between the duke of Alençon and John Casimir's German army obliged the royal party to grant all that the allied forces demanded of them

Fifth War.

Henry III. (1574-1589).

in the "peace of Monsieur," signed at Beaulieu on the 6th of May 1576, the duke of Alençon receiving the appanage of Anjou, Touraine and Berry, the king of Navarre Guienne, and Condé Picardy, while the Protestants were granted freedom of worship in all parts of the kingdom except Paris, the rehabilitation of Coligny and the other victims of St Bartholomew, their fortified towns, and an equal number of seats in the courts of the parlements.

This was going too fast; and in consequence of a reaction against this too liberal edict a fourth party made its appearance, that of the Catholic League, under the Guises—Henry le Balafré, duke of Guise, and his two brothers, Charles, duke of Mayenne, and Louis, archbishop of Reims and cardinal. With the object of destroying Calvinism by effective opposition, they imitated the Protestant organization of provincial associations, drawing their chief supporters from the upper middle class and the lesser nobility. It was not at first a demagogy maddened by the preaching of the irreconcilable clergy of Paris, but a union of the more honest and prudent classes of the nation in order to combat heresy. Despite the immorality and impotence of Henry III. and the Protestantism of Henry of Navarre, this party talked of re-establishing the authority of the king; but in reality it inclined more to the Guises, martyrs in the good cause, who were supported by Philip II. of Spain and Pope Gregory XIII. A sort of popular government was thus established to counteract the incapacity of royalty, and it was in the name of the imperilled rights of the people that, from the States of Blois onward, this Holy League demanded the re-establishment of Catholic unity, and set the religious right of the nation in opposition to the divine right of incapable or evil-doing kings (1576).

In order to oust his rival Henry of Guise, Henry III. made a desperate effort to outbid him in the eyes of the more extreme Catholics, and by declaring himself head of the League degraded himself into a party leader. The League, furious at this stroke of policy, tried to impose a council of thirty-six advisers upon the king. But the deputies of the third estate did not support the other two orders, and the latter in their turn refused the king money for making war on the heretics, desiring, they said, not war but the destruction of heresy. This would have reduced Henry III. to impotence; fortunately for him, however, the break of the Huguenots with the "Malcontents," and the divisions in the court of Navarre and in the various parties at La Rochelle, allowed Henry III., after two little wars in the south west, during which fighting gradually degenerated into brigandage, to sign terms of peace at Bergerac (1577), which much diminished the concessions made in the edict of Beaulieu. This peace was confirmed three years after by that of Fleix. The suppression of both the leagues was stipulated for (1580). It remained, however, a question whether the Holy League would submit to this.

The death of the duke of Anjou after his mad endeavour to establish himself in the Netherlands (1584), and the accession of Henry of Navarre, heir to the effeminate Henry III., reversed the situations of the two parties: the Protestants again became supporters of the principle of heredity and divine right; the Catholics appealed to right of election and the sovereignty of the people. Could the crown of the eldest daughter of the Church be allowed to devolve upon a relapsed heretic? Such was the doctrine officially preached in pulpit and pamphlet. But between Philip II. on the one hand—now master of Portugal and delivered from William of Orange, involved in strife with the English Protestants, and desirous of avenging the injuries inflicted upon him by the Valois in the Netherlands—and the Guises on the other hand, whose cousin Mary Stuart was a prisoner of Queen Elizabeth, there was a common interest in supporting one another and pressing things forward. A definite agreement was made between them at Joinville (December 31, 1584), the religious and popular pretext being the danger of leaving the

kingdom to the king of Navarre, and the ostensible end to secure the succession to a Catholic prince, the old Cardinal de Bourbon, an ambitious and violent man of mean intelligence; while the secret aim was to secure the crown for the Guises, who had already attempted to fabricate for themselves a genealogy tracing their descent from Charlemagne. In the meantime Philip II., being rid of Don John of Austria, whose ambition he dreaded, was to crush the Protestants of England and the Netherlands; and the double result of the compact at Joinville was to allow French politics to be controlled by Spain, and to transform the wars of religion into a purely political quarrel.

The pretensions of the Guises were, in fact, soon manifested in the declaration of Péronne (March 30, 1585) against the foul court of the Valois; they were again manifested in a furious agitation, fomented, by the secret council of the League at Paris, which favoured the Guises, and which now worked on the people through their terror of Protestant retaliations and the Church's peril. Incited by Philip II., who wished to see him earning his pension of 600,000 golden crowns, Henry of Guise began the war in the end of April, and in a few days the whole kingdom was on fire. The situation was awkward for Henry III., who had not the courage to ask Queen Elizabeth for the soldiers and money that he lacked. The crafty king of Navarre being unwilling to alienate the Protestants save by an apostasy profitable to himself, Henry III., by the treaty of Nemours (July 7, 1585), granted everything to the head of the League in order to save his crown. By a stroke of the pen he suppressed Protestantism, while Pope Sixtus V., who had at first been unfavourable to the treaty of Joinville as a purely political act, though he eventually yielded to the solicitations of the League, excommunicated the two Bourbons, Henry and Condé. But the duke of Guise's audacity did not make Henry III. forget his desire for vengeance. He hoped to ruin him by attaching him to his cause. His favourite Joyeuse was to defeat the king of Navarre, whose forces were very weak, while Guise was to deal with the strong reinforcement of Germans that Elizabeth was sending to Henry of Navarre. Exactly the contrary happened. By the defeat of Joyeuse at Coutras Henry III. found himself wounded on his strongest side; and by Henry of Guise's successes at Vimory and Auneau the Germans, who should have been his best auxiliaries against the League, were crushed (October-November 1587).

The League now thought they had no longer anything to fear. Despite the king's hostility the duke of Guise came to Paris, urged thereto by Philip II., who wanted to occupy Paris and be master of the Channel coasts whilst he launched his invincible Armada to avenge the death of Mary Stuart in 1587. On the Day of the Barricades (May 12, 1588) Henry III. was besieged in the Louvre by the populace in revolt; but his rival dared not go so far as to depose the king, and appeased the tumult. The king, having succeeded in taking refuge at Chartres, ended, however, by granting him in the Act of Union all that he had refused in face of the barricades—the post of lieutenant-general of the kingdom and the proscription of Protestantism. At the second assembly of the states of Blois, called together on account of the need for money (1588), all of Henry III.'s enemies who were elected showed themselves even bolder than in 1576 in claiming the control of the financial administration of the kingdom; but the destruction of the Armada gave Henry III., already exasperated by the insults he had received, new vigour. He had the old Cardinal de Bourbon imprisoned, and Henry of Guise and his brother the cardinal assassinated (December 23, 1588). On the 5th of January, 1589, died his mother, Catherine de' Medici, the astute Florentine.

"Now I am king!" cried Henry III. But Paris being dominated by the duke of Mayenne, who had escaped assassination, and by the council of "Sixteen," the chiefs of the League, most of the provinces replied by open revolt, and Henry III.

Peace of Monsieur (1576).

The Catholic League.

The States of Blois (1576).

Sixth War and peace of Bergerac (1577). Seventh War and peace of Fleix (1580).

Union between the Guises and Philip II.

The committee of Sixteen at Paris.

Eighth war of the three Henries.

Day of the Barricades.

Assassination of the Guises at the second states-general of Blois.

had no alternative but an alliance with Henry of Navarre.

Thanks to this he was on the point of seizing Paris, when in his turn he was assassinated on the 1st of August 1589 by a Jacobin monk, Jacques Clément; with his dying breath he designated the king of Navarre as his successor.

Between the popular League and the menace of the Protestants it was a question whether the new monarch was to be powerless in his turn. Henry IV. had almost the whole of his kingdom to conquer. The Cardinal de Bourbon, king according to the League and proclaimed under the title of Charles X., could count upon the Holy League itself, upon the Spaniards of the Netherlands, and upon the pope. Henry IV. was only supported by a certain number of the Calvinists and by the Catholic minority of the *Politiques*, who, however, gradually induced the rest of the nation to rally round the only legitimate prince. The nation wished for the establishment of internal unity through religious tolerance and the extinction of private organizations; it looked for the extension of France's external power through the abasement of the house of Spain, protection of the Protestants in the Netherlands and Germany, and independence of Rome. Henry IV., moreover, was forced to take an oath at the camp of Saint Cloud to associate the nation in the affairs of the kingdom by means of the states-general. These three conditions were interdependent; and Henry IV., with his persuasive manners, his frank and charming character, and his personal valour, seemed capable of keeping them all three.

The first thing for this soldier-king to do was to conquer his kingdom and maintain its unity. He did not waste time by withdrawing towards the south; he kept in the neighbourhood of Paris, on the banks of the Seine, within reach of help from Elizabeth; and twice—at Arques and at Ivry (1589-1590)—he vanquished the duke of Mayenne, lieutenant-general of the League. But after having tried to seize Paris (as later Rouen) by a *coup-de-main*, he was obliged to raise the siege in view of reinforcements sent to Mayenne by the duke of Parma. Pope Gregory XIV., an enthusiastic supporter of the League and a strong adherent of Spain, having succeeded Sixtus V., who had been very lukewarm towards the League, made Henry IV.'s position still more serious just at the moment when, the old Cardinal de Bourbon having died, Philip II. wanted to be declared the protector of the kingdom in order that he might dismember it, and when Charles Emmanuel of Savoy, a grandson of Francis I., and Charles III., duke of Lorraine, a son-in-law of Henry II., were both of them claiming the crown. Fortunately, however, the Sixteen had disgusted the upper bourgeoisie by their demagogic airs; while their open alliance with Philip II., and their acceptance of a Spanish garrison in Paris had offended the patriotism of the *Politiques* or moderate members of the League. Mayenne, who oscillated between Philip II. and Henry IV., was himself obliged to break up and subdue this party of fanatics and theologians (December 1591). This game of see-saw between the *Politiques* and the League furthered his secret ambition, but also the dissolution of the kingdom; and the pressure of public opinion, which desired an effective monarchy, put an end to this temporizing policy and caused the convocation of the states-general in Paris (December 1592). Philip II., through the duke of Feria's instrumentality, demanded the throne for his daughter Isabella, grand-daughter of Henry II. through her mother. But who was to be her husband? The archduke Ernest of Austria, Guise or Mayenne? The parlement cut short these bargainings by condemning all ultramontane pretensions and Spanish intrigues. The unpopularity of Spain, patriotism, the greater predominance of national questions in public opinion, and weariness of both religious disputation and indecisive warfare, all these sentiments were expressed in the wise and clever pamphlet entitled the *Satire Ménippée*. What had been a slow movement between 1585 and 1592 was quickened by Henry IV.'s abjuration of Protestantism at Saint-Denis on the 23rd of July 1593.

States-general of 1592.

The coronation of the king at Chartres in February 1594 completed the rout of the League. The parlement of Paris declared against Mayenne, who was simply the mouth-piece of Spain, and Brissac, the governor, surrendered the capital to the king. The example of Paris and Henry IV.'s clemency rallied round him all prudent Catholics, like Villeroy and Jeannin, anxious for national unity; but he had to buy over the adherents of the League, who sold him his own kingdom for sixty million francs. The pontifical absolution of September 17, 1595, finally stultified the League, which had been again betrayed by the unsuccessful plot of Jean Chastel, the Jesuit's pupil.

Nothing was now left but to expel the Spaniards, who under cover of religion had worked for their own interests alone. Despite the brilliant charge of Fontaine-Française in Burgundy (June 5, 1595), and the submission of the heads of the League, Guise, Mayenne, Joyeuse, and Mercœur, the years 1595-1597 were not fortunate for Henry IV.'s armies. Indignant at his conversion, Elizabeth, the Germans, and the Swiss Protestants deserted him; while the taking of Amiens by the Spaniards compromised for the moment the future both of the king and the country. But exhaustion of each other, by which only England and Holland profited, brought about the Peace of Vervins. This confirmed the results of the treaty of Cateau-Cambrésis (May 2, 1598), that is to say, the decadence of Spanish power, and its inability either to conquer or to dismember France.

The League, having now no reason for existence, was dissolved; but the Protestant party remained very strong, with its political organization and the fortified places which the assemblies of Millau, Nîmes and La Rochelle (1573-1574) had established in the south and the west. It was a republican state within the kingdom, and, being unwilling to break with it, Henry IV. came to terms by the edict of Nantes, on the 13th of April 1598. This was a compromise between the royal government and the Huguenot government, the latter giving up the question of public worship, which was only authorized where it had existed before 1597 and in two towns of each *bailliage*, with the exception of Paris; but it secured liberty of conscience throughout the kingdom, state payment for its ministers, admission to all employments, and courts composed equally of Catholics and Protestants in the parlements. An authorization to hold synods and political assemblies, to open schools, and to occupy a hundred strong places for eight years at the expense of the king, assured to the Protestants not only rights but privileges. In no other country did they enjoy so many guarantees against a return of persecution. This explains why the edict of Nantes was not registered without some difficulty.

Thus the blood-stained 16th century closed with a promise of religious toleration and a dream of international arbitration. This was the end of the long tragedy of civil strife and of wars of conquest, mingled with the sound of madrigals and psalms and pavaues. It had been the golden age of the arquebus and the viol, of sculptors and musicians, of poets and humanists, of fratricidal conflicts and of love-songs, of *mignons* and martyrs. At the close of this troubled century peace descends upon exhausted passions; and amidst the choir of young and ardent voices celebrating the national reconciliation, the tocsin no longer sounds its sinister and persistent bass. Despite the leagues of either faith, religious liberty was now confirmed by the more free and generous spirit of Henry IV.

Why was this king at once so easygoing and so capricious? Why, again, had the effort and authority of feudal and popular resistance been squandered in the follies of the League and to further the ambitions of the rebellious Guises? Why had the monarchy been forced to purchase the obedience of the upper classes and the provinces with immunities which enfeebled it without limiting it? At all events, when the kingdom had been reconquered from the Spaniards and religious strife ended, in order to fulfil his engagements, Henry IV. need only have

Assassination of Henry III.

The Bourbons.

Henry IV. (1589-1610).

Abjuration of Henry IV., July 23, 1593.

Peace of Vervins.

Edict of Nantes, 1598.

Results of the religious wars.

associated the nation with himself in the work of reconstructing the shattered monarchy. But during the atrocious holocausts formidable states had grown up around France, observing her and threatening her; and on the other hand, as on the morrow of the Hundred Years' War, the lassitude of the country, the lack of political feeling on the part of the upper classes and their selfishness, led to a fresh abdication of the nation's rights. The need of living caused the neglect of that necessity for control which had been maintained by the states-general from 1560 to 1593. And this time, moderation on the part of the monarchy no longer made for success. Of the two contrary currents which have continually mingled and conflicted throughout the course of French history, that of monarchic absolutism and that of aristocratic and democratic liberty, the former was now to carry all before it.

The kingdom was now issuing from thirty-eight years of civil war. Its inhabitants had grown unaccustomed to work; its finances were ruined by dishonesty, disorder, and a very heavy foreign debt. The most characteristic symptom of this distress was the brigandage carried on incessantly from 1598 to 1610. Side by side with this temporary disorder there was a more serious administrative disorganization, a habit of no longer obeying the king. The harassed population, the municipalities which under cover of civil war had resumed the right of self-government, and the parlements elated with their social importance and their security of position, were not alone in abandoning duty and obedience. Two powers faced each other threateningly: the organized and malcontent Protestants; and the provincial governors, all great personages possessing an armed following, theoretically agents of the king, but practically independent. The Montmorencys, the D'Épernons, the Birons, the Guises, were accustomed to consider their offices as hereditary property. Not that these two powers entered into open revolt against the king; but they had adopted the custom of recriminating, of threatening, of coming to understandings with the foreign powers, which with some of them, like Marshal Biron, the D'Entragues and the duc de Bouillon, amounted to conspiracy (1602-1606).

As to the qualifications of the king: he had had the good fortune not to be educated for the throne. Without much learning and sceptical in religious matters, he had the lively intelligence of the Gascon, more subtle than profound, more brilliant than steady. Married to a woman of loose morals, and afterwards to a devout Italian, he was gross and vulgar in his appetites and pleasures. He had retained all the habits of a country gentleman of his native Béarn, careless, familiar, boastful, thrifty, cunning, combined since his sojourn at the court of the Valois with a taint of corruption. He worked little but rapidly, with none of the bureaucratic pedantry of a Philip II. cloistered in the dark towers of the Escorial. Essentially a man of action and a soldier, he preserved his tone of command after he had reached the throne, the inflexibility of the military chief, the conviction of his absolute right to be master. Power quickly intoxicated him, and his monarchy was therefore anything but parliamentary. His personality was everything, institutions nothing. If, at the gathering of the notables at Rouen in 1596, Henry IV. spoke of putting himself in tutelage, that was but preliminary to a demand for money. The states-general, called together ten times in the 16th century, and at the death of Henry III. under promise of convocation, were never assembled. To put his absolute right beyond all control he based it upon religion, and to this sceptic disobedience became a heresy. He tried to make the clergy into an instrument of government by recalling the Jesuits, who had been driven away in 1594, partly from fear of their regicides, partly because they have always been the best teachers of servitude; and he gave the youth of the nation into the hands of this cosmopolitan and ultramontane clerical order. His government was personal, not through departments; he retained the old council though reducing its members; and his ministers, taken from every party, were never—not even Sully—anything more than mere clerks, without independent position,

mere instruments of his good pleasure. Fortunately this was not always capricious.

Henry IV. soon realized that his most urgent duty was to resuscitate the corpse of France. Pilfering was suppressed, and the revolts of the malcontents—the *Gauthiers* of Normandy, the *Croquants* and *Tard-avisés* of Périgord and Limousin—were quelled, adroitly at first, and later with a sterner hand. He then provided for the security of the country districts, and reduced the taxes on the peasants, the most efficacious means of making them productive and able to pay. Inspired by Barthélemy de Laffémas (1545-1612), controller-general of commerce, and by Olivier de Serres (1539-1619),¹ Henry IV. encouraged the culture of silk, though without much result, had orchards planted and marshes drained; while though he permitted the free circulation of wine and corn, this depended on the harvests. But the twofold effect of civil war—the ruin of the farmers and the scarcity and high price of rural labour—was only reduced arbitrarily and by fits and starts.

Despite the influence of Sully, a convinced agrarian because of his horror of luxury and love of economy, Henry IV. likewise attempted amelioration in the towns, where the state of affairs was even worse than in the country. But the edict of 1597, far from inaugurating individual liberty, was but a fresh edition of that of 1581, a second preface to the legislation of Colbert, and in other ways no better respected than the first. As for the new features, the syndical courts proposed by Laffémas, they were not even put into practice. Various industries, nevertheless, concurrent with those of England, Spain and Italy, were created or reorganized: silk-weaving, printing, tapestry, &c. Sully at least provided renesant manufacture with the roads necessary for communication and planted them with trees. In external commerce Laffémas and Henry IV. were equally the precursors of Colbert, freeing raw material and prohibiting the import of products similar to those manufactured within the kingdom. Without regaining that preponderance in the Levant which had been secured after the victory of Lepanto and before the civil wars, Marseilles still took an honourable place there, confirmed by the renewal in 1604 of the capitulations of Francis I. with the sultan. Finally, the system of commercial companies, antipathetic to the French bourgeoisie, was for the first time practised on a grand scale; but Sully never understood that movement of colonial expansion, begun by Henry II. in Brazil and continued in Canada by Champlain, which had so marvellously enlarged the European horizon. His point of view was altogether more limited than that of Henry IV.; and he did not foresee, like Elizabeth, that the future would belong to the peoples whose national energy took that line of action.

His sphere was essentially the superintendence of finance, to which he brought the same enthusiasm that he had shown in fighting the League. Vain and imaginative, his reputation was enormously enhanced by his "Économies royales"; he was no innovator, and being a true representative of the nation at that period, like it he was but lukewarm towards reform, accepting it always against the grain. He was not a financier of genius; but he administered the public moneys with the same probity and exactitude which he used in managing his own, retrieving alienated property, straightening accounts, balancing expenditure and receipts, and amassing a reserve in the Bastille. He did not reform the system of *aides* and *tailles* established by Louis XI. in 1482; but by charging much upon indirect taxation, and slightly lessening the burden of direct taxation, he avoided an appeal to the states-general and gave an illusion of relief.

Nevertheless, economic disasters, political circumstances and the personal government of Henry IV. (precursor in this also

¹ Olivier de Serres, sieur de Pradel, spent most of his life on his model farm at Pradel. In 1599 he dedicated a pamphlet on the cultivation of silk to Henry IV., and in 1600 published his *Théâtre d'agriculture et ménage des champs*, which passed through nineteen editions up to 1675.

of Louis XIV.) rendered his task impossible or fatal. The nobility remained in debt and disaffected; and the clergy, more remarkable for wealth and breeding than for virtues, were won over to the ultramontane ideas of the triumphant Jesuits. The rich bourgeoisie began more and more to monopolize the magistracy; and though the country-people were somewhat relieved from the burden which had been crushing them, the working-classes remained impoverished, owing to the increase of prices which followed at a distance the rise of wages. Moreover, under insinuating and crafty pretexts, Henry IV. undermined as far as he could the right of control by the states-general, the right of remonstrance by the parlements, and the communal franchises, while ensuring the impoverishment of the municipalities by his fiscal methods. Arbitrary taxation, scandalous intervention in elections, forced candidatures, confusion in their financial administration, bankruptcy and revolt on the part of the tenants: all formed an anticipation of the personal rule of Richelieu and Louis XIV.

Thus Henry IV. evinced very great activity in restoring order and very great poverty of invention in his methods. His sole original creation, the edict of La Paulette in 1604, was disastrous. In consideration of an annual payment of one-sixtieth of the salary, it made hereditary offices which had hitherto been held only for life; and the millions which it daily poured into the royal exchequer removed the necessity for seeking more regular and better distributed resources. Political liberty and social justice were equally the losers by this extreme financial measure, which paved the way for a catastrophe.

In foreign affairs the abasement of the house of Austria remained for Henry IV., as it had been for Francis I. and Henry II., a political necessity, while under his successors it was to become a mechanical obsession. The peace of Vervins had concluded nothing. The difference concerning the marquisate of Saluzzo, which the duke of Savoy had seized upon in 1588, profiting by Henry III.'s embarrassments, is only worth mentioning because the treaty of Lyons (1601) finally dissipated the Italian mirage, and because, in exchange for the last of France's possessions beyond the Alps, it added to the royal domain the really French territory of La Bresse, Bugey, Valromey and the district of Gex. The great external affair of the reign was the projected war upon which Henry IV. was about to embark when he was assassinated. The "grand design" of Sully, the organization of a "Christian Republic" of the European nations for the preservation of peace, was but the invention of an irresponsible minister, soured by defeat and wishing to impress posterity. Henry IV., the least visionary of kings, was between 1598 and 1610 really hesitating between two great contradictory political schemes: the war clamoured for by the Protestants, politicians like Sully, and the nobility; and the Spanish alliance, to be cemented by marriages, and preached by the ultramontane Spanish camarilla formed by the queen, Père Cotton, the king's confessor, the minister Villeroy, and Ubaldini, the papal nuncio. Selfish and suspicious, Henry IV. consistently played this double game of policy in conjunction with president Jeannin. By his alliance with the Grisons (1603) he guaranteed the integrity of the Valtellina, the natural approach to Lombardy for the imperial forces; and by his intimate union with Geneva he controlled the routes by which the Spaniards could reach their hereditary possessions in Franche-Comté and the Low Countries from Italy. But having defeated the duke of Savoy he had no hesitation in making sure of him by a marriage; though the Swiss might have misunderstood the treaty of Brusol (1610) by which he gave one of his daughters to the grandson of Philip II. On the other hand he astonished the Protestant world by the imprudence of his mediation between Spain and the rebellious United Provinces (1609). When the succession of Cleves and of Jülich, so long expected and already discounted by the treaty of Halle (1610), was opened up in Germany, the great war was largely due to an access of senile passion for the charms of the

princesse de Condé. The stroke of Ravaillac's knife caused a timely descent of the curtain upon this new and tragi-comic Trojan War. Thus, here as elsewhere, we see a vacillating hand-to-mouth policy, at the mercy of a passion for power or for sensual gratification. The *Cornette blanche* of Arques, the *Poule au pôt* of the peasant, successes as a lover and a dashing spirit, have combined to surround Henry IV. with a halo of romance not justified by fact.

The extreme instability of monarchical government showed itself afresh after Henry IV.'s death. The reign of Louis XIII., a perpetual regency by women, priests, and favourites, was indeed a curious prelude to the grand age of the French monarchy. The eldest son of Henry IV. being a minor, Marie de' Medici induced the parlement to invest her with the regency, thanks to Villeroy and contrary to the last will of Henry IV. This second Florentine, at once jealous of power and incapable of exercising it, bore little resemblance to her predecessor. Light-minded, haughty, apathetic and cold-hearted, she took a sort of passionate delight in changing Henry IV.'s whole system of government. Who would support her in this? On one side were the former ministers, Sillery and president Jeannin, ex-leaguers but loyalists, no lovers of Spain and still less of Germany; on the other the princes of the blood and the great nobles, Condé, Guise, Mayenne and Nevers, apparently still much more faithful to French ideas, but in reality convinced that the days of kings were over and that their own had arrived. Instead of weakening this aristocratic agitation by the see-saw policy of Catherine de' Medici, Marie could invent no other device than to despoil the royal treasure by distributing places and money to the chiefs of both parties. The savings all expended and Sully fallen into disgrace, she lost her influence and became the almost unconscious instrument of an ambitious man of low birth, the Florentine Concini, who was to drag her down with him in his fall; petty shifts became thenceforward the order of the day.

Thus Villeroy thought fit to add still further to the price already paid to triumphant Madrid and Vienna by disbanding the army, breaking the treaty of Brusol, and abandoning the Protestant princes beyond the Rhine and the trans-Pyrenean Moriscos. France joined hands with Spain in the marriages of Louis XIII. with Anne of Austria and Princess Elizabeth with the son of Philip III., and the Spanish ambassador was admitted to the secret council of the queen. To soothe the irritation of England the duc de Bouillon was sent to London to offer the hand of the king's sister to the prince of Wales. Meanwhile, however, still more was ceded to the princes than to the kings; and after a pretence of drawing the sword against the prince of Condé, rebellious through jealousy of the Italian surroundings of the queen-mother, recourse was had to the purse. The peace of Sainte Menehould, four years after the death of Henry IV., was a virtual abdication of the monarchy (May 1614); it was time for a move in the other direction. Villeroy inspired the regent with the idea of an armed expedition, accompanied by the little king, into the West. The convocation of the states-general was about to take place, wrung, as in all minorities, from the royal weakness—this time by Condé; so the elections were influenced in the monarchist interest. The king's majority, solemnly proclaimed on the 28th of October 1614, further strengthened the throne; while owing to the bungling of the third estate, who did not contrive to gain the support of the clergy and the nobility by some sort of concessions, the states-general, the last until 1789, proved like the others a mere historic episode, an impotent and inorganic expedient. In vain Condé tried to play with the parlement of Paris the same game as with the states-general, in a sort of anticipation of the Fronde. Villeroy demurred; and the parlement, having illegally assumed a political rôle, broke with Condé and effected a reconciliation with the court. After this double victory Marie de' Medici could at last undertake the famous journey to Bordeaux and consummate the Spanish marriages. In order not to countenance by his presence an act which had been the pretext for his opposition, Condé rebelled

Criticism of Henry IV.'s achievement.

Edict of La Paulette.

Foreign policy of Henry IV.

The regency of Marie de' Medici.

Louis XIII. (1610-1643).

once more in August 1615; but he was again pacified by the governorships and pensions of the peace of Loudun (May 1616).

But Villeroy and the other ministers knew not how to reap the full advantage of their victory. They had but one desire,

to put themselves on a good footing again with Condé, instead of applying themselves honestly to the service of the king. The "marshals," Concini and his wife

Leonora Galigai, more influential with the queen and more exacting than ever, by dint of clever intrigues forced the ministers to retire one after another; and with the last of Henry IV.'s "greybeards" vanished also all the pecuniary reserves left. Concini surrounded himself with new men, insignificant persons ready to do his bidding, such as Barbin or Mangot, while in the background was Richelieu, bishop of Luçon. Condé now began intrigues with the princes whom he had previously betrayed; but his pride dissolved in piteous entreaties when Thémènes, captain of the guard, arrested him in September 1616. Six months later Concini had not even time to protest when another captain, Vitry, slew him at the Louvre, under orders from Louis XIII., on the 24th of April 1617.

Richelieu had appeared behind Marie de' Medici; Albert de Luynes rose behind Louis XIII., the neglected child whom he had contrived to amuse. "The tavern remained the same, having changed nothing but the bush." De Luynes was made a duke and marshal in Concini's place, with no better title; while the duc d'Épernon, supported by the queen-mother (now in disgrace at Blois), took Condé's place at the head of the opposition. The treaties of Angoulême and Angers (1619-1620), negotiated by Richelieu, recalled the "unwholesome" treaties of Sainte-Menehould and Loudun. The revolt of the Protestants was more serious. Goaded by the vigorous revival of militant Catholicism which marked the opening of the 17th century, de Luynes tried to put a finishing touch to the triumph of Catholicism in France, which he had assisted, by abandoning in the treaty of Ulm the defence of the small German states against the ambition of the ruling house of Austria, and by sacrificing the Protestant Grisons to Spain. The re-establishment of Catholic worship in Béarn was the pretext for a rising among the Protestants, who had remained loyal during these troublous years; and although the military organization of French Protestantism, arranged by the assembly of La Rochelle, had been checked in 1621, by the defection of most of the reformed nobles, like Bouillon and Lesdiguières, de Luynes had to raise the disastrous siege of Montauban. Death alone saved him from the disgrace suffered by his predecessors (December 15, 1621).

From 1621 to 1624 Marie de' Medici, re-established in credit, prosecuted her intrigues; and in three years there were three different ministries: de Luynes was succeeded by the prince de Condé, whose Montauban was found at Montpellier; the Brûlarts succeeded Condé, and having, like de Luynes, neglected France's foreign interests, they had to give place to La Vieuville; while this latter was arrested in his turn for having sacrificed the interests of the English Catholics in the negotiations regarding the marriage of Henrietta of France with the prince of Wales. All these personages were undistinguished figures beyond whom might be discerned the cold clear-cut profile of Marie de' Medici's secretary, now a cardinal, who was to take the helm and act as viceroy during eighteen years.

Richelieu came into power at a lucky moment. Every one was sick of government by deputy; they desired a strong hand and an energetic foreign policy, after the defeat of the Czechs at the White Mountain by the house of Austria, the Spanish intrigues in the Valtellina, and the resumption of war between Spain and Holland.

Richelieu contrived to raise hope in the minds of all. As president of the clergy at the states-general of 1614 he had figured as an adherent of Spain and the ultramontane interest; he appeared to be a representative of that religious party which was identical with the Spanish party. But he had also been put into the ministry by the party of the *Politiques*, who had

terminated the civil wars, acclaimed Henry IV., applauded the Protestant alliance, and by the mouth of Miron, president of the third estate, had in 1614 proclaimed its intention to take up the national tradition once more. Despite the concessions necessary at the outset to the partisans of a Catholic alliance, it was the programme of the *Politiques* that Richelieu adopted and laid down with a master's hand in his Political Testament.

To realize it he had to maintain his position. This was very difficult with a king who "wished to be governed and yet was impatient at being governed." Incapable of applying himself to great affairs, but of sane and even acute judgment, Louis XIII. excelled only in a passion for detail and for manual pastimes. He realized the superior qualities of his minister, though with a lively sense of his own dignity he often wished him more discreet and less imperious; he had confidence in him but did not love him. Cold-hearted and formal by nature, he had not even self-love, detested his wife Anne of Austria—too good a Spaniard—and only attached himself fitfully to his favourites, male or female, who were naturally jealously suspected by the cardinal. He was accustomed to listen to his mother, who detested Richelieu as her ungrateful protégé. Neither did he love his brother, Gaston of Orleans, and the feeling was mutual; for the latter, remaining for twenty years heir-presumptive to a crown which he could neither defend nor seize, posed as the beloved prince in all the conspiracies against Richelieu, and issued from them each time as a Judas. Add to this that Louis XIII., like Richelieu himself, had wretched health, aggravated by the extravagant medicines of the day; and it is easy to understand how this pliable disposition which offered itself to the yoke caused Richelieu always to fear that his king might change his master, and to declare that "the four square feet of the king's cabinet had been more difficult for him to conquer than all the battlefields of Europe."

Richelieu, therefore, passed his time in safeguarding himself from his rivals and in spying upon them; his suspicious nature, rendered still more irritable by his painful practice of a dissimulation repugnant to his headstrong character, making him fancy himself threatened more than was actually the case. He brutally suppressed six great plots, several of which were scandalous, and had more than fifty persons executed; and he identified himself with the king, sincerely believing that he was maintaining the royal authority and not merely his own. He had a preference for irregular measures rather than legal prosecutions, and a jealousy of all opinions save his own. He maintained his power through the fear of torture and of special commissions. It was Louis XIII. whose cold decree ordained most of the rigorous sentences, but the stain of blood rested on the cardinal's robe and made his reasons of state pass for private vengeance. Chalais was beheaded at Nantes in 1626 for having upheld Gaston of Orleans in his refusal to wed Mademoiselle de Montpensier, and Marshal d'Ornano died at Vincennes for having given him bad advice in this matter; while the duellist de Boutteville was put to the torture for having braved the edict against duels. The royal family itself was not free from his attacks; after the Day of Dupes (1630) he allowed the queen-mother to die in exile, and publicly dishonoured the king's brother Gaston of Orleans by the publication of his confessions; Marshal de Marillac was put to the torture for his ingratitude, and the constable de Montmorency for rebellion (1632). The birth of Louis XIV. in 1638 confirmed Richelieu in power. However, at the point of death he roused himself to order the execution of the king's favourite, Cinq-Mars, and his friend de Thou, guilty of treason with Spain (1642).

Absolute authority was not in itself sufficient; much money was also needed. In his state-papers Richelieu has shown that at the outset he desired that the Huguenots should share no longer in public affairs, that the nobles should cease to behave as rebellious subjects, and the powerful provincial governors as suzerains over the lands committed to their charge. With his passion for the uniform and the useful on a grand scale, he hoped by means of the Code

**Concini,
Marshal
d'Ancres.**

**Louis XIII.
and
Richelieu.**

**Return of
Marie de'
Medici.**

**Cardinal
Richelieu
1624-
1642.**

**Financial
policy of
Richelieu.**

Michaud to put an end to the sale of offices, to lighten imposts, to suppress brigandage, to reduce the monasteries, &c. To do this it would have been necessary to make peace, for it was soon evident that war was incompatible with these reforms. He chose war, as did his Spanish rival and contemporary Olivares. War is expensive sport; but Richelieu maintained a lofty attitude towards finance, disdained figures, and abandoned all petty details to subordinate officials like D'Effiat or Bullion. He therefore soon reverted to the old and worse measures, including the debasement of coinage, and put an extreme tension on all the springs of the financial system. The land-tax was doubled and trebled by war, by the pensions of the nobles, by an extortion the profits of which Richelieu disdained neither for himself nor for his family; and just when the richer and more powerful classes had been freed from taxes, causing the wholesale oppression of the poorer, these few remaining were jointly and severally answerable. Perquisites, offices, forced loans were multiplied to such a point that a critic of the times, Guy Patin, facetiously declared that duties were to be exacted from the beggars basking in the sun. Richelieu went so far as to make poverty systematic and use famine as a means of government. This was the price paid for the national victories.

Thus he procured money at all costs, with an extremely crude fiscal judgment which ended by exasperating the people; hence numerous insurrections of the poverty-stricken; Dijon rose in revolt against the *aides* in 1630, Provence against the tax-officers (*élus*) in 1631, Paris and Lyons in 1632, and Bordeaux against the increase of customs in 1635. In 1636 the *Croquants* ravaged Limousin, Poitou, Angoumois, Gascony and Périgord; in 1639 it needed an army to subdue the *Va-nu-pieds* (bare-feet) in Normandy. Even the *rentiers* of the Hôtel-de-Ville, big and little, usually very peaceable folk, were excited by the curtailment of their incomes, and in 1639 and 1642 were roused to fury.

Every one had to bend before this harsh genius, who insisted on uniformity in obedience. After the feudal vassals, decimated

by the wars of religion and the executioner's hand, and after the recalcitrant taxpayers, the Protestants, in their turn, and by their own fault, experienced this.

While Richelieu was opposing the designs of the pope and of the Spaniards in the Valtellina, while he was arming the duke of Savoy and subsidizing Mansfeld in Germany, Henri, duc de Rohan, and his brother Benjamin de Rohan, duc de Soubise, the Protestant chiefs, took the initiative in a fresh revolt despite the majority of their party (1625). This Huguenot rising, in stirring up which Spanish diplomacy had its share, was a revolt of discontented and ambitious individuals who trusted for success to their compact organization and the ultimate assistance of England. Under pressure of this new danger and urged on by the Catholic *dévôts*, supported by the influence of Pope Urban VIII., Richelieu concluded with Spain the treaty of Monzon (March 5, 1626), by which the interests of his allies Venice, Savoy and the Grisons were sacrificed without their being consulted. The Catholic Valtellina, freed from the claims of the Protestant Grisons, became an independent state under the joint protection of France and Spain; the question of the right of passage was left open, to trouble France during the campaigns that followed; but the immediate gain, so far as Richelieu was concerned, was that his hands were freed to deal with the Huguenots.

Soubise had begun the revolt (January 1625) by seizing Port Blavet in Brittany, with the royal squadron that lay there, and in command of the ships thus acquired, combined with those of La Rochelle, he ranged the western coast, intercepting commerce. In September, however, Montmorency succeeded, with a fleet of English and Dutch ships manned by English seamen, in defeating Soubise, who took refuge in England. La Rochelle was now invested, the Huguenots were hard pressed also on land, and, but for the reluctance of the Dutch to allow their ships to be used for such a purpose, an end might have been made of the Protestant opposition in France; as it was, Richelieu was forced to accept the mediation of England and conclude a treaty with the Huguenots (February 1626).

He was far, however, from forgiving them for their attitude or being reconciled to their power. So long as they retained their compact organization in France he could undertake no successful action abroad, and the treaty was in effect no more than a truce that was badly observed. The oppression of the French Protestants was but one of the pretexts for the English expedition under James I.'s favourite, the duke of Buckingham, to La Rochelle in 1627; and, in the end, this intervention of a foreign power compromised their cause. When at last the citizens of the great Huguenot stronghold, caught between two dangers, chose what seemed to them the least and threw in their lot with the English, they definitely proclaimed their attitude as anti-national; and when, on the 29th of October 1628, after a heroic resistance, the city surrendered to the French king, this was hailed not as a victory for Catholicism only, but for France. The taking of La Rochelle was a crushing blow to the Huguenots, and the desperate alliance which Rohan, entrenched in the Cévennes, entered into with Philip IV. of Spain, could not prolong their resistance. The amnesty of Alais, prudent and moderate in religious matters, gave back to the Protestants their common rights within the body politic. Unfortunately what was an end for Richelieu was but a first step for the Catholic party.

The little Protestant group eliminated, Richelieu next wished to establish Catholic religious uniformity; for though in France the Catholic Church was the state church, unity did not exist in it. There were no fixed principles in the relations between king and church, hence incessant conflicts between Gallicans and Ultramontanes, in which Richelieu claimed to hold an even balance. Moreover, a Catholic movement for religious reform in the Church of France began during the 17th century, marked by the creation of seminaries, the foundation of new orthodox religious orders, and the organization of public relief by Saint Vincent de Paul. Jansenism was the most vigorous contemporary effort to renovate not only morals but Church doctrine (see JANSENISM). But Richelieu had no love for innovators, and showed this very plainly to du Vergier de Hauranne, abbot of Saint Cyran, who was imprisoned at Vincennes for the good of Church and State. In affairs of intellect dragooning was equally the policy; and, as Corneille learnt to his cost, the French Academy was created in 1635 simply to secure in the republic of letters the same unity and conformity to rules that was enforced in the state.

Before Richelieu, there had been no effective monarchy and no institutions for controlling affairs; merely advisory institutions which collaborated somewhat vaguely in the administration of the kingdom. Had the king been willing these might have developed further; but Richelieu ruthlessly suppressed all such growth, and they remained embryonic. According to him, the king must decide in secret, and the king's will must be law. No one might meddle in political affairs, neither parlements nor states-general; still less had the public any right to judge the actions of the government. Between 1631 and the edict of February 1641 Richelieu strove against the continually renewed opposition of the parlements to his system of special commissions and judgments; in 1641 he refused them any right of interference in state affairs; at most would he consent occasionally to take counsel with assemblies of notables. Provincial and municipal liberties were no better treated when through them the king's subjects attempted to break loose from the iron ring of the royal commissaries and intendants. In Burgundy, Dijon saw her municipal liberties restricted in 1631; the provincial assembly of Dauphiné was suppressed from 1628 onward, and that of Languedoc in 1629; that of Provence was in 1639 replaced by communal assemblies, and that of Normandy was prorogued from 1639 to 1642. Not that Richelieu was hostile to them in principle; but he was obliged at all hazards to find money for the upkeep of the army, and the provincial states were a slow and heavy machine to put in motion. Through an excessive reaction against the disintegration that had menaced the kingdom after the dissolution of the League, he fell into the abuse of

Peace of Alais, 1629.

Richelieu and the Catholics.

Destruction of public spirit.

over-centralization; and depriving the people of the habit of criticizing governmental action, he taught them a fatal acquiescence in uncontrolled and undisputed authority. Like one of those physical forces which tend to reduce everything to a dead level, he battered down alike characters and fortresses; and in his endeavours to abolish faction, he killed that public spirit which, formed in the 16th century, had already produced the *République* of Bodin, de Thou's *History of his Times*, La Boetie's *Contre un*, the *Satire Ménippée*, and Sully's *Économies royales*.

In order to establish this absolute despotism Richelieu created no new instruments, but made use of a revolutionary institution of the 16th century, namely "intendants" (*q.v.*), agents who were forerunners of the commissaries of the Convention, gentlemen of the long robe of inferior condition, hated by every one, and for that reason the more trustworthy. He also drew most of the members of his special commissions from the grand council, a supreme administrative tribunal which owed all its influence to him.

However, having accomplished all these great things, the treasury was left empty and the reforms were but ill-established; for Richelieu's policy increased poverty, neglected the toiling and suffering peasants, deserted the cause of the workers in order to favour the privileged classes, and left idle and useless that bourgeoisie whose intellectual activity, spirit of discipline, and civil and political culture would have yielded solid support to a monarchy all the stronger for being limited. Richelieu completed the work of Francis I.; he endowed France with the fatal tradition of autocracy. This priest by education and by turn of mind was indifferent to material interests, which were secondary in his eyes; he could organize neither finance, nor justice, nor an army, nor the colonies, but at the most a system of police. His method was not to reform, but to crush. He was great chiefly in negotiation, the art *par excellence* of ecclesiastics. His work was entirely abroad; there it had more continuity, more future, perhaps because only in his foreign policy was he unhampered in his designs. He sacrificed everything to it; but he ennobled it by the genius and audacity of his conceptions, by the energetic tension of all the muscles of the body politic.

The Thirty Years' War in fact dominated all Richelieu's foreign policy; by it he made France and unmade Germany.

It was the support of Germany which Philip II. had lacked in order to realize his Catholic empire; and the election of the archduke Ferdinand II. of Styria as emperor gave that support to his Spanish cousins (1619). Thenceforward all the forces of the Habsburg monarchy would be united, provided that communication could be maintained in the north with the Netherlands and in the south with the duchy of Milan, so that there should be no flaw in the iron vice which locked France in on either side. It was therefore of the highest importance to France that she should dominate the valleys of the Alps and Rhine. As soon as Richelieu became minister in 1624 there was an end to cordial relations with Spain. He resumed the policy of Henry IV., confining his military operations to the region of the Alps, and contenting himself at first with opposing the coalition of the Habsburgs with a coalition of Venice, the Turks, Bethlen Gabor, king of Hungary, and the Protestants of Germany and Denmark. But the revolts of the French Protestants, the resentment of the nobles at his dictatorial power, and the perpetual ferment of intrigues and treason in the court, obliged him almost immediately to draw back. During these eight years, however, Richelieu had pressed on matters as fast as possible.

While James I. of England was trying to get a general on the cheap in Denmark to defend his son-in-law, the elector palatine,

Richelieu was bargaining with the Spaniards in the treaty of Monzon (March 1626); but as the strained relations between France and England forced him to conciliate Spain still further by the treaty of April 1627, the Spaniards profited by this to carry on an intrigue with Rohan, and in concert with the duke of Savoy, to occupy Montferrat when the death of Vincenzo II.

(December 26, 1627) left the succession of Mantua, under the will of the late duke, to Charles Gonzaga, duke of Nevers, a Frenchman by education and sympathy. But the taking of La Rochelle allowed Louis to force the pass of Susa, to induce the duke of Savoy to treat with him, and to isolate the Spaniards in Italy by a great Italian league between Genoa, Venice and the dukes of Savoy and Mantua (April 1629). Unlike the Valois, Richelieu only desired to free Italy from Spain in order to restore her independence.

The fact that the French Protestants in the Cévennes were again in arms enabled the Habsburgs and the Spaniards to make a fresh attack upon the Alpine passes; but after the peace of Alais Richelieu placed himself at the head of forty thousand men, and stirred up enemies everywhere against the emperor, victorious now over the king of Denmark as in 1621 over the elector palatine. He united Sweden, now reconciled with Poland, and the Catholic and Protestant electors, disquieted by the edict of Restitution and the omnipotence of Wallenstein; and he aroused the United Provinces. But the disaffection of the court and the more extreme Catholics made it impossible for him as yet to enter upon a struggle against both Austria and Spain; he was only able to regulate the affairs of Italy with much prudence. The intervention of Mazarin, despatched by the pope, who saw no other means of detaching Italy from Spain than by introducing France into the affair, brought about the signature of the armistice of Rivalte on the 4th of September 1630, soon developed into the peace of Cherasco, which re-established the agreement with the still fugitive duke of Savoy (June 1631). Under the harsh tyranny of Spain, Italy was now nothing but a lifeless corpse; young vigorous Germany was better worth saving. So Richelieu's envoys, Brulart de Léon and Father Joseph, disarmed¹ the emperor at the diet of Regensburg, while at the same time Louis XIII. kept Casale and Pinerolo, the gates of the Alps. Lastly, by the treaty of Fontainebleau (May 30th, 1631), Maximilian of Bavaria, the head of the Catholic League, engaged to defend the king of France against all his enemies, even Spain, with the exception of the emperor. Thus by the hand of Richelieu a union against Austrian imperialism was effected between the Bavarian Catholics and the Protestants who dominated in central and northern Germany.

Twice had Richelieu, by means of the purse and not by force of arms, succeeded in reopening the passes of the Alps and of the Rhine. The kingdom at peace and the Huguenot party ruined, he was now able to engage upon his policy of prudent acquisitions and apparently disinterested alliances. But Gustavus Adolphus, king of Sweden, called in by Richelieu and Venice to take the place of the played-out king of Denmark, brought danger to all parties. He would not be content merely to serve French interests in Germany, according to the terms of the secret treaty of Bärwalde (June 1631); but, once master of Germany and the rich valley of the Rhine, considered chiefly the interests of Protestantism and Sweden. Neither the prayers nor the threats of Richelieu, who wished indeed to destroy Spain but not Catholicism, nor the death of Gustavus Adolphus at Lützen (1632), could repair the evils caused by this immoderate ambition. A violent Catholic reaction against the Protestants ensued; and the union of Spain and the Empire was consolidated just when that of the Protestants was dissolved at Nördlingen, despite the efforts of Oxenstierna (September 1634). Moreover, Wallenstein, who had been urged by Richelieu to set up an independent kingdom in Bohemia, had been killed on the 23rd of February 1634. In the course of a year Württemberg and Franconia were reconquered from the Swedes; and the duke of Lorraine, who had taken the side of the Empire, called in the Spanish and the imperial forces to open the road to the Netherlands through Franche-Comté.

His allies no longer able to stand alone, Richelieu was obliged to intervene directly (May 19th, 1635). By the treaty of Saint-Germain-en-Laye he purchased the army of Bernard of Saxe-

¹ Ferdinand is reported to have said: "Le capucin m'a désarmé avec son scapulaire et a mis dans capuchon six bonnets électoraux."

Methods employed by Richelieu.

The results.

External policy of Richelieu.

Richelieu and Gustavus Adolphus.

Temporary policy, except in Italy, 1624-1630.

Weimar; by that of Rivoli he united against Spain the dukes of Modena, Parma and Mantua; he signed an open alliance with the league of Heilbronn, the United Provinces and Sweden; and after these alliances military operations began, Marshal de la Force occupying the duchy of Lorraine. Richelieu attempted to operate simultaneously in the Netherlands by joining hands with the Dutch, and on the Rhine by uniting with the Swedes; but the bad organization of the French armies, the double invasion of the Spaniards as far as Corbie and the imperial forces as far as the gates of Saint-Jean-de-Losne (1636), and the death of his allies, the dukes of Hesse-Cassel, Savoy and Mantua at first frustrated his efforts. A decided success was, however, achieved between 1638 and 1640, thanks to Bernard of Saxe-Weimar and afterwards to Guébriant, and to the parallel action of the Swedish generals, Banér, Wrangel and Torstensson. Richelieu obtained Alsace, Breisach and the forest-towns on the Rhine; while in the north, thanks to the Dutch and owing to the conquest of Artois, marshals de la Meilleraye, de Châtillon and de Brézé forced the barrier of the Netherlands. Turin, the capital of Piedmont, was taken by Henri de Lorraine, comte d'Harcourt; the alliance with rebellious Portugal facilitated the occupation of Roussillon and almost the whole of Catalonia, and Spain was reduced to defending herself; while the embarrassments of the Habsburgs at Madrid made those of Vienna more tractable. The diet of Regensburg, under the mediation of Maximilian of Bavaria, decided in favour of peace with France, and on the 25th of December 1641 the preliminary settlement at Hamburg fixed the opening of negotiations to take place at Münster and Osnabrück. Richelieu's death (December 4, 1642) prevented him from seeing the triumph of his policy, but it can be judged by its results; in 1624 the kingdom had in the east only the frontier of the Meuse to defend it from invasion; in 1642 the whole of Alsace, except Strassburg, was occupied and the Rhine guarded by the army of Guébriant. Six months later, on the 14th of May 1643, Louis XIII. rejoined his minister in his true kingdom, the land of shades.

But thanks to Mazarin, who completed his work, France gathered in the harvest sown by Richelieu. At the outset no one believed that the new cardinal would have any success. Every one expected from Anne of Austria a change in the government which appeared to be justified by the persecutions of Richelieu and the disdainful unscrupulousness of Louis XIII. On the 16th of May the queen took the little four-year-old Louis XIV. to the parlement of Paris which, proud of playing a part in politics, hastened, contrary to Louis XIII.'s last will, to acknowledge the command of the little king, and to give his mother "free, absolute and entire authority." The great nobles were already looking upon themselves as established in power, when they learnt with amazement that the regent had appointed as her chief adviser, not Gaston of Orleans, but Mazarin. The political revenge which in their eyes was owing to them as a body, the queen claimed for herself alone, and she made it a romantic one. This Spaniard of waning charms, who had been neglected by her husband and insulted by Richelieu, now gave her indolent and full-blown person, together with absolute power, into the hands of the Sicilian. Whilst others were triumphing openly, Mazarin, in the shadow and silence of the interregnum, had kept watch upon the heart of the queen; and when the old party of Marie de' Medici and Anne of Austria wished to come back into power, to impose a general peace, and to substitute for the Protestant alliances an understanding with Spain, the arrest of François de Vendôme, duke of Beaufort, and the exile of other important nobles proved to the great families that their hour had gone by (September 1643).

Mazarin justified Richelieu's confidence and the favour of Anne of Austria. It was upon his foreign policy that he relied to maintain his authority within the kingdom. Thanks to him, the duke of Enghien (Louis de Bourbon, afterwards prince of Condé), appointed commander-in-chief at the age of twenty-two, caused the downfall of the renowned Spanish infantry at

Rocroi; and he discovered Turenne, whose prudence tempered Condé's overbold ideas. It was he too who by renewing the traditional alliances and resuming against Bavaria, Ferdinand III.'s most powerful ally, the plan of common action with Sweden which Richelieu had sketched out, pursued it year after year: in 1644 at Freiburg im Breisgau, despite the death of Guébriant at Rottweil; in 1645 at Nördlingen, despite the defeat of Marienthal; and in 1646 in Bavaria, despite the rebellion of the Weimar cavalry; to see it finally triumph at Zusmarshausen in May 1648. With Turenne dominating the Eiser and the Inn, Condé victorious at Lens, and the Swedes before the gates of Prague, the emperor, left without a single ally, finally authorized his plenipotentiaries to sign on the 24th of October 1648 the peace about which negotiations had been going on for seven years. Mazarin had stood his ground notwithstanding the treachery of the duke of Bavaria, the defection of the United Provinces, the resistance of the Germans, and the general confusion which was already pervading the internal affairs of the kingdom.

The dream of the Habsburgs was shattered. They had wished to set up a centralized empire, Catholic and German; but the treaties of Westphalia kept Germany in its passive and fragmentary condition; while the Catholic and Protestant princes obtained formal recognition of their territorial independence and their religious equality. Thus disappeared the two principles which justified the Empire's existence; the universal sovereignty to which it laid claim was limited simply to a German monarchy much crippled in its powers; and the enfranchisement of the Lutherans and Calvinists from papal jurisdiction cut the last tie which bound the Empire to Rome. The victors' material benefits were no less substantial: the congress of Münster ratified the final cession of the Three Bishoprics and the conquest of Alsace, and Breisach and Philippsburg completed these acquisitions. The Spaniards had no longer any hope of adding Luxemburg to their Franche-Comté; while the Holy Roman Empire in Germany, taken in the rear by Sweden (now mistress of the Baltic and the North Sea), cut off for good from the United Provinces and the Swiss cantons, and enfeebled by the recognized right of intervention in German affairs on the part of Sweden and France, was now nothing but a meaningless name.

Mazarin had not been so fortunate in Italy, where in 1642 the Spanish remained masters. Venice, the duchy of Milan and the duke of Modena were on his side; the pope and the grand-duke of Tuscany were trembling, but the romantic expedition of the duke of Guise to Naples, and the outbreak of the Fronde, saved Spain, who had refused to take part in the treaties of Westphalia and whose ruin Mazarin wished to compass.

It was, however, easier for Mazarin to remodel the map of Europe than to govern France. There he found himself face to face with all the difficulties that Richelieu had neglected to solve, and that were now once more giving trouble. The *Lit de Justice* of the 18th of May 1643 had proved authority to remain still so personal an affair that the person of the king, insignificant though that was, continued to be regarded as its absolute depository. Thus regular obedience to an abstract principle was under Mazarin as incomprehensible to the idle and selfish nobility as it had been under Richelieu. The parlement still kept up the same extra-judicial pretensions; but beyond its judicial functions it acted merely as a kind of town-crier to the monarchy, charged with making known the king's edicts. Yet through its right of remonstrance it was the only body that could legally and publicly intervene in politics; a large and independent body, moreover, which had its own demands to make upon the monarchy and its ministers. Richelieu, by setting his special agents above the legal but complicated machinery of financial administration, had so corrupted it as to necessitate radical reform; all the more so because financial charges had been increased to a point far beyond what the nation could bear. With four armies to keep up, the insurrection in Portugal to maintain, and pensions to serve the needs of the allies, the burden had become a crushing one.

Treaties of Westphalia.

State of the kingdom.

Mazarin, 1643-1661.

The French Thirty Years' War.

Richelieu had been able to surmount these difficulties because he governed in the name of a king of full age, and against isolated adversaries; while Mazarin had the latter against him in a coalition which had lasted ten years, with the further disadvantages of his foreign origin and a royal minority at a time when every one was sick of government by ministers. He was the very opposite of Richelieu, as wheedling in his ways as the other had been haughty and scornful, as devoid of vanity and rancour as Richelieu had been full of jealous care for his authority; he was gentle where the other had been passionate and irritable, with an intelligence as great and more supple, and a far more grasping nature.

It was the fiscal question that arrayed against Mazarin a coalition of all petty interests and frustrated ambitions; this was always the Achilles' heel of the French monarchy, which in 1648 was at the last extremity for money. All imposts were forestalled, and every expedient for obtaining either direct or indirect taxes had been exhausted by the methods of the financiers. As the country districts could yield nothing more, it became necessary to demand money from the Parisians and from the citizens of the various towns, and to search out and furbish up old disused edicts—edicts as to measures and scales of prices—at the very moment when the luxury and corruption of the *parvenus* was insulting the poverty and suffering of the people, and exasperating all those officials who took their functions seriously.

A storm burst forth in the parlement against Mazarin as the patron of these expedients, the occasion for this being the edict of redemption by which the government renewed for nine years the "Paulette" which had now expired, by withholding four years' salary from all officers of the Great Council, of the *Chambres des comptes*, and of the *Cour des aides*. The parlement, although expressly exempted, associated itself with their protest by the decree of union of May 13, 1648, and deliberations in a body upon the reform of the state. Despite the queen's express prohibition, the insurrectionary assembly of the *Chambre Saint Louis* criticized the whole financial system, founded as it was upon usury, claimed the right of voting taxes, respect for individual liberty, and the suppression of the intendants, who were a menace to the new bureaucratic feudalism. The queen, haughty and exasperated though she was, yielded for the time being, because the invasion of the Spaniards in the north, the arrest of Charles I. of England, and the insurrection of Masaniello at Naples made the moment a critical one for monarchies; but immediately after the victory at Lens she attempted a *coup d'état*, arresting the leaders, and among them Broussel, a popular member of the parlement (August 26, 1648). Paris at once rose in revolt—a Paris of swarming and unpoliced streets, that had been making French history ever since the reign of Henry IV., and that had not forgotten the barricades of the League. Once more a pretence of yielding had to be made, until Condé's arrival enabled the court to take refuge at Saint-Germain (January 15, 1649).

Civil war now began against the rebellious coalition of great nobles, lawyers of the parlement, populace, and mercenaries just set free from the Thirty Years' War. It lasted four years, for motives often as futile as the Grande Mademoiselle's ambition to wed little Louis XIV., Cardinal de Retz's red hat, or Madame de Longueville's stool at the queen's side; it was, as its name of *Fronde* indicates, a hateful farce, played by grown-up children, in several acts.

Its first and shortest phase was the Fronde of the Parlement. At a period when all the world was a little mad, the parlement had imagined a loyalist revolt, and, though it raised an armed protest, this was not against the king but against Mazarin and the persons to whom he had delegated power. But the parlement soon became disgusted with its allies—the princes and nobles, who had only drawn their swords in order to beg more effectively with arms in their hands; and the Parisian mob, whose fanaticism had been aroused by Paul de Gondi, a warlike ecclesiastic, a Catiline in a cassock, who preached the gospel at the dagger's point.

When a suggestion was made to the parlement to receive an envoy from Spain, the members had no hesitation in making terms with the court by the peace of Rueil (March 11, 1649), which ended the first Fronde.

As an *entr'acte*, from April 1649 to January 1650, came the affair of the *Petits Maîtres*: Condé, proud and violent; Gaston of Orleans, pliable and contemptible; Conti, the simpleton; and Longueville, the betrayed husband. The victor of Lens and Charenton imagined that every one was under an obligation to him, and laid claim to a dictatorship so insupportable that Anne of Austria and Mazarin—assured by Gondi of the concurrence of the parlement and people—had him arrested. To defend Condé the great conspiracy of women was formed: Madame de Chevreuse, the subtle and impassioned princess palatine, and the princess of Condé vainly attempted to arouse Normandy, Burgundy and the mob of Bordeaux; while Turenne, bewitched by Madame de Longueville, allowed himself to become involved with Spain and was defeated at Rethel (December 15, 1650). Unfortunately, after his custom when victor, Mazarin forgot his promises—above all, Gondi's cardinal's hat. A union was effected between the two Frondes, that of the *Petits Maîtres* and that of the parlements, and Mazarin was obliged to flee for safety to the electorate of Cologne (February 1651), whence he continued to govern the queen and the kingdom by means of secret letters. But the heads of the two Frondes—Condé, now set free from prison at Havre, and Gondi who detested him—were not long in quarrelling fatally. Owing to Mazarin's exile and to the king's attainment of his majority (September 5, 1651) quiet was being restored, when the return of Mazarin, jealous of Anne of Austria, nearly brought about another reconciliation of all his opponents (January 1652). Condé resumed civil war with the support of Spain, because he was not given Mazarin's place; but though he defeated the royal army at Bléneau, he was surprised at Étampes, and nearly crushed by Turenne at the gate of Saint-Antoine. Saved, however, by the Grande Mademoiselle, daughter of Gaston of Orleans, he lost Paris by the disaster of the Hôtel de Ville July 4, 1652, where he had installed an insurrectionary government. A general weariness of civil war gave plenty of opportunity after this to the agents of Mazarin, who in order to facilitate peace made a pretence of exiling himself for a second time to Bouillon. Then came the final collapse: Condé having taken refuge in Spain for seven years, Gaston of Orleans being in exile, Retz in prison, and the parlement reduced to its judiciary functions only, the field was left open for Mazarin, who, four months after the king, re-entered in triumph that Paris which had driven him forth with jeers and mockery (February 1653).

The task was now to repair these four years of madness and folly. The nobles who had hoped to set up the League again, half counting upon the king of Spain, were held in check by Mazarin with the golden dowries of his numerous nieces, and were now employed by him in warfare and in decorative court functions; while others, De Retz and La Rochefoucauld, sought consolation in their Memoirs or their Maxims, one for his mortifications and the other for his rancour as a statesman out of employment. The parlement, which had confused political power with judiciary administration, was given to understand, in the session of April 13, 1655, at Vincennes, that the era of political manifestations was over; and the money expended by Gourville, Mazarin's agent, restored the members of the parlement to docility. The power of the state was confided to middle-class men, faithful servants during the evil days: Abel Servien, Michel le Tellier, Hugues de Lionne. Like Henry IV. after the League, Mazarin, after having conquered the Fronde, had to buy back bit by bit the kingdom he had lost, and, like Richelieu, he spread out a network of agents, thenceforward regular and permanent, who assured him of that security without which he could never have carried on his vast plunderings in peace and quiet. His imitator and superintendent, Fouquet, the Maecenas of the future Augustus, concealed this gambling policy beneath the lustre of the arts and the glamour of a literature remarkable for

Richelieu and Mazarin.

Financial difficulties.

Rebellion of the parlement.

The Fronde of the Princes.

The administration of Mazarin.

elevation of thought and vigour of style, and further characterized by the proud though somewhat restricted freedom conceded to men like Corneille, Descartes and Pascal, but soon to disappear.

It was also necessary to win back from Spain the territory which the Frondeurs had delivered up to her. Both countries,

War with Spain.

exhausted by twenty years of war, were incapable of bringing it to a successful termination, yet neither would be first to give in; Mazarin, therefore, disquieted by Condé's victory at Valenciennes (1656), reknit the bond of Protestant alliances, and, having nothing to expect from Holland, he deprived Spain of her alliance with Oliver Cromwell (March 23, 1657). A victory in the Dunes by Turenne, now reinstated in honour, and above all the conquest of the Flemish seaboard, were the results (June 1658); but when, in order to prevent the emperor's intervention in the Netherlands, Mazarin attempted, on the death of Ferdinand III., to wrest the Empire from the Habsburgs, he was foiled by the gold of the Spanish envoy Peñaranda (1657). When the abdication of Christina of Sweden caused a quarrel between Charles Gustavus of Sweden and John Casimir of Poland, by which the emperor and the elector of Brandenburg hoped to profit, Mazarin (August 15, 1658) leagued the Rhine princes against them; while at the same time the substitution of Pope Alexander VII. for Innocent X., and the marriage of Mazarin's two nieces with the duke of Modena and a prince of the house of Savoy, made Spain anxious about her Italian possessions. The suggestion of a marriage between Louis XIV. and a princess of Savoy

Peace of the Pyrenees.

decided Spain, now brought to bay, to accord him the hand of Maria Theresa as a chief condition of the peace of the Pyrenees (November 1659). Roussillon and Artois, with a line of strongholds constituting a formidable northern frontier, were ceded to France; and the acquisition of Alsace and Lorraine under certain conditions was ratified. Thus from this long duel between the two countries Spain issued much enfeebled, while France obtained the preponderance in Italy, Germany, and throughout northern Europe, as is proved by Mazarin's successful arbitration at Copenhagen and at Oliva (May-June 1660). That dream of Henry IV. and Richelieu, the ruin of Philip II.'s Catholic empire, was made a realized fact by Mazarin; but the clever engineer, dazzled by success, took the wrong road in national policy when he hoped to crown his work by the Spanish marriage.

The development of events had gradually enlarged the royal prerogative, and it now came to its full flower in the administrative monarchy of the 17th century. Of this system

Louis XIV. (1661-1715).

Louis XIV. was to be the chief exponent. His reign may be divided into two very distinct periods. The death of Colbert and the revocation of the edict of Nantes brought the first to a close (1661-1683-1685); coinciding with the date when the Revolution in England definitely reversed the traditional system of alliances, and when the administration began to disorganize. In the second period (1685-1715) all the germs of decadence were developed until the moment of final dissolution.

In a monarchy so essentially personal the preparation of the heir to the throne for his position should have been the chief

Education of Louis XIV.

task. Anne of Austria, a devoted but unintelligent mother, knew no method of dealing with her son, save devotion combined with the rod. His first preceptors were nothing but courtiers; and the most intelligent, his valet Laporte, developed in the royal child's mind his natural instinct of command, a very lively sense of his rank, and that nobly majestic air of master of the world which he preserved even in the commonest actions of his life. The continual agitations of the Fronde prevented him from persevering in any consistent application during those years which are the most valuable for study, and only instilled in him a horror of revolution, parliamentary remonstrance, and disorder of all kinds; so that this recollection determined the direction of his government. Mazarin, in his later years, at last taught him his trade as king by admitting him to the council, and by instructing him in the details of politics and of administration.

In 1661 Louis XIV. was a handsome youth of twenty-two, of splendid health and gentle serious mien; eager for pleasure, but discreet and even dissimulating; his rather mediocre intellectual qualities relieved by solid common sense; fully alive to his rights and his duties.

The duties he conscientiously fulfilled, but he considered he need render no account of them to any one but his Maker, the last humiliation for God's vicegerent being "to take the law from his people." In the solemn language of the "Memoirs for the Instruction of the Dauphin" he did but affirm the arbitrary and capricious character of his predecessors' action. As for his rights, Louis XIV. looked upon these as plenary and unlimited. Representative of God upon earth, heir to the sovereignty of the Roman emperors, a universal suzerain and master over the goods and the lives of his vassals, he could conceive no other bounds to his authority than his own interests or his obligations towards God, and in this he was a willing believer of Bossuet. He therefore had but two aims: to increase his power at home and to enlarge his kingdom abroad. The army and taxation were the chief instruments of his policy. Had not Bodin, Hobbes and Bossuet taught that the force which gives birth to kingdoms serves best also to feed and sustain them? His theory of the state, despite Grotius and Jurieu, rejected as odious and even impious the notion of any popular rights, anterior and superior to his own. A realist in principle, Louis XIV. was terribly utilitarian and egotistical in practice; and he exacted from his subjects an absolute, continual and obligatory self-abnegation before his public authority, even when improperly exercised.

His political ideas.

This deified monarch needed a new temple, and Versailles, where everything was his creation, both men and things, adored its maker. The highest nobility of France, beginning with the princes of the blood, competed for posts in the royal household, where an army of ten thousand soldiers, four thousand servants, and five thousand horses played its costly and luxurious part in the ordered and almost religious pageant of the king's existence. The "*anciennes cohues de France*," gay, familiar and military, gave place to a stilted court life, a perpetual adoration, a very ceremonious and very complicated ritual, in which the demigod "pontificated" even "in his dressing-gown." To pay court to himself was the first and only duty in the eyes of a proud and haughty prince who saw and noted everything, especially any one's absence. Versailles, where the delicate refinements of Italy and the grave politeness of Spain were fused and mingled with French vivacity, became the centre of national life and a model for foreign royalties; hence if Versailles has played a considerable part in the history of civilization, it also seriously modified the life of France. Etiquette and self-seeking became the chief rules of a courtier's life, and this explains the division of the nobility into two sections: the provincial squires, embittered by neglect; and the courtiers, who were ruined materially and intellectually by their way of living. Versailles sterilized all the idle upper classes, exploited the industrious classes by its extravagance, and more and more broke relations between king and kingdom.

The forms of Louis XIV.'s monarchy.

But however divine, the king could not wield his power unaided. Louis XIV. called to his assistance a hierarchy of humbly submissive functionaries, and councils over which he regularly presided. Holding the very name of *roi fainéant* in abhorrence, he abolished the office of mayor of the palace—that is to say, the prime minister—thus imposing upon himself work which he always regularly performed. In choosing his collaborators his principle was never to select nobles or ecclesiastics, but persons of inferior birth. Neither the immense fortunes amassed by these men, nor the venality and robust vitality which made their families veritable races of ministers, altered the fact that De Lionne, Le Tellier, Louvois and Colbert were in themselves of no account, even though the parts they played were much more important than Louis XIV. imagined. This was the age of plebeians, to the great indignation of the duke and peer Saint Simon. Mere

Louis XIV.'s ministers.

reflected lights, these satellites professed to share their master's horror of all individual and collective rights of such a nature as to impose any check upon his public authority. Louis XIV. detested the states-general and never convoked them, and the parlements were definitely reduced to silence in 1673; he completed the destruction of municipal liberties, under pretext of bad financial administration; suffered no public, still less private criticism; was ruthless when his exasperated subjects had recourse to force; and made the police the chief bulwark of his government. Prayers and resignation were the only solace left for the hardships endured by his subjects. All the ties of caste, class, corporation and family were severed; the jealous despotism of Louis XIV. destroyed every opportunity of taking common action; he isolated every man in private life, in individual interests, just as he isolated himself more and more from the body social. Freedom he tolerated for himself alone.

His passion for absolutism made him consider himself master of souls as well as bodies, and Bossuet did nothing to contravene an opinion which was, indeed, common to every sovereign of his day. Louis XIV., like Philip II., pretending to not only political but religious authority, would not allow the pope to share it, still less would he abide any religious dissent; and this gave rise to many conflicts, especially with the pope, at that time a temporal sovereign both at Rome and at Avignon, and as the head of Christendom bound to interfere in the affairs of France. Louis XIV.'s pride caused the first struggle, which turned exclusively upon questions of form, as in the affair of the Corsican Guard in 1662. The question of the right of *regale* (right of the Crown to the revenues of vacant abbeys and bishoprics), which touched the essential rights of sovereignty, further inflamed the hostility between Innocent XI. and Louis XIV. Conformably with the traditions of the administrative monarchy in 1673, the king wanted to extend to the new additions to the kingdom his rights of receiving the revenues of vacant bishoprics and making appointments to their benefices, including taking oaths of fidelity from the new incumbents. A protest raised by the bishops of Pamiers and Aleth, followed by the seizure of their revenues, provoked the intervention of Innocent XI. in 1678; but the king was supported by the general assembly of the clergy, which declared that, with certain exceptions, the *regale* extended over the whole kingdom (1681). The pope ignored the decisions of the assembly; so, dropping the *regale*, the king demanded that, to obviate further conflict, the assembly should define the limits of the authority due respectively to the king, the Church and the pope. This was the object of the Declaration of the Four

Articles: the pope has no power in temporal matters; general councils are superior to the pope in spiritual affairs; the rules of the Church of France are inviolable; decisions of the pope in matters of faith are only irrevocable by consent of the Church. The French laity transferred to the king this quasi-divine authority, which became the political theory of the *ancien régime*; and since the pope refused to submit, or to institute the new bishops, the Sorbonne was obliged to interfere. The affair of the "diplomatic prerogatives," when Louis XIV. was decidedly in the wrong, made relations even more strained (1687), and the idea of a schism was mooted with greater insistence than in 1681. The death of Innocent XI. in 1689 allowed Louis XIV. to engage upon negotiations rendered imperative by his check in the affair of the Cologne bishopric, where his candidate was ousted by the pope's. In 1693, under the pontificate of Innocent XII., he went, like so many others, to Canossa.

Recipient now of immense ecclesiastical revenues, which, owing to the number of vacant benefices, constituted a powerful engine of government, Louis XIV. had immense power over the French Church. Religion began to be identified with the state; and the king combated heresy and dissent, not only as a religious duty, but as a matter of political expediency, unity of faith being obviously conducive to unity of law.

Richelieu having deprived the Protestants of all political guarantees for their liberty of conscience, an anti-Protestant

party (directed by a cabal of religious devotees, the *Compagnie du Saint Sacrement*) determined to suppress it completely by conversions and by a jesuitical interpretation of the terms of the edict of Nantes. Louis XIV. made this impolitic policy his own. His passion for absolutism, a religious zeal that was the more active because it had to compensate for many affronts to public and private morals, the financial necessity of augmenting the free donations of the clergy, and the political necessity of relying upon that body in his conflicts with the pope, led the king between 1661 and 1685 to embark upon a double campaign of arbitrary proceedings with the object of nullifying the edict, conversions being procured either by force or by bribery. The promulgation and application of systematic measures from above had a response from below, from the corporation, the urban workshop, and the village street, which supported ecclesiastical and royal authority in its suppression of heresy, and frequently even went further: individual and local fanaticism co-operating with the head of the state, the *intendants*, and the military and judiciary authorities. Protestants were successively removed from the states-general, the consulates, the town councils, and even from the humblest municipal offices; they were deprived of the charge of their hospitals, their academies, their colleges and their schools, and were left to ignorance and poverty; while the intolerance of the clergy united with chicanery of procedure to invade their places of worship, insult their adherents, and put a stop to the practice of their ritual. Pellisson's methods of conversion, considered too slow, were accelerated by the violent persecution of Louvois and by the king's galleys, until the day came when Louis XIV., deceived by the clergy, crowned his record of complaisant legal methods by revoking the edict of Nantes. This was the signal for a Huguenot renaissance, and the Camisards of the Cévennes held the royal armies in check from 1703 to 1711. Notwithstanding this, however, Louis XIV. succeeded only too well, since Protestantism was reduced both numerically and intellectually. He never perceived how its loss threw France back a full century, to the great profit of foreign nations; while neither did the Church perceive that she had been firing on her own troops.

The same order of ideas produced the persecution of the Jansenists, as much a political as a religious sect. Founded by a bishop of Ypres on the doctrine of predestination, and growing by persecution, it had speedily recruited adherents among the disillusioned followers of the Fronde, the Gallican clergy, the higher nobility, even at court, and more important still, among learned men and thinkers, such as the great Arnauld, Pascal and Racine. Pure and austere, it enjoined the strictest morals in the midst of corruption, and the most dignified self-respect in face of idolatrous servility. Amid general silence it was a formidable and much dreaded body of opinion; and in order to stifle it Louis XIV., the tool of his confessor, the Jesuit Le Tellier, made use of his usual means. The nuns of Port Royal were in their turn subjected to persecution, which, after a truce between 1666 and 1679, became aggravated by the affair of the *regale*, the bishops of Aleth and Pamiers being Jansenists. Port Royal was destroyed, the nuns dispersed, and the ashes of the dead scattered to the four winds. The bull *Unigenitus* launched by Pope Clement XI. in 1713 against a Jansenist book by Father Quesnel rekindled a quarrel, the end of which Louis XIV. did not live to see, and which raged throughout the 18th century.

Bossuet, Louis XIV.'s mouthpiece, triumphed in his turn over the quietism of Madame Guyon, a mystic who recognized neither definite dogmas nor formal prayers, but abandoned herself "to the torrent of the forces of God." Fénelon, who in his *Maximes des Saints* had given his adherence to her doctrine, was obliged to submit in 1699; but Bossuet could not make the spirit of authority prevail against the religious criticism of a Richard Simon or the philosophical polemics of a Bayle. He might exile their persons; but their doctrines, supported by the

Royal despotism.

Louis XIV. and the Church.

Declaration of the Four Articles.

Louis XIV. and the Protestants.

Suppression of the edict of Nantes (1685).

Louis XIV. and the Jansenists.

Louis XIV. and the Libertins.

scientific and philosophic work of Newton and Leibnitz, were to triumph over Church and religion in the 18th century.

The chaos of the administrative system caused difficulties no less great than those produced by opinions and creeds. Traditional rights, differences of language, provincial autonomy, ecclesiastical assemblies, parlements, governors, intendants—vestiges of the past, or promises for the future—all jostled against and thwarted each other. The central authority had not yet acquired a vigorous constitution, nor destroyed all the intermediary authorities. Colbert now offered his aid in making Louis XIV. the sole pivot of public life, as he had already become the source of religious authority, thanks to the Jesuits and to Bossuet.

Colbert, an agent of Le Tellier, the honest steward of Mazarin's dishonest fortunes, had a future opened to him by the fall of Fouquet (1661). Harsh and rough, he compelled admiration for his delight in work, his aptitude in disentangling affairs, his desire of continually augmenting the wealth of the state, and his regard for the public welfare without forgetting his own. Born in a draper's shop, this great administrator always preserved its narrow horizon, its short-sighted imagination, its taste for detail, and the conceit of the parvenu; while with his insinuating ways, and knowing better than Fouquet how to keep his distance, he made himself indispensable by his *savoir-faire* and his readiness for every emergency. He gradually got everything into his control: finance, industry, commerce, the fine arts, the navy and colonies, the administration, even the fortifications, and—through his uncle Pussort—the law, with all the profits attaching to its offices.

His first care was to restore the exhausted resources of the country and to re-establish order in finance. He began by measures of liquidation: the *Chambre ardente* of 1661 to 1665 to deal with the farmers of the revenue, the condemnation of Fouquet, and a revision of the funds. Next, like a good man of business, Colbert determined that the state accounts should be kept as accurately as those of a shop; but though in this respect a great minister, he was less so in his manner of levying contributions. He kept to the old system of revenues from the demesne and from imposts that were reactionary in their effect, such as the *taille*, aids, salt-tax (*gabelle*) and customs; only he managed them better. His forest laws have remained a model. He demanded less of the *taille*, a direct impost, and more from indirect aids, of which he created the code—not, however, out of sympathy for the common people, towards whom he was very harsh, but because these aids covered a greater area and brought in larger returns. He tried to import more method into the very unequal distribution of taxation, less brutality in collection, less confusion in the fiscal machine, and more uniformity in the matter of rights; while he diminished the debts of the much-involved towns by putting them through the bankruptcy court. With revolutionary intentions as to reform, this only ended, after several years of normal budgets, in ultimate frustration. He could never make the rights over the drink traffic uniform and equal, nor restrict privileges in the matter of the *taille*; while he was soon much embarrassed, not only by the coalition of particular interests and local immunities, which made despotism acceptable by tempering it, but also by Louis XIV.'s two master-passions for conquest and for building. To his great chagrin he was obliged to begin borrowing again in 1672, and to have recourse to "*affaires extraordinaires*"; and this brought him at last to his grave.

Order was for Colbert the prime condition of work. He desired all France to set to work as he did "with a contented air and rubbing his hands for joy"; but neither general theories nor individual happiness preoccupied his attention. He made economy truly political: that is to say, the prosperity of industry and commerce afforded him no other interest than that of making the country wealthy and the state powerful. Louis XIV.'s aspirations towards glory chimed in very well with the extremely positive

views of his minister; but here too Colbert was an innovator and an unsuccessful one. He wanted to give 17th-century France the modern and industrial character which the New World had imprinted on the maritime states; and he created industry on a grand scale with an energy of labour, a prodigious genius for initiative and for organization; while, in order to attract a foreign clientèle, he imposed upon it the habits of meticulous probity common to a middle-class draper. But he maintained the legislation of the Valois, who placed industry in a state of strict dependency on finance, and he instituted a servitude of labour harder even than that of individuals; his great factories of soap, glass, lace, carpets and cloth had the same artificial life as that of contemporary Russian industry, created and nourished by the state. It was therefore necessary, in order to compensate for the fatal influence of servitude, that administrative protection should be lavished without end upon the royal manufactures; moreover, in the course of its development, industry on a grand scale encroached in many ways upon the resources of smaller industries. After Colbert's day, when the crutches lent by privilege were removed, his achievements lost vigour; industries that ministered to luxury alone escaped decay; the others became exhausted in struggling against the persistent and teasing opposition of the municipal bodies and the bourgeoisie—conceited, ignorant and terrified at any innovation—and against the blind and intolerant policy of Louis XIV.

Colbert, in common with all his century, believed that the true secret of commerce and the indisputable proof of a country's prosperity was to sell as many of the products of national industry to the foreigner as possible, while purchasing as little as possible. In order to do this, he sometimes figured as a free-trader and sometimes as a protectionist, but always in a practical sense; if he imposed prohibitive tariffs, in 1664 and 1667, he also opened the free ports of Marseilles and Dunkirk, and engineered the *Canal du midi*. But commerce, like industry, was made to rely only on the instigation of the state, by the intervention of officials; here, as throughout the national life, private initiative was kept in subjection and under suspicion. Once more Colbert failed; with regard to internal affairs, he was unable to unify weights and measures, or to suppress the many custom-houses which made France into a miniature Europe; nor could he in external affairs reform the consulates of the Levant. He did not understand that, in order to purge the body of the nation from its traditions of routine, it would be necessary to reawaken individual energy in France. He believed that the state, or rather the bureaucracy, might be the motive power of national activity.

His colonial and maritime policy was the newest and most fruitful part of his work. He wished to turn the eyes of contemporary adventurous France towards her distant interests, the wars of religion having diverted her attention from them to the great profit of English and Dutch merchants. Here too he had no preconceived ideas; the royal and monopolist companies were never for him an end but a means; and after much experimenting he at length attained success. In the course of twenty years he created many dependencies of France beyond sea. To her colonial empire in America he added the greater part of Santo Domingo, Tobago and Dominica; he restored Guiana; prepared for the acquisition of Louisiana by supporting Cavalier de la Salle; extended the suzerainty of the king on the coast of Africa from the Bay of Arguin to the shores of Sierra Leone, and instituted the first commercial relations with India. The population of the Antilles doubled; that of Canada quintupled; while if in 1672 at the time of the war with Holland Louis XIV. had listened to him, Colbert would have sacrificed his pride to the acquisition of the rich colonies of the Netherlands. In order to attach and defend these colonies Colbert created a navy which became his passion; he took convicts to man the galleys in the Mediterranean, and for the fleet in the Atlantic he established the system of naval reserve which still obtains. But, in the 18th century, the monarchy, hypnotized by the classical battle-fields

Colbert
and
commerce.

Colbert
and
finance.

Colbert
and the
colonies.

Colbert
and
industry.

of Flanders and Italy, madly squandered the fruits of Colbert's work as so much material for barter and exchange.

In the administration, the police and the law, Colbert preserved all the old machinery, including the inheritance of office. In the great codification of laws, made under the direction of his uncle Pussort, he set aside the parlement of Paris, and justice continued to be ill-administered and cruel. The police, instituted in 1667 by La Reynie, became a public force independent of magistrates and under the direct orders of the ministers, making the arbitrary royal and ministerial authority absolute by means of *lettres de cachet* (q.v.), which were very convenient for the government and very terrible for the individuals concerned.

Provincial administration was no longer modified; it was regularized. The intendant became the king's factotum, not purchasing his office but liable to dismissal, the government's confidential agent and the real repository of royal authority, the governor being only for show (see INTENDANT).

Colbert's system went on working regularly up to the year 1675; from that time forward he was cruelly embarrassed for money, and, seeking new sources of revenue, begged for subsidies from the assembly of the clergy. He did not succeed either in stemming the tide of expense, nor in his administration, being in no way in advance of his age, and not perceiving that decisive reform could not be achieved by a government dealing with the nation as though it were inert and passive material, made to obey and to pay. Like a good Cartesian he conceived of the state as an immense machine, every portion of which should receive its impulse from outside—that is from him, Colbert. Leibnitz had not yet taught that external movement is nothing, and inward spirit everything. As the minister of an ambitious and magnificent king, Colbert was under the hard necessity of sacrificing everything to the wars in Flanders and the pomp of Versailles—a gulf which swallowed up all the country's wealth;—and, amid a society which might be supposed submissively docile to the wishes of Louis XIV., he had to retain the most absurd financial laws, making the burden of taxation weigh heaviest on those who had no other resources than their labour, whilst landed property escaped free of charge. Habitual privation during one year in every three drove the peasants to revolt: in Boulonnais, the Pyrenees, Vivarais, in Guyenne from 1670 onwards and in Brittany in 1675. Cruel means of repression assisted natural hardships and the carelessness of the administration in depopulating and laying waste the countryside; while Louis XIV.'s martial and ostentatious policy was even more disastrous than pestilence and famine, when Louvois' advice prevailed in council over that of Colbert, now embittered and desperate. The revocation of the edict of Nantes vitiated through a fatal contradiction all the efforts of the latter to create new manufactures; the country was impoverished for the benefit of the foreigner to such a point that economic conditions began to alarm those private persons most noted for their talents, their character, or their regard for the public welfare; such as La Bruyère and Fénelon in 1692, Bois-Guillebert in 1697 and Vauban in 1707. The movement attracted even the ministers, Boulainvilliers at their head, who caused the intendants to make inquiry into the causes of this general ruin. There was a volume of attack upon Colbert; but as the fundamental system remained unchanged, because reform would have necessitated an attack upon privilege and even upon the constitution of the monarchy, the evil only went on increasing. The social condition of the time recalls that of present-day Morocco, in the high price of necessaries and the extortions of the financial authorities; every man was either soldier, beggar or smuggler.

Ruin of Colbert's work.

Under Pontchartrain, Chamillard and Desmarets, the expenses of the two wars of 1688 and 1701 attained to nearly five milliards. In order to cover this recourse was had as usual, not to remedies, but to palliatives worse than the evil: heavy usurious loans, debasement of the coinage, creation of stocks that were perpetually being converted, and ridiculous charges which the

bourgeois, sickened with officialdom, would endure no longer. Richelieu himself had hesitated to tax labour; Louis XIV. trod the trade organizations under foot. It was necessary to have recourse to revolutionary measures, to direct taxation, ignoring all class distinction. In 1695 the graduated poll-tax was a veritable *coup d'état* against privileged persons, who were equally brought under the tax; in 1710 was added the tithe (*dixième*), a tax upon income from all landed property. Money scarce, men too were lacking; the institution of the militia, the first germ of obligatory enlistment, was a no less important innovation. But these were only provisionary and desperate expedients, superposed upon the old routine, a further charge in addition to those already existing; and this entirely mechanical system, destructive of private initiative and the very sources of public life, worked with difficulty even in time of peace. As Louis XIV. made war continually the result was the same as in Spain under Philip II.: depopulation and bankruptcy within the kingdom and the coalitions of Europe without.

In 1660 France was predominant in Europe; but she aroused no jealousy except in the house of Habsburg, enfeebled and divided against itself. It was sufficient to remain faithful to the practical policy of Henry IV., of Richelieu and of Mazarin: that of moderation in strength. This Louis XIV. very soon altered, while yet claiming to continue it; he superseded it by one principle: that of replacing the proud tyranny of the Habsburgs of Spain by another. He claimed to lay down the law everywhere, in the preliminary negotiations between his ambassador and the Spanish ambassador in London, in the affair of the salute exacted from French vessels by the English, and in that of the Corsican guard in Rome; while he proposed to become the head of the crusade against the Turks in the Mediterranean as in Hungary.

The eclipse of the great idea of the balance of power in Europe was no sudden affair; the most flourishing years of the reign were still enlightened by it: witness the repurchase of Dunkirk from Charles II. in 1662, the cession of the duchies of Bar and of Lorraine and the war against Portugal. But soon the partial or total conquest of the Spanish inheritance proved "the grandeur of his beginnings and the meanness of his end." Like Philip the Fair and like Richelieu, Louis XIV. sought support for his external policy in that public opinion which in internal matters he held so cheap; and he found equally devoted auxiliaries in the jurists of his parlements.

It was thus that the first of his wars for the extension of frontiers began, the War of Devolution. On the death of his father-in-law, Philip IV. of Spain, he transferred into the realm of politics a civil custom of inheritance prevailing in Brabant, and laid claim to Flanders in the name of his wife Maria Theresa. The Anglo-Dutch War (1665-1667), in which he was by way of supporting the United Provinces without engaging his fleet, retarded this enterprise by a year. But after his mediation in the treaty of Breda (July 1667), when Hugues de Lionne, secretary of state for foreign affairs, had isolated Spain, he substituted soldiers for the jurists and cannon for diplomacy in the matter of the queen's rights.

The secretary of state for war, Michel le Tellier, had organized his army; and thanks to his great activity in reform, especially after the Fronde, Louis XIV. found himself in possession of an army that was well equipped, well clothed, well provisioned, and very different from the rabble of the Thirty Years' War, fitted out by dishonest jobbing contractors. Severe discipline, suppression of fraudulent interference, furnishing of clothes and equipment by the king, regulation of rank among the officers, systematic revictualling of the army, settled means of manufacturing and furnishing arms and ammunition, placing of the army under the direct authority of the king, abolition of great military charges, subordination of the governors of strongholds, control by the civil authority over the soldiers effected by means of paymasters and commissaries of stores; all this organization of the royal army was the work of le Tellier.

Recourse to revolutionary measures.

Foreign policy of Louis XIV.

War of Devolution, 1667.

His son, François Michel le Tellier, marquis de Louvois, had one sole merit, that of being his father's pupil. A *parvenu* of the middle classes, he was brutal in his treatment of the lower orders and a sycophant in his behaviour towards the powerful; prodigiously active, ill-obeyed—as was the custom—but much dreaded. From 1677 onwards he did but finish perfecting Louis XIV.'s army in accordance with the suggestions left by his father, and made no fundamental changes: neither the definite abandonment of the feudal *arrière-ban* and of recruiting—sources of disorder and insubordination—nor the creation of the militia, which allowed the nation to penetrate into all the ranks of the army, nor the adoption of the gun with the bayonet,—which was to become the *ultima ratio* of peoples as the cannon was that of sovereigns,—nor yet the uniform, intended to strengthen *esprit de corps*, were due to him. He maintained the institutions of the day, though seeking to diminish their abuse, and he perfected material details; but misfortune would have it that instead of remaining a great military administrator he flattered Louis XIV.'s megalomania, and thus caused his perdition.

Under his orders Turenne conquered Flanders (June-August 1667); and as the queen-mother of Spain would not give in,

Condé occupied Franche Comté in fourteen days (February 1668). But Europe rose up in wrath; the United Provinces and England, jealous and disquieted by this near neighbourhood, formed with Sweden the triple alliance of the Hague (January 1668), ostensibly to offer their mediation, though in reality to prevent the occupation of the Netherlands. Following the advice of Colbert and de Lionne, Louis XIV. appeared to accede, and by the treaty of Aix-la-Chapelle he preserved his conquests in Flanders (May 1668).

This peace was neither sufficient nor definite enough for Louis XIV.; and during four years he employed all his diplomacy to isolate the republic of the United Provinces in Europe, as he had done for Spain. He wanted to ruin this nation both in a military and an economic sense, in order to annex to French Flanders the rest of the Catholic Netherlands allotted to him by a secret treaty for partitioning the Spanish possessions, signed with his brother-in-law the emperor Leopold on the 10th of January 1668. Colbert—very envious of Holland's wealth—prepared the finances, le Tellier the army and de Lionne the alliances. In vain did the grand-

pensionary of the province of Holland, Jan de Witt, offer concessions of all kinds; both England, bound by the secret treaty of Dover (January 1670), and France had need of this war. Avoiding the Spanish Netherlands, Louis XIV. effected the passage of the Rhine in June 1672; and the disarmed United Provinces, which had on their side only Brandenburg and Spain, were occupied in a few days. The brothers de Witt, in consequence of their fresh offer to treat at any price, were assassinated; the broken dykes of Muiden arrested the victorious march of Condé and Turenne; while the popular and military party, directed by the stadtholder William of Orange, took the upper hand and preached resistance to the death. "The war is over," said the new secretary of state for foreign affairs, Arnauld de Pomponne; but Louvois and Louis XIV. said no. The latter wished not only to take possession of the Netherlands, which were to be given up to him with half of the United Provinces and their colonial empire; he wanted "to play the Charlemagne," to re-establish Catholicism in that country as Philip II. had formerly attempted to do, to occupy all the territory as far as the Lech, and to exact an annual oath of fealty. But the patriotism and the religious fanaticism of the Dutch revolted against this insupportable tyranny. Power had passed from the hands of the burghers of Amsterdam into those of William of Orange, who on the 30th

of August 1673, profiting by the arrest of the army brought about by the inundation and by the fears of Europe, joined in a coalition with the emperor, the king of Spain, the duke of Lorraine, many of the princes of the Empire, and with England, now at last enlightened as to the projects of Catholic restoration which Louis XIV. was

planning with Charles II. It was necessary to evacuate and then to settle with the United Provinces, and to turn against Spain. After fighting for five years against the whole of Europe by land and by sea, the efforts of Turenne, Condé and Duquesne culminated at Nijmegen in fresh acquisitions (1678). Spain had to cede to Louis XIV., Franche Comté, Dunkirk and half of Flanders. This was another natural and glorious result of the treaty of the Pyrenees. The Spanish monarchy was disarmed.

But Louis XIV. had already manifested that unmeasured and restless passion for glory, that claim to be the exclusive arbiter of western Europe, that blind and narrow insistence, which were to bear out his motto "*Seul contre tous*." Whilst all Europe was disarming he kept his troops, and used peace as a means of conquest. Under orders from Colbert de Croissy the jurists came upon the scene once more, and their unjust decrees were sustained by force of arms. The *Chambres de Réunion* sought for and joined to the kingdom those lands which were not actually dependent upon his new conquests, but which had formerly been so: such as Saarbrücken, Deux Ponts (Zweibrücken) and Montbéliard in 1680, Strassburg and Casale in 1681. The power of the house of Habsburg was paralysed by an invasion of the Turks, and Louis XIV. sent 35,000 men into Belgium; while Luxembourg was occupied by Créqui and Vauban. The truce of Ratisbon (Regensburg) imposed upon Spain completed the work of the peace of Nijmegen (1684); and thenceforward Louis XIV.'s terrified allies avoided his clutches while making ready to fight him.

This was the moment chosen by Louis XIV.'s implacable enemy, William of Orange, to resume the war. His surprise of Marshal Luxembourg near Mons, after the signature of the peace of Nijmegen, had proved that in his eyes war was the basis of his authority in Holland and in Europe. His sole arm of support amidst all his allies was not the English monarchy, sold to Louis XIV., but Protestant England, jealous of France and uneasy about her independence. Being the husband of the duke of York's daughter, he had an understanding in this country with Sunderland, Godolphin and Temple—a party whose success was retarded for several years by the intrigues of Shaftesbury. But Louis XIV. added mistake to mistake; and the revocation of the edict of Nantes added religious hatreds to political jealousies. At the same time the Catholic powers responded by the league of Augsburg (July 1686) to his policy of unlimited aggrandisement. The unsuccessful attempts of Louis XIV. to force his partisan Cardinal Wilhelm Egon von Fürstenberg (sec. FÜRSTENBERG: *House*) into the electoral see of Cologne; the bombardment of Genoa; the humiliation of the pope in Rome itself by the marquis de Lavardin; the seizure of the Huguenot emigrants at Mannheim, and their imprisonment at Vincennes under pretext of a plot, precipitated the conflict. The question of the succession in the Palatinate, where Louis XIV. supported the claims of his sister-in-law the duchess of Orleans, gave the signal for a general war. The French armies devastated the Palatinate instead of attacking William of Orange in the Netherlands, leaving him free to disembark at Torbay, usurp the throne of England, and construct the Grand Alliance of 1689.

Far from reserving all his forces for an important struggle elsewhere, foreshadowed by the approaching death of Charles II. of Spain, Louis XIV., isolated in his turn, committed the error of wasting it for a space of ten years in a war of conquest, by which he alienated all that remained to him of European sympathy. The French armies, notwithstanding the disappearance of Condé and Turenne, had still glorious days before them with Luxembourg at Fleurus, at Steenkirk and at Neerwinden (1690-1693), and with Catinat in Piedmont, at Staffarda, and at Marsaglia; but these successes alternated with reverses. Tourville's fleet, victorious at Beachy Head, came to grief at La Hogue (1692); and though the expeditions to Ireland in favour of James II. were unsuccessful, thanks to the Huguenot Schomberg, Jean Bart and Duguay-

Peace of Aix-la-Chapelle.

War with Holland.

Peace of Nijmegen.

Truce of Ratisbon.

William of Orange.

League of Augsburg.

War of the Grand Alliance.

Trouin ruined Anglo-Dutch maritime commerce. Louis XIV. assisted in person at the sieges of Mons and Namur, operations for which he had a liking, because, like Louvois, who died in 1691, he thought little of the French soldiery in the open field. After three years of strife, ruinous to both sides, he made the first overtures of peace, thus marking an epoch in his foreign policy; though William took no unfair advantage of this, remaining content with the restitution of places taken by the *Chambres de Réunion*, except Strassburg, with a frontier-line of fortified places for the Dutch, and with the official deposition of the Stuarts. But the treaty of Ryswick (1697) marked the condemnation of the policy pursued since that of Nijmegen. While signing this peace Louis XIV. was only thinking of the succession in Spain. By partitioning her in advance with the other strong powers, England and Holland, by means of the treaties of the Hague and of London (1698-1699),—as he had formerly done with the emperor in 1668,—he seemed at first to wish for a pacific solution of the eternal conflict between the Habsburgs and the Bourbons, and to restrict himself to the perfecting of his natural frontiers; but on the death of Charles II. of Spain (1700) he claimed everything in favour of his grandson, the duke of Anjou, now appointed universal heir, though risking the loss of all by once more letting himself fall into imprudent and provocative action in the dynastic interest.

English public opinion, desirous of peace, had forced William III. to recognize Philip V. of Spain; but Louis XIV.'s maintenance of the eventual right of his grandson to the crown of France, and the expulsion of the Dutch, who had not recognized Philip V., from the Barrier towns, brought about the Grand Alliance of 1701 between the maritime Powers and the court of Vienna, desirous of partitioning the inheritance of Charles II. The recognition of the Old Pretender as James III., king of England, was only a response to the Grand Alliance, but it drew the English Tories into an inevitable war. Despite the death of William III. (March 19, 1702) his policy triumphed, and in this war, the longest in the reign, it was the names of the enemy's generals, Prince Eugène of Savoy, Mazarin's grand-nephew, and the duke of Marlborough, which sounded in the ear, instead of Condé, Turenne and Luxembourg. Although during the first campaigns (1701-1703) in Italy, in Germany and in the Netherlands success was equally balanced, the successors of Villars—thanks to the treason of the duke of Savoy—were defeated at Höchstädt and Landau, and were reduced to the defensive (1704). In 1706 the defeats at Ramillies and Turin led to the evacuation of the Netherlands and Italy, and endangered the safety of Dauphiné. In 1708 Louis XIV. by a supreme effort was still able to maintain his armies; but the rout at Oudenarde, due to the misunderstanding between the duke of Burgundy and Vendôme, left the northern frontier exposed, and the cannons of the Dutch were heard at Marly. Louis XIV. had to humble himself to the extent of asking the Dutch for peace; but they forgot the lesson of 1673, and revolted by their demands at the Hague, he made a last appeal to arms and to the patriotism of his subjects at Malplaquet (September 1709). After this came invasion. Nature herself conspired with the enemy in the disastrous winter of 1709.

What saved Louis XIV. was not merely his noble constancy of resolve, the firmness of the marquis de Torcy, secretary of state for foreign affairs, the victory of Vendôme at Villaviciosa, nor the loyalty of his people. The interruption of the conferences at Gertruydenberg having obliged the Whigs and Marlborough to resign their power into the hands of the Tories, now sick of war, the death of the emperor Joseph I. (April 1711), which risked the reconstruction of Charles V.'s colossal and unwieldy monarchy upon the shoulders of the archduke Charles, and Marshal Villars' famous victory of Denain (July 1712) combined to render possible the treaties of Utrecht, Rastatt and Baden (1713-1714). These gave Italy and the Netherlands to the Habsburgs, Spain and her colonies to the Bourbons, the places on the coast and the colonial commerce to England (who had the lion's share), and a royal crown to the duke of Savoy

and the elector of Brandenburg. The peace of Utrecht was to France what the peace of Westphalia had been to Austria, and curtailed the former acquisitions of Louis XIV.

The ageing of the great king was betrayed not only by the fortune of war in the hands of Villeroy, la Feuillade, or Marsin; disgrace and misery at home were worse than defeat. By the strange and successive deaths of the Grand Dauphin (1711), the duke and duchess of Burgundy (1712)—who had been the only joy of the old monarch—and of his two grandsons (1712-1714), it seemed as though his whole family were involved under the same curse. The court, whose sentimental history has been related by Madame de la Fayette, its official splendours by Loret, and its intrigues by the duc de Saint-Simon, now resembled an infirmary of morose invalids, presided over by Louis XIV.'s elderly wife, Madame de Maintenon, under the domination of the Jesuit le Tellier. Neither was it merely the clamours of the people that arose against the monarch. All the more remarkable spirits of the time, like prophets in Israel, denounced a tyranny which put Chamillart at the head of the finances because he played billiards well, and Villeroy in command of the armies although he was utterly untrustworthy; which sent the "patriot" Vauban into disgrace, banished from the court Catinat, the Père la Pensée, "exiled" to Cambrai the too clear sighted Fénelon, and suspected Racine of Jansenism and La Fontaine of independence.

Disease and famine; crushing imposts and extortions; official debasement of the currency; bankruptcy; state prisons; religious and political inquisition; suppression of all institutions for the safe-guarding of rights; tyranny by the intendants; royal, feudal and clerical oppression burdening every faculty and every necessary of life; "monstrous and incurable luxury"; the horrible drama of poison; the twofold adultery of Madame de Montespan; and the narrow bigotry of Madame de Maintenon—all concurred to make the end of the reign a sad contrast with the splendour of its beginning. When reading Molière and Racine, Bossuet and Fénelon, the campaigns of Turenne, or Colbert's ordinances; when enumerating the countless literary and scientific institutions of the great century; when considering the port of Brest, the Canal du Midi, Perrault's colonnade of the Louvre, Mansart's Invalides and the palace of Versailles, and Vauban's fine fortifications—admiration is kindled for the radiant splendour of Louis XIV.'s period. But the art and literature expressed by the genius of the masters, reflected in the tastes of society, and to be taken by Europe as a model throughout a whole century, are no criterion of the social and political order of the day. They were but a magnificent drapery of pomp and glory thrown across a background of poverty, ignorance, superstition, hypocrisy and cruelty; remove it, and reality appears in all its brutal and sinister nudity. The corpse of Louis XIV., left to servants for disposal, and saluted all along the road to Saint Denis by the curses of a noisy crowd sitting in the *cabarets*, celebrating his death by drinking more than their fill as a compensation for having suffered too much from hunger during his lifetime—such was the coarse but sincere epitaph which popular opinion placed on the tomb of the "Grand Monarque." The nation, restive under his now broken yoke, received with a joyous anticipation, which the future was to discount, the royal infant whom they called Louis the Well-beloved, and whose funeral sixty years later was to be greeted with the same proofs of disillusionment.

The death of Louis XIV. closed a great era of French history; the 18th century opens upon a crisis for the monarchy. From 1715 to 1723 came the reaction of the Regency, with its marvellous effrontery, innovating spirit and frivolous immorality. From 1723 to 1743 came the mealy-mouthed despotism of Cardinal Fleury, and his apathetic policy within and without the kingdom. From 1743 to 1774 came the personal rule of Louis XV., when all the different powers were in conflict—the bishops and parlement quarrelling, the government fighting against the clergy and the magistracy, and public opinion in declared opposition to the state. Till at last, from 1774 to 1789, came Louis XVI. with his honest illusions.

*End of
Louis
XIV.'s
reign.*

*Peace of
Ryswick.*

*War of the
Spanish
Succession.*

*Peace of
Utrecht,
1713.*

*Character
of the
eighteenth
century.*

his moral pusillanimity and his intellectual impotence, to aggravate still further the accumulated errors of ages and to prepare for the inevitable Revolution.

The 18th century, like the 17th, opened with a political *coup d'état*. Louis XV. was five years old, and the duke of

**The
Regency
(1715-
1723).**

Orleans held the regency. But Louis XIV. had in his will delegated all the power of the government to a council on which the duke of Maine, his legitimated son, had the first, but Madame de Maintenon and the

Jesuits the predominant place. This collective administration, designed to cripple the action of the regent, encountered a two-fold opposition from the nobles and the parlement; but on the 2nd of September 1715 the emancipated parlement set aside the will in favour of the duke of Orleans, who thus together with the title of regent had all the real power. He therefore reinstated the parlement in its ancient right of remonstrance (suspended since the declarations of 1667 and 1673), and handed over ministerial power to the nobility, replacing the secretaries of state by six councils composed in part of great nobles, on the advice of the famous duc de Saint-Simon. The duc de Noailles, president of the council of finance, had the direction of this "Polysynodie."

The duke of Orleans, son of the princess palatine and Louis XIV.'s brother, possessed many gifts—courage, intelligence and agility of mind—but he lacked the one gift of

**Phillip of
Orleans.**

using these to good advantage. The political crisis that had placed him in power had not put an end to

the financial crisis, and this, it was hoped, might be effected by substituting partial and petty bankruptcies for the general bankruptcy cynically advocated by Saint-Simon. The reduction of the royal revenues did not suffice to fill the treasury; while the establishment of a chamber of justice (March 1716) had no other result than that of demoralizing the great lords and ladies already mad for pleasure, by bringing them into contact with the farmers of the revenue who purchased impunity from them. A very clever Scotch adventurer named John Law (*q.v.*) now offered his assistance in dealing with the enormous debt of more than three milliards, and in providing the treasury. Being well acquainted with the mechanism of banking, he had adopted views as to cash, credit and the circulation of values which contained an admixture of truth and falsehood. Authorized after many difficulties to organize a private bank of deposit and account, which being well conceived prospered and revived commerce, Law proposed to lighten the treasury by the profits accruing to a great maritime and colonial company. Payment for the shares in this new Company of the West, with a capital of a hundred millions, was to be made in credit notes upon the government, converted into 4% stock. These aggregated funds, needed to supply the immense and fertile valley of the Mississippi, and the annuities of the treasury destined to pay for the shares, were non-transferable. Law's idea was to ask the bank for the floating capital necessary, so that the bank and the Company of the West were to be supplementary to each other; this is what was called Law's system. After the chancellor D'Aguesseau and the duc de Noailles had been replaced by D'Argenson alone, and after the *lit de justice* of the 26th of August 1718 had deprived the parlement, hostile to Law, of the authority left to it, the bank became royal and the Company of the West universal. But the royal bank, as a state establishment, asked for compulsory privilege to increase the emission of its credit notes, and that they should receive a premium upon all metallic specie. The Company of the Indies became the grantee for the farming of tobacco, the coinage of metals, and farming in general; and in order to procure funds it multiplied the output of shares, which were adroitly launched and became more and more sought for on the exchange in the rue Quincampoix. This soon caused a frenzy of stock-jobbing, which disturbed the stability of private fortunes and social positions, and depraved customs and manners with the seductive notion of easily obtained riches. The nomination of Law to the controller-generalship, re-established for his benefit on the resignation of D'Argenson (January 5, 1720), let loose still wilder speculation;

till the day came when he could no longer face the terrible difficulty of meeting both private irredeemable shares with a variable return, and the credit notes redeemable at sight and guaranteed by the state. Gold and silver were proscribed; the bank and the company were joined in one; the credit notes and the shares were assimilated. But credit cannot be commanded either by violence or by expedients; between July and September 1720 came the suspension of payments, the flight of Law, and the disastrous liquidation which proved once again that respect for the state's obligations had not yet entered into the law of public finance.

Reaction on a no less extensive scale characterized foreign policy during the Regency. A close alliance between France and her ancient enemies, England and Holland, was concluded and maintained from 1717 to 1739: France, after thirty years of fighting, between two periods of bankruptcy; Holland reinstated in her commercial position; and England, seeing before her the beginning of her empire over the seas—all three had an interest in peace. On the other hand, peace was imperilled by Philip V. of Spain and by the emperor (who had accepted the portion assigned to them by the treaty of Utrecht, while claiming the whole), by Savoy and Brandenburg (who had profited too much by European conflicts not to desire their perpetuation), by the crisis from which the maritime powers of the Baltic were suffering, and by the Turks on the Danube. The dream of Cardinal Alberoni, Philip V.'s minister, was to set fire to all this inflammable material in order to snatch therefrom a crown of some sort to satisfy the maternal greed of Elizabeth Farnese; and this he might have attained by the occupation of Sardinia and the expedition to Sicily (1717-1718), if Dubois, a priest without a religion, a greedy parvenu and a diplomatist of second rank, though tenacious and full of resources as a minister, had not placed his common sense at the disposal of the regent's interests and those of European peace. He signed the triple alliance at the Hague, succeeding with the assistance of Stanhope, the English minister, in engaging the emperor therein, after attempting this for a year and a half. Whilst the Spanish fleet was destroyed before Syracuse by Admiral Byng, the intrigue of the Spanish ambassador Cellamare with the duke of Maine to exclude the family of Orleans from the succession on Louis XV.'s death was discovered and repressed; and Marshal Berwick burned the dockyards at Pasajes in Spain. Alberoni's dream was shattered by the treaty of London in 1720.

**The
Anglo-
Dutch
Alliance.**

Seized in his turn with a longing for the cardinal's hat, Dubois paid for it by the registering of the bull *Unigenitus* and by the persecution of the Jansenists which the regent had stopped. After the majority of Louis XV. had been proclaimed on the 16th of February 1723, Dubois was the first to depart; and four months after his disappearance the duke of Orleans, exhausted by his excesses, carried with him into the grave that spirit of reform which he had compromised by his frivolous voluptuousness (December 2, 1723).

The Regency had been the making of the house of Orleans; thenceforward the question was how to humble it, and the duc de Bourbon, now prime minister—a great-grandson of the great Condé, but a narrow-minded man of limited intelligence, led by a worthless woman—set himself to do so. The marquise de Prie was the first of a series of publicly recognized mistresses; from 1723 to 1726 she directed foreign policy and internal affairs despite the king's majority, moved always more by a spirit of vengeance than by ambition. This sad pair were dominated by the self-interested and continual fear of becoming subject to the son of the Regent, whom they detested; but danger came upon them from elsewhere. They found standing in their way the very man who had been the author of their fortunes, Louis XV.'s tutor, uneasy in the exercise of a veiled authority; for the churchman Fleury knew how to wait, on condition of ultimately attaining his end. Neither the festivities given at Chantilly in honour of the king, nor the dismissal (despite the most solemn promises) of the Spanish infanta, who had been betrothed

**Ministry
of the
duc de
Bourbon.**

to Louis XV., nor yet the young king's marriage to Maria Leszczyńska (1725)—a marriage negotiated by the marquise de Prie in order to bar the throne from the Orleans family—could alienate the sovereign from his old master. The irritation kept up by the agents of Philip V., incensed by this affront, and the discontent aroused by the institutions of the *cinquantième* and the militia, by the re-establishment of the feudal tax on Louis XV.'s joyful accession, and by the resumption of a persecution of the Protestants and the Jansenists which had apparently died out, were cleverly exploited by Fleury; and a last ill-timed attempt by the queen to separate the king from him brought about the fall of the duc de Bourbon, very opportunely for France, in June 1726.

From the hands of his unthinking pupil Fleury eventually received the supreme direction of affairs, which he retained for seventeen years. He was aged seventy-two when he thus obtained the power which had been his unmeasured though not ill-calculated ambition. Soft-spoken and polite, crafty and suspicious, he was pacific by temperament and therefore allowed politics to slumber. His turn for economics made Orry,¹ the controller-general of finance, for long his essential partner. The latter laboured at re-establishing order in fiscal affairs; and various measures like the impost of the *dixième* upon all property save that of the clergy, together with the end of the corn famine, sufficed to restore a certain amount of well-being. Religious peace was more difficult to secure; in fact politico-religious quarrels dominated all the internal policy of the kingdom during forty years, and gradually compromised the royal authority. The Jesuits, returned to power in 1723 with the duc de Bourbon and in 1726 with Fleury, rekindled the old strife regarding the bull *Unigenitus* in opposition to the Gallicans and the Jansenists. The retraction imposed upon Cardinal de Noailles, and his replacement in the archbishopric of Paris by Vintimille, an unequivocal Molinist, excited among the populace a very violent agitation against the court of Rome and the Jesuits, the prelude to a united Fronde of the Sorbonne and the parlement. Fleury found no other remedy for this agitation—in which appeal was made even to miracles—than *lits de justice* and *lettres de cachet*; Jansenism remained a potent source of trouble within the heart of Catholicism.

This worn-out septuagenarian, who prized rest above everything, imported into foreign policy the same mania for economy and the same sloth in action. He naturally adopted the idea of reconciling Louis XIV.'s descendants, who had all been embroiled ever since the Polish marriage. He succeeded in this by playing very adroitly on the ambition of Elizabeth Farnese and her husband Philip V., who was to reign in France notwithstanding any renunciation that might have taken place. Despite the birth of a dauphin (September 1729), which cut short the Spanish intrigues, the reconciliation was a lasting one (treaty of Seville); it led to common action in Italy, and to the installation of Spanish royalties at Parma, Piacenza, and soon after at Naples. Fleury, supported by the English Hanoverian alliance, to which he sacrificed the French navy, obliged the emperor Charles VI. to sacrifice the trade of the Austrian Netherlands to the maritime powers and Central Italy to the Bourbons, in order to gain recognition for his Pragmatic Sanction. The question of the succession in France lay dormant until the end of the century, and Fleury thought he had definitely obtained peace in the treaty of Vienna (1731).

The war of the Polish succession proved him to have been deceived. On the death of Augustus II. of Saxony, king of Poland, Louis XV.'s father-in-law had been proclaimed king by the Polish diet. This was an ephemeral success, ill-prepared and obtained by taking a sudden advantage of national sentiment; it was soon followed by a check, owing to a Russian and

¹ Jean Orry Louis Orry de Fulvy (1703–1751), counsel to the parlement in 1723, intendant of finances in 1737, founded at Vincennes the manufactory of porcelain which was bought in 1750 by the farmers general and transferred to Sèvres.

German coalition and the baseness of Cardinal Fleury, who, in order to avoid intervening, pretended to tremble before an imaginary threat of reprisals on the part of England. But Chauvelin, the keeper of the seals, supported by public opinion, avenged on the Rhine and the Po the unlucky heroism of the comte de Plélo at Danzig,² the vanished dream of the queen, the broken word of Louis XV., and the treacherous abandonment of Poland. Fleury never forgave him for this: Chauvelin had checkmated him with war; he checkmated Chauvelin with peace, and hastened to replace Marshals Berwick and Villars by diplomatists. The third treaty of Vienna (1738), the reward of so much effort, would only have claimed for France the little duchy of Bar, had not Chauvelin forced Louis XV. to obtain Lorraine for his father-in-law—still hoping for the reversion of the crown; but Fleury thus rendered impossible any influence of the queen, and held Stanislaus at his mercy. In order to avenge himself upon Chauvelin he sacrificed him to the cabinets of Vienna and London, alarmed at seeing him revive the national tradition in Italy.

Fleury hardly had time to breathe before a new conflagration broke out in the east. The Russian empress Anne and the emperor Charles VI. had planned to begin dismembering the Turkish empire. More fortunate than Plélo, Villeneuve, the French ambassador at Constantinople, endeavoured to postpone this event, and was well supported; he revived the courage of the Turks and provided them with arms, thanks to the comte de Bonneval (*q.v.*), one of those adventurers of high renown whose influence in Europe during the first half of the eighteenth century is one of the most piquant features of that period. The peace of Belgrade (September 1739) was, by its renewal of the capitulations, a great material success for France, and a great moral victory by the rebuff to Austria and Russia.

France had become once more the arbiter of Europe, when the death of the emperor Charles VI. in 1740 opened up a new period of wars and misfortunes for Europe and for the pacific Fleury. Every one had signed Charles VI.'s Pragmatic Sanction, proclaiming the succession-rights of his daughter, the archduchess Maria Theresa; but on his death there was a general renunciation of signatures and an attempt to divide the heritage. The safety of the house of Austria depended on the attitude of France; for Austria could no longer harm her. Fleury's inclination was not to misuse France's traditional policy by exaggerating it, but to respect his sworn word; he dared not press his opinion, however, and yielded to the fiery impatience of young hot-heads like the two Belle-Isles, and of all those who, infatuated by Frederick II., felt sick of doing nothing at Versailles and were backed up by Louis XV.'s bellicose mistresses. He had to experience the repeated defections of Frederick II. in his own interests, and the precipitate retreat from Bohemia. He had to humble himself before Austria and the whole of Europe; and it was high time for Fleury, now fallen into second childhood, to vanish from the scene (January 1743).

Louis XV. was at last to become his own prime minister and to reign alone; but in reality he was more embarrassed than pleased by the responsibility incumbent upon him. He therefore retained the persons who had composed Fleury's staff; though instead of being led by a single one of them, he fell into the hands of several, who disputed among themselves for the ascendancy: Maurepas, incomparable in little things, but neglectful of political affairs; D'Argenson, bold, and strongly attached to his work as minister

² Louis Robert Hippolyte de Bréhan, comte de Plélo (1699–1734), a Breton by birth, originally a soldier, was at the time of the siege of Danzig French ambassador to Denmark. Enraged at the return to Copenhagen, without having done anything, of the French force sent to help Stanislaus, he himself led it back to Danzig and fell in an attack on the Russians on the 27th of May 1734. Plélo was a poet of considerable charm, and well-read both in science and literature.

See Marquis de Bréhan, *Le Comte de Plélo* (Nantes, 1874); R. Rathery, *Le Comte de Plélo* (Paris, 1876); and P. Boyé, *Stanislaus Leszczyński et le troisième traité de Vienne* (Paris, 1898).

War of the Polish Succession (1733-1738).

The Eastern question.

War of the Austrian Succession.

Personal rule of Louis XV.

of war; and the cardinal de Tencin, a frivolous and worldly priest. Old Marshal de Noailles tried to incite Louis XV. to take his kingship in earnest, thinking to cure him by war of his effeminate passions; and, in the spring of 1744, the king's grave illness at Metz gave a momentary hope of reconciliation between him and the deserted queen. But the duc de Richelieu, a roué who had joined hands with the sisters of the house of Nesle and was jealous of Marshal de Noailles, soon regained his lost ground; and, under the influence of this panderer to his pleasures, Louis XV. settled down into a life of vice. Holding aloof from active affairs, he tried to relieve the incurable boredom of satiety in the violent exercise of hunting, in supper-parties with his intimates, and in spicy indiscretions. Brought up religiously and to shun the society of women, his first experiences in adultery had been made with many scruples and intermittently. Little by little, however, jealous of power, yet incapable of exercising it to any purpose, he sank into a sensuality which became utterly shameless under the influence of his chief mistress the duchesse de Châteauroux.

Hardly had a catastrophe snatched her away in the zenith of her power when complete corruption and the flagrant triumph of egoism supervened with the accession to power of the marquise de Pompadour, and for nearly twenty years (1745-1764) the whims and caprices of this little *bourgeoise* ruled the realm. A prime minister in petticoats, she had her political system: reversed the time-honoured alliances of France, appointed or disgraced ministers, directed fleets and armies, concluded treaties, and failed in all her enterprises! She was the queen of fashion in a society where corruption blossomed luxuriantly and exquisitely, and in a century of wit hers was second to none. Amidst this extraordinary instability, when everything was at the mercy of a secret thought of the master, the mistress alone held lasting sway; in a reign of all-pervading satiety and tedium, she managed to remain indispensable and bewitching to the day of her death.

Meanwhile the War of the Austrian Succession broke out again, and never had secretary of state more intricate questions to solve than had D'Argenson. In the attempt to make a stage-emperor of Charles Albert of Bavaria, defeat was incurred at Dettingen, and the French were driven back on the Rhine (1743). The Bavarian dream dissipated, victories gained in Flanders by Marshal Saxe, another adventurer of genius, at Fontenoy, Raucoux and Lawfeld (1745-1747), were hailed with joy as continuing those of Louis XIV.; even though they resulted in the loss of Germany and the doubling of English armaments. The "disinterested" peace of Aix-la-Chapelle (October 1748) had no effectual result other than that of destroying in Germany, and for the benefit of Prussia, a balance of power that had yet to be secured in Italy, despite the establishment of the Spanish prince Philip at Parma. France, meanwhile, was beaten at sea by England, Maria Theresa's sole ally. While founding her colonial empire England had come into collision with France; and the rivalry of the Hundred Years' War had immediately sprung up again between the two countries. Engaged already in both Canada and in India (where Dupleix was founding an empire with a mere handful of men), it was to France's interest not to become involved in war upon the Rhine, thus falling into England's continental trap. She did fall into it, however: for the sake of conquering Silesia for the king of Prussia, Canada was left exposed by the capture of Cape Breton; while in order to restore this same Silesia to Maria Theresa, Canada was lost and with it India.

France had worked for the king of Prussia from 1740 to 1748; now it was Maria Theresa's game that was played in the Seven Years' War. In 1755, the English having made a sudden attack upon the French at sea, and Frederick II. having by a fresh *volte-face* passed into alliance with Great Britain, Louis XV.'s government accepted an alliance with Maria Theresa in the treaty of the 1st of May 1756. Instead of remaining upon the defensive in this continental war—merely accessory as it was—he made

it his chief affair, and placed himself under the petticoat government of three women, Maria Theresa, Elizabeth of Russia and the marquise de Pompadour. This error—the worst of all—laid the foundations of the Prussian and British empires. By three battles, victories for the enemies of France—Rossbach in Germany, 1757, Plassey in India, 1757, and Quebec in Canada, 1759 (owing to the recall of Dupleix, who was not bringing in large enough dividends to the Company of the Indies, and to the abandonment of Montcalm, who could not interest any one in "a few acres of snow"), the expansion of Prussia was assured, and the British relieved of French rivalry in the expansion of their empire in India and on the North American continent.

Owing to the blindness of Louis XV. and the vanity of the favourite, the treaties of Paris and Hubertusburg (1763) once more proved the French splendid in their conceptions, *Treaties of Paris and Hubertusburg*, but deficient in action. Moreover, Choiseul, secretary of state for foreign affairs since 1758, made out of this deceptive Austrian alliance a system which put the finishing touch to disaster; and after having thrown away everything to satisfy Maria Theresa's hatred of Frederick II., the reconciliation between these two irreconcilable Germans at Neisse and at Neustadt (1769-1770) was witnessed by France, to the prejudice of Poland, one of her most ancient adherents. The expedient of the Family Compact, concluded with Spain in 1761—with a view to taking vengeance upon England, whose fleets were a continual thorn in the side to France—served only to involve Spain herself in misfortune. Choiseul, who at least had a policy that was sometimes in the right, and who was very anxious to carry it out, then realized that the real quarrel had to be settled with England. Amid the anguish of defeat and of approaching ruin, he had an acute sense of the actualities of the case, and from 1763 to 1766 devoted himself passionately to the reconstruction of the navy. To compensate for the loss of the colonies he annexed Lorraine (1766), and by the acquisition of Corsica in 1768 he gave France an intermediary position in the Mediterranean, between friendly Spain and Italy, looking forward to the time when it should become a stepping-stone to Africa.

But Louis XV. had two policies. The incoherent efforts which he made to repair by the secret diplomacy of the comte de Broglie the evils caused by his official policy only aggravated his shortcomings and betrayed his weakness. The contradictory intrigues of the king's secret proceedings in the candidature of Prince Xavier, the dauphine's brother, and the patriotic efforts of the confederation of Bar, contributed to bring about the Polish crisis which the partition of 1772 resolved in favour of Frederick II.; and the Turks were in their turn dragged into the same disastrous affair. Of the old allies of France, Choiseul preserved at least Sweden by the *coup d'état* of Gustavus III.; but instead of being as formerly the centre of great affairs, the cabinet of Versailles lost all its credit, and only exhibited before the eyes of contemptuous Europe France's extreme state of decay.

The nation felt this humiliation, and showed all the greater irritation as the want of cohesion in the government and the anarchy in the central authority became more and more intolerable in home affairs. Though the administration still possessed a fund of tradition and a personnel which, including many men of note, protected it from the enfeebling influence of the court, it looked as though chance regulated everything so far as the government was concerned. These fluctuations were owing partly to the character of Louis XV., and partly also to the fact that society in the 18th century was too advanced in its ideas to submit without resistance to the caprice of such a man. His mistresses were not the only cause of this; for ever since Fleury's advent political parties had come to the fore. From 1749 to 1757 the party of religious devotees grouped round the queen and the king's daughters, with the dauphin as chief and the comte D'Argenson and Machault d'Arnouville, keeper of the seals, as lieutenants, had worked against Madame de Pompadour (who leant for support upon the parlements, the Jansenists and the philosophers),

Madame de Pompadour.

Peace of Aix-la-Chapelle.

First partition of Poland.

Internal policy of Louis XV.

The Seven Years' War, 1756-1763.

and had gained the upper hand. Thenceforward poverty, disorders, and consequently murmurs increased. The financial reform attempted by Machault d'Arnouville between 1745 and 1749—a reduction of the debt through the impost of the twentieth and the edict of 1749 against the extensive property held in mortmain by the Church—after his disgrace only resulted in failure. The army, which D'Argenson (likewise dismissed by Madame de Pompadour) had been from 1743 to 1747 trying to restore by useful reforms, was riddled by cabals. Half the people in the kingdom were dying of hunger, while the court was insulting poverty by its luxury and waste; and from 1750 onwards political ferment was everywhere manifest. It found all the more favourable foothold in that the Church, the State's best ally, had made herself more and more unpopular. Her refusal of the sacraments to those who would not accept the bull *Unigenitus* (1746) was exploited in the eyes of the masses, as in those of more enlightened people was her selfish and short-sighted resistance to the financial plans of Machault. The general discontent was expressed by the parlements in their attempt to establish a political supremacy amid universal confusion, and by the popular voice in pamphlets recalling by their violence those of the League. Every one expected and desired a speedy revolution that should put an end to a policy which alternated between overheated effervescence, abnormal activity and lethargy. Nothing can better show the point to which things had descended than the attempted assassination of Louis the Well-beloved by Damiens in 1757.

Choiseul was the means of accelerating this revolution, not only by his abandonment of diplomatic traditions, but still more by his improvidence and violence. He reversed the policy of his predecessors in regard to the parlement. Supported by public opinion, which clamoured for guarantees against arbitrary power, the parlements had dared not only to insist on being consulted as to the budget of the state in 1763, but to enter upon a confederation throughout the whole of France, and on repeated occasions to ordain a general strike of the judicial authorities. Choiseul did not hesitate to attack through *lits de justice* or by exile a judiciary oligarchy which doubtless rested its pretensions merely on wealth, high birth, or that encroaching spirit that was the only counteracting agency to the monarchy. Louis XV., wearied with their clamour, called them to order. Choiseul's religious policy was no less venturesome; after the condemnation in 1759 of the Jesuits who were involved in the bankruptcy of Father de la Valette, their general, in the Antilles, he had the order dissolved for refusing to modify its constitution (1761–1764). Thus, not content with encouraging writers with innovating ideas to the prejudice of traditional institutions, he attacked, in the order of the Jesuits, the strongest defender of these latter, and delivered over the new generation to revolutionary doctrines.

A woman had elevated him into power; a woman brought him to the ground. He succumbed to a coalition of the chancellor Maupeou, the duc d'Aiguillon and the Abbé Terray, which depended on the favour of the king's latest mistress, Madame du Barry (December 1770); and the Jesuits were avenged by a stroke of authority similar to that by which they themselves had suffered. Following on an edict registered by the *lit de justice*, which forbade any remonstrance in political matters, the parlement had resigned, and had been imitated by the provincial parlements; whereupon Maupeou, an energetic chancellor, suppressed the parlements and substituted superior councils of magistrates appointed by the king (1771). This reform was justified by the religious intolerance of the parlements; by their scandalous trials of Calas, Pierre Paul Sirven (1709–1777), the chevalier de la Barre and the comte de Lally; by the retrograde spirit that had made them suppress the Encyclopaedia in 1759 and condemn *Émile* in 1762; and by their selfishness in perpetuating abuses by which they profited. But this reform, being made by the minister of a hated sovereign, only aided in exasperating public opinion, which was grateful to the parlements in that their remonstrances had not always been fruitless.

Thus all the buttresses of the monarchical institution began to fall to pieces: the Church, undermined by the heresy of Jansenism, weakened by the inroads of philosophy, discredited by evil-livers among the priesthood, and divided against itself, like all losing parties; the nobility of the court, still brave at heart, though incapable of exertion and reduced to beggary, having lost all respect for discipline and authority, not only in the camp, but in civilian society; and the upper-class officials, narrow-minded and egotistical, unsettling by their opposition the royal authority which they pretended to safeguard. Even the "liberties," among the few representative institutions which the *ancien régime* had left intact in some provinces, turned against the people. The estates opposed most of the intelligent and humane measures proposed by such intendants as Tourny and Turgot to relieve the peasants, whose distress was very great; they did their utmost to render the selfishness of the privileged classes more oppressive and vexatious.

Thus the terrible prevalence of poverty and want; the successive famines; the mistakes of the government; the scandals of the Parc aux Cerfs; and the parlements playing the Roman senate: all these causes, added together and multiplied, assisted in setting a general fermentation to work. The philosophers only helped to precipitate a movement which they had not created; without pointing to absolute power as the cause of the trouble, and without pretending to upset the traditional system, they attempted to instil into princes the feeling of new and more precise obligations towards their subjects. Voltaire, Montesquieu, the Encyclopaedists and the Physiocrats (recurring to the tradition of Bayle and Fontenelle), by dissolving in their analytical crucible all consecrated beliefs and all fixed institutions, brought back into the human society of the 18th century that humanity which had been so rudely eliminated. They demanded freedom of thought and belief with passionate insistence; they ardently discussed institutions and conduct; and they imported into polemics the idea of natural rights superior to all political arrangements. Whilst some, like Voltaire and the Physiocrats, representatives of the privileged classes and careless of political rights, wished to make use of the omnipotence of the prince to accomplish desirable reforms, or, like Montesquieu, adversely criticized despotism and extolled moderate governments, other, plebeians like Rousseau, proclaimed the theory of the social contract and the sovereignty of the people. So that during this reign of frivolity and passion, so bold in conception and so poor in execution, the thinkers contributed still further to mark the contrast between grandeur of plan and mediocrity of result.

The preaching of all this generous philosophy, not only in France, but throughout the whole of Europe, would have been in vain had there not existed at the time a social class interested in these great changes, and capable of compassing them. Neither the witty and lucid form in which the philosophers clothed their ideas in their satires, romances, stage-plays and treatises, nor the salons of Madame du Deffand, Madame Geoffrin and Mademoiselle de Lespinasse, could possibly have been sufficiently far-reaching or active centres of political propaganda. The former touched only the more highly educated classes; while to the latter, where privileged individuals alone had entry, novelties were but an undiluted stimulant for the jaded appetites of persons whose ideas of good-breeding, moreover, would have drawn the line at martyrdom.

The class which gave the Revolution its chiefs, its outward and visible forms, and the irresistible energy of its hopes, was the *bourgeoisie*, intelligent, ambitious and rich; in the forefront the capitalists and financiers of the *haute bourgeoisie*, farmers-general and army contractors, who had supplanted or swamped the old landed and military aristocracy, had insensibly reconstructed the interior of the ancient social edifice with the gilded and incongruous materials of wealth, and in order to consolidate or increase their monopolies, needed to secure themselves against the arbitrary action of royalty and the bureaucracy.

Ancient Influences and Institutions.

The new Ideas.

The Triumvirate, 1770-1774.

The bourgeoisie—the incarnation of new Ideas.

Next came the crowd of stockholders and creditors of the state, who, in face of the government's "extravagant anarchy," no longer felt safe from partial or total bankruptcy. More powerful still, and more masterful, was the commercial, industrial and colonial *bourgeoisie*; because under the Regency and under Louis XV. they had been more productive and more creative. Having gradually revolutionized the whole economic system, in Paris, in Lyons, in Nantes, in Bordeaux, in Marseilles, they could not tamely put up with being excluded from public affairs, which had so much bearing upon their private or collective enterprises. Finally, behind this *bourgeoisie*, and afar off, came the crowd of serfs, rustics whom the acquisition of land had gradually enfranchised, and who were the more eager to enjoy their definitive liberation because it was close at hand.

The habits and sentiments of French society showed similar changes. From having been almost exclusively national during

Transformation of manners and customs.

Louis XIV.'s reign, owing to the perpetual state of war and to a sort of proud isolation, it had gradually become cosmopolitan. After the peace of Aix-la-Chapelle, France had been flooded from all quarters of the civilized world, but especially from England, by a concourse of refined and cultured men well acquainted with her usages and her universal language, whom she had received sympathetically. Paris became the brain of Europe. This revolution in manners and customs, coinciding with the revolution in ideas, led in its turn to a transformation in feeling, and to new aesthetic needs. Gradually people became sick of openly avowed gallantry, of shameless libertinism, of moral obliquity and of the flattering artifices of vice; a long shudder ran through the selfish torpor of the social body. After reading the *Nouvelle-Héloïse*, *Clarissa* and *Sir Charles Grandison*, fatigued and wearied society revived as though beneath the fresh breezes of dawn. The principle of examination, the reasoned analysis of human conditions and the discussion of causes, far from culminating in disillusioned nihilism, everywhere aroused the democratic spirit, the life of sentiment and of human feeling: in the drama, with Marivaux, Diderot and La Chaussée; in art, with Chardin and Greuze; and in the salons, in view of the suppression of privilege. So that to Louis XV.'s cynical and hopeless declaration: "Après moi le déluge," the setting 18th century responded by a belief in progress and an appeal to the future. A long-drawn echo from all classes hailed a revolution that was possible because it was necessary.

If this revolution did not burst forth sooner, in the actual lifetime of Louis XV., if in Louis XVI.'s reign there was a renewal of loyalty to the king, before the appeal to liberty was made, that is to be explained by this hope of recovery. But Louis XVI.'s reign (1774-1792) was only to be a temporary halting-place, an artifice of history for passing through the transition period whilst elaborating the transformation which was to revolutionize, together with France, the whole world.

Louis XVI. was twenty years of age. Physically he was stout, and a slave to the Bourbon fondness for good living; *Louis XVI.* intellectually a poor creature and but ill-educated, he loved nothing so much as hunting and locksmith's work. He had a taste for puerile amusements, a mania for useless little domestic economies in a court where millions vanished like smoke, and a natural idleness which achieved as its masterpiece the keeping a diary from 1766 to 1792 of a life so tragic, which was yet but a foolish chronicle of trifles. Add to this that he was a virtuous husband, a kind father, a fervent Christian and a good-natured man full of excellent intentions, yet a spectacle of moral pusillanimity and ineptitude.

From 1770 onwards lived side by side with this king, rather than at his side, the archduchess Marie Antoinette of Austria—*Marie Antoinette.* one of the very graceful and very frivolous women who were to be found at Versailles, opening to life like the flowers she so much loved, enamoured of pleasure and luxury, delighting to free herself from the formalities of court life, and mingling in the amusements

of society; lovable and loving, without ceasing to be virtuous. Flattered and adored at the outset, she very soon furnished a sinister illustration to Beaumarchais' *Basile*; for evil tongues began to calumniate the queen: those of her brothers-in-law, the duc d'Aiguillon (protector of Madame du Barry and dismissed from the ministry), and the Cardinal de Rohan, recalled from his embassy in Vienna. She was blamed for her friendship with the comtesse de Polignac, who loved her only as the dispenser of titles and positions; and when weary of this persistent begging for rewards, she was taxed with her preference for foreigners who asked nothing. People brought up against her the debts and expenditure due to her belief in the inexhaustible resources of France; and hatred became definite when she was suspected of trying to imitate her mother Maria Theresa and play the part of ruler, since her husband neglected his duty. They then became persuaded that it was she who caused the weight of taxation; in the most infamous libels comparison was made between her freedom of behaviour and that of Louis XV.'s former mistresses. Private envy and public misconceptions very soon summed up her excessive unpopularity in the menacing nickname, "L'Autrichienne." (See MARIE ANTOINETTE.)

All this shows that Louis XVI. was not a monarch capable of directing or suppressing the inevitable revolution. His reign was but a tissue of contradictions. External affairs seemed in even a more dangerous position than those at home. Louis XVI. confided to Vergennes the charge of reverting to the traditions of the crown and raising France from the humiliation suffered by the treaty of Paris and the partition of Poland. His first act was to release French policy from the Austrian alliance of 1756; in this he was aided both by public opinion and by the confidence of the king—the latter managing to set aside the desires of the queen, whom the ambition of Maria Theresa and Joseph II. hoped to use as an auxiliary. Vergennes' object was a double one: to free the kingdom from English supremacy and to shake off the yoke of Austria. Opportunities offered themselves simultaneously. In 1775 the English colonies in America rebelled, and Louis XVI., after giving them secret aid and encouragement almost from the first, finally in February 1778, despite Marie Antoinette, formed an open alliance with them; while when Joseph II., after having partitioned Poland, wanted in addition to balance the loss of Silesia with that of Bavaria, Vergennes prevented him from doing so. In vain was he offered a share in the partition of the Netherlands by way of an inducement. France's disinterested action in the peace of Teschen (1779) restored to her the lost adherence of the secondary states. Europe began to respect her again when she signed a Franco-Dutch-Spanish alliance (1779-1780), and when, after the capitulation of the English at Yorktown, the peace of Versailles (1783) crowned her efforts with at least formal success. Thenceforward, partly from prudence and partly from penury, Vergennes cared only for the maintenance of peace—a not too easy task, in opposition to the greed of Catherine II. and Joseph II., who now wished to divide the Ottoman empire. Joseph II., recognizing that Louis XVI. would not sacrifice the "sick man" to him, raised the question of the opening of the Scheldt, against the Dutch. Vainly did Joseph II. accuse his sister of ingratitude and complain of her resistance; the treaty of Fontainebleau in 1785 maintained the rights of Holland. Later on, Joseph II., sticking to his point, wanted to settle the house of Bavaria in the Netherlands; but Louis XVI. supported the confederation of princes (Fürstenbund) which Frederick II. called together in order to keep his turbulent neighbour within bounds. Vergennes completed his work by signing a commercial treaty in 1786 with England, whose commerce and industry were favoured above others, and a second in 1787 with Russia. He died in 1787, at an opportune moment for himself; though he had temporarily raised France's position in Europe, his work was soon ruined by the very means taken to secure its successes: warfare and armaments had hastened the "hideous bankruptcy."

Foreign policy of Louis XVI.

From the very beginning of his reign Louis XVI. fell into

contradictions and hesitation in internal affairs, which could not but bring him to grief. He tried first of all to govern in accordance with public opinion, and was induced to flatter it beyond measure; in an extreme of inconsistency he re-established the parlements, the worst enemies of reform, at the very moment when he was calling in the reformers to his councils.

Turgot, the most notable of these latter, was well fitted to play his great part as an enlightened minister, as much from the principle of hard work and domestic economy traditional in his family, as from a maturity of mind developed by extensive study at the Sorbonne and by frequenting the salons of the Encyclopaedists.

He had proved this by his capable administration in the paymaster's office at Limoges, from 1761 to 1774. A disciple of Quesnay and of Gournay, he tried to repeat in great affairs the experience of liberty which he had found successful in small, and to fortify the unity of the nation and the government by social, political and economic reforms. He ordained the free circulation of grain within the kingdom, and was supported by Louis XVI. in the course of the flour-war (*guerre des farines*) (April-May 1775); he substituted a territorial subsidy for the royal *corvée*—so burdensome upon the peasants—and thus tended to abolish privilege in the matter of imposts; and he established the freedom of industry by the dissolution of privileged trade corporations (1776). Finance was in a deplorable state, and as controller-general he formulated a new fiscal policy, consisting of neither fresh taxation nor loans, but of retrenchment. At one fell stroke the two auxiliaries on which he had a right to count failed him: public opinion, clamouring for reform on condition of not paying the cost; and the king, too timid to dominate public opinion, and not knowing how to refuse the demands of privilege. Economy in the matter of public finance implies a grain of severity in the collection of taxes as well as in expenditure. By the former Turgot hampered the great interests; by the second he thwarted the desires of courtiers not only of the second rank but of the first. Therefore, after he had aroused the complaints of the commercial world and the bourgeoisie, the court, headed by Marie Antoinette, profited by the general excitement to overthrow him. The Choiseul party, which had gradually been reconstituted, under the influence of the queen, the princes, parlement, the prebendaries, and the trade corporations, worked adroitly to eliminate this reformer of lucrative abuses. The old courtier Maupepas, jealous of Turgot and desirous of remaining a minister himself, refrained from defending his colleague; and when Turgot, who never knew how to give in, spoke of establishing assemblies of freeholders in the communes and the provinces, in order to relax the tension of over-centralization, Louis XVI., who never dared to pass from sentiment to action, sacrificed his minister to the rancour of the queen, as he had already sacrificed Malesherbes (1776). Thus the first governmental act of the queen was an error, and dissipated the hope of replacing special privileges by a general guarantee given to the nation, which alone could have postponed a revolution. It was still too early for a Fourth of August; but the queen's victory was none the less vain, since Turgot's ideas were taken up by his successors.

The first of these was Necker, a Genevese financier. More able than Turgot, though a man of smaller ideas, he abrogated the edicts registered by the *lits de justice*; and unable or not daring to attack the evil at its root, he thought he could suppress its symptoms by a curative process of borrowing and economy. Like Turgot he failed, and for the same reasons. The American war had finally exhausted the exchequer, and, in order to replenish it, he would have needed to inspire confidence in the minds of capitalists; but the resumption in 1778 of the plan of provincial assemblies charged with remodelling the various imposts, and his *comptendu* in which he exhibited the monarchy paying its pensioners for their inactivity as it had never paid its agents for their zeal, aroused a fresh outburst of anger. Necker was carried away in his turn by the reaction he had helped to bring about (1781).

Having fought the oligarchy of privilege, the monarchy next tried to rally it to its side, and all the springs of the old régime were strained to the breaking-point. The military rule of the marquis de Ségur eliminated the plebeians from the army; while the great lords, drones in the hive, worked with a kind of fever at the enforcement of their seigniorial rights; the feudal system was making a last struggle before dying. The Church claimed her right of ordering the civil estate of all Frenchmen as an absolute mistress more strictly than ever. Joly de Fleury and D'Ormesson, Necker's successors, pushed their narrow spirit of reaction and the temerity of their inexperience to the furthest limit; but the reaction which reinforced the privileged classes was not sufficient to fill the coffers of the treasury, and Marie Antoinette, who seemed gifted with a fatal perversion of instinct, confided the finances of the kingdom to Calonne, an upper-class official and a veritable Cagliostro of finance.

From 1783 to 1787, this man organized his astounding system of falsification all along the line. His unbridled prodigality, by spreading a belief in unlimited resources, augmented the confidence necessary for the success of perpetual loans; until the day came when, having exhausted the system, he tried to suppress privilege and fall back upon the social reforms of Turgot, and the financial schemes of Necker, by suggesting once more to the assembly of notables a territorial subsidy from all landed property. He failed, owing to the same reaction that was causing the feudal system to make inroads upon the army, the magistracy and industry; but in his fall he put on the guise of a reformer, and by a last wild plunge he left the monarchy, already compromised by the affair of the Diamond Necklace (*q.v.*), hopelessly exposed (April 1787).

The volatile and brilliant archbishop Loménie de Brienne was charged with the task of laying the affairs of the *ancien régime* before the assembly of notables, and with asking the nation for resources, since the monarchy could no longer provide for itself; but the notables refused, and referred the minister to the states-general, the representative of the nation. Before resorting to this extremity, Brienne preferred to lay before the parlement his two edicts regarding a stamp duty and the territorial subsidy; to be met by the same refusal, and the same reference to the states-general. The exile of the parlement to Troyes, the arrest of various members, and the curt declaration of the king's absolute authority (November 9, 1787) were unsuccessful in breaking down its resistance. The threat of Chrétien François de Lamoignon, keeper of the seals, to imitate Maupeou, aroused public opinion and caused a fresh confederation of the parlements of the kingdom. The royal government was too much exhausted to overthrow even a decaying power like that of the parlements, and being still more afraid of the future representatives of the French people than of the supreme courts, capitulated to the insurgent parlements. The recalled parlement seemed at the pinnacle of power.

Its next action ruined its ephemeral popularity, by claiming the convocation of the states-general "according to the formula observed in 1614," as already demanded by the estates of Dauphiné at Vizille on the 21st of July 1788. The exchequer was empty; it was necessary to comply. The royal declaration of the 23rd of September 1788 convoked the states-general for the 1st of May 1789, and the fall of Brienne and Lamoignon followed the recall of Necker. Thenceforward public opinion, which was looking for something quite different from the superannuated formula of 1614, abandoned the parlements, which in their turn disappeared from view; for the struggle beginning between the privileged classes and the government, now at bay, had given the public, through the states-general, that means of expression which they had always lacked.

The conflict immediately changed ground, and an engagement began between privilege and the people over the twofold question of the number of deputies and the mode of voting. Voting by head, and the double representation of the third estate (*tiers état*); this was the great revolution; voting by order meant the

Internal policy of Louis XVI.

Turgot, 1774-1776.

The return of feudalism to the offensive.

Calonne, 1783-1787.

Loménie de Brienne.

Recall of Necker.

continued domination of privilege, and the lesser revolution. The monarchy, standing apart, held the balance, but needed a decisive policy. Necker, with little backing at court, could not act energetically, and Louis XVI., wavering between Necker and the queen, chose the attitude most convenient to his indolence and least to his interest:

Prelude to the states-general.

he remained neutral, and his timidity showed clearly in the council of the 27th of December 1788. Separating the two questions which were so closely connected, and despite the sensational brochure of the abbé Sieyès, "What is the Third Estate?" he pronounced for the doubling of the third estate without deciding as to the vote by head, yet leaving it to be divined that he preferred the vote by order. As to the programme there was no more decisive resolution; but the edict of convocation gave it to be understood that a reform was under consideration: "the establishment of lasting and permanent order in all branches of the administration." The point as to the place of convocation gave rise to a compromise between the too-distant centre of France and too-tumultuous Paris. Versailles was chosen "because of the hunting!" In the procedure of the elections

The electorate.

the traditional system of the states-general of 1614 was preserved, and the suffrage was almost universal, but in two kinds: for the third estate nearly all citizens over twenty-five years of age, paying a direct contribution, voted—peasants as well as bourgeois; the country clergy were included among the ecclesiastics; the smaller nobility among the nobles; and finally, Protestants were electors and eligible.

According to custom, documents (*cahiers*) were drawn up, containing a list of grievances and proposals for reform. All the orders were agreed in demanding prudently modified

The addresses.

reform: the vote on the budget, order in finance, regular convocation of the states-general, and a written constitution in order to get rid of arbitrary rule. The address of the clergy, inspired by the great prelates, sought to make inaccurate lamentations over the progress of impiety a means of safeguarding their enormous spiritual and temporal powers, their privileges and exemptions, and their vast wealth. The nobility demanded voting by order, the maintenance of their privileges, and, above all, laws to protect them against the arbitrary proceedings of royalty. The third estate insisted on the vote by head, the graduated abolition of privilege in all governmental affairs, a written constitution and union. The programme went on broadening as it descended in the social scale.

The elections sufficed finally to show that the *ancien régime*, characterized from the social point of view by inequality, from

The elections.

the political point of view by arbitrariness, and from the religious point of view by intolerance, was completed from the administrative point of view by inextricable disorder. As even the extent of the jurisdiction of the *bailliages* was unknown, convocations were made at haphazard, according to the good pleasure of influential persons, and in these assemblies decisions were arrived at by a process that confused every variety of rights and powers, and was governed by no logical principle; and in this extreme confusion terms and affairs were alike involved.

Whilst the bureaucracy of the *ancien régime* sought for desperate

The counter-currents of the Revolution.

expedients to prolong its domination, the whole social body gave signs of a yet distant but ever nearing disintegration. The revolution was already complete before it was declared to the world. Two distinct currents of disaffection, one economic, the other philosophic, had for long been pervading the nation.

There had been much suffering throughout the 17th and 18th centuries; but no one had hitherto thought of a politico-social rising. But the other, the philosophic current, had been set going in the 18th century; and the policy of despotism tempered by privilege had been criticized in the name of liberty as no longer justifying itself by its services to the state. The ultramontane and oppressively burdensome church had been taunted with its lack of Christian charity, apostolic poverty and primitive virtue. All vitality had been sapped

from the old order of nobles, reduced in prestige by the *savonnette à vilains* (office purchased to ennoble the holder), enervated by court life, and so robbed of its roots in the soil, from which it had once drawn its strength, that it could no longer live save as a ruinous parasite on the central monarchy. Lastly, to come to the bottom of the social scale, there were the common people, taxable at will, subject to the arbitrary and burdensome forced labour of the *corvée*, cut off by an impassable barrier from the privileged classes whom they hated. For them the right to work had been asserted, among others by Turgot, as a natural right opposed to the caprices of the arbitrary and selfish aristocracy of the corporations, and a breach had been made in the tyranny of the masters which had endeavoured to set a barrier to the astonishing outburst of industrial force which was destined to characterize the coming age.

The outward and visible progress of the Revolution, due primarily to profound economic disturbance, was thus accelerated and rendered irresistible. Economic reformers found a moral justification for their dissatisfaction in philosophical theories; the chance conjunction of a philosopho-political idea with a national deficit led to the preponderance of the third estate at the elections, and to the predominance of the democratic spirit in the states-general. The third estate wanted civil liberty above all; political liberty came second only, as a means and guarantee for the former. They wanted the abolition of the feudal system, the establishment of equality and a share in power. Neither the family nor property was violently attacked; the church and the monarchy still appeared to most people two respectable and respected institutions. The king and the privileged classes had but so to desire it, and the revolution would be easy and peaceful.

Louis XVI. was reluctant to abandon a tittle of his absolute power, nor would the privileged classes sacrifice their time-honoured traditions; they were inexorable. The king, more ponderous and irresolute every day, vacillated between Necker the liberal on one side and Marie Antoinette, whose feminine pride was opposed to any concessions, with the comte d'Artois, a mischievous nobody who could neither choose a side nor stick to one, on the other. When the states-general opened on the 5th of May 1789 Louis XVI. had decided nothing. The conflict between him and the Assembly immediately broke out, and became acute over the verification of the mandates; the third estate desiring this to be made in common by the deputies of the three orders, which would involve voting by head, the suppression of classes and the preponderance of the third estate. On the refusal of the privileged classes and after an interval of six weeks, the third estate, considering that they represented 96% of the nation, and in accordance with the proposal of Sieyès, declared that they represented the nation and therefore were authorized to take resolutions unaided, the first being that in future no arrangement for taxation could take place without their consent.

Meeting of the states-general.

The king, urged by the privileged classes, responded to this first revolutionary act, as in 1614, by closing the Salle des Menus Plaisirs where the third estate were sitting; whereupon, gathered in one of the tennis-courts under the presidency of Bailly, they swore on the 20th of June not to separate before having established the constitution of the kingdom.

Oath of the tennis-court.

Louis XVI. then decided, on the 23rd, to make known his policy in a royal *lit de justice*. He declared for the lesser reform, the fiscal, not the social; were this rejected, he declared that "he alone would arrange for the welfare of his people." Meanwhile he annulled the sitting of the 17th, and demanded the immediate dispersal of the Assembly. The third estate refused to obey, and by the mouth of Bailly and Mirabeau asserted the legitimacy of the Revolution. The refusal of the soldiers to coerce the Assembly showed that the monarchy could no longer rely on the army; and a few days later, when the lesser nobility and the lower ranks of the clergy had united with the third estate whose cause was their own, the king yielded, and on the 27th of June commanded both orders to join in the National Assembly, which was thereby

The Lit de Justice of June 23, 1789.

recognized and the political revolution sanctioned. But at the same time, urged by the "infernal cabal" of the queen and the comte d'Artois, Louis XVI. called in the foreign regiments—the only ones of which he could be certain—and dismissed Necker. The Assembly, dreading a sudden attack, demanded the withdrawal of the troops. Meeting with a refusal, Paris opposed the king's army with her citizen-soldiers; and by the taking of the Bastille, that mysterious dark fortress which personified the *ancien régime*, secured the triumph of the Revolution (July 14). The king was obliged to recall Necker, to mount the tricolor cockade at the Hôtel de Ville, and to recognize Bailly as mayor of Paris and La Fayette as commander of the National Guard, which remained in arms after the victory. The National Assembly had right on its side after the 20th of June and might after the 14th of July. Thus was accomplished the Revolution which was to throw into the melting-pot all that had for centuries appeared fixed and stable.

As Paris had taken her Bastille, it remained for the towns and country districts to take theirs—all the Bastilles of feudalism.

Want, terror and the contagion of examples precipitated the disruption of governmental authority and of the old political status; and sudden anarchy dislocated all the organs of authority. Upon the ruins of the central administration temporary authorities were founded in various isolated localities, limited in area but none the less defiant of the government. The provincial assemblies of Dauphiné and elsewhere gave the signal; and numerous towns, following the example of Paris, instituted municipalities which substituted their authority for that of the intendants and their subordinates. Clubs were openly organized, pamphlets and journals appeared, regardless of administrative orders; workmen's unions multiplied in Paris, Bordeaux and Lyons, in face of drastic prohibition; and anarchy finally set in with the defection of the army in Paris on the 23rd of June, at Nancy, at Metz and at Brest. The crying abuses of the old régime, an insignificant factor at the outset, soon combined with the widespread agrarian distress, due to the unjust distribution of land, the disastrous exploitation of the soil, the actions of the government, and the severe winter of 1788. Discontent showed itself in pillage and incendiarism on country estates; between March and July 1789 more than three hundred agrarian riots took place, uprooting the feudal idea of property, already compromised by its own excesses. Not only did pillaging take place; the boundaries or property were also ignored, and people no longer held themselves bound to pay taxes. These *jacqueries* hastened the movement of the regular revolution.

The decrees of the 4th of August, proposed by those noble "patriots" the duc d'Aiguillon and the vicomte de Noailles, who had already on the 23rd of June made armed resistance to the evacuation of the Hall of Assembly, put the final touch to the revolution begun by the provincial assemblies, by liberating land and labour, and proclaiming equality among all Frenchmen. Instead of exasperating the demands of the peasants and workmen by repression and raising civil war between the bourgeoisie and the proletariat, they drew a distinction between personal servitude, which was suppressed, and the rights of contract, which were to be redeemed—a laudable but impossible distinction. The whole feudal system crumbled before the revolutionary insistence of the peasants; for their masters, bourgeois or nobles, terrified by prolonged riots, capitulated and gradually had to consent to make the resolutions of the 4th of August a reality.

Overjoyed by this social liberation, the Assembly awarded Louis XVI. the title of "renewer of French liberty"; but remaining faithful to his hesitating policy of the 23rd of June, he ratified the decrees of the 4th of August, only with a very ill grace. On the other hand, the privileged classes, and notably the clergy, who saw the whole traditional structure of their power threatened, now rallied to him, and when after the 28th of August the Assembly

set to work on the new constitution, they combined in the effort to recover some of the position they had lost. But whatever their theoretical agreement on social questions, politically they were hopelessly at odds. The bourgeoisie, conscious of their opportunity, decided for a single chamber against the will of the noblesse; against that of the king they declared it permanent, and, if they accorded him a suspensory veto, this was only in order to guard them against the extreme assertion of popular rights. Thus the progress of the Revolution, so far, had left the mass of the people still excluded from any constitutional influence on the government, which was in the hands of the well-to-do classes, which also controlled the National Guard and the municipalities. The irritation of the disfranchised proletariat was moreover increased by the appalling dearness of bread and food generally, which the suspicious temper of the times—fomented by the tirades of Marat in the *Ami du peuple*—ascribed to English intrigues in revenge for the aid given by France to the American colonies, and to the treachery in high places that made these intrigues successful. The climax came with the rumour that the court was preparing a new military *coup d'état*, a rumour that seemed to be confirmed by indiscreet toasts proposed at a banquet by the officers of the guard at Versailles; and on the night of the 5th to the 6th of October a Parisian mob forced the king and royal family to return with them to Paris amid cries of "We are bringing the baker, the baker's wife and the little baker's boy!" The Assembly followed; and henceforth king and Assembly were more or less under the influence of the whims and passions of a populace maddened by want and suspicion, by the fanatical or unscrupulous incitements of an unfettered press, and by the unrestrained oratory of obscure demagogues in the streets, the cafés and the political clubs.

Convened for the purpose of elaborating a system that should conciliate all interests, the Assembly thus found itself forced into a conflict between the views of the people, who feared betrayal, and the court, which dreaded being overwhelmed. This schism was reflected in the parties of the Assembly, the absolutists of the extreme Right; the moderate monarchists of the Right and Centre; the constitutionalists of the Left Centre and Left; and, finally, on the extreme Left the democratic revolutionists, among whom Robespierre sat as yet all but unnoticed. Of talent there was enough and to spare in the Assembly; what was conspicuously lacking was common sense and a practical knowledge of affairs. Of all the orators who declaimed from the tribune, Mirabeau alone realized the perils of the situation and possessed the power of mind and will to have mastered them. Unfortunately, however, he was discredited by a disreputable past, and yet more by the equivocal attitude he had to assume in order to maintain his authority in the Assembly while working in what he believed to be the true interests of the court. His political ideal for France was that of the monarchy, rescued from all association with the abuses of the old régime and "broad-based upon the people's will"; his practical counsel was that the king should frankly proclaim this ideal to the people as his own, should compete with the Assembly for popular favour, while at the same time using every means to win over those by whom his authority was flouted. For a time Mirabeau influenced the counsels of the court through the comte de Montmorin; but the king neither trusted him nor could be brought to see his point of view, and Marie Antoinette, though she resigned herself to negotiating with him, was very far from sympathizing with his ideals. Finally, all hope of the conduct of affairs being entrusted to him was shattered when the Assembly passed a law forbidding its members to become ministers.

The attempted reconciliation with the king having failed, the Assembly ended by working alone, and made the control that it should have exerted an instrument, not of co-operation but of strife. It inaugurated its legislative labours by a metaphysical declaration of the Rights of Man and of the Citizen (October 2, 1789). This enunciation of universal verities, the bulk of which have, sooner

**Taking
of the
Bastille.**

**Spontaneous
anarchy.**

**The
night of
August 4.**

**Elaboration
of the
constitution.**

**Declaration
of the
rights of
man.**

or later, been accepted by all civilized nations as "the gospel of modern times," was inspired by all the philosophy of the 18th century in France and by the *Contrat Social*. It comprised various rational and humane ideas, no longer theological, but profoundly and deliberately thought out: ideas as to the sovereign-right of the nation, law by general consent, man superior to the pretensions of caste and the fetters of dogma, the vindication of the ideal and of human dignity. Unable to rest on historic precedent like England, the Constituent Assembly took as the basis for its labours the tradition of the thinkers.

Upon the principles proclaimed in this Declaration the constitution of 1791 was founded. Its provisions are discussed elsewhere (see the section below on *Law and Institutions*); here it will suffice to say that it established under the sovereign people, for the king was to survive merely as the supreme executive official, a wholly new model of government in France, both in Church and State. The historic divisions of the realm were wiped out; for the old provinces were substituted eighty-three departments; and with the provinces vanished the whole organization, territorial, administrative and ecclesiastical, of the *ancien régime*. In one respect, indeed, the system of the old monarchy remained intact; the tradition of centralization established by Louis XIV. was too strong to be overthrown, and the destruction of the historic privileges and immunities with which this had been ever in conflict only served to strengthen this tendency. In 1791 France was pulverized into innumerable administrative atoms incapable of cohesion; and the result was that Paris became more than ever the brain and nerve-centre of France. This fact was soon to be fatal to the new constitution, though the administrative system established by it still survives. Paris was in effect dominated by the armed and organized proletariat, and this proletariat could never be satisfied with a settlement which, while proclaiming the sovereignty of the people, had, by means of the property qualification for the franchise, established the political ascendancy of the middle classes. The settlement had, in fact, settled nothing; it had, indeed, merely intensified the profound cleavage between the opposing tendencies; for if the democrats were alienated by the narrow franchise, the Civil Constitution of the Clergy, which cut at the very roots of the Catholic system, drove into opposition to the Revolution not only the clergy themselves but a vast number of their flocks.

The policy of the Assembly, moreover, hopelessly aggravated its misunderstanding with the king. Louis, indeed, accepted the constitution and attended the great Feast of Federation (July 14, 1790), when representatives from all the new departments assembled in the Champ de Mars to ratify the work of the Assembly; but the king either could not or would not say the expected word that would have dissipated mistrust. The Civil Constitution of the Clergy, too, seemed to him not only to violate his rights as a king, but his faith as a Christian also; and when the emigration of the nobility and the death of Mirabeau (April 2, 1791) had deprived him of his natural supporters and his only adviser, resuming the old plan of withdrawing to the army of the marquis de Bouillé at Metz, he made his ill-fated attempt to escape from Paris (June 20, 1791). The flight to Varennes was an irreparable error; for during the king's absence and until his return the insignificance of the royal power became apparent. La Fayette's fusillade of the republicans, who demanded the deposition of the king (July 17, 1791), led to a definite split between the democratic party and the bourgeois party. Vainly did Louis, brought back a captive to Paris, swear on the 14th of September 1791 solemnly mere lip-service to the constitution; the mistrustful party of revolution abandoned the constitution they had only just obtained, and to guard against the sovereign's mental reservations and the selfish policy of the middle classes, appealed to the main force of the people. The conflict between the *ancien régime* and the National Assembly ended in the defeat of the royalists.

Through lassitude or disinterestedness the men of 1791, on

Robespierre's suggestion, had committed one last mistake, by leaving the task of putting the constitution into practice to new men even more inexperienced than themselves. Thus the new Assembly's time was occupied in a conflict between the Legislative Assembly and the king, who plotted against it; and, as a result, the monarchy, insulted by the proceedings of the 20th of June, was eliminated altogether by those of the 10th of August 1792.

The new Assembly which had met on the 1st of October 1791 had a majority favourable to the constitutional monarchy and to the bourgeois franchise. But, among these bourgeois those who were called Feuillants, from the name of their club (see FEUILLANTS, CLUB OF THE), desired the strict and loyal application of the constitution without encroaching upon the authority of the king; the triumvirate, Duport, Barnave and Lameth, were at the head of this party. The Jacobins, on the contrary, considered that the king should merely be hereditary president of the Republic, to be deposed if he attempted to violate the constitution, and that universal suffrage should be established. The dominant group among these was that of the Girondins or Girondists, so called because its most brilliant members had been elected in the Gironde (see GIRONDISTS). But the republican party was more powerful without than within. Their chief was not so much Robespierre, president of the parliamentary and bourgeois club of the Jacobins (*q.v.*), which had acquired by means of its two thousand affiliated branches great power in the provinces as the advocate Danton, president of the popular and Parisian club of the Cordeliers (*q.v.*). Between the Feuillants and the Jacobins, the independents, incapable of keeping to any fixed programme, vacillated sometimes to the right, sometimes to the left.

But the best allies of the republicans against the Feuillants were the royalists pure and simple, who cared nothing about the constitution, and claimed to "extract good from the excess of evil." The election of a Jacobin, Pétion, instead of Bailly, the resigning mayor, and La Fayette, the candidate for office, was their first achievement. The court, on its side, showed little sign of a conciliatory spirit, though, realizing its danger, it attempted to restrain the foolish violence of the *émigrés*, *i.e.* the nobles who after the suppression of titles of nobility in 1790 and the arrest of the king at Varennes, had fled in a body to Coblenz and joined Louis XVI.'s brothers, the counts of Provence and Artois. They it was who set in motion the national and European conflict. Under the prince of Condé they had collected a little army round Trier; and in concert with the "Austrian Committee" of Paris they solicited the armed intervention of monarchical Europe. The declaration of Pillnitz, which was but an excuse for non-interference on the part of the emperor and the king of Prussia, interested in the prolongation of these internal troubles, was put forward by them as an assurance of forthcoming support (August 27, 1791).

At the same time the application of the Civil Constitution of the Clergy roused the whole of western La Vendée; and in face of the danger threatened by the refractory clergy and by the army of the *émigrés*, the Girondins set about confounding the court with the Feuillants in the minds of the public, and compromising Louis XVI. by a national agitation, denouncing him as an accomplice of the foreigner. Owing to the decrees against the comte de Provence, the emigrants, and the refractory priests, voted by the Legislative Assembly in November 1791, they forced Louis XVI. to show his hand by using his veto, so that his complicity should be plainly declared, to replace his Feuillant ministry—disparate in birth, opinions and ambitions—by the Girondin ministry of Dumouriez-Roland (March 10), no more united than the other, but believers in a republican crusade for the overthrow of thrones, that of Louis XVI. first of all; and finally to declare war against the king of Bohemia and Hungary, a step also desired by the court in the hope of ridding itself of the Assembly at the first note of victory (April 20, 1792).

The Legislative Assembly (Oct. 1, 1791-Sept. 20, 1792).

The constitution.

The parties.

Royalist intrigues.

The émigrés.

Declaration of Pillnitz.

The decrees.

The war.

But when, owing to the disorganization of the army through emigration and desertion, the ill-prepared Belgian war was followed by invasion and the trouble in La Vendée increased, all France suspected a betrayal. The Assembly, in order to reduce the number of hostile forces, voted for the exile of all priests who had refused to swear to the Civil Constitution and the substitution of a body of twenty thousand volunteer national guards, under the authority of Paris for the king's constitutional guard (May 27-June 8, 1792). Louis XVI's veto and the dismissal of the Girondin ministry—thanks to an intrigue of Dumouriez, analogous to that of Mirabeau and as ineffectual—dismayed the Feuillants and maddened the Girondins; the latter, to avert popular fury, turned it upon the king. The *émeute* of the 20th of June, a burlesque which, but for the persistent good-humour of Louis XVI., might have become a tragedy, alarmed but did not overthrow the monarchy.

The bourgeoisie, the Assembly, the country and La Fayette, one of the leaders of the army, now embarked upon a royalist reaction, which, would perhaps have been efficacious, had it not been for the entry into the affair of the Prussians as allies of the Austrians, and for the insolent manifesto of the duke of Brunswick. The Assembly's cry of "the country in danger" (July 11) proved to the nation that the king was incapable of defending France against the foreigner; and the appeal of the federal volunteers in Paris gave to the opposition, together with the war-song of the Marseillaise, the army which had been refused by Louis XVI., now disarmed. The vain attempts of the Gironde to reconcile the king and the Revolution, the ill-advised decree of the Assembly on the 8th of August, freeing La Fayette from his guilt in forsaking his army; his refusal to vote for the deposition of the king, and the suspected treachery of the court, led to the success of the republican forces when, on the 10th of August, the mob of Paris organized by the revolutionary Commune rose against the monarchy.

The suspension and imprisonment of the king left the supreme authority nominally in the hands of the Assembly, but actually in those of the Commune, consisting of delegates from the administrative sections of Paris. Installed at the Hôtel de Ville this attempted to influence the discredited government, entered into conflict with the Legislative Assembly, which considered its mission at an end, and paralyzed the action of the executive council, particularly during the bloody days of September, provoked by the discovery of the court's intrigues with the foreigner, by the treachery of La Fayette, the capture of Longwy, the investiture of Verdun by the Prussians (August 19-30), and finally by the incendiary placards of Marat. Danton, a master of diplomatic and military operations, had to avoid any rupture with the Commune. Fortunately, on the very day of the dispersal of the Legislative Assembly, Dumouriez saved France from a Prussian invasion by the victory of Valmy, and by unauthorized negotiations which prefigured those of Bonaparte at Léoben (September 22, 1792).

The popular insurrection against Louis XVI. determined the simultaneous fall of the bourgeois régime and the establishment of the democracy in power. The Legislative Assembly, without a mandate for modifying a constitution that had become inapplicable with the suspension of the monarch, had before disappearing convoked a National Convention, and as the reward of the struggle for liberty had replaced the limited franchise by universal suffrage. Public opinion became republican from an excess of patriotism, and owing to the propaganda of the Jacobin club; while the decree of the 25th of August 1792, which marked the destruction of feudalism, now abolished in principle, caused the peasants to rally definitely to the Republic.

This had hardly been established before it became distracted by the fratricidal strife of its adherents, from September 22, 1792, to the 18th Fructidor (September 4, 1797). The electoral

assemblies, in very great majority, had desired this Republic to be democratic and equalizing in spirit, but on the face of it, liberal, uniform and propagandist; in consequence, the 782 deputies of the Convention were not divided on principles, but only by personal rivalries and ambition. They all wished for a unanimity and harmony impossible to obtain; and being unable to convince they destroyed one another.

The Girondins in the Convention played the part of the Feuillants in the Legislative Assembly. Their party was not well disciplined, they purposely refrained from making it so, and hence their ruin. Oratorically they represented the spirit of the South; politically, the ideas of the bourgeoisie in opposition to the democracy—which they despised although making use of it—and the federalist system, from an objection to the preponderance of Paris. Paris, on the other hand, had elected only deputies of the Mountain, as the more advanced of the Jacobins were called, that party being no more settled and united than the others. They drew support from the Parisian democracy, and considered the decentralization of the Girondins as endangering France's unity, circumstances demanding a strong and highly concentrated government; they opposed a republic on the model of that of Rome to the Polish republic of the Gironde. Between the two came the *Plaine*, the *Marais*, the troop of trembling bourgeois, sincerely attached to the Revolution, but very moderate in the defence of their ideas; some seeking a refuge from their timidity in hard-working committees, others partaking in the violence of the Jacobins out of weakness or for reasons of state.

The Girondins were the first to take the lead; in order to retain it they should have turned the Revolution into a government. They remained an exclusive party, relying on the mob but with no influence over it. Without a leader or popular power, they might have found both in Danton; for, occupied chiefly with the external danger, he made advances towards them, which they repulsed, partly in horror at the proceedings of September, but chiefly because they saw in him the most formidable rival in the path of the government. They waged war against him as relentlessly as did the Constitutionals against Mirabeau, whom he resembled in his extreme ugliness and his volcanic eloquence. They drove him into the arms of Robespierre, Marat and the Commune of Paris. On the other hand, after the 23rd of September they declared Paris dangerous for the Convention, and wanted to reduce it to "eighty-three influential members." Danton and the Mountain responded by decreeing the unity and indivisibility of the Republic, in order to emphasize the suspicions of federalism which weighed upon the Girondins.

The trial of Louis XVI. still further enhanced the contrasts of ideas and characters. The discovery of fresh proofs of treachery in the iron chest (November 20, 1792) gave the Mountain a pretext for forcing on the clash of parties and raising the question not of legality but of public safety. By the execution of the king (January 21, 1793) they "cast down a king's head as a challenge to the kings of Europe." In order to preserve popular favour and their direction of the Republic, the Girondins had not dared to pronounce against the sentence of death, but had demanded an appeal to the people which was rejected; morally weakened by this equivocal attitude they were still more so by foreign events.

The king's death did not result in the unanimity so much desired by all parties; it only caused the reaction on themselves of the hatred which had been hitherto concentrated upon the king, and also an augmentation in the armies of the foreigner, which obliged the revolutionists to face all Europe. There was a coalition of monarchs, and the people of La Vendée rose in defence of their faith. Dumouriez, the conqueror of Jemappes (November 6, 1792), who invaded Holland, was beaten by the Austrians (March 1793). A levy of 300,000 men was ordered; a Committee of General Security was charged with the search for suspects; and thenceforward military occurrences called forth parliamentary crises

The Convention, Sept. 21, 1792-Oct. 26, 1795.

The parties.

The Girondins.

Trial and death of Louis XVI.

First European coalition.

Proceedings of June 20.

Manifesto of Brunswick.

The insurrectional commune of Paris.

The September massacres.

and popular upheavals. Girondins and Jacobins unjustly accused one another of leaving the traitors, the conspirators, the "stipendiaries of Coblenz" unpunished. To avert the danger threatened by popular dissatisfaction, the Gironde was persuaded to vote for the creation of a revolutionary tribunal to judge suspects, while out of spite against Danton who demanded it, they refused the strong government which might have made a stand against the enemy (March 10, 1793). This was the first of the exceptional measures which were to call down ruin upon them. Whilst the insurrection in La Vendée was spreading, and Dumouriez falling back upon Neerwinden, sentence of death was laid upon *émigrés* and refractory priests; the treachery of Dumouriez, disappointed in his Belgian projects, gave grounds

First committee of public safety. for all kinds of suspicion, as that of Mirabeau had formerly done, and led the Gironde to propose the new government which they had refused to Danton. The transformation of the provisional executive council into the Committee of Public Safety—omnipotent save in financial matters—was voted because the Girondins meant to control it; but Danton got the upper hand (April 6).

The Girondins, discredited in Paris, multiplied their attacks upon Danton, now the master: they attributed the civil war and the disasters of the foreign campaign to the despotism of the Paris Commune and the clubs; they accused Marat of instigating the September massacres; and they began the supreme struggle by demanding the election of a committee of twelve deputies, charged with breaking up the anarchic authorities in Paris (May 18).

Struggle between the commune and the Gironde. The complete success of the Girondin proposals; the arrest of Hébert—the violent editor of the *Père Duchêne*; the insurrection of the Girondins of Lyons against the Montagnard Commune; the bad news from La Vendée—the military reverses; and the economic situation which had compelled the fixing of a maximum price of corn (May 4) excited the "moral insurrections" of May 31 and June 2. Marat himself sounded the tocsin, and Hanriot, at the head of the Parisian army, surrounded the Convention. Despite the efforts of Danton and the Committee of Public Safety, the arrest of the Girondins sealed the victory of the Mountain.

The threat of the Girondin Isnard was fulfilled. The federalist insurrection, to avenge the violation of national representation, responded to the Parisian insurrection. Sixty-nine departmental governments protested against the violence done to the Convention; but the ultra-democratic constitution of 1793 deprived the Girondins,

Fall of the Gironde. who were arming in the west, the south and the centre, of all legal force. To the departments that were hostile to the dictatorship of Paris, and the tyranny of Danton or Robespierre, it promised the referendum, an executive of twenty-four citizens, universal suffrage, and the free exercise of religion. The populace, who could not understand this parliamentary quarrel, and were in a hurry to set up a national defence, abandoned the Girondins, and the latter excited the enthusiasm of only one person, Charlotte Corday, who by the murder of Marat ruined them irretrievably. The battle of Brécourt was a defeat without a fight for their party without stamina and their general without troops (July 13); while on the 31st of October their leaders perished on the guillotine, where they had been preceded by the queen, Marie Antoinette. The Girondins and their adversaries were differentiated by neither religious dissensions nor political divergency, but merely by a question of time. The Girondins, when in power, had had scruples which had not troubled them while scaling the ladder; idols of Paris, they had flattered her in turn, and when Paris scorned them they sought support in the provinces. A great responsibility for this defeat of the liberal and republican bourgeoisie, whom they represented, is to be laid upon Madame Roland, the Egeria of the party. An ardent patriot and republican, her relations with Danton resembled those of Marie Antoinette with Mirabeau, in each case a woman spoilt by flattery, enraged at indifference. She was the ruin of the Gironde, but taught it how to die.

The fall of the Gironde left the country disturbed by civil war,

and the frontiers more seriously threatened than before Valmy. Bouchotte, a totally inefficient minister for war, the Commune's man of straw, left the army without food or ammunition, while the suspected officers remained inactive. In the Angevin Vendée the incapable leaders let themselves be beaten at Aubiers, Beaupréau and Thouars, at a time when Cathelineau was taking possession of Saumur and threatening Nantes, the capture of which would have permitted the insurgents in La Vendée to join those of Brittany and receive provisions from England. Meanwhile, the remnants of the Girondin federalists were overcome by the disguised royalists, who had aroused the whole of the Rhône valley from Lyons to Marseilles, had called in the Sardinians, and handed over the fleet and the arsenal at Toulon to the English, whilst Paoli left Corsica at their disposal. The scarcity of money due to the discrediting of the assignats, the cessation of commerce, abroad and on the sea, and the bad harvest of 1793, were added to all these dangers, and formed a serious menace to France and the Convention.

This meant a hard task for the first Committee of Public Safety and its chief Danton. He was the only one to understand the conditions necessary to a firm government; he caused the adjournment of the decentralizing constitution of 1793, and set up a revolutionary government. The Committee of Public Safety, now a permanency, annulled the Convention and was itself the central authority, its organization in Paris being the twelve committees substituted for the provisional executive committee and the six ministers, the Committee of General Security for the maintenance of the police, and the arbitrary Revolutionary Tribunal. The execution of its orders in the departments was carried out by omnipotent representatives "on mission" in the armies, by popular societies—veritable missionaries of the Revolution—and by the revolutionary committees which were its backbone.

Despite this Reign of Terror Danton failed; he could neither dominate foes within nor divide those without. Representing the sane and vigorous democracy, and like Jefferson a friend to liberty and self-government, he had been obliged to set up the most despotic of governments in face of internal anarchy and foreign invasion. Being of a temperament that expressed itself only in action, and neither a theorist nor a cabinet-minister, he held the views of a statesman without having a following sufficient to realize them. Moreover, the proceedings of the 2nd of June, when the Commune of Paris had triumphed, had dealt him a mortal blow. He is his turn tried to stem the tumultuous current which had borne him along, and to prevent discord; but the check to his policy of an understanding with Prussia and with Sardinia, to whom, like Richelieu and D'Argenson, he offered the realization of her transalpine ambition in exchange for Nice and Savoy, was added to the failure of his temporizing methods in regard to the federalist insurgents, and of his military operations against La Vendée. A man of action and not of cunning shifts, he succumbed on the 10th of July to the blows of his own government, which had passed from his hands into those of Robespierre, his ambitious and crafty rival.

The second Committee of Public Safety lasted until the 27th of July 1794. Composed of twelve members, re-eligible every month, and dominated by the triumvirate, Robespierre, Saint-Just and Couthon, it was stronger than ever, since it obtained the right of appointing leaders, disposed of money, and muzzled the press.

Second committee of public safety. Many of its members were sons of the bourgeoisie, men who having been educated at college, thanks to some charitable agency, in the pride of learning, and raised above their original station, were ready for anything but had achieved nothing. They had plenty of talent at command, were full of classical tirades against tyranny, and, though sensitive enough in their private life, were bloodthirsty butchers in their public relations. Such were Robespierre, Saint-Just, Couthon, Billaud-Varenne, Cambon, Thuriot, Collot d'Herbois, Barrère and Prieur de la Marne. Working hand in hand with these politicians, not

The dictatorship of the first committee of public safety.

Danton's failure.

always in accordance with them, but preserving a solid front, were the specialists, Carnot, Robert Lindet, Jean Bon Saint-André and Prieur de la Côte d'Or, honourable men, anxious above all to safeguard their country. At the head of the former type Robespierre, without special knowledge or exceptional talent, devoured by jealous ambition and gifted with cold grave eloquence, enjoyed a great moral ascendancy, due to his incorruptible purity of life and the invariably correct behaviour that had been wanting in Mirabeau, and by the persevering will which Danton had lacked. His marching orders were: no more temporizing with the federalists or with generals who are afraid of conquering; war to the death with all Europe in the name of revolutionary propaganda and the monarchical tradition of natural frontiers; and fear, as a means of government. The specialists answered foreign foes by their organization of victory; as for foes at home, the triumvirate crushed them beneath the Terror.

France was saved by them and by that admirable outburst of patriotism which provided 750,000 patriots for the army through the general levy of the 16th of August 1793, aided, moreover, by the mistakes of her enemies. Instead of profiting by Dumouriez's treachery and the successes in La Vendée, the Coalition, divided over the resuscitated Polish question, lost time on the frontiers of this new Poland of the west which was sacrificing itself for the sake of a Universal Republic. Thus in January 1794 the territory of France was cleared of the Prussians and Austrians by the victories at Hondschoote, Wattignies and Wissembourg; the army of La Vendée was repulsed from Granville, overwhelmed by Hoche's army at Le Mans and Savenay, and its leaders shot; royalist sedition was suppressed at Lyons, Bordeaux, Marseilles and Toulon; federalist insurrections were wiped out by the terrible massacres of Carrier at Nantes, the atrocities of Lebon at Arras, and the wholesale executions of Fouché and Collot d'Herbois at Lyons; Louis XVI. and Marie Antoinette guillotined, the *émigrés* dispersed, denied or forsaken by all Europe.

But the triumphant Mountain was not as united as it boasted. The second Committee of Public Safety had now to struggle against two oppositions: one of the left, represented by Hébert, the Commune of Paris and the Cordeliers; another of the right, Danton and his followers. The former would not admit that the Terror was only a temporary method of defence; for them it was a permanent system which was even to be strengthened in order to crush all who were hostile to the Revolution. Their sanguinary violence was combined with an anti-religious policy, not atheistical, but inspired by mistrust of the clergy, and by a civic and deistic creed that was a direct outcome of the federations. To these latter were due the substitution of the Republican for the Gregorian calendar, and the secular Feasts of Reason (November 19, 1793). The followers of Hébert wanted to push forward the movement of May 31, 1793, in order to become masters in their turn; while those of Danton were by way of arresting it. They considered it

time to re-establish the reign of ordinary laws and justice; sick of bloodshed, with Camille Desmoulins they demanded a "Committee of Clemency." A deist and therefore hostile to "anti-religious masquerades," while uneasy at the absolute authority of the Paris Commune, which aimed at suppressing the State, and at its armed propaganda abroad, Robespierre resumed the struggle against its illegal power, so fatal to the Gironde. His boldness succeeded (March 24, 1794), and then, jealous of Danton's activity and statesmanship, and exasperated by the jeers of his friends, he rid himself of the party of tolerance by a parody of justice (April 5).

Robespierre now stood alone. During five months, while affecting to be the representative of "a reign of justice and virtue," he laboured at strengthening his politico-religious dictatorship—already so formidably armed—with new powers. "The incorruptible wanted to become the invulnerable" and the scaffold of the guillotine was crowded. By his dogma of the supreme state

Robespierre founded a theocratic government with the police as an Inquisition. The festival of the new doctrine, which turned the head of the new pontiff (June 8), the *loi de Prairial*, or "code of legal murder" (June 10), which gave the deputies themselves into his hand; and the multiplication of executions at a time when the victory of Fleurus (June 25) showed the uselessness and barbarity of this aggravation of the Reign of Terror provoked against him the victorious coalition of revenge, lassitude and fear. Vanquished and imprisoned, he refused to take part in the illegal action proposed by the Commune against the Convention. Robespierre was no man of action. On the 9th Thermidor (July 27, 1794) he fell into the gulf that had opened on the 31st of May, and through which the 18th Brumaire was visible.

Although brought about by the Terrorists, the tragic fall of Robespierre put an end to the Reign of Terror; for their chiefs having disappeared, the subordinates were too much divided to keep up the dictatorship of the third Committee of Public Safety, and reaction soon set in. After a change in *personnel* in favour of the surviving Dantonists, came a limitation to the powers of the Committee of Public Safety, now placed in dependence upon the Convention; and next followed the destruction of the revolutionary system, the Girondin decentralization and the resuscitation of departmental governments; the reform of the Revolutionary Tribunal on the 10th of August; the suppression of the Commune of Paris on the 1st of September, and of the salary of forty *sous* given to members of the sections; the abolition of the maximum, the suppression of the Guillotine, the opening of the prisons, the closing of the Jacobin club (November 11), and the henceforward insignificant existence of the popular societies.

Power reverted to the Girondins and Dantonists, who re-entered the Convention on the 18th of December; but with them re-entered likewise the royalists of Lyons, Marseilles and Toulon, and further, after the peace of Basel, many young men set free from the army, hostile to the Jacobins and defenders of the now moderate and peace-making Convention. These *muscadins* and *incroyables*, led by Fréron, Tallien and Barras—former revolutionists who had become aristocrats—profited by the restored liberty of the press to prepare for days of battle in the salons of the *merveilleuses* Madame Tallien, Madame de Staël and Madame Récamier, as the *sans-culottes* had formerly done in the clubs. The remnants of Robespierre's faction became alarmed at this Thermidor reaction, in which they scented royalism. Aided by famine, by the suppression of the maximum, and by the imminent bankruptcy of the assignats, they endeavoured to arouse the working classes and the former Harriot companies against a government which was trying to destroy the republic, and had broken the busts of Marat and guillotined Carrier and Fouquier-Tinville, the former public prosecutor. Thus the risings of the 12th Germinal (April 1, 1795) and of the 1st Prairial (May 20) were economic revolts rather than insurrections excited by the deputies of the Mountain; in order to suppress them the reactionaries called in the army. Owing to this first intervention of the troops in politics, the Committee of Public Safety, which aimed not so much at a moderate policy as at steering a middle course between the Thermidorians of the Right and of the Left, was able to dispense with the latter.

The royalists now supposed that their hour had come. In the south, the companions of Jehu and of the Sun inaugurated a "White Terror," which had not even the apparent excuse of the public safety or of exasperated patriotism. At the same time they prepared for a twofold insurrection against the republic—in the west with the help of England, and in the east with that of Austria—by an attempt to bribe General Pichegru. But though the heads of the government wanted to put an end to the Revolution they had no thought of restoring the monarchy in favour of the Comte de Provence, who had taken the title of Louis XVIII. on hearing of the death of the dauphin in the Temple, and still less of bringing

9th Thermidor.

Third committee of public safety.

Resuscitation of the royalist party.

Popular risings of Germinal and Prairial.

The white terror.

Defeat of the coalition.

The new parties.

The party of tolerance.

Robespierre's dictatorship.

back the *ancien régime*. Hoche crushed the insurrection of the Chouans and the Bretons at Quiberon on the 2nd of July 1795, and Pichegru, scared, refused to entangle himself any further.

To cut off all danger from royalists or terrorists the Convention now voted the Constitution of the year III.; suppressing that

The constitution of the year III.

of 1793, in order to counteract the terrorists, and re-establishing the bourgeois limited franchise with election in two degrees—a less liberal arrangement than that granted from 1789 to 1792. The chambers of the

Five Hundred and of the Ancients were elected by the moneyed and intellectual aristocracy, and were to be re-elected by thirds annually. The executive authority, entrusted to five Directors, was no more than a definite and very strong Committee of Public Safety; but Sieyès, the author of the new constitution, in opposition to the royalists, had secured places of refuge for his party by reserving posts as directors for the regicides, and two-thirds of the deputies' seats for members of the Convention. In self-

The 13th Vendémiaire.

defence against this continuance of the policy and the *personnel* of the Convention—a modern “Long Parliament”—the royalists, persistent street-fighters and masters in the “sections” after the suppression of

the daily indemnification of forty *sous*, attempted the insurrection of the 13th Vendémiaire (October 5, 1795), which was easily put down by General Bonaparte.

Thus the bourgeois republic reaped the fruits of its predecessor's external policy. After the freeing of the land in January 1794

Military achievements of the convention.

an impulse had been given to the spirit of conquest which had gradually succeeded to the disinterested fever of propaganda and overheated patriotism. This it was which had sustained Robespierre's dictatorship; and, owing to the “amalgam” and the re-establishment of

discipline, Belgium and the left bank of the Rhine had been conquered and Holland occupied, simultaneously with Kosciusko's rising in Poland, Prussia's necessity of keeping and extending her Polish acquisitions, Robespierre's death, the prevalent desires of the majority, and the continued victories of Pichegru, Jourdan and Moreau, enfeebled the coalition. At Basel (April-

Treaty of Basel.

July 1795) republican France, having rejoined the concert of Europe, signed the long-awaited peace with Prussia, Spain, Holland and the grand-duke of Tuscany.

But thanks to the past influence of the Girondin party, who had caused the war, and of the regicides of the Mountain, this peace not only ratified the conquest of Belgium, the left bank of the Rhine and Santo Domingo, but paved the way for fresh conquests; for the old spirit of domination and persistent hostility to Austria attracted the destinies of the Revolution definitely towards war.

The work of internal construction amidst this continued battle against the whole world had been no less remarkable. The

Internal achievements.

Constituent Assembly had been more destructive than constructive; but the Convention preserved intact those fundamental principles of civil liberty which had been the main results of the Revolution: the

equality so dear to the French, and the sovereignty of the people—the foundation of democracy. It also managed to engage private interests in state reform by creating the Grand Livre de la Dette Publique (September 13-26, 1793), and enlisted peasant and bourgeois savings in social reforms by the distribution and sale of national property. But with views reaching beyond equality of rights to a certain equality of property, the committees, as regards legislation, poor relief and instruction, laid down principles which have never been realized, save in the matter of the metric system; so that the Convention which was dispersed on the 16th of October 1795 made a greater impression on political history and social ideas than on institutions. Its disappearance left a great blank.

During four years the Directory attempted to fill this blank. Being the outcome of the Constitution of the year III., it should have been the organizing and pacifying government of the Republic; in reality it sought not to create, but to preserve its own existence. Its internal weakness, between the danger of anarchy and the opposition of the monar-

chists, was extreme; and it soon became discredited by its own *coups d'état* and by financial impotence in the eyes of a nation sick of revolution, aspiring towards peace and the resumption of economic undertakings. As to foreign affairs, its aggressive policy imperilled the conquests that had been the glory of the Convention, and caused the frontiers of France, the defence of which had been a point of honour with the Republic, to be called in question. Finally, there was no real government on the part of the five directors: La Révellière-Lépeaux, an honest man but weak; Reubell, the negotiator of the Hague; Letourneur, an officer of talent; Barras, a man of intrigue, corrupt and without real convictions; and Carnot, the only really worthy member. They never understood one another, and never consulted together in hours of danger, save to embroil matters in politics as in war. Leaning on the bourgeois, conservative, liberal and anti-clerical republicans, they were no more able than was the Thermidor party to re-establish the freedom that had been suspended by revolutionary despotism; they created a ministry of police, interdicted the clubs and popular societies, distracted the press, and with partiality undertook the separation of Church and State voted on the 18th of September 1794. Their real defence against counter revolution was the army; but, by a further contradiction, they reinforced the army attached to the Revolution while seeking an alliance with the peace-making bourgeoisie. Their party had therefore no more homogeneity than had their policy.

Moreover the Directory could not govern alone; it had to rely upon two other parties, according to circumstances: the republican-democrats and the disguised royalists.*

The former, purely anti-royalist, thought only of remedying the sufferings of the people. Roused by the collapse of the assignats, following upon the ruin of industry and the arrest of commerce, they were still further exasperated by the speculations of the financiers, by the jobbery which prevailed throughout the administration, and by the sale of national property which had profited hardly any but the bourgeoisie. After the 13th Vendémiaire the royalists too, deceived in their hopes, were expecting to return gradually to the councils, thanks to the high property qualification for the franchise. Under the name of “moderates” they demanded an end to this war which England continued and Austria threatened to recommence, and that the Directory from self-interested motives refused to conclude; they desired the abandonment of revolutionary proceedings, order in finance and religious peace.

The Directory, then, was in a minority in the country, and had to be ever on the alert against faction; all possible methods seemed legitimate, and during two years appeared successful. Order was maintained in France, even the

royalist west being pacified, thanks to Hoche, who finished his victorious campaign of 1796 against Stofflet, Charette and Cadoudal, by using mild and just measures to complete the subjection of the country. The greatest danger lay in the republican-democrats and their socialist ally, François Noel (“Gracchus”) Babeuf (*q.v.*). The former had united the

Jacobins and the more violent members of the Convention in their club, the Société du Panthéon; and their fusion, after the closing of the club, with the secret society of the Babouvists lent formidable strength to this party, with which Barras was secretly in league. The terrorist party, deprived of its head, had found a new leader, who, by developing the consequences of the Revolution's acts to their logical conclusion, gave first expression to the levelling principle of communism. He proclaimed the right of property as appertaining to the state, that is, to the whole community; the doctrine of equality as absolutely opposed to social

inequality of any kind—that of property as well as that of rank; and finally the inadequacy of the solution of the agrarian question, which had profited scarcely any one, save a new class of privileged individuals. But these socialist demands were premature; the attack of the camp of Grenelle upon constitutional order

The parties.

Struggle against the royalists.

Struggle against the republican-democrats and the socialists.

Babeuf.

ended merely in the arrest and guillotining of Babeuf (September 9, 1796–May 25, 1797).

The liquidation of the financial inheritance of the Convention was no less difficult. The successive issues of assignats, and the multiplication of counterfeiters made abroad, had so depreciated this paper money that an assignat of 100 francs was in February 1796 worth only 30 centimes; while the government, obliged to accept them at their nominal value, no longer collected any taxes and could not pay salaries. The destruction of the plate for printing assignats, on the 18th of February 1796, did not prevent the drop in the forty milliards still in circulation. Territorial mandates were now tried, which inspired no greater confidence, but served to liquidate two-thirds of the debt, the remaining third being consolidated by its dependence on the Grand Livre (September 30, 1797). This widespread bankruptcy, falling chiefly on the bourgeoisie, inaugurated a reaction which lasted until 1830 against the chief principle of the Constituent Assembly, which had favoured indirect taxation as producing a large sum without imposing any very obvious burden. The bureaucrats of the old system—having returned to their offices and being used to these indirect taxes—lent their assistance, and thus the Directory was enabled to maintain its struggle against the Coalition.

All system in finance having disappeared, war provided the Directory, now *in extremis*, with a treasury, and was its only source for supplying constitutional needs; while it opened a path to the military commanders who were to be the support and the glory of the state. England remaining invulnerable in her insular position despite Hoche's attempt to land in Ireland in 1796, the Directory resumed the traditional policy against Austria of conquering the natural frontiers, Carnot furnishing the plans; hence the war in southern Germany, in which Jourdan and Moreau were repulsed by an inferior force under the archduke Charles, and Bonaparte's triumphant Italian campaign. Chief of an army that he had made irresistible, not by honour but by glory, and master of wealth by rapine, Bonaparte imposed his will upon the Directory, which he provided with funds. After having separated the Piedmontese from the Austrians, whom he drove back into Tyrol, and repulsed offensive reprisals of Wurmser and Alvinzi on four occasions, he stopped short at the preliminary negotiations of Léoben just at the moment when the Directory, discouraged by the problem of Italian reconstitution, was preparing the army of the Rhine to re-enter the field under the command of Hoche. Bonaparte thus gained the good opinion of peace-loving Frenchmen; he partitioned Venetian territory with Austria, contrary to French interests but conformably with his own in Italy, and henceforward was the decisive factor in French and European policy, like Caesar or Pompey of old. England, in consternation, offered in her turn to negotiate at Lille.

These military successes did not prevent the Directory, like the Thermidorians, from losing ground in the country. Every strategic truce since 1795 had been marked by a political crisis; peace reawakened opposition. The constitutional party, royalist in reality, had made alarming progress, chiefly owing to the Babouvist conspiracy; they now tried to corrupt the republican generals, and Condé procured the treachery of Pichegru, Kellermann and General Ferrand at Besançon. Moreover, their Clichy club, directed by the abbé Brottier, manipulated Parisian opinion; while many of the refractory priests, having returned after the liberal Public Worship Act of September 1795, made active propaganda against the principles of the Revolution, and plotted the fall of the Directory as maintaining the State's independence of the Church. Thus the partial elections of the year V. (May 20, 1797) had brought back into the two councils a counter-revolutionary majority of royalists, constitutionalists of 1791, Catholics and moderates. The Director Letourneur had been replaced by Barthélemy, who had negotiated the treaty of Basel and was a constitutional monarchist. So that the executive not only found it impossible to govern, owing to the opposition of the councils and a vehement press-campaign, but was distracted

by ceaseless internal conflict. Carnot and Barthélemy wished to meet ecclesiastical opposition by legal measures only, and demanded peace; while Barras, La Révellière and Reubell saw no other remedy save military force. The attempt of the counter-revolutionaries to make an army for themselves out of the guard of the Legislative Assembly, and the success of the Catholics, who had managed at the end of August 1797 to repeal the laws against refractory priests, determined the Directory to appeal from the rebellious parliament to the ready swords of Augereau and Bernadotte. On the 18th Fructidor (September 4, 1797) Bonaparte's lieutenants, backed up by the whole army, stopped the elections in forty-nine departments, and deported to Guiana many deputies of both councils, journalists and non-juring priests, as well as the director Barthélemy, though Carnot escaped into Switzerland. The royalist party was once more overthrown, but with it the republican constitution itself. Thus every act of violence still further confirmed the new empire of the army and the defeat of principles, preparing the way for military despotism.

Political and financial *coups d'état* were not enough for the directors. In order to win back public opinion, tired of intestine quarrels and sickened by the scandalous immorality of the generals and of those in power, and to remove from Paris an army which after having given them a fresh lease of life was now a menace to them, war appeared their only hopeful course. They attempted to renew the designs of Louis XIV. and anticipate those of Napoleon. But Bonaparte saw what they were planning; and to the rupture of the negotiations at Lille and an order for the resumption of hostilities he responded by a fresh act of disobedience and the infliction on the Directory of the peace of Campo-Formio, on October 17, 1797. The directors were consoled for this enforced peace by acquiring the left bank of the Rhine and Belgium, and for the forfeiture of republican principles by attaining what had for so long been the ambition of the monarchy. But the army continued a menace. To avoid disbanding it, which might, as after the peace of Basel, have given the counter-revolution further auxiliaries, the Directory appointed Bonaparte chief of the Army of England, and employed Jourdan to revise the conscription laws so as to make military service a permanent duty of the citizen, since war was now to be the permanent object of policy. The Directory finally conceived the gigantic project of bolstering up the French Republic—the triumph of which was celebrated by the peace of Campo-Formio—by forming the neighbouring weak states into tributary vassal republics. This system had already been applied to the Batavian republic in 1795, to the Ligurian and Cisalpine republics in June 1797; it was extended to that of Mülhausen on the 28th of January 1798, to the Roman republic in February, to the Helvetian in April, while the Parthenopean republic (Naples) was to be established in 1799. This was an international *coup de force*, which presupposed that all these nations in whose eyes independence was flaunted would make no claim to enjoy it; that though they had been beaten and pillaged they would not learn to conquer in their turn; and that the king of Sardinia, dispossessed of Milan, the grand-duke of Tuscany who had given refuge to the pope when driven from Rome, and the king of Naples, who had opened his ports to Nelson's fleet, would not find allies to make a stand against this hypocritical system.

What happened was exactly the contrary. Meanwhile, the armies were kept in perpetual motion, procuring money for the impecunious Directory, making a diversion for internal discontent, and also permitting of a "reversed Fructidor," against the anarchists, who had got the upper hand in the partial elections of May 1798. The social danger was averted in its turn after the clerical danger had been dissipated. The next task was to relieve Paris of Bonaparte, who had already refused to repeat Hoche's unhappy expedition to Ireland and to attack England at home without either money or a navy. The pecuniary

Financial policy of the Directory.

External policy.

18th Fructidor.

Aggressive policy of the Directory.

Struggle against the royalists.

Coup d'état of the 22nd Floréal.

resources of Berne and the wealth of Rome fortunately tided over the financial difficulty and provided for the expedition to Egypt, which permitted Bonaparte to wait "for the fruit to ripen"—i.e. till the Directory should be ruined in the eyes of France and of all Europe. The disaster of Aboukir (August 1, 1798) speedily decided the coalition pending between England, Austria, the Empire, Portugal, Naples, Russia and Turkey. The Directory had to make a stand or perish, and with it the Republic. The directors had thought France might retain a monopoly in numbers and in initiative. They soon perceived that enthusiasm is not as great for a war of policy and conquest as for a war of national defence; and the army dwindled, since a country cannot bleed itself to death. The law of conscription was voted on the 5th of September 1798; and the tragedy of Rastadt, where the French commissioners were assassinated, was the opening of a war, desired but ill-prepared for, in which the Directory showed hesitation in strategy and incoherence in tactics, over a disproportionate area in Germany, Switzerland and Italy. Military reverses were inevitable, and responsibility for them could not be shirked. As though shattered by a reverberant echo from the cannon of the Trebbia, the Directory crumbled to pieces, succumbing on the 18th of June 1799 beneath the reprobation showered on Treillard, Merlin de Douai, and La Révellière-Lépeaux. A few more military disasters, royalist insurrections in the south, Chouan disturbances in Normandy, Orleanist intrigues and the end came. To soothe the populace and protect the frontier more was required than the resumption, as in all grave crises of the Revolution, of terrorist measures such as forced taxation or the law of hostages; the new Directory, Sieyès presiding, saw that for the indispensable revision of the constitution "a head and a sword" were needed. Moreau being unattainable, Joubert was to be the sword of Sieyès; but, when he was killed at the battle of Novi, the sword of the Revolution fell into the hands of Bonaparte.

Although Brune and Masséna retrieved the fight at Bergen and Zürich, and although the Allies lingered on the frontier as they had done after Valmy, still the fortunes of the Directory were not restored. Success was reserved for Bonaparte, suddenly landing at Fréjus with the prestige of his victories in the East, and now, after Hoche's death, appearing as sole master of the armies. He manœuvred among the parties as on the 13th Vendémiaire. On the 18th Brumaire of the year VIII. France and the army fell together at his feet. By a twofold *coup d'état*, parliamentary and military, he culled the fruits of the Directory's systematic aggression and unpopularity, and realized the universal desires of the rich bourgeoisie, tired of warfare; of the wretched populace; of landholders, afraid of a return to the old order of things; of royalists, who looked upon Bonaparte as a future Monk; of priests and their people, who hoped for an indulgent treatment of Catholicism; and finally of the immense majority of the French, who love to be ruled and for long had had no efficient government. There was hardly any one to defend a liberty which they had never known. France had, indeed, remained monarchist at heart for all her revolutionary appearance; and Bonaparte added but a name, though an illustrious one, to the series of national or local dictatorships, which, after the departure of the weak Louis XVI., had maintained a sort of informal republican royalty.

On the night of the 19th Brumaire a mere ghost of an Assembly abolished the constitution of the year III., ordained the provisional Consulate, and legalized the *coup d'état* in favour of Bonaparte. A striking and singular event; for the history of France and a great part of Europe was now for fifteen years to be summed up in the person of a single man (see NAPOLEON).

This night of Brumaire, however, seemed to be a victory for Sieyès rather than for Bonaparte. He it was who originated the project which the legislative commissions, charged with elaborating the new constitution, had to discuss. Bonaparte's

cleverness lay in opposing Daunou's plan to that of Sieyès, and in retaining only those portions of both which could serve his ambition. Parliamentary institutions annulled by the complication of three assemblies—the Council of State which drafted bills, the Tribune which discussed them without voting them, and the Legislative Assembly which voted them without discussing them; popular suffrage, mutilated by the lists of notables (on which the members of the Assemblies were to be chosen by the conservative senate); and the triple executive authority of the consuls, elected for ten years: all these semblances of constitutional authority were adopted by Bonaparte. But he abolished the post of Grand Elector, which Sieyès had reserved for himself, in order to reinforce the real authority of the First Consul himself—by leaving the two other consuls, Cambacérès and Lebrun, as well as the Assemblies, equally weak. Thus the aristocratic constitution of Sieyès was transformed into an unavowed dictatorship, a public ratification of which the First Consul obtained by a third *coup d'état* from the intimidated and yet reassured electors—reassured by his dazzling but unconvincing offers of peace to the victorious Coalition (which repulsed them), by the rapid disarmament of La Vendée, and by the proclamations in which he filled the ears of the infatuated people with the new talk of stability of government, order, justice and moderation. He gave every one a feeling that France was governed once more by a real statesman, that a pilot was at the helm.

Bonaparte had now to rid himself of Sieyès and those republicans who had no desire to hand over the republic to one man, particularly of Moreau and Masséna, his military rivals. The victory of Marengo (June 14, 1800) momentarily in the balance, but secured by Desaix and Kellermann, offered a further opportunity to his jealous ambition by increasing his popularity. The royalist plot of the Rue Saint-Nicaise (December 24, 1800) allowed him to make a clean sweep of the democratic republicans, who despite their innocence were deported to Guiana, and to annul Assemblies that were a mere show by making the senate omnipotent in constitutional matters; but it was necessary for him to transform this deceptive truce into the general pacification so ardently desired for the last eight years. The treaty of Lunéville, signed in February 1801 with Austria who had been disarmed by Moreau's victory at Hohenlinden, restored peace to the continent, gave nearly the whole of Italy to France, and permitted Bonaparte to eliminate from the Assemblies all the leaders of the opposition in the discussion of the Civil Code. The Concordat (July 1801), drawn up not in the Church's interest but in that of his own policy, by giving satisfaction to the religious feeling of the country, allowed him to put down the constitutional democratic Church, to rally round him the consciences of the peasants, and above all to deprive the royalists of their best weapon. The "Articles Organiques" hid from the eyes of his companions in arms and councillors a reaction which, in fact if not in law, restored to a submissive Church, despoiled of her revenues, her position as the religion of the state. The peace of Amiens with England (March 1802), of which France's allies, Spain and Holland, paid all the costs, finally gave the peacemaker a pretext for endowing himself with a Consulate, not for ten years but for life, as a recompense from the nation. The Rubicon was crossed on that day: Bonaparte's march to empire began with the constitution of the year X. (August 1802).

Before all things it was now necessary to reorganize France, ravaged as she was by the Revolution, and with her institutions in a state of utter corruption. The touch of the master was at once revealed to all the foreigners who rushed to gaze at the man about whom, after so many catastrophes and strange adventures, Paris, "la ville lumière," and all Europe were talking. First of all, Louis XV.'s system of roads was improved and that of Louis XVI.'s canals developed; then industry put its shoulder to the wheel; order and discipline were re-established everywhere, from the frontiers to the capital, and brigandage suppressed: and finally there was Paris, the city of cities! Everything was in process of transformation:

Bonaparte in Egypt.

The second coalition.

Coup d'état of the 18th Brumaire.

The Consulate, Sept. 11, 1799—May 18, 1804.

The constitution of the year VIII.

The Consulate.

Internal reorganization.

a second Rome was arising, with its forum, its triumphal arches, its shows and parades; and in this new Rome of a new Caesar fancy, elegance and luxury, a radiance of art and learning from the age of Pericles, and masterpieces rifled from the Netherlands, Italy and Egypt illustrated the consular peace. The Man of Destiny renewed the course of time. He borrowed from the *ancien régime* its plenipotentiaries; its over-centralized, strictly utilitarian administrative and bureaucratic methods; and afterwards, in order to bring them into line, the subservient pedantic scholasticism of its university. On the basis laid down by the Constituent Assembly and the Convention he constructed or consolidated the funds necessary for national institutions, local governments, a judiciary system, organs of finance, banking, codes, traditions of conscientious well-disciplined labour, and in short all the organization which for three-quarters of a century was to maintain and regulate the concentrated activity of the French nation (see the section *Law and Institutions*). Peace and order helped to raise the standard of comfort. Provisions, in this Paris which had so often suffered from hunger and thirst, and lacked fire and light, had become cheap and abundant; while trade prospered and wages ran high. The pomp and luxury of the *nouveaux riches* were displayed in the salons of the good Joséphine, the beautiful Madame Tallien, and the "divine" Juliette Récamier.

But the republicans, and above all the military, saw in all this little but the fetters of system; the wily despotism, the bullying police, the prostration before authority, the sympathy lavished on royalists, the recall of the *émigrés*, the contempt for the Assemblies, the purification of the Tribunate, the platitudes of the servile Senate, the silence of the press. In the formidable machinery of state, above all in the creation of the Legion of Honour, the Concordat, and the restoration of indirect taxes, they saw the rout of the Revolution. But the expulsion of persons like Benjamin Constant and Madame de Staël sufficed to quell this Fronde of the salons. The expedition to San Domingo reduced the republican army to a nullity; war demoralized or scattered the leaders, who were jealous of their "comrade" Bonaparte; and Moreau, the last of his rivals, cleverly compromised in a royalist plot, as Danton had formerly been by Robespierre, disappeared into exile. In contradistinction to this opposition of senators and republican generals, the immense mass of the people received the ineffaceable impression of Bonaparte's superiority. No suggestion of the possibility of his death was tolerated, of a crime which might cut short his career. The conspiracy of Cadoudal and Pichegru, after Bonaparte's refusal to give place to Louis XVIII., and the political execution of the duc d'Enghien, provoked an outburst of adulation, of which Bonaparte took advantage to put the crowning touch to his ambitious dream.

The decision of the senate on the 18th of May 1804, giving him the title of emperor, was the counterblast to the dread he had excited. Thenceforward "the brow of the emperor broke through the thin mask of the First Consul." Never did a harder master ordain more imperiously, nor understand better how to command obedience. "This was because," as Goethe said, "under his orders men were sure of accomplishing their ends. That is why they rallied round him, as one to inspire them with that kind of certainty." Indeed no man ever concentrated authority to such a point, nor showed mental abilities at all comparable to his: an extraordinary power of work, prodigious memory for details and fine judgment in their selection; together with a luminous decision and a simple and rapid conception, all placed at the disposal of a sovereign will. No head of the state gave expression more imperiously than this Italian to the popular passions of the French of that day: abhorrence for the emigrant nobility, fear of the *ancien régime*, dislike of foreigners, hatred of England, an appetite for conquest evoked by revolutionary propaganda, and the love of glory. In this Napoleon was a soldier of the people: because of this he judged and ruled his contemporaries. Having seen their actions in the stormy hours of the Revolution, he despised them and

looked upon them as incapable of disinterested conduct, conceited, and obsessed by the notion of equality. Hence his colossal egoism, his habitual disregard of others, his jealous passion for power, his impatience of all contradiction, his vain untruthful boasting, his unbridled self-sufficiency and lack of moderation—passions which were gradually to cloud his clear faculty of reasoning. His genius, assisted by the impoverishment of two generations, was like the oak which admits beneath its shade none but the smallest of saplings. With the exception of Talleyrand, after 1808 he would have about him only mediocre people, without initiative, prostrate at the feet of the giant: his tribe of paltry, rapacious and embarrassing Corsicans; his admirably subservient generals; his selfish ministers, docile agents, apprehensive of the future, who for fourteen long years felt a prognostication of defeat and discounted the inevitable catastrophe.

So France had no internal history outside the plans and transformations to which Napoleon subjected the institutions of the Consulate, and the after-effects of his wars. Well knowing that his fortunes rested on the delighted acquiescence of France, Napoleon expected to continue indefinitely fashioning public opinion according to his pleasure. To his contempt for men he added that of all ideas which might put a bridle on his ambition; and to guard against them, he inaugurated the Golden Age of the police that he might tame every moral force to his hand. Being essentially a man of order, he loathed, as he said, all demagogic action, Jacobinism and visions of liberty, which he desired only for himself. To make his will predominant, he stifled or did violence to that of others, through his bishops, his gendarmes, his university, his press, his catechism. Nourished like Frederick II. and Catherine the Great in 18th-century maxims, neither he nor they would allow any of that ideology to filter through into their rough but regular ordering of mankind. Thus the whole political system, being summed up in the emperor, was bound to share his fall.

Although an enemy of idealogues, in his foreign policy Napoleon was haunted by grandiose visions. A condottiere of the Renaissance living in the 19th century, he used France, and all those nations annexed or attracted by the Revolution, to resuscitate the Roman conception of the Empire for his own benefit. On the other hand, he was enslaved by the history and aggressive idealism of the Convention, and of the republican propaganda under the Directory; he was guided by them quite as much as he guided them. Hence the immoderate extension given to French activity by his classical Latin spirit; hence also his conquests, leading on from one to another, and instead of being mutually helpful interfering with each other; hence, finally, his not entirely coherent policy, interrupted by hesitation and counter-attractions. This explains the retention of Italy, imposed on the Directory from 1796 onward, followed by his criminal treatment of Venice, the foundation of the Cisalpine republic—a foretaste of future annexations—the restoration of that republic after his return from Egypt, and in view of his as yet inchoate designs, the postponed solution of the Italian problem which the treaty of Lunéville had raised.

Marengo inaugurated the political idea which was to continue its development until his Moscow campaign. Napoleon dreamed as yet only of keeping the duchy of Milan, setting aside Austria, and preparing some new enterprise in the East or in Egypt. The peace of Amiens, which cost him Egypt, could only seem to him a temporary truce; whilst he was gradually extending his authority in Italy, the cradle of his race, by the union of Piedmont, and by his tentative plans regarding Genoa, Parma, Tuscany and Naples. He wanted to make this his Cisalpine Gaul, laying siege to the Roman state on every hand, and preparing in the Concordat for the moral and material servitude of the pope. When he recognized his error in having raised the papacy from decadence by restoring its power over all the churches, he tried in vain to correct it by the *Articles Organiques*—wanting, like Charlemagne, to be the legal protector of the pope, and eventually master of the Church. To conceal his plan he aroused French colonial aspirations against England, and also

The republican opposition.

Napoleon emperor May 18, 1804-April 6, 1814.

Napoleon's political idea.

the memory of the spoliations of 1763, exasperating English jealousy of France, whose borders now extended to the Rhine, and laying hands on Hanover, Hamburg and Cuxhaven. By the "Recess" of 1803, which brought to his side Bavaria, Württemberg and Baden, he followed up the overwhelming tide of revolutionary ideas in Germany, to stem which Pitt, back in power, appealed once more to an Anglo-Austro-Russian coalition against this new Charlemagne, who was trying to renew the old Empire, who was mastering France, Italy and Germany; who finally on the 2nd of December 1804 placed the imperial crown upon his head, after receiving the iron crown of the Lombard kings, and made Pius VII. consecrate him in Notre-Dame.

After this, in four campaigns from 1805 to 1809, Napoleon transformed his Carolingian feudal and federal empire into one modelled on the Roman empire. The memories of imperial Rome were for a third time, after Caesar and Charlemagne, to modify the historical evolution of France. Though the vague plan for an invasion of England fell to the ground Ulm and Austerlitz obliterated Trafalgar, and the camp at Boulogne put the best military resources he had ever commanded at Napoleon's disposal.

In the first of these campaigns he swept away the remnants of the old Roman-Germanic empire, and out of its shattered fragments created in southern Germany the vassal states of Bavaria, Baden, Württemberg, Hesse-Darmstadt and Saxony, which he attached to France under the name of the Confederation of the Rhine;

Treaty of Presburg, 1805.

but the treaty of Presburg gave France nothing but the danger of a more centralized and less docile Germany. On the other hand, Napoleon's creation of the kingdom of Italy, his annexation of Venetia and her ancient Adriatic empire—wiping out the humiliation of 1797—and the occupation of Ancona, marked a new stage in his progress towards his Roman Empire. His good fortune soon led him from conquest to spoliation, and he complicated his master-idea of the grand empire by his Family Compact; the clan of the Bonapartes invaded European monarchies, wedding with princesses of blood-royal, and adding kingdom to kingdom. Joseph replaced the dispossessed Bourbons at Naples; Louis was installed on the throne of Holland; Murat became grand-duke of Berg, Jerome son-in-law to the king of Württemberg, and Eugène de Beauharnais to the king of Bavaria; while Stéphanie de Beauharnais married the son of the grand-duke of Baden.

Meeting with less and less resistance, Napoleon went still further and would tolerate no neutral power. On the 6th of August 1806

Jena.

he forced the Habsburgs, left with only the crown of Austria, to abdicate their Roman-Germanic title of emperor. Prussia alone remained outside the Confederation of the Rhine, of which Napoleon was Protector, and to further her decision he offered her English Hanover. In a second campaign he destroyed at Jena both the army and the state of Frederick William III., who could not make up his mind between the Napoleonic treaty of Schönbrunn and Russia's counter-proposal at Potsdam (October 14, 1806). The hutchery at Eylau and the

Eylau and Friedland.

vengeance taken at Friedland finally ruined Frederick the Great's work, and obliged Russia, the ally of England and Prussia, to allow the latter to be despoiled, and to join Napoleon against the maritime tyranny of the former. After Tilsit, however (July 1807), instead of trying to reconcile Europe to his grandeur, Napoleon had but one thought: to make use of his success to destroy England and complete his Italian dominion. It was from Berlin, on the 21st of November 1806, that he had dated the

Peace of Tilsit, July 8, 1807.

first decree of a continental blockade, a monstrous conception intended to paralyze his inveterate rival, but which on the contrary caused his own fall by its immoderate extension of the empire. To the coalition of the northern powers he added the league of the Baltic and Mediterranean ports, and to the bombardment of Copenhagen by an

Continental blockade.

English fleet he responded by a second decree of blockade, dated from Milan on the 17th of December 1807.

But the application of the Concordat and the taking of Naples

led to the first of those struggles with the pope, in which were formulated two antagonistic doctrines: Napoleon declaring himself Roman emperor, and Pius VII. renewing the theocratic affirmations of Gregory VII. The former's Roman ambition was made more and more plainly visible by the occupation of the kingdom of Naples and of the Marches, and the entry of Miollis into Rome; while Junot invaded Portugal, Radet laid hands on the pope himself, and Murat took possession of formerly Roman Spain, whither Joseph was afterwards to be transferred. But Napoleon little knew the flame he was kindling. No more far-seeing than the Directory or the men of the year III., he thought that, with energy and execution, he might succeed in the Peninsula as he had succeeded in Italy in 1796 and 1797, in Egypt, and in Hesse, and that he might cut into Spanish granite as into Italian mosaic or "that big cake, Germany." He stumbled unawares upon the revolt of a proud national spirit, evolved through ten historic centuries; and the trap of Bayonne, together with the enthroning of Joseph Bonaparte, made the contemptible prince of the Asturias the elect of popular sentiment, the representative of religion and country.

Napoleon thought he had Spain within his grasp, and now suddenly everything was slipping from him. The Peninsula became the grave of whole armies and a battlefield for England. Dupont capitulated at Bailen into the hands of Castaños, and Junot at Cintra to Wellesley; while Europe trembled at this first check to the hitherto invincible imperial armies. To reduce Spanish resistance Napoleon had in his turn to come to terms with the tsar Alexander at Erfurt; so that abandoning his designs in the East, he could make the Grand Army evacuate Prussia and return in force to Madrid.

Bailen.

Thus Spain swallowed up the soldiers who were wanted for Napoleon's other fields of battle, and they had to be replaced by forced levies. Europe had only to wait, and he would eventually be found disarmed in face of a last

Wagram.

coalition; but Spanish heroism infected Austria, and showed the force of national resistance. The provocations of Talleyrand and England strengthened the illusion: Why should not the Austrians emulate the Spaniards? The campaign of 1809, however, was but a pale copy of the Spanish insurrection. After a short and decisive action in Bavaria, Napoleon opened up the road to Vienna for a second time; and after the two days' battle at Essling, the stubborn fight at Wagram, the failure of a patriotic insurrection in northern Germany and of the English expedition against Antwerp, the treaty of Vienna (December 14, 1809), with the annexation of the Illyrian provinces, completed the colossal empire. Napoleon profited, in fact, by this

Peace of Vienna.

campaign which had been planned for his overthrow. The pope was deported to Savona beneath the eyes of indifferent Europe, and his domains were incorporated in the Empire; the senate's decision on the 17th of February 1810 created the title of king of Rome, and made Rome the capital of Italy. The pope banished, it was now desirable to send away those to whom Italy had been more or less promised. Eugène de Beauharnais, Napoleon's stepson, was transferred to Frankfurt, and Murat carefully watched until the time should come to take him to Russia and instal him as king of Poland. Between 1810 and 1812 Napoleon's divorce of Josephine, and his marriage with Marie Louise of Austria, followed by the birth of the king of Rome, shed a brilliant light upon his future policy. He renounced a federation in which his brothers were not sufficiently docile; he gradually withdrew power from them; he concentrated all his affection and ambition on the son who was the guarantee of the continuance of his dynasty. This was the apogee of his reign.

But undermining forces were already at work: the faults inherent in his unwieldy achievement. England, his chief enemy, was persistently active; and rebellion both of the governing and the governed broke out everywhere. Napoleon felt his impotence in coping with the Spanish insurrection, which he underrated, while yet unable to suppress it altogether. Men like Stein, Hardenberg and Scharnhorst were secretly preparing Prussia's retaliation. Napoleon's material omnipotence could not stand

Beginning of the end. Uprising of nationalism.

against the moral force of the pope, a prisoner at Fontainebleau; and this he did not realize. The alliance arranged at Tilsit was seriously shaken by the Austrian marriage, the threat of a Polish restoration, and the unfriendly policy of Napoleon at Constantinople. The very persons whom he had placed in power were counteracting his plans: after four years' experience Napoleon found himself obliged to treat his Corsican dynasties like those of the *ancien régime*, and all his relations were betraying him. Caroline conspired against her brother and against her husband; the hypochondriacal Louis, now Dutch in his sympathies, found the supervision of the blockade taken from him, and also the defence of the Scheldt, which he had refused to ensure; Jerome, idling in his harem, lost that of the North Sea shores; and Joseph, who was attempting the moral conquest of Spain, was continually insulted at Madrid. The very nature of things was against the new dynasties, as it had been against the old.

After national insurrections and family recriminations came treachery from Napoleon's ministers. Talleyrand betrayed his designs to Metternich, and had to be dismissed; **Treachery.** Fouché corresponded with Austria in 1809 and 1810, entered into an understanding with Louis, and also with England; while Bourrienne was convicted of peculation. By a natural consequence of the spirit of conquest he had aroused, all these parvenus, having tasted victory, dreamed of sovereign power: Bernadotte, who had helped him to the Consulate, played Napoleon false to win the crown of Sweden; Soult, like Murat, coveted the Spanish throne after that of Portugal, thus anticipating the treason of 1813 and the defection of 1814; many persons hoped for "an accident" which might resemble the tragic end of Alexander and of Caesar. The country itself, besides, though flattered by conquests, was tired of self-sacrifice. It had become satiated; "the cry of the mothers rose threateningly" against "the Ogre" and his intolerable imposition of wholesale conscription. The soldiers themselves, discontented after Austerlitz, cried out for peace after Eylau. Finally, amidst profound silence from the press and the Assemblies, a protest was raised against imperial despotism by the literary world, against the excommunicated sovereign by Catholicism, and against the author of the continental blockade by the discontented bourgeoisie, ruined by the crisis of 1811.

Napoleon himself was no longer the General Bonaparte of his campaign in Italy. He was already showing signs of physical decay; the Roman medallion profile had coarsened, **Degeneration of Napoleon.** the obese body was often lymphatic. Mental degeneration, too, betrayed itself in an unwonted irresolution. At Eylau, at Wagram, and later at Waterloo, his method of acting by enormous masses of infantry and cavalry, in a mad passion for conquest, and his misuse of his military resources, were all signs of his moral and technical decadence; and this at the precise moment when, instead of the armies and governments of the old system, which had hitherto reigned supreme, the nations themselves were rising against France, and the events of 1792 were being avenged upon her. The three campaigns of two years brought the final catastrophe.

Napoleon had hardly succeeded in putting down the revolt in Germany when the tsar himself headed a European insurrection against the ruinous tyranny of the continental blockade. To put a stop to this, to ensure his own access to the Mediterranean and exclude his chief rival, Napoleon made a desperate effort in 1812 against a country as invincible as Spain. Despite his victorious advance, the taking of Smolensk, the victory on the Moskwa, and the entry into Moscow, he was vanquished by Russian patriotism and religious fervour, by the country and the climate, and by Alexander's refusal to make terms. After this came the lamentable retreat, while all Europe was concentrating against him. Pushed back, as he had been in Spain, from bastion to bastion, after the action on the Beresina, Napoleon had to fall back upon the frontiers of 1809, and then—having refused the peace offered him by Austria at the congress of Prague, from a dread of losing Italy, where each of his victories had marked a stage in the accomplishment of his dream—on those of 1805, despite

Lützen and Bautzen, and on those of 1802 after his defeat at Leipzig, where Bernadotte turned upon him, Moreau figured among the Allies, and the Saxons and Bavarians forsook him. Following his retreat from Russia came his retreat from Germany. After the loss of Spain, reconquered by Wellington, the rising in Holland preliminary to the invasion and the manifesto of Frankfort which proclaimed it, he had to fall back upon the frontiers of 1795; and then later was driven yet farther back upon those of 1792, despite the wonderful campaign of 1814 against the invaders, in which the old Bonaparte of 1796 seemed to have returned. Paris capitulated on the 30th of March, and the "Delenda Carthago," pronounced against England, was spoken of by Napoleon. The great empire of East and West fell in ruins with the emperor's abdication at Fontainebleau.

The military struggle ended, the political struggle began. How was France to be governed? The Allies had decided on the eviction of Napoleon at the Congress of Châtillon; and the precarious nature of the Bonapartist monarchy in France itself was made manifest by the exploit of General Malet, which had almost succeeded during the Russian campaign, and by Lainé's demand for free exercise of political rights, when Napoleon made a last appeal to the Legislative Assembly for support. The defection of the military and civil aristocracy, which brought about Napoleon's abdication, the refusal of a regency, and the failure of Bernadotte, who wished to resuscitate the Consulate, enabled Talleyrand, vice-president of the senate and desirous of power, to persuade the Allies to accept the Bourbon solution of the difficulty. The declaration of St Ouen (May 2, 1814) indicated that the new monarchy was only accepted upon conditions. After Napoleon's abdication, and exile to the island of Elba, came the Revolution's abdication of her conquests: the first treaty of Paris (May 30th) confirmed France's renunciation of Belgium and the left bank of the Rhine, and her return within her pre-revolutionary frontiers, save for some slight rectifications.

After the scourge of war, the horrors of conscription, and the despotism which had discounted glory, every one seemed to rejoice in the return of the Bourbons, which atoned for humiliations by restoring liberty. But questions of form, which aroused questions of sentiment, speedily led to grave dissensions. The hurried armistice of the 23rd of April, by which the comte d'Artois delivered over disarmed France to her conquerors; Louis XVIII's excessive gratitude to the prince regent of England; the return of the *émigrés*; the declaration of St Ouen, dated from the nineteenth year of the new reign; the charter of June 4th, "*conçue et octroyée*," maintaining the effete doctrine of legitimacy in a country permeated with the idea of national sovereignty; the slights put upon the army; the obligatory processions ordered by Comte Beugnot, prefect of police; all this provoked a conflict not only between two theories of government but between two groups of men and of interests. An avowedly imperialist party was soon again formed, a centre of heated opposition to the royalist party; and neither Baron Louis' excellent finance, nor the peace, nor the charter of June 4th—which despite the irritation of the *émigrés* preserved the civil gains of the Revolution—prevented the man who was its incarnation from seizing an opportunity to bring about another military *coup d'état*. Having landed in the Bay of Jouan on the 1st of March, on the 20th Napoleon re-entered the Tuileries in triumph, while Louis XVIII. fled to Ghent. By the *Acte additionnel* of the 22nd of April he induced Carnot and Fouché—the last of the Jacobins—and the heads of the Liberal opposition, Benjamin Constant and La Fayette, to side with him against the hostile Powers of Europe, occupied in dividing the spoils of Vienna. He proclaimed his intention of founding a new democratic empire; and French policy was thus given another illusion, which was to be exploited with fatal success by Napoleon's namesake. But the cannon of Waterloo ended this adventure (June 18, 1815), and, thanks to Fouché's treachery, the triumphal progress of

Campaigns of 1813-14.

D downfall of the Empire.

Faults of the Bourbons.

The Hundred Days. March-June 1815.

Milan, Rome, Naples, Vienna, Berlin, and even of Moscow, was to end at St Helena.

The consequences of the Hundred Days were very serious; France was embroiled with all Europe, though Talleyrand's clever diplomacy had succeeded in causing division over Saxony and Poland by the secret Austro-Anglo-French alliance of the 3rd of January 1815, and the Coalition destroyed both France's political independence and national integrity by the treaty of peace of November 20th: she found herself far weaker than before the Revolution, and in the power of the European Alliance. The Hundred Days divided the nation itself into two irreconcilable parties: one ultra-royalist, eager for vengeance and retaliation, refusing to accept the Charter; the other imperialist, composed of Bonapartists and Republicans, incensed by their defeat—of whom Béranger was the Tyrtæus—both parties equally revolutionary and equally obstinate. Louis XVIII., urged by his more fervent supporters towards the *ancien régime*, gave his policy an exactly contrary direction; he had common-sense enough to maintain the Empire's legal and administrative tradition, accepting its institutions of the Legion of Honour, the Bank, the University, and the imperial nobility—modifying only formally certain rights and the conscription, since these had aroused the nation against Napoleon. He even went so far as to accept advice from the imperial ministers Talleyrand and Fouché. Finally, as the chief political organization had become thoroughly demoralized, he imported into France the entire constitutional system of England, with its three powers, king, upper hereditary chamber, and lower elected chamber; with its plutocratic electorate, and even with details like the speech from the throne, the debate on the address, &c. This meant importing also difficulties such as ministerial responsibility, as well as electoral and press legislation.

Louis XVIII., taught by time and misfortune, wished not to reign over two parties exasperated by contrary passions and desires; but his dynasty was from the outset implicated in the struggle, which was to be fatal to it, between old France and revolutionary France. Anti-monarchical, liberal and anti-clerical France at once recommenced its revolutionary work; the whole 19th century was to be filled with great spasmodic upheavals, and Louis XVIII. was soon overwhelmed by the White Terrorists of 1815.

Vindictive sentences against men like Ney and Labédoyère were followed by violent and unpunished action by the White Terror, which in the south renewed the horrors of St Bartholomew and the September massacres. The elections of August 14, 1815, made under the influence of these royalist and religious passions, sent the "*Chambre introuvable*" to Paris, an unforeseen revival of the *ancien régime*. Neither the substitution of the duc de Richelieu's ministry for that of Talleyrand and Fouché, nor a whole series of repressive laws in violation of the charter, were successful in satisfying its tyrannical loyalism, and Louis XVIII. needed something like a *coup d'état*, in September 1816, to rid himself of the "ultras."

He succeeded fairly well in quieting the opposition between the dynasty and the constitution, until a reaction took place between 1820 and 1822. State departments worked regularly and well, under the direction of Decazes, Lainé, De Serre and Pasquier, power alternating between two great well-disciplined parties almost in the English fashion, and many useful measures were passed: the reconstruction of finance stipulated for as a condition of evacuation of territory occupied by foreign troops; the electoral law of February 5, 1817, which, by means of direct election and a qualification of three hundred francs, renewed the preponderance of the *bourgeoisie*; the Gouvion St-Cyr law of 1818, which for half a century based the recruiting of the French army on the national principle of conscription; and in 1819, after Richelieu's dismissal, liberal regulations for the press under control of a commission. But the advance of the Liberal movement, and the election of the generals—Foy, Lamarque, Lafayette and of Manuel, excited the "ultras" and caused the

dismissal of Richelieu; while that of the constitutional bishop Grégoire led to the modification in a reactionary direction of the electoral law of 1817. The assassination of the duc de Berry, second son of the comte d'Artois (attributed to the influence of Liberal ideas), caused the downfall of Decazes, and caused the king—more weak and selfish than ever—to override the charter and embark upon a reactionary path. After 1820, Madame du Cayla, a trusted agent of the ultra-royalist party, gained great influence over the king; and M. de Villèle, its leader, supported by the king's brother, soon eliminated the Right Centre by the dismissal of the duc de Richelieu, who had been recalled to tide over the crisis—just as the fall of M. Decazes had signaled the defeat of the Left Centre (December 15, 1821)—and moderate policy thus received an irreparable blow.

Thenceforward the government of M. de Villèle—a clever statesman, but tied to his party—did nothing for six years but promulgate a long series of measures against Liberalism and the social work of the Revolution; to retain power it had to yield to the impatience of the comte d'Artois and the majority. The suspension of individual liberty, the re-establishment of the censorship; the electoral right of the "double vote," favouring taxation of the most oppressive kind; and the handing over of education to the clergy: these were the first achievements of this anti-revolutionary ministry. The Spanish expedition, in which M. de Villèle's hand was forced by Montmorency and Chateaubriand, was the united work of the association of Catholic zealots known as the Congregation and of the autocratic powers of the Grand Alliance; it was responded to—as at Naples and in Spain—by secret Carbonari societies, and by severely repressed military conspiracies. Politics now bore the double imprint of two rival powers: the Congregation and Carbonarism. By 1824, nevertheless, the dynasty seemed firm—the Spanish War had reconciled the army, by giving back military prestige; the Liberal opposition had been decimated; revolutionary conspiracies discouraged; and the increase of public credit and material prosperity pleased the whole nation, as was proved by the "*Chambre retrouvée*" of 1824. The law of septennial elections tranquillized public life by suspending any legal or regular manifestation by the nation for seven years.

It was the monarchy which next became revolutionary, on the accession of Charles X. (September 16, 1824). This inconsistent prince soon exhausted his popularity, and remained the fanatical head of those *émigrés* who had learnt nothing and forgotten nothing. While the opposition became conservative as regards the Charter and French liberties, the king and the clerical party surrounding him challenged the spirit of modern France by a law against sacrilege, by a bill for re-establishing the right of primogeniture, by an indemnity of a milliard francs, which looked like compensation given to the *émigrés*, and finally by the "*loi de liberté et d'amour*" against the press. The challenge was so definite that in 1826 the Chamber of Peers and the Academy had to give the Villèle ministry a lesson in Liberalism, for having lent itself to this *ancien régime* reaction by its weakness and its party-promises. The elections

"*de colère et de vengeance*" of January 1827 gave the Left a majority, and the resultant short-lived Martignac ministry tried to revive the Right Centre which had supported Richelieu and Decazes (January 1828). Martignac's accession to power, however, had only meant personal concessions from Charles X., not any concession of principle: he supported his ministry but was no real stand-by. The Liberals, on the other hand, made bargains for supporting the moderate royalists, and Charles X. profited by this to form a fighting ministry in conjunction with the prince de Polignac, one of the *émigrés*, an ignorant and visionary person, and the comte de Bourmont, the traitor of Waterloo. Despite all kinds of warnings, the former tried by a *coup d'état* to put into practice his theories of the supremacy of the royal prerogative; and the battle of Navarino, the French occupation of the Morea, and the Algerian expedition could not make the nation forget this conflict at home. The united opposition of monarchist

Louis XVIII.

The reaction of 1820.

Charles X.

The Constitutional party's rule.

Victory of the constitutional parties, 1827.

Liberals and imperialist republicans responded by legal resistance, then by a popular *coup d'état*, to the ordinances of July 1830, which dissolved the intractable Chamber, eliminated licensed dealers from the electoral list, and muzzled the press. After fighting for three days against the troops feebly led by the Marmont of 1814, the workmen, driven to the barricades by the deliberate closing of Liberal workshops, gained the victory, and sent the white flag of the Bourbons on the road to exile.

The rapid success of the "Three Glorious Days" ("les Trois Glorieuses"), as the July Days were called, put the leaders of the parliamentary opposition into an embarrassing position.

While they had contented themselves with words, the small Republican-Imperialist party, aided by the almost entire absence of the army and police, and by the convenience which the narrow, winding, paved streets of those times offered for fighting, had determined upon the revolution and brought it to pass. But the Republican party, which desired to re-establish the Republic of 1793, recruited chiefly from among the students and workmen, and led by Godefroy Cavaignac, the son of a Conventionalist, and by the chemist Raspail, had no hold on the departments nor on the dominating opinion in Paris. Consequently this premature attempt was promptly seized upon by the Liberal *bourgeoisie* and turned to the advantage of the Orleanist party, which had been secretly organized since 1829 under the leadership of Thiers, with the *National* as its organ. Before the struggle was yet over, Benjamin Constant, Casimir Périer, Lafitte, and Odilon Barrot had gone to fetch the duke of Orleans from Neuilly, and on receiving his promise to defend the Charter and the tricolour flag, installed him at the Palais Bourbon as lieutenant-general of the realm, while La Fayette and the Republicans established themselves at the Hôtel de Ville.

An armed conflict between the two governments was imminent, when Lafayette, by giving his support to Louis Philippe, decided matters in his favour.

Louis Philippe, in order to avoid a recurrence of the difficulties which had arisen with the Bourbons, the following preliminary conditions were imposed upon the king: the recognition of the supremacy of the people by the title of "king of the French by the grace of God and the will of the people," the responsibility of ministers, the suppression of hereditary succession to the Chamber of Peers, now reduced to the rank of a council of officials, the suppression of article 14 of the charter which had enabled Charles X. to supersede the laws by means of the ordinances, and the liberty of the press. The qualification for electors was lowered from 300 to 200 francs, and that for eligibility from 1000 to 500 francs, and the age to 25 and 30 instead of 30 and 40; finally, Catholicism lost its privileged position as the state religion. The *bourgeois* National Guard was made the guardian of the charter. The liberal ideas of the son of Philippe Égalité, the part he had played at Valmy and Jemappes, his gracious manner and his domestic virtues, all united in winning Louis Philippe the good opinion of the public.

He now believed, as did indeed the great majority of the electors, that the revolution of 1830 had changed nothing but the head of the state. But in reality the July monarchy was affected by a fundamental weakness. It sought to model itself upon the English monarchy, which rested upon one long tradition. But the tradition of France was both twofold and contradictory, *i.e.* the Catholic-legitimist and the revolutionary. Louis Philippe had them both against him. His monarchy had but one element in common with the English, namely, a parliament elected by a limited electorate. There was at this time a cause of violent outcry against the English monarchy, which, on the other hand, met with firm support among the aristocracy and the clergy. The July monarchy had no such support. The aristocracy of the *ancien régime* and of the Empire were alike without social influence; the clergy, which had paid for its too close alliance with Charles X. by a dangerous unpopularity, and foresaw the rise of democracy, was turning more and more towards the people, the future source of all power. Even the monarchical principle

itself had suffered from the shock, having proved by its easy defeat how far it could be brought to capitulate. Moreover, the victory of the people, who had shown themselves in the late struggle to be brave and disinterested, had won for the idea of national supremacy a power which was bound to increase. The difficulty of the situation lay in the doubt as to whether this expansion would take place gradually and by a progressive evolution, as in England, or not.

Now Louis Philippe, beneath the genial exterior of a bourgeois and peace-loving king, was entirely bent upon recovering an authority which was menaced from the very first on the one hand by the anger of the royalists at their failures, and on the other hand by the impatience of the republicans to follow up their victory. He wanted the insurrection to stop at a change in the reigning family, whereas it had in fact revived the revolutionary tradition, and restored to France the sympathies of the nationalities and democratic parties oppressed by Metternich's "system." The republican party, which had retired from power but not from activity, at once faced the new king with the serious problem of the acquisition of political power by the people, and continued to remind him of it. He put himself at the head of the party of progress ("parti du mouvement") as opposed to the ("parti de la cour") court party, and of the "resistance," which considered that it was now necessary "to check the revolution in order to make it fruitful, and in order to save it." But none of these parties were homogeneous; in the chamber they split up into a republican or radical Extreme Left, led by Garnier-Pagès and Arago; a dynastic Left, led by the honourable and sincere Odilon Barrot; a constitutional Right Centre and Left Centre, differing in certain slight respects, and presided over respectively by Thiers, a wonderful political orator, and Guizot, whose ideas were those of a strict doctrinaire; not to mention a small party which clung to the old legitimist creed, and was dominated by the famous *avocat* Berryer, whose eloquence was the chief ornament of the cause of Charles X.'s grandson, the comte de Chambord. The result was a ministerial majority which was always uncertain; and the only occasion on which Guizot succeeded in consolidating it during seven years resulted in the overthrow of the monarchy.

Louis Philippe first summoned to power the leaders of the party of "movement," Dupont de l'Eure, and afterwards Lafitte, in order to keep control of the progressive forces for his own ends. They wished to introduce democratic reforms and to uphold throughout Europe the revolution, which had spread from France into Belgium, Germany, Italy and Poland, while Paris was still in a state of unrest. But Louis Philippe took fright at the attack on the Chamber of Peers after the trial of the ministers of Charles X., at the sack of the church of Saint Germain l'Auxerrois and the archbishop's palace (February, 1831), and at the terrible strike of the silk weavers at Lyons. Casimir Périer, who was both a Liberal and a believer in a strong government, was then charged with the task of heading the resistance to advanced ideas, and applying the principle of non-intervention in foreign affairs (March 13, 1831). After his death by cholera in May 1832, the agitation which he had succeeded by his energy in checking at Lyons, at Grenoble and in the Vendée, where it had been stirred up by the romantic duchess of Berry, began to gain ground. The struggle against the republicans was still longer; for having lost all their chance of attaining power by means of the Chamber, they proceeded to reorganize themselves into armed secret societies. The press, which was gaining that influence over public opinion which had been lost by the parliamentary debates, openly attacked the government and the king, especially by means of caricature. Between 1832 and 1836 the Soulé ministry, of which Guizot, Thiers and the duc de Broglie were members, had to combat the terrible insurrections in Lyons and Paris (1834). The measures of repression were threefold: military repression, carried out by the National Guard and the regulars, both under the command of Bugeaud; judicial repression, effected by the great trial of April 1835;

The Revolution of 1830.

Republican and Orleanist parties.

Louis Philippe.

The bourgeois monarchy.

The parties.

The Republicans crushed.

and legislative repression, consisting in the laws of September, which, when to mere ridicule had succeeded acts of violence, such as that of Fieschi (July 28th, 1835), aimed at facilitating the condemnation of political offenders and at intimidating the press. The party of "movement" was vanquished.

But the July Government, born as it was of a popular movement, had to make concessions to popular demands. Casimir Périer had carried a law dealing with municipal organization, which made the municipal councils elective, as they had been before the year VIII.; and in 1833 Guizot had completed it by making the *conseils généraux* also elective. In the same year the law dealing with primary instruction had also shown the mark of new ideas. But now that the bourgeoisie was raised to power it did not prove itself any more liberal than the aristocracy of birth and fortune in dealing with educational, fiscal and industrial questions. In spite of the increase of riches, the bourgeois régime maintained a fiscal and social legislation which, while it assured to the middle class certainty and permanence of benefits, left the labouring masses poor, ignorant, and in a state of incessant agitation.

The Orleanists, who had been unanimous in supporting the king, disagreed, after their victory, as to what powers he was to be given. The Left Centre, led by Thiers, held that he should reign but not govern; the Right Centre, led by Guizot, would admit him to an active part in the government; and the third party (*tiers-parti*) wavered between these two. And so between 1836 and 1840, as the struggle against the king's claim to govern passed from the sphere of outside discussion into parliament, we see the rise of a bourgeois socialist party, side by side with the now dwindling republican party. It no longer confined its demands to universal suffrage, on the principle of the legitimate representation of all interests, or in the name of justice. Led by Saint-Simon, Fourier, P. Leroux and Lamennais, it aimed at realizing a better social organization for and by means of the state. But the question was by what means this was to be accomplished. The secret societies, under the influence of Blanqui and Barbès, two revolutionaries who had revived the traditions of Babeuf, were not willing to wait for the complete education of the masses, necessarily a long process. On the 12th of May 1839 the *Société des Saisons* made an attempt to overthrow the bourgeoisie by force, but was defeated. Democrats like Louis Blanc, Ledru-Rollin and Lamennais continued to repeat in support of the wisdom of universal suffrage the old profession of faith: *vox populi, vox Dei*. And finally this republican doctrine, already confused, was still further complicated by a kind of mysticism which aimed at reconciling the most extreme differences of belief, the Catholicism of Buchez, the Bonapartism of Cormenin, and the humanitarianism of the cosmopolitans. It was in vain that Auguste Comte, Michelet and Quinet denounced this vague humanitarian mysticism and the pseudo-liberalism of the Church. The movement had now begun.

At first these moderate republicans, radical or communist, formed only imperceptible groups. Among the peasant classes, and even in the industrial centres, warlike passions were still rife. Louis Philippe tried to find an outlet for them in the Algerian war, and later by the revival of the Napoleonic legend, which was held to be no longer dangerous, since the death of the duke of Reichstadt in 1832. It was imprudently recalled by Thiers' *History of the Consulate and Empire*, by artists and poets, in spite of the prophecies of Lamartine, and by the solemn translation of Napoleon I.'s ashes in 1840 to the Invalides at Paris.

All theories require to be based on practice, especially those which involve force. Now Louis Philippe, though as active as his predecessors had been slothful, was the least warlike of men. His only wish was to govern personally, as George III. and George IV. of England had done, especially in foreign affairs, while at home was being waged the great duel between Thiers and Guizot, with Molé as intermediary. Thiers, head of the cabinet of the 22nd of February 1836, an astute man but not pliant

enough to please the king, fell after a few months, in consequence of his attempt to stop the Carlist civil war in Spain, and to support the constitutional government of Queen Isabella. Louis Philippe hoped that, by calling upon Molé to form a ministry, he would be better able to make his personal authority felt. From 1837 to 1839 Molé aroused opposition on all hands; this was emphasized by the refusal of the Chambers to vote one of those endowments which the king was continually asking them to grant for his children, by two dissolutions of the Chambers, and finally by the Strasburg affair and the stormy trial of Louis Napoleon, son of the former king of Holland (1836-1837). At the elections of 1839 Molé was defeated by Thiers, Guizot and Barrot, who had combined to oppose the tyranny of the "Château," and after a long ministerial crisis was replaced by Thiers (March 1, 1840). But the latter was too much in favour of war to please the king, who was strongly disposed towards peace and an alliance with Great Britain, and consequently fell at the time of the Egyptian question, when, in answer to the treaty of London concluded behind his back by Nicholas I. and Palmerston on the 15th of July 1840, he fortified Paris and proclaimed his intention to give armed support to Mehemet Ali, the ally of France (see MEHEMET ALI). But the violence of popular Chauvinism and the renewed attempt of Louis Napoleon at Boulogne proved to the holders of the doctrine of peace at any price that in the long-run their policy tends to turn a peaceful attitude into a warlike one, and to strengthen the absolutist idea.

In spite of all, from 1840 to 1848 Louis Philippe still further extended his activity in foreign affairs, thus bringing himself into still greater prominence, though he was already frequently held responsible for failures in foreign politics and unpopular measures in home affairs. The catchword of Guizot, who was now his minister, was: Peace and no reforms. With the exception of the law of 1842 concerning the railways, not a single measure of importance was proposed by the ministry. France lived under a régime of general corruption: parliamentary corruption, due to the illegal conduct of the deputies, consisting of slavish or venal officials; electoral corruption, effected by the purchase of the 200,000 electors constituting the "*pays légal*," who were bribed by the advantages of power; and moral corruption, due to the reign of the plutocracy, the bourgeoisie, a hard-working, educated and honourable class, it is true, but insolent, like all newly enriched parvenus in the presence of other aristocracies, and with unyielding selfishness maintaining an attitude of suspicion towards the people, whose aspirations they did not share and with whom they did not feel themselves to have anything in common. This led to a slackening in political life, a sort of exhaustion of interest throughout the country, an excessive devotion to material prosperity. Under a superficial appearance of calm a tempest was brewing, of which the industrial writings of Balzac, Eugène Sue, Lamartine, H. Heine, Vigny, Montalembert and Tocqueville were the premonitions. But it was in vain that they denounced this supremacy of the bourgeoisie, relying on its two main supports, the suffrage based on a property qualification and the National Guard, for its rallying-cry was the "*Enrichissez-vous*" of Guizot, and its excessive materialism gained a sinister distinction from scandals connected with the ministers Teste and Cubières, and such mysterious crimes as that of Choiseul-Praslin.¹ In vain also did they point out that mere riches are not so much a protection to the ministry who are in power as a temptation to the majority excluded from power by this barrier of wealth.

¹ Charles Laure Hugues Théobald, duc de Choiseul-Praslin (1805-1847), was deputy in 1839, created a peer of France in 1840. He had married a daughter of General Sebastiani, with whom he lived on good terms till 1840, when he entered into open relations with his children's governess. The duchess threatened a separation; and the duke consented to send his mistress out of the house, but did not cease to correspond with and visit her. On the 18th of August 1847 the duchess was found stabbed to death, with more than thirty wounds, in her room. The duke was arrested on the 20th and imprisoned in the Luxembourg, where he died of poison, self-administered on the 24th. It was, however, popularly believed that the government had smuggled him out of the country and that he was living under a feigned name in England.

The bourgeois policy.

The socialist party.

Guizot's ministry.

The Bonapartist revival.

Parliamentary opposition to the royal power.

It was in vain that beneath the inflated *haute bourgeoisie* which speculated in railways and solidly supported the Church, behind the shopkeeper clique who still remained Voltairian, who enviously applauded the pamphlets of Cormenin on the luxury of the court, and who were bitterly satirized by the pencil of Daumier and Gavarni, did the thinkers give voice to the mutterings of an immense industrial proletariat, which were re-echoing throughout the whole of western Europe.

In face of this tragic contrast Guizot remained unmoved, blinded by the superficial brilliance of apparent success and prosperity. He adorned by flights of eloquence his invariable theme: no new laws, no reforms, no foreign complications, the policy of material interests. He preserved his yielding attitude towards Great Britain in the affair of the right of search in 1841, and in the affair of the missionary Pritchard at Tahiti (1843-1845). And when the marriage of the duc de Montpensier with a Spanish infanta in 1846 had broken this *entente cordiale* to which he clung, it was only to yield in turn to Metternich, when he took possession of Cracow, the last remnant of Poland, to protect the *Sonderbund* in Switzerland, to discourage the Liberal ardour of Pius IX., and to hand over the education of France to the Ultramontane clergy. Still further strengthened by the elections of 1846, he refused the demands of the Opposition formed by a coalition of the Left Centre and the Radical party for parliamentary and electoral reform, which would have excluded the officials from the Chambers, reduced the electoral qualification to 100 francs, and added to the number of the electors the *capacitaires* whose competence was guaranteed by their education. For Guizot the whole country was represented by the "*pays légal*," consisting of the king, the ministers, the deputies and the electors. When the Opposition appealed to the country, he flung down a disdainful challenge to what "*les brouillons et les badauds appellent le peuple*." The challenge was taken up by all the parties of the Opposition in the campaign of the banquets got up somewhat artificially in 1847 in favour of the extension of the franchise. The monarchy had arrived at such a state of weakness and corruption that a determined minority was sufficient to overthrow it. The prohibition of a last banquet in Paris precipitated the catastrophe. The monarchy which for fifteen years had overcome its adversaries collapsed on the 24th of February 1848 to the astonishment of all.

The industrial population of the faubourgs on its way towards the centre of the town was welcomed by the National Guard, among cries of "*Vive la réforme*." Barricades were raised after the unfortunate incident of the firing on the crowd in the Boulevard des Capucines. On the 23rd Guizot's cabinet resigned, abandoned by the *petite bourgeoisie*, on whose support they thought they could depend. The heads of the Left Centre and the dynastic Left, Molé and Thiers, declined the offered leadership. Odilon Barrot accepted it, and Bugeaud, commander-in-chief of the first military division, who had begun to attack the barricades, was recalled. But it was too late. In face of the insurrection which had now taken possession of the whole capital, Louis Philippe decided to abdicate in favour of his grandson, the comte de Paris. But it was too late also to be content with the regency of the duchess of Orleans. It was now the turn of the Republic, and it was proclaimed by Lamartine in the name of the provisional government elected by the Chamber under the pressure of the mob.

This provisional government with Dupont de l'Eure as its president, consisted of Lamartine for foreign affairs, Crémieux for justice, Ledru-Rollin for the interior, Carnot for public instruction, Gondchaux for finance, Arago for the navy, and Bedeau for war. Garnier-Pagès was mayor of Paris. But, as in 1830, the republican-socialist party had set up a rival government at the Hôtel de Ville, including L. Blanc, A. Marrast, Flocon, and the workman Albert, which bid fair to involve discord and civil war. But this time the Palais Bourbon was not victorious over the Hôtel de Ville. It had to consent to a fusion of the two bodies,

in which, however, the predominating elements were the moderate republicans. It was doubtful what would eventually be the policy of the new government. One party, seeing that in spite of the changes in the last sixty years of all political institutions, the position of the people had not been improved, demanded a reform of society itself, the abolition of the privileged position of property, the only obstacle to equality, and as an emblem hoisted the red flag. The other party wished to maintain society on the basis of its ancient institutions, and rallied round the tricolour.

The first collision took place as to the form which the revolution of 1848 was to take. Were they to remain faithful to their original principles, as Lamartine wished, and accept the decision of the country as supreme, or were they, as the revolutionaries under Ledru-Rollin claimed, to declare the republic of Paris superior to the universal suffrage of an insufficiently educated people? On the 5th of March the government, under the pressure of the Parisian clubs, decided in favour of an immediate reference to the people, and direct universal suffrage, and adjourned it till the 26th of April. In this fateful and unexpected decision, which instead of adding to the electorate the educated classes, refused by Guizot, admitted to it the unqualified masses, originated the Constituent Assembly of the 4th of May 1848. The provisional government having resigned, the republican and anti-socialist majority on the 9th of May entrusted the supreme power to an executive commission consisting of five members: Arago, Marie, Garnier-Pagès, Lamartine and Ledru-Rollin. But the spell was already broken. This revolution which had been peacefully effected with the most generous aspirations, in the hope of abolishing poverty by organizing industry on other bases than those of competition and capitalism, and which had at once aroused the fraternal sympathy of the nations, was doomed to be abortive.

The result of the general election, the return of a constituent assembly predominantly moderate if not monarchical, dashed the hopes of those who had looked for the establishment, by a peaceful revolution, of their ideal socialist state; but they were not prepared to yield without a struggle, and in Paris itself they commanded a formidable force. In spite of the preponderance of the "*tricolour*" party in the provisional government, so long as the voice of France had not spoken, the socialists, supported by the Parisian proletariat, had exercised an influence on policy out of all proportion to their relative numbers or personal weight. By the decree of the 24th of February the provisional government had solemnly accepted the principle of the "*right to work*," and decided to establish "*national workshops*" for the unemployed; at the same time a sort of industrial parliament was established at the Luxembourg, under the presidency of Louis Blanc, with the object of preparing a scheme for the organization of labour; and, lastly, by the decree of the 8th of March the property qualification for enrolment in the National Guard had been abolished and the workmen were supplied with arms. The socialists thus formed, in some sort, a state within the state, with a government, an organization and an armed force.

In the circumstances a conflict was inevitable; and on the 15th of May an armed mob, headed by Raspail, Blanqui and Barbès, and assisted by the proletariat Guard, attempted to overwhelm the Assembly. They were defeated by the bourgeois battalions of the National Guard; but the situation none the less remained highly critical. The national workshops were producing the results that might have been foreseen. It was impossible to provide remunerative work even for the genuine unemployed, and of the thousands who applied the greater number were employed in perfectly useless digging and refilling; soon even this expedient failed, and those for whom work could not be invented were given a half wage of 1 franc a day. Even this pitiful dole, with no obligation to work, proved attractive, and all over France workmen threw up their jobs and streamed to Paris, where they swelled the ranks of the army under the red flag. It was soon clear that the continuance of this experiment would mean financial ruin; it had been proved by the *émeute* of the 15th of May that it constituted a perpetual menace

**Guizot's
Foreign
Policy.**

**Universal
suffrage.**

**Campaign
of the
banquets.**

**The
Executive
Commis-
sion.**

**The Re-
volution
of Feb. 24,
1848.**

**The Pro-
visional
Govern-
ment.**

to the state; and the government decided to end it. The method chosen was scarcely a happy one. On the 21st of June M. de Falloux decided in the name of the parliamentary commission on labour that the workmen should be discharged within three days and such as were able-bodied should be forced to enlist.

The June Days.

A furious insurrection at once broke out. Throughout the whole of the 24th, 25th and 26th of June, the eastern industrial quarter of Paris, led by Pujol, carried on a furious struggle against the western quarter, led by Cavaignac, who had been appointed dictator. Vanquished and decimated, first by fighting and afterwards by deportation, the socialist party was crushed. But they dragged down the Republic in their ruin. This had already become unpopular with the peasants, exasperated by the new land tax of 45 centimes imposed in order to fill the empty treasury, and with the *bourgeois*, in terror of the power of the revolutionary clubs and hard hit by the stagnation of business. By the "massacres" of the June Days the working classes were also alienated from it; and abiding fear of the "Reds" did the rest. "France," wrote the duke of Wellington at this time, "needs a Napoleon! I cannot yet see him . . . Where is he?"¹

France indeed needed, or thought she needed, a Napoleon; and the demand was soon to be supplied. The granting of universal suffrage to a society with Imperialist sympathies, and unfitted to reconcile the principles of order with the consequences of liberty, was indeed bound, now that the political balance in France was so radically changed, to prove a formidable instrument of reaction; and this was proved by the election of the president of the Republic. On the 4th of November 1848 was promulgated the new constitution, obviously the work of inexperienced hands, proclaiming a democratic republic, direct universal suffrage and the separation of powers; there was to be a single permanent assembly of 750 members elected for a term of three years by the *scrutin de liste*, which was to vote on the laws prepared by a council of state elected by the Assembly for six years; the executive power was delegated to a president elected for four years by direct universal suffrage, *i.e.* on a broader basis than that of the chamber, and not eligible for re-election; he was to choose his ministers, who, like him, would be responsible. Finally, all revision was made impossible since it involved obtaining three times in succession a majority of three-quarters of the deputies in a special assembly. It was in vain that M. Grévy, in the name of those who perceived the obvious and inevitable risk of creating, under the name of a president, a monarch and more than a king, proposed that the head of the state should be no more than a removable president of the ministerial council. Lamartine, thinking that he was sure to be the choice of the electors under universal suffrage, won over the support of the Chamber, which did not even take the precaution of rendering ineligible the members of families which had reigned over France. It made the presidency an office dependent upon popular acclamation.

The election was keenly contested; the socialists adopted as their candidate Ledru-Rollin, the republicans Cavaignac; and the recently reorganized Imperialist party Prince Bonaparte. Louis Napoleon, unknown in 1835, and forgotten or despised since 1840, had in the last eight years advanced sufficiently in the public estimation to be elected to the Constituent Assembly in 1848 by five departments. He owed this rapid increase of popularity partly to blunders of the government of July, which had unwisely aroused the memory of the country, filled as it was with recollections of the Empire, and partly to Louis Napoleon's campaign carried on from his prison at Ham by means of pamphlets of socialistic tendencies. Moreover, the monarchists, led by Thiers and the committee of the Rue de Poitiers, were no longer content even with the safe dictatorship of the upright Cavaignac, and joined forces with the Bonapartists. On the 10th of December the peasants gave over 5,000,000 votes to a name: Napoleon, which stood for order at all costs, against 1,400,000 for Cavaignac.

¹T. T. de Martens, *Recueil des traités*, &c., xii. 248.

For three years there went on an indecisive struggle between the heterogeneous Assembly and the prince who was silently awaiting his opportunity. He chose as his ministers men but little inclined towards republicanism, for preference Orleanists, the chief of whom was Odilon Barrot. In order to strengthen his position, he endeavoured to conciliate the reactionary parties, without committing himself to any of them. The chief instance of this was the expedition to Rome, voted by the Catholics with the object of restoring the papacy, which had been driven out by Garibaldi and Mazzini. The prince-president was also in favour of it, as beginning the work of European renovation and reconstruction which he already looked upon as his mission. General Oudinot's entry into Rome provoked in Paris a foolish insurrection in favour of the Roman republic, that of the Château d'Eau, which was crushed on the 13th of June 1849. On the other hand, when Pius IX., though only just restored, began to yield to the general movement of reaction, the president demanded that he should set up a Liberal government. The pope's dilatory reply having been accepted by his ministry, the president replaced it on the 1st of November by the Fould-Rouher cabinet.

Expedition to Rome.

This looked like a declaration of war against the Catholic and monarchist majority in the Legislative Assembly which had been elected on the 28th of May in a moment of panic. But the prince-president again pretended to be playing the game of the Orleanists, as he had done in the case of the Constituent-Assembly. The complementary elections of March and April 1850 having resulted in an unexpected victory for the advanced republicans, which struck terror into the reactionary leaders, Thiers, Berryer and Montalembert, the president gave his countenance to a clerical campaign against the republicans at home. The Church, which had failed in its attempts to gain control of the university under Louis XVIII. and Charles X., aimed at setting up a rival establishment of its own. The *Loi Falloux* of the 15th of March 1850, under the pretext of establishing the liberty of instruction promised by the charter, again placed the teaching of the university under the direction of the Catholic Church, as a measure of social safety, and, by the facilities which it granted to the Church for propagating teaching in harmony with its own dogmas, succeeded in obstructing for half a century the work of intellectual enfranchisement effected by the men of the 18th century and of the Revolution. The electoral law of the 31st of May was another class law directed against subversive ideas. It required as a proof of three years' domicile the entries in the record of direct taxes, thus cutting down universal suffrage by taking away the vote from the industrial population, which was not as a rule stationary. The law of the 16th of July aggravated the severity of the press restrictions by re-establishing the "caution money" (*cautionnement*) deposited by proprietors and editors of papers with the government as a guarantee of good behaviour. Finally, a skilful interpretation of the law on clubs and political societies suppressed about this time all the Republican societies. It was now their turn to be crushed like the socialists.

The Legislative Assembly.

"Loi Falloux."

Electoral law of May 31.

But the president had only joined in Montalembert's cry of "Down with the Republicans!" in the hope of effecting a revision of the constitution without having recourse to a *coup d'état*. His concessions only increased the boldness of the monarchists; while they had only accepted Louis Napoleon as president in opposition to the Republic and as a step in the direction of the monarchy. A conflict was now inevitable between his personal policy and the majority of the Chamber, who were, moreover, divided into legitimists and Orleanists, in spite of the death of Louis Philippe in August 1850. Louis Napoleon skilfully exploited their projects for a restoration of the monarchy, which he knew to be unpopular in the country, and which gave him the opportunity of furthering his own personal ambitions. From the 8th of August to the 12th of November 1850 he went about France stating the case for a revision of the constitution in speeches which he varied according to each place; he held

Struggle between the President and the Assembly.

reviews, at which cries of "*Vive Napoléon*" showed that the army was with him; he superseded General Changarnier, on whose arms the parliament relied for the projected monarchical *coup d'état*; he replaced his Orleanist ministry by obscure men devoted to his own cause, such as Morny, Fleury and Persigny, and gathered round him officers of the African army, broken men like General Saint-Arnaud; in fact he practically declared open war.

His reply to the votes of censure passed by the Assembly, and their refusal to increase his civil list, was to hint at a vast communistic plot in order to scare the bourgeoisie, and to denounce the electoral law of the 31st of May in order to gain the support of the mass of the people. The Assembly retaliated by throwing out the proposal for a partial reform of that article of the constitution which prohibited the re-election of the president and the re-establishment of universal suffrage (July). All hope of a peaceful issue was at an end. When the questors called upon the Chamber to have posted up in all barracks the decree of the 6th of May 1848 concerning the right of the Assembly to demand the support of the troops if attacked, the Mountain, dreading a restoration of the monarchy, voted with the Bonapartists against the measure, thus disarming the legislative power. Louis Napoleon saw his opportunity. On the night between the 1st and 2nd of December 1851, the anniversary of Austerlitz, he dissolved the Chamber, re-established universal suffrage, had all the party leaders arrested, and summoned a new assembly to prolong his term of office for ten years. The deputies who had met under Berryer at the *Mairie* of the tenth arrondissement to defend the constitution and proclaim the deposition of Louis Napoleon were scattered by the troops at Mazas and Mont Valérien. The resistance organized by the republicans within Paris under Victor Hugo was soon subdued by the intoxicated soldiers. The more serious resistance in the departments was crushed by declaring a state of siege and by the "mixed commissions." The plebiscite of the 20th of December ratified by a huge majority the *coup d'état* in favour of the prince-president, who alone reaped the benefit of the excesses of the Republicans and the reactionary passions of the monarchists.

The second attempt to revive the principle of 1789 only served as a preface to the restoration of the Empire. The new anti-parliamentary constitution of the 14th of January 1852 was to a large extent merely a repetition of that of the year VIII. All executive power was entrusted to the head of the state, who was solely responsible to the people, now powerless to exercise any of their rights. He was to nominate the members of the council of state, whose duty it was to prepare the laws, and of the senate, a body permanently established as a constituent part of the empire. One innovation was made, namely, that the Legislative Body was elected by universal suffrage, but it had no right of initiative, all laws being proposed by the executive power. This new and violent political change was rapidly followed by the same consequence as had attended that of Brumaire. On the 2nd of December 1852, France, still under the effect of the Napoleonic *virus*, and the fear of anarchy, conferred almost unanimously by a plebiscite the supreme power, with the title of emperor, upon Napoleon III.

But though the machinery of government was almost the same under the Second Empire as it had been under the First, the principles upon which its founder based it were different. The function of the Empire, as he loved to repeat, was to guide the people internally towards justice and externally towards perpetual peace. Holding his power by universal suffrage, and having frequently, from his prison or in exile, reproached former oligarchical governments with neglecting social questions, he set out to solve them by organizing a system of government based on the principles of the "Napoleonic Idea," *i.e.* of the emperor, the elect of the people as the representative of the democracy, and as such supreme; and of himself, the representative of the great Napoleon, "who had sprung armed from the Revolution like Minerva from the head of Jove," as the guardian of the

social gains of the revolutionary epoch. But he soon proved that social justice did not mean liberty; for he acted in such a way that those of the principles of 1848 which he had preserved became a mere sham. He proceeded to paralyze all those active national forces which tend to create the public spirit of a people, such as parliament, universal suffrage, the press, education and associations. The Legislative Body was not allowed either to elect its own president or to regulate its own procedure, or to propose a law or an amendment, or to vote on the budget in detail, or to make its deliberations public. It was a dumb parliament. Similarly, universal suffrage was supervised and controlled by means of official candidature, by forbidding free speech and action in electoral matters to the Opposition, and by a skilful adjustment of the electoral districts in such a way as to overwhelm the Liberal vote in the mass of the rural population. The press was subjected to a system of *cautionnements*, *i.e.* "caution money," deposited as a guarantee of good behaviour, and *avertissements*, *i.e.* requests by the authorities to cease publication of certain articles, under pain of suspension or suppression; while books were subject to a censorship. France was like a sick-room, where nobody might speak aloud. In order to counteract the opposition of individuals, a *surveillance* of suspects was instituted. Orsini's attack on the emperor in 1858, though purely Italian in its motive, served as a pretext for increasing the severity of this régime by the law of general security (*sûreté générale*) which authorized the internment, exile or deportation of any suspect without trial. In the same way public instruction was strictly supervised, the teaching of philosophy was suppressed in the *Lycées*, and the disciplinary powers of the administration were increased. In fact for seven years France had no political life. The Empire was carried on by a series of plebiscites. Up to 1857 the Opposition did not exist; from then till 1860 it was reduced to five members: Darimon, Émile Ollivier, Hénon, J. Favre and E. Picard. The royalists waited inactive after the new and unsuccessful attempt made at Frohsdorf in 1853, by a combination of the legitimists and Orleanists, to re-create a living monarchy out of the ruin of two royal families. Thus the events of that ominous night in December were closing the future to the new generations as well as to those who had grown up during forty years of liberty.

But it was not enough to abolish liberty by conjuring up the spectre of demagogy. It had to be forgotten, the great silence had to be covered by the noise of festivities and material enjoyment, the imagination of the French people had to be distracted from public affairs by the taste for work, the love of gain, the passion for good living. The success of the imperial despotism, as of any other, was bound up with that material prosperity which would make all interests dread the thought of revolution. Napoleon III., therefore, looked for support to the clergy, the great financiers, industrial magnates and landed proprietors. He revived on his own account the "Let us grow rich" of 1840. Under the influence of the Saint-Simonians and men of business great credit establishments were instituted and vast public works entered upon: the *Crédit foncier de France*, the *Crédit mobilier*, the conversion of the railways into six great companies between 1852 and 1857. The rage for speculation was increased by the inflow of Californian and Australian gold, and consumption was facilitated by a general fall in prices between 1856 and 1860, due to an economic revolution which was soon to overthrow the tariff wall, as it had done already in England. Thus French activity flourished exceedingly between 1852 and 1857, and was merely temporarily checked by the crisis of 1857. The universal Exhibition of 1855 was its culminating point. Art felt the effects of this increase of comfort and luxury. The great enthusiasms of the romantic period were over; philosophy became sceptical and literature merely amusing. The festivities of the court at Compiègne set the fashion for the bourgeoisie, satisfied with this energetic government which kept such good guard over their bank balances.

If the Empire was strong, the emperor was weak. At once headstrong and a dreamer, he was full of rash plans, but irresolute

*Coup
d'État of
Dec. 2,
1851.*

*The
Second
Empire.*

*Material
prosperity
a con-
dition of
despotism.*

in carrying them out. An absolute despot, he remained what his life had made him, a conspirator through the very mysticism of his mental habit, and a revolutionary by reason of his demagogic imperialism and his democratic chauvinism. In his opinion the artificial work of the congress of Vienna, involving the downfall of his own family and of France, ought to be destroyed, and Europe organized as a collection of great industrial states, united by community of interests and bound together by commercial treaties, and expressing this unity by periodical congresses presided over by himself, and by universal exhibitions. In this way he would reconcile the revolutionary principle of the supremacy of the people with historical tradition, a thing which neither the Restoration nor the July monarchy nor the Republic of 1848 had been able to achieve. Universal suffrage, the organization of Rumanian, Italian and German nationality, and commercial liberty; this was to be the work of the Revolution. But the creation of great states side by side with France brought with it the necessity for looking for territorial compensation elsewhere, and consequently for violating the principle of nationality and abjuring his system of economic peace. Napoleon III.'s foreign policy was as contradictory as his policy in home affairs, "L'Empire, c'est la paix," was his cry; and he proceeded to make war.

So long as his power was not yet established, Napoleon III. made especial efforts to reassure European opinion, which had been made uneasy by his previous protestations against the treaties of 1815. The Crimean War, in which, supported by England and the king of Sardinia, he upheld against Russia the policy of the integrity of the Turkish empire, a policy traditional in France since Francis I., won him the adherence both of the old parties and the Liberals. And this war was the prototype of all the rest. It was entered upon with no clearly defined military purpose, and continued in a hesitating way. This was the cause, after the victory of the allies at the Alma (September 14, 1854), of the long and costly siege of Sevastopol (September 8, 1855). Napoleon III., whose joy was at its height owing to the signature of a peace which excluded Russia from the Black Sea, and to the birth of the prince imperial, which ensured the continuation of his dynasty, thought that the time had arrived to make a beginning in applying his system. Count Walewski, his minister for foreign affairs, gave a sudden and unexpected extension of scope to the deliberations of the congress which met at Paris in 1856 by inviting the plenipotentiaries to consider the questions of Greece, Rome, Naples, &c. This motion contained the principle of all the upheavals which were to effect such changes in Europe between 1859 and 1871. It was Cavour and Piedmont who immediately benefited by it, for thanks to Napoleon III. they were able to lay the Italian question before an assembly of diplomatic Europe.

It was not Orsini's attack on the 14th of January 1858 which brought this question before Napoleon. It had never ceased to occupy him since he had taken part in the patriotic conspiracies in Italy in his youth. The triumph of his armies in the East now gave him the power necessary to accomplish this mission upon which he had set his heart. The suppression of public opinion made it impossible for him to be enlightened as to the conflict between the interests of the country and his own generous visions. The sympathy of all Europe was with Italy, torn for centuries past between so many masters; under Alexander II. Russia, won over since the interview of Stuttgart by the emperor's generosity rather than conquered by armed force, offered no opposition to this act of justice; while England applauded it from the first. The emperor, divided between the empress Eugénie, who as a Spaniard and a devout Catholic was hostile to anything which might threaten the papacy, and Prince Napoleon, who as brother-in-law of Victor Emmanuel favoured the cause of Piedmont, hoped to conciliate both sides by setting up an Italian federation, intending to reserve the presidency of it to Pope Pius IX., as a mark of respect to the moral authority of the Church. Moreover, the

very difficulty of the undertaking appealed to the emperor, elated by his recent success in the Crimea. At the secret meeting between Napoleon and Count Cavour (July 20, 1858) the eventual armed intervention of France, demanded by Orsini before he mounted the scaffold, was definitely promised.

The ill-advised Austrian ultimatum demanding the immediate cessation of Piedmont's preparations for war precipitated the Italian expedition. On the 3rd of May 1859 Napoleon declared his intention of making Italy "free from the Alps to the Adriatic." As he had done four years ago, he plunged into the war with no settled scheme and without preparation; he held out great hopes, but without reckoning what efforts would be necessary to realize them. Two months later, in spite of the victories of Montebello, Magenta and Solferino, he suddenly broke off, and signed the patched-up peace of Villafranca with Francis Joseph (July 9). Austria ceded Lombardy to Napoleon III., who in turn ceded it to Victor Emmanuel; Modena and Tuscany were restored to their respective dukes, the Romagna to the pope, now president of an Italian federation. The mountain had brought forth a mouse.

The reasons for this breakdown on the part of the emperor in the midst of his apparent triumph were many. Neither Magenta nor Solferino had been decisive battles. Further, his idea of a federation was menaced by the revolutionary movement which seemed likely to drive out all the princes of central Italy, and to involve him in an unwelcome dispute with the French clerical party. Moreover, he had forgotten to reckon with the Germanic Confederation, which was bound to come to the assistance of Austria. The mobilization of Prussia on the Rhine, combined with military difficulties and the risk of a defeat in Venetian territory, rather damped his enthusiasm, and decided him to put an end to the war. The armistice fell upon the Italians as a bolt from the blue, convincing them that they had been betrayed; on all sides despair drove them to sacrifice their jealously guarded independence to national unity. On the one hand the Catholics were agitating throughout all Europe to obtain the independence of the papal territory; and the French republicans were protesting, on the other hand, against the abandonment of those revolutionary traditions, the revival of which they had hailed so enthusiastically. The emperor, unprepared for the turn which events had taken, attempted to disentangle this confusion by suggesting a fresh congress of the Powers, which should reconcile dynastic interests with those of the people. After a while he gave up the attempt and resigned himself to the position, his actions having had more wide-reaching results than he had wished. The treaty of Zürich proclaimed the fallacious principle of non-intervention (November 10, 1859); and then, by the treaty of Turin of the 24th of May 1860, Napoleon threw over his ill-timed confederation. He conciliated the mistrust of Great Britain by replacing Walewski, who was hostile to his policy, by Thouvenel, an anti-clerical and a supporter of the English alliance, and he counterbalanced the increase of the new Italian kingdom by the acquisition of Nice and Savoy. Napoleon, like all French governments, only succeeded in finding a provisional solution for the Italian problem.

But this solution would only hold good so long as the emperor was in a powerful position. Now this Italian war, in which he had given his support to revolution beyond the Alps, and, though unintentionally, compromised the temporal power of the popes, had given great offence to the Catholics, to whose support the establishment of the Empire was largely due. A keen Catholic opposition sprang up, voiced in L. Veuillot's paper the *Univers*, and was not silenced even by the Syrian expedition (1860) in favour of the Catholic Maronites, who were being persecuted by the Druses. On the other hand, the commercial treaty with Great Britain which was signed in January 1860, and which ratified the free-trade policy of Richard Cobden and Michael Chevalier, had brought upon French industry the sudden shock of foreign competition. Thus both Catholics and protectionists made the discovery that absolutism may be an excellent thing when it

Napoleon III.'s ideas.

The Crimean War.

The War in Italy.

The peace of Villafranca.

The Italian problem.

Catholic and protectionist opposition.

serves their ambitions or interests, but a bad thing when it is exercised at their expense. But Napoleon, in order to restore the prestige of the Empire before the newly-awakened hostility of public opinion, tried to gain from the Left the support which he had lost from the Right. After the return from Italy the general amnesty of the 16th of August 1859 had marked the evolution of the absolutist empire towards the liberal, and later parliamentary empire, which was to last for ten years.

Napoleon began by removing the gag which was keeping the country in silence. On the 24th of November 1860, "by a *coup d'état* matured during his solitary meditations," like a conspirator in his love of hiding his mysterious thoughts even from his ministers, he granted to the Chambers the right to vote an address annually in answer to the speech from the throne, and to the press the right of reporting parliamentary debates. He counted on the latter concession to hold in check the growing Catholic opposition, which was becoming more and more alarmed by the policy of *laissez-faire* practised by the emperor in Italy. But the government majority already showed some signs of independence. The right of voting on the budget by sections, granted by the emperor in 1861, was a new weapon given to his adversaries. Everything conspired in their favour: the anxiety of those candid friends who were calling attention to the defective budget; the commercial crisis, aggravated by the American Civil War; and above all, the restless spirit of the emperor, who had annoyed his opponents in 1860 by insisting on an alliance with Great Britain in order forcibly to open the Chinese ports for trade, in 1863 by his ill-fated attempt to put down a republic and set up a Latin empire in Mexico in favour of the archduke Maximilian of Austria, and from 1861 to 1863 by embarking on colonizing experiments in Cochin China and Annam.

The same inconsistencies occurred in the emperor's European politics. The support which he had given to the Italian cause had aroused the eager hopes of other nations. The proclamation of the kingdom of Italy on the 18th of February 1861 after the rapid annexation of Tuscany and the kingdom of Naples had proved the danger of half-measures. But when a concession, however narrow, had been made to the liberty of one nation, it could hardly be refused to the no less legitimate aspirations of the rest. In 1863 these "new rights" again clamoured loudly for recognition, in Poland, in Schleswig and Holstein, in Italy, now indeed united, but with neither frontiers nor capital, and in the Danubian principalities. In order to extricate himself from the Polish *impasse*, the emperor again had recourse to his expedient—always fruitless because always inopportune—of a congress. He was again unsuccessful: England refused even to admit the principle of a congress, while Austria, Prussia and Russia gave their adhesion only on conditions which rendered it futile, *i.e.* they reserved the vital questions of Venetia and Poland.

Thus Napoleon had yet again to disappoint the hopes of Italy, let Poland be crushed, and Germany triumph over Denmark in the Schleswig-Holstein question. These inconsistencies resulted in a combination of the opposition parties, Catholic, Liberal and Republican, in the *Union libérale*. The elections of May-June 1863 gained the Opposition forty seats and a leader, Thiers, who at once urgently gave voice to its demand for "the necessary liberties."

It would have been difficult for the emperor to mistake the importance of this manifestation of French opinion, and in view of his international failures, impossible to repress it. The sacrifice of Persigny, minister of the interior, who was responsible for the elections, the substitution for the ministers without portfolio of a sort of presidency of the council filled by Rouher, the "Vice-Emperor," and the nomination of V. Duruy, an anti-clerical, as minister of public instruction, in reply to those attacks of the Church which were to culminate in the Syllabus of 1864, all indicated a distinct rapprochement between the emperor and the Left. But though the opposition represented by Thiers was rather constitutional than dynastic, there was another and irreconcilable opposition,

that of the amnestied or voluntarily exiled republicans, of whom Victor Hugo was the eloquent mouthpiece. Thus those who had formerly constituted the governing classes were again showing signs of their ambition to govern. There appeared to be some risk that this movement among the *bourgeoisie* might spread to the people. As Antaeus recruited his strength by touching the earth Napoleon believed that he would consolidate his menaced power by again turning to the labouring masses, by whom that power had been established.

This industrial policy he embarked upon as much from motives of interest as from sympathy, out of opposition to the *bourgeoisie*, which was ambitious of governing or desirous of his overthrow. His course was all the easier, since he had only to exploit the prejudices of the working classes. They had never forgotten the *loi Chapelle* of 1791, which by forbidding all combinations among the workmen had placed them at the mercy of their employers, nor had they forgotten how the limited suffrage had conferred upon capital a political monopoly which had put it out of reach of the law, nor how each time they had left their position of rigid isolation in order to save the Charter or universal suffrage, the triumphant *bourgeoisie* had repaid them at the last with neglect. The silence of public opinion under the Empire and the prosperous state of business had completed the separation of the labour party from the political parties. The visit of an elected and paid labour delegation to the Universal Exhibition of 1862 in London gave the emperor an opportunity for re-establishing relations with that party, and these relations were to his mind all the more profitable, since the labour party, by refusing to associate their social and industrial claims with the political ambitions of the *bourgeoisie*, maintained a neutral attitude between the parties, and could, if necessary, divide them, while by its keen criticism of society it aroused the conservative instincts of the *bourgeoisie* and consequently checked their enthusiasm for liberty. A law of the 23rd of May 1863 gave the workmen the right, as in England, to save money by creating co-operative societies. Another law, of the 25th of May 1864, gave them the right to enforce better conditions of labour by organizing strikes. Still further, the emperor permitted the workmen to imitate their employers by establishing unions for the permanent protection of their interests. And finally, when the *ouvriers*, with the characteristic French tendency to insist on the universal application of a theory, wished to substitute for the narrow utilitarianism of the English trade-unions the ideas common to the wage-earning classes of the whole world, he put no obstacles in the way of their leader M. Tolain's plan for founding an International Association of Workers (*Société Internationale des Travailleurs*). At the same time he encouraged the provision made by employers for thrift and relief and for improving the condition of the working-classes.

Thus assured of support, the emperor, through the mouth-piece of M. Rouher, who was a supporter of the absolutist régime, was able to refuse all fresh claims on the part of the Liberals. He was aided by the cessation of the industrial crisis as the American civil war came to an end, by the apparent closing of the Roman question by the convention of the 15th of September, which guaranteed to the papal states the protection of Italy, and finally by the treaty of the 30th of October 1864, which temporarily put an end to the crisis of the Schleswig-Holstein question. But after 1865 the momentary agreement which had united Austria and Prussia for the purpose of administering the conquered duchies gave place to a silent antipathy which foreboded a rupture. Yet, though the Austro-Prussian War of 1866 was not unexpected, its rapid termination and fateful outcome came as a severe and sudden shock to France. Napoleon had hoped to gain fresh prestige for his throne and new influence for France by an intervention at the proper moment between combatants equally matched and mutually exhausted. His calculations were upset and his hopes dashed by the battle of Sadowa (Königgrätz) on the 4th of July. The treaty of Prague put an end to the secular rivalry of Habsburg and Hohenzollern for the hegemony of Germany, which had been France's

The
Liberal
Empire.

Industrial
policy
of the
Empire.

The
policy of
national-
ism.

Sadowa
(1866).

opportunity; and Prussia could afford to humour the just claims of Napoleon by establishing between her North German Confederation and the South German states the illusory frontier of the Main. The belated efforts of the French emperor to obtain "compensation" on the left bank of the Rhine, at the expense of the South German states, made matters worse. France realized with an angry surprise that on her eastern frontier had arisen a military power by which her influence, if not her existence, was threatened; that in the name of the principle of nationality unwilling populations had been brought under the sway of a dynasty by tradition militant and aggressive, by tradition the enemy of France; that this new and threatening power had destroyed French influence in Italy, which owed the acquisition of Venetia to a Prussian alliance and to Prussian arms; and that all this had been due to Napoleon, outwitted and outmaneuvered at every turn, since his first interview with Bismarck at Biarritz in October 1865.

All confidence in the excellence of imperial régime vanished at once. Thiers and Jules Favre as representatives of the Opposition denounced in the Legislative Body the blunders of 1866. Émile Ollivier split up the official majority by the amendment of the 45, and gave it to be understood that a reconciliation with the Empire would be impossible until the emperor would grant entire liberty. The recall of the French troops from Rome, in accordance with the convention of 1864, also led to further attacks by the Ultramontane party, who were alarmed for the papacy. Napoleon III. felt the necessity for developing "the great act of 1860" by the decree of the 19th of January 1867. In spite of Rouher, by a secret agreement with Ollivier the right of interpellation was restored to the Chambers. Reforms in press supervision and the right of holding meetings were promised. It was in vain that M. Rouher tried to meet the Liberal opposition by organizing a party for the defence of the Empire, the "Union dynastique." But the rapid succession of international reverses prevented him from effecting anything.

The year 1867 was particularly disastrous for the Empire. In Mexico "the greatest idea of the reign" ended in a humiliating withdrawal before the ultimatum of the United States, while Italy, relying on her new alliance with Prussia and already forgetful of her promises, was mobilizing the revolutionary forces to complete her unity by conquering Rome. The chassespots of Mentana were needed to check the Garibaldians. And when the imperial diplomacy made a belated attempt to obtain from the victorious Bismarck those territorial compensations on the Rhine, in Belgium and in Luxemburg, which it ought to have been possible to exact from him earlier at Biarritz, Benedetti added to the mistake of asking at the wrong time the humiliation of obtaining nothing (see LUXEMBURG). Napoleon did not dare to take courage and confess his weakness. And finally was seen the strange contrast of France, though reduced to such a state of real weakness, courting the mockery of Europe by a display of the external magnificence which concealed her decline. In the Paris transformed by Baron Haussmann and now become almost exclusively a city of pleasure and frivolity, the opening of the Universal Exhibition was marked by Berezowski's attack on the tsar Alexander II., and its success was clouded by the tragic fate of the unhappy emperor Maximilian of Mexico. Well might Thiers exclaim, "There are no blunders left for us to make."

But the emperor managed to commit still more, of which the consequences both for his dynasty and for France were irreparable. Old, infirm and embittered, continually keeping his ministers in suspense by the uncertainty and secrecy of his plans, surrounded by a people now bent almost entirely on pleasure, and urged on by a growing opposition, there now remained but two courses open to Napoleon III.: either to arrange a peace which should last, or to prepare for a decisive war. He allowed himself to drift in the direction of war, but without bringing things to a necessary state of preparation. It was in vain that Count Beust revived on behalf of the Austrian

government the project abandoned by Napoleon since 1866 of a settlement on the basis of the *status quo* with reciprocal disarmament. Napoleon refused, on hearing from Colonel Stoffel, his military attaché at Berlin, that Prussia would not agree to disarmament. But he was more anxious than he was willing to show. A reconstitution of the military organization seemed to him to be necessary. This Marshal Niel was unable to obtain either from the Bonapartist Opposition, who feared the electors, in whom the old patriotism had given place to the commercial or cosmopolitan spirit, or from the Republican opposition, who were unwilling to strengthen the despotism. Both of them were blinded by party interest to the danger from outside.

The emperor's good fortune had departed; he was abandoned by men and disappointed by events. He had vainly hoped that, though by the laws of May-June 1868, granting the freedom of the press and authorizing meetings, he had conceded the right of speech, he would retain the right of action; but he had played into the hands of his enemies. Victor Hugo's *Châtiments*, the insults of Rochefort's *Lanterne*, the subscription for the monument to Baudin, the deputy killed at the barricades in 1851, followed by Gambetta's terrible speech against the Empire on the occasion of the trial of Delescluze, soon showed that the republican party was irreconcilable, and bent on the Republic. On the other hand, the Ultramontane party were becoming more and more discontented, while the industries formerly protected were equally dissatisfied with the free-trade reform. Worse still, the working classes had abandoned their political neutrality, which had brought them nothing but unpopularity, and gone over to the enemy. Despising Proudhon's impassioned attacks on the slavery of communism, they had gradually been won over by the collectivist theories of Karl Marx or the revolutionary theories of Bakounine, as set forth at the congresses of the International. At these Labour congresses, the fame of which was only increased by the fact that they were forbidden, it had been affirmed that the social emancipation of the worker was inseparable from his political emancipation. Henceforth the union between the internationalists and the republican bourgeois was an accomplished fact. The Empire, taken by surprise, sought to curb both the middle classes and the labouring classes, and forced them both into revolutionary actions. On every side took place strikes, forming as it were a review of the effective forces of the Revolution.

The elections of May 1869, made during these disturbances, inflicted upon the Empire a serious moral defeat. In spite of the revival by the government of the cry of the red terror, Ollivier, the advocate of conciliation, was rejected by Paris, while 40 irreconcilables and 116 members of the Third Party were elected. Concessions had to be made to these, so by the *senatus-consulte* of the 8th of September 1869 a parliamentary monarchy was substituted for personal government. On the 2nd of January 1870 Ollivier was placed at the head of the first homogeneous, united and responsible ministry. But the republican party, unlike the country, which hailed this reconciliation of liberty and order, refused to be content with the liberties they had won; they refused all compromise, declaring themselves more than ever decided upon the overthrow of the Empire. The murder of the journalist Victor Noir by Pierre Bonaparte, a member of the imperial family, gave the revolutionaries their long desired opportunity (January 10). But the *émeute* ended in a failure, and the emperor was able to answer the personal threats against him by the overwhelming victory of the plebiscite of the 8th of May 1870.

But this success, which should have consolidated the Empire, determined its downfall.¹ It was thought that a diplomatic success should complete it, and make the country forget liberty for glory. It was in vain that after the parliamentary revolution of the 2nd of January that prudent statesman Comte Daru revived, through Lord Clarendon, Count Beust's plan of disarmament after Sadowa. He met with a refusal from Prussia and from the imperial *entourage*. The Empress Eugénie was credited with

Further concessions of Napoleon III.

Struggle between Ollivier and Rouher.

The year 1867.

Peace or war.

Action of the revolutionaries.

The parliamentary Empire.

The Franco-German war.

the remark, "If there is no war, my son will never be emperor." The desired pretext was offered on the 3rd of July 1870 by the candidature of a Hohenzollern prince for the throne of Spain. To the French people it seemed that Prussia, barely mistress of Germany, was reviving against France the traditional policy of the Habsburgs. France, having rejected for dynastic reasons the candidature of a Frenchman, the duc de Montpensier, saw herself threatened with a German prince. Never had the emperor, now both physically and morally ill, greater need of the counsels of a clear-headed statesman and the support of an enlightened public opinion if he was to defeat the statecraft of Bismarck. But he could find neither.

Ollivier's Liberal ministry, wishing to show itself as jealous for national interests as any absolutist ministry, bent upon doing something great, and swept away by the force of that opinion which it had itself set free, at once accepted the war as inevitable, and prepared for it with a light heart. In face of the decided declaration of the duc de Gramont, the minister for foreign affairs, before the Legislative Body of the 6th of July, Europe, in alarm, supported the efforts of French diplomacy and obtained the withdrawal of the Hohenzollern candidature. This did not suit the views either of the war party in Paris or of Bismarck, who wanted the other side to declare war. The ill-advised action of Gramont in demanding from King William one of those promises for the future which are humiliating but never binding, gave Bismarck his opportunity, and the king's refusal was transformed by him into an insult by the "editing" of the Ems telegram. The chamber, in spite of the desperate efforts of Thiers and Gambetta, now voted by 246 votes to 10 in favour of the war.

France found herself isolated, as much through the duplicity of Napoleon as through that of Bismarck. The disclosure to the diets of Munich and Stuttgart of the written text of the claims laid by Napoleon on the territories of Hesse and Bavaria had since the 22nd of August 1866 estranged southern Germany from France, and disposed the southern states to sign the military convention with Prussia. Owing to a similar series of blunders, the rest of Europe had become hostile. Russia, which it had been Bismarck's study both during and after the Polish insurrection of 1863 to draw closer to Prussia, learnt with annoyance, by the same indiscretion, how Napoleon was keeping his promises made at Stuttgart. The hope of gaining a revenge in the East for her defeat of 1856 while France was in difficulties made her decide on a benevolent neutrality. The disclosure of Benedetti's designs of 1867 on Belgium and Luxemburg equally ensured an unfriendly neutrality on the part of Great Britain. The emperor counted at least on the alliance of Austria and Italy, for which he had been negotiating since the Salzburg interview (August 1867). But Austria, having suffered at his hands in 1859 and 1866, was not ready and asked for a delay before joining in the war; while the hesitating friendships of Italy could only be won by the evacuation of Rome. The chassepots of Mentana, Rouher's "Never," and the hostility of the Catholic empress to any secret article which should open to Italy the gates of the capital, deprived France of her last friend.

Marshal Leboeuf's armies were no more effective than Gramont's alliances. The incapacity of the higher officers of the French army, the lack of preparation for war at headquarters, the selfishness and shirking of responsibility on the part of the field officers, the absence of any fixed plan when failure to mobilize had destroyed all chance of the strong offensive which had been counted on, and the folly of depending on chance, as the emperor had so often

¹ In the 14th volume of his *L'Empire libéral* (1909) M. Émile Ollivier gives a detailed and illuminating account of the events that led up to the war. He indignantly denies that he ever said that he contemplated it "with a light heart," and says that he disapproved of Gramont's demand for "guarantees," to which he was not privy. His object is to prove that France was entrapped by Bismarck into a position in which she was bound in honour to declare war. (ED.)

done successfully, instead of scientific warfare, were all plainly to be seen as early as the insignificant engagement of Saarbrücken. Thus the French army proceeded by disastrous stages from Weissenburg, Forbach, Froeschweiler, Borny, Gravelotte, Noisseville and Saint-Privat to the siege of Metz and the slaughter at Illy. By the capitulation of Sedan the Empire lost its only support, the army, and fell. Paris was left unprotected and emptied of troops, with only a woman at the Tuileries, a terrified Assembly at the Palais-Bourbon, a ministry, that of Palikao, without authority, and leaders of the Opposition who fled as the catastrophe approached. (P. W.)

THE THIRD REPUBLIC 1870-1909

The Third Republic may be said to date from the revolution of the 4th of September 1870, when the republican deputies of Paris at the hôtel de ville constituted a provisional government under the presidency of General Trochu, military governor of the capital. The Empire had fallen, and the emperor was a prisoner in Germany. As, however, since the great Revolution régimes in France have been only passing expedients, not inextricably associated with the destinies of the people, but bound to disappear when accounted responsible for national disaster, the surrender of Louis Napoleon's sword to William of Prussia did not disarm the country. Hostilities were therefore continued. The provisional government had to assume the part of a Committee of National Defence, and while insurrection was threatening in Paris, it had, in the face of the invading Germans, to send a delegation to Tours to maintain the relations of France with the outside world. Paris was invested, and for five months endured siege, bombardment and famine. Before the end of October the capitulation of Metz, by the treason of Marshal Bazaine, deprived France of the last relic of its regular army. With indomitable courage the garrison of Paris made useless sorties, while an army of irregular troops vainly essayed to resist the invader, who had reached the valley of the Loire. The acting Government of National Defence, thus driven from Tours, took refuge at Bordeaux, where it awaited the capitulation of Paris, which took place on the 29th of January 1871. The same day the preliminaries of peace were signed at Versailles, which, confirmed by the treaty of Frankfurt of the 10th of May, transferred from France to Germany the whole of Alsace, excepting Belfort, and a large portion of Lorraine, including Metz, with a money indemnity of two hundred millions sterling.

On the 13th of February 1871 the National Assembly, elected after the capitulation of Paris, met at Bordeaux and assumed the powers hitherto exercised by the Government of National Defence. Since the meeting of the states-general in 1789 no representative body in France had ever contained so many men of distinction. Elected to conclude a peace, the great majority of its members were monarchists, Gambetta, the rising hope of the republicans, having discredited his party in the eyes of the weary population by his efforts to carry on the war. The Assembly might thus have there and then restored the monarchy had not the monarchists been divided among themselves as royalist supporters of the comte de Chambord, grandson of Charles X., and as Orleanists favouring the claims of the comte de Paris, grandson of Louis Philippe. The majority being unable to unite on the essential point of the choice of a sovereign, decided to allow the Republic, declared on the morrow of Sedan, to liquidate the disastrous situation. Consequently, on the 17th of February the National Assembly elected Thiers as "Chief of the Executive Power of the French Republic," the abolition of the Empire being formally voted a fortnight later. The old minister of Louis Philippe, who had led the opposition to the Empire, and had been the chief opponent of the war, was further marked out for the position conferred on him by his election to the Assembly in twenty-six departments in recognition of his tour through Europe after the first defeats, undertaken in the patriotic hope of obtaining the intervention of the Powers on behalf of France. Thiers composed a ministry, and announced that the first duty of the government,

Government of National Defence, 1870.

Foundation of the Third Republic, 1871.

The Hohenzollern candidature.

The declaration of war.

France isolated.

Sedan. Fall of the Empire.

before examining constitutional questions, would be to reorganize the forces of the nation in order to provide for the enormous war indemnity which had to be paid to Germany before the territory could be liberated from the presence of the invader. The tacit acceptance of this arrangement by all parties was known as the "*pacte de Bordeaux*." Apart from the pressure of patriotic considerations, it pleased the republican minority to have the government of France officially proclaimed a Republic, while the monarchists thought that pending their choice of a monarch it might popularize their cause not to have it associated with the imposition of the burden of war taxation. From this fortuitous and informal transaction, accepted by a monarchical Assembly, sprang the Third Republic, the most durable régime established in France since the ancient monarchy disappeared in 1792.

The Germans marched down the Champs Elysées on the 1st of March 1871, and occupied Paris for forty-eight hours.

The National Assembly then decided to remove its sittings to Versailles; but two days before its arrival at the palace, where the king of Prussia had just been proclaimed German emperor, an insurrection broke out in Paris. The revolutionary element, which had been foremost in proclaiming the Republic on the 4th of September, had shown signs of disaffection during the siege. On the conclusion of the peace the triumphal entry of the German troops, the threatened disbanding of the national guard by an Assembly known to be anti-republican, and the resumption of orderly civic existence after the agitated life of a suffering population isolated by siege, had excited the nerves of the Parisians, always prone to revolution. The Commune was proclaimed on the 18th of March, and Paris was declared to be a free town, which recognized no government but that chosen by the people within its walls, the communard theory being that the state should consist of a federation of self-governing communes subject to no central power. Administrative autonomy was not, however, the real aim of the insurgent leaders. The name of the Commune had always been a rallying sign for violent revolutionaries ever since the Terrorists had found their last support in the municipality of Paris in 1794. In 1871 among the communard chiefs were revolutionaries of every sect, who, disagreeing on governmental and economic principles, were united in their vague but perpetual hostility to the existing order of things. The regular troops of the garrison of Paris followed the National Assembly to Versailles, where they were joined by the soldiers of the armies of Sedan and Metz, liberated from captivity in Germany. With this force the government of the Republic commenced the second siege of Paris, in order to capture the city from the Commune, which had established the parody of a government there, having taken possession of the administrative departments and set a minister at the head of each office. The second siege lasted six weeks under the eyes of the victorious Germans encamped on the heights overlooking the capital. The presence of the enemy, far from restraining the humiliating spectacle of Frenchmen waging war on Frenchmen in the hour of national disaster, seemed to encourage the fury of the combatants. The communards, who had begun their reign by the murder of two generals, concluded it, when the Versailles troops were taking the city, with the massacre of a number of eminent citizens, including the archbishop of Paris, and with the destruction by fire of many of the finest historical buildings, including the palace of the Tuileries and the hôtel de ville. History has rarely known a more unpatriotic crime than that of the insurrection of the Commune; but the punishment inflicted on the insurgents by the Versailles troops was so ruthless that it seemed to be a counter-manifestation of French hatred for Frenchmen in civil disturbance rather than a judicial penalty applied to a heinous offence. The number of Parisians killed by French soldiers in the last week of May 1871 was probably 20,000, though the partisans of the Commune declared that 36,000 men and women were shot in the streets or after summary court-martial.

It is from this point that the history of the Third Republic commences. In spite of the doubly tragic ending of the war

the vitality of the country seemed unimpaired. With ease and without murmur it supported the new burden of taxation called for by the war indemnity and by the reorganization of the shattered forces of France. Thiers was thus aided in his task of liberating the territory from the presence of the enemy. His proposal at Bordeaux to make the "*essai loyal*" of the Republic, as the form of government which caused the least division among Frenchmen, was discouraged by the excesses of the Commune which associated republicanism with revolutionary disorder. Nevertheless, the monarchists of the National Assembly received a note of warning that the country might dispense with their services unless they displayed governmental capacity, when in July 1871 the republican minority was largely increased at the bye-elections. The next month, within a year of Sedan, a provisional constitution was voted, the title of president of the French Republic being then conferred on Thiers. The monarchists consented to this against their will; but they had their own way when they conferred constituent powers on the Assembly in opposition to the republicans, who argued that it was a usurpation of the sovereignty of the people for a body elected for another purpose to assume the power of giving a constitution to the land without a special mandate from the nation. The debate gave Gambetta his first opportunity of appearing as a serious politician. The "*fou furieux*" of Tours, whom Thiers had denounced for his efforts to prolong the hopeless war, was about to become the chief support of the aged Orleanist statesman whose supreme achievement was to be the foundation of the Republic.

It was in 1872 that Thiers practically ranged himself with Gambetta and the republicans. The divisions in the monarchical party made an immediate restoration impossible. This situation induced some of the moderate deputies, whose tendencies were Orleanist, to support the organization of a Republic which now no longer found its chief support in the revolutionary section of the nation, and it suited the ideas of Thiers, whose personal ambition was not less than his undoubted patriotism. Having become unexpectedly chief of the state at seventy-four he had no wish to descend again to the position of a minister of the Orleans dynasty which he had held at thirty-five. So, while the royalists refused to admit the claims of the comte de Paris, the old minister of Louis Philippe did his best to undermine the popularity of the Orleans tradition, which had been great among the Liberals under the Second Empire. He moved the Assembly to restore to the Orleans princes the value of their property confiscated under Louis Napoleon. This he did in the well-founded belief that the family would discredit itself in the eyes of the nation by accepting two millions sterling of public money at a moment when the country was burdened with the war indemnity. The incident was characteristic of his wary policy, as in the face of the anti-republican majority in the Assembly he could not openly break with the Right; and when it was suggested that he was too favourable to the maintenance of the Republic he offered his resignation, the refusal of which he took as indicating the indispensable nature of his services. Meanwhile Gambetta, by his popular eloquence, had won for himself in the autumn a triumphal progress, in the course of which he declared at Grenoble that political power had passed into the hands of "*une couche sociale nouvelle*," and he appealed to the new social strata to put an end to the comedy of a Republic without republicans. When the Assembly resumed its sittings, order having been restored in the land disturbed by war and revolution, the financial system being reconstituted and the reorganization of the army planned, Thiers read to the house a presidential message which marked such a distinct movement towards the Left that Gambetta led the applause. "The Republic exists," said the president, "it is the lawful government of the country, and to devise anything else is to devise the most terrible of revolutions."

The year 1873 was full of events fateful for the history of France. It opened with the death of Napoleon III. at Chislehurst; but the disasters amid which the Second Empire had ended were too

Rep-
blicans and
Monarch-
ists after
the war.

1872:
Thiers and
Gambetta.

recent for the youthful promise of his heir to be regarded as having any connexion with the future fortunes of France, except by the small group of Bonapartists. Thiers remained the centre of interest. Much as the monarchists disliked him, they at first shrank from upsetting him before they were ready with a scheme of monarchical restoration, and while Gambetta's authority was growing in the land. But when the Left Centre took alarm at the return of radical deputies at numerous by-elections the reactionaries utilized the divisions in the republican party, and for the only time in the history of the Third Republic they gave proof of parliamentary adroitness. The date for the evacuation of France by the German troops had been advanced, largely owing to Thiers' successful efforts to raise the war indemnity. The monarchical majority, therefore, thought the moment had arrived when his services might safely be dispensed with, and the campaign against him was ably conducted by a coalition of Legitimists, Orleanists and Bonapartists. The attack on Thiers was led by the duc de Broglie, the son of another minister of Louis Philippe and grandson of Madame de Staël. Operations began with the removal from the chair of the Assembly of Jules Grévy, a moderate republican, who was chosen president at Bordeaux, and the substitution of Buffet, an old minister of the Second Republic who had rallied to the Empire. A debate on the political tendency of the government brought Thiers himself to the tribune to defend his policy. He maintained that a conservative Republic was the only régime possible, seeing that the monarchists in the Assembly could not make a choice between their three pretenders to the throne. A resolution, however, was carried which provoked the old statesman into tendering his resignation. This time it was not declined, and the majority with unseemly

Resignation of Thiers.

haste elected as president of the Republic Marshal MacMahon, duc de Magenta, an honest soldier of royalist sympathies, who had won renown and a ducal title on the battlefields of the Second Empire. In the eyes of Europe the curt dismissal of the aged liberator of the territory was an act of ingratitude. Its justification would have been the success of the majority in forming a stable monarchical government; but the sole result of the 24th of May 1873 was to provide a definite date to mark the opening of the era of anti-republican incompetency in France which has lasted for more than a generation, and has been perhaps the most effective guardian of the Third Republic.

Marshal MacMahon president of the Republic.

The political incompetency of the reactionaries was fated never to be corrected by the intelligence of its princes or of its chiefs, and the year which saw Thiers dismissed to make way for a restoration saw also that restoration indefinitely postponed by the fatal action of the legitimist pretender. The comte de Paris went to Frohsdorf to abandon to the comte de Chambord his claims to the crown as the heir of the July Monarchy, and to accept the position of dauphin, thus implying that his grandfather Louis Philippe was a usurper. With the "Government of Moral Order" in command the restoration of the monarchy seemed imminent, when the royalists had their hopes dashed by the announcement that "Henri V." would accept the throne only on the condition that the nation adopted as the standard of France the white flag—at the very sight of which Marshal MacMahon said the rifles in the army would go off by themselves. The comte de Chambord's refusal to accept the tricolour was

probably only the pretext of a childless man who had no wish to disturb his secluded life for the ultimate benefit of the Orleans family which had usurped his crown, had sent him as a child into exile, and outraged his mother the duchesse de Berry. Whatever his motive, his decision could have no other effect than that of establishing the Republic, as he was likely to live for years, during which the comte de Paris' claims had to remain suspended. It was not possible to leave the land for ever under the government improvised at Bordeaux when the Germans were masters of France; so the majority in the Assembly decided to organize another provisional government on more regular lines, which might possibly last till the comte de Chambord had taken the white flag

The comte de Chambord.

to the grave, leaving the way to the throne clear for the comte de Paris. On the 19th of November 1873 a Bill was passed which instituted the Septennate, whereby the executive power was confided to Marshal MacMahon for seven years. It also provided for the nomination of a commission of the National Assembly to take in hand the enactment of a constitutional law. Before this an important constitutional innovation had been adopted. Under Thiers there were no changes of ministry. The president of the Republic was perpetual prime minister, constantly dismissing individual holders of portfolios, but never changing at one moment the whole council of ministers. Marshal MacMahon, the day after his appointment, nominated a cabinet with a vice-president of the council as premier, and thus inaugurated the system of ministerial instability which has been the most conspicuous feature of the government of the Third Republic. Under the Septennate the ministers, monarchist or moderate republican, were socially and perhaps intellectually of a higher class than those who governed France during the last twenty years of the 19th century. But the duration of the cabinets was just as brief, thus displaying the fact, already similarly demonstrated under the Restoration and the July Monarchy, that in France parliamentary government is an importation not suited to the national temperament.

The duc de Broglie was the prime minister in MacMahon's first two cabinets which carried on the government of the country up to the first anniversary of Thiers' resignation. The duc de Broglie's defeat by a coalition of Legitimists and Bonapartists with the Republicans displayed the mutual attitude of parties. The Royalists, chagrined that the fusion of the two branches of the Bourbons had not brought the comte de Chambord to the throne, vented their rage on the Orleanists, who had the chief share in the government without being able to utilize it for their dynasty. The Bonapartists, now that the memory of the war was receding, were winning elections in the provinces, and were further encouraged by the youthful promise of the Prince Imperial. The republicans had so improved their position that the duc d'Audiffret-Pasquier, great-nephew of the chancellor Pasquier, tried to form a coalition ministry with M. Waddington, afterwards ambassador of the Republic in London, and other members of the Left Centre. Out of this uncertain state of affairs was evolved the constitution which has lasted the longest of all those that France has tried since the abolition of the old monarchy in 1792. Its birth was due to chance. Not being able to restore a monarchy, the National Assembly was unwilling definitively to establish a republic, and as no limit was set by the law on the duration of its powers, it might have continued the provisional state of things had it not been for the Bonapartists. That party displayed so much activity in agitating for a plebiscite, that when the rural voters at by-elections began to rally to the Napoleonic idea, alarm seized the constitutionalists of the Right Centre who had never been persuaded by Thiers' exhortations to accept the Republic. Consequently in January 1875 the Assembly, having voted the general principle that the legislative power should be exercised by a Senate and a Chamber of Deputies, without any mention of the executive régime, accepted by a majority of one a momentous resolution proposed by M. Wallon, a member of the Right Centre. It provided that the president of the Republic should be elected by the absolute majority of the Senate and the Chamber united as a National Assembly, that he should be elected for seven years, and be eligible for re-election. Thus by one vote the Republic was formally established, "the Father of the Constitution" being M. Wallon, who began his political experiences in the Legislative Assembly of 1849, and survived to take an active part in the Senate until the twentieth century.

The Septennate.

The Republic being thus established, General de Cisse, who had become prime minister, made way for M. Buffet, but retained his portfolio of war in the new coalition cabinet, which contained some distinguished members of the two central groups, including M. Léon Say. A fortnight previously, at the end of February

Constitution voted, 1875.

1875, were passed two statutes defining the legislative and executive powers in the Republic, and organizing the Senate. These joined to a third enactment, voted in July, form the body of laws known as the "Constitution of 1875," which though twice revised, lasted without essential alteration to the twentieth century. The legislative power was conferred on a Senate and a Chamber of Deputies, which might unite in congress to revise the constitution, if they both agreed that revision was necessary, and which were bound so to meet for the election of the president of the Republic when a vacancy occurred. It was enacted that the president so elected should retain office for seven years, and be eligible for re-election at the end of his term. He was also held to be irresponsible, except in the case of high treason. The other principal prerogatives bestowed on the presidential office by the constitution of 1875 were the right of initiating laws concurrently with the members of the two chambers; the promulgation of the laws; the right of dissolving the Chamber of Deputies before its legal term on the advice of the Senate, and that of adjourning the sittings of both houses for a month; the right of pardon; the disposal of the armed forces of the country; the reception of diplomatic envoys, and, under certain limitations, the power to ratify treaties. The constitution relieved the president of the responsibility of private patronage, by providing that every act of his should be countersigned by a minister. The constitutional law provided that the Senate should consist of 300 members, 75 being nominated for life by the National Assembly, and the remaining 225 elected for nine years by the departments and the colonies. Vacancies among the life members, after the dissolution of the National Assembly, were filled by the Senate until 1884, when the nominative system was abolished, though the survivors of it were not disturbed. The law of 1875 enacted that the elected senators, who were distributed among the departments on a rough basis of population, should be elected for nine years, a third of them retiring triennially. It was provided that the senatorial electors in each department should be the deputies, the members of the *conseil général* and of the *conseils d'arrondissement*, and delegates nominated by the municipal councils of each commune. As the municipal delegates composed the majority in each electoral college, Gambetta called the Senate the Grand Council of the Communes; but in practice the senators elected have always been the nominees of the local deputies and of the departmental councillors (*conseillers généraux*).

The Constitutional Law further provided that the deputies should be elected to the Chamber for four years by direct manhood suffrage, which had been enjoyed in France ever since 1848. The laws relating to registration, which is of admirable simplicity in France, were left practically the same as under the Second Empire. From 1875 to 1885 the elections were held on the basis of *scrutin d'arrondissement*, each department being divided into single-member districts. In 1885 *scrutin de liste* was tried, the department being the electoral unit, and each elector having as many votes as there were seats ascribed to the department without the power to cumulate—like the voting in the city of London when it returned four members. In 1889 *scrutin d'arrondissement* was resumed. The payment of members continued as under the Second Empire, the salary now being fixed at 9000 francs a year in both houses, or about a pound sterling a day. The Senate and the Chamber were endowed with almost identical powers. The only important advantage given to the popular house in the paper constitution was its initiative in matters of finance, but the right of rejecting or of modifying the financial proposals of the Chamber was successfully upheld by the Senate. In reality the Chamber of Deputies has overshadowed the upper house. The constitution did not prescribe that ministers should be selected from either house of parliament, but in practice the deputies have been in cabinets in the proportion of five to one in excess of the senators. Similarly the very numerous ministerial crises which have taken place under the Third Republic have with the rarest exceptions been caused by votes in the lower chamber. Among minor differences between the two houses

ordained by the constitution was the legal minimum age of their members, that of senators being forty and of deputies twenty-five. It was enacted, moreover, that the Senate, by presidential decree, could be constituted into a high court for the trial of certain offences against the security of the state.

The constitution thus produced, the fourteenth since the Revolution of 1789, was the issue of a monarchical Assembly forced by circumstances to establish a republic. It was therefore distinguished from others which preceded it in that it contained no declaration of principle and no doctrinal theory. The comparative excellence of the work must be recognized, seeing that it has lasted. But it owed its duration, as it owed its origin and its character, to the weakness of purpose and to the dissensions of the monarchical parties. The first legal act under the new constitution was the selection by the expiring National Assembly of seventy-five nominated senators, and here the reactionaries gave a crowning example of that folly which has ever marked their conduct each time they have had the chance of scoring an advantage against the Republic. The principle of nomination had been carried in the National Assembly by the Right and opposed by the Republicans. But the quarrels of the Legitimists with the duc de Broglie and his party were so bitter that the former made a present of the nominated element in the Senate to the Republicans in order to spite the Orleanists; so out of seventy-five senators nominated by the monarchical Assembly, fifty-seven Republicans were chosen. Without this suicidal act the Republicans would have been in a woeful minority in the Senate when parliament met in 1876 after the first elections under the new system of parliamentary government. The slight advantage which, in spite of their self-destruction, the reactionaries maintained in the upper house was outbalanced by the republican success at the elections to the Chamber. In a house of over 500 members only about 150 monarchical deputies were returned, of whom half were Bonapartists. The first cabinet under the new constitution was formed by Dufaure, an old minister of Louis Philippe like Thiers, and like him born in the 18th century. The premier now took the title of president of the council, the chief of the state no longer presiding at the meetings of ministers, though he continued to be present at their deliberations. Although the republican victories at the elections were greatly due to the influence of Gambetta, none of his partisans was included in the ministry, which was composed of members of the two central groups. At the end of 1876 Dufaure retired, but nearly all his ministers retained their portfolios under the presidency of Jules Simon, a pupil of Victor Cousin, who first entered political life in the Constituent Assembly of 1848, and was later a leading member of the opposition in the last seven years of the Second Empire.

The premiership of Jules Simon came to an end with the abortive *coup d'état* of 1877, commonly called from its date the *Seize Mai*. After the election of Marshal MacMahon to the presidency, the clerical party, irritated at the failure to restore the comte de Chambord, commenced a campaign in favour of the restitution of the temporal power to the Pope. It provoked the Italian government to make common cause with Germany, as Prince Bismarck was likewise attacked by the French clericals for his ecclesiastical policy. At last Jules Simon, who was a liberal most friendly to Catholicism, had to accept a resolution of the Chamber, inviting the ministry to adopt the same disciplinary policy towards the Church which had been followed by the Second Empire and the Monarchy of July. It was on this occasion that Gambetta used his famous expression, "*Le cléricalisme, voilà l'ennemi.*" Some days later a letter appeared in the *Journal officiel*, dated 16th May 1877, signed by President MacMahon, informing Jules Simon that he had no longer his confidence, as it was clear that he had lost that influence over the Chamber which a president of the Council ought to exercise. The dismissal of the prime minister and the presidential acts which followed did not infringe the letter of the new constitution; yet the proceeding was regarded as a *coup d'état* in favour of the clerical reactionaries. The duc de

Provisions of the Constitution of 1875.

1876: Political parties under the new Constitution.

Scrutin d'arrondissement and scrutin de liste.

The Seize Mai 1877.

Brogie formed an anti-republican ministry, and Marshal MacMahon, in virtue of the presidential prerogative conferred by the law of 1875, adjourned parliament for a month. When the Chamber reassembled the republican majority of 363 denounced the coalition of parties hostile to the Republic. The president, again using his constitutional prerogative, obtained the authorization of the Senate to dissolve the Chamber. Meanwhile the Broglie ministry had put in practice the policy, favoured by all parties in France, of replacing the functionaries hostile to it with its own partisans. But in spite of the administrative electoral machinery being thus in the hands of the reactionaries, a republican majority was sent back to the Chamber, the sudden death of Thiers on the eve of his expected return to power, and the demonstration at his funeral, which was described as a silent insurrection, aiding the rout of the monarchists. The duc de Broglie resigned, and Marshal MacMahon sent for General de Rochebouet, who formed a cabinet of unknown reactionaries, but it lasted only a few days, as the Chamber refused to vote supply. Dufaure was then called back to office, and his moderate republican ministry lasted for the remainder of the MacMahon presidency.

Thus ended the episode of the *Seize Mai*, condemned by the whole of Europe from its inception. Its chief effects were to prove again to the country the incompetency of the monarchists, and by associating in the public mind the Church with this ill-conceived venture, to provoke reprisals from the anti-clericals when they came into power. After the storm, the year 1878 was one of political repose. The first international exhibition held at Paris after the war displayed to Europe how the secret of France's recuperative power lay in the industry and artistic instinct of the nation. Marshal MacMahon presided with dignity over the fêtes held in honour of the exhibition, and had he pleased he might have tranquilly fulfilled the term of his Septennate. But in January 1879 he made a difference of opinion on a military question an excuse for resignation, and Jules Grévy, the president of the Chamber, was elected to succeed him by the National Assembly, which thus met for the first time under the Constitutional Law of 1875.

Henceforth the executive as well as the legislative power was in the hands of the republicans. The new president was a leader of the bar, who had first become known in the Constituent Assembly of 1848 as the advocate of the principle that a republic would do better without a president. M. Waddington was his first prime minister, and Gambetta was elected president of the Chamber. The latter, encouraged by his rivals in the idea that the time was not ripe for him openly to direct the affairs of the country, thus put himself, in spite of his occult dictatorship, in a position of official self-effacement from which he did not emerge until the jealousies of his own party-colleagues had undermined the prestige he had gained as chief founder of the Republic. The most active among them was Jules Ferry, minister of

Education, who having been a republican deputy for Paris at the end of the Empire, was one of the members of the provisional government proclaimed on 4th September 1870. Borrowing Gambetta's cry that clericalism was the enemy, he commenced the work of reprisal for the *Seize Mai*. His educational projects of 1879 were thus anti-clerical in tendency, the most famous being article 7 of his education bill, which prohibited members of any "unauthorized" religious orders exercising the profession of teaching in any school in France, the disability being applied to all ecclesiastical communities, excepting four or five which had been privileged by special legislation. This enactment, aimed chiefly at the Jesuits, was advocated with a sectarian bitterness which will be associated with the name of Jules Ferry long after his more statesmanlike qualities are forgotten. The law was rejected by the Senate, Jules Simon being the eloquent champion of the clericals, whose intrigues had ousted him from office. The unauthorized orders were then dissolved by decree; but though the forcible expulsion of aged priests and nuns gave rise to painful scenes, it cannot be said that popular feeling was excited in their favour, so

grievously had the Church blundered in identifying itself with the conspiracy of the *Seize Mai*.

Meanwhile the death of the Prince Imperial in Zululand had shattered the hopes of the Bonapartists, and M. de Freycinet, a former functionary of the Empire, had become prime minister at the end of 1879. He had retained Jules Ferry at the ministry of Education, but unwilling to adopt all his anti-clerical policy, he resigned the premiership in September 1880. The constitution of the first Ferry cabinet secured the further exclusion from office of Gambetta, to which, however, he preferred his "occult dictatorship." In August he had, as president of the Chamber, accompanied M. Grévy on an official visit to Cherbourg, and the acclamations called forth all over France by his speech, which was a hopeful defiance to Germany, encouraged the wily chief of the state to aid the republican conspiracy against the hero of the Republic. In 1881 the only political question before the country was the destiny of Gambetta. His influence in the Chamber was such that in spite of the opposition of the prime minister he carried his electoral scheme of *scrutin de liste*, descending from the presidential chair to defend it. Its rejection by the Senate caused no conflict between the houses. The check was inflicted not on the Chamber, but on Gambetta, who counted on his popularity to carry the lists of his candidates in all the republican departments in France as a quasi-plebiscitary demonstration in his favour. His rivals dared not openly quarrel with him. There was the semblance of a reconciliation between him and Ferry, and his name was the rallying-cry of the Republic at the general election, which was conducted on the old system of *scrutin d'arrondissement*.

The triumph for the Republic was great, the combined force of reactionary members returned being less than one-fifth of the new Chamber. M. Grévy could no longer abstain from asking Gambetta to form a ministry, but he had bided his time till jealousy of the "occult power" of the president of the Chamber had undermined his position in parliament. Consequently, when on the 14th of November 1881 Gambetta announced the composition of his cabinet, ironically called the "*grand ministère*," which was to consolidate the Republic and to be the apotheosis of its chief, a great feeling of disillusion fell on the country, for his colleagues were untried politicians. The best known was Paul Bert, a man of science, who as the "reporter" in the Chamber of the Ferry Education Bill had distinguished himself as an aggressive free-thinker, and he inappropriately was named minister of public worship. All the conspicuous republicans who had held office refused to serve under Gambetta. His cabinet was condemned in advance. His enemies having succeeded in ruining its composition, declared that the construction of a one-man machine was ominous of dictatorship, and the "*grand ministère*" lived for only ten weeks.

Gambetta was succeeded in January 1882 by M. de Freycinet, who having first taken office in the Dufaure cabinet of 1877, and having continued to hold office at intervals until 1899, was the most successful specimen of a "*ministériel*"—as recurrent portfolio-holders have been called under the Third Republic. His second ministry lasted only six months. The failure of Gambetta, though pleasing to his rivals, discouraged the republican party and disorganized its majority in the Chamber. M. Duclerc, an old minister of the Second Republic, then became president of the council, and before his short term of office was run Gambetta died on the last day of 1882, without having had the opportunity of displaying his capacity as a minister or an administrator. He was only forty-four at his death, and his fame rests on the unfulfilled promise of a brief career. The men who had driven him out of public life and had shortened his existence were the most ostentatious of the mourners at the great pageant with which he was buried, and to have been of his party was in future the popular trade-mark of his republican enemies.

Gambetta's death was followed by a period of anarchy, during which Prince Napoleon, the son of Jerome, king of Westphalia, placarded the walls of Paris with a manifesto. The Chamber thereupon voted the exile of the members of the families which

1879:
Jules
Grévy
president
of the
Republic.

Gambetta
prime
minister.

Jules
Ferry.

Death of
Gambetta.

had reigned in France. The Senate rejected the measure, and a conflict arose between the two houses. M. Duclerc resigned the premiership in January 1883 to his minister of the Interior, M. Fallières, a Gascon lawyer, who became president of the Senate in 1899 and president of the Republic in 1906. He held office for three weeks, when Jules Ferry became president of the council for the second time. Several of the closest of Gambetta's friends accepted office under the old enemy of their chief, and the new combination adopted the epithet "opportunist," which had been invented by Gambetta in 1875 to justify the expediency of his alliance with Thiers. The Opportunists thenceforth formed an important group standing between the Left Centre, which was now excluded from office, and the Radicals. It claimed the tradition of Gambetta, but the guiding principle manifested by its members was that of securing the spoils of place. To this end it often allied itself with the Radicals, and the Ferry cabinet practised this policy in 1883 when it removed the Orleans princes from the active list in the army as the illogical result of the demonstration of a Bonaparte. How needless was this proceeding was shown a few months later when the comte de Chambord died, as his death, which finally fused the Royalists with the Orleanists, caused no commotion in France.

The year 1884 was unprecedented seeing that it passed without a change of ministry. Jules Ferry displayed real administrative ability, and as an era of steady government seemed to be commencing, the opportunity was taken to revise the Constitution. The two Chambers therefore met in congress, and enacted that the republican form of government could never be the subject of revision, and that all members of families which had reigned in France were ineligible for the presidency of the Republic—a repetition of the adventure of Louis Bonaparte in the middle of the century being thus made impossible. It also decided that the clauses of the law of 1875 relating to the organization of the Senate should no longer have a constitutional character. This permitted the reform of the Upper House by ordinary parliamentary procedure. So an organic law was passed to abolish the system of nominating senators, and to increase the number of municipal delegates in the electoral colleges in proportion to the population of the communes. The French nation, for the first time since it had enjoyed political life, had revised a constitution by pacific means without a revolution. Gambetta being out of the way, his favourite electoral system of *scrutin de liste* had no longer any terror for his rivals, so it was voted by the Chamber early in 1885. Before the Senate had passed it into law the Ferry ministry had fallen at the end of March, after holding office for twenty-five months, a term rarely exceeded in the annals of the Third Republic. This long tenure of power had excited the dissatisfaction of jealous politicians, and the news of a slight disaster to the French troops in Tongking called forth all the pent-up rancour which Jules Ferry had inspired in various groups. By the exaggerated news of defeat Paris was excited to the brink of a revolution. The approaches of the Chamber were invaded by an angry mob, and Jules Ferry was the object of public hate more bitter than any man had called forth in France since Napoleon III. on the days after Sedan. Within the Chamber he was attacked in all quarters. The Radicals took the lead, supported by the Monarchists, who remembered the anti-clerical rigour of the Ferry laws, by the Left Centre, not sorry for the tribulation of the group which had supplanted it, and by place-hunting republicans of all shades. The attack was led by a politician who disdained office. M. Georges Clémenceau, who had originally come to Paris from the Vendée as a doctor, had as a radical leader in the Chamber used his remarkable talent as an overthrower of ministries, and nearly every one of the eight ministerial crises which had already occurred during the presidency of Grévy had been hastened by his mordant eloquence.

The next prime minister was M. Brisson, a radical lawyer and journalist, who in April 1885 formed a cabinet of "concentration"—that is to say, it was recruited from various groups with the

idea of concentrating all republican forces in opposition to the reactionaries. MM. de Freycinet and Carnot, afterwards president of the Republic, represented the moderate element in this ministry, which superintended the general elections under *scrutin de liste*. That system was recommended by its advocates as a remedy for the rapid decadence in the composition of the Chamber. Manhood suffrage, which had returned to the National Assembly a distinguished body of men to conclude peace with Germany, had chosen a very different type of representative to sit in the Chamber created by the constitution of 1875. At each succeeding election the standard of deputies returned grew lower, till Gambetta described them contemptuously as "*sous-vétérinaires*," indicating that they were chiefly chosen from the petty professional class, which represented neither the real democracy nor the material interests of the country. His view was that the election of members by departmental lists would ensure the candidature of the best men in each region, who under the system of single-member districts were apt to be neglected in favour of local politicians representing narrow interests. When his death had removed the fear of his using *scrutin de liste* as a plebiscitary organization, parliament sanctioned its trial. The result was not what its promoters anticipated. The composition of the Chamber was indeed transformed, but only by the substitution of reactionary deputies for republicans.

Elections of 1885.

Of the votes polled, 45% were given to the Monarchists, and if they had obtained one-half of the abstentions the Republic would have come to an end. At the same time the character of the republican deputies returned was not improved; so the sole effect of *scrutin de liste* was to show that the electorate, weary of republican dissensions, was ready to make a trial of monarchical government, if only the reactionary party proved that it contained statesmen capable of leading the nation. So menacing was the situation that the republicans thought it wise not further to expose their divisions in the presidential election which was due to take place at the end of the year. Consequently, on the 28th of December 1885, M. Grévy, in spite of his growing unpopularity, was elected president of the Republic for a second term of seven years.

The Brisson cabinet at once resigned, and on the 7th of January 1886 its most important member, M. de Freycinet, formed his third ministry, which had momentous influence on the history of the Republic. The new minister of war was General Boulanger, a smart soldier of no remarkable military record; but being the nominee of M. Clémenceau, he began his official career by taking radical measures against commanding officers of reactionary tendencies. He thus aided the government in its campaign against the families which had reigned in France, whose situation had been improved by the result of the elections. The fêtes given by the comte de Paris to celebrate his daughter's marriage with the heir-apparent of Portugal moved the republican majority in the Chambers to expel from France the heads of the houses of Orleans and of Bonaparte, with their eldest sons. The names of all the princes on the army list were erased from it, the decree being executed with unseemly ostentation by General Boulanger, who had owed early promotion to the protection of the duc d'Aumale, and on that prince protesting he was exiled too. Meanwhile General Boulanger took advantage of Grévy's unpopularity to make himself a popular hero, and at the review, held yearly on the 14th of July, the anniversary of the fall of the Bastille, his acclamation by the Parisian mob showed that he was taking an unexpected place in the imagination of the people. He continued to work with the Radicals, so when they turned out M. de Freycinet in December 1886, one of their group, M. Goblet, a lawyer from Amiens, formed a ministry, and retained Boulanger as minister of war. M. Clémenceau, however, withdrew his support from the general, who was nevertheless loudly patronized by the violent radical press. His bold attitude towards Germany in connexion with the arrest on the German frontier of a French official named Schnaebele so roused the enthusiasm of the public, that M. Goblet was not sorry to resign in May 1887 in order to get rid of his too popular colleague.

General Boulanger.

Tongking.

Ferry was the object of public hate more bitter than any man had called forth in France since Napoleon III. on the days after Sedan. Within the Chamber he was attacked in all quarters. The Radicals took the lead, supported by the Monarchists, who remembered the anti-clerical rigour of the Ferry laws, by the Left Centre, not sorry for the tribulation of the group which had supplanted it, and by place-hunting republicans of all shades. The attack was led by a politician who disdained office. M. Georges Clémenceau, who had originally come to Paris from the Vendée as a doctor, had as a radical leader in the Chamber used his remarkable talent as an overthrower of ministries, and nearly every one of the eight ministerial crises which had already occurred during the presidency of Grévy had been hastened by his mordant eloquence.

The next prime minister was M. Brisson, a radical lawyer and journalist, who in April 1885 formed a cabinet of "concentration"—that is to say, it was recruited from various groups with the

To form the twelfth of his ministries, Grévy called upon M. Rouvier, an Opportunist from Marseilles, who had first held office in Gambetta's short-lived cabinet. General Boulanger was sent to command a *corps d'armée* at Clermont-Ferrand; but the popular press and the people clamoured for the hero who was said to have terrorized Prince Bismarck, and they encouraged him to play the part of a plebiscitary candidate. There were grave reasons for public discontent. Parliament in 1887 was more than usually sterile in legislation, and in the autumn session it had to attend to a scandal which had long been rumoured: The son-in-law of Grévy, Daniel Wilson, a prominent deputy who had been an under secretary of state, was accused of trafficking the decoration of the Legion of Honour, and of using the Elysée, the president's official residence, where he lived, as an agency for his corrupt practices. The evidence against him was so clear that his colleagues in the Chamber put the government into a minority in order to precipitate a presidential crisis, and on Grévy refusing to accept this hint, a long array of politicians, representing all the republican groups, declined his invitation to aid him in forming a new ministry, all being bent on forcing his resignation. Had General Boulanger been a man of resolute courage he might at this crisis have made a *coup d'état*, for his popularity in the street and in the army increased as the Republic sank deeper into scandal and anarchy. At last, when Paris was on the brink of revolution, Grévy was prevailed on to resign. The candidates for his succession to the presidency were two ex-prime ministers, MM. Ferry and de Freycinet, and Floquet, a barrister, who had been conspicuous in the National Assembly for his sympathy with the Commune. The Monarchists had no candidate ready, and resolved to vote for Ferry, because they believed that if he were elected his unpopularity with the democracy would cause an insurrection in Paris and the downfall of the Republic. MM. de Freycinet and Floquet each looked for the support of the Radicals, and each had made a secret compact, in the event of his election, to restore General Boulanger to the war office. But M. Clémenceau, fearing the election of Jules Ferry, advised his followers to vote for an "outsider," and after some manœuvring the congress elected by a large majority Sadi Carnot.

The new president, though the nominee of chance, was an excellent choice. The grandson of Lazare Carnot, the "organizer of victory" of the Convention, he was also a man of unsullied probity. The tradition of his family name, only less glorious than that of Bonaparte in the annals of the Revolution, was welcome to France, almost ready to throw herself into the arms of a soldier of fortune, while his blameless repute reconciled some of those whose opposition to the Republic had been quickened by the mean vices of Grévy. But the name and character of Carnot would have been powerless to check the Boulangist movement without the incompetency of its leader, who was getting the democracy at his back without knowing how to utilize it. The new president's first prime minister was M. Tirard, a senator who had held office in six of Grévy's ministries, and he formed a cabinet of politicians as colourless as himself. The early months of 1888 were occupied with the trial of Wilson, who was sentenced to two years' imprisonment for fraud, and with the conflicts of the government with General Boulanger, who was deprived of his command for coming to Paris without leave. Wilson appealed against his sentence, and General Boulanger was elected deputy for the department of the Aisne by an enormous majority. It so happened that the day after his election a presidential decree was signed on the advice of the minister of war removing General Boulanger from the army, and the court of appeal quashed Wilson's conviction. Public feeling was profoundly moved by the coincidence of the release of the relative of the ex-president by the judges of the Republic on the same day that its ministers expelled from the army the popular hero of universal suffrage.

As General Boulanger had been invented by the Radicals it was thought that a Radical cabinet might be a remedy to cope with him, so M. Floquet became president of the council

in April 1888, M. de Freycinet taking the portfolio of war, which he retained through many ministries. M. Floquet's chief achievement was a duel with General Boulanger, in which, though an elderly civilian, he wounded him.

Nothing, however, checked the popularity of the military politician, and though he was a failure as a speaker in the Chamber, several departments returned him as their deputy by great majorities. The Bonapartists had joined him, and while in his manifestos he described himself as the defender of the Republic, the mass of the Monarchists, with the consent of the comte de Paris, entered the Boulangist camp, to the dismay both of old-fashioned Royalists and of many Orleanists, who resented his recent treatment of the duc d'Aumale. The centenary of the taking of the Bastille was to be celebrated in Paris by an international exhibition, and it appeared likely that it would be inaugurated by General Boulanger, so irresistible seemed his popularity. In January 1889 he was elected member for the metropolitan department of the Seine with a quarter of a million votes, and by a majority of eighty thousand over the candidate of the government. Had he marched on the Elysée the night of his election, nothing could have saved the parliamentary Republic; but again he let his chance go by. The government in alarm proposed the restoration of *scrutin d'arrondissement* as the electoral system for *scrutin de liste*. The change was rapidly enacted by the two Chambers, and was a significant commentary on the respective advantages of the two systems. M. Tirard was again called to form a ministry, and he selected as minister of the interior M. Constans, originally a professor at Toulouse, who had already proved himself a skilful manipulator of elections when he held the same office in 1881. He was therefore given the supervision of the machinery of centralization with which it was supposed that General Boulanger would have to be fought at the general election. That incomplete hero, however, saved all further trouble by flying the country when he heard that his arrest was imminent. The government, in order to prevent any plebiscitary manifestation in his favour, passed a law forbidding a candidate to present himself for a parliamentary election in more than one constituency; it also arraigned the general on the charge of treason before the Senate sitting as a high court, and he was sentenced in his absence to perpetual imprisonment. Such measures were needless. The flight of General Boulanger was the death of Boulangism. He alone had saved the Republic which had done nothing to save itself. Its government had, on the contrary, displayed throughout the crisis an anarchic feebleness and incoherency which would have speeded its end had the leader of the plebiscitary movement possessed sagacity or even common courage.

The elections of 1889 showed how completely the reactionaries had compromised their cause in the Boulangist failure. Instead of 45% of the votes polled as in 1885, they obtained only 21%, and the comte de Paris, the pretender of constitutional monarchy, was irretrievably prejudiced by his alliance with the military adventurer who had outraged the princes of his house. A period of calm succeeded the storm of Boulangism, and for the first time under the Third Republic parliament set to work to produce legislation useful for the state, without rousing party passion, as in its other period of activity when the Ferry education laws were passed. Before the elections of 1889 the reform of the army was undertaken, the general term of active compulsory service was made three years, while certain classes hitherto dispensed from serving, including ecclesiastical seminarists and lay professors, had henceforth to undergo a year's military training. The new parliament turned its attention to social and labour questions, as the only clouds on the political horizon were the serious strikes in the manufacturing districts, which displayed the growing political organization of the socialist party. Otherwise nothing disturbed the calm of the country. The young duc d'Orléans vainly tried to ruffle it by breaking his exile in order to claim his citizen's right to perform his military service. The cabinet was rearranged in March 1890, M. de Freycinet becoming prime minister for the fourth time, and

The Wilson scandal.

Boulangism.

Boulangier's flight.

M. Carnot president of the Republic, 1887.

retaining the portfolio of war. All seemed to point to the consolidation of the Republic, and even the Church made signals of reconciliation. Cardinal Lavigerie, a patriotic missionary and statesman, entertained the officers of the fleet at Algiers, and proposed the toast of the Republic to the tune of the "Marseillaise" played by his *pères blancs*. The royalist Catholics protested, but it was soon intimated that the archbishop of Algiers' demonstration was approved at Rome. The year 1891 was one of the few in the annals of the Republic which passed without a change of ministry, but the agitations of 1892 were to counterbalance the repose of the two preceding years.

The first crisis arose out of the peacemaking policy of the Pope. Following up his intimation to the archbishop of Algiers,

The papal encyclical, 1892.

Leo XIII. published in February 1892 an encyclical, bidding French Catholics accept the Republic as the firmly established form of government. The papal injunction produced a new political group called the "Ralliés," the majority of its members being Monarchists who rallied to the Republic in obedience to the Vatican. The most conspicuous among them was Comte Albert de Mun, an eloquent exponent in the Chamber of legitimism and Christian socialism. The extreme Left mistrusted the adhesion of the new converts to the Republic, and ecclesiastical questions were the constant subjects of acrimonious debates in parliament. In the course of one of them M. de Freycinet found himself in a minority. He ceased to be prime minister, being succeeded by M. Loubet, a lawyer from Montélimar, who had previously held office for three months in the first Tirard cabinet; but M. de Freycinet continued to hold his portfolio of war. The confusion of the republican groups kept pace with the disarray of the reactionaries, and outside parliament the frequency of anarchist outrages did not increase public confidence. The only figure in the Republic which grew in prestige was that of M. Carnot, who in his frequent presidential tours dignified his office, though his modesty made him unduly efface his own personality.

When the autumn session of 1892 began all other questions were overwhelmed by the bursting of the Panama scandal.

The Panama scandal.

The company associated for the piercing of the Isthmus of Panama, undertaken by M. de Lesseps, the maker of the Suez Canal, had become insolvent some years before. Fifty millions sterling subscribed by the thrift of France had disappeared, but the rumours involving political personages in the disaster were so confidently asserted to be reactionary libels, that a minister of the Republic, afterwards sent to penal servitude for corruption, obtained damages for the publication of one of them. It was known that M. de Lesseps was to be tried for misappropriating the money subscribed; but considering the vast sums lost by the public, little interest was taken in the matter till it was suddenly stirred by the dramatic suicide of a well-known Jewish financier closely connected with republican politicians, driven to death, it was said, by menaces of blackmail. Then succeeded a period of terror in political circles. Every one who had a grudge against an enemy found vent for it in the press, and the people of Paris lived in an atmosphere of delation. Unhappily it was true that ministers and members of parliament had been subsidized by the Panama company. Floquet, the president of the Chamber, avowed that when prime minister he had laid hands on £12,000 of the company's funds for party purposes, and his justification of the act threw a light on the code of public morality of the parliamentary Republic. Other politicians were more seriously implicated on the charge of having accepted subsidies for their private purposes, and emotion reached its height when the cabinet ordered the prosecution of two of its members for corrupt traffic of their offices. These two ministers were afterwards discharged, and they seem to have been accused with recklessness; but their prosecution by their own colleagues proved that the statesmen of the Republic believed that their high political circles were sapped with corruption. Finally, only twelve senators and deputies were committed for trial, and the only one convicted was a minister of M. de Freycinet's third cabinet, who pleaded guilty to receiving large bribes from the Panama company. The

public regarded the convicted politician as a scapegoat, believing that there were numerous delinquents in parliament, more guilty than he, who had not even been prosecuted. This feeling was aggravated by the sentence passed, but afterwards remitted, on the aged M. de Lesseps, who had involved French people in misfortune only because he too sanguinely desired to repeat the triumph he had achieved for France by his great work in Egypt.

Within the nation the moral result of the Panama affair was a general feeling that politics had become under the Republic a profession unworthy of honest citizens. The sentiment evoked by the scandal was one of sceptical lassitude rather than of indignation. The reactionaries had crowned their record of political incompetence. At a crisis which gave legitimate opportunity to a respectable and patriotic Opposition they showed that the country had nothing to expect from them but incoherent and exaggerated invective. If the scandal had come to light in the time of General Boulanger the parliamentary Republic would not have survived it. As it was, the sordid story did little more than produce several changes of ministry. M. Loubet resigned the premiership in December 1892 to M. Ribot, a former functionary of the Empire, whose ministry lived for three stormy weeks. On the first day of 1893 M. Ribot formed his second cabinet, which survived till the end of March, when he was succeeded by his minister of education, M. Charles Dupuy, an ex-professor who had never held office till four months previously. M. Dupuy, having taken the portfolio of the interior, supervised the general election of 1893, which took place amid the profound indifference of the population, except in certain localities where personal antagonisms excited violence. An intelligent Opposition would have roused the country at the polls against the régime compromised by the Panama affair. Nothing of the sort occurred, and the electorate preferred the doubtful probity of their republican representatives to the certain incompetence of the reactionaries. The adversaries of the Republic polled only 16% of the votes recorded, and the chief feature of the election was the increased return of socialist and radical-socialist deputies. When parliament met it turned out the Dupuy ministry, and M. Casimir-Périer quitted the presidency of the Chamber to take his place. The new prime minister was the bearer of an eminent name, being the grandson of the statesman of 1831, and the great-grandson of the owner of Vizille, where the estates of Dauphiné met in 1788, as a prelude to the assembling of the states-general the next year. His acceptance of office aroused additional interest because he was a minister possessed of independent wealth, and therefore a rare example of a French politician free from the imputation of making a living out of politics. Neither his repute nor his qualities gave long life to his ministry, which fell in four months, and M. Dupuy was sent for again to form a cabinet in May 1894.

Before the second Dupuy ministry had been in office a month President Carnot died by the knife of an anarchist at Lyons. He was perhaps the most estimable politician of the *Assassination of president Carnot.* Third Republic. Although the standard of political life was not elevated under his presidency, he at all events set a good personal example, and to have filled unscathed the most conspicuous position in the land during a period unprecedented for the scurrility of libels on public men was a testimony to his blameless character. As the term of his septennate was near, parliament was not unprepared for a presidential election, and M. Casimir-Périer, who had been spoken of as his possible successor, was elected by the Congress *Casimir-Périer president, 1894.* which met at Versailles on the 27th of June 1894, three days after Carnot's assassination. The election of one who bore respectably a name not less distinguished in history than that of Carnot seemed to ensure that the Republic would reach the end of the century under the headship of a president of exceptional prestige. But instead of remaining chief of the state for seven years, in less than seven months M. Casimir-Périer astonished France and Europe by his resignation. Scurrilously defamed by the socialist press, the new president found that the Republicans in the Chamber were not disposed to defend him in his high office; so, on the 15th of January 1895, he seized

the occasion of the retirement of the Dupuy ministry to address a message to the two houses intimating his resignation of the presidency, which, he said, was endowed with too many responsibilities and not sufficient powers.

This time the Chambers were unprepared for a presidential vacancy, and to fill it in forty-eight hours was necessarily a matter of haphazard. The choice of the congress fell on Félix Faure, a merchant of Havre, who, though minister of marine in the retiring cabinet, was one of the least-known politicians who had held office. The selection was a good one, and introduced to the presidency a type of politician unfortunately rare under the Third Republic—a successful man of business. Félix Faure had a fine presence and polished manners, and having risen from a humble origin he displayed in his person the fact that civilization descends to a lower social level in France than elsewhere. Although he was in a sense a man of the people the Radicals and Socialists in the Chambers had voted against him. Their candidate, like almost all democratic leaders in France, had never worked with his hands—M. Brisson, the son of an attorney at Bourges, a member of the Parisian bar, and perpetual candidate for the presidency. Nevertheless the Left tried to take possession of President Faure. His first ministry, composed of moderate republicans and presided over by M. Ribot, lasted until the autumn session of 1895, when it was turned out and a radical cabinet was formed by M. Léon Bourgeois, an ex-functionary, who when a prefect had been suspected of reactionary tendencies.

The Bourgeois cabinet of 1895 was remarkable as the first ministry formed since 1877 which did not contain a single member of the outgoing cabinet. It was said to be exclusively radical in its composition, and thus to indicate that the days of "republican concentration" were over, and that the Republic, being firmly established, an era of party government on the English model had arrived. The new ministry, however, on analysis did not differ in character from any of its predecessors. Seven of its members were old office-holders of the ordinary "ministrable" type. The most conspicuous was M. Cavaignac, the son of the general who had opposed Louis Bonaparte in 1848, and the grandson of J. B. Cavaignac, the regicide member of the Convention. Like Carnot and Casimir-Périer, he was, therefore, one of those rare politicians of the Republic who possessed some hereditary tradition. An ambitious man, he was now classed as a Radical on the strength of his advocacy of the income-tax, the principle of which has never been popular in France, as being adverse to the secretive habits of thrift cultivated by the people, which are a great source of the national wealth. The radicalism of the rest of the ministry was not more alarming in character, and its tenure of office was without legislative result. Its fall, however, occasioned the only constitutionally interesting ministerial crisis of the twenty-four which had taken place since Grévy's election to the presidency sixteen years before. The Senate, disliking the fiscal policy of the government, refused to vote supply in spite of the support which the Chamber gave to the ministry. The collision between the two houses did not produce the revolutionary rising which the Radicals predicted, and the Senate actually forced the Bourgeois cabinet to resign amid profound popular indifference.

The new prime minister was M. Méline, who began his long political career as a member of the Commune in 1871, but was so little compromised in the insurrection that Jules Simon gave him an under-secretaryship in his ministry of 1876. After that he was once a cabinet minister, and was for a year president of the Chamber. He was chiefly known as a protectionist; but it was as leader of the Progressists, as the Opportunists now called themselves, that he formed his cabinet in April 1896, which was announced as a moderate ministry opposed to the policy of the Radicals. It is true that it made no attempt to tax incomes, but otherwise its achievements did not differ from those of other ministries, radical or concentration, except in its long survival. It lasted for over two years, and lived as long as the second Ferry cabinet. Its existence was prolonged by certain incidents of the Franco-Russian alliance. The visit of the Tsar to Paris

in October 1896, being the first official visit paid by a European sovereign to the Republic, helped the government over the critical period at which ministries usually succumbed, and it was further strengthened in parliament by the invitation to the president of the Republic to return the imperial visit at St Petersburg in 1897. The Chamber came to its normal term that autumn; but a law had been passed fixing May as the month for general elections, and the ministry was allowed to retain office till the dissolution at Easter 1898.

The long duration of the Méline government was said to be a further sign of the arrival of an era of party government with its essential accompaniment, ministerial stability. But in the country there was no corresponding sign that the electorate was being organized into two parties of Progressists and Radicals; while in the Chamber it was ominously observed that persistent opposition to the moderate ministry came from nominal supporters of its views, who were dismayed at one small band of fellow-politicians monopolizing office for two years. The last election of the century was therefore fought on a confused issue, the most tangible results being the further reduction of the Monarchists, who secured only 12% of the total poll, and the advance of the Socialists, who obtained nearly 20% of the votes recorded. The Radicals returned were less numerous than the Moderates, but with the aid of the Socialists they nearly balanced them. A new group entitled Nationalist made its appearance, supported by a miscellaneous electorate representing the malcontent element in the nation of all political shades from monarchist to revolutionary socialist. The Chamber, so composed, was as incoherent as either of its predecessors. It refused to elect the radical leader M. Brisson as its president, and then refused its confidence to the moderate leader M. Méline. M. Brisson, the rejected of the Chamber, was sent for to form a ministry, on the 28th of June 1898, which survived till the adjournment, only to be turned out when the autumn session began. M. Charles Dupuy thus became prime minister for the third time with a cabinet of the old concentration pattern, and for the third time in less than five years under his premiership the Presidency of the Republic became vacant. Félix Faure had increased in pomposity rather than in popularity. His contact with European sovereigns seems to have made him over-conscious of his superior rank, and he cultivated habits which austere republicans make believe to be the monopoly of frivolous courts. The regular domesticity of middle-class life may not be disturbed with impunity when age is advancing, and Félix Faure died with tragic unexpectedness on the 16th of February 1899. The joys of his high office were so dear to him that nothing but death would have induced him to lay it down before the term of his septennate. There was therefore no candidate in waiting for the vacancy; and as Paris was in an agitated mood the majority in the Congress elected M. Loubet president of the Republic, because he happened to hold the second place of dignity in the state, the presidency of the Senate, and was, moreover, a politician who had the confidence of the republican groups as an adversary of plebiscitary pretensions. His only competitor was M. Méline, whose ambitions were not realized, in spite of the alliance of his Progressist supporters with the Monarchists and Nationalists. The Dupuy ministry lasted till June 1899, when a new cabinet was formed by M. Waldeck-Rousseau, who, having held office under Gambetta and Jules Ferry, had relinquished politics for the bar, of which he had become a distinguished leader. Though a moderate republican, he was the first prime minister to give portfolios to socialist politicians. This was the distinguishing feature of the last cabinet of the century—the thirty-seventh which had taken office in the twenty-six years which had elapsed since the resignation of Thiers in 1873.

It is now necessary to go back a few years in order to refer to a matter which, though not political in its origin, in its development filled the whole political atmosphere of France in the closing period of the 19th century. Soon after the failure of the Boulangist movement a journal was founded at Paris called the

Franco-Russian alliance.

Félix Faure
president,
1895.

1899:
death of
President
Faure.

M. Loubet
president.

Libre Parole. Its editor, M. Drumont, was known as the author of *La France juive*, a violent anti-Semitic work, written to denounce the influence exercised by Jewish financiers in the politics of the Third Republic. It may be said to have started the anti-Semitic movement in France, where hostility to the Jews had not the pretext existing in those lands which contain a large Jewish population exercising local rivalry with the natives of the soil, or spoiling them with usury. That state of things existed in Algeria, where the indigenous Jews were made French citizens during the Franco-Prussian War to secure their support against the Arabs in rebellion. But political anti-Semitism was introduced into Algeria only as an offshoot of the movement in continental France, where the great majority of the Jewish community were of the same social class as the politicians of the Republic. Primarily directed against the Jewish financiers, the movement was originally looked upon as a branch of the anti-capitalist propaganda of the Socialists. Thus the *Libre Parole* joined with the revolutionary press in attacking the repressive legislation provoked by the dynamite outrages of the anarchists, clerical reactionaries who supported it being as scurrilously abused by the anti-Semitic organ as its republican authors. The Panama affair, in the exposure of which the *Libre Parole* took a prominent part soon after its foundation, was also a bond between anti-Semites and Socialists, to whom, however, the Monarchists, always incapable of acting alone, united their forces. The implication of certain Jewish financiers with republican politicians in the Panama scandal aided the anti-Semites in their special propaganda, of which a main thesis was that the government of the Third Republic had been organized by its venal politicians for the benefit of Jewish immigrants from Germany, who had thus enriched themselves at the expense of the laborious and unsuspecting French population. The *Libre Parole*, which had become a popular organ with reactionaries and with malcontents of all classes, enlisted the support of the Catholics by attributing the anti-religious policy of the Republic to the influence of the Jews, skilfully reviving bitter memories of the enactment of the Ferry decrees, when sometimes the laicization of schools or the expulsion of monks and nuns had been carried out by a Jewish functionary. Thus religious sentiment and race prejudice were introduced into a movement which was at first directed against capital; and the campaign was conducted with the weapons of scurrility and defamation which had made an unlicensed press under the Third Republic a demoralizing national evil.

An adroit feature of the anti-Semitic campaign was an appeal to national patriotism to rid the army of Jewish influence. The Jews, it was said, not content with directing the financial, and thereby the general policy of the Republic, had designs on the French army, in which they wished to act as secret agents of their German kindred. In October 1894 the *Libre Parole* announced that a Jewish officer of artillery attached to the general staff, Captain Alfred Dreyfus, had been arrested on the charge of supplying a government of the Triple Alliance with French military secrets. Tried by court-martial, he was sentenced to military degradation and to detention for life in a fortress. He was publicly degraded at Paris in January 1895, a few days before Casimir-Périer resigned the presidency of the Republic, and was transported to the Île du Diable on the coast of French Guiana. His conviction, on the charge of having betrayed to a foreign power documents relating to the national defence, was based on the alleged identity of his handwriting with that of an intercepted covering-letter, which contained a list of the papers treasonably communicated. The possibility of his innocence was not raised outside the circle of his friends; the Socialists, who subsequently defended him, even complained that common soldiers were shot for offences less than that for which this richly connected officer had been only transported. The secrecy of his trial did not shock public sentiment in France, where at that time all civilians charged with crime were interrogated by a judge in private, and where all accused persons are presumed guilty until proved innocent. In a land subject to invasion there was

less disposition to criticize the decision of a military tribunal acting in the defence of the nation even than there would have been in the case of a doubtful judgment passed in a civil court. The country was practically unanimous that Captain Dreyfus had got his deserts. A few, indeed, suggested that had he not been a Jew he would never have been accused; but the greater number replied that an ordinary French traitor of Gentile birth would have been forgotten from the moment of his condemnation. The pertinacity with which some of his co-religionists set to work to show that he had been irregularly condemned seemed to justify the latter proposition. But it was not a Jew who brought about the revival of the affair. Colonel Picquart, an officer of great promise, became head of the intelligence department at the war office, and in 1896 informed the minister of his suspicion that the letter on which Dreyfus had been condemned was written by a certain Major Esterhazy. The military authorities, not wishing to have the case reopened, sent Colonel Picquart on foreign service, and put in his place Colonel Henry. The all-seeing press published various versions of the incident, and the anti-Semitic journals denounced them as proofs of a Jewish conspiracy against the French army.

At the end of 1897 M. Scheurer-Kestner, an Alsatian devoted to France and a republican senator, tried to persuade his political friends to reopen the case; but M. Méline, the prime minister, declared in the name of the Republic that the Dreyfus affair no longer existed. The fact that the senator who championed Dreyfus was a Protestant encouraged the clerical press in its already marked tendency to utilize anti-Semitism as a weapon of ecclesiastical warfare. But the religious side-issues of the question would have had little importance had not the army been involved in the controversy, which had become so keen that all the population, outside that large section of it indifferent to all public questions, was divided into "Dreyfusards" and "anti-Dreyfusards." The strong position of the latter was due to their assuming the position of defenders of the army, which, at an epoch when neither the legislature nor the government inspired respect, and the Church was the object of polemic, was the only institution in France to unite the nation by appealing to its martial and patriotic instincts. That is the explanation of the enthusiasm of the public for generals and other officers by whom the trial of Dreyfus and subsequent proceedings had been conducted in a manner repugnant to those who do not favour the arbitrary ways of military dictatorship, which, however, are not unpopular in France. The acquittal of Major Esterhazy by a court-martial, the conviction of Zola by a civil tribunal for a violent criticism of the military authorities, and the imprisonment without trial of Colonel Picquart for his efforts to exonerate Dreyfus, were practically approved by the nation. This was shown by the result of the general elections in May 1898. The clerical reactionaries were almost swept out of the Chamber, but the overwhelming republican majority was practically united in its hostility, to the defenders of Dreyfus, whose only outspoken representatives were found in the socialist groups. The moderate Méline ministry was succeeded in June 1898 by the radical Brisson ministry. But while the new prime minister was said to be personally disposed to revise the sentence on Dreyfus, his civilian minister of war, M. Cavaignac, was as hostile to revision as any of his military predecessors—General Mercier, under whom the trial took place, General Zurlinden, and General Billot, a republican soldier devoted to the parliamentary régime.

The radical minister of war in July 1898 laid before the Chamber certain new proofs of the guilt of Dreyfus, in a speech so convincing that the house ordered it to be placarded in all the communes of France. The next month Colonel Henry, the chief of the intelligence department, confessed to having forged those new proofs, and then committed suicide. M. Cavaignac thereupon resigned office, but declared that the crime of Henry did not prove the innocence of Dreyfus. Many, however, who had hitherto accepted the judgment of 1894, reflected that the offence of a guilty man did not need new crime for its proof. It was further remarked that

Dreyfusards and anti-Dreyfusards.

Political results of Dreyfus agitation.

the forgery had been committed by the intimate colleague of the officers of the general staff, who had zealously protected Esterhazy, the suspected author of the document on which Dreyfus had been convicted. An uneasy misgiving became widespread; but partisan spirit was too excited for it to cause a general revulsion of feeling. Some journalists and politicians of the extreme Left had adopted the defence of Dreyfus as an anti-clerical movement in response to the intemperate partisanship of the Catholic press on the other side. Other members of the socialist groups, not content with criticizing the conduct of the military authorities in the Dreyfus affair, opened a general attack on the French army,—an unpopular policy which allowed the anti-Dreyfusards to utilize the old revolutionary device of making the word "patriotism" a party cry. The defamation and rancour with which the press on both sides flooded the land obscured the point at issue. However, the Brisson ministry just before its fall remitted the Dreyfus judgment to the criminal division of the cour de cassation—the supreme court of revision in France. M. Dupuy formed a new cabinet in November 1898, and made M. de Freycinet minister of war, but that adroit office-holder, though a civilian and a Protestant, did not favour the anti-military and anti-clerical defenders of Dreyfus. The refusal of the Senate, the stronghold of the Republic, to re-elect M. Scheurer-Kestner as its vice-president, showed that the opportunist minister of war understood the feeling of parliament, which was soon displayed by an extraordinary proceeding. The divisional judges, to whom the case was remitted, showed signs that their decision would be in favour of a new trial of Dreyfus. The republican legislature, therefore, disregarding the principle of the separation of the powers, which is the basis of constitutional government, took the arbitrary step of interfering with the judicial authority. It actually passed a law withdrawing the partly-heard cause from the criminal chamber of the cour de cassation, and transferring it to the full court of three divisions, in the hope that a majority of judges would thus be found to decide against the revision of the sentence on Dreyfus.

This flagrant confusion of the legislative with the judicial power displayed once more the incompetence of the French rightly to use parliamentary institutions; but it left the nation indifferent. It was during the passage of the bill that the president of the Republic suddenly died. Félix Faure was said to be hostile to the defenders of Dreyfus and disposed to utilize the popular enthusiasm for the army as a means of making the presidential office independent of parliament. The Chambers, therefore, in spite of their anti-Dreyfusard bias, were determined not to relinquish any of their constitutional prerogative. The military and plebiscitary parties were now fomenting the public discontent by noisy demonstrations. The president of the Senate, M. Loubet, as has been mentioned, was known to have no sympathy with this agitation, so he was elected president of the Republic by a large majority at the congress held at Versailles on 18th February 1899. The new president, who was unknown to the public, though he had once been prime minister for nine months, was respected in political circles; but his elevation to the first office of the State made him the object of that defamation which had become the chief characteristic of the partisan press under the Third Republic. He was recklessly accused of having been an accomplice of the Panama frauds, by screening certain guilty politicians when he was prime minister in 1892, and because he was not opposed to the revision of the Dreyfus sentence he was wantonly charged with being bought with Jewish money. Meanwhile the united divisions of the cour de cassation were, in spite of the intimidation of the legislature, reviewing the case with an independence worthy of praise in an ill-paid magistracy which owed its promotion to political influence. Instead of justifying the suggestive interference of parliament it revised the judgment of the court-martial, and ordered Dreyfus to be re-tried by a military tribunal at Rennes. The Dupuy ministry, which had wished to prevent this decision, resigned, and M. Waldeck-Rousseau formed a heterogeneous cabinet in which Socialists, who for the first time took office, had for their colleague as minister of war General de Galliffet, whose chief

political fame had been won as the executioner of the Communards after the insurrection of 1871. Dreyfus was brought back from the Devil's Island, and in August 1899 was put upon his trial a second time. His old accusers, led by General Mercier, the minister of war of 1894, redoubled their efforts to prove his guilt, and were permitted by the officers composing the court a wide license according to English ideas of criminal jurisprudence. The published evidence did not, however, seem to connect Dreyfus with the charges brought against him. Nevertheless the court, by a majority of five to two, found him guilty, and with illogical inconsequence added that there were in his treason extenuating circumstances. He was sentenced to ten years' detention, and while it was being discussed whether the term he had already served would count as part of his penalty, the ministry completed the inconsequence of the situation by advising the president of the Republic to pardon the prisoner. The result of the second trial satisfied neither the partisans of the accused, who desired his rehabilitation, some of them reproaching him for accepting a pardon, nor his adversaries, whose vindictiveness was unquenched by the penalty he had already suffered. But the great mass of the French people, who are always ready to treat a public question with indifference, were glad to be rid of a controversy which had for years infected the national life.

The Dreyfus affair was severely judged by foreign critics as a miscarriage of justice resulting from race-prejudice. If that simple appreciation rightly describes its origin, it became in its development one of those scandals symptomatic of the unhealthy political condition of France, which on a smaller scale had often recurred under the Third Republic, and which were made the pretext by the malcontents of all parties for gratifying their animosities. That in its later stages it was not a question of race-persecution was seen in the curious phenomenon of journals owned or edited by Jews leading the outcry against the Jewish officer and his defenders. That it was not a mere episode of the rivalry between Republicans and Monarchists, or between the advocates of parliamentarism and of military autocracy, was evident from the fact that the most formidable opponents of Dreyfus, without whose hostility that of the clericals and reactionaries would have been ineffective, were republican politicians. That it was not a phase of the anti-capitalist movement was shown by the zealous adherence of the socialist leaders and journalists to the cause of Dreyfus; indeed, one remarkable result of the affair was its diversion of the socialist party and press for several years from their normal campaign against property. The Dreyfus affair was utilized by the reactionaries against the Republic, by the clericals against the non-Catholics, by the anti-clericals against the Church, by the military party against the parliamentarians, and by the revolutionary socialists against the army. It was also conspicuously utilized by rival republican politicians against one another, and the chaos of political groups was further confused by it.

An epilogue to the Dreyfus affair was the trial for treason before the Senate, at the end of 1899, of a number of persons, mostly obscure followers either of M. Déroulède the poet, who advocated a plebiscitary republic, or of the duc d'Orléans, the pretender of the constitutional monarchy. On the day of President Faure's funeral M. Déroulède had vainly tried to entice General Roget, a zealous adversary of Dreyfus, who was on duty with his troops, to march on the Elysée in order to evict the newly-elected president of the Republic. Other demonstrations against M. Loubet ensued, the most offensive being a concerted assault upon him on the racecourse at Auteuil in June 1899. The subsequent resistance to the police of a band of anti-Semites threatened with arrest, who barricaded themselves in a house in the rue Chabrol, in the centre of Paris, and, with the marked approval of the populace, sustained a siege for several weeks, indicated that the capital was in a condition not far removed from anarchy. M. Déroulède, indicted at the assizes of the Seine for his misdemeanour on the day of President Faure's funeral, had been triumphantly

Second trial of Dreyfus.

Real character of the Dreyfus agitation.

The State trial of 1899.

acquitted. It was evident that no jury would convict citizens prosecuted for political offences and the government therefore decided to make use of the article of the Law of 1875, which allowed the Senate to be constituted a high court for the trial of offences endangering the state. A respectable minority of the Senate, including M. Wallon, the venerable "Father of the Constitution" of 1875, vainly protested that the framers of the law intended to invest the upper legislative chamber with judicial power only for the trial of grave crimes of high treason, and not of petty political disorders which a well-organized government ought to be able to repress with the ordinary machinery of police and justice. The outvoted protest was justified by the proceedings before the High Court, which, undignified and disorderly, displayed both the fatuity of the so-called conspirators and the feebleness of the government which had to cope with them. The trial proved that the plebiscitary faction was destitute of its essential factor, a chief to put forward for the headship of the state, and that it was resolved, if it overturned the parliamentary system, not to accept under any conditions the duc d'Orléans, the only pretender before the public. It was shown that royalists and plebiscitary republicans alike had utilized as an organization of disorder the anti-Semitic propaganda which had won favour among the masses as a nationalist movement to protect the French from foreign competition. The evidence adduced before the high court revealed, moreover, the curious fact that certain Jewish royalists had given to the duc d'Orléans large sums of money to found anti-Semitic journals as the surest means of popularizing his cause.

The last year of the 19th century, though uneventful for France, was one of political unrest. This, however, did not take

French parties at the close of the 19th century.

the form of ministerial crises, as, for the fourth time since responsible cabinets were introduced in 1873, a whole year, from the 1st of January to the 31st of December, elapsed without a change of ministry. The prime minister, M. Waldeck-Rousseau, though his domestic policy exasperated a large section of the political world, including one half of the Progressive group which he had helped to found, displayed qualities of statesmanship always respected in France, but rarely exhibited under the Third Republic. He had proved himself to be what the French call *un homme de gouvernement*—that is to say, an authoritative administrator of unimpassioned temperament capable of governing with the arbitrary machinery of Napoleonic centralization. His alliance with the extreme Left and the admission into his cabinet of socialist deputies, showed that he understood which wing of the Chamber it was best to conciliate in order to keep the government in his hands for an abnormal term. The advent to office of Socialists disquieted the respectable and prosperous commercial classes, which in France take little part in politics, though they had small sympathy with the nationalists, who were the most violent opponents of the Waldeck-Rousseau ministry. The alarm caused by the handing over of important departments of the state to socialist politicians arose upon a danger which is not always understood beyond the borders of France. Socialism in France is a movement appealing to the revolutionary instincts of the French democracy, advocated in vague terms by the members of rival groups or sects. Thus the increasing number of socialist deputies in parliament had produced no legislative results, and their presence in the cabinet was not feared on that account. The fear which their office-holding inspired was due to the immense administrative patronage which the centralized system confides to each member of the government. French ministers are wont to bestow the places at their disposal on their political friends, so the prospect of administrative posts being filled all over the land by revolutionaries caused some uneasiness. Otherwise the presence of Socialists on the ministerial bench seemed to have no other effect than that of partially muzzling the socialist groups in the Chamber. The opposition to the government was heterogeneous. It included the few Monarchists left in the Chamber, the Nationalists, who resembled the Boulangists of twelve years before, and who had added anti-Semitism to the articles of the revisionist

creed, and a number of republicans, chiefly of the old Opportunist group, which had renewed itself under the name of Progressist at the time when M. Waldeck-Rousseau was its most important member in the Senate.

The ablest leaders of this Opposition were all malcontent Republicans; and this fact seemed to show that if ever any form of monarchy were restored in France, political office would probably remain in the hands of men who were former ministers of the Third Republic. Thus the most conspicuous opponents of the cabinet were three ex-prime ministers, MM. Méline, Charles Dupuy and Ribot. Less distinguished republican "ministrables" had their normal appetite for office whetted in 1900 by the international exhibition at Paris. It brought the ministers of the day into unusual prominence, and endowed them with large subsidies voted by parliament for official entertainments. The exhibition was planned on too ambitious a scale to be a financial success. It also called forth the just regrets of those who deplored the tendency of Parisians under the Third République to turn their once brilliant city into an international casino. Its most satisfactory feature was the proof it displayed of the industrial inventiveness and the artistic instinct of the French. The political importance of the exhibition lay in the fact that it determined the majority in the Chamber not to permit the foreigners attracted by it to the capital to witness a ministerial crisis. Few strangers of distinction, however, came to it, and not one sovereign of the great powers visited Paris; but the ministry remained in office, and M. Waldeck-Rousseau had uninterrupted opportunity of showing his governmental ability. The only change in his cabinet took place when General de Galliffet resigned the portfolio of war to General André. The army, as represented by its officers, had shown symptoms of hostility to the ministry in consequence of the pardon of Dreyfus. The new minister of war repressed such demonstrations with proceedings of the same arbitrary character as those which had called forth criticism in England when used in the Dreyfus affair. In both cases the high-handed policy was regarded either with approval or with indifference by the great majority of the French nation, which ever since the Revolution has shown that its instincts are in favour of authoritative government. The emphatic support given by the radical groups to the autocratic policy of M. Waldeck-Rousseau and his ministers was not surprising to those who have studied the history of the French democracy. It has always had a taste for despotism since it first became a political power in the days of the Jacobins, to whose early protection General Bonaparte owed his career. On the other hand liberalism has always been repugnant to the masses, and the only period in which the Liberals governed the country was under the régime of limited suffrage—during the Restoration and the Monarchy of July.

The most important event in France during the last year of the century, not from its political result, but from the lessons it taught, was perhaps the Paris municipal election. The quadrennial renewal of all the municipal councils of France took place in May 1900. The municipality of the capital had been for many years in the hands of the extreme Radicals and the revolutionary Socialists. The Parisian electors now sent to the Hôtel de Ville a council in which the majority were Nationalists, in general sympathy with the anti-Semitic and plebiscitary movements. The nationalist councillors did not, however, form one solid party, but were divided into five or six groups, representing every shade of political discontent, from monarchism to revisionist-socialism. While the electorate of Paris thus pronounced for the revision of the Constitution, the provincial elections, as far as they had a political bearing, were favourable to the ministry and to the Republic. M. Waldeck-Rousseau accepted the challenge of the capital, and dealt with its representatives with the arbitrary weapons of centralization which the Republic had inherited from the Napoleonic settlement of the Revolution. Municipal autonomy is unknown in France, and the town council of Paris has to submit to special restrictions on its liberty of action. The prefect of the Seine is always present at its meetings as agent of the government and the minister of

the interior can veto any of its resolutions. The Socialists, when their party ruled the municipality, clamoured in parliament for the removal of this administrative control. But now being in a minority they supported the government in its anti-autonomic rigours. The majority of the municipal council authorized its president to invite to a banquet, in honour of the international exhibition, the provincial mayors and a number of foreign municipal magnates, including the lord mayor of London. The ministers were not invited, and the prefect of the Seine thereupon informed the president of the municipality that he had no right, without consulting the agent of the government, to offer a banquet to the provincial mayors; and they, with the deference which French officials instinctively show to the central authority, almost all refused the invitation to the Hôtel de Ville. The municipal banquet was therefore abandoned, but the government gave one in the Tuileries gardens, at which no fewer than 22,000 mayors paid their respects to the chief of the state. These events showed that, as in the Terror, as at the *coup d'état* of 1851, and as in the insurrection of the Commune, the French provinces were never disposed to follow the political lead of the capital, whether the opinions prevailing there were Jacobin or reactionary. These incidents displayed the tendency of the French democracy, in Paris and in the country alike, to submit to and even to encourage the arbitrary working of administrative centralization. The elected mayors of the provincial communes, urban and rural, quitted themselves like well-drilled functionaries of the state, respectful of their hierarchical superiors, just as in the days when they were the nominees of the government; while the population of Paris, in spite of its perennial proneness to revolution, accepted the rebuff inflicted on its chosen representatives without any hostile demonstration. The municipal elections in Paris afforded fresh proof of the unchanging political ineptitude of the reactionaries. The dissatisfaction of the great capital with the government of the Republic might, in spite of the reluctance of the provinces to follow the lead of Paris, have had grave results if skilfully organized. But the anti-republican groups, instead of putting forward men of high ability or reputation to take possession of the Hôtel de Ville, chose their candidates among the same inferior class of professional politicians as the Radicals and the Socialists whom they replaced on the municipal council.

The beginning of a century of the common era is a purely artificial division of time. Yet it has often marked a turning-point in the history of nations. This was notably the case in France in 1800. The violent and anarchical phases of the Revolution of 1789 came to an end with the 18th century; and the dawn of the 19th was coincident with the administrative reconstruction of France by Napoleon, on lines which endured with little modification till the end of that century, surviving seven revolutions of the executive power. The opening years of the 20th century saw no similar changes in the government of the country. The Third Republic, which was about to attain an age double that reached by any other régime since the Revolution, continued to live on the basis of the Constitution enacted in 1875, before it was five years old. Yet it seems not unlikely that historians of the future may take the date 1900 as a landmark between two distinct periods in the evolution of the French nation.

With the close of the 19th century the Dreyfus affair came practically to an end. Whatever the political and moral causes of the agitation which attended it, its practical result was to strengthen the Radical and Socialist parties in the Republic, and to reduce to unprecedented impotence the forces of reaction. This was due more to the maladroitness of the Reactionaries than to the virtues or the prescience of the extreme Left, as the imprisonment of the Jewish captain, which agitated and divided the nation, could not have been inflicted without the ardent approval of Republicans of all shades of opinion. But when the majority at last realized that a mistake had been committed, the Reactionaries, in great

measure through their own unwise policy, got the chief credit for it. Consequently, as the clericals formed the militant section of the anti-Republican parties, and as the Radical-Socialists were at that time keener in their hostility to the Church than in their zeal for social or economic reform, the issue of the Dreyfus affair brought about an anti-clerical movement, which, though initiated and organized by a small minority, met with nothing to resist it in the country, the reactionary forces being effete and the vast majority of the population indifferent. The main and absorbing feature therefore of political life in France in the first years of the 20th century was a campaign against the Roman Catholic Church, unparalleled in energy since the Revolution. Its most striking result was the rupture of the Concordat between France and the Vatican. This act was additionally important as being the first considerable breach made in the administrative structure reared by Napoleon, which had hitherto survived all the vicissitudes of the 19th century. Concurrently with this the influence of the Socialist party in French policy largely increased. A primary principle professed by the Socialists throughout Europe is pacificism, and its dissemination in France acted in two very different ways. It encouraged in the French people a growth of anti-military spirit, which showed some sign of infecting the national army, and it impelled the government of the Republic to be zealous in cultivating friendly relations with other powers. The result of the latter phase of pacificism was that France, under the Radical-Socialist administrations of the early years of the 20th century, enjoyed a measure of international prestige of that superficial kind which is expressed by the state visits of crowned heads to the chief of the executive power, greater than at any period since the Second Empire.

The voting of the law which separated the Church from the state will probably mark a capital date in French history; so, as the ecclesiastical policy of successive ministries filled almost entirely the interior chronicles of France for the first five years of the new century, it will be convenient to set forth in order the events which during that period led up to the passing of the Separation Act.

The French legislature during the first session of the 20th century was chiefly occupied with the passing of the Associations Law. That measure, though it entirely changed the legal position of all associations in France, was primarily directed against the religious associations of the Roman Catholic Church. Their influence in the land, according to the anti-clericals, had been proved by the Dreyfus affair to be excessive. The Jesuits were alleged, on their own showing, to exercise considerable power over the officers of the army, and in this way to have been largely responsible for the blunders of the Dreyfus case. Another less celebrated order, which took an active part against Dreyfus, the Assumptionists, had achieved notoriety by its journalistic enterprise, its cheap newspapers of wide circulation being remarkable for the violence of their attacks on the institutions and men of the Republic. The mutual antagonism between the French government and religious congregations is a tradition which dates from the ancient monarchy and was continued by Napoleon I. long before the Third Republic adopted it in the legislation associated with the names of Jules Ferry and Paul Bert. The prime minister, under whose administration the 20th century succeeded the 19th, was M. Waldeck-Rousseau, who had been the colleague of Paul Bert in Gambetta's *grand ministère*, and in 1883 had served under Jules Ferry in his second ministry. He had retired from political life, though he remained a member of the Senate, and was making a large fortune at the bar, when in June 1899, at pecuniary sacrifice, he consented to form a ministry for the purpose of "liquidating" the Dreyfus affair. In 1900, the year after the second condemnation of Dreyfus and his immediate pardon by the government, M. Waldeck-Rousseau in a speech at Toulouse announced that legislation was about to be undertaken on the subject of associations.

At that period the hostility of the Revolution to the principle of associations of all kinds, civil as well as religious, was still enforced by the law. With the exception of certain commercial

Paris
and the
provinces.

France
at the
opening
of the
20th cen-
tury.

Results
of the
Dreyfus
affair.

Church
policy.

societies subject to special legislation, no association composed of more than twenty persons could be formed without governmental authorization which was always revocable, the restriction applying equally to political and social clubs and to religious communities. The law was the same for all, but was differently applied. Authorization was rarely refused to political or social societies, though any club was liable to have its authorization withdrawn and to be shut up or dissolved. But to religious orders new authorization was practically never granted. Only four of them, the orders of Saint Lazare, of the Saint Esprit, of the Missions Étrangères and of Saint Sulpice, were authorized under the Third Republic—their authorization dating from the First Empire and the Restoration. The Frères de la Doctrine Chrétienne were also recognized, not, however, as a religious congregation under the jurisdiction of the minister of public worship, but as a teaching body under that of the minister of education. All the great historical orders, preaching, teaching or contemplative, were “unauthorized”; they led a precarious life on sufferance, having as corporations no civil existence, and being subject to dissolution at a moment’s notice by the administrative authority. In spite of this disability and of the decrees of 1880 directed against unauthorized monastic orders they had so increased under the anti-clerical Republic, that the religious of both sexes were more numerous in France at the beginning of the 20th century than at the end of the ancient monarchy. Moreover, in the twenty years during which unauthorized Orders had been supposed to be suppressed under the Ferry Decrees, their numbers had become six times more numerous than before, while it was the authorized Congregations which had diminished. The bare catalogue of the religious houses in the land, with the value of their properties (estimated by M. Waldeck-Rousseau at a milliard—£40,000,000) filled two White Books of two thousand pages, presented to parliament on the 4th of December 1900. The hostility to the Congregations was not confined to the anti-clericals. The secular clergy were suffering materially from the enterprising competition of their old rivals the regulars. Had the legislation for defining the legal situation of the religious orders been undertaken with the sole intention of limiting their excessive growth, such a measure would have been welcome to the parochial clergy. But they saw that the attack upon the congregations was only preliminary to a general attack upon the Church, in spite of the sincere assurances of the prime minister, a statesman of conservative temperament, that no harm would accrue to the secular clergy from the passing of the Associations Law.

In January 1901, on the eve of the first debate in the Chamber of Deputies on the Associations bill, a discussion took place which showed that the rupture of the Concordat might be nearing the range of practical politics, though parliament was as yet unwilling to take it into consideration. The archbishop of Paris, Cardinal Richard, had published a letter addressed to him by Leo XIII. deploring the projected legislation as being a breach of the Concordat under which the free exercise of the Catholic religion in France was assured. The Socialists argued that this letter was an intolerable intervention on the part of the Vatican in the domestic politics of the Republic, and proposed that parliament should after voting the Associations Law proceed to separate Church and State. M. Waldeck-Rousseau, the prime minister, calm and moderate, declined to take this view of the pope’s letter, and the resolution was defeated by a majority of more than two to one. But another motion, proposed by a Nationalist, that the Chamber should declare its resolve to maintain the Concordat, was rejected by a small majority. The discussion of the Associations bill was then commenced by the Chamber and went on until the Easter recess. Its main features when finally voted were that the right to associate for purposes not illicit should be henceforth free of all restrictions, though “juridical capacity” would be accorded only to such associations as were formally notified to the administrative authority. The law did not, however, accord liberty of association to religious “Congregations,” none of which could be formed without a special statute, and

any constituted without such authorization would be deemed illicit. The policy of the measure, as applying to religious orders, was attacked by the extreme Right and the extreme Left from their several standpoints. The clericals proposed that under the new law all associations, religious as well as civil, should be free. The Socialists proposed that all religious communities, authorized or unauthorized, should be suppressed. The prime minister took a middle course. But he went farther than the moderate Republicans, with whom he was generally classed. While he protected the authorized religious orders against the attacks of the extreme anti-clericals, he accepted from the latter a new clause which disqualified any member of an unauthorized order from teaching in any school. This was a blow at the principle of liberty of instruction, which had always been supported by Liberals of the old school, who had no sympathy with the pretensions of clericalism. Consequently this provision, though voted by a large majority, was opposed by the Liberals of the Republican party, notably by M. Ribot, who had been twice prime minister, and M. Aynard, almost the sole survivor of the Left Centre. It was remarked that in these, as in all subsequent debates on ecclesiastical questions, the ablest defenders of the Church were not found among the clericals, but among the Liberals, whose primary doctrine was that of tolerance, which they believed ought to be applied to the exercise of the religion nominally professed by a large majority of the nation. Few of the ardent professors of that religion gave effective aid to the Church during that period of crisis. M. de Mun still used his eloquence in its defence, but the brilliant Catholic orator had entered his sixtieth year with health impaired, and among the young reactionary members there was not one who displayed any talent. At the other end of the Chamber M. Viviani, a Socialist member for Paris, made an eloquent speech. As was anticipated the bill received no serious opposition in the Senate. Though not in sympathy with the attacks of the Socialists in the Chamber on property, the Upper House had as a whole no objection to their attacks on the Church, and had become a more persistently anti-clerical body than the Chamber of Deputies. The bill was therefore passed without any serious amendments, even those which were moved for the purpose of affirming the principle of liberty of education being supported by very few Republican senators. In the debates some of the utterances of the prime minister were important. On the proposal of M. Rambaud, a professor who was minister of education in the Méline cabinet of 1896, that religious associations should be authorized by decree and not by law, M. Waldeck-Rousseau said that inasmuch as vows of poverty and celibacy were illegal, nothing but a law would suffice to give legality to any association in which such vows were imposed on the members. It was thus laid down by the responsible author of the law that the third clause, providing that any association founded for an illicit cause was null, applied to religious communities. On the other hand the prime minister in another speech repudiated the suggestion that the proposed law was aimed against any form of religion. He argued that the religious orders, far from being essential to the existence of the Church, were a hindrance to the work of the parochial clergy, and that inasmuch as the religious orders were organizations independent of the State they were by their nature and influence a danger to the State. Consequently their regulation had become necessary in the interests both of Church and State. The general suppression of religious congregations, the prime minister said, was not contemplated; the case of each one would be decided on its merits, and he had no doubt that parliament would favourably consider the authorization of those whose aim was to alleviate misery at home or to extend French influence abroad. The tenor of M. Waldeck-Rousseau’s speech was eminently Concordatory. One of his chief arguments against the religious orders was that they were not mentioned in the Concordat, and that their unregulated existence prejudiced the interests of the Concordatory clergy. The speech was therefore an official declaration in favour of the maintenance of the relations between Church and State. That being so, it is important to notice that

by a majority of nearly two to one the Senate voted the placarding of the prime minister's speech in all the communes of France, and that the mover of the resolution was M. Combes, senator of the Charente-Inférieure, a politician of advanced views who up to that date had held office only once, when he was minister of education and public worship for about six months, in the Bourgeois administration in 1895-1896.

The "Law relating to the contract of Association" was promulgated on the 2nd of July 1901, and its enactment was the *Socialism*. only political event of high importance that year.

The Socialists, except in their anti-clerical capacity, were more active outside parliament than within. Early in the year some formidable strikes took place. At Montceau-les-Mines in Burgundy, where labour demonstrations had often been violent, a new feature of a strike was the formation of a trade-union by the non-strikers, who called their organization "the yellow trade-union" (*le syndicat jaune*) in opposition to the red trade-union of the strikers, who adopted the revolutionary flag and were supported by the Socialist press. At the same time the dock-labourers at Marseilles went out on strike, by the orders of an international trade-union in that port, as a protest against the dismissal of a certain number of foreigners. The number of strikes in France had increased considerably under the Waldeck-Rousseau government. Its opponents attributed this to the presence in the cabinet of M. Millerand, who had been ranked as a Socialist. On the other hand, the revolutionary Socialists excommunicated the minister of commerce for having joined a "bourgeois government" and retired from the general congress of the Socialist party at Lyons, where MM. Briand and Viviani, themselves future ministers, persuaded the majority not to go so far. The federal committee of miners projected a general strike in all the French coal-fields, and to that end organized a referendum. But of 125,000 miners inscribed on their lists nearly 70,000 abstained from voting, and although the general strike was voted in October by a majority of 34,000, it was not put into effect. Another movement favoured by the Socialists was that of anti-militarism. M. Hervé, a professor at the lycée of Sens, had written, in a local journal, the *Pioupiau de l'Yonne*, on the occasion of the departure of the conscripts for their regiments, some articles outraging the French flag. He was prosecuted and acquitted at the assizes at Auxerre in November, a number of his colleagues in the teaching profession coming forward to testify that they shared his views. The local educational authority, the academic council of Dijon, however, dismissed M. Hervé from his official functions, and its sentence was confirmed by the superior council of public education to which he had appealed. Thereupon the Socialists in the Chamber, under the lead of M. Viviani, violently attacked the Government shortly before the prorogation at the end of the year. M. Leygues, the minister of education, defended the policy of his department with equal vigour, declaring that if a professor in the "university" claimed the right of publishing unpatriotic and anti-military opinions he could exercise it only on the condition of giving up his employment under government—a thesis which was supported by the entire Chamber with the exception of the Socialists. This manifestation of anti-military spirit, though not widespread, was the more striking as it followed close upon a second visit of the emperor and empress of Russia to France, which took place in September 1901 and was of a military rather than of a popular character. The Russian sovereigns did not come to Paris. After a naval display at Dunkirk, where they landed, they were the guests of President Loubet at Compiègne, and concluded their visit by attending a review near Reims of the troops which had taken part in the Eastern manœuvres. Compared with the welcome given by the French population to the emperor and empress in 1896 their reception on this occasion was not enthusiastic. By not visiting Paris they seemed to wish to avoid contact with the people, who were persuaded by a section of the press that the motive of the imperial journey to France was financial. The Socialists openly repudiated the Russian alliance, and one of them, the mayor of Lille, who refused to decorate his municipal buildings when the

sovereigns visited the department of the Nord, was neither revoked nor suspended, although he publicly based his refusal on grounds insulting to the tsar.

It may be mentioned that the census returns of 1901 showed that the total increase of the population of France since the previous census in 1896 amounted only to 412,364, of which 289,662 was accounted for by the capital, while on the other hand the population of sixty out of eighty-seven departments had diminished.

As the quadrennial election of the Chamber of Deputies was due to take place in the spring of 1902, the first months of that year were chiefly occupied by politicians in preparing for it, though none of them gave any sign of being aware that the legislation to be effected by the new Chamber would be the most important which any parliament had undertaken under the constitution of 1875. At the end of the recess the prime minister in a speech at Saint Etienne, the capital of the Loire, of which department he was senator, passed in review the work of his ministry. With regard to the future, on the eve of the election which was to return the Chamber destined to disestablish the Church, he assured the secular clergy that they must not consider the legislation of the last session as menacing them: far from that, the recent law, directed primarily against those monastic orders which were anti-Republican associations, owning political journals and organizing electioneering funds (whose members he described as "moines ligueurs et moines d'affaires"), would be a guarantee of the Republic's protection of the parochial clergy. The presence of his colleague, M. Millerand, on this occasion showed that M. Waldeck-Rousseau did not intend to separate himself from the Radical-Socialist group which had supported his government; and the next day the Socialist minister of commerce, at Firminy, a mining centre in the same department, made a speech deprecating the pursuit of unpractical social ideals, which might have been a version of Gambetta's famous discourse on opportunism edited by an economist of the school of Léon Say. The Waldeck-Rousseau programme for the elections seemed therefore to be an implied promise of a moderate opportunist policy which would strengthen and unite the Republic by conciliating all sections of its supporters. When parliament met, M. Delcassé, minister for foreign affairs, on a proposal to suppress the Embassy to the Vatican, declared that even if the Concordat were ever revoked it would still be necessary for France to maintain diplomatic relations with the Holy See. On the other hand, the ministry voted, against the moderate Republicans, for an abstract resolution, proposed by M. Brisson, in favour of the abrogation of the Loi Falloux of 1850, which law, by abolishing the monopoly of the "university," had established the principle of liberty of education. Another abstract resolution, supported by the government, which subsequently became law, was voted in favour of the reduction of the terms of compulsory military service from three years to two.

The general elections took place on the 27th of April 1902, with the second ballots on the 11th of May, and were favourable to the ministry, 321 of its avowed supporters being *Resignation of Waldeck-Rousseau*. returned and 268 members of the Opposition, including 140 "Progressist" Republicans, many of whom were deputies whose opinions differed little from those of M. Waldeck-Rousseau. In Paris the government lost a few seats which were won by the Nationalist group of reactionaries. The chief surprise of the elections was the announcement made by M. Waldeck-Rousseau on the 20th of May, while the president of the Republic was in Russia on a visit to the tsar, of his intention to resign office. No one but the prime minister's intimates knew that his shattered health was the true cause of his resignation, which was attributed to the unwillingness of an essentially moderate man to be the leader of an advanced party and the instrument of an immoderate policy. His retirement from public life at this crisis was the most important event of its kind since the death of his old master Gambetta. He had learned opportunist statesmanship in the short-lived *grand ministère* and in the long-lived Ferry administration of 1883-

1885, after which he had become an inactive politician in the Senate, while making a large fortune at the bar. In spite of having eschewed politics he had been ranked in the public mind with Gambetta and Jules Ferry as one of the small number of politicians of the Republic who had risen high above mediocrity. While he had none of the magnetic exuberance which furthered the popularity of Gambetta, his cold inexpansiveness had not made him unpopular as was his other chief, Jules Ferry. Indeed, his unemotional coldness was one of the elements of the power with which he dominated parliament; and being regarded by the nation as the strong man whom France is always looking for, he was the first prime minister of the Republic whose name was made a rallying cry at a general election. Yet the country gave him a majority only for it to be handed over to other politicians to use in a manner which he had not contemplated. On the 3rd of June 1902 he formally resigned office, his ministry having lasted for three years, all but a few days, a longer duration than that of any other under the Third Republic.

M. Loubet called upon M. Léon Bourgeois, who had already been prime minister under M. Félix Faure, to form a ministry, but he had been nominated president of the new Chamber. The president of the Republic then offered the post to M. Brisson, who had been twice prime minister in 1885 and 1898, but he also refused. A

third member of the Radical party was then sent for, M. Emile Combes, and he accepted. The senator of the Charente Inférieure, in his one short term of office in the Bourgeois ministry, had made no mark. But he had attained a minor prominence in the debates of the Senate by his ardent anti-clericalism. He had been educated as a seminarist and had taken minor orders, without proceeding to the priesthood, and had subsequently practised as a country doctor before entering parliament. M. Combes retained two of the most important members of the Waldeck-Rousseau cabinet, M. Delcassé, who had been at the foreign office for four years, and General André, who had become war minister in 1900 on the resignation of General de Gallifet. General André was an ardent Dreyfusard, strongly opposed to clerical and reactionary influences in the army. Among the new ministers was M. Rouvier, a colleague of Gambetta in the *grand ministère* and prime minister in 1887, whose participation in the Panama affair had caused his retirement from official life. Being a moderate opportunist and reputed the ablest financier among French politicians, his return to the ministry of finance reassured those who feared the fiscal experiments of an administration supported by the Socialists. The nomination as minister of marine of M. Camille Pelletan (the son of Eugène Pelletan, a notable adversary of the Second Empire), who had been a Radical-Socialist deputy since 1881, though new to office, was less reassuring. M. Combes reserved for himself the departments of the interior and public worship, meaning that the centralized administration of France should be in his own hands while he was keeping watch over the Church. But in spite of the prime minister's extreme anti-clericalism there was no hint made in his ministerial declaration, on the 10th of June 1902, on taking office that there would be any question of the new Chamber dealing with the Concordat or with the relations of Church and state. M. Combes, however, warned the secular clergy not to make common cause with the religious orders, against which he soon began vigorous action. Before the end of June he directed the *Préfets* of the departments to bring political pressure to bear on all branches of the public service, and he obtained a presidential decree closing a hundred and twenty-five schools, which had been recently opened in buildings belonging to private individuals, on the ground that they were conducted by members of religious associations and that this brought the schools under the law of 1901. Such action seemed to be opposed to M. Waldeck-Rousseau's interpretation of the law; but the Chamber having supported M. Combes he ordered in July the closing of 2,500 schools, conducted by members of religious orders, for which authorization had not been requested. This again seemed contrary to the assurances of M. Waldeck-Rousseau, and it called forth vain protests in the name of liberty from Radicals of the

old school, such as M. Goblet, prime minister in 1886, and from Liberal Protestants, such as M. Gabriel Monod. The execution of the decrees closing the schools of the religious orders caused some violent agitation in the provinces during the parliamentary recess. But the majority of the departmental councils, at their meetings in August, passed resolutions in favour of the governmental policy, and a movement led by certain Nationalists, including M. Drumont, editor of the anti-semitic *Libre Parole*, and M. François Coppée, the Academician, to found a league having similar aims to those of the "passive resisters" in our country, was a complete failure. On the reassembling of parliament, both houses passed votes of confidence in the ministry and also an act supplementary to the Associations Law penalizing the opening of schools by members of religious orders.

In spite of the ardour of parliamentary discussions the French public was less moved in 1902 by the anti-clerical action of the government than by a vulgar case of swindling known as the "Humbert affair." The wife of a former deputy for Seine-et-Marne, who was the son of M. Gustave Humbert, minister of justice in 1882, had for many years maintained a luxurious establishment, which included a political salon, on the strength of her assertion that she and her family had inherited several millions sterling from one Crawford, an Englishman. Her story being believed by certain bankers she had been enabled to borrow colossal sums on the legend, and had almost married her daughter as a great heiress to a Moderate Republican deputy who held a conspicuous position in the Chamber. The flight of the Humberts, the exposure of the fraud and their arrest in Spain excited the French nation more deeply than the relative qualities of M. Waldeck-Rousseau and M. Combes or the woes of the religious orders. A by-election to the Senate in the spring of 1902 merits notice as it brought back to parliament M. Clémenceau, who had lived in comparative retirement since 1893 when he lost his seat as deputy for Draguignan, owing to a series of unusually bitter attacks made against him by his political enemies. He had devoted his years of retirement to journalism, taking a leading part in the Dreyfus affair on the side of the accused. His election as senator for the Var, where he had formerly been deputy, was an event of importance unanticipated at the time.

The year 1903 saw in progress a momentous development of the anti-clerical movement in France, though little trace of this is found in the statute-book. The chief act of parliament of that year was one which interested the population much more than any law affecting the Church. This was an act regulating the privileges of the *bouilleurs de cru*, the peasant proprietors who, permitted to distil from their produce an annual quantity of alcohol supposed to be sufficient for their domestic needs, in practice fabricated and sold so large an amount as to prejudice gravely the inland revenue. As there were a million of these illicit distillers in the land they formed a powerful element in the electorate. The crowded and excited debates affecting their interests, in which Radicals and Royalists of the rural districts made common cause against Socialists and Clericals of the towns, were in striking contrast with the less animated discussions concerning the Church. The prime minister, an anti-clerical zealot, bitterly hostile to the Church of which he had been a minister, took advantage of the relative indifference of parliament and of the nation in matters ecclesiastical. The success of M. Combes in his campaign against the Church was an example of what energy and pertinacity can do. There was no great wave of popular feeling on the question, no mandate given to the deputies at the general election or asked for by them. Neither was M. Combes a popular leader or a man of genius. He was rather a trained politician, with a fixed idea, who knew how to utilize to his ends the ability and organization of the extreme anti-clerical element in the Chamber, and the weakness of the extreme clerical party. The majority of the Chamber did not share the prime minister's animosity towards the Church, for which at the same time it had not the least enthusiasm, and under the concordatory lead of M. Waldeck-Rousseau it would have been content to

Humbert affair.

*M. Combes
prime
minister.*

*Anti-clerical
movement.*

curb clerical pretensions without having recourse to extreme measures of repression. It was, however, equally content to follow the less tolerant guidance of M. Combes. Thus, early in the session of 1903 it approved of his circular forbidding the priests of Brittany to make use of the Breton language in their religious instruction under pain of losing their salaries. It likewise followed him on the 26th of January when he declined to accept, as being premature and unpractical, a Socialist resolution in favour of suppressing the budget of public worship, though the majority was indeed differently composed on those two occasions. In the Senate on the 29th of January M. Waldeck-Rousseau indicated what his policy would have been had he retained office, by severely criticizing his successor's method of applying the Associations Law. Instead of asking parliament to judge on its merits each several demand for authorization made by a congregation, the government had divided the religious orders into two chief categories, teaching orders and preaching orders, and had recommended that all should be suppressed by a general refusal of authorization. The Grande Chartreuse was put into a category by itself as a trading association and was dissolved; but Lourdes, which with its crowds of pilgrims enriched the Pyrenean region and the railway companies serving it, was spared for electioneering reasons. A dispute arose between the government and the Vatican on the nomination of bishops to vacant sees. The Vatican insisted on the words "*nobis nominavit*" in the papal bulls instituting the bishops nominated by the chief of the executive in France under the Concordat. M. Combes objected to the pronoun, and maintained that the complete nomination belonged to the French government, the Holy See having no choice in the matter, but only the power of canonical institution. This produced a deadlock, with the consequence that no more bishops were ever again appointed under the Concordat, which both before and after the Easter recess M. Combes now threatened to repudiate. These menaces derived an increased importance from the failing health of the pope. Leo XIII. had attained the great age of ninety-three, and on the choice of his successor grave issues depended. He died on the 20th of July 1903. The conclave indicated as his successor his secretary of state, Cardinal Rampolla, an able exponent of the late pope's diplomatic methods and also a warm friend of France. It was said to be the latter quality which induced Austria to exercise its ancient power of veto on the choice of a conclave, and finally Cardinal Sarto, patriarch of Venice, a pious prelate inexperienced in diplomacy, was elected and took the title of Pius X. In September the inauguration of a statue of Renan at Tréguier, his birthplace, was made the occasion of an anti-clerical demonstration in Catholic and reactionary Brittany, at which the prime minister made a militant speech in the name of the freethinkers of France, though Renan was a Voltairian aristocrat who disliked the aims and methods of modern Radical-Socialists. In the course of his speech M. Combes pointed out that the anti-clerical policy of the government had not caused the Republic to lose prestige in the eyes of the monarchies of Europe, which were then showing it unprecedented attentions. This assertion was true, and had reference to the visit of the king of England to the president of the Republic in May and the projected visit of the king of Italy. That of Edward VII., which was the first state visit of a British sovereign to France for nearly fifty years, was returned by President Loubet in July, and was welcomed by all parties, excepting some of the reactionaries. M. Millevoyc, a Nationalist deputy for Paris, in the *Patrie* counselled the Parisians to remember Fashoda, the Transvaal War, and the attitude of the English in the Dreyfus affair, and to greet the British monarch with cries of "*Vivent les Boers.*" M. Déroulède, the most interesting member of the Nationalist party, wrote from his exile at Saint-Sébastien protesting against the folly of this proceeding, which merits to be put on record as an example of the incorrigible ineptitude of the reactionaries in France. The incident served only to prove their complete lack of influence on popular feeling, while it damaged the cause of the Church at a most critical moment by showing that the only persons in France willing to insult a

friendly monarch who was the guest of the nation, belonged to the clerical party. Of the royal visits that of the king of Italy was the more important in its immediate effects on the history of France, as will be seen in the narration of the events of 1904.

The session of 1904 began with the election of a new president of the Chamber, on the retirement of M. Bourgeois. The choice fell on M. Henri Brisson, an old Radical, but not a Socialist, who had held that post in 1881 and had subsequently filled it on ten occasions, the election to the office being annual. The narrow majority he obtained over M. Paul Bertrand, a little-known moderate Republican, by secret ballot, followed by the defeat of M. Jaurès, the Socialist leader, for one of the vice-presidential chairs, showed that one half of the Chamber was of moderate tendency. But, as events proved, the Moderates lacked energy and leadership, so the influence of the Radical prime minister prevailed. In a debate on the 22nd of January on the expulsion of an Alsatian priest of French birth from a French frontier department by the French police, M. Ribot, who set an example of activity to younger men of the moderate groups, reproached M. Combes with reducing all questions in which the French nation was interested to the single one of anti-clericalism, and the prime minister retorted that it was solely for that purpose that he took office. In pursuance of this policy a bill was introduced, and was passed by the Chamber before Easter, interdicting from teaching all members of religious orders, authorized or not authorized. Among other results this law, which the Senate passed in the summer, swept out of existence the schools of the Frères de la Doctrine Chrétienne (Christian Brothers) and closed in all 2400 schools before the end of the year.

This drastic act of anti-clerical policy, which was a total repudiation by parliament of the principle of liberty of education, should have warned the authorities of the Church of the relentless attitude of the government. The most superficial observation ought to have shown them that the indifference of the nation would permit the prime minister to go to any length, and common prudence should have prevented them from affording him any pretext for more damaging measures. The President of the Republic accepted an invitation to return the visit of the king of Italy. When it was submitted to the Chamber on March 25th, 1904, a reactionary deputy moved the rejection of the vote for the expenses of the journey on the ground that the chief of the French executive ought not to visit the representative of the dynasty which had plundered the papacy. The amendment was rejected by a majority of 502 votes to 12, which showed that at a time of bitter controversy on ecclesiastical questions French opinion was unanimous in approving the visit of the president of the Republic to Rome as the guest of the king of Italy. Nothing could be more gratifying to the entire French nation, both on racial and on traditional grounds, than such a testimony of a complete revival of friendship with Italy, of late years obscured by the Triple Alliance. Yet the Holy See saw fit to advance pretensions inevitably certain to serve the ends of the extreme anti-clericals, whose most intolerant acts at that moment, such as the removal of the crucifixes from the law-courts, were followed by new electoral successes. Thus the reactionary majority on the Paris municipal council was displaced by the Radical-Socialists on the 1st of May, the day that M. Loubet returned from his visit to Rome. On the 16th of May M. Jaurès' Socialist organ, *L'Humanité*, published the text of a protest, addressed by the pope to the powers having diplomatic relations with the Vatican, against the visit of the president of the Republic to the King of Italy. This document, dated the 28th of April, was offensive in tone both to France and to Italy. It intimated that while Catholic sovereigns refrained from visiting the person who, contrary to right, exercised civil sovereignty in Rome, that "duty" was even more "imperious" for the ruler of France by reason of the "privileges" enjoyed by that country from the Concordat; that the journey of M. Loubet to "pay homage" within the pontifical see to that person was an insult to the sovereign pontiff; and that only for reasons of special gravity was the nuncio permitted to remain

in Paris. The publication of this document caused some joy among the extreme clericals, but this was nothing to the exultation of the extreme anti-clericals, who saw that the prudent diplomacy of Leo XIII., which had risen superior to many a provocation of the French government, was succeeded by a papal policy which would facilitate their designs in a manner unhopd for. Moderate men were dismayed, seeing that the Concordat was now in instant danger; but the majority of the French nation remained entirely indifferent to its fate. Within a week France took the initiative by recalling the ambassador to the Vatican, M. Nisard, leaving a third-secretary in charge. In the debate in the Chamber upon the incident, the foreign minister, M. Delcassé, said that the ambassador was recalled, not because the Vatican had protested against the visit of the president to the king of Italy, but because it had communicated this protest, in terms offensive to France, to foreign powers. The Chamber on the 27th of May approved the recall of the ambassador by the large majority of 420 to 90. By a much smaller majority it rejected a Socialist motion that the Nuncio should be given his passports. The action of the Holy See was not actually an infringement of the Concordat; so the government, satisfied with the effect produced on public opinion, which was now quite prepared for a rupture with the Vatican, was willing to wait for a new pretext, which was not long in coming. Two bishops, Mgr. Geay of Laval and Mgr. Le Nordez of Dijon, were on bad terms with the clerical reactionaries in their dioceses. The friends of the prelates, including some of their episcopal brethren, thought that their chief offence was their loyalty to the Republic, and it was an unfortunate coincidence that these bishops, subjected to proceedings which had been unknown under the long pontificate of Leo XIII., should have been two who had incurred the animosity of anti-republicans. Their enemies accused Mgr. Geay of immorality and Mgr. Le Nordez of being in league with the freemasons. The bishop of Laval was summoned by the Holy Office, without any communication with the French government, to resign his see, and he submitted the citation forthwith to the minister of public worship. The French chargé d'affaires at the Vatican was instructed to protest against this grave infringement of an article of the Concordat, and, soon after, against another violation of the Concordat committed by the Nuncio, who had written to the bishop of Dijon ordering him to suspend his ordinations, the Nuncio being limited, like all other ambassadors, to communicating the instructions of his government through the intermediary of the minister for foreign affairs. The Vatican declined to give any satisfaction to the French government and summoned the two bishops to Rome under pain of suspension. So the French chargé d'affaires was directed to leave Rome, after having informed the Holy See that the government of the Republic considered that the mission of the apostolic Nuncio in Paris was terminated. Thus came to an end on the 30th of July 1904 the diplomatic relations which under the Concordat had subsisted between France and the Vatican for more than a hundred years.

Twelve days later M. Waldeck-Rousseau died, having lived just long enough to see this unanticipated result of his policy. It was said that his resolve to regulate the religious associations arose from his feeling that whatever injustice had been committed in the Dreyfus case had been aggravated by the action of certain unauthorized orders. However that may be, his own utterances showed that he believed that his policy was one of finality. But he had not reckoned that his legislation, which needed hands as calm and impartial as his own to apply it, would be used in a manner he had not contemplated by sectarian politicians who would be further aided by the self-destructive policy of the highest authorities of the Church. When parliament assembled for the autumn session a general feeling was expressed, by moderate politicians as well as by supporters of the Combes ministry, that disestablishment was inevitable. The prime minister said that he had been long in favour of it, though the previous year he had intimated to M. Nisard, ambassador to the Vatican, that he had not a majority in parliament to vote

it. But the papacy and the clergy had since done everything to change that situation. The Chamber did not move in the matter beyond appointing a committee to consider the general question, to which M. Combes submitted in his own name a bill for the separation of the churches from the State.

During the last three months of 1904 public opinion was diverted to the cognate question of the existence of masonic delation in the army. M. Guyot de Villeneuve, Nationalist deputy for Saint Denis, who had been dismissed from the army by General de Galliffet in connexion with the Dreyfus affair, brought before the Chamber a collection of documents which, it seemed, had been abstracted from the Grand Orient of France, the headquarters of French freemasonry, by an official of that order. These papers showed that an elaborate system of espionage and delation had been organized by the freemasons throughout France for the purpose of obtaining information as to the political opinions and religious practices of the officers of the army, and that this system was worked with the connivance of certain officials of the ministry of war. Its aim appeared to be to ascertain if officers went to mass or sent their children to convent schools or in any way were in sympathy with the Roman Catholic religion, the names of officers so secretly denounced being placed on a black-list at the War Office, whereby they were disqualified for promotion. There was no doubt about the authenticity of the documents or of the facts which they revealed. Radical ex-ministers joined with moderate Republicans and reactionaries in denouncing the system. Anti-clerical deputies declared that it was no use to cleanse the war office of the influence of the Jesuits, which was alleged to have prevailed there, if it were to be replaced by another occult power, more demoralizing because more widespread. Only the Socialists and a few of the Radical-Socialists in the Chamber supported the action of the freemasons. General André, minister of war, was so clearly implicated, with the evident approval of the prime minister, that a revulsion of feeling against the policy of the anti-clerical cabinet began to operate in the Chamber. Had the opposition been wisely guided there can be little doubt that a moderate ministry would have been called to office and the history of the Church in France might have been changed. But the reactionaries, with their accustomed folly, played into the hands of their adversaries. The minister of war had made a speech which produced a bad impression. As he stepped down from the tribune he was struck in the face by a Nationalist deputy for Paris, a much younger man than he. The cowardly assault did not save the minister, who was too deeply compromised in the delation scandal. But it saved the anti-clerical party, by rallying a number of waverers who, until this exhibition of reactionary policy, were prepared to go over to the Moderates, from the "bloc," as the ministerial majority was called. The Nationalist deputy was committed to the assizes on the technical charge of assaulting a functionary while performing his official duties. Towards the end of the year, on the eve of his trial, he met with a violent death, and the circumstances which led to it, when made public, showed that this champion of the Church was a man of low morality. General André had previously resigned and was succeeded as minister of war by M. Berteaux, a wealthy stock-broker and a Socialist.

The Combes cabinet could not survive the delation scandal, in spite of the resignation of the minister of war and the ineptitude of the opposition. On the 8th of January 1905, two days before parliament met, an election took place in Paris to fill the vacancy caused by the death of the Nationalist deputy who had assaulted General André. The circumstances of his death, at that time partially revealed, did not deter the electors from choosing by a large majority a representative of the same party, Admiral Bienaimé, who the previous year had been removed for political reasons from the post of maritime prefect at Toulon, by M. Camille Pelletan, minister of marine. A more serious check to the Combes ministry was given by the refusal of the Chamber to re-elect as president M. Brisson, who was defeated by a majority of twenty-

*Diplomatic
crisis with
Rome.*

*War
Office
diffi-
culties.*

*Fall
of the
Combes
ministry.*

five by M. Doumer, ex-Governor-General of Indo-China, who, though he had entered politics as a Radical, was now supported by the anti-republican reactionaries as well as by the moderate Republicans. A violent debate arose on the question of expelling from the Legion of Honour certain members of that order, including a general officer, who had been involved in the delation scandal. M. Jaurès, the eloquent Socialist deputy for Albi, who played the part of *Eminence grise* to M. Combes in his anti-clerical campaign, observed that the party which was now demanding the purification of the order had been in no hurry to expel from it Esterhazy long after his crimes had been proved in connexion with the Dreyfus case. The debate was inconclusive, and the government on the 14th of January obtained a vote of confidence by a majority of six. But M. Combes, whose animosity towards the church was keener than his love of office, saw that his ministry would be constantly liable to be put in a minority, and that thus the consideration of separation might be postponed until after the general elections of 1906. So he announced his resignation in an unprecedented manifesto addressed to the president of the Republic on the 18th January.

M. Rouvier, minister of finance in the outgoing government, was called upon for the second time in his career to form a ministry.

Second Rouvier ministry. A moderate opportunist himself, he intended to form a coalition cabinet in which all groups of Republicans, from the Centre to the extreme Left, would be represented. But he failed, and the ministry of the 24th

of January 1905 contained no members of the Republican opposition which had combated M. Combes. The prime minister retained the portfolio of finance; M. Delcassé remained at the foreign office, which he had directed since 1898, and M. Berteaux at the war office; M. Etienne, member for Oran, went to the ministry of the interior; another Algerian deputy, M. Thomson, succeeded M. Camille Pelletan at the ministry of marine, which department was said to have fallen into inefficiency; public worship was separated from the department of the interior and joined with that of education under M. Bienvenu-Martin, Radical-Socialist deputy for Auxerre, who was new to official life. Although M. Rouvier, as befitted a politician of the school of Waldeck-Rousseau, disliked the separation of the churches from the state, he accepted that policy as inevitable. After the action of the Vatican in 1904, which had produced the rupture of diplomatic relations with France, many moderates who had been persistent in their opposition to the Combes ministry, and even certain Nationalists, accepted the principle of separation, but urged that it should be effected on liberal terms. So on the 27th of January, after the minister of education and public worship had announced that the government intended to introduce a separation bill, a vote of confidence was obtained by a majority of 373 to 99, half of the majority being opponents of the Combes ministry of various Republican and reactionary groups, while the minority was composed of 84 Radicals and Socialists and only 15 reactionaries.

On the 21st of March the debates on the separation of the churches from the state began. A commission had been appointed in 1904 to examine the subject. Its reporter was M.

The Separation Law. Aristide Briand, Socialist member for Saint Etienne. According to French parliamentary procedure, the reporter of a commission, directed to draw up a great scheme of legislation, can make himself a more important person in conducting it through a house of legislature than the minister in charge of the bill. This is what M. Briand succeeded in doing. He produced with rapidity a "report" on the whole question, in which he traced with superficial haste the history of the Church in France from the baptism of Clovis, and upon this drafted a bill which was accepted by the government. He thus at one bound came from obscurity into the front rank of politicians, and in devising a revolutionary measure learned a lesson of moderate statesmanship. In conducting the debates he took the line of throwing the responsibility for the rupture of the Concordat on the pope. The leadership of the Opposition fell on M. Ribot, who had been twice prime minister of the Republic and was not a practising Catholic. He recognized that separation

had become inevitable, but argued that it could be accomplished as a permanent act only in concert with the Holy See. The clerical party in the Chamber did little in defence of the Church. The abbés Lemire and Gayraud, the only ecclesiastics in parliament, spoke with moderation, and M. Groussau, a Catholic jurist, attacked the measure with less temperate zeal; but the best serious defence of the interests of the Church came from the Republican centre. Few amendments from the extreme Left were accepted by M. Briand, whose general tone was moderate and not illiberal. One feature of the debates was the reluctance of the prime minister to take part in them, even when financial clauses were discussed in which his own office was particularly concerned. The bill finally passed the Chamber on the 3rd of July by 341 votes against 233, the majority containing a certain number of conservative Republicans and Nationalists. At the end the Radical-Socialists manifested considerable discontent at the liberal tendencies of M. Briand, and declared that the measure as it left the Chamber could be considered only provisional. In the Senate it underwent no amendment whatever, not a single word being altered. The prime minister, M. Rouvier, never once opened his lips during the lengthy debates, in the course of which M. Clémenceau, as a philosophical Radical who voted for the bill, criticized it as too concordatory, while M. Méline, as a moderate Republican, who voted against it, predicted that it would create such a state of things as would necessitate new negotiations with Rome a few years later. It was finally passed by a majority of 181 to 102, the complete number of senators being 300, and three days later, on the 9th of December 1905, it was promulgated as law by the president of the Republic.

The main features of the act were as follows. The first clauses guaranteed liberty of conscience and the free practice of public worship, and declared that henceforth the Republic neither recognized nor remunerated any form of religion, except in the case of chaplains to public schools, hospitals and prisons. It provided that after inventories had been taken of the real and personal property in the hands of religious bodies, hitherto remunerated by the state, to ascertain whether such property belonged to the state, the department, or the commune, all such property should be transferred to associations of public worship (*associations cultuelles*) established in each commune in accordance with the rules of the religion which they represented, for the purpose of carrying on the practices of that religion. As the Vatican subsequently refused to permit Catholics to take part in these associations, the important clauses relating to their organization and powers became a dead letter, except in the case of the Protestant and Jewish associations, which affected only a minute proportion of the religious establishments under the act. Nothing, therefore, need be said about them except that the chief discussions in the Chamber took place with regard to their constitution, which was so amended, contrary to the wishes of the extreme anti-clericals, that many moderate critics of the original bill thought that thereby the regular practice of the Catholic religion, under episcopal control, had been safeguarded. A system of pensions for ministers of religion hitherto paid by the state was provided, according to the age and the length of service of the ecclesiastics interested, while in small communes of under a thousand inhabitants the clergy were to receive in any case their full pay for eight years. The bishops' palaces were to be left gratuitously at the disposal of the occupiers for two years, and the presbyteries and seminaries for five years. This provision too became a dead letter, owing to the orders given by the Holy See to the clergy. Other provisions enacted that the churches should not be used for political meetings, while the services held in them were protected by the law from the acts of disturbers. As the plenary operation of the law depended on the *associations cultuelles*, the subsequent failure to create those bodies makes it useless to give a complete exposition of a statute of which they were an essential feature.

The passing of the Separation Law was the chief act of the last year of the presidency of M. Loubet. One other important measure has to be noted, the law reducing compulsory military

service to two years. The law of 1889 had provided a general service of three years, with an extensive system of dispensations accorded to persons for domestic reasons, or because they belonged to certain categories of students, such citizens being let off with one year's service with the colours or being entirely exempted. The new law exacted two years' service from every Frenchman, no one being exempted save for physical incapacity. Under the act of 1905 even the cadets of the military college of Saint Cyr and of the Polytechnic had to serve in the ranks before entering those schools. Anti-military doctrines continued to be encouraged by the Socialist party, M. Hervé, the professor who had been revoked in 1901 for his suggestion of a military strike in case of war and for other unpatriotic utterances, being elected a member of the administrative committee of the Unified Socialist party, of which M. Jaurès was one of the chiefs. At a congress of elementary schoolmasters at Lille in August, anti-military resolutions were passed and a general adherence was given to the doctrines of M. Hervé. At Longwy, in the Eastern coal-field, a strike took place in September, during which the military was called out to keep order and a workman was killed in a cavalry charge. The minister of war, M. Berteaux, visited the scene of the disturbance, and was reported to have saluted the red revolutionary flag which was borne by a procession of strikers singing the "Internationale."

During the autumn session in November M. Berteaux suddenly resigned the portfolio of war during a sitting of the Chamber, and was succeeded by M. Etienne, minister of the interior, a moderate politician who inspired greater confidence. Earlier in the year other industrial strikes of great gravity had taken place, notably at Limoges, among the potters, where several deaths took place in a conflict with the troops and a factory was burnt. Even more serious were the strikes in the government arsenals in November. At Cherbourg and Brest only a small proportion of the workmen went out, but at Lorient, Rochefort and especially at Toulon the strikes were on a much larger scale. In 1905 solemn warnings were given in the Chamber of the coming crisis in the wine-growing regions of the South. Radical-Socialists such as M. Doumergue, the deputy for Nîmes and a member of the Combes ministry, joined with monarchists such as M. Lasies, deputy of the Gers, in calling attention to the distress of the populations dependent on the vine. They argued that the wines of the South found no market, not because of the alleged over-production, but because of the competition of artificial wines; that formerly only twenty departments of France were classed in the atlas as wine-producing, but that thanks to the progress of chemistry seventy departments were now so described. The deputies of the north of France and of Paris, irrespective of party, opposed these arguments, and the government, while promising to punish fraud, did not seem to take very seriously the legitimate warnings of the representatives of the South.

The Republic continued to extend its friendly relations with foreign powers, and the end of M. Loubet's term of office was signalized by a procession of royal visits to Paris, some of which the president returned. At the end of May the king of Spain came and narrowly escaped assassination from a bomb which was thrown at him by a Spaniard as he was returning with the president from the opera. In October M. Loubet returned this visit at Madrid and went on to Lisbon to see the king of Portugal, being received by the queen, who was the daughter of the comte de Paris and the sister of the duc d'Orléans, both exiled by the Republic. In November the king of Portugal came to Paris, and the president of the Republic also received during the year less formal visits from the kings of England and of Greece.

One untoward international event affecting the French ministry occurred in June 1905. M. Delcassé (see section on *Exterior Policy*), who had been foreign minister longer than any holder of that office under the Republic, resigned, and it was believed that he had been sacrificed by the prime minister to the exigencies of Germany, which power was said to be disquieted at his having, in connexion

with the Morocco question, isolated Germany by promoting the friendly relations of France with England, Spain and Italy. Whether it be true or not that the French government was really in alarm at the possibility of a declaration of war by Germany, the impression given was unfavourable, nor was it removed when M. Rouvier himself took the portfolio of foreign affairs.

The year 1906 is remarkable in the history of the Third Republic in that it witnessed the renewal of all the public powers in the state. A new president of the Republic *M. Fallières* was elected on the 17th of January ten days after the *president of the* triennial election of one third of the senate, and the *of the* general election of the chamber of deputies followed *Republic.* in May—the ninth which had taken place under the constitution of 1875. The senatorial elections of the 7th of January showed that the delegates of the people who chose the members of the upper house and represented the average opinion of the country approved of the anti-clerical legislation of parliament. The election of M. Fallières, president of the senate, to the presidency of the Republic was therefore anticipated, he being the candidate of the parliamentary majorities which had disestablished the church. At the congress of the two chambers held at Versailles on the 17th of January he received the absolute majority of 449 votes out of 849 recorded. The candidate of the Opposition was M. Paul Doumer, whose anti-clericalism in the past was so extreme that when married he had dispensed with a religious ceremony and his children were unbaptized. So the curious spectacle was presented of the Moderate Opportunist M. Fallières being elected by Radicals and Socialists, while the Radical candidate was supported by Moderates and Reactionaries. For the second time a president of the senate, the second official personage in the Republic, was advanced to the chief magistracy, M. Loubet having been similarly promoted. As in his case, M. Fallières owed his election to M. Clémenceau. When M. Loubet was elected M. Clémenceau had not come to the end of his retirement from parliamentary life; but in political circles, with his powerful pen and otherwise, he was resuming his former influence as a "king-maker." He knew of the precariousness of Félix Faure's health and of the indiscretions of the elderly president. So when the presidency suddenly became vacant in January 1899 he had already fixed his choice on M. Loubet, as a candidate whose unobtrusive name excited no jealousy among the republicans. At that moment, owing to the crisis caused by the Dreyfus affair, the Republic needed a safe man to protect it against the attacks of the plebiscitary party which had been latterly favoured by President Faure. M. Constans, it was said, had in 1899 desired the presidency of the senate, vacant by M. Loubet's promotion, in preference to the post of ambassador at Constantinople. But M. Clémenceau, deeming that his name had been too much associated with polemics in the past, contrived the election of M. Fallières to the second place of dignity in the Republic, so as to have another safe candidate in readiness for the Elysée in case President Loubet suddenly disappeared. M. Loubet, however, completed his septennate, and to the end of it M. Fallières was regarded as his probable successor. As he fulfilled his high duties in the senate inoffensively without making enemies among his political friends, he escaped the fate which had awaited other presidents-designate of the Republic. Previously to presiding over the senate this Gascon advocate, who had represented his native Lot-et-Garonne, in either chamber, since 1876, had once been prime minister for three weeks in 1883. He had also held office in six other ministries, so no politician in France had a larger experience in administration and in public affairs.

On New Year's Day 1906, the absence of the Nuncio from the presidential reception of the diplomatic body marked conspicuously the rupture of the Concordat; for hitherto the representative of the Holy See had ranked as *doyen* of the ambassadors to the Republic, whatever the relative seniority of his colleagues, and in the name of all the foreign powers had officially saluted the chief of the state. On the 20th of January the inventories of the churches were commenced, under the 3rd clause of the

Separation Act, for the purpose of assessing the value of the furniture and other objects which they contained. In Paris they occasioned some disturbance; but as the protesting rioters were led by persons whose hostility to the Republic was more notorious than their love for religion, the demonstrations were regarded as political rather than religious. In certain rural districts, where the church had retained its influence and where its separation from the state was unpopular, the taking of the inventories was impeded by the inhabitants, and in some places, where the troops were called out to protect the civil authorities, further feeling was aroused by the refusal of officers to act. But, as a rule, this first manifest operation of the Separation Law was received with indifference by the population. One region where popular feeling was displayed in favour of the church was

The Sarrien ministry.

Flanders, where, in March, at Boeschepe on the Belgian frontier, a man was killed during the taking of an inventory. This accident caused the fall of the ministry. The moderate Republicans in the Chamber, who had helped to keep M. Rouvier in office, withheld their support in a debate arising out of the incident, and the government was defeated by thirty-three votes. M. Rouvier resigned, and the new president of the Republic sent for M. Sarrien, a Radical of the old school from Burgundy, who had been deputy for his native Saône-et-Loire from the foundation of the Chamber in 1876 and had previously held office in four cabinets. In M. Sarrien's ministry of the 14th of March 1906 the president of the council was only a minor personage, its real conductor being M. Clémenceau, who accepted the portfolio of the interior. Upon him, therefore devolved the function of "making the elections"

M. Clémenceau minister of the interior.

of 1906, as it is the minister at the Place Beauvau, where all the wires of administrative government are centralized, who gives the orders to the prefectures at each general election. As in France ministers sit and speak in both houses of parliament, M. Clémenceau, though a senator, now returned, after an absence of thirteen years, to the Chamber of Deputies, in which he had played a mighty part in the first seventeen years of its existence. His political experience was unique. From an early period after entering the Chamber in 1876 he had exercised there an influence not exceeded by any deputy. Yet it was not until 1906, thirty years after his first election to parliament, that he held office—though in 1888 he just missed the presidency of the Chamber, receiving the same number of votes as M. Méline, to whom the post was allotted by right of seniority. He now returned to the tribune of the Palais Bourbon, on which he had been a most formidable orator. During his career as deputy his eloquence was chiefly destructive, and of the nineteen ministries which fell between the election of M. Grévy to the presidency of the Republic in 1879 and his own departure from parliamentary life in 1893 there were few of which the fall had not been expedited by his mordant criticism or denunciation. He now came back to the scene of his former achievements not to attack but to defend a ministry. Though his old occupation was gone, his re-entry excited the keenest interest, for at sixty-five he remained the biggest political figure in France. After M. Clémenceau the most interesting of the new ministers was M. Briand, who was not nine years old when M. Clémenceau had become conspicuous in political life as the mayor of Montmartre on the eve of the Commune. M. Briand had entered the Chamber, as Socialist deputy for Saint Étienne, only in 1902. The mark he had made as "reporter" of the Separation Bill has been noted, and on that account he became minister of education and public worship—the terms of the Separation Law necessitating the continuation of a department for ecclesiastical affairs. As he had been a militant Socialist of the "unified" group of which M. Jaurès was the chief, and also a member of the superior council of labour, his appointment indicated that the new ministry courted the support of the extreme Left. It, however, contained some moderate men, notably M. Poincaré, who had the repute of making the largest income at the French bar after M. Waldeck-Rousseau gave up his practice, and who became for the second time minister of finance. The portfolios of the colonies and of public works were

also given to old ministers of moderate tendencies, M. Georges Leygues and M. Barthou. A former prime minister, M. Léon Bourgeois, went to the foreign office, over which he had already presided, besides having represented France at the peace conference at the Hague; while MM. Étienne and Thomson retained their portfolios of war and marine. The cabinet contained so many men of tried ability that it was called the ministry of all the talents. But the few who understood the origin of the name knew that it would be even more ephemeral than was the British ministry of 1806; for the fine show of names belonged to a transient combination which could not survive the approaching elections long enough to leave any mark in politics.

Before the elections took place grave labour troubles showed that social and economical questions were more likely to give anxiety to the government than any public movement resulting from the disestablishment of the church. Almost the first ministerial act of M. Clémenceau was to visit the coal basin of the Pas de Calais, where an accident causing great loss of life was followed by an uprising of the working population of the region, which spread into the adjacent department of the Nord and caused the minister of the interior to take unusual precautions to prevent violent demonstrations in Paris on Labour Day, the 1st of May. The activity of the Socialist leaders in encouraging anti-capitalist agitation did not seem to alarm the electorate. Nor did it show any sympathy with the appeal of the pope, who in his encyclical letter, *Vehementer nos*, addressed to the French cardinals on the 11th of February, denounced the Separation Law. So the result of the elections of May 1906 was a decisive victory for the anti-clericals and Socialists.

Progress of socialism.

A brief analysis of the composition of the Chamber of Deputies is always impossible, the limits of the numerous groups being ill-defined. But in general terms the majority supporting the radical policy of the *bloc* in the last parliament, which had usually mustered about 340 votes, now numbered more than 400, including 230 Radical-Socialists and Socialists. The gains of the extreme Left were chiefly at the expense of the moderate or progressist republicans, who, about 120 strong in the old Chamber, now came back little more than half that number. The anti-republican Right, comprising Royalists, Bonapartists and Nationalists, had maintained their former position and were about 130 all told. The general result of the polls of the 6th and 20th of May was thus an electoral vindication of the advanced policy adopted by the old Chamber and a repudiation of moderate Republicanism; while the stationary condition of the reactionary groups showed that the tribulations inflicted by the last parliament on the church had not provoked the electorate to increase its support of clerical politicians.

The Vatican, however, declined to recognize this unmistakable demonstration. The bishops, taking advantage of their release from the concordatory restrictions which had withheld from them the faculty of meeting in assembly, had met at a preliminary conference to consider their plan of action under the Separation Law. They had adjourned for further instructions from the Holy See, which were published on the 10th of August 1906, in a new encyclical *Gravissimo officii*, wherein, to the consternation of many members of the episcopate, the pope interdicted the *associations cultuelles*, the bodies which, under the Separation Law, were to be established in each parish, to hold and to organize the church property and finances, and were essential to the working of the act. On the 4th of September the bishops met again and passed a resolution of submission to the Holy See. In spite of their loyalty they could not but deplore an injunction which inevitably would cause distress to the large majority of the clergy after the act came into operation on the 12th of December 1906. They knew only too well how hopeless was the idea that the distress of the clergy would call forth any revulsion of popular feeling in France. The excitement of the public that summer over a painful clerical scandal in the diocese of Chartres showed that the interest taken by the mass of the population in church matters was not of a kind which would aid the clergy in their difficult situation.

At the close of the parliamentary recess M. Sarrien resigned the premiership on the pretext of ill-health, and by a presidential decree of the 25th of October 1906 M. Clémenceau, who had been called to fill the vacancy, took office. MM. Bourgeois, Poincaré, Étienne and Leygues retired with M. Sarrien. The new prime minister placed at the foreign office M. Pichon, who had learned politics on the staff of the *Justice*, the organ of M. Clémenceau, by whose influence he had entered the diplomatic service in 1893, after eight years in the chamber of deputies. He had been minister at Peking during the Boxer rebellion and resident at Tunis, and he was now radical senator for the Jura. M. Caillaux, a more adventurous financier than M. Rouvier or M. Poincaré, who had been Waldeck-Rousseau's minister of finance, resumed that office. The most significant appointment was that of General Picquart to the war office. The new minister when a colonel had been willing to sacrifice his career, although he was an anti-Semite, to redressing the injustice which he believed had been inflicted on a Jewish officer—whose second condemnation, it may be noted, had been quashed earlier in 1906. M. Viviani became the first minister of labour (*Travail et Prévoyance sociale*). The creation of the office and the appointment of a socialist lawyer and journalist to fill it showed that M. Clémenceau recognized the increasing prominence of social and industrial questions and the growing power of the trade-unions.

The acts and policy of the Clémenceau ministry and the events which took place during the years that it held office are too near the present time to be appraised historically. It seems not unlikely that the first advent to power, after thirty-five years of strenuous political life, of one who must be ranked among the ablest of the twenty-seven prime ministers of the Third Republic will be seen to have been coincident with an important evolution in the history of the French nation. The separation of the Roman Catholic Church from the state, by the law of December 1905, had deprived the Socialists, the now most powerful party of the extreme Left, of the chief outlet for their activity, which hitherto had chiefly found its scope in anti-clericalism. Having no longer the church to attack they turned their attention to economical questions, the solution of which had always been their theoretical aim. At the same period the law relating to the Contract of Association of 1901, by removing the restrictions (save in the case of religious communities) which previously had prevented French citizens from forming association without the authorization of the government, had formally abrogated the individualistic doctrine of the Revolution, which in all its phases was intolerant of associations. The law of June 1791 declared the destruction of all corporations of persons engaged in the same trade or profession to be a fundamental article of the French constitution, and it was only in the last six years of the Second Empire that some tolerance was granted to trade-unions, which was extended by the Third Republic only in 1884. In that year the prohibition of 1791 was repealed. Not quite 70 unions existed at the end of 1884. In 1890 they had increased to about 1000, in 1894 to 2000, and in 1901, when the law relating to the Contract of Association was passed, they numbered 3287 with 588,832 members. The law of 1901 did not specially affect them; but this general act, completely emancipating all associations formed for secular purposes, was a definitive break with the individualism of the Revolution which had formed the basis of all legislation in France for nearly a century after the fall of the ancient monarchy. It was an encouragement and at the same time a symptom of the spread of anti-individualistic doctrine. This was seen in the accelerated increase of syndicated workmen during the years succeeding the passing of the Associations Law, who in 1909 were over a million strong. The power exercised by the trade-unions moved the functionaries of the government, a vast army under the centralized system of administration, numbering not less than 800,000 persons, to demand equal freedom of association for the purpose of regulating their salaries paid by the state and their conditions of labour. This movement brought into new relief the long-recognized incompatibility of parliamentary government with administrative centralization as organized by Napoleon.

In another direction the increased activity in the rural districts of the Socialists, who hitherto had chiefly worked in the industrial centres, indicated that they looked for support from the peasant proprietors, whose ownership in the soil had hitherto opposed them to the practice of collectivist doctrine. In the summer of 1907 an economic crisis in the wine-growing districts of the South created a general discontent which spread to other rural regions. The Clémenceau ministry, while opposing the excesses of revolutionary socialism and while incurring the strenuous hostility of M. Jaurès, the Socialist leader, adopted a programme which was more socialistic than that of any previous government of the republic. Under its direction a bill for the imposition of a graduated income tax was passed by the lower house, involving a scheme of direct taxation which would transform the interior fiscal system of France. But the income tax was still only a project of law when M. Clémenceau unexpectedly fell in July 1909, being succeeded as prime minister by his colleague M. Briand. His ministry had, however, passed one important measure which individualists regarded as an act of state-socialism. It took a long step towards the nationalization of railways by purchasing the important Western line and adding it to the relatively small system of state railways. Previously a more generally criticized act of the representatives of the people was not of a nature to augment the popularity of parliamentary institutions at a period of economic crisis, when senators and deputies increased their own annual salary, or indemnity as it is officially called, to 15,000 francs. (J. E. C. B.)

EXTERIOR POLICY 1870-1909

The Franco-German War marks a turning-point in the history of the exterior policy of France as distinct as does the fall of the ancient monarchy or the end of the Napoleonic epoch. With the disappearance of the Second Empire, by its own fault, on the field of Sedan in September 1870, followed in the early months of 1871 by the proclamation of the German empire at Versailles and the annexation of Alsace and Lorraine under the treaty of peace of Frankfurt, France descended from its primacy among the nations of continental Europe, which it had gradually acquired in the half-century subsequent to Waterloo. It was the design of Bismarck that united Germany, which had been finally established under his direction by the war of 1870, should take the place hitherto occupied by France in Europe. The situation of France in 1871 in no wise resembled that after the French defeat of 1815, when the First Empire, issue of the Revolution, had been upset by a coalition of the European monarchies which brought back and supported on his restored throne the legitimate heir to the French crown. In 1871 the Republic was founded in isolation. France was without allies, and outside its frontiers the form of its executive government was a matter of interest only to its German conquerors. Bismarck desired that France should remain isolated in Europe and divided at home. He thought that the Republican form of government would best serve these ends. The revolutionary tradition of France would, under a Republic, keep aloof the monarchies of Europe, whereas, in the words of the German ambassador at Paris, Prince Hohenlohe, a "monarchy would strengthen France and place her in a better position to make alliances and would threaten our alliances." At the same time Bismarck counted on governmental instability under a Republic to bring about domestic disorganization which would so disintegrate the French nation as to render it unformidable as a foe and ineffective as an ally. The Franco-German War thus produced a situation unprecedented in the mutual relations of two great European powers. From that situation resulted all the exterior policy of France, for a whole generation, colonial as well as foreign.

In 1875 Germany saw France in possession of a constitution which gave promise of durability if not of permanence. German opinion had already been perturbed by the facility and speed with which France had paid off the colossal war indemnity exacted by the conqueror, thus giving proof of the inexhaustible resources of the country and of its powers of recuperation. The

successful reorganization of the French army under the military law of 1872 caused further alarm when there appeared to be some possibility of the withdrawal of Russia from the Dreikaiserbund, which had set the seal on Germany's triumph and France's abasement in Europe. It seemed, therefore, as though it might be expedient for Germany to make a sudden aggression upon France before that country was adequately prepared for war, in order to crush the nation irreparably and to remove it from among the great powers of Europe.

The constitution of the Third Republic was voted by the National Assembly on the 25th of February 1875. The new constitution had to be completed by electoral laws and other complementary provisions, so it could not become effective until the following year, after the first elections of the newly founded Senate and Chamber of Deputies. M. Buffet was then charged by the president of the republic, Marshal MacMahon, to form a provisional ministry in which the duc Decazes, who had been foreign minister since 1873, was retained at the Quai d'Orsay. The cabinet met for the first time on the 11th of March, and ten days later the National Assembly adjourned for a long recess.

It was during that interval that occurred the incident known as "The Scare of 1875." The Kulturkampf had left Prince

The crisis of 1875.

Bismarck in a state of nervous irritation. In all directions he was on the look out for traces of Ultramontane intrigue. The clericals in France after the fall of Thiers had behaved with great indiscretion in their desire to see the temporal power of the pope revived. But when the reactionaries had placed MacMahon at the head of the state, their divisions and their political ineptitude had shown that the government of France would soon pass from their hands, and of this the voting of the Republican constitution by a monarchical assembly was the visible proof. Nevertheless Bismarck, influenced by the presence at Berlin of a French ambassador, M. de Gontaut-Biron, whom he regarded as an Ultramontane agent, seems to have thought otherwise. A military party at Berlin affected alarm at a law passed by the French Assembly on the 12th of March, which continued a provision increasing from three to four the battalions of each infantry regiment, and certain journals, supposed to be inspired by Bismarck, argued that as the French were preparing, it might be well to anticipate their designs before they were ready. Europe was scared by an article on the 6th of May in *The Times*, professing to reveal the designs of Bismarck, from its Paris correspondent, Blowitz, who was in relations with the French foreign minister, the duc Decazes, and with Prince Hohenlohe, German ambassador to France, both being prudent diplomatists, and, though Catholics, opposed to Ultramontane pretensions. Europe was astounded at the revelation and alarmed at the alleged imminence of war. In England the Disraeli ministry addressed the governments of Russia, Austria and Italy, with a view to restraining Germany from its aggressive designs, and Queen Victoria wrote to the German emperor to plead the cause of peace. It is probable that there was no need either for this intervention or for the panic which had produced it. We know now that the old emperor William was steadfastly opposed to a fresh war, while his son, the crown prince Frederick, who then seemed likely soon to succeed him for a long reign, was also determined that peace should be maintained. The scare had, however, a most important result, in sowing the seeds of the subsequent Franco-Russian alliance. Notwithstanding that the tsar Alexander II. was on terms of affectionate intimacy with his uncle, the emperor William, he gave a personal assurance to General Le Flô, French ambassador at St Petersburg, that France should have the "moral support" of Russia in the case of an aggression on the part of Germany. It is possible that the danger of war was exaggerated by the French foreign minister and his ambassador at Berlin, as is the opinion of certain French historians, who think that M. de Gontaut-Biron, as an old royalist, was only too glad to see the Republic under the protection, as it were, of the most reactionary monarchy of Europe. At the same time Bismarck's denials of having acted with

terrorizing intent cannot be accepted. He was more sincere when he criticized the ostentation with which the Russian Chancellor, Prince Gortchakoff, had claimed for his master the character of the defender of France and the obstacle to German ambitions. It was in memory of this that, in 1878 at the congress of Berlin, Bismarck did his best to impair the advantages which Russia had obtained under the treaty of San Stefano.

The events which led to that congress put into abeyance the prospect of a serious understanding between France and Russia. The insurrection in Herzegovina in July 1875 reopened the Eastern question, and in the Orient the interests of France and Russia had been for many years conflicting, as witness the controversy concerning the Holy Places, which was one of the causes of the Crimean War. France had from the reign of Louis XIV. claimed the exclusive right of protecting Roman Catholic interests in the East. This claim was supported not only by the monarchists, for the most part friendly to Russia in other respects, who directed the foreign policy of the Third Republic until the Russo-Turkish War of 1877, but by the Republicans, who were coming into perpetual power at the time of the congress of Berlin—the ablest of the anti-clericals, Gambetta, declaring in this connexion that "anti-clericalism was not an article of exportation." The defeat of the monarchists at the elections of 1877, after the "Seize Mai," and the departure from office of the duc Decazes, whose policy had tended to prepare the way for an alliance with the tsar, changed the attitude of French diplomacy towards Russia. M. Waddington, the first Republican minister for foreign affairs, was not a Russophil, while Gambetta was ardently anti-Russian, and he, though not a minister, was exercising that preponderant influence in French politics which he retained until 1882, the last year of his life. Many Republicans considered that the monarchists, whom they had turned out, favoured the support of Russia not only as a defence against Germany, which was not likely to be effective so long as a friendly uncle and nephew were reigning at Berlin and at St Petersburg respectively, but also as a possible means of facilitating a monarchical restoration in France. Consequently at the congress of Berlin M. Waddington and the other French delegates maintained a very independent attitude towards Russia. They supported the resolutions which aimed at diminishing the advantages obtained by Russia in the war, they affirmed the rights of France over the Holy Places, and they opposed the anti-Semitic views of the Russian representatives. The result of the congress of Berlin seemed therefore to draw France and Russia farther apart, especially as Gambetta and the Republicans now in power were more disposed towards an understanding with England. The contrary, however, happened. The treaty of Berlin, which took the place of the treaty of San Stefano, was the ruin of Russian hopes. It was attributed to the support given by Bismarck to the anti-Russian policy of England and Austria at the congress, the German chancellor having previously discouraged the project of an alliance between Russia and Germany. The consequence was that the tsar withdrew from the Dreikaiserbund, and Germany, finding the support of Austria inadequate for its purposes, sought an understanding with Italy. Hence arose the Triple Alliance of 1882, which was the work of Bismarck, who thus became eventually the author of the Franco-Russian alliance, which was rather a sedative for the nervous temperament of the French than a remedy necessary for their protection. The twofold aim of the Triplice was the development of the Bismarckian policy of the continued isolation of France and of the maintenance of the situation in Europe acquired by the German empire in 1871. The most obvious alliance for Germany was that with Russia, but it was clear that it could be obtained only at the price of Russia having a free hand to satisfy its ambitions in the East. This not only would have irritated England against Germany, but also Austria, and so might have brought about a Franco-Austrian alliance, and a day of reckoning for Germany for the combined rancours of two nations, left by 1866 and 1871. It was thus that Germany allied itself first

with Austria and then with Italy, leaving Russia eventually to unite with France.

As the congress of Berlin took in review the general situation of the Turkish empire, it was natural that the French delegates should formulate the position of France in Egypt.

Egyptian question. Thus the powers of Europe accepted the maintenance of the *condominium* in Egypt, financial and administrative, of England and France. Egypt, nominally a province of the Turkish empire, had been invested with a large degree of autonomy, guaranteed by an agreement made in 1840 and 1841 between the Porte and the then five great powers, though some opposition was made to France being a party to this compact. By degrees Austria, Prussia and Russia (as well as Italy when it attained the rank of a great power) had left the international control of Egypt to France and England by reason of the preponderance of the interests of those two powers on the Nile.

In 1875 the interests of England in Egypt, which had hitherto been considered inferior to those of France, gained a superiority owing to the purchase by the British government of the shares of the khedive Ismail in the Suez Canal. Whatever rivalry there may have been between England and France, they had to present a united front to the pretensions of Ismail, whose prodigalities made him impatient of the control which they exercised over his finances. This led to his deposition and exile. The control was re-established by his successor Tewfik on the 4th of September 1879. The revival ensued of a so-called national party, which Ismail for his own purposes had encouraged in its movement hostile to foreign domination. In September 1881 took place the rising led by Arabi, by whose action an assembly of notables was convoked for the purpose of deposing the government authorized by the European powers. The fear lest the sultan should intervene gave an appearance of harmony to the policy of England and France, whose interests were too great to permit of any such interference. At the end of 1879 the first Freycinet cabinet had succeeded that of M. Waddington and had in turn been succeeded in September 1880 by the first Ferry cabinet. In the latter the foreign minister was M. Barthélemy Saint-Hilaire, an aged philosopher who had first taken part in politics when he helped to dethrone Charles X. in 1830. In September 1881 he categorically invited the British government to join France in a military intervention to oppose any interference which the Porte might attempt, and the two powers each sent a war-ship to Alexandria. On the 14th of November Gambetta formed his *grand ministère*, in which he was foreign minister. Though it lasted less than eleven weeks, important measures were taken by it, as Arabi had become under-secretary for war at Cairo, and was receiving secret encouragement from the sultan. On the 7th of January 1882, at the instance of Gambetta, a joint note was presented by the British and French consuls to the khedive, to the effect that their governments were resolved to maintain the *status quo*, Gambetta having designed this as a consecration of the Anglo-French alliance in the East. Thereupon the Porte protested, by a circular addressed to the powers, against this infringement of its suzerainty in Egypt. Meanwhile, the assembly of notables claimed the right of voting the taxes and administering the finances of the country, and Gambetta, considering this as an attempt to emancipate Egypt from the financial control of Europe, moved the British government to join with France in protesting against any interference on the part of the notables in the budget. But when Lord Granville accepted this proposal Gambetta had fallen, on the 26th of January, being succeeded by M. de Freycinet, who for the second time became president of the council and foreign minister. Gambetta fell nominally on a scheme of partial revision of the constitution. It included the re-establishment of *scrutin de liste*, a method of voting to which many Republicans were hostile, so this gave his enemies in his own party their opportunity. He thus fell the victim of republican jealousy, nearly half the Republicans in the chamber voting against him in the fatal division. The subsequent debates of 1882 show that many of Gambetta's adversaries were also opposed to his policy of uniting with England on the Egyptian question. Henceforth the interior

affairs of Egypt have little to do with the subject we are treating; but some of the incidents in France which led to the English occupation of Egypt ought to be mentioned. M. de Freycinet was opposed to any armed intervention by France; but in the face of the feeling in the country in favour of maintaining the traditional influence of France in Egypt, his declarations of policy were vague. On the 23rd of February 1882 he said that he would assure the non-exclusive preponderance in Egypt of France and England by means of an understanding with Europe, and on the 11th of May that he wished to retain for France its peculiar position of privileged influence. England and France sent to Alexandria a combined squadron, which did not prevent a massacre of Europeans there on the 11th of June, the khedive being now in the hands of the military party under Arabi. On the 11th of July the English fleet bombarded Alexandria, the French ships in anticipation of that action having departed the previous day. On the 18th of July the Chamber debated the supplementary vote for the fleet in the Mediterranean, M. de Freycinet declaring that France would take no active part in Egypt except as the mandatory of the European powers. This was the occasion for the last great speech of Gambetta in parliament. In it he earnestly urged close co-operation with England, which he predicted would otherwise become the mistress of Egypt, and in his concluding sentences he uttered the famous "*Ne rompez jamais l'alliance anglaise.*" A further vote, proposed in consequence of Arabi's open rebellion, was abandoned, as M. de Freycinet announced that the European powers declined to give France and England a collective mandate to intervene in their name. In the Senate on the 25th of July M. Scherer, better known as a philosopher than as a politician, who had Gambetta's confidence, read a report on the supplementary votes which severely criticized the timidity and vacillation of the government in Egyptian policy. Four days later in the Chamber M. de Freycinet proposed an understanding with England limited to the protection of the Suez Canal. Attacked by M. Clémenceau on the impossibility of separating the question of the canal from the general Egyptian question, the ministry was defeated by a huge majority, and M. de Freycinet fell, having achieved the distinction of being the chief instrument in removing Egypt from the sphere of French interest.

Some of the Republicans whose votes turned out M. de Freycinet wanted Jules Ferry to take his place, as he was considered to be a strong man in foreign policy, and Gambetta, for this reason, was willing to see his personal enemy at the head of public affairs. But this was prevented by M. Clémenceau and the extreme Left, and the new ministry was formed by M. Duclerc, an old senator whose previous official experience had been under the Second Republic. On its taking office on the 7th of August, the ministerial declaration announced that its policy would be in conformity with the vote which, by refusing supplies for the occupation of the Suez Canal, had overthrown M. de Freycinet. The declaration characterized this vote as "a measure of reserve and of prudence but not as an abdication." Nevertheless the action of the Chamber—which was due to the hostility to Gambetta of rival leaders, who had little mutual affection, including MM. de Freycinet, Jules Ferry, Clémenceau and the president of the Republic, M. Grévy, rather than to a desire to abandon Egypt—did result in the abdication of France. After England single-handed had subdued the rebellion and restored the authority of the khedive, the latter signed a decree on the 11th of January 1883 abolishing the joint control of England and France. Henceforth Egypt continued to be a frequent topic of debate in the Chambers; the interests of France in respect of the Egyptian finances, the judicial system and other institutions formed the subject of diplomatic correspondence, as did the irritating question of the eventual evacuation of Egypt by England. But though it caused constant friction between the two countries up to the Anglo-French convention of the 8th of April 1904, there was no longer a French active policy with regard to Egypt. The lost predominance of France in that country did, however, quicken French activity in other regions of northern Africa.

The idea that the Mediterranean might become a French lake has, in different senses, been a preoccupation for France and for its rivals in Europe ever since Algeria became a French province by a series of fortuitous incidents—an insult offered by the dey to a French consul, his refusal to make reparation, and the occasion it afforded of diverting public attention in France from interior affairs after the Revolution of 1830. The French policy of preponderance in Egypt had only for a secondary aim the domination of the Mediterranean. The French tradition in Egypt was a relic of Napoleon's vain scheme to become emperor of the Orient even before he had made himself emperor of the West. It was because Egypt was the highway to India that under Napoleon III. the French had constructed the Suez Canal, and for the same reason England could never permit them to become masters of the Nile delta. But the possessors of Algeria could extend their coast-line of North Africa without seriously menacing the power which held Gibraltar and Malta. It was Italy which objected to a French occupation of Tunis. Algeria has never been officially a French "colony." It is in many respects administered as an integral portion of French territory, the governor-general, as agent of the central power, exercising wide jurisdiction. Although the Europeans in Algeria are less than a seventh of the population, and although the French are actually a minority of the European inhabitants—Spaniards prevailing in the west, Italians and Maltese in the east—the three departments of Constantine, Algiers and Oran are administered like three French departments. Consequently, when disturbances occurred on the borderland separating Constantine from Tunis, the French were able to say to Europe that the integrity of their national frontier was threatened by the proximity of a turbulent neighbour. The history of the relations between Tunis and France were set forth, from the French standpoint, in a circular, of which Jules Ferry was said to be the author, addressed by the foreign minister, M. Barthélemy Saint-Hilaire on the 9th of May 1881, to the diplomatic agents of France abroad. The most important point emphasized by the French minister was the independence of Tunis from the Porte, a situation which would obviate difficulties with Turkey such as had always hampered the European powers in Egypt. In support of this contention a protest made by the British government in 1830, against the French conquest of Algiers, was quoted, as in it Lord Aberdeen had declared that Europe had always treated the Barbary states as independent powers. On the other hand, there was the incident of the bey of Tunis having furnished to Turkey a contingent during the Crimean War, which suggested a recognition of its vassalage to the Sublime Porte. But in 1864, when the sultan had sent a fleet to La Goulette to affirm his "rights" in Tunis, the French ambassador at Constantinople intimated that France declined to have Turkey for a neighbour in Algeria. France also in 1868 essayed to obtain control over the finances of the regency; but England and Italy had also large interests in the country, so an international financial commission was appointed. In 1871, when France was disabled after the war, the bey obtained from Constantinople a firman of investiture, thus recognizing the suzerainty of the Porte. Certain English writers have reproached the Foreign Office for its lack of foresight in not taking advantage of France's disablement by establishing England as the preponderant power in Tunis. The fact that five-sixths of the commerce of Tunis is now with France and Algeria may seem to justify such regrets. Yet by the light of subsequent events it seems probable that England would have been diverted from more profitable undertakings had she been saddled with the virtual administration and military occupation of a vast territory which such preponderance would have entailed. The wonder is that this opportunity was not seized by Italy; for Mazzini and other workers in the cause of Italian unity, before the Bourbons had been driven from Naples, had cast eyes on Tunis, lying over against the coasts of Sicily at a distance of barely 100 m., as a favourable field for colonization and as the key of the African Mediterranean. But when Rome became once more the capital of Italy, Carthage was not fated to fall again under its domination

and the occasion offered by France's temporary impotence was neglected. In 1875 when France was rapidly recovering, there went to Tunis as consul an able Frenchman, M. Roustan, who became virtual ruler of the regency in spite of the resistance of the representative of Italy. French action was facilitated by the attitude of England. On the 26th of July 1878 M. Waddington wrote to the marquis d'Harcourt, French ambassador in London, that at the congress of Berlin Lord Salisbury had said to him—the two delegates being the foreign ministers of their respective governments—in reply to his protest, on behalf of France, against the proposed English occupation of Cyprus, "Do what you think proper in Tunis: England will offer no opposition." This was confirmed by Lord Salisbury in a despatch to Lord Lyons, British ambassador in Paris, on the 8th of August, and it was followed in October by an intimation made by the French ambassador at Rome that France intended to exercise a preponderant influence in Tunis. Italy was not willing to accept this situation. In January 1881 a tour made by King Humbert in Sicily, where he received a Tunisian mission, was taken to signify that Italy had not done with Tunis, and it was answered in April by a French expedition in the regency sent from Algeria, on the pretext of punishing the Kroumirs who had been marauding on the frontier of Constantine. It was on this occasion that M. Barthélemy Saint-Hilaire issued the circular quoted above. France nominally was never at war with Tunis; yet the result of the invasion was that that country became virtually a French possession, although officially it is only under the protection of France. The treaty of El Bardo of the 12th of May 1881, confirmed by the decree of the 22nd of April 1882, placed Tunis under the protectorate of France. The country is administered under the direction of the French Foreign Office, in which there is a department of Tunisian affairs. The governor is called minister resident-general of France, and he also acts as foreign minister, being assisted by seven French and two native ministers.

The annexation of Tunis was important for many reasons. It was the first successful achievement of France after the disasters of the Franco-German War, and it was the first enterprise of serious utility to France undertaken beyond its frontiers since the early period of the Second Empire. It was also important as establishing the hegemony of France on the southern shores of the Mediterranean. When M. Jules Cambon became governor-general of Algeria, his brother M. Paul Cambon having been previously French resident in Tunis and remaining the vigilant ambassador to a Mediterranean power, a Parisian wit said that just as Switzerland had its *Lac des quatre Cantons*, so France had made of the midland sea its *Lac des deux Cambons*. The *jeu d'esprit* indicated what was the primary significance to the French of their becoming masters of the Barbary coast from the boundary of Morocco to that of Tripoli. Apart from the Mediterranean question, when the scramble for Africa began and the Hinterland doctrine was asserted by European powers, the possession of this extended coast-line resulted in France laying claim to the Sahara and the western Sudan. Consequently, on the maps, the whole of north-west Africa, from Tunis to the Congo, is claimed by France with the exception of the relatively small areas on the coast belonging to Morocco, Spain, Portugal, Liberia, Germany and England. On this basis, in point of area, France is the greatest African power, in spite of British annexations in south and equatorial Africa, its area being estimated at 3,866,950 sq. m. (including 227,950 in Madagascar) as against 2,101,411 more effectively possessed by Great Britain. The immensity of its domain on paper is no doubt a satisfaction to a people which prefers to pursue its policy of colonial expansion without the aid of emigration. The acquisition of Tunis by France is also important as an example of the system of protectorate as applied to colonization. Open annexation might have more gravely irritated the powers having interests in the country. England, in spite of Lord Salisbury's suggestions to the French foreign minister, was none too pleased with France's policy; while Italy, with its subjects outnumbering all other European settlers in the

*Extension
of African
territory.*

regency, was in a mood to accept a pretext for a quarrel for the reasons already mentioned. Apart from these considerations the French government favoured a protectorate because it did not wish to make of Tunis a second Algeria. While the annexation of the latter had excellent commercial results for France, it had not been followed by successful colonization, though it had cost France 160 millions sterling in the first sixty years after it became French territory. The French cannot govern at home or abroad without a centralized system of administration. The organization of Algeria, as departments of France with their administrative divisions, was not an example to imitate. In the beylical government France found, ready-made, a sufficiently centralized system, such as did not exist in Algeria under native rule, which could form a basis of administration by French functionaries under the direction of the Quai d'Orsay. The result has not been unpleasing to the numerous advocates in France of protectorates as a means of colonization. According to M. Paul Leroy-Beaulieu, the most eminent French authority on colonization, who knows Tunis well, a protectorate is the most pacific, the most supple, and the least costly method of colonization in countries where an organized form of native government exists; it is the system in which the French can most nearly approach that of English crown colonies. One evil which it avoids is the so-called representative system, under which senators and deputies are sent to the French parliament not only from Algeria as an integral part of France, but from the colonies of Martinique, Guadeloupe and French India, while Cochinchina, Guiana and Senegal send deputies alone. These sixteen deputies and seven senators attach themselves to the various Moderate, Radical and Socialist groups in parliament, which have no connexion with the interests of the colonies; and the consequent introduction of French political controversies into colonial elections has not been of advantage to the oversea possessions of France. From this the protectorate system spared Tunis, and the paucity of French immigration will continue to safeguard that country from parliamentary representation. After twenty years of French rule, of 120,000 European residents in Tunis, not counting the army, only 22,000 were French, while nearly 70,000 were Italian. If under a so-called representative system the Italians had demanded nationalization, for the purpose of obtaining the franchise, complications might have arisen which are not to be feared under a protectorate.

But of all the results of the French annexation of Tunis, the most important was undoubtedly the Triple Alliance, into which Italy entered in resentment at having been deprived of the African territory which seemed marked out as its natural field for colonial expansion. The most manifest cause of Italian hostility towards France had passed away four years before the annexation of Tunis, when the reactionaries, who had favoured the restitution of the temporal power of the pope, fell for ever from power. The clericalism of the anti-republicans, who favoured a revival of the fatal policy of the Second Empire whereby France, after Magenta and Solferino, had by leaving its garrison at St Angelo, been the last obstacle to Italian unity, was one of the chief causes of their downfall. For after the war with Germany, the mutilated land and the vanquished nation had need to avoid wanton provocations of foreign powers. Henceforth the French Republic, governed by Republicans, was to be an anti-clerical force in Europe, sympathizing with the Italian occupation of Rome. But to make Italy realize that France was no longer the enemy of complete Italian unity it would have been necessary that all causes of irritation between the two Latin sister nations were removed. Such causes of dissension did, however, remain, arising from economic questions. The maritime relations of the two chief Mediterranean powers were based on a treaty of navigation of 1862—when Venice was no party to it being an Austrian port—which Crispi denounced as a relic of Italian servility towards Napoleon III. Commercial rivalry was induced by the industrial development of northern Italy, when freed from Austrian rule. Moreover, the emigrant propensity

of the Italians flooded certain regions of France with Italian cheap labour, with the natural result of bitter animosity between the intruders and the inhabitants of the districts thus invaded. The annexation of Tunis, coming on the top of these causes of irritation, exasperated Italy. A new treaty of commerce was nevertheless signed between the two countries on the 3rd of November 1881. Unfortunately for its stability, King Humbert the previous week had gone to Vienna to see the emperor of Austria. In visiting in his capital the former arch-enemy of Italian unity, who could never return the courtesy, Rome being interdicted for Catholic sovereigns by the "prisoner of the Vatican," Humbert had only followed the example of his father Victor Emmanuel, who went both to Berlin and to Vienna in 1873. But that was when in France the duc de Broglie was prime minister of a clerical government of which many of the supporters were clamouring for the restitution of the temporal power. King Humbert's visit to Vienna at the moment when Gambetta, the great anti-clerical champion, was at the height of his influence was significant for other reasons. Since the 7th of October 1879 Germany and Austria had been united by a defensive treaty, and though its provisions were not published until 1888, the two central empires were known to be in the closest alliance. The king of Italy's visit to Vienna, where he was accompanied by his ministers Depretis and Mancini, had therefore the same significance as though he had gone to Berlin also. On the 20th of May 1882 was signed the treaty of the Triple Alliance, which for many years bound Italy to Germany in its relations with the continental powers. The alliance was first publicly announced on the 13th of March 1883, in the Italian Chamber, by Signor Mancini, minister for foreign affairs. The aim of Italy in joining the combination was alliance with Germany, the enemy of France. The connexion with Austria was only tolerated because it secured a union with the powerful government of Berlin. It effected the complete isolation of France in Europe. An understanding between the French Republic and Russia, which alone could alter that situation, was impracticable, as its only basis seemed to be the possibility of having a common enemy in Germany or even in England. But that double eventuality was anticipated by a secret convention concluded at Skiernewice in September 1884 by the tsar and the German emperor, in which they guaranteed to one another a benevolent neutrality in case of hostilities between England and Russia arising out of the Afghan question.

It will be convenient here to refer to the relations of France with Germany and Italy respectively in the years succeeding the signature of the Triple Alliance. With Germany both Gambetta, who died ten weeks before the treaty was announced and who was a strong Russophobe, and his adversary Jules Ferry were inclined to come to an understanding. But in this they had not the support of French opinion. In September 1883 the king of Spain had visited the sovereigns of Austria and Germany. Alphonso XII., to prove that this journey was not a sign of hostility to France, came to Paris on his way home on Michaelmas Day on an official visit to President Grévy. Unfortunately it was announced that the German emperor had made the king colonel of a regiment of Uhlans garrisoned at Strassburg, the anniversary of the taking of which city was being celebrated by the emperor by the inauguration of a monument made out of cannon taken from the French, on the very eve of King Alphonso's arrival. Violent protests were made in Paris in the monarchial and in not a few republican journals, with the result that the king of Spain was hooted by the crowd as he drove with the president from the station to his embassy, and again on his way to dine the same night at the Elysée. The incident was closed by M. Grévy's apologies and by the retirement of the minister of war, General Thibaudin, who under pressure from the extreme Left had declined to meet *le roi uhlan*. Though it displayed the bitter hostility of the population towards Germany, the incident did not aggravate Franco-German relations. This was due to the policy of the prime minister, Jules Ferry, who to carry it out made himself foreign minister in November, in the place of Challemeil-Lacour, who resigned.

Jules Ferry's idea was that colonial expansion was the surest means for France to recover its prestige, and that this could be obtained only by maintaining peaceful relations with all the powers of Europe. His consequent unpopularity caused his fall in April 1885, and the next year a violent change of military policy was marked by the arrival of General Boulanger at the ministry of war, where he remained, in the Freycinet and Goblet cabinets, from January 1886 to the 17th of May 1887. His growing popularity in France was answered by Bismarck, who asked for an increased vote for the German army, indicating that he considered Boulanger the coming dictator for the war of revenge; so when the Reichstag, on the 14th of January 1887, voted the supplies for three years, instead of for the seven demanded by the chancellor, it was dissolved. Bismarck redoubled his efforts in the press and in diplomacy, vainly attempting to come to an understanding with Russia and with more success moving the Vatican to order the German Catholics to support him. He obtained his vote for seven years in March, and the same month renewed the Triple Alliance. In April the Schnaebelé incident seemed nearly to cause war between France and Germany. The commissary-special, an agent of the ministry of the interior, at Pagny-sur-Moselle, the last French station on the frontier of the annexed territory of Lorraine, having stepped across the boundary to regulate some official matter with the corresponding functionary on the German side, was arrested. It was said that Schnaebelé was arrested actually on French soil, and on whichever side of the line he was standing he had gone to meet the German official at the request of the latter. Bismarck justified the outrage in a speech in the Prussian Landtag which suggested that it was impossible to live at peace with a nation so bellicose as the French. In France the incident was regarded as a trap laid by the chancellor to excite French opinion under the aggressive guidance of Boulanger, and to produce events which would precipitate a war. The French remained calm, in spite of the growing popularity of Boulanger. The Goblet ministry resigned on the 17th of May 1887 after a hostile division on the budget, and the opportunity was taken to get rid of the minister of war, who posed as the coming restorer of Alsace and Lorraine to France. The Boulangist movement soon became anti-Republican, and the opposition to it of successive ministries improved the official relations of the French and German governments. The circumstances attending the fall of President Grévy the same year strengthened the Boulangist agitation, and Jules Ferry, who seemed indicated as his successor, was discarded by the Republican majority in the electoral congress, as a revolution was threatened in Paris if the choice fell on "the German Ferry." Sadi Carnot was consequently elected president of the Republic on the 3rd of December 1887. Three months later, on the 9th of March 1888, died the old emperor William who had personified the conquest of France by Germany. His son, the pacific emperor Frederick, died too, on the 15th of June, so the accession of William II., the pupil of Bismarck, at a moment when Boulanger threatened to become plebiscitary dictator of France, was ominous for the peace of Europe. But in April 1889 Boulanger ignominiously fled the country, and in March 1890 Bismarck fell. France none the less rejected all friendly overtures made by the young emperor. In February 1891 his mother came to Paris and was unluckily induced to visit the scenes of German triumph near the capital—the ruins of St Cloud and the Château of Versailles where the German empire was proclaimed. The incident called forth such an explosion of wrath from the French press that it was clear that France had not forgotten 1871. By this time, however, France was no longer isolated and at the mercy of Germany, which by reason of the increase of its population while that of France had remained almost stationary, was, under the system of compulsory military service in the two countries, more than a match for its neighbour in a single-handed conflict. Even the Triple Alliance ceased to be a terror for France. An understanding arose between France and Russia preliminary to the Franco-Russian alliance, which became the pivot of French exterior relations until the defeat of Russia

in the Japanese war of 1904. So the second renewal of the Triple Alliance was forthwith answered by a visit of the French squadron to Kronstadt in July 1891.

While such were the relations between France and the principal party to the Triple Alliance, the same period was marked by bitter dissension between France and Italy. Tunis had made Italy Gallophobe, but the diplomatic relations between the two countries had been courteous until the death of Depretis in 1887. When Crispi succeeded him as prime minister, and till 1891 was the director of the exterior policy of Italy, a change took place. Crispi, though not the author of the Triple Alliance, entered with enthusiasm into its spirit of hostility to France. The old Sicilian revolutionary hastened to pay his respects to Bismarck at Friedrichsruh in October 1887, the visit being highly approved in Italy. Before that the French Chamber had, in July 1886, by a small majority, rejected a new treaty of navigation between France and Italy, this being followed by the failure to renew the commercial treaty of 1881. Irritating incidents were of constant occurrence. In 1888 a conflict between the French consul at Massowah and the Italians who occupied that Abyssinian port induced Bismarck to instruct the German ambassador in Paris to tell M. Goblet, minister for foreign affairs in the Floquet cabinet, in case he should refer to the matter, that if Italy were involved thereby in complications it would not stand alone—this menace being communicated to Crispi by the Italian ambassador at Berlin and officially printed in a green-book. But after Bismarck's fall relations improved a little, and in April 1890 the Italian fleet was sent to Toulon to salute President Carnot in the name of King Humbert, though this did not prevent the French government being suspected of having designs on Tripoli. Italian opinion was again incensed against France by the action of the French clericals, represented by a band of Catholic "pilgrims" who went to Rome to offer their sympathy to the pope in the autumn of 1891, and outraged the burial-place of Victor Emmanuel by writing in the visitors' register kept at the Pantheon the words "*Vive le pape.*" In August 1893 a fight took place at Aigues Mortes, the medieval walled city on the salt marshes of the Gulf of Lyons, between French and Italian workmen, in which seven Italians were killed. But Crispi had gone out of office early in 1891, and the ministers who succeeded him were more disposed to prevent a rupture between Italy and France. Crispi became prime minister again in December 1893, but this time without the portfolio of foreign affairs: He placed at the Consulta Baron Blanc, who though a strong partisan of the Triple Alliance was closely attached to France, being a native of Savoy, where he spent his yearly vacations on French soil. That the relations between the two nations were better was shown by what occurred after the murder of President Carnot in June 1894. The fact that the assassin was an Italian might have caused trouble a little earlier; but the grief of the Italians was so sincere, as shown by popular demonstrations at Rome, that no anti-Italian violence took place in France, and in the words of the French ambassador, M. Billot, Caserio's crime seemed likely to further an understanding between the two peoples. The movement was very slight and made no progress during the short presidency of M. Casimir-Périer. On the 1st of November 1894 Alexander III. died, when the Italian press gave proof of the importance attributed by the Triple Alliance to the Franco-Russian understanding by expressing a hope that the new tsar would put an end to it. But on the 10th of June 1895, the foreign minister, M. Hanotaux, intimated to the French Chamber that the understanding had become an alliance, and on the 17th the Russian ambassador in Paris conveyed to M. Félix Faure, who was now president of the Republic, the collar of St Andrew, while the same day the French and Russian men-of-war, invited to the opening of the Kiel Canal, entered German waters together. The union of France with Russia was no doubt one cause of the cessation of Italian hostility to France; but others were at work. The inauguration of the statue of MacMahon at Magenta the same week as the announcement of the Franco-Russian alliance showed that

Franco-German relations.

France and Italy.

there was a disposition to revive the old sentiment of fraternity which had once united France with Italy. More important was the necessity felt by the Italians of improved commercial relations with the French. Crispi fell on the 4th of March 1896, after the news of the disaster to the Italian troops at Adowa, the war with Abyssinia being a disastrous legacy left by him. The previous year he had caused the withdrawal from Paris of the Italian ambassador Signor Ressmann, a friend of France, transferring thither Count Tornielli, who during his mission in London had made a speech, after the visit of the Italian fleet to Toulon, which qualified him to rank as a *misogallo*. But with the final disappearance of Crispi the relations of the two Latin neighbours became more natural. Commerce between them had diminished, and the business men of both countries, excepting certain protectionists, felt that the commercial rupture was mutually prejudicial. Friendly negotiations were initiated on both sides, and almost the last act of President Félix Faure before his sudden death—M. Delcassé being then foreign minister—was to promulgate, on the 2nd of February 1899, a new commercial arrangement between France and Italy which the French parliament had adopted. By that time M. Barrère was ambassador at the Quirinal and was engaged in promoting cordial relations between Italy and France, of which Count Tornielli in Paris had already become an ardent advocate. Italy remained a party to the Triple Alliance, which was renewed for a third period in 1902. But so changed had its significance become that in October 1903 the French Republic received for the first time an official visit from the sovereigns of Italy. This reconciliation of France and Italy was destined to have most important results outside the sphere of the Triple Alliance. The return visit which President Loubet paid to Victor Emmanuel III. in April 1904, it being the first time that a French chief of the state had gone to Rome since the pope had lost the temporal sovereignty, provoked a protest from the Vatican which caused the rupture of diplomatic relations between France and the Holy See, followed by the repudiation of the Concordat by an act passed in France, in 1905, separating the church from the state.

While the decadence of the Triple Alliance had this important effect on the domestic affairs of France, its inception had produced the Franco-Russian alliance, which took France out of its isolation in Europe, and became the pivot of its exterior policy. It has been noted that in the years succeeding the Franco-Prussian War the tsar Alexander II. had shown a disposition to support France against German aggression, as though to make up for his neutrality during the war, which was so benevolent for Germany that his uncle William I. had ascribed to it a large share of the German victory. The assassination of Alexander II. by revolutionaries in 1881 made it difficult for the new autocrat to cultivate closer relations with a Republican government, although the Third Republic, under the influence of Gambetta, to whom its consolidation was chiefly due, had repudiated that proselytizing spirit, inherited from the great Revolution, which had disquieted the monarchies of Europe in 1848 and had provoked their hostility to the Second Republic. But the Triple Alliance which was concluded the year after the murder of the tsar indicated the possible expediency of an understanding between the two great powers of the West and the East, in response to the combination of the three central powers of Europe,—though Bismarck after his fall revealed that in 1884 a secret treaty was concluded between Germany and Russia, which was, however, said to have in view a war between England and Russia. Internal dissension on the subject of colonial policy in the far East, followed by the fall of Jules Ferry and the Boulangist agitation were some of the causes which prevented France from strengthening its position in Europe by seeking a formal understanding with Russia in the first part of the reign of Alexander III. But when the Boulangist movement came to an end, entirely from the incompetency of its leader, it behoved the government of the Republic to find a means of satisfying the strong patriotic sentiment revealed in the nation, which, directed by a capable and daring soldier, would have swept away the parliamentary republic and estab-

lished a military dictatorship in its place. The Franco-Russian understanding provided that means, and Russia was ready for it, having become, by the termination in 1890 of the secret treaty with Germany, not less isolated in Europe than France. In July 1891, when the French fleet visited Kronstadt the incident caused such enthusiasm throughout the French nation that the exiled General Boulanger's existence would have been forgotten, except among his dwindling personal followers, had he not put an end to it by suicide two months later at Brussels. The Franco-Russian understanding united all parties, not in love for one another but in the idea that France was thereby about to resume its place in Europe. The Catholic Royalists ceased to talk of the restitution of the temporal power of the pope in their joy at the deference of the government of the republic for the most autocratic monarchy of Christendom; the Boulangists, now called Nationalists, hoped that it would lead to the war of revenge with Germany, and that it might also be the means of humiliating England, as shown by their resentment at the visit of the French squadron to Portsmouth on its way home from Kronstadt. It is, however, extremely improbable that the understanding and subsequent alliance would have been effected had the Boulangist movement succeeded. For the last thing that the Russian government desired was war with Germany. What it needed and obtained was security against German aggression on its frontier and financial aid from France; so a French plebiscitary government, having for its aim the restitution of Alsace and Lorraine, would have found no support in Russia. As the German chancellor, Count von Caprivi, said in the Reichstag on the 27th of November 1891, a few weeks after a Russian loan had been subscribed in France nearly eight times over, the naval visit to Kronstadt had not brought war nearer by one single inch. Nevertheless when in 1893 the Russian fleet paid a somewhat tardy return visit to Toulon, where it was reviewed by President Carnot, a party of Russian officers who came to Paris was received by the population of the capital, which less than five years before had acclaimed General Boulanger, with raptures which could not have been exceeded had they brought back to France the territory lost in 1871. In November 1894, Alexander III. died, and in January 1895, M. Casimir-Périer resigned the presidency of the Republic, to which he had succeeded only six months before on the assassination of M. Carnot. So it was left to Nicholas II. and President Félix Faure to proclaim the existence of a formal alliance between France and Russia. It appears that in 1891 and 1892, at the time of the first public manifestations of friendship between France and Russia, in the words of M. Ribot, secret conventions were signed by him, being foreign minister, and M. de Freycinet, president of the council, which secured for France "the support of Russia for the maintenance of the equilibrium in Europe"; and on a later occasion the same statesman said that it was after the visit of the empress Frederick to Paris in 1891 that Alexander III. made to France certain offers which were accepted. The word "alliance" was not publicly used by any minister to connote the relations of France with Russia until the 10th of June 1895, when M. Hanotaux used the term with cautious vagueness amid the applause of the Chamber of Deputies. Yet not even when Nicholas II. came to France in October 1896 was the word "alliance" formally pronounced in any of the official speeches. But the reception given to the tsar and tsaritsa in Paris, where no European sovereign had come officially since William of Germany passed down the Champs Elysées as a conqueror, was of such a character that none could doubt that this was the consecration of the alliance. It was at last formally proclaimed by Nicholas II., on board a French man-of-war, on the occasion of the visit of the president of the Republic to Russia in August 1897. From that date until the formation of M. Briand's cabinet in 1909, nine different ministries succeeded one another and five ministers of foreign affairs; but they all loyally supported the Franco-Russian alliance, although its popularity diminished in France long before the war between Russia and Japan, which deprived it of its efficacy in Europe. In 1901 Nicholas II. came again to France and was the guest of President

Loubet at Compiègne. His visit excited little enthusiasm in the nation, which was disposed to attribute it to Russia's financial need of France; while the Socialists, now a strong party which provided the Waldeck-Rousseau ministry with an important part of its majority in the Chamber, violently attacked the alliance of the Republic with a reactionary autocracy. However anomalous that may have been it did not prevent the whole French nation from welcoming the friendship between the governments of Russia and of France in its early stages. Nor can there be any doubt that the popular instinct was right in according it that welcome. France in its international relations was strengthened morally by the understanding and by the alliance, which also served as a check to Germany. But its association with Russia had not the results hoped for by the French reactionaries. It encouraged them in their opposition to the parliamentary Republic during the Dreyfus agitation, the more so because the Russian autocracy is anti-Semitic. It also made a Nationalist of one president of the Republic, Félix Faure, whose head was so turned by his imperial frequentations that he adopted some of the less admirable practices of princes, and also seemed ready to assume the bearing of an autocrat. His sudden death was as great a relief to the parliamentary Republicans as it was a disappointment to the plebiscitary party, which anti-Dreyfusism, with its patriotic pretensions, had again made a formidable force in the land. But the election of the pacific and constitutional M. Loubet as president of the Republic at this critical moment in its history counteracted any reactionary influence which the Russian alliance might have had in France; so the general effect of the alliance was to strengthen the Republic and to add to its prestige. The visit of the tsar to Paris, the first paid by a friendly sovereign since the Second Empire, impressed a population, proud of its capital, by an outward sign which seemed to show that the Republic was not an obstacle to the recognition by the monarchies of Europe of the place still held by France among the great powers. Before M. Loubet laid down office the nation, grown more republican, saw the visit of the tsar followed by those of the kings of England and of Italy, who might never have been moved to present their respects to the French Republic had not Russia shown them the way.

While the French rejoiced at the Russian alliance chiefly as a check to the aggressive designs of Germany, they also liked the association of France with a power regarded as hostile to England. This traditional feeling was not discouraged by one of the chief artificers of the alliance, Baron Mohrenheim, Russian ambassador in Paris, who until 1884 had filled the same position in London, where he had not learned to love England, and who enjoyed in France a popularity rarely accorded to the diplomatic agent of a foreign power. An *entente cordiale* has since been initiated between England and France. But it is necessary to refer to the less agreeable relations which existed between the two countries, as they had some influence on the exterior policy of the Third Republic. England and France had no causes of friction within Europe. But in its policy of colonial expansion, during the last twenty years of the 19th century, France constantly encountered England all over the globe. The first important enterprise beyond the seas seriously undertaken by France after the Franco-German War, was, as we have seen, in Tunis. But even before that question had been mentioned at the congress of Berlin, in 1878, France had become involved in an adventure in the Far East, which in its developments attracted more public attention at home than the extension of French territory in northern Africa. Had these pages been written before the end of the 19th century it would have seemed necessary to trace the operations of France in Indo-China with not less detail than has been given to the establishment of the protectorate in Tunis. But French hopes of founding a great empire in the Far East came to an end with the partial resuscitation of China and the rise to power of Japan. As we have seen, Jules Ferry's idea was that in colonial expansion France would find the best means of recovering prestige after the defeat of 1870-71 in the years

of recuperation when it was essential to be diverted from European complications. Jules Ferry was not a friend of Gambetta, in spite of later republican legends. But the policy of colonial expansion in Tunis and in Indo-China, associated with Ferry's name, was projected by Gambetta to give satisfaction to France for the necessity, imposed, in his opinion, on the French government, of taking its lead in foreign affairs from Berlin. How Jules Ferry developed that system we know now from Bismarck's subsequent expressions of regret at Ferry's fall. He believed that, had Ferry remained in power, an amicable arrangement would have been made between France and Germany, a formal agreement having been almost concluded to the effect that France should maintain peaceable and friendly relations with Germany, while Bismarck supported France in Tunis, in Indo-China and generally in its schemes of oversea colonization. Even though the friendly attitude of Germany towards those schemes was not official the contrast was manifest between the benevolent tone of the German press and that of the English, which was generally hostile. Jules Ferry took his stand on the position that his policy was one not of colonial conquest, but of colonial conservation, that without Tunis, Algeria was insecure, that without Tongking and Annam, there was danger of losing Cochinchina, where the French had been in possession since 1861. It was on the Tongking question that Ferry fell. On the 30th of March 1885, on the news of the defeat of the French troops at Lang-Son, the Chamber refused to vote the money for carrying on the campaign by a majority of 306 to 149. Since that day public opinion in France has made amends to the memory of Jules Ferry. His patriotic foresight has been extolled. Criticism has not been spared for the opponents of his policy in parliament of whom the most conspicuous, M. Clémenceau and M. Ribot, have survived to take a leading part in public affairs in the 20th century. The attitude of the Parisian press, which compared Lang-Son with Sedan and Jules Ferry with Émile Ollivier, has been generally deplored, as has that of the public which was ready to offer violence to the fallen minister, and which was still so hostile to him in 1887 that the congress at Versailles was persuaded that there would be a revolution in Paris if it elected "the German Ferry" president of the Republic. Nevertheless his adversaries in parliament, in the press and in the street have been justified—not owing to their superior sagacity, but owing to a series of unexpected events which the most foreseeing statesmen of the world never anticipated. The Indo-China dream of Jules Ferry might have led to a magnificent empire in the East to compensate for that which Duplex lost and Napoleon failed to reconquer.

The Russian alliance, which came at the time when Ferry's policy was justified in the eyes of the public, too late for him to enjoy any credit, gave a new impetus to the French idea of establishing an empire in the Far East. In the opinion of all the prophets of Europe the great international struggle in the near future was to be that of England with Russia for the possession of India. If Russia won, France might have a share in the dismembered Indian empire, of which part of the frontier now marched with that of French Indo-China, since Burma had become British and Tongking French. Such aspirations were not formulated in white-books or in parliamentary speeches. Indeed, the apprehension of difficulty with England limited French ambition on the Siamese frontier. That did not prevent dangerous friction arising between England and France on the question of the Mekong, the river which flows from China almost due south into the China Sea traversing the whole length of French Indo-China, and forming part of the eastern boundary of Upper Burma and Siam. The aim of France was to secure the whole of the left bank of the Mekong, the highway of commerce from southern China. The opposition of Siam to this delimitation was believed by the French to be inspired by England, the supremacy of France on the Mekong river being prejudicial to British commerce with China. The inevitable rivalry between the two powers reached an acute crisis in 1893, the British ambassador in Paris being Lord Dufferin, who well understood the question, upper Burma having been annexed to India under

*Relations
with
England.*

his viceroyalty in 1885. The matter was not settled until 1894, when not only was the French claim to the left bank of the Mekong allowed, but the neutrality of a 25-kilometre zone on the Siamese bank was conceded as open to French trade. It is said that at one moment in July 1893 England and France were more nearly at war than at any other international crisis under the Third Republic, not excluding that of Fashoda, though the acute tension between the governments was unknown to the public.

The Panama affair had left French public opinion in a nervous condition. Fantastic charges were brought not only in the press, but in the chamber of deputies, against newspapers and politicians of having accepted bribes from the British government. At the general election in August and September 1893 M. Clémenceau was pursued into his distant constituency in the Var by a crowd of Parisian politicians, who brought about his defeat less by alleging his connexion with the Panama scandal than by propagating the legend that he was the paid agent of England. The official republic, which changed its prime minister three times and its foreign minister twice in 1893, M. Develle filling that post in the Ribot and Dupuy ministries and M. Casimir-Périer in his own, repudiated with energy the calumnies as to the attempted interference of England in French domestic affairs. But the successive governments were not in a mood to make concessions in foreign questions, as all France was under the glamour of the preliminary manifestations of the Russian alliance. This was seen, a few weeks after the elections, in the wild enthusiasm with which Paris received Admiral Avelane and his officers, who had brought the Russian fleet to Toulon to return the visit of the French fleet to Kronstadt in 1891. The death of Marshal MacMahon, who had won his first renown in the Crimea, and his funeral at the Invalides while the Russians were in Paris, were used to emphasize the fact that the allies before Sebastopol were no longer friends. The projector of the French empire in the Far East did not live to see this phase of the seeming justification of the policy which had cost him place and popularity. Jules Ferry had died on the 17th of March 1893, only three weeks after his triumphant rehabilitation in the political world by his election to the presidency of the Senate, the second post in the state. The year he died it seemed as though with the active aid of Russia and the sympathy of Germany the possessions of France in south-eastern Asia might have indefinitely expanded into southern China. A few years later the defeat of Russia by Japan and the rise of the sea-power of the Japanese practically ended the French empire in Indo-China. What the French already had at the end of the last century is virtually guaranteed to them only by the Anglo-Japanese alliance. It is in the irony of things that these possessions which were a sign of French rivalry with England should now be secured to France by England's friendliness. For it is now recognized by the French that the defence of Indo-China is impossible.

Had the French dream been realized of a large expansion of territory into southern China, the success of the new empire would have been based on free Chinese labour. This might have counterbalanced an initial obstacle to all French colonial schemes, more important than those which arise from international difficulties—the reluctance of the French to establish themselves as serious colonists in their oversea possessions. We have noted how Algeria, which is nearer to Toulon and Marseilles than are Paris and Havre, has been comparatively neglected by the French, after eighty years of occupation, in spite of the amenity of its climate and its soil for European settlers. The new French colonial school advocates the withdrawal of France from adventures in distant tropical countries which can be reached only by long sea voyages, and the concentration of French activity in the northern half of the African continent. Madagascar is, as we have seen, counted as Africa in computing the area of French colonial territory. But it lies entirely outside the scheme of African colonization, and in spite of the loss of life and money incurred in its conquest, its retention is not popular with the new school, although the first claim of France to it was as long ago as the reign of Louis XIII., when in 1642 a company was founded under

the protection of Richelieu for the colonization of the island. The French of the 19th and 20th centuries may well be considered less enterprising in both hemispheres than were their ancestors of the 17th, and Madagascar, after having been the cause of much ill-feeling between England and France under the Third Republic down to the time of its formal annexation, by the law of the 9th of August 1896, is not now the object of much interest among French politicians. On the African continent it is different. When the Republic succeeded to the Second Empire the French African possessions outside Algiers were inconsiderable in area. The chief was Senegal, which though founded as a French station under Louis XIII., was virtually the creation of Faidherbe under the Second Empire, even in a greater degree than were Tunis and Tongking of Jules Ferry under the Third Republic. There was also Gabun, which is now included in French Congo. Those outposts in the tropics became the starting-points for the expansion of a French sphere of influence in north Africa, which by the beginning of the 20th century made France the nominal possessor of a vast territory stretching from the equatorial region on the gulf of Guinea to the Mediterranean. A large portion of it is of no importance, including the once mysterious Timbuktu and the wilds of the waterless Sahara desert. But the steps whereby these wide tracts of wilderness and of valuable territory came to be marked on the maps in French colours, by international agreement, are important, as they were associated with the last serious official dispute between England and France before the period of *entente*. M. Hanotaux, who was foreign minister for the then unprecedented term of four years, from 1894 to 1898, with one short interval of a few months, has thrown an instructive light on the feeling with which French politicians up to the end of the 19th century regarded England. He declared in 1909, with the high authority of one who was during years of Anglo-French tension the mouth-piece of the Republic in its relations with other powers, that every move in the direction of colonial expansion made by France disquieted and irritated England. He complained that when France, under the stimulating guidance of Jules Ferry, undertook the reconstitution of an oversea domain, England barred the way—in Egypt, in Tunis, in Madagascar, in Indo-China, in the Congo, in Oceania. Writing with the knowledge of an ex-foreign minister, who had enjoyed many years of retirement to enable him to weigh his words, M. Hanotaux asserted without any qualification that when he took office England "had conceived a triple design, to assume the position of heir to the Portuguese possessions in Africa, to destroy the independence of the South African republics, and to remain in perpetuity in Egypt." We have not to discuss the truth of those propositions, we have only to note the tendency of French policy; and in so doing it is useful to remark that the official belief of the Third Republic in the last period of the 19th century was that England was the enemy of French colonial expansion all over the globe, and that in the so-called scramble for Africa English ambition was the chief obstacle to the schemes of France. M. Hanotaux, with the authority of official knowledge, indicated that the English project of a railway from the Cape of Good Hope to Cairo was the provocation which stimulated the French to essay a similar adventure; though he denied that the Marchand mission and other similar expeditions about to be mentioned were conceived with the specific object of preventing the accomplishment of the British plan. The explorations of Stanley had demonstrated that access to the Great Lakes and the Upper Nile could be effected as easily from the west coast of Africa as from other directions. The French, from their ancient possession of Gabun, had extended their operations far to the east, and had by treaties with European powers obtained the right bank of the Ubanghi, a great affluent of the Congo, as a frontier between their territory and that of the Congo Independent State. They thus found themselves, with respect to Europe, in possession of a region which approached the valley of the Upper Nile. Between the fall of Jules Ferry in 1885 and the beginning of the Russian alliance came a period

French
and
English
rivalry.

of decreased activity in French colonial expansion. The unpopularity of the Tongking expedition was one of the causes of the popularity of General Boulanger, who diverted the French public from distant enterprises to a contemplation of the German frontier, and when Boulangism came to an end the Panama affair took its place in the interest it excited. But the colonial party in France did not lose sight of the possibility of establishing

Upper Nile exploration. a position on the Upper Nile. The partition of Africa seemed to offer an occasion for France to take compensation for the English occupation of Egypt. In 1892 the Budget Commission, on the proposal of M. Étienne, deputy for Oran, who had three times been colonial under secretary, voted 300,000 francs for the despatch of a mission to explore and report on those regions, which had not had much attention since the days of Emin. But the project was not then carried out. Later, parliament voted a sum six times larger for strengthening the French positions on the Upper Ubanghi and their means of communication with the coast. But Colonel Monteil's expedition, which was the consequence of this vote, was diverted, and the 1,800,000 francs were spent at Loango, the southern port of French Congo, and on the Ivory Coast, the French territory which lies between Liberia and the British Gold Coast Colony, where a prolonged war ensued with Samory, a Nigerian chieftain. In September 1894, M. Delcassé being colonial minister, M. Liotard was appointed commissioner of the Upper Ubanghi with instructions to extend French influence in the Bahr-el-Ghazal up to the Nile. In addition to official missions, numerous expeditions of French explorers took place in Central Africa during this period, and negotiations were continually going on between the British and French governments. Towards the end of 1895 Lord Salisbury, who had succeeded Lord Kimberley at the foreign office, informed Baron de Courcel, the French ambassador, that an expedition to the Upper Nile was projected for the purpose of putting an end to Mahdism. M. Hanotaux was not at this moment minister of foreign affairs. He had been succeeded by M. Berthelot, the eminent chemist, who resigned that office on the 26th of March 1896, a month before the fall of the Bourgeois cabinet of which he was a member, in consequence of a question raised in the chamber on this subject of the English expedition to the Soudan. According to M. Hanotaux, who returned to the Quai d'Orsay, in the Méline ministry, on the 29th of April 1896, Lord Salisbury at the end of the previous year, in announcing the expedition confidentially to M. de Courcel, had assured him that it would not go beyond Dongola without a preliminary understanding with France. There must have been a misunderstanding on this point, as after reaching Dongola in September 1896 the Anglo-Egyptian army proceeded up the Nile in the direction of Khartoum. Before M. Hanotaux resumed office the Marchand mission had been formally

Marchand mission.

planned. On the 24th of February 1896 M. Guieysse, colonial minister in the Bourgeois ministry, had signed Captain Marchand's instructions to the effect that he must march through the Upper Ubanghi, in order to extend French influence as far as the Nile, and try to reach that river before Colonel Colville, who was leading an expedition from the East. He was also advised to conciliate the Mahdi if the aim of the mission could be benefited thereby. M. Liotard was raised to the rank of governor of the Upper Ubanghi, and in a despatch to him the new colonial minister, M. André Lebon, wrote that the Marchand mission was not to be considered a military enterprise, it being sent out with the intention of maintaining the political line which for two years M. Liotard had persistently been following, and of which the establishment of France in the basin of the Nile ought to be the crowning reward. Two days later, on the 25th of June 1896, Captain Marchand embarked for Africa. This is not the place for a description of his adventures in crossing the continent or when

Fashoda.

he encountered General Kitchener at Fashoda, two months after his arrival there in July 1898 and a fortnight after the battle of Omdurman and the capture of Khartoum. The news was made known to Europe by the

sirdar's telegrams to the British government in September announcing the presence of the French mission at Fashoda. Then ensued a period of acute tension between the French and English governments, which gave the impression to the public that war between the two countries was inevitable. But those who were watching the situation in France on the spot knew that there was no question of fighting. France was unprepared, and was also involved in the toils of the Dreyfus affair. Had the situation been that of a year later, when the French domestic controversy was ending and the Transvaal War beginning, England might have been in a very difficult position. General Kitchener declined to recognize a French occupation of any part of the Nile valley. A long discussion ensued between the British and French governments, which was ended by the latter deciding on the 6th of November 1898 not to maintain the Marchand mission at Fashoda. Captain Marchand refused to return to Europe by way of the Nile and Lower Egypt, marching across Abyssinia to Jibuti in French Somaliland, where he embarked for France. He was received with well-merited enthusiasm in Paris. But the most remarkable feature of his reception was that the ministry became so alarmed lest the popularity of the hero of Fashoda should be at the expense of that of the parliamentary republic, that it put an end to the public acclamations by despatching him secretly from the capital—a somewhat similar treatment having been accorded to General Dodds in 1893 on his return to France after conquering Dahomey. The Marchand mission had little effect on African questions at issue between France and Great Britain, as a great settlement had been effected while it was on its way across the continent. On the 14th of June 1898, the day before the fall of the Méline ministry, when M. Hanotaux finally quitted the Quai d'Orsay, a convention of general delimitation was signed at Paris by that minister and by the British ambassador, Sir Edmund Monson, which as regards the respective claims of England and France covered in its scope the whole of the northern half of Africa from Senegambia and the Congo to the valley of the Nile. Comparatively little attention was paid to it amid the exciting events which followed, so little that M. de Courcel has officially recorded that three months later, on the eve of the Fashoda incident, Lord Salisbury declared to him that he was not sufficiently acquainted with the geography of Africa to express an opinion on certain questions of delimitation arising out of the success of the British expedition on the Upper Nile. The convention of June 1898 was, however, of the highest importance, as it affirmed the junction into one vast territory of the three chief African domains of France, Algeria and Tunis, Senegal and the Niger, Chad and the Congo, thus conceding to France the whole of the north-western continent with the exception of Morocco, Liberia and the European colonies on the Atlantic. This arrangement, which was completed by an additional convention on the 21st of March 1899, made Morocco a legitimate object of French ambition.

The other questions which caused mutual animosity between England and France in the decline of the 19th century had nothing whatever to do with their conflicting international interests. The offensive attitude of the English press towards France on account of the Dreyfus affair was repaid by the French in their criticism of the Boer War. When those sentimental causes of mutual irritation had become less acute, the press of the two countries was moved by certain influences to recognize that it was in their interest to be on good terms with one another. The importance of their commercial relations was brought into relief as though it were a new fact. At last in 1903 state visits between the rulers of England and of France took place in their respective capitals, for the first time since the early days of the Second Empire, followed by an Anglo-French convention signed on the 8th of April 1904. By this an arrangement was come to on outstanding questions of controversy between England and France in various parts of the world. France undertook not to interfere with the action of England in Egypt,

Convention of 1898.

The entente with England.

while England made a like undertaking as to French influence in Morocco. France conceded certain of its fishing rights in Newfoundland which had been a perpetual source of irritation between the two countries for nearly two hundred years since the treaty of Utrecht of 1713. In return England made several concessions to France in Africa, including that of the Los Islands off Sierra Leone and some rectifications of frontier on the Gambia and between the Niger and Lake Chad. Other points of difference were arranged as to Siam, the New Hebrides and Madagascar. The convention of 1904 was on the whole more advantageous for England than for France. The free hand which England conceded to France in dealing with Morocco was a somewhat burdensome gift owing to German interference; but the incidents which arose from the Franco-German conflict in that country are as yet too recent for any estimate of their possible consequences.

One result was the retirement of M. Delcassé from the foreign office on the 6th of June 1905. He had been foreign minister for seven years, a consecutive period of rare length, only once exceeded in England since the creation of the office, when Castlereagh held it for ten years, and one of prodigious duration in the history of the

Third Republic. He first went to the Quai d'Orsay in the Brisson ministry of June 1898, remained there during the Dupuy ministry of the same year, was reappointed by M. Waldeck-Rousseau in his cabinet which lasted from June 1899 to June 1902, was retained in the post by M. Combes till his ministry fell in January 1905, and again by his successor M. Rouvier till his own resignation in June of that year. M. Delcassé had thus an uninterrupted reign at the foreign office during a long critical period of transition both in the interior politics of France and in its exterior relations. He went to the Quai d'Orsay when the Dreyfus agitation was most acute, and left it when parliament was absorbed in discussing the separation of church and state. He saw the Franco-Russian alliance lose its popularity in the country even before the Russian defeat by the Japanese in the last days of his ministry. Although in the course of his official duties at the colonial office he had been partly responsible for some of the expeditions sent to Africa for the purpose of checking British influence, he was fully disposed to pursue a policy which might lead to a friendly understanding with England. In this he differed from M. Hanotaux, who was essentially the man of the Franco-Russian alliance, owing to it much of his prestige, including his election to the French Academy, and Russia, to which he gave exclusive allegiance, was then deemed to be primarily the enemy of England. M. Delcassé on the contrary, from the first, desired to assist a *rapprochement* between England and Russia as preliminary to the arrangement he proposed between England and France. He was foreign minister when the tsar paid his second visit to France, but there was no longer the national unanimity which welcomed him in 1896. M. Delcassé also accompanied President Loubet to Russia when he returned the tsar's second visit in 1902. But exchange of compliments between France and Russia were no longer to be the sole international ceremonials within the attributes of the French foreign office; M. Delcassé was minister when the procession of European sovereigns headed by the kings of England and of Italy in 1903 came officially to Paris, and he went with M. Loubet to London and to Rome on the president's return visits to those capitals—the latter being the immediate cause of the rupture of the concordat with the Vatican, though M. Delcassé was essentially a concordatory minister. His retirement from the Rouvier ministry in June 1905 was due to pressure from Germany in consequence of his opposition to German interference in Morocco. His resignation took place just a week after the news had arrived of the destruction of the Russian fleet by the Japanese, which completed the disablement of the one ally of France. The impression was current in France that Germany wished to give the French nation a fright before the understanding with England had reached an effective stage, and it was actually believed that the resignation of M. Delcassé averted a declaration of war. Although that belief revived to some extent the fading enmity

of the French towards the conquerors of Alsace-Lorraine, the fear which accompanied it moved a considerable section of the nation to favour an understanding with Germany in preference to, or even at the expense of, friendly relations with England. M. Clémenceau, who only late in life came into office, and attained it at the moment when a better understanding with England was progressing, had been throughout his long career, of all French public men in all political groups, the most consistent friend of England. His presence at the head of affairs was a guarantee of amicable Anglo-French relations, so far as they could be protected by statesmanship.

By reason of the increased duration and stability of ministries, the personal influence of ministers in directing the foreign policy of France has in one sense become greater in the 20th century than in those earlier periods when France had first to recuperate its strength after the war and then to take its exterior policy from Germany. Moreover, not only have cabinets lasted longer, but the foreign minister has often been retained in a succession of them. Of the thirty years which in 1909 had elapsed since Marshal MacMahon retired and the republic was governed by republicans, in the first fifteen years from 1879 to 1894 fourteen different persons held the office of minister of foreign affairs, while six sufficed for the fifteen years succeeding the latter date. One must not, however, exaggerate the effect of this greater stability in office-holding upon continuity of policy, which was well maintained even in the days when there was on an average a new foreign minister every year. Indeed the most marked breach in the continuity of the foreign policy of France has been made in that later period of long terms of office, which, with the repudiation of the Concordat, has seen the withdrawal of the French protectorate over Roman Catholic missions in the East—though it is too soon to estimate the result. In another respect France has under the republic departed a long way from a tradition of the Quai d'Orsay. It no longer troubles itself on the subject of nationalities. Napoleon III., who had more French temperament than French blood in his constitution, was an idealist on this question, and one of the causes of his own downfall and the defeat of France was his sympathy in this direction with German unity. Since Sedan little has been done in France to further the doctrine of nationalities. A faint echo of it was heard during the Boer war, but French sympathy with the struggling Dutch republics of South Africa was based rather on anti-English sentiment than on any abstract theory. (J. E. C. B.)

BIBLIOGRAPHY OF FRENCH HISTORY.—The scientific study of the history of France only begins with the 16th century. It was hampered at first by the traditions of the middle ages and by a servile imitation of antiquity. Paulus Aemilius Verona (*De rebus gestis Francorum*, 1517), who may be called the first of modern historians, merely applies the oratorical methods of the Latin historiographers. It is not till the second half of the century that history emancipates itself; Catholics and Protestants alike turn to it for arguments in their religious and political controversies. François Hotman published (1574) his *Franco-Gallia*; Claude Fauchet his *Antiquités gauloises et françoises* (1579); Étienne Pasquier his *Recherches de la France* (1611), "the only work of erudition of the 16th century which one can read through without being bored." Amateurs like Petau, A. de Thou, Bongars and Peiresc collected libraries to which men of learning went to draw their knowledge of the past; Pierre Pithou, one of the authors of the *Satire Ménippée*, published the earliest annals of France (*Annales Francorum*, 1588, and *Historiae Francorum scriptores coelanei XI.*, 1596); Jacques Bongars collected in his *Gesta Dei per Francos* (1611–1617) the principal chroniclers of the Crusades. Others made a study of chronology like J. J. Scaliger (*De emendatione temporum*, 1583; *Thesaurus temporum*, 1606), sketched the history of literature, like François Grudé, sieur of La Croix in Maine (*Bibliothèque françoise*, 1584), and Antoine du Verdier (*Catalogue de tous les auteurs qui ont écrit ou traduit en françois*, 1585), or discussed the actual principles of historical research, like Jean Bodin (*Methodus ad facilem historiarum cognitionem*, 1566) and Henri Lancelot Voisin de La Popelinière (*Histoire des histoires*, 1599).

But the writers of history are as yet very inexpert; the *Histoire générale des rois de France* of Bernard de Girard, seigneur de Hailan (1576), the *Grandes Annales de France* of François de Belleforest (1579), the *Inventaire général de l'histoire de France* of Jean de Serres (1597), the *Histoire générale de France depuis Pharamond ou Scipion Duplex* (1621–1645), the *Histoire de France* (1643–1651) of François Eudes de Mézeray, and above all his *Abrégé chronologique de l'histoire*

de France (1668), are compilations which were eagerly read when they appeared, but are worthless nowadays. Historical research lacked method, leaders and trained workers; it found them all in the 17th century, the golden age of learning which was honoured alike by laymen, priests and members of the monastic orders, especially the Benedictines of the congregation of St Maur. The publication of original documents was carried on with enthusiasm. To André Duchesne we owe two great collections of chronicles: the *Historiae Normannorum scriptores antiqui* (1619) and the *Historiae Francorum scriptores*, continued by his son François (5 vols., 1636-1649). These publications were due to a part only of his prodigious activity; his papers and manuscripts, preserved in the Bibliothèque Nationale at Paris, are an inexhaustible mine. Charles du Fresne, seigneur du Cange, published Villehardouin (1657) and Joinville (1668); Étienne Baluze, the *Capitularia regum Francorum* (1674), the *Nova collectio conciliorum* (1677), the *Vitae paparum Avenionensium* (1693). The clergy were very much aided in their work by their private libraries and by their co-operation; Père Philippe Labbe published his *Bibliotheca nova manuscriptorum* (1657), and began (1671) his *Collection des conciles*, which was successfully completed by his colleague Père Cossart (18 vols.). In 1643 the Jesuit Jean Bolland brought out vol. i. of the *Acta sanctorum*, a vast collection of stories and legends which has not yet been completed beyond the 4th of November. (See BOLLANDISTS.) The Benedictines, for their part, published the *Acta sanctorum ordinis sancti Benedicti* (9 vols., 1668-1701). One of the chief editors of this collection, Dom Jean Mabillon, published on his own account the *Vetera analecta* (4 vols., 1675-1685) and prepared the *Annales ordinis sancti Benedicti* (6 vols., 1703-1793). To Dom Thierry Ruinart we owe good editions of Gregory of Tours and Fredegarius (1699). The learning of the 17th century further inaugurated those specialized studies which are important aids to history. Mabillon in his *De re diplomatica* (1681) creates the science of documents or diplomatics. Adrien de Valois lays a sound foundation for historical geography by his critical edition of the *Notitia Galliarum* (1675). Numismatics finds an enlightened pioneer in François Leblanc (*Traité historique des monnaies de France*, 1690). Du Cange, one of the greatest of the French scholars who have studied the middle ages, has defined terms bearing on institutions in his *Glossarium mediae et infimae latinitatis* (1678), recast by the Benedictines (1733), with an important supplement by Dom Carpentier (1768), republished twice during the 19th century, with additions, by F. Didot (1840-1850), and by L. Favre at Niort (1883-1888); this work is still indispensable to every student of medieval history. Finally, great biographical or bibliographical works were undertaken; the *Gallia christiana*, which gave a chronological list of the archbishops, bishops and abbots of the Gauls and of France, was compiled by two twin brothers, Scévole and Louis de Sainte-Marthe, and by the two sons of Louis (4 vols., 1656); a fresh edition, on a better plan, and with great additions, was begun in 1715 by Denys de Sainte-Marthe, continued throughout the 18th century by the Benedictines, and finished in the 19th century by Barthélemy Hauréau (1856-1861).

As to the nobility, a series of researches and publications, begun by Pierre d'Hozier (d. 1660) and continued well on into the 19th century by several of his descendants, developed into the *Armorial général de la France*, which was remodelled several times. A similar work, of a more critical nature, was carried out by Père Anselme (*Histoire généalogique de la maison de France et des grands officiers de la couronne*, 1674) and by Père Ange and Père Simplicien, who completed the work (3rd ed. in 9 vols., 1726-1733). Critical bibliography is especially represented by certain Protestants, expelled from France by the revocation of the Edict of Nantes. Pierre Bayle, the sceptic, famous for his *Dictionnaire critique* (1699), which is in part a refutation of the *Dictionnaire historique et géographique* published in 1673 by the Abbé Louis Moréri, was the first to publish the *Nouvelles de la république des lettres* (1684-1687), which was continued by Henri Basnage de Beauval under the title of *Histoire des ouvrages des savants* (24 vols.). In imitation of this, Jean Le Clerc successively edited a *Bibliothèque universelle et historique* (1686-1693), a *Bibliothèque choisie* (1703-1713), and a *Bibliothèque ancienne et moderne* (1714-1727). These were the first of our "periodicals."

The 18th century continues the traditions of the 17th. The Benedictines still for some time hold the first place. Dom Edmond Martène visited numerous archives (which were then closed) in France and neighbouring countries, and drew from them the material for two important collections: *Thesaurus novus anecdotorum* (9 vols., 1717, in collaboration with Dom Ursin Durand) and *Veterum scriptorum collectio* (9 vols., 1724-1733). Dom Bernard de Montfaucon also travelled in search of illustrated records of antiquity; private collections, among others the celebrated collection of Gaignières (now in the Bibliothèque Nationale), provided him with the illustrations which he published in his *Monuments de la monarchie française* (5 vols., 1729-1733). The text is in two languages, Latin and French. Dom Martin Bouquet took up the work begun by the two Duchesnes, and in 1738 published vol. i. of the *Historians of France* (*Rerum Gallicarum et Francicarum scriptores*), an enormous collection which was intended to include all the sources of the history of France, grouped under centuries and reigns. He produced the first eight volumes himself; his work was continued by several

collaborators, the most active of whom was Dom Michel J. Brial, and already comprised thirteen volumes when it was interrupted by the Revolution. In 1733, Antoine Rivet de La Grange produced vol. i. of the *Histoire littéraire de la France*, which in 1789 numbered twelve volumes. While Dom C. François Toussaint and Dom René Prosper Tassin published a *Nouveau Traité de diplomatique* (6 vols., 1750-1765), others were undertaking the *Art de vérifier les dates* (1750; new and much enlarged edition in 1770). Still others, with more or less success, attempted histories of the provinces.

In the second half of the 18th century, the ardour of the Benedictines of St Maur diminished, and scientific work passed more and more into the hands of laymen. The Académie des Inscriptions et Belles-lettres, founded in 1663 and reorganized in 1701, became its chief instrument, numbering among its members Denis François Secousse, who continued the collection of *Ordonnances des rois de France*, begun (1723) by J. de Laurière; J.-B. de La Curne de Sainte Palaye (*Mémoires sur l'ancienne chevalerie*, 1759-1781; *Glossaire de la langue française depuis son origine jusqu'à la fin de Louis XIV.*, printed only in 1875-1882); J.-B. d'Anville (*Notice sur l'ancienne Gaule tirée des monuments*, 1760); and L. G. de Bréquigny, the greatest of them all, who continued the publication of the *Ordonnances*, began the *Table chronologique des diplômes concernant l'histoire de France* (3 vols., 1769-1783), published the *Diplomata, chartae, ad res Francicas spectantia* (1791, with the collaboration of La Porte du Theil), and directed fruitful researches in the archives in London, to enrich the *Cabinet des chartes*, where Henri Bertin (1719-1792), an enlightened minister of Louis XV., had in 1764 set himself the task of collecting the documentary sources of the national history. The example set by the religious orders and the government bore fruit. The general assembly of the clergy gave orders that its *Procès verbaux* (9 vols., 1767-1789) should be printed; some of the provinces decided to have their history written, and mostly applied to the Benedictines to have this done. Brittany was treated by Dom Lobineau (1707) and Dom Morice (1742); the duchy of Burgundy by Dom Urbain Plancher (1739-1748); Languedoc by Dom Dominique Vaissète (1730-1749, in collaboration with Dom Claude de Vic; new ed. 1873-1893); for Paris, its secular history was treated by Dom Michel Félibien and Dom Lobineau (1725), and its ecclesiastical history by the abbé Lebeuf (1745-1760; new ed. 1883-1890).

This ever-increasing stream of new evidence aroused curiosity, gave rise to pregnant comparisons, developed and sharpened the critical sense, but further led to a more and more urgent need for exact information. The Académie des Inscriptions brought out its *Histoire de l'Académie avec les mémoires de littérature tirés de ses registres* (vol. i. 1717; 51 vols. appeared before the Revolution, with five indexes; vide the *Bibliographie* of Lasteyrie, vol. iii. pp. 256 et seq.). Other collections, mostly of the nature of bibliographies, were the *Journal des savants* (111 vols., from 1665 to 1792; vide the *Table méthodique* by H. Cocheris, 1860); the *Journal de Trévoux*, or *Mémoires pour l'histoire des sciences et des beaux-arts*, edited by Jesuits (265 vols., 1701-1790); the *Mercur de France* (977 vols., from 1724 to 1791). To these must be added the dictionaries and encyclopaedias: the *Dictionnaire de Moréri*, the last edition of which numbers 10 vols. (1759); the *Dictionnaire géographique, historique et politique des Gaules et de la France*, by the abbé J. J. Expilly (6 vols., 1762-1770; unfinished); the *Répertoire universel et raisonné de jurisprudence civile, criminelle, canonique et bénéficiale*, by Guyot (64 vols., 1775-1786; supplement in 17 vols., 1784-1785), reorganized and continued by Merlin de Douai, who was afterwards one of the *Montagnards*, a member of the Directory, and a count under the Empire.

The historians did not use to the greatest advantage the treasures of learning provided for them; they were for the most part superficial, and dominated by their political or religious prejudices. Thus works like that of Père Gabriel Daniel (*Histoire de France*, 3 vols., 1713), of Président Hénault (*Abrégé chronologique*, 1744; 25 editions between 1770 and 1834), of the abbé Paul François Velly and those who completed his work (*Histoire de France*, 33 vols., 1765 to 1783), of G. H. Gaillard (*Histoire de la rivalité de la France et de l'Angleterre*, 11 vols., 1771-1777), and of L. P. Anquetil (1805), in spite of the brilliant success with which they met at first, have fallen into a just oblivion. A separate place must be given to the works of the theorists and philosophers: *Histoire de l'ancien gouvernement de la France*, by the Comte de Boulainvilliers (1727), *Histoire critique de l'établissement de la monarchie française dans les deux Gaules*, by the abbé J. B. Dubos (1734); *L'Esprit des lois*, by the président de Montesquieu (1748); the *Observations sur l'histoire de France*, by the abbé de Mably (1765); the *Théorie de la politique de la monarchie française*, by Marie Pauline de Lézardière (1792). These works have, if nothing else, the merit of provoking reflection.

At the time of the Revolution this activity was checked. The religious communities and royal academies were suppressed, and France violently broke with even her most recent past, which was considered to belong to the *ancien régime*. When peace was re-established, she began the task of making good the damage which had been done, but a greater effort was now necessary in order to revive the spirit of the institutions which had been overthrown. The new state, which was, in spite of all, bound by so many ties to the former order of things, seconded this effort, and during the

whole of the 19th century, and even longer, had a strong influence on historical production. The section of the Institut de France, which in 1816 assumed the old name of Académie des Inscriptions et Belles-lettres, began to reissue the two series of the *Mémoires* and of the *Notices et extraits des manuscrits tirés de la bibliothèque royale* (the first volume had appeared in 1787); began (1844) that of the *Mémoires présentés par divers savants* and the *Comptes rendus* (subject index 1857-1900, by G. Ledos, 1906); and continued the *Recueil des historiens de France*, the plan of which was enlarged by degrees (*Historiens des croisades, obituaires, pouillés, comptes, &c.*), the *Ordonnances* and the *Table chronologique des diplômes*. During the reign of Louis Philippe, the ministry of the interior reorganized the administration of the archives of the departments, communes and hospitals, of which the *Inventaires sommaires* are a mine of precious information (see the *Rapport au ministre*, by G. Servois, 1902). In 1834 the ministry of public instruction founded a committee, which has been called since 1881 the Comité des Travaux historiques et scientifiques, under the direction of which have been published: (1) the *Collection des documents inédits relatifs à l'histoire de France* (more than 260 vols. have appeared since 1836); (2) the *Catalogue général des manuscrits des bibliothèques de France*; (3) the *Dictionnaires topographiques* (25 vols. have appeared); and the *Répertoires archéologiques* of the French departments (8 vols. between 1861 and 1888); (4) several series of *Bulletins*, the details of which will be found in the *Bibliographie de Lasteurie*. At the same time were founded or reorganized, both in Paris and the departments, numerous societies, devoted sometimes partially and sometimes exclusively to history and archaeology; the Académie Celtique (1804), which in 1813 became the Société des Antiquaires de France (general index by M. Prou, 1894); the Société de l'histoire de France (1834); the Société de l'École des Chartes (1839); the Société de l'histoire de Paris et de l'Île-de-France (1874; four decennial indexes), &c. The details will be found in the excellent *Bibliographie générale des travaux historiques et archéologiques publiés par les sociétés savantes de France*, which has appeared since 1885 under the direction of Robert de Lasteurie.

Individual scholars also associated themselves with this great literary movement. Guizot published a *Collection de mémoires relatifs à l'histoire de France* (31 vols., 1824-1835); Buchon, a *Collection des chroniques nationales françaises écrites en langue vulgaire du XIII^e au XVI^e siècle* (47 vols., 1824-1829), and a *Choix de chroniques et mémoires sur l'histoire de France* (14 vols., 1836-1841); Petitot and Monmerqué, a *Collection de mémoires relatifs à l'histoire de France* (131 vols., 1819-1829); Michaud and Poujoulat, a *Nouvelle Collection de mémoires pour servir à l'histoire de France* (32 vols., 1836-1839); Barrière and de Lescure, a *Bibliothèque de mémoires relatifs à l'histoire de France pendant le XVIII^e siècle* (30 vols., 1855-1875); and finally Berville and Barrière, a *Collection des mémoires relatifs à la Révolution Française* (55 vols., 1820-1827). The details are to be found in the *Sources de l'histoire de France*, by Alfred Franklin (1876). The abbé J. P. Migne in his *Patrologia Latina* (221 vols., 1844-1864), re-edited a number of texts anterior to the 13th century. Under the second empire, the administration of the imperial archives at Paris published ten volumes of documents (*Monuments historiques*, 1866; *Layettes du trésor des chartes*, 1863, which were afterwards continued up to 1270; *Actes du parlement de Paris*, 1863-1867), not to mention several volumes of *Inventaires*. The administration of the Bibliothèque impériale had printed the *Catalogue général de l'histoire de France* (10 vols., 1855-1870; vol. xi., containing the alphabetical index to the names of the authors, appeared in 1895). Other countries also supplied a number of useful texts; there is much in the English Rolls series, in the collection of *Chroniques belges*, and especially in the *Monumenta Germaniae historica*.

At the same time the scope of history and its auxiliary sciences becomes more clearly defined; the École des Chartes produces some excellent palaeographers, as for instance Natalis de Wailly (*Éléments de paléographie*, 1838), and L. Delisle (*q.v.*), who has also left traces of his profound researches in the most varied departments of medieval history (*Bibliographie des travaux de M. Léopold Delisle*, 1902); Anatole de Barthélemy made a study of coins and medals, Douët d'Arcq and G. Demay of seals. The works of Alexandre Lenoir (*Musée des monuments français*, 1800-1822), of Arcisse de Caumont (*Histoire de l'architecture du moyen âge*, 1837; *Abécédaire ou rudiment d'archéologie*, 1850), of A. Napoléon Didron (*Annales archéologiques*, 1844), of Jules Quicherat (*Mélanges d'archéologie et d'histoire*, published after his death, 1886), and the dictionaries of Viollet le Duc (*Dictionnaire raisonné de l'architecture française*, 1853-1868; *Dictionnaire du mobilier français*, 1855) displayed to the best advantage one of the most brilliant sides of the French intellect, while other sciences, such as geology, anthropology, the comparative study of languages, religions and folk-lore, and political economy, continued to enlarge the horizon of history. The task of writing the general history of a country became more and more difficult, especially for one man, but the task was none the less undertaken by several historians, and by some of eminence. François Guizot treated of the *Histoire de la civilisation en France* (1828-1830); Augustin Thierry after the *Récits des temps mérovingiens* (1840) published the *Monuments de l'histoire du tiers état* (1849-1856), the introduction to which was expanded into a book (1855); Charles Simonde

de Sismondi produced a mediocre *Histoire des français* in 31 vols. (1821-1844), and Henri Martin a *Histoire de France* in 16 vols. (1847-1854), now of small use except for the two or three last centuries of the ancien régime. Finally J. Michelet, in his *Histoire de France* (17 vols., 1833-1856) and his *Histoire de la Révolution* (7 vols., 1847-1853), aims at reviving the very soul of the nation's past.

After the Franco-German War begins a better organization of scientific studies, modelled on that of Germany. The École des Hautes Études, established in 1868, included in its programme the critical study of the sources, both Latin and French, of the history of France; and from the séminaire of Gabriel Monod came men of learning, already prepared by studying at the École des Chartes; Paul Viollet, who revived the study of the history of French law; Julien Havet, who revived that of Merovingian diplomatics; Arthur Giry, who resumed the study of municipal institutions where it had been left by A. Thierry, prepared the *Annales carolingiennes* (written by his pupils, Eckel, Favre, Lauer, Lot, Poupardin), and brought back into honour the study of diplomatics (*Manuel de diplomatique*, 1894); Auguste Molinier, author of the *Sources de l'histoire de France* (1902-1904; general index, 1906), &c. Auguste Longnon introduced at the École des Hautes Études the study of historical geography (*Atlas historique de la France*, in course of publication since 1888). The universities, at last reorganized, popularized the employment of the new methods. The books of Fustel de Coulanges and Achille Luchaire on the middle ages, and those of A. Aulard on the revolution, gave a strong, though well-regulated, impetus to historical production. The École du Louvre (1881) increased the value of the museums and placed the history of art among the studies of higher education, while the Musée archéologique of St-Germain-en-Laye offered a fruitful field for research on Gallic and Gallo-Roman antiquities. Rich archives, hitherto inaccessible, were thrown open to students; at Rome those of the Vatican (*Registres pontificaux*, published by students at the French school of archaeology, since 1884); at Paris, those of the Foreign Office (*Recueil des instructions données aux ambassadeurs depuis le traité de Westphalie*, 16 vols., 1885-1901; besides various collections of diplomatic papers, inventories, &c.). Those of the War Office were used by officers who published numerous documents bearing on the wars of the Revolution and the Empire, and on that of 1870-1871). In 1904 a commission, generously endowed by the French parlement, was entrusted with the task of publishing the documents relating to economic and social life of the time of the Revolution, and four volumes had appeared by 1908. Certain towns, Paris, Bordeaux, &c., have made it a point of honour to have their chief historical monuments printed. The work now becomes more and more specialized. *L'Histoire de France*, by Ernest Lavisse (1900, &c.), is the work of fifteen different authors. It is therefore more than ever necessary that the work should be under sound direction. The *Manuel de bibliographie historique* of Ch. V. Langlois (2nd edition, 1901-1904) is a good guide, as is his *Archives de l'histoire de France* (1891, in collaboration with H. Stein).

Besides the special bibliographies mentioned above, it will be useful to consult the *Bibliothèque historique* of Père Jacques Lelong (1719; new ed. by Fevret de Fontette, 5 vols., 1768-1778); the *Geschichte der historischen Forschung und Kunst* of Ludwig Wachler (2 vols., 1812-1816); the *Bibliographie de la France*, established in 1811 (1st series, 1811-1856, 45 vols.; 2nd series, 1 vol. per annum since 1857); the publications of the Société de Bibliographie (*Polybiblion*, from 1868 on, &c.); the *Bibliographie de l'histoire de France*, by Gabriel Monod (1888); the *Répertoire* of the abbé Ulysse Chevalier (*Biobibliographie*; new ed. 1903-1907; and *Topobibliographie*, 1894-1899). Bearing exclusively on the middle ages are the *Bibliotheca historica medii aevi* of August Potthast (new ed. 1896) and the *Manuel (Les Sources de l'histoire de France*, 1901, &c.) of A. Molinier; but the latter is to be continued up to modern times, the 16th century having already been begun by Henri Hauser (1st part, 1906). Finally, various special reviews, besides teaching historical method by criticism and by example, try to keep their readers au courant with literary production; the *Revue critique d'histoire et de littérature* (1866 fol.), the *Revue des questions historiques* (1866 fol.), the *Revue historique* (1876 fol.), the *Revue d'histoire moderne et contemporaine*, accompanied annually by a valuable *Répertoire méthodique* (1898 fol.); the *Revue de synthèse historique* (1900 fol.), &c. (C. B.)*

FRENCH LAW AND INSTITUTIONS

Celtic Period.—The remotest times to which history gives us access with reference to the law and institutions formerly existing in the country which is now called France are those in which the dominant race at least was Celtic. On the whole, our knowledge is small of the law and institutions of these Celts, or Gauls, whose tribes constituted independent Gaul. For their reconstruction, modern scholars draw upon two sources; firstly, there is the information furnished by the classical writers and by Caesar and Strabo in particular, which is trustworthy but somewhat scanty; the other source, which is not so pure, consists in

the accounts found in those legal works of the middle ages written in the neo-Celtic dialects, the most important and the greater number of which belong to Ireland. A reconstruction from them is always hazardous, however delicate and scientific be the criticism which is brought to bear on it, as in the case of d'Arbois de Jubainville, for example. Moreover, in the historical evolution of French institutions those of the Celts or Gauls are of little importance. Not one of them can be shown to have survived in later law. What has survived of the Celtic race is the blood and temperament, still found in a great many Frenchmen, certain traits which the ancients remarked in the Gauls being still recognizable: *bellum gerere et argute loqui*.

Roman Period.—It was the Roman conquest and rule which really formed Gaul, for she was Romanized to the point of losing almost completely that which persists most stubbornly in a conquered nation, namely, the language; the Breton-speaking population came to France later, from Britain. The institutions of Roman Gaul became identical with those of the Roman empire, provincial and municipal government undergoing the same evolution as in the other parts of the empire. It was under Roman supremacy too, as M. d'Arbois de Jubainville has shown, that the ownership of land became personal and free in Gaul. The law for the Gallo-Romans was that which was administered by the *conventus* of the magistrate; there are only a few peculiarities, mere Gallicisms, resulting from conventions or usage, which are pointed out by Roman juriconsults of the classical age. The administrative reforms of Diocletian and Constantine applied to Gaul as to the rest of the empire. Gaul under this rule consisted of seventeen provinces, divided between two dioceses, ten in the diocese of the Gauls, under the authority of the praetorian prefect, who resided at Treves; and the other seven in the *diocesis septem provinciarum*, under the authority of a *vicarius*. The Gallo-Romans became Christian with the other subjects of the empire; the Church extended thither her powerful organization modelled on the administrative organization, each *civitas* having a bishop, just as it had a *curia* and municipal magistrates. But, although endowed with privileges by the Christian emperors, the Church did not yet encroach upon the civil power. She had the right of acquiring property, of holding councils, subject to the imperial authority, and of the free election of bishops. But only the first germs of ecclesiastical jurisdiction are to be traced. In virtue of the laws, the bishops were privileged arbitrators, and in the matter of public sins exercised a disciplinary jurisdiction over the clergy and the faithful. In the second half of the 4th century, monasteries appeared in Gaul. After the fall of the Western empire; there was left to the Gallo-Romans as an expression of its law, which was also theirs, a written legislation. It consisted of the imperial constitutions, contained in the Gregorian, Hermogenian and Theodosian codes (the two former being private compilations, and the third an official collection), and the writings of the five jurists (Gaius, Papinian, Paulus, Ulpian and Modestinus), to which Valentinian III. had in 426 given the force of law.

The Barbarian Invasion.—The invasions and settlements of the barbarians open a new period. Though there were robbery and violence in every case, the various barbarian kingdoms set up in Gaul were established under different conditions. In those of the Burgundians and Visigoths, the owners of the great estates, which had been the prevailing form of landed property in Roman Gaul, suffered partial dispossession, according to a system the rules regulating which can, in the case of the Burgundians, be traced almost exactly. It is doubtful whether a similar process took place in the case of the Frankish settlements, but their first conquests in the north and east seem to have led to the extermination or total expulsion of the Gallo-Roman population. It is impossible to say to what extent, in these various settlements, the system of collective property prevailing among the Germanic tribes was adopted. Another important difference was that, in embracing Christianity, some of the barbarians became Arians, as in the case of the Visigoths and Burgundians; others Catholic, as in the case of the Franks. This was probably the main cause of the absorption of the other

kingdoms into the Frankish monarchy. In each case, however, the barbarian king appeared as wishing not to overthrow the Roman administration, but to profit by its continuation. The kings of the Visigoths and Burgundians were at first actually representatives of the Western empire, and Clovis himself was ready to accept from the emperor Anastasius the title of consul; but these were but empty forms, similar to the fictitious ties which long existed or still exist between China or Turkey and certain parts of their former empires, now separated from them for ever.

As soon as the Merovingian monarch had made himself master of Gaul, he set himself to maintain and keep in working order the administrative machinery of the Romans, save that the administrative unit was henceforth no longer the *provincia* but the *civitas*, which generally took the name of *pagus*, and was placed under the authority of a count, *comes* or *grafio* (*Graf*). Perhaps this was not entirely an innovation, for it appears that at the end of the Roman supremacy certain *civitates* had already a *comes*. Further, several *pagi* could be united under the authority of a *dux*. The *pagus* seems to have generally been divided into hundreds (*centenae*).

But the Roman administrative machinery was too delicate to be handled by barbarians; it could not survive for long, but underwent changes and finally disappeared. Thus the Merovingians tried to levy the same direct taxes as the Romans had done, the *capitatio terrena* and the *capitatio humana*, but they ceased to be imposts reassessed periodically in accordance with the total sum fixed as necessary to meet the needs of the state, and became fixed annual taxes on lands or persons; finally, they disappeared as general imposts, continuing to exist only as personal or territorial dues. In the same way the Roman municipal organization, that of the *curiae*, survived for a considerable time under the Merovingians, but was used only for the registration of written deeds; under the Carolingians it disappeared, and with it the old senatorial nobility which had been that of the Empire. The administration of justice (apart from the king's tribunal) seems to have been organized on a system borrowed partly from Roman and partly from Germanic institutions; it naturally tends to assume popular forms. Justice is administered by the count (*comes*) or his deputy (*centenarius* or *vicarius*), but on the verdict of notables called in the texts *boni homines* or *rachimburgii*. This takes place in an assembly of all the free subjects, called *mallus*, at which every free man is bound to attend at least a certain number of times a year, and in which are promulgated the general acts emanating from the king. The latter could issue commands or prohibitions under the name of *bannus*, the violation of which entailed a fine of 60 *solidi*; the king also administered justice (*in palatio*), assisted by the officers of his household, his jurisdiction being unlimited and at the same time undefined. He could hear all causes, but was not bound to hear any, except, apparently, accusations of deliberate failure of justice and breach of trust on the part of the *rachimburgii*.

But what proved the great disturbing element in Gallo-Roman society was the fact that the conquerors, owing to their former customs and the degree of their civilization, were all warriors, men whose chief interest was to become practised in the handling of arms, and whose normal state was that of war. It is true that under the Roman empire all the men of a *civitas* were obliged, in case of necessity, to march against the enemy, and under the Frankish monarchy the count still called together his *pagenses* for this object. But the condition of the barbarian was very different; he lived essentially for fighting. Hence those gatherings or annual reviews of the *Campus Martius*, which continued so long, in Austrasia at least. They constituted the chief armed force; for mercenary troops, in spite of the assertions of some to the contrary, play at this period only a small part. But this military class, though not an aristocracy (for among the Franks the royal race alone was noble), was to a large extent independent, and the king had to attach these *leudes* or *fideles* to himself by gifts and favours. At the same time the authority of the king gradually underwent a

change in character, though he always claimed to be the successor of the Roman emperor. It gradually assumed that domestic or personal character that, among the Germans, marked most of the relations between men. The household of the king gained in political importance, by reason that the heads of the principal offices in the palace became at the same time high public officials. There was, moreover, a body of men more especially attached to the king, the *antrustions* (*q.v.*) and the commensals (*convivae regis*) whose *weregeld* (*i.e.* the price of a man's life in the system of compensation then prevalent) was three times greater than that of the other subjects of the same race.

The Frankish monarch had also the power of making laws, which he exercised after consulting the chief men of the kingdom, both lay and ecclesiastical, in the *placita*, which were meetings differing from the *Campus Martius* and apparently modelled principally on the councils of the Church. But throughout the kingdom in many places the direct authority of the king over the people ceased to make itself felt. The *immunitates*, granted chiefly to the great ecclesiastical properties, limited this authority in a curious way by forbidding public officials to exercise their functions in the precinct of land which was *immunis*. The judicial and fiscal rights frequently passed to the landowner, who in any case became of necessity the intermediary between the supreme power and the people. In regard to this last point, moreover, the case seems to have been the same with all the great landowners or *potentes*, whose territory was called *potestas*, and who gained a real authority over those living within it; later in the middle ages they were called *homines potestatis* (*hommes de poeste*).

Other principles, arising perhaps less from Germanic custom strictly speaking than from an inferior level of civilization, also contributed towards the weakening of the royal power. The monarch, like his contemporaries, considered the kingdom and the rights of the king over it to be his property; consequently, he had the power of dealing with it as if it were a private possession; it is this which gave rise to the concessions of royal rights to individuals, and later to the partitions of the kingdom, and then of the empire, between the sons of the king or emperor, to the exclusion of the daughters, as in the division of an inheritance in land. This proved one of the chief weaknesses of the Merovingian monarchy.

In order to rule the Gallo-Romans, the barbarians had had inevitably to ask the help of the Church, which was the representative of Roman civilization. Further, the Merovingian monarch and the Catholic Church had come into close alliance in their struggle with the Arians.

The result for the Church had been that she gained new privileges, but at the same time became to a certain extent dependent. Under the Merovingians the election of the bishop *a clero et populo* is only valid if it obtains the assent (*assensus*) of the king, who often directly nominates the prelate. But at the same time the Church retains her full right of acquiring property, and has her jurisdiction partially recognized; that is to say, she not only exercises more freely than ever a disciplinary jurisdiction, but the bishop, in place of the civil power, administers civil and criminal justice over the clergy. The councils had for a long time forbidden the clergy to cite one another before secular tribunals; they had also, in the 6th century, forbidden secular judges under pain of excommunication to cite before them and judge the clergy, without permission of the bishop. A decree of Clotaire II. (614) acknowledged the validity of these claims, but not completely; a precise interpretation of the text is, however, difficult.

The Merovingian dynasty perished of decay, amid increasing anarchy. The crown passed, with the approval of the papacy, to an Austrasian mayor of the palace and his family, one of those mayors of the palace (*i.e.* chief officer of the king's household) who had been the last support of the preceding dynasty. It was then that there developed a certain number of institutions, which offered themselves as useful means of consolidating the political organism,

and were in reality the direct precursors of feudalism. One was the royal benefice (*beneficium*), of which, without doubt, the Church provided both the model and, in the first instance, the material. The model was the *precaria*, a form of concession by which it was customary for the Church to grant the possession of her lands to free men; this practice she herself had copied from the five-years leases granted by the Roman exchequer. Gradually, however, the *precaria* had become a concession made, in most cases, free and for life. As regards the material, when the Austrasian mayors of the palace (probably Charles Martel) wished to secure the support of the *fideles* by fresh benefits, the royal treasury being exhausted, they turned to the Church, which was at that time the greatest landowner, and took lands from her to give to their warriors. In order to disguise the robbery it was decided—perhaps as an afterthought—that these lands should be held as *precariae* from the Church, or from the monastic houses which had furnished them. Later, when the royal treasury was reorganized, the grants of land made by the kings naturally took a similar form: the *beneficium*, as a free grant for life. Under the Merovingians royal grants of land were in principle made in full ownership, except, as Brunner has shown, that provision was made for a revocation under certain circumstances. No special services seem to have been attached to the benefice, whether granted by the king or by some other person, but, in the second half of the 9th century at least, the possession of the benefice is found as the characteristic of the military class and the form of their pay. This we find clearly set forth in the treatise *de ecclesiis et capellis* of Hincmar of Reims. The *beneficium*, in obedience to a natural law, soon tended to crystallize into a perpetual and hereditary right. Another institution akin to the *beneficium* was the *senioratus*; by the *commendatio*, a form of solemn contract, probably of Germanic origin, and chiefly characterized by the placing of the hands between those of the lord, a man swore absolute fidelity to another man, who became his *senior*. It became the generally received idea (as expressed in the capitularies) that it was natural and normal for every free man to have a *senior*. At the same time a benefice was never granted unless accompanied by the *commendatio* of the beneficiary to the grantor. As the most important *seniores* were thus bound to the king and received from him their benefices, he expected through them to command their men; but in reality the king disappeared little by little in the *senior*. The king granted as benefices not only lands, but public functions, such as those of count or *dux*, which thus became possessions, held, first for life, and later as hereditary properties. The Capitulary of Kiersy-sur-Oise (877), which was formerly considered to have made fiefs legally and generally hereditary, only proves that it was already the custom for benefices of this kind, *honores*, to pass from the father to one of the sons.

Charlemagne, while sanctioning these institutions, tried to arrest the political decomposition. He reorganized the administration of justice, fixing the respective jurisdictions of the count and the *centenarius*, substituting for the *rachim-burgii* permanent *scabini*, chosen by the count in the presence of the people, and defining the relations of the count, as the representative of the central authority, with the *advocati* or *judices* of *immunitates* and *potestates*. He reorganized the army, determining the obligations and the military outfit of free men according to their means. Finally, he established those regular inspections by the *missi dominici* which are the subject of so many of his capitularies. From the *De ordine palatii* of Hincmar of Reims, who follows the account of a contemporary of the great emperor, we learn that he also regularly established two general assemblies, *conventus* or *placita*, in the year, one in the autumn, the other in the spring, which were attended by the chief officials, lay and ecclesiastical. It was here that the capitularies (*q.v.*) and all important measures were first drawn up and then promulgated. The revenues of the Carolingian monarch (which are no longer identical with the finances of the state) consisted chiefly in the produce of the royal lands (*villae*), which the king and his suite often came and

Character of the Merovingian kingship.

Beginnings of the feudal system.

Position of the Church.

Reforms of Charlemagne.

Carolingian period.

consumed on the spot; and it is known how carefully Charlemagne regulated the administration of the *villae*. There were also the free gifts which the great men were bound, according

Carolligan fiscal system.

to custom, to bring to the *conventus*, the contributions of this character from the monasteries practically amounting to a tax; the regular personal or territorial dues into which the old taxes had resolved themselves; the profits arising from the courts (the royal *bannus*, and the *fredum*, or part of the compensation-money which went to the king); finally, numberless requisitions in kind, a usage which had without doubt existed continuously since Roman times. The Church was loaded with honours and had added a fresh prerogative to her former privileges, namely, the right of levying a real tax in kind, the *tithe*. Since the 3rd century she had tried to exact the payment of tithes from the faithful, interpreting as applicable to the Christian clergy the texts in the Old Testament bearing on the Levites; Gallican councils had repeatedly proclaimed it as an obligation, though, it appears, with little success. But from the reign of Pippin the Short onwards the civil law recognized and sanctioned this obligation, and the capitularies of Charlemagne and Louis the Debonnaire contain numerous provisions dealing with it. Ecclesiastical jurisdiction

The Church under Charlemagne.

extended farther and farther, but Charlemagne, the protector of the papacy, maintained firmly his authority over the Church. He nominated its dignitaries, both bishops and abbots, who were true ecclesiastical officials, parallel with the lay officials. In each *pagus*, bishop and count owed each other mutual support, and the *missi* on the same circuit were ordinarily a count and a bishop. In the first collection of capitularies, that of Ansegisus, two books out of four are devoted to ecclesiastical capitularies.

What, then, was the private and criminal law of this Frankish monarchy which had come to embrace so many different races?

The law under the Frank monarchy.

The men of Roman descent continued under the Roman law, and the conquerors could not hope to impose their customs upon them. The authorized expression of the Roman law was henceforth to be found in the *Lex romana Wisigothorum* or *Breviarium Alarici*, drawn up by order of Alaric II. in 506. It is an abridgment of the codes, of that of Theodosius especially, and of certain of the writings of the jurists included under the Law of Citations. As to the barbarians, they had hitherto had nothing but customs, and these customs, of which the type nearest to the original is to be found in the oldest text of the *Lex Salica*, were nothing more than a series of tariffs of compensations, that is to say, sums of money due to the injured party or his family in case of crimes committed against individuals, for which crimes these compensations were the only penalty. They also introduced a barbarous system of trial, that by compurgation, *i.e.* exculpation by the oath of the defendant supported by a certain number of *cojurantes*, and that by ordeal, later called *judicium Dei*. In each new kingdom the barbarians naturally kept their own laws, and when these men of different races all became subject to the Frankish monarchy, there evolved itself a system (called the *personnalité des lois*) by which every subject had, in principle, the right to be tried by the law of the race to which he belonged by birth (or sometimes for some other reason, such as emancipation or marriage). When the two adversaries were of different race, it was the law of the defendant which had to be applied. The customs of the barbarians had been drawn up in Latin. Sometimes, as in the case of the first text of the Salic law, the system on which they were compiled is not exactly known; but it was generally done under the royal authority. At this period only these written documents bear the name of "law" (*leges romanorum; leges barbarorum*), and at least the tacit consent of the people seems to have been required for these collections of laws, in accordance with an axiom laid down in a later capitulary; *lex fit consensu populi et constitutione regis*. It is noteworthy, too, that in the process of being drawn up in Latin, most of the *leges barbarorum* were very much Romanized.

In the midst of this diversity, a certain number of causes tended to produce a partial unity. The capitularies, which had in themselves the force of law, when there was no question of

modifying the *leges*, constituted a legislation which was the same for all; often they inflicted corporal punishment for grave offences, which applied to all subjects without distinction. Usage and individual convenience led to the same result. The Gallo-Romans, and even the Church itself, to a certain extent, adopted the methods of trial introduced by the Germans, as was likely in a country relapsing into barbarism. On the other hand, written acts became prevalent among the barbarians, and at the same time they assimilated a certain amount of Roman law; for these acts continued to be drawn up in Latin, after Roman models, which were in most cases simply misinterpreted owing to the general ignorance. The type is preserved for us in those collections of *Formulae*, of which complete and scientific editions have been published by Eugène de Rozière and Carl Zeumer. During this period, too, the Gallican Church adopted the collection of councils and decretals, called later the *Codex canonum ecclesiae Gallicanae*, which she continued to preserve. This collection was that of Dionysius Exiguus, which was sent to Charlemagne in 774 by Pope Adrian I. But in the course of the 9th century apocryphal collections were also formed in the Gallican Church: the False Capitularies of Benedictus Levita, and the False Decretals of Isidorus Mercator (see DECRETALS).

All the subjects of the Frankish monarchy were not of equal status. There was, strictly speaking, no nobility, both the Roman and the Germanic nobility having died out; but slavery continued to exist. The Church, however, was preparing the transformation of the slave into the serf, by giving force and validity to their marriages, in cases, at least, when the master had approved of them, and by forbidding the latter unjustly to seize the slave's *peculium*. But between the free man (*ingenuus*) and the slave lay a number of persons of intermediate status; they possessed legal personality but were subject to incapacities of various kinds, and had to perform various duties towards other men. There was, to begin with, the Roman colonist (*colonus*), a class as to the origin of which there is still a controversy, and of which there is no clear mention in the laws before the 4th century; they and their children after them were attached perpetually to a certain piece of land, which they were allowed to cultivate on payment of a rent. There were, further, the *liti* (*litus* or *lidus*), a similar class of Germanic origin; also the greater number of the freedmen or descendants of freedmen. Many free men who had fled to the great landowners for protection took, by arrangement or by custom, a similar position. Under the Merovingian régime, and especially under the Carolingians, the occupation of the land tended to assume the character of tenure; but free ownership of land continued to exist under the name of *alod* (*alodis*), and there is even evidence for the existence of this in the form of small properties, held by free men; the capitularies contain numerous complaints and threats against the counts, who endeavoured by the abuse of their power to obtain the surrender of these properties.

Period of Anarchy and the Rise of Feudalism.—The 10th and 11th centuries were a period of profound anarchy, during which feudalism was free to develop itself and to take definitive shape. At that time the French people may be said to have lived without laws, without even fixed customs and without government. The legislative power was no longer exercised, for the last Carolingian capitularies date from the year 884, and the first laws of the Capetian kings (if they may be called laws) do not appear till during the 12th century. During this period the old capitularies and *leges* fell into disuse and in their place territorial customs tended to grow up, their main constituents being furnished by the law of former times, but which were at the outset ill-defined and strictly local. As to the government, if the part played by the Church be excepted, we shall see that it could be nothing but the application of brute force. In this anarchy, as always happens under similar conditions, men drew together and formed themselves into groups for mutual defence. A nucleus was formed which was to become the new social unit, that is to say, the feudal group. Of this the centre was a chief, around whom gathered men capable of bearing arms, who commended themselves to

Anarchy and feudal origins.

him according to the old form of vassalage, *per manus*. They owed him fidelity and assistance, the support of their arms but not of their purse, save in quite exceptional cases; while he owed them protection. Some of them lived in his castle or fortified house, receiving their equipment only and eating at his table. Others received lands from him, which were, or later became, fiefs, on which they lived *casati*. The name fief, *feudum*, does not appear, however, till towards the end of this period; these lands are frequently called *beneficia* as before; the term most in use at first, in many parts, is *casamentum*. The fief, moreover, was generally held for life and did not become generally hereditary till the second half of the 11th century. The lands kept by the chief and those which he granted to his men were for the most part rented from him, or from them, for a certain amount in money or in kind. All these conditions had already existed previously in much the same form; but the new development is that the chief was no longer, as before, merely an intermediary between his men and the royal power. The group had become in effect independent, so organized as to be socially and politically self-sufficient. It constituted a small army, led, naturally, by the chief, and composed of his feudatories, supplemented in case of need by the *rustici*. It also formed an assembly in which common interests were discussed, the lord, according to custom, being bound to consult his feudatories and they to advise him to the best of their power. It also formed a court of justice, in which the feudatories gave judgment under the presidency of their lord; and all of them claimed to be subject only to the jurisdiction of this tribunal composed of their peers. Generally they also judged the villeins (*villani*) and the serfs dependent on the group, except in cases where the latter obtained as a favour judges of their own status, which was, however, at that time a very rare occurrence.

Under these conditions a nobility was formed, those men becoming nobles who were able to devote themselves to the profession of arms and were either chiefs or soldiers in one of the groups which have just been described. The term designating a noble, *miles*, corresponds also to that of knight (Fr. *chevalier*, Low Lat. *caballerius*), for the reason that chivalry, of which the origins are uncertain, represents essentially the technical skill and professional duties of this military class. Every noble was destined on coming of age to become a knight, and the knight equally as a matter of course received a fief, if he had not one already by hereditary title. This nobility, moreover, was not a caste but could be indefinitely recruited by the granting of fiefs and admission to knighthood (see KNIGHTHOOD AND CHIVALRY).

The state of anarchy was by now so far advanced that war became an individual right, and the custom of private war arose.

Every man had in principle the right of making war to defend his rights or to avenge his wrongs. Later on, doubtless, in the 13th century, this was a privilege of the noble (*gentilhomme*); but the texts defining the limits which the Church endeavoured to set to this abuse, namely, the Peace of God and the Truce of God, show that this was at the outset a power possessed by men of all classes. Even a man who had appeared in a court of law and received judgment had the choice of refusing to accept the judgment and of making war instead. Justice, moreover, with its frequent employment of trial by combat, did not essentially differ from private war.

It is unnecessary to go further and to affirm, with certain historians of our time, for example Guilhermoz and Sée, that the only free men at that time, besides the clergy, were the nobles, all the rest being serfs. There are many indications which lead us to assume, not only in the towns but even in the country districts, the existence of a class of men of free status who were not *militēs*, the class later known in the 13th century as *vilains*, *hommes de poeste*, and, later, *roturiers*. The fact more probably was that only the nobles and ecclesiastics were exempt from the exactions of the feudal lords; while from all the others the seigneurs could at pleasure levy the *taille* (a direct and arbitrary tax), and those innumerable rights then called *consuetudines*.

Free ownership, the *allodium*, even under the form of small freeholds, still existed by way of exception in many parts.

Had, then, the main public authority disappeared? This is practically the contention of certain writers, who, like M. Sée, maintain that real property, the possession of a domain, conferred on the big landed proprietor all rights of taxation, command and coercion over the inhabitants of his domain, who, according to this view, were always serfs. But this is an exaggeration of the thesis upheld by old French authors, who saw in feudalism, though in a different sense, a confusion of property with sovereignty. It appears that in this state of political disintegration each part of the country which had a homogeneous character tended to form itself into a higher unit. In this unit there arose a powerful lord, generally a duke, a count, or a viscount, who sometimes came to be called the *capitalis dominus*. He was either a former official of the monarchy, whose function had become hereditary, or a usurper who had formed himself on this model. He laid claim to an authority other than that conferred by the possession of real property. He still claimed to exercise over the whole of his former district certain rights, which we see him sometimes surrendering for the benefit of churches or monasteries. His court of justice was held in the highest honour, and to it were referred the most important affairs. But in this district there were generally a number of more or less powerful lords, who as a rule had as yet no particular feudal title and are often given the name of *principes*. Often, but not always, they had commended themselves to this duke or count by doing homage.

On the other hand, the royal power continued to exist, being recognized by a considerable part of old Gaul, the *regnum Francorum*. But under the last of the Carolingians it had in fact become elective, as is shown by the elections of Odo and Robert before that of Hugh Capet. The electors were the chief lords and prelates of the *regnum Francorum*. But following a clever policy, each king during his lifetime took as partner of his kingdom his eldest son and consecrated and crowned him in advance, so that the first of the Capetians revived the principle of heredity in favour of the eldest son, while establishing the hereditary indivisibility of the kingdom. This custom was recognized at the accession of Louis the Fat, but the authority of the king was very weak, being merely a vague allegiance. His only real authority lay where his own possessions were, or where there had not arisen a duke, a count, or lord of equal rank with them. He maintained, however, a general right of administering justice, a *curia*, the jurisdiction of which seems to have been universal. It is true that the parties in a suit had to submit themselves to it voluntarily, and could accept or reject the judgment given, but this was at that time the general rule. The king dispensed justice surrounded by the officers of his household (*domestici*), who thus formed his council; but these were not the only ones to assist him, whether in court or council. Periodically, at the great yearly festivals, he called together the chief lords and prelates of his kingdom, thus carrying on the tradition of the Carolingian *placita* or *conventus*; but little by little, with the appropriation of the *honores*, the character of the gathering changed; it was no longer an assembly of officials but of independent lords. This was now called the *curia regis*.

While the power of the State was almost disappearing, that of the Church, apart from the particular acts of violence of which she was often the victim, continued to grow. Her jurisdiction gained ground, since her procedure was reasonable and comparatively scientific (except that she admitted to a certain extent compurgation by oath and the *judicia Dei*, with the exception of trial by combat). Not only was the privilege of clergy, by which accused clerks were brought under her jurisdiction, almost absolute, but she had cognizance of a number of causes in which laymen only were concerned, marriage and everything nearly or remotely affecting it, wills, crimes and offences against religion; and even contracts, when the two parties wished it or when the agreement was made on oath, came within her competence. Such, then, were the

The royal power.

The Church.

Private war.

ecclesiastical or Christian courts (*cours d'église, coursedechrétienté*). The Church, moreover, remained in close connexion with the crown, the king preserving a quasi-ecclesiastical character, while the royal prerogatives with regard to the election of bishops were maintained more successfully than the rights of the crown, though in many of the great fiefs they none the less passed to the count or the duke. It was at this time too that the Church tried to break the last ties which still kept her more or less dependent on the civil power; this was the true import of the Investiture Contest (see INVESTITURE, and CHURCH HISTORY), though this was not very acute in France.

The period of the true feudal monarchy is embraced by the 12th and 13th centuries, that is to say, it was at this time that the crown again assumed real strength and authority; but so far it had no organs and instruments save those which were furnished by feudalism, now organized under a regular hierarchy, of which the king was the head, the "sovereign enfeoffor of the kingdom" (*souverain fiefieux du royaume*), as he came later on to be called. This new position of affairs was the result of three great factors: the revival of Roman Law, the final organization of feudalism and the rise of the privileged towns. The revival of Roman

law began in France and Italy in the second half of the 11th century, developing with extraordinary brilliance in the latter country at the university of Bologna, which was destined for a long time to dominate Europe. Roman law spread rapidly in the French schools and universities, except that of Paris, which was closed to it by the papacy; and the influence of this study was so great that it transformed society. On the one hand it contributed largely to the reconstitution of the royal power, modelling the rights of the king on those of the Roman emperor. On the other hand it wrought a no less profound change in private law. From this time dates the division of old France into the *Pays de droit écrit*, in which Roman law, under the form in which it was codified by Justinian, was received as the ordinary law; and the *Pays de*

coutume, where it played only a secondary part, being generally valid only as *ratio scripta* and not as *lex scripta*. In this period the customs also took definitive form, and over and above the local customs properly so called there were formed customs known as *general*, which held good through a whole province or *bailliage*, and were based on the jurisprudence of the higher jurisdictions.

The final organization of feudalism resulted from the struggle for organization which was proceeding in each district where the more powerful lords compelled the others to do them homage and become their vassals; the *capitalis dominus* had beneath him a whole hierarchy, and was himself a part of the feudal system of France (see FEUDALISM). Doubtless in the case of lords like the dukes of Brittany and Burgundy, the king could not actually demand the strict fulfilment of the feudal obligations; but the principle was established. The question now arises, did free and absolute property, the *allodium*, entirely disappear in this process, and were all lands held as tenures? It continued to exist, by way of exception, in most districts, unchanged save in the burden of proof of ownership, with which, according to the customs, sometimes the lord and sometimes the holder of the land was held

charged. In one respect, however, namely in the administration of justice, the feudal hierarchy had absolute sway. Towards the end of the 13th century Beaumanoir clearly laid down this principle: "All secular jurisdiction in France is held from the king as a fief or an *arrière-fief*." Henceforth it could also be said that "All justice emanates from the king." The law concerning fiefs became settled also from another point of view, the fief becoming patrimonial; that is to say, not only hereditary, but freely alienable by the vassal, subject in both cases to certain rights of transfer due to the lord, which were at first fixed by agreement and later by custom. The most salient features of feudal succession were the right of primogeniture and the preference given to heirs-male; but from the 13th century onwards the

right of primogeniture, which had at first involved the total exclusion of the younger members of a family, tended to be modified, except in the case of the chief lords, the eldest son obtaining the preponderant share or *préciput*. Non-noble (*roturier*) tenancies also became patrimonial in similar circumstances, except that in their case there was no right of primogeniture nor any privilege of males. The tenure of serfs did not become alienable, and only became hereditary by certain devices.

Feudal society next saw the rise of a new element within it: the privileged towns. At this time many towns acquired privileges, the movement beginning towards the end of the 11th century; they were sanctioned by a formal concession from the lord to whom the town was subject, the concession being embodied in a charter or in a record of customs (*coutume*). Some towns won for themselves true political rights, for instance the right of self-administration, rights of justice over the inhabitants, the right of not being taxed except by their own consent, of maintaining an armed force, and of controlling it themselves. Others only obtained civil rights, e.g. guarantees against the arbitrary rights of justice and taxation of the lord or his provost. The chief forms of municipal organization at this time were the *commune jurée* of the north and east, and the *consulat*, which came from Italy and penetrated as far as Auvergne and Limousin. The towns with important privileges formed in feudal society as it were a new class of lordships; but their lords, that is to say their burgesses, were inspired by quite a new spirit. The crown courted their support, taking them under its protection, and championing the causes in which they were interested (see COMMUNE). Finally, it is in this period, under Philip Augustus, that the great fiefs began to be effectually reannexed to the crown, a process which, continued by the kings up to the end of the *ancien régime*, re-founded for their profit the territorial sovereignty of France.

The crown maintained the machinery of feudalism, the chief central instruments of which were the great officers of the crown, the seneschal, butler, constable and chancellor, who were to become irremovable officials, those at least who survived. But this period saw the rise of a special college of dignitaries, that of the Twelve Peers of France, consisting of six laymen and six ecclesiastics, which took definitive shape at the beginning of the 13th century. We cannot yet discern with any certainty by what process it was formed, why those six prelates and those six great feudatories in particular were selected rather than others equally eligible. But there is no doubt that we have here a result of that process of feudal organization mentioned above; the formation of a similar assembly of twelve peers occurs also in a certain number of the great fiefs. Besides the part which they played at the consecration of kings, the peers of France formed a court in which they judged one another under the presidency of the king, their overlord, according to feudal custom. But the *cour des pairs* in this sense was not separate from the *curia regis*, and later from the parlement of Paris, of which the peers of France were by right members. From this time, too, dates another important institution, that of the *maîtres des requêtes*.

The legislative power of the crown again began to be exercised during the 12th century, and in the 13th century had full authority over all the territories subject to the crown. Beaumanoir has a very interesting theory on this subject. The right of war tends to regain its natural equilibrium, the royal power following the Church in the endeavour to check private wars. Hence arose the *quarantaine le roi*, due to Philip Augustus or Saint Louis, by which those relatives of the parties to a quarrel who had not been present at the quarrel were rendered immune from attack for forty days after it; and above all the *assurements* imposed by the king or lord; on these points too Beaumanoir has an interesting theory. The rule was, moreover, already in force by which private wars had to cease during the time that the king was engaged in a foreign war. But the most appreciable progress took place in the

Rise of the privileged towns.

Great officers of the crown and peers of France.

Growth of the royal power.

administrative and judicial institutions. Under Philip Augustus arose the royal *baillis* (see BAILIFF: section *Bailli*), and seneschals (*q.v.*), who were the representatives of the king in the provinces, and superior judges. At the same time the form of the feudal courts tended to change, as they began more and more to be influenced by the Romano-canonical law. Saint Louis had striven to abolish trial by combat, and the Church had condemned other forms of ordeal, the *purgatio vulgaris*. In most parts of the country the feudal lords began to give place in the courts of law to the provosts (*prévôts*) and *baillis* of the lords or of the crown, who were the judges, having as their councillors the *avocats* (advocates) and *procurateurs* (procurators) of the assize. The feudal courts, which were founded solely on the relations of homage and tenure, before which the vassals and tenants as such appeared, disappeared in part from the 13th century on. Of the seigniorial jurisdictions there soon remained only the *hautes* or *basses justices* (in the 14th century arose an intermediate grade, the *moyenne justice*), all of which were considered to be concessions of the royal power, and so delegations of the public authority. As a result of the application of Roman and canon law, there arose the *appel* strictly so called, both in the class of royal and of seigniorial jurisdictions, the case in the latter instance going finally before a royal court, from which henceforth there was no appeal. In the 13th century too appeared the theory of crown cases (*cas royaux*), cases which the lords became incompetent to try and which were reserved for the royal court. Finally, the *curia regis* was gradually transformed into a regular court of justice, the *Parlement* (*q.v.*), as it was already called in the second half of the 13th century. At this time the king no longer appeared in it regularly, and before each session (for it was not yet a permanent body) a list of properly qualified men was drawn up in advance to form the parlement, only those whose names were on the list being capable of sitting in it. Its main function had come to be that of a final court of appeal. At the various sessions, which were regularly held at Paris, appeared the *baillis* and seneschals, who were called upon to answer for the cases they had judged and also for their administration. The accounts were received by members of the parlement at the Temple, and this was the origin of the Cour or Chambre des Comptes.

At the end of this period the nobility became an exclusive class. It became an established rule that a man had to be noble in order to be made a knight, and even in order to acquire a fief; but in this latter respect the king made exceptions in the case of *roturiers*, who were licensed to take up fiefs, subject to a payment known as the *droits de franc-fief*. The *roturiers*, or villeins who were not in a state of thralldom, were already a numerous class not only in the towns but in the country. The Church maintained her privileges; a few attempts only were made to restrain the abuse, not the extent, of her jurisdiction. This jurisdiction was, during the 12th century, to a certain extent regularized, the bishop nominating a special functionary to hold his court; this was the *officialis* (Fr. *official*), whence the name of *officialité* later applied in France to the ecclesiastical jurisdictions. On one point, however, her former rights were diminished. She preserved the right of freely acquiring personal and real property, but though she could still acquire feudal tenures she could not keep them; the customs decided that she must *vider les mains*, that is, alienate the property again within a year and a day. The reason for this new rule was that the Church, the ecclesiastical establishment, is a proprietor who does not die and in principle does not surrender her property; consequently, the lords had no longer the right of exacting the transfer duties on those tenures which she acquired. It was possible, however, to compromise and allow the Church to keep the tenure on condition of the consent not only of the lord directly concerned, but of all the higher lords up to the *capitalis dominus*; it goes without saying that this concession was only obtained by the payment of pecuniary compensations, the chief of which was the *droit d'amortissement*, paid to these different lords. In this period the form of the episcopal elections under-

went a change, the electoral college coming to consist only of the canons composing the chapter of the cathedral church. But except for the official candidatures, which were abused by the kings and great lords, the elections were regular; the Pragmatic Sanction, attributed to Saint Louis, which implies the contrary, is nowadays considered apocryphal by the best critics.

Finally, it must be added that during the 13th century criminal law was profoundly modified. Under the influence of Roman law a system of arbitrary penalties replaced those laid down by the customs, which had usually been fixed and cruel. The criminal procedure of the feudal courts had been based on the right of accusation vested only in the person wronged and his relations; for this was substituted the inquisitorial procedure (*processus per inquisitionem*), which had developed in the canon law at the very end of the 12th century, and was to become the *procédure à l'extraordinaire* of the *ancien régime*, which was conducted in secret and without free defence and debate. Of this procedure torture came to be an ordinary and regular part.

The customs, which at that time contained almost the whole of the law for a great part of France, were not fixed by being written down. In that part of France which was subject to customary law (*la France coutumière*) they were defined when necessary by the verdict of a jury of practitioners in what was called the *enquête par turbes*; some of them, however, were, in part at least, authentically recorded in seigniorial charters, *chartes de ville* or *chartes de coutume*. Their rules were also recorded by experts in private works or collections called *livres coutumiers*, or simply *coutumiers* (customaries). The most notable of these are *Les Coutumes de Beauvoisis* of Philippe de Beaumanoir, which Montesquieu justly quotes as throwing light on those times; also the *Très ancienne coutume de Normandie* and the *Grand Coutumier de Normandie*; the *Conseil à un ami* of Pierre des Fontaines, the *Établissements de Saint Louis*; the *Livre de justice et de plet*. At the same time the clerks of important judges began to collect in registers notable decisions; it is in this way that we have preserved to us the old decisions of the exchequer of Normandy, and the *Olim* registers of the parlement of Paris.

The Limited Monarchy.—The 14th and 15th centuries were the age of the limited monarchy. Feudal institutions kept their political importance; but side by side with them arose others of which the object was the direct exercise of the royal authority; others also arose from the very heart of feudalism, but at the same time transformed its laws in order to adapt them to the new needs of the crown. In this period certain rules for the succession to the throne were fixed by precedents: the exclusion of women and of male descendants in the female line, and the principle that a king could not by an act of will change the succession of the crown. The old *curia regis* disappeared and was replaced by the parlement as to its judicial functions, while to fulfil its deliberative functions there was formed a new body, the royal council (*conseil du roi*), an administrative and governing council, which was in no way of a feudal character. The number of its members was at first small, but they tended to increase; soon the brevet of *conseiller du roi en ses conseils* was given to numerous representatives of the clergy and nobility, the great officers of the crown becoming members by right. Side by side with these officials, whose power was then at its height, there were gradually evolved more subservient ministers who could be dispensed with at will; the *secrétaires des commandements du roi* of the 15th century, who in the 16th century developed into the *secrétaires d'état*, and were themselves descended from the *clercs du secret* and *secrétaires des finances* of the 14th century. The College of the Twelve Peers of France had not its full numbers at the end of the 13th century; the six ecclesiastical peerages existed and continued to exist to the end, together with the archbishopric and bishoprics to which they were attached, not being suppressed; but several of the great fiefs to which six lay peerages had been attached had been annexed to the crown. To fill these vacancies, Philip the Fair raised the duchies of Brittany and Anjou and

*Nobles,
commons
and the
Church in
the 13th
century.*

*Changes
in criminal
law.*

*The
customs.*

the countship of Artois to the rank of peerages of France. This really amounted to changing the nature of the institution; for the new peers held their rank merely at the king's will, though the rank continued to belong to a great barony and to be handed down with it. Before long peers began to be created when there were no gaps in the ranks of the College, and there was a constant increase in the numbers of the lay peers.

At the beginning of the 14th century appeared the states general (*états généraux*), which were often convoked, though not at fixed intervals, throughout the whole of the 14th century and the greater part of the 15th. Their power reached its height at a critical moment of the Hundred Years' War during the reign of King John. At the same time there arose side by side with them, and from the same causes, the provincial estates, which were in miniature for each province what the states general were for the whole kingdom. Of these provincial assemblies some were founded in one or other of the great fiefs, being convoked by the duke or count under the pressure of the same needs which led the king to convoke the states general; others, in provinces which had already been annexed to the crown, probably had their origin in the councils summoned by the *bailli* or seneschal to aid him in his administration. Later it became a privilege for a province to have its own assembly; those which did so were never of right subject to the royal *taille*, and kept, at least formally, the right of sanctioning, by means of the assembly, the subsidies which took its place. Hence it became the endeavour of the crown to suppress these provincial assemblies, which in the 14th century were to be found everywhere; from the outset of the 15th century they began to disappear in central France.

The most characteristic feature of this period was the institution of universal taxation by the crown. So far the king's sole revenues were those which he exacted, in his capacity of feudal lord, wherever another lord did not intervene between him and the inhabitants, in addition to the income arising from certain crown rights which he had preserved or regained. But these revenues, known later as the income of the royal domain and later still as the *finances ordinaires*, became insufficient in proportion as the royal power increased; it became a necessity for the monarch to be able to levy imposts throughout the whole extent of the provinces annexed to the crown, even upon the subjects of the different lords. This he could only do by means of the co-operation of those lords, lay and ecclesiastical, who alone had the right of taxing their subjects; the co-operation of the privileged towns, which had the right to tax themselves, was also necessary. It was in order to obtain this consent that the states general, in most cases, and the provincial assemblies, in all cases, were convoked. In some cases, however, the king adopted different methods; for instance, he sometimes utilized the principle of the feudal aids. In cases where his vassals owed him, as overlord, a pecuniary aid, he substituted for the sum paid directly by his vassals a tax levied by his own authority on their subjects. It is in this way that for thirty years the necessary sums were raised, without any vote from the states general, to pay the ransom of King John. But in principle the taxes were in the 14th century sanctioned by the states general. Whatever form they took, they were given the generic name of Aids or *auxilia*, and were considered as occasional and extraordinary subsidies, the king being obliged in principle to "live of his own" (*vivre de son domaine*). Certain aids, it is true, tended to become permanent under the reign of Charles VI.; but the taxes subject to the consent of the states general were at first the sole resource of Charles VII. In the second half of his reign the two chief taxes became permanent: in 1435 that of the aids (a tax on the sale of articles of consumption, especially on wine), with the formal consent of the states general, and that of the *taille* in 1439. In the latter case the consent of the states general was not given; but only the nobility protested, for at the same time as the royal *taille* became permanent the seigniorial *taille* was suppressed. These imposts were increased, on the royal authority, by Louis XI. After his death the states general, which met at Tours in 1484, endeavoured

to re-establish the periodical vote of the tax, and only granted it for two years, reducing it to the sum which it had reached at the death of Charles VII. But the promise that they would again be convoked before the expiry of two years was not kept. These imposts and that of the *gabelle* were henceforth permanent. Together with the taxes there was evolved the system of their administration. Their main outlines were laid down by the states general in the reign of King John, in 1355 and the following years. For the administration of the subsidies which they granted, they nominated from among their own numbers *surintendants généraux* or *généraux des finances*, and further, for each diocese or equivalent district, *élus*. Both had not only the active administration but also judicial rights, the latter constituting courts of the first instance and the former courts of final appeal. After 1360 the crown again adopted this organization, which had before been only temporary; but henceforth *généraux* and *élus* were nominated by the king. The *élus*, or *officiers des élections*, only existed in districts which were subject to the royal *taille*; hence the division, so important in old France, into *pays d'élections* and *pays d'états*. The *élus* kept both administration and jurisdiction; but in the higher stage a differentiation was made: the *généraux des finances*, who numbered four, kept the administration, while their jurisdiction as a court of final appeal was handed over to another body, the *cour des aides*, which had already been founded at the end of the 14th century. Besides the four *généraux des finances*, who administered the taxation, there were four Treasurers of France (*trésoriers de France*), who administered the royal domain; and these eight officials together formed in the 15th century a kind of ministry of finance to the monarchy.

The army also was organized. On the one hand, the military service attached to the fiefs was transformed for the profit of the king, who alone had the right of making war: it became the *arrière-ban*, a term which had formerly applied to the *levée en masse* of all the inhabitants in times of national danger. Before the 14th century the king had only had the power of calling upon his own immediate vassals for service. Henceforth all possessors of fiefs owed him, whether within the kingdom or on the frontiers, military service without pay and at their own expense. This was for long an important resource for the king. But Charles VII. organized an army on another footing. It comprised the *francs-archers* furnished by the parishes, a militia which was only summoned in case of war, but in time of peace had to practise archery, and companies of *gendarmerie* or heavy cavalry, forming a permanent establishment, which were called *compagnies d'ordonnance*. It was chiefly to provide for the expense of the first nucleus of a permanent army that the *taille* itself had been made permanent.

The new army led to the institution of the governors of provinces, who were to command the troops quartered there. At first they were only appointed for the frontiers and fortified places, but later the kingdom was divided into *gouvernements généraux*. There were at first twelve of these, which were called in the middle of the 16th century the *douze anciens gouvernements*. Although, strictly speaking, they had only military powers, the governors, always chosen from among the great lords, became in the provinces the direct representatives of the king and caused the *baillis* and seneschals to take a secondary place.

The courts of law continued to develop on the lines already laid down. The parlement, which had come to be a judicial committee nominated every year, but always consisting in fact of the same persons, changed in the course of the 14th century into a body of magistrates who were permanent but as yet subject to removal. During this period were evolved its organization and definitive features (see PARLEMENT). The provincial parlements had arisen after and in imitation of that of Paris, and had for the most part taken the place of some superior jurisdiction which had formerly existed in the same district when it had been independent (like Provence) or had formed one of the great fiefs (like Normandy or Burgundy). It was during this period also that the parlements acquired the right of opposing the registration, that is to say, the promulgation

States
general
and pro-
vincial
estates.

Royal
taxation.

The
army.

The law
courts.

of laws, of revising them, and of making representations (*remontrances*) to the king when they refused the registration, giving the reasons for such refusal. The other royal jurisdictions were completed (see BALLIFF, CHÂTELET). Besides them arose another of great importance, which was of military origin, but came to include all citizens under its sway. These were the provosts of the marshals of France (*prévôts des maréchaux de France*), who were officers of the *Maréchaussée* (the gendarmerie of the time); they exercised criminal jurisdiction without appeal in the case of crimes committed by vagabonds and fugitives from justice, this class being called their *gibier* (game), and of a number of crimes of violence, whatever the rank of the offender. Further, another class of officers was created in connexion with the law courts: the "king's men" (*gens du roi*), the *procureurs* and *avocats du roi*, who were at first simply those lawyers who represented the king in the law courts, or pleaded for him when he had some interest to follow up or to defend. Later they became officers of the crown. In the case of the *procureurs du roi* this development took place in the first half of the 14th century. Their duty was not only to represent the king in the law courts, whether as plaintiff or defendant, but also to take care that in each case the law was applied, and to demand its application. From this time on the *procureurs du roi* had full control over matters concerning the public interest, and especially over public prosecution. In this period, too, appeared what was afterwards called *justice retenue*, that is to say, the justice which the king administered, or was supposed to administer, in person. It was based on the idea that, since all justice and all judicial power reside in the king, he could not deprive himself of them by delegating their exercise to his officers and to the feudal lords. Consequently he could, if he thought fit, take the place of the judges and call up a case before his own council. He could reverse even the decisions of the courts of final appeal, and in some cases used this means of appealing against the decrees of the parlements (*proposition d'erreur, requête civile, pourvoi en révision*). In these cases the king was supposed to judge in person; in reality they were examined by the *maîtres des requêtes* and submitted to the royal council (*conseil du roi*), at which the king was always supposed to be present and which had in itself no power of giving a decision. For this purpose there was soon formed a special committee of the council, which was called the *conseil privé* or *de justice*. At the end of the 15th century, Charles VIII., in order to relieve the council of some of its functions, created a new final court, the *grand conseil*, to deal with a number of these cases. But before long it again became the custom to appeal to the *conseil du roi*, so that the *grand conseil* became almost useless. The king frequently, by means of *lettres de justice*, intervened in the procedure of the courts, by granting *bénéfices*, by which rules which were too severe were modified, and faculties or facilities for overcoming difficulties arising from flaws in contracts or judgments, cases at that time not covered by the common law. By *lettres de grâce* he granted reprieve or pardon in individual cases. The most extreme form of intervention by the king was made by means of *lettres de cachet* (*q.v.*), which ordered a subject to go without trial into a state prison or into exile.

The condition of the Church changed greatly during this period. The jurisdiction of the *officialités* was very much reduced, even over the clergy. They ceased to be competent to judge actions concerning the possession of real property, in which the clergy were defendants. In criminal law the theory of the *cas privilégié*, which appears in the 14th century, enabled the royal judges to take action against and judge the clergy for all serious crimes, though without the power of inflicting any penalties but arbitrary fines, the ecclesiastical judge remaining competent, in accordance with the privileges of clergy, to try the offender for the same crime as what was technically called a *délit commun*. The development of jurisprudence gradually removed from the *officialités* causes of a purely secular character in which laymen only were concerned, such as wills and contracts; and in matrimonial cases their jurisdiction was limited to those in which the *foedus matrimonii*

was in question. For the acquisition of real property by ecclesiastical establishments the consent of the king to the amortization was always necessary, even in the case of allodial lands; and if it was a case of feudal tenures the king and the direct overlords alone kept their rights, the intermediate lords being left out of the question.

As regards the conferring of ecclesiastical benefices, from the 14th century onwards the papacy encroached more and more upon the rights of the bishops, in whose gift the inferior benefices generally were, and of the electors, who usually conferred the superior benefices; at the same time it exacted from newly appointed incumbents heavy dues, which were included under the generic name of annates (*q.v.*). During the Great Schism of the Western Church, these abuses became more and more crying, until by a series of edicts, promulgated with the consent and advice of the parlement and the clergy, the Gallican Church was restored to the possession of its former liberties, under the royal authority. Thus France was ready to accept the decrees of reform issued by the council of Basel (*q.v.*), which she did, with a few modifications, in the Pragmatic Sanction of Charles VII., adopted after a solemn assembly of the clergy and nobles at Bourges and registered by the parlement of Paris in 1438. It suppressed the annates and most of the means by which the popes disposed of the inferior benefices: the reservations and the *gratie expectativae*. For the choice of bishops and abbots, it restored election by the chapters and convents. The Pragmatic Sanction, however, was never recognized by the papacy, nor was it consistently and strictly applied by the royal power. The transformation of the civil and criminal law under the influence of Roman and canon law had become more and more marked. The production of the *coutumiers*, or *livres de pratiques*, also continued. The chief of them were: in the 14th century, the *Stylus Vetus Curiae Parliamenti* of Guillaume de Breuil; the *Très ancienne coutume de Bretagne*; the *Grand Coutumier de France*, or *Coutumier de Charles VI.*; the *Somme rural* of Boutillier; in the 15th century, for Auvergne, the *Practica forensis* of Masuer. Charles VII., in an article of the Grand Ordonnance of Montil-les-Tours (1453), ordered the general customs to be officially recorded under the supervision of the crown. It was an enormous work, which would almost have transformed them into written laws; but up to the 16th century little recording was done, the procedure established by the Ordonnance for the purpose not being very suitable.

The Absolute Monarchy.—From the 16th century to the Revolution was the period of the absolute monarchy, but it can be further divided into two periods: that of the establishment of this régime, from 1515 to about 1673; and that of the *ancien régime* when definitively established, from 1673 to 1789. The reigns of Francis I. and Henry II. clearly laid down the principle of the absolute power of the crown and applied it effectually, as is plainly seen from the temporary disappearance of the states general, which were not assembled under these two reigns. There were merely a few assemblies of notables chosen by the royal power, the most important of which was that of Cognac, under Francis I., summoned to advise on the non-fulfilment of the treaty of Madrid. It is true that in the second half of the 16th century the states general reappeared. They were summoned in 1560 at Orleans, then in 1561 at Pontoise, and in 1576 and 1588 at Blois. The League even convoked one, which was held at Paris in 1593. This represented a crucial and final struggle. Two points were then at issue: firstly, whether France was to be Protestant or Catholic; secondly, whether she was to have a limited or an absolute monarchy. The two problems were not necessarily bound up with one another. For if the Protestants desired political liberty, many of the Catholics wished for it too, as is proved by the writings of the time, and even by the fact that the League summoned the estates. But the states general of the 16th century, in spite of their good intentions and the great talents which were at their service, were dominated by religious passions, which made them powerless

Papal encroachments.

Government under the absolute monarchy.

for any practical purpose. They only produced a few great ordinances of reform, which were not well observed. They were, however, to be called together yet again, as a result of the disturbances which followed the death of Henry IV.; but their dissensions and powerlessness were again strikingly exemplified and they did not reappear until 1789. Other bodies, however, which the royal power had created, were to carry on the struggle against it. There were the parlements, the political rivals of the states general. Thanks to the principle according to which no law came into effect so long as it had not been registered by them, they had, as we have seen, won for themselves the right of a preliminary discussion of those laws which were presented to them, and of refusing registration, explaining their reasons to the king by means of the *remontrances*. The royal power saw in this merely a concession from itself, a consultative power, which ought to yield before the royal will, when the latter was clearly manifested, either by *lettres de jussion* or by the actual words and presence of the king, when he came in person to procure the registration of a law in a so-called *lit de justice*. But from the 16th century onwards the members of the parlements claimed, on the strength of a historical theory, to have inherited the powers of the ancient assemblies (the Merovingian and Carolingian *placita* and the *curia regis*), powers which they, moreover, greatly exaggerated. The successful assertion of this claim would have made them at once independent of and necessary to the crown. During the minority of kings, they had possessed, in fact, special opportunities for asserting their pretensions, particularly when they had been called upon to intervene in the organization of the regency. It is on this account that at the beginning of the reign of Louis XIV. the parlement of Paris wished to take part in the government, and in 1648, in concert with the other supreme courts of the capital, temporarily imposed a sort of charter of liberties. But the first Fronde, of which the parlement was the centre and soul, led to its downfall, which was completed when later on Louis XIV. became all-powerful. The ordinance of 1667 on civil procedure, and above all a declaration of 1673, ordered the parlement to register the laws as soon as it received them and without any modification. It was only after this registration that they were allowed to draw up remonstrances, which were henceforth futile. The nobles, as a body, had also become politically impotent. They had been sorely tried by the wars of religion, and Richelieu, in his struggles against the governors of the provinces, had crushed their chief leaders. The second Fronde was their last effort (see FRONDE). At the same time the central government underwent changes. The great officers of the crown disappeared one by one. The office of constable of France was suppressed by purchase during the first half of the 17th century, and of those in the first rank only the chancellor survived till the Revolution. But though his title could only be taken from him by condemnation on a capital charge, the king was able to deprive him of his functions by taking from him the custody and use of the seal of France, which were entrusted to a *garde des sceaux*. Apart from the latter, the king's real ministers were the secretaries of state, generally four in number, who were always removable and were not chosen from among the great nobles. For purposes of internal administration, the provinces were divided among them, each of them corresponding by despatches with those which were assigned to him. Any other business (with the exception of legal affairs, which belonged to the chancellor, and finance, of which we shall speak later) was divided among them according to convenience. At the end of the 16th century, however, were evolved two regular departments, those of war and foreign affairs. Under Francis I. and Henry II., the chief administration of finance underwent a change; for the four *généraux des finances*, who had become too powerful, were substituted the *intendants des finances*, one of whom soon became a chief minister of finance, with the title *surintendant*. The *généraux des finances*, like the *trésoriers de France*, became provincial officials, each at the head of a *généralité* (a superior administrative district for purposes of finance); under Henry III. the two functions were combined and assigned to the *bureaux des finances*. The fall of Fouquet

led to the suppression of the office of *surintendant*; but soon Colbert again became practically a minister of finance, under the name of *contrôleur général des finances*, both title and office continuing to exist up to the Revolution.

The *conseil du roi*, the origin of which we have described, was an important organ of the central government, and for a long time included among its members a large number of representatives of the nobility and clergy. Besides the councillors of state (*conseillers d'état*), its ordinary members, the great officers of the crown and secretaries of state, princes of the blood and peers of France were members of it by right. Further, the king was accustomed to grant the brevet of councillor to a great number of the nobility and clergy, who could be called upon to sit in the council and give an opinion on matters of importance. But in the 17th century the council tended to differentiate its functions, forming three principal sections, one for political, one for financial, and the third for legal affairs. Under Louis XIV. it took a definitely professional, administrative and technical character. The *conseillers à brevet* were all suppressed in 1673, and the peers of France ceased to be members of the council. The political council, or *conseil d'en haut*, had no *ex officio* members, not even the chancellor; the secretary of state for foreign affairs, however, necessarily had entry to it; it also included a small number of persons chosen by the king and bearing the title of ministers of state (*ministres d'état*). The other important sections of the *conseil du roi* were the *conseil des finances*, organized after the fall of Fouquet, and the *conseil des dépêches*, in which sat the four secretaries of state and where everything concerned with internal administration (except finance) was dealt with, including the legal business connected with this administration. As to the government and the preparation of laws, under Louis XIV. and Louis XV., the *conseil du roi* often passed into the background, when, as the saying went, a minister who was projecting some important measure *travailloit seul avec le roi* (worked alone with the king), having from the outset gained the king's ear.

The chief authority in the provincial administration belonged in the 16th century to the governors of the provinces, though, strictly speaking, the governor had only military powers in his *gouvernement*; for, as we have seen, he was the direct representative of the king for general purposes. But at the end of this century were created the intendants of the provinces, who, after a period of conflict with the governors and the parlements, became absolute masters of the administration in all those provinces which had no provincial estates, and the instruments of a complete administrative centralization (see INTENDANT).

The towns having a *corps de ville*, that is to say, a municipal organization, preserved in the 16th century a fairly wide autonomy, and played an important part in the wars of religion, especially under the League. But under Louis XIV. their independence rapidly declined. They were placed under the tutelage of the intendants, whose sanction, or that of the *conseil du roi*, was necessary for all acts of any importance. In the closing years of the 17th century, the municipal officials ceased, even in principle, to be elective. Their functions ranked as offices which were, like royal offices, saleable and heritable. The pretext given by the edicts were the intrigues and dissensions caused by the elections; the real cause was that the government wanted to sell these offices, which is proved by the fact that it frequently allowed towns to redeem them and to re-establish the elections.

The sale of royal offices is one of the characteristic features of the *ancien régime*. It had begun early, and, apparently, with the office of councillor of the parlement of Paris, when this became permanent, in the second half of the 14th century. It was first practised by magistrates who wished to dispose of their office in favour of a successor of their own choice. The *resignatio in favorem* of ecclesiastical benefices served as model, and at first care was taken to conceal the money transaction between the parties. The crown winked at these resignations in consideration of a payment in money.

Provincial
adminis-
tration.

The
towns.

Sale of
offices.

But in the 16th century, under Francis I. at the latest, the crown itself began officially to sell offices, whether newly created or vacant by the death of their occupiers, taking a fee from those upon whom they were conferred. Under Charles IX. the right of resigning *in favorem* was recognized by law in the case of royal officials, in return for a payment to the treasury of a certain proportion of the price. In the case of judicial offices there was a struggle for at least two centuries between the system of sale and another, also imitated from canon law, *i.e.* the election or presentation of candidates by the legal corporations. The ordinances of the second half of the 16th century, granted in answer to complaints of the states general, restored and confirmed the latter system, giving a share in the presentation to the towns or provincial notables and forbidding sales. The system of sale, however, triumphed in the end, and, in the case of judges, had, moreover, a favourable result, assuring to them that irremovability which Louis XI. had promised in vain; for, under this system, the king could not reasonably dismiss an official arbitrarily without refunding the fee which he had paid. On the other hand, it contributed to the development of the *épices*, or dues paid by litigants to the judges. The system of sale, and with it irremovability, was extended to all official functions, even to financial posts. The process was completed by the recognition of the rights in the sale of offices as hereditary, *i.e.* the right of resigning the office on payment of a fee, either in favour of a competent descendant or of a third party, passed to the heirs of an official who had died without having exercised this right himself. It was established under Henry IV. in 1604 by the system called the *Paulette*, in return for the payment by the official of an annual fee (*droit annuel*) which was definitely fixed at a hundredth part of the price of the office. Thus these offices, though the royal nomination was still required as well as the professional qualifications required by the law, became heritable property in virtue of the finance attached to them. This led to the formation of a class of men who, though bound in many ways to the crown, were actually independent. Hence the tendency in the 18th century to create new and important functions under the form, not of offices, but of simple commissions.

In this period of the history of France were evolved and defined the essential principles of the old public law. There were, in the first place, the *fundamental laws of the realm*, which were true constitutional principles, established for the most part not by law but by custom, and considered as binding in respect of the king himself; so that, although he was sovereign, he could neither abrogate, nor modify, nor violate them. There was, however, some discussion as to what rules actually came under this category, except in the case of two series about which there was no doubt. These were, on the one hand, those which dealt with the succession to the crown and forbade the king to change its order, and those which proclaimed the inalienability of the royal domain, against which no title by prescription was valid. This last principle, introduced in the 14th century, had been laid down and defined by the edict of Moulins in 1566; it admitted only two exceptions: the formation of appanages (*q.v.*), and selling (*engagement*), to meet the necessities of war, with a perpetual option of redeeming it.

There was in the second place the theory of the rights, franchises and liberties of the Gallican Church, formed of elements some of which were of great antiquity, and based on the conditions which had determined the relations of the Gallican Church with the crown and papacy during the Great Schism and under the Pragmatic Sanction of Bourges, and defined at the end of the 16th and the beginning of the 17th century. This body of doctrine was defined by the writings of three men especially, Guy Coquille, Pierre Pithou and Pierre Dupuy, and was solemnly confirmed by the declaration of the clergy of France, or *Déclaration des quatre articles* of 1682, and by the edict which promulgated it. Its substance was based chiefly on three principles: firstly, that the temporal power was absolutely independent of the spiritual power; secondly, that the pope had authority over the clergy of France in temporal matters and matters of

discipline only by the consent of the king; thirdly, that the king had authority over and could legislate for the Gallican Church in temporal matters and matters of discipline. The old public law provided a safeguard against the violation of these rules. This was the process known as the *appel comme d'abus*, formed of various elements, some of them very ancient, and definitely established during the 16th century. It was heard before the parlements, but could, like every other case, be evoked before the royal council. Its effect was to annul any act of the ecclesiastical authority due to abuse or contrary to French law. The clergy were, when necessary, reduced to obedience by means of arbitrary fines and by the seizure of their temporalities. The Pragmatic Sanction had been abrogated and replaced by the Concordat of 1515, concluded between Francis I. and Leo X., which remained in force until suppressed by the Constituent Assembly. The Concordat, moreover, preserved many of the enactments of the Pragmatic Sanction, notably those which protected the collation of the inferior benefices from the encroachments of the papacy, and which had introduced reforms in certain points of discipline. But in the case of the superior benefices (bishoprics and abbeys) election by the chapters was suppressed. The king of France nominated the candidate, to whom the pope gave canonical institution. As a matter of fact, the pope had no choice; he had to institute the nominee of the king, unless he could show his unworthiness or incapacity, as the result of inquiries regularly conducted in France; for the pope it was, as the ancient French authors used to say, a case of compulsory collation. The annates were re-established at the time of the Concordat, but considerably diminished in comparison with what they had been before the Pragmatic Sanction. We must add, to complete this account, that many of the inferior benefices, in France as in the rest of Christendom, were conferred according to the rules of patronage, the patron, whether lay or ecclesiastic, presenting a candidate whom the bishop was bound to appoint, provided he was neither incapable nor unsuitable. There was some difficulty in getting the Concordat registered by the parlement of Paris, and the latter even announced its intention of not taking the Concordat into account in those cases concerning benefices which might come before it. The crown found an easy method of making this opposition ineffectual, namely, to transfer to the Grand Conseil the decision of cases arising out of the application of the Concordat.

In the 16th century also, contributions to the public services drawn from the immense possessions of the clergy were regularized. Since the second half of the 12th century at least, the kings had in times of urgent need asked for subsidies from the church, and ever since the Saladin tithe (*dîme saladin*) of Philip Augustus this contribution had assumed the form of a tithe, taking a tenth part of the revenue of the benefices for a given period. Tithes of this kind were fairly frequently granted by the clergy of France, either with the pope's consent or without (this being a disputed point). After the conclusion of the Concordat, Leo X. granted the king a tithe (*décime*) under the pretext of a projected war against the Turks; hitherto concessions of this kind had been made by the papacy in view of the Crusades or of wars against heretics. The concession was several times renewed, until, by force of custom, the levying of these tithes became permanent. But in the middle of the 16th century the system changed. The crown was heavily in debt, and its needs had increased. The property of the clergy having been threatened by the states general of 1560 and 1561, the king proposed to them to remit the bulk of the tithes and other dues, in return for the payment by them of a sum equivalent to the proceeds of the taxes which he had mortgaged. A formal contract to this effect was concluded at Poissy in 1561 between the king and the clergy of France, represented by the prelates who were then gathered together for the Colloquy of Poissy with the Protestants, and some of those who had been sitting at the states general of Pontoise. The fulfilment of this agreement was, however, evaded by the king, who diverted part of the funds provided by the clergy from their proper purpose. In 1580,

after a period of ten years which had been agreed on, a new assembly of the clergy was called together and, after protesting against this action, renewed the agreement, which was henceforward always renewed every ten years. Such was the definitive form of the contribution of the clergy, who also acquired the right of themselves assessing and levying these taxes on the holders of benefices. Thus every ten years there was a great assembly of the clergy, the members of which were elected. There were two stages in the election, a preliminary one in the dioceses and a further election in the ecclesiastical provinces, each province sending four deputies to the general assembly, two of the first rank, that is to say, chosen from the episcopate, and two of the second rank, which included all the other clergy. The *dons gratuits* (benevolences) voted by the assembly comprised a fixed sum equivalent to the old tithes and supplementary sums paid on one occasion only, which were sometimes considerable. The church, on her side, profited by this arrangement in order to obtain the commutation or redemption of the taxes affecting ecclesiastics considered as individuals. This settlement only applied to the "clergy of France," that is to say, to the clergy of those districts which were united to the crown before the end of the 16th century. The provinces annexed later, called *pays étrangers*, or *pays conquis*, had in this matter, as in many others, an arrangement of their own. At last, under Louis XV. the edict of 1749, *concernant les établissements et acquisitions des gens de mainmorte*, was completely effective in subordinating the acquisition of property by ecclesiastical establishments to the consent and control of the crown, rendering them incapable of acquiring real property by bequests.

At the end of the 16th century a wise law had been made which, in spite of the traces which it bore of past struggles, had established a reasonable balance among the Christians of France. The edict of Nantes, in 1598, granted the Protestants full civil rights, liberty of conscience and public worship in many places, and notably in all the royal *bailliages*. The Catholics, whose religion was essentially a state religion, had never accepted this arrangement as final, and at last, in 1685, under Louis XIV., the edict of Nantes was revoked and the Protestant pastors expelled from France. Their followers were forbidden to leave the country, but many succeeded nevertheless in escaping abroad. The position of those who remained behind was peculiar. Laws passed in 1715 and 1724 established the legal theory that there were no longer any Protestants in France, but only *vieux catholiques* and *nouveaux convertis*. The result was that henceforth they had no longer any regular civil status, the registers containing the lists of Catholics enjoying civil rights being kept by the Catholic clergy.

The form of government established under Louis XIV. was preserved without any fundamental modification under Louis XV. After the death of Louis XIV., however, the regent, under the inspiration of the duc de St Simon, made trial of a system of which the latter had made a study while in a close correspondence with the duke of Burgundy. It consisted in substituting for the authority of the ministers, secretaries of state and controller-general councils, or governmental bodies, mainly composed of great lords and prelates. These only lasted for a few years, when a return was made to the former organization. The parlements had regained their ancient rights in consequence of the parlement of Paris having, in 1715, set aside the will of Louis XIV. as being contrary to the fundamental laws of the kingdom, in that it laid down rules for the composition of the council of regency, and limited the power of the regent. This newly revived power they exercised freely, and all the more so since they were the last surviving check on the royal authority. During this reign there were numerous conflicts between them and the government, the causes of this being primarily the innumerable incidents to which the bull *Unigenitus* gave rise, and the increase of taxation; proceedings against Jesuits also figure conspicuously in the action of the parlements. They became at this period the avowed representatives of the nation; they contested the validity of the registration of laws in the *lits de justice*, asserting that laws could only be made obligatory when the registration

had been freely endorsed by themselves. Before the registration of edicts concerning taxation they demanded a statement of the financial situation and the right of examining the accounts. Finally, by the theory of the *classes*, which considered the various parlements of France as parts of one and the same body, they established among them a political union. These pretensions the crown refused to recognize. Louis XV. solemnly condemned them in a *lit de justice* of December 1770, and in 1771 the chancellor Maupeou took drastic measures against them. The magistrates of the parlement of Paris were removed, and a new parlement was constituted, including the members of the *grand conseil*, which had also been abolished. The *cour des aides* of Paris, which had made common cause with the parlement, was also suppressed. Many of the provincial parlements were reorganized, and a certain number of useful reforms were carried out in the jurisdiction of the parlement of Paris; the object of these, however, was in most cases that of diminishing its importance. These actions, the *coup d'état* of the chancellor Maupeou, as they were called, produced an immense sensation. The repeated conflicts of the reign of Louis XV. had already given rise to a whole literature of books, pamphlets and tracts in which the rights of the crown were discussed. At the same time the political philosophy of the 18th century was disseminating new principles, and especially those of the supremacy of the people and the differentiation of powers, the government of England also became known among the French. Thus men's minds were being prepared for the Revolution.

The personal government of Louis XVI. from 1774 to 1789 was chiefly marked by two series of facts. Firstly, there was the partial application of the principles propounded by the French economists of this period, the Physiocrats, who had a political doctrine peculiar to themselves. They were not in favour of political liberty, but attached on the contrary to the absolute monarchy, of which they did not fear the abuses because they were convinced that so soon as they should be known, reason (*évidence*) alone would suffice to make the crown respect the "natural and essential laws of bodies politic" (*Lois naturelles et essentielles des sociétés politiques*, the title of a book by Mercier de La Rivière). On the other hand, they favoured civil and economic liberty. They wished, in particular, to decentralize the administration and restore to the landed proprietors the administration and levying of taxes, which they wished to reduce to a tax on land only. This school came into power with Turgot, who was appointed controller-general of the finances, and laid the foundations of many reforms. He actually accomplished for the moment one very important reform, namely, the suppression of the trade and craft guilds (*communautés, jurandes et maîtrises*). This organization, which was common to the whole of Europe (see GILDS), had taken definitive shape in France in the 13th and 14th centuries, but had subsequently been much abused. Turgot suppressed the privileges of the *maîtres*, who alone had been able to work on their own account, or to open shops and workshops, and thus proclaimed the freedom of labour, industry and commerce. However, the old organization, slightly amended, was restored under his successor Necker. It was Turgot's purpose to organize provincial and other inferior assemblies, whose chief business was to be the assessment of taxes. Necker applied this idea, partially and experimentally, by creating a few of these provincial assemblies in various *généralités* of the *pays d'élections*. A general reform on these lines and on a very liberal basis was proposed by Calonne to the assembly of notables in 1787, and it was brought into force for all the *pays d'élections*, though not under such good conditions, by an edict of the same year. Louis XVI. had inaugurated his reign by the restoration of the parlements; all the bodies which had been suppressed by Maupeou and all the officials whom he had dismissed were restored, and all the bodies and officials created by him were suppressed. But it was not long before the old struggle between the crown and parlements again broke out. It began by the conservative opposition offered by the parlement of Paris to Turgot's reforms. But the real struggle broke out in 1787

over the edicts coming from the assembly of notables, and particularly over the two new taxes, the stamp duty and the land tax. The parlement of Paris refused to register them, asserting that the consent of the taxpayers, as represented by the states general, was necessary to fresh taxation. The struggle seemed to have come to an end in September; but in the following November it again broke out, in spite of the king's promise to summon the states general. It reached its height in May 1788, when the king had created a *cour plénière* distinct from the parlements, the chief function of which was to register the laws in their stead. A widespread agitation arose, amounting to actual anarchy, and was only ended by the recall of Necker to power and the promise to convoke the states general for 1789.

Various Institutions.—The permanent army which, as has been stated above, was first established under Charles VII., was developed and organized during the *ancien régime*. The *gendarmerie* or heavy cavalry was continuously increased in numbers. On the other hand, the *francs archers* fell into disuse after Louis XI.; and, after a fruitless attempt had been made under Francis I. to establish a national infantry, the system was adopted for this also of recruiting permanent bodies of mercenaries by voluntary enlistment. First there were the "old bands" (*vieilles bandes*), chiefly those of Picardy and Piedmont, and at the end of the 16th century appeared the first regiments, the number of which was from time to time increased. There were also in the service and pay of the king French and foreign regiments, the latter principally Swiss, Germans and Scots. The system of purchase penetrated also to the army. Each regiment was the property of a great lord; the captain was, so to speak, owner of his company, or rather a contractor, who, in return for the sums paid him by the king, recruited his men and gave them their uniform, arms and equipment. In the second half of the reign of Louis XIV. appeared the militia (*milices*). To this force each parish had to furnish one recruit, who was at first chosen by the assembly of the inhabitants, later by drawing lots among the bachelors or widowers without children, who were not exempt. The militia was very rarely raised from the towns. The purpose for which these men were employed varied from time to time. Sometimes, as under Louis XIV., they were formed into special active regiments. Under Louis XV. and Louis XVI. they were formed into *régiments provinciaux*, which constituted an organized reserve. But their chief use was during war, when they were individually incorporated into various regiments to fill up the gaps.

Under Louis XV., with the duc de Choiseul as minister of war, great and useful reforms were effected in the army. Choiseul suppressed what he called the "farming of companies" (*compagnie-ferme*); recruiting became a function of the state, and voluntary enlistment a contract between the recruit and the state. Arms, uniform and equipment were furnished by the king. Choiseul also equalized the numbers of the military units, and his reforms, together with a few others effected under Louis XVI., produced the army which fought the first campaigns of the Revolution.

One of the most distinctive features of the *ancien régime* was excessive taxation. The taxes imposed by the king were numerous, and, moreover, hardly any of them fell on all parts of the kingdom. To this territorial inequality was added the inequality arising from privileges. Ecclesiastics, nobles, and many of the crown officials were exempted from the heaviest imposts. The chief taxes were the *taille* (*q.v.*), the *aides* and the *gabelle* (*q.v.*), or monopoly of salt, the consumption of which was generally made compulsory up to the amount determined by regulations. In the 17th and 18th centuries certain important new taxes were established: from 1695 to 1698 the *capitation*, which was re-established in 1701 with considerable modifications, and in 1710 the tax of the *dixième*, which became under Louis XV. the tax of the *vingtièmes*. These two imposts had been established on the principle of equality, being designed to affect every subject in proportion to his income; but so strong was the system of privileges, that

as a matter of fact the chief burden fell upon the roturiers. The income of a roturier who was not exempt was thus subject in turn to three direct imposts: the *taille*, the *capitation* and the *vingtièmes*, and the apportioning or assessment of these was extremely arbitrary. In addition to indirect taxation strictly so called, which was very extensive in the 17th and 18th centuries, France under the *ancien régime* was subject to the *traites*, or customs, which were not only levied at the frontiers on foreign trade, but also included many internal custom-houses for trade between different provinces. Their origin was generally due to historical reasons; thus, among the *provinces repeülées étrangères* were those which in the 14th century had refused to pay the aids for the ransom of King John, also certain provinces which had refused to allow customs offices to be established on their foreign frontier. Colbert had tried to abolish these internal duties, but had only succeeded to a limited extent.

The indirect taxes, the *traites* and the revenues of the royal domain were farmed out by the crown. At first a separate contract had been made for each impost in each *élection*, but later they were combined into larger lots, as is shown by the name of one of the customs districts, *l'enceinte des cinq grosses fermes*. From the reign of Henry IV. on the levying of each indirect impost was farmed *en bloc* for the whole kingdom, a system known as the *fermes générales*; but the real *ferme générale*, including all the imposts and revenues which were farmed in the whole of France, was only established under Colbert. The *ferme générale* was a powerful company, employing a vast number of men, most of whom enjoyed various privileges. Besides the royal taxes, seigniorial imposts survived under the form of tolls and market dues. The lords also often possessed local monopolies, e.g. the right of the common bakehouse (*four banal*), which were called the *banalités*.

The organization of the royal courts of justice underwent but few modifications during the *ancien régime*. The number of parlements, of *cours des aides* and of *cours des comptes* increased; in the 17th century the name of *conseil supérieur* was given to some new bodies which actually discharged the functions of the parlement, this being the period of the decline of the parlement. In the 16th century, under Henry II., had been created *présidiaux*, or courts of final jurisdiction, intended to avoid numerous appeals in small cases, and above all to avoid a final appeal to the parlements. Seigniorial courts survived, but were entirely subordinate to the royal jurisdictions and were badly officered by ill-paid and ignorant judges, the lords having long ago lost the right to sit in them in person. Their chief use was to deal with cases concerning the payment of feudal dues to the lord. Both lawyers and people would have preferred only two degrees of justice; and an ordinance of May 1788 realized this desire in the main. It did not suppress the seigniorial jurisdictions, but made their extinction a certainty by allowing litigants to ignore them and go straight to the royal judges. This was, however, reversed on the recall of Necker and the temporary triumph of the parlements.

The ecclesiastical jurisdictions survived to the end, but with diminished scope. Their competency had been considerably reduced by the Ordinance of Villers Cotterets of 1539, and by an edict of 1693. But a series of ingenious legal theories had been principally efficacious in gradually depriving them of most of the cases which had hitherto come under them. In the 18th century the privilege of clergy did not prevent civil suits in which the clergy were defendants from being almost always taken before secular tribunals, and ever since the first half of the 17th century, for all grave offences, or *cas privilégiés*, the royal judge could pronounce a sentence of corporal punishment on a guilty cleric without this necessitating his previous degradation. The inquiry into the case was, it is true, conducted jointly by the royal and the ecclesiastical judge, but each of them pronounced his sentence independently. All cases concerning benefices came before the royal judges. Finally, the *officialités* had no longer as a rule any jurisdiction over laymen, even in the matter of marriage, except in questions of betrothals, and sometimes in cases of opposition to marriages.

Courts of law.

Ecclesiastical courts.

System of taxation.

The parish priests, however, continued to enter declarations of baptisms, marriages and burials in registers kept according to the civil laws.

The general customs of the *pays coutumiers* were almost all officially recorded in the 16th century, definite procedure for this purpose having been adopted at the end of the 15th century. Drafts were prepared by the officials of the royal courts in the chief town of the district in which the particular customs were valid, and were then submitted to the government. The king then appointed commissioners to visit the district and promulgate the customs on the spot. For the purpose of this *publication* the lords, lay and ecclesiastical, of the district, with representatives of the towns and of various bodies of the inhabitants, were summoned for a given day to the chief town. In this assembly each article was read, discussed and put to the vote. Those which were approved by the majority were thereupon decreed (*décrétés*) by the commissioners in the king's name; those which gave rise to difficulties were put aside for the parlement to settle when it registered the *coutume*. The *coutumes* in this form became practically written law; henceforward their text could only be modified by a formal revision carried out according to the same procedure as the first version. Throughout the 16th century a fair number of *coutumes* were thus revised (*reformées*), with the express object of profiting by the observations and criticisms on the first text which had appeared in published commentaries and notes, the most important of which were those of Charles Dumoulin. In the 16th century there had been a revival of the study of Roman law, thanks to the historical school, among the most illustrious representatives of which were Jacques Cujas, Hugues Doneau and Jacques Godefroy; but this study had only slight influence on practical jurisprudence. Certain institutions, however, such as contracts and obligations, were regulated throughout the whole of France by the principles of Roman law.

Legislation by *ordonnances*, *édits*, *déclarations* or *lettres patentes*, emanating from the king, became more and more frequent; but the character of the *grandes ordonnances*, which were of a far-reaching and comprehensive nature, underwent a change during this period. In the 14th, 15th and 16th centuries they had been mainly *ordonnances de réformation* (i.e. revising previous laws), which were most frequently drawn up after a sitting of the states general, in accordance with the suggestions submitted by the deputies. The last of this type was the ordinance of 1629, promulgated after the states general of 1614 and the assemblies of notables which had followed it. In the 17th and 18th centuries they became essentially *codifications*, comprising a systematic and detailed statement of the whole branch of law. There are two of these series of codifying ordinances: the first under Louis XIV., inspired by Colbert and carried out under his direction. The chief ordinances of this group are that of 1667 on civil procedure (code of civil procedure); that of 1670 on the examination of criminal cases (code of penal procedure); that of 1673 on the commerce of merchants, and that of 1681 on the regulation of shipping, which form between them a complete code of commerce by land and sea. The ordinance of 1670 determined the formalities of that secret and written criminal procedure, as opposed to the hearing of both parties in a suit, which formerly obtained in France; it even increased its severity, continuing the employment of torture, binding the accused by oath to speak the truth, and refusing them counsel save in exceptional cases. The second series of codifications was made under Louis XV., through the action of the chancellor d'Aguesseau. Its chief result was the regulation, by the ordinances of 1731, 1735 and 1747, of deeds of gift between living persons, wills, and property left in trust. Under Louis XVI. some mitigation was made of the criminal law, notably the abolition of torture.

The feudal régime, in spite of the survival of seigniorial courts and tolls, was no longer of any political importance; but it still furnished the common form of real property. The fief, although it still implied homage from the vassal, no longer involved any service on his part (excepting that of the *arrière-ban* due to the

king); but when a fief changed hands the lord still exacted his *profits*. Tenures held by *roturiers*, in addition to some similar rights of transfer, were generally subject to periodical and fixed contributions for the profit of the lord. This system was still further complicated by tenures which were simply real and not feudal, e.g. that by payment of ground rent, which were superadded to the others, and had become all the heavier since, in the 18th century, royal rights of transfer had been added to the feudal rights. The inhabitants of the country districts were longing for the liberation of real property.

Serfdom had disappeared from most of the provinces of the kingdom; among all the *coutumes* which were officially codified, not more than ten or so still recognized this institution. This had been brought about especially by the agency of the custom by which serfs had been transformed into *roturiers*. An edict of Louis XVI. of 1779 abolished serfdom on crown lands, and mitigated the condition of the serfs who still existed on the domains of individual lords. The nobility still remained a privileged class, exempt from certain taxes. Certain offices were restricted to the nobility; according to an edict of Louis XVI. (1781) it was even necessary to be a noble in order to become an officer in the army. In fact, the royal favours were reserved for the nobility. Certain rules of civil and criminal procedure also distinguished nobles from *roturiers*. The acquisition of fiefs had ceased to bring nobility with it, but the latter was derived from three sources: birth, *lettres d'anoblissement* granted by the king and appointment to certain offices. In the 17th and 18th centuries the peers of France can be reckoned among the nobility, forming indeed its highest grade, though the rank of peer was still attached to a fief, which was handed down with it; on the eve of the Revolution there were thirty-eight lay peers. The rest of the nation, apart from the ecclesiastics, consisted of the *roturiers*, who were not subject to the disabilities of the serfs, but had not the privileges of the nobility. Hence the three orders (estates) of the kingdom: the clergy, the nobility and the *tiers état* (third estate). An edict of Louis XVI. had made a regular civil status possible to the Protestants, and had thrown open offices and professions to them, though not entirely; but the exercise of their religion was still forbidden.

The Revolution.—With the Revolution France entered the ranks of constitutional countries, in which the liberty of men is guaranteed by fixed and definite laws; from this time on, she has had always (except in the interval between two revolutions) a written constitution, which could not be touched by the ordinary legislative power. The first constitution was that of 1791; the states general of 1789, transformed by their own will, backed by public opinion, into the Constituent Assembly, drew it up on their own authority. But their work did not stop there. They abolished the whole of the old public law of France and part of the criminal law, or rather, transformed it in accordance with the principles laid down by the political philosophy of the 18th century. The principles which were then proclaimed are still, on most points, the foundation of modern French law. The development resulting from this extraordinary impetus can be divided into two quite distinct phases: the first, from 1789 to the *coup d'état* of the 18th Brumaire in the year VIII., was the continuation of the impulse of the Revolution; the second includes the Consulate and the first Empire, and was, as it were, the marriage or fusion of the institutions arising from the Revolution with those of the *ancien régime*.

On the whole, the constitutional law of the Revolution is a remarkably united whole, if we consider only the two constitutions which were effectively applied during this first phase, that of the 3rd of September 1791, and that of the 5th Fructidor in the year III. It is true that between them occurred the ultra-democratic constitution of the 24th of June 1793, the first voted by the Convention; but although this was ratified by the popular vote, to which it had been directly submitted, in accordance with a principle proclaimed by the Convention and kept in force under the Consulate

Land
tenure.

Serfdom.

The three
estates.The Con-
stitutions
of the
Revolution.

and the Empire, it was never carried into effect. It was first suspended by the establishment of the revolutionary government strictly so called, and after Thermidor, under the pretext of completing it, the Convention put it aside and made a new one, being taught by experience. As long as it existed it was the sovereign assembly of the Convention itself which really exercised the executive power, governing chiefly by means of its great committees.

The constitution of 1791 was without doubt monarchical, in so far as it preserved royalty. The constitution of the year III. was, on the contrary, republican. The horror of monarchy was still so strong at that time that an executive college was created, a Directory of five members, one of whom retired every year; they were elected by a complicated and curious procedure, in which each of the two legislative councils played a distinct part. But this difference, though apparently essential, was not in reality very profound; this is proved, for example, by the fact that the Directory had distinctly more extensive powers than those conferred on Louis XVI. by the Constituent Assembly. On almost all points of importance the two constitutions were similar. They were both preceded by a statement of principles, a "Declaration of the Rights of Man and of the Citizen." They were both based on two principles which they construed alike: the sovereignty of the people and the separation of powers. Both of them (with the exception of what has been said with regard to the ratification of constitutions after 1793) recognized only representative government. From the principle of the sovereignty of the people they had not deduced universal suffrage; though, short of this, they had extended the suffrage as far as possible. According to the constitution of 1791, in addition to the conditions of age and residence, an elector was bound to pay a direct contribution equivalent to three days' work; the constitution of the year III. recognized the payment of any direct contribution as sufficient; it even conferred on every citizen the right of having himself enrolled, without any other qualification than a payment equivalent to three days' work, and thus to become an elector. Further, neither of the two constitutions admitted of a direct suffrage; the elections were carried out in two stages, and only those who paid at a higher rating could be chosen as electors for the second stage. The executive power, which was in the case of both constitutions clearly separated from the legislative, could not initiate legislation. The Directory had no veto; Louis XVI. had with difficulty obtained a merely suspensive veto, which was overridden in the event of three legislatures successively voting against it. The right of dissolution was possessed by neither the king nor the Directory. Neither the king's ministers nor those of the Directory could be members of the legislative body, nor could they even be chosen from among its ranks. The ministers of Louis XVI. had, however, thanks to an unfortunate inspiration of the Constituent Assembly of 1791, the right of entry to, and, to a certain extent, of speaking in the Legislative Assembly; the constitution of the year III. showed greater wisdom in not bringing them in any way into contact with the legislative power. The greatest and most notable difference between the two constitutions was that that of 1791 established a single chamber which was entirely renewed every two years; that of the year III., on the contrary, profiting by the lessons of the past, established two chambers, one-third of the members of which were renewed every year. Moreover, the two chambers, the Council of Five Hundred and the Council of Ancients, were appointed by the same electors, and almost the only difference between their members was that of age.

The Revolution entirely abolished the *ancien régime*, and in the first instance whatever remained of feudalism. The Constituent Assembly, in the course of its immense work of settlement, wished to draw distinctions, abolishing absolutely, without indemnity, all rights which had amounted in the beginning to a usurpation and could not be justified, e.g. serfdom and seigniorial courts of justice. On the other hand, it declared subject to redemption such feudal charges as had been the subject of contract or of a concession of lands. But as it was almost impossible to discover the exact

origin of various feudal rights, the Assembly had proceeded to do this by means of certain legal assumptions which sometimes admitted of a proof to the contrary. It carefully regulated the conditions and rate of repurchase, and forbade the creation in the future of any perpetual charge which could not be redeemed: a principle that has remained permanent in French law. This was a rational and equitable solution; but in a period of such violent excitement it could not be maintained. The Legislative Assembly declared the abolishment without indemnity of all feudal rights for which the original deed of concession could not be produced; and to produce this was, of course, in most cases impossible. Finally, the Convention entirely abolished all feudal rights, and commanded that the old deeds should be destroyed; it maintained on the contrary, though subject to redemption, those tenures and charges which were solely connected with landed property and not feudal.

With feudalism had been abolished serfdom. Further, the Constituent Assembly suppressed nobility; it even forbade any one to assume and bear the titles, emblems and arms of nobility. Thus was established the equality of citizens before the law. The Assembly also proclaimed the liberty of labour and industry, and suppressed the corporations of artisans and workmen, the *jurandes* and *matrises*, as Turgot had done. But, in order to maintain this liberty of the individual, it forbade all associations between workers or employers, fearing that such contracts would again lead to the formation of corporations similar to the old ones. It even forbade and declared punishable, as being contrary to the declaration of the rights of man and the citizen, combinations or strikes, or an agreement between workmen or employers to refuse to work or to give work except on given conditions. Such, for a long time, was French legislation on this point.

The Constituent Assembly gave to France a new administrative division, that into departments, districts, cantons and communes; and this division, which was intended to make the old provincial distinctions disappear, had to serve all purposes, the department being the unit for all public services. This settlement was definitive, with the exception of certain modifications in detail, and exists to the present day. But there was a peculiar administrative organism depending on this arrangement. The constitution of 1791, it is true, made the king the titular head of the executive power; but the internal administration of the kingdom was not actually in his hands. It was deputed, under his orders, to bodies elected in each department, district and commune. The municipal bodies were directly elected by citizens duly qualified; other bodies were chosen by the method of double election. Each body consisted of two parts: a council, for deliberative purposes, and a *bureau* or *directoire* chosen by the council from among its numbers to form the executive. These were the only instruments for the general administration and for that of the direct taxes. The king could, it is true, annul the illegal acts of these bodies, but not dismiss their members; he could merely suspend them from exercising their functions, but the matter then went before the Legislative Assembly, which could maintain or remit the suspension as it thought fit. The king had not a single agent chosen by himself for general administrative purposes. This was a reaction, though a very exaggerated one, against the excessive centralization of the *ancien régime*, and resulted in an absolute administrative anarchy. The organization of the revolutionary government partly restored the central authority; the councils of the departments were suppressed; the Committee of Public Safety and the "representatives of the people on mission" were able to remove and replace the members of the elected bodies; and also, by an ingenious arrangement, national agents were established in the districts. The constitution of the year III. continued in this course, simplifying the organization established by the Constituent Assembly, while maintaining its principle. The department had an administration of five members, elected as in the past, but having executive as well as deliberative functions. The district was suppressed. The communes retained only a

Admini-
strative
reorgani-
zation.

municipal agent elected by themselves, and the actual municipal body, the importance of which was considerably increased, was removed to the canton, and consisted of the municipal agents from each commune, and a president elected by the duly qualified citizens of the canton. The Directory was represented in each departmental and communal administration by a commissary appointed and removable by itself, and could dismiss the members of these administrations.

The Constituent Assembly decided on the complete reorganization of the judicial organization. This was accomplished on a

Judicial system. very simple plan, which realized that ideal of the two degrees of justice which, as we have noticed, was that of France under the *ancien régime*. In the lower degrees it created in each canton a justice of the peace (*juge de paix*), the idea and name of which were borrowed from England, but which differed very much from the English justice of the peace. He judged, both with and without appeal, civil cases of small importance; and, in cases which did not come within his competency, it was his duty to try to reconcile the parties. In each district was established a civil court composed of five judges. This completed the judicial organization, except for the court of cassation, which had functions peculiar to itself, never judging the facts of the case but only the application of the law. For cases coming under the district court, the Assembly had not thought fit to abolish the guarantee of the appeal in cases involving sums above a certain figure. But by a curious arrangement the district tribunals could hear appeals from one another. With regard to penal prosecutions, there was in each department a criminal court which judged crimes with the assistance of a jury; it consisted of judges borrowed from district courts, and had its own president and public prosecutor. Correctional tribunals, composed of *juges de paix*, dealt with misdemeanours. The Assembly preserved the commercial courts, or consular jurisdictions, of the *ancien régime*. There was a court of cassation, the purpose of which was to preserve the unity of jurisprudence in France; it dealt with matters of law and not of fact, considering appeals based on the violation of law, whether in point of matter or of form, and if such violation were proved, sending the matter before another tribunal of the same rank for re-trial. All judges were elected for a term of years; the *juges de paix* by the primary assembly of the canton, the district judges by the electoral assembly consisting of the electors of the second degree for the district, the members of the court of cassation by the electors of the departments, who were divided for the purpose into two series, which voted alternately. The Constituent Assembly did, it is true, require professional guarantees, by proof of a more or less extended exercise of the profession of lawyer from all judges except the *juges de paix*. But the system was really the same as that of the administrative organization. The king only appointed the *commissaires du roi* attached to the district courts, criminal tribunals and the court of cassation; but the appointment once made could not be revoked by him. These commissaries fulfilled one of the functions of the old *ministère public*, their duty being to demand the application of laws. The Convention did not change this general organization; but it suppressed the professional guarantees required in the case of candidates for a judgeship, so that henceforth all citizens were eligible; and it also caused new elections to take place. Moreover, the Convention, either directly or by means of one of its committees, not infrequently removed and replaced judges without further election. The constitution of the year III. preserved this system, but introduced one considerable modification. It suppressed the district courts, and in their place created in each department a civil tribunal consisting of twenty judges. The idea was a happy one, for it gave the courts more importance, and therefore more weight and dignity. But this reform, beneficial as it would be nowadays, was at the time premature, in view of the backward condition of means of communication.

The Constituent Assembly suppressed the militia and maintained the standing army, according to the old type, the numbers of which were henceforth to be fixed every year by the Legis-

lative Assembly. The army was to be recruited by voluntary enlistment, careful rules for which were drawn up; the only change was in the system of appointment to ranks; **The army.** promotion went chiefly by seniority, and in the lower ranks a system of nomination by equals or inferiors was organized. The Assembly proclaimed, however, the principle of compulsory and personal service, but under a particular form, that of the National Guard, to which all qualified citizens belonged, and in which almost all ranks were conferred by election. Its chief purpose was to maintain order at home; but it could be called upon to furnish detachments for defence against foreign invasion. This was an institution which, with many successive modifications, and after various long periods of inactivity followed by a revival, lasted more than three-quarters of a century, and was not suppressed till 1871. For purposes of war the Convention, in addition to voluntary enlistments and the resources furnished by the National Guards, and setting aside the forced levy of 200,000 men in 1793, decided on the expedient of calling upon the communes to furnish men, a course which revived the principle of the old militia. But the Directory drew up an important military law, that of the 6th Fructidor of the year VI., which established compulsory military service for all, under the form of conscription strictly so called. Frenchmen aged from 20 to 25 (*défenseurs conscrits*) were divided into five classes, each including the men born in the same year, and were liable until they were 25 years old to be called up for active service, the whole period of service not exceeding four years. No class was called upon until the younger classes had been exhausted, and the sending of substitutes was forbidden. This law, with a few later modifications, provided for the French armies up to the end of the Empire.

The Constituent Assembly abolished nearly all the taxes of the *ancien régime*. Almost the only taxes preserved were the stamp duty and that on the registration of acts **Taxation.** (the old *contrôle* and *centième denier*), and these were completely reorganized; the customs were maintained only at the frontiers for foreign trade. In the establishment of new taxes the Assembly was influenced by two sentiments: the hatred which had been inspired by the former arbitrary taxation, and the influence of the school of the Physiocrats. Consequently it did away with indirect taxation on objects of consumption, and made the principal direct tax the tax on land. Next in importance were the *contribution personnelle et mobilière* and the *patentes*. The essential elements of the former were a sort of capitation-tax equivalent to three days' work, which was the distinctive and definite sign of a qualified citizen, and a tax on personal income, calculated according to the rent paid. The *patentes* were paid by traders, and were also based on the amount of rent. These taxes, though considerably modified later, are still essentially the basis of the French system of direct taxation. The Constituent Assembly had on principle repudiated the tax on the gross income, much favoured under the *ancien régime*, which everybody had felt to be arbitrary and oppressive. The system of public contributions under the Convention was arbitrary and revolutionary, but the councils of the Directory, side by side with certain bad laws devised to tide over temporary crises, made some excellent laws on the subject of taxation. They resumed the regulation of the land tax, improving and partly altering it, and also dealt with the *contribution personnelle et mobilière*, the *patentes*, and the stamp and registration duties. It was at this time, too, that the door and window tax, which still exists, was provisionally established; there was also a partial reappearance of indirect taxation, in particular the *octrois* of the towns, which had been suppressed by the Constituent Assembly.

The Constituent Assembly gave the Protestants liberty of worship and full rights; it also gave Jews the status of citizen, which they had not had under the *ancien régime*, **Religious liberty.** together with political rights. With regard to the Catholic Church, the Assembly placed at the disposal of the nation the property of the clergy, which had already, in the course of the 18th century, been regarded by most political

writers as a national possession; at the same time it provided for salaries for the members of the clergy and pensions for those who had been monks. It abolished tithes and the religious orders, and forbade the re-formation of the latter in the future. The ecclesiastical districts were next reorganized, the department being always taken as the chief unit, and a new church was organized by the civil constitution of the clergy, the bishops being elected by the electoral assembly of the department (the usual electors), and the curés by the electoral assembly of the district. This was an unfortunate piece of legislation, inspired partly by the old Gallican spirit, partly by the theories on civil religion of J. J. Rousseau and his school, and, together with the civic oath imposed on the clergy, it was a source of endless troubles. The constitutional church established in this way was, however, abolished as a state institution by the Convention. By laws of the years III. and IV. the Convention and the Directory, in proclaiming the liberty of worship, declared that the Republic neither endowed nor recognized any form of worship. Buildings formerly consecrated to worship, which had not been alienated, were again placed at the disposal of worshippers for this purpose, but under conditions which were hard for them to accept.

The Assemblies of the Revolution, besides the laws which, by abolishing feudalism, altered the character of real property, passed many others concerning civil law. The most important are those of 1792, passed by the Legislative Assembly, which organized the registers of the *état civil* kept by the municipalities, and laid down rules for marriage as a purely civil contract. Divorce was admitted to a practically unlimited extent; it was possible not only for causes determined by law, and by mutual consent, but also for incompatibility of temper and character proved, by either husband or wife, to be of a persistent nature. Next came the laws of the Convention as to inheritance, imposing perfect equality among the natural heirs and endeavouring to ensure the division of properties. Illegitimate children were considered by these laws as on the same level with legitimate children. The Convention and the councils of the Directory also made excellent laws on the administration of *hypothèques*, and worked at the preparation of a

Criminal law.

Civil Code (see CODE NAPOLÉON). In criminal law their work was still more important. In 1791 the Constituent Assembly gave France her first penal code. It was inspired by humanitarian ideas, still admitting capital punishment, though accompanied by no cruelty in the execution; but none of the remaining punishments was for life. Long imprisonment with hard labour was introduced. Finally, as a reaction against the former system of arbitrary penalties, there came a system of fixed penalties determined, both as to its assessment and its nature, for each offence, which the judge could not modify. The Constituent Assembly also reformed the procedure of criminal trials, taking English law as model. It introduced the jury, with the double form of *jury d'accusation* and *jury de jugement*. Before the judges procedure was always public and oral. The prosecution was left in principle to the parties concerned, plaintiffs or *dénonciateurs civils*, and the preliminary investigation was handed over to two magistrates; one was the *jugé de paix*, as in English procedure at this period, and the other a magistrate chosen from the district court and called the *directeur du jury*. The Convention, before separating, passed the *Code des délits et des peines* of the 3rd Brumaire in the year IV. This piece of work, which was due to Merlin de Douai, was intended to deal with criminal procedure and penal law; but only the first part could be completed. It was the procedure established by the Constituent Assembly, but further organized and improved.

The Consulate and the Empire.—The constitutional law of the Consulate and the Empire is to be found in a series of documents called later the *Constitutions de l'Empire*, the constitution promulgated during the Hundred Days being consequently given the name of *Acte additionnel aux Constitutions de l'Empire*. These documents consist of (1) the Constitution of the 22nd Frimaire of the year VIII., the work of Sieyès and Bonaparte,

the text on which the others were based; (2) the *senatus consulte* of the 16th Thermidor in the year X., establishing the consulate for life; and (3) the *senatus consulte* of the 28th Floréal in the year XII., which created the Empire. These constitutional acts, which were all, whether in their full text or in principle, submitted to the popular vote by means of a *plébiscite*, had all the same object: to assure absolute power to Napoleon, while preserving the forms and appearance of liberty. Popular suffrage was maintained, and even became universal; but, since the system was that of suffrage in many stages, which, moreover, varied very much, the citizens in effect merely nominated the candidates, and it was the Senate, playing the part of *grand électeur* which Sieyès had dreamed of as his own, which chose from among them the members of the various so-called elected bodies, even those of the political assemblies. According to the constitution of the year VIII., the first consul (to whom had been added two colleagues, the second and third consuls, who did not disappear until the Empire) possessed the executive power in the widest sense of the word, and he alone could initiate legislation. There were three representative assemblies in existence, elected as we have seen; but one of them, the Corps Législatif, passed laws without discussing them, and without the power of amending the suggestions of the government. The Tribunal, on the contrary, discussed them, but its vote was not necessary for the passing of the law. The Senate was the guardian and preserver of the constitution; in addition to its role of *grand électeur*, its chief function was to annul laws and acts submitted to it by the Tribunal as being unconstitutional. This original organization was naturally modified during the course of the Consulate and the Empire; not only did the emperor obtain the right of directly nominating senators, and the princes of the imperial family, and grant dignitaries of the Empire that of entering the Senate by right; but a whole body, the Tribunal, which was the only one which could preserve some independence, disappeared, without resort having been had to a plebiscite; it was modified and weakened by *senatus consulte* of the year X., and was suppressed in 1807 by a mere *senatus consulte*. The importance of another body, on the contrary, the *conseil d'état*, which had been formed on the improved type of the ancient *conseil du roi*, and consisted of members appointed by Napoleon and carefully chosen, continually increased. It was this body which really prepared and discussed the laws; and it was its members who advocated them before the Corps Législatif, to which the Tribunal also sent orators to speak on its behalf. The ministers, who had no relation with the legislative power, were merely the agents of the head of the state, freely chosen by himself. Napoleon, however, found these powers insufficient, and arrogated to himself others, a fact which the Senate did not forget when it proclaimed his downfall. Thus he frequently declared war upon his own authority, in spite of the provisions to the contrary made by the constitution of the year VIII.; and similarly, under the form of *décrets*, made what were really laws. They were afterwards called *décrets-lois*, and those that were not indissolubly associated with the political régime of the Empire, and survived it, were subsequently declared valid by the court of cassation, on the ground that they had not been submitted to the Senate as unconstitutional, as had been provided by the constitution of the year VIII.

This period saw the rise of a whole new series of great organic laws. For administrative organization, the most important was that of the 28th Pluviôse in the year VIII. It established as chief authority for each department a prefect, and side by side with him a *conseil général* for deliberative purposes; for each *arrondissement* (corresponding to the old *district*) a sub-prefect (*sous-préfet*) and a *conseil d'arrondissement*; and for each *commune*, a mayor and a municipal council. But all these officials, both the members of the councils and the individual agents, were appointed by the head of the state or by the prefect, so that centralization was restored more completely than ever. Together with the prefect there was also established a *conseil*

Administrative changes under Consulate and Empire.

de préfecture, having administrative functions, and generally acting as a court of the first instance in disputes and litigation arising out of the acts of the administration; for the Constituent Assembly had removed such cases from the jurisdiction of the civil tribunals, and referred them to the administrative bodies themselves. The final appeal in these disputes was to the *conseil d'état*, which was supreme judge in these matters. In 1807 was created another great administrative jurisdiction, the *cour des comptes*, after the pattern of that which had existed under the *ancien régime*.

Judicial organization had also been fundamentally altered. The system of election was preserved for a time in the case of the *juges de paix* and the members of the court of cassation, but finally disappeared there, even where it had already been no more than a form. The magistrates were in principle appointed for life, but under the Empire a device was found for evading the rule of irremovability. For the judgment of civil cases there was a court of first instance in every *arrondissement*, and above these a certain number of courts of appeal, each of which had within its province several departments. The separate criminal tribunals were abolished in 1809 by the *Code d'Instruction Criminelle*, and the magistrates forming the *cour d'assises*, which judged crimes with the aid of a jury, were drawn from the courts of appeal and from the civil tribunals. The *jury d'accusation* was also abolished by the *Code d'Instruction Criminelle*, and the right of pronouncing the indictment was transferred to a chamber of the court of appeal. The correctional tribunals were amalgamated with the civil tribunals of the first instance. The *tribunal de cassation*, which took under the Empire the name of *cour de cassation*, consisted of magistrates appointed for life, and still kept its powers. The *ministère public* (consisting of imperial *avocats* and *procureurs*) was restored in practically the same form as under the *ancien régime*.

The former system of taxation was preserved in principle, but with one considerable addition: Napoleon re-established indirect taxation on articles of consumption, which had been abolished by the Constituent Assembly; the chief of these were the duties on liquor (*droits réunis*, or excise) and the monopoly of tobacco.

The Concordat concluded by Napoleon with the papacy on the 26th Messidor of the year IX. re-established the Catholic religion in France as the form of worship recognized and endowed by the state. It was in principle drawn up on the lines of that of 1516, and assured to the head of the French state in his dealings with the papacy the same prerogatives as had formerly been enjoyed by the kings; the chief of these was that he appointed the bishops, who afterwards had to ask the pope for canonical institution. The territorial distribution of dioceses was preserved practically as it had been left by the civil constitution of the clergy. The state guaranteed the payment of salaries to bishops and curés; and the pope agreed to renounce all claims referring to the appropriation of the goods of the clergy made by the Constituent Assembly. Later on, a decree restored to the *fabriques* (vestries) such of their former possessions as had not been alienated, and the churches which had not been alienated were restored for the purposes of worship. The law of the 18th Germinal in the year X., ratifying the Concordat, reasserted, under the name of *articles organiques du culte catholique*, all the main principles contained in the old doctrine of the liberties of the Gallican Church. The Concordat did not include the restoration of the religious orders and congregations; Napoleon sanctioned by decrees only a few establishments of this kind.

One important creation of the Empire was the university. The *ancien régime* had had its universities for purposes of instruction and for the conferring of degrees; it had also, though without any definite organization, such secondary schools as the towns admitted within their walls, and the primary schools of the parishes. The Revolution suppressed the universities and the teaching congregations. The constitution of the year III. proclaimed the liberty of

instruction and commanded that public schools, both elementary and secondary, should be established. Under the Directory there was in each department an *école centrale*, in which all branches of human knowledge were taught. Napoleon, developing ideas which had been started in the second half of the 18th century, founded by laws and decrees of 1806, 1808 and 1811 the Université de France, which provided and organized higher, secondary and primary education; this was to be the monopoly of the state, carried on by its *facultés*, *lycées* and primary schools. No private educational establishment could be opened without the authorization of the state.

But chief among the documents dating from this period are the Codes, which still give laws to France. These are the Civil Code of 1804, the *Code de Procédure Civile* of 1806, the *Code de Commerce* of 1807, the *Code d'Instruction Criminelle* of 1809, and the *Code Pénal* of 1810. These monumental works, in the elaboration of which the *conseil d'état* took the chief part, contributed, to a greater or less extent, towards the fusion of the old law of France with the laws of the Revolution. It was in the case of the *Code Civil* that this task presented the greatest difficulty (see CODE NAPOLÉON). The *Code de Commerce* was scarcely more than a revised and emended edition of the *ordonnances* of 1673 and 1681; while the *Code de Procédure Civile* borrowed its chief elements from the *ordonnance* of 1667. In the case of the *Code d'Instruction Criminelle* a distinctly new departure was made; the procedure introduced by the Revolution into courts where judgment was given remained public and oral, with full liberty of defence; the preliminary procedure, however, before the examining court (*juge d'instruction* or *chambre des mises en accusation*) was borrowed from the *ordonnance* of 1670; it was the procedure of the old law, without its cruelty, but secret and written, and generally not in the presence of both parties. The *Code Pénal* maintained the principles of the Revolution, but increased the penalties. It substituted for the system of fixed penalties, in cases of temporary punishment, a maximum and a minimum, between the limits of which judges could assess the amount. Even in the case of misdemeanours, it admitted the system of extenuating circumstances, which allowed them still further to decrease and alter the penalty in so far as the offence was mitigated by such circumstances. (See further under NAPOLÉON I.)

The Restored Monarchy.—The Restoration and the Monarchy of July, though separated by a revolution, form one period in the history of French institutions, a period in which the same régime was continued and developed. This was the constitutional monarchy, with a parliamentary body consisting of two chambers, a system imitated from England. The same constitution was preserved under these two monarchies—the charter granted by Louis XVIII. in 1814. The revolution of 1830 took place in defence of the charter which Charles X. had violated by the *ordonnances* of July, so that this charter was naturally preserved under the "July Monarchy." It was merely revised by the Chamber of Deputies, which had been one of the movers of the revolution, and by what remained of the House of Peers. In order to give the constitution the appearance of originating in the will of the people, the preface, which made it appear to be a favour granted by the king, was destroyed. The two chambers acquired the initiative in legislation, which had not been recognized as theirs under the Restoration, but from this time on belonged to them equally with the king. The sittings of the House of Peers were henceforth held in public; but this chamber underwent another and more fundamental transformation. The peers were nominated by the king, with no limit of numbers, and according to the charter of 1814 their appointment could be either for life or hereditary; but, in execution of an ordinance of Louis XVIII., during the Restoration they were always appointed under the latter condition. Under the July Monarchy their tenure of office was for life, and the king had to choose them from among twenty-two classes of notables fixed by law. The franchise for the election of the Chamber of Deputies had been limited by a system of money qualifications; but while, under the

Judicial changes.

Taxation.

The Concordat.

The university.

The Codes.

Constitutional monarchy.

Restoration, it had been necessary, in order to be an elector, to pay three hundred francs in direct taxation, this sum was reduced in 1831 to two hundred francs, while in certain cases even a smaller amount sufficed. In order to be elected as a deputy it was necessary, according to the charter of 1814, to pay a thousand francs in direct taxation, and according to that of 1830 five hundred francs. From 1817 onwards there was direct suffrage, the electors directly electing the deputies. The idea of those who had framed the charter of 1814 had been to give the chief influence to the great landed proprietors, though the means adopted to this end were not adequate: in 1830 the chief aim had been to give a preponderating influence to the middle and lower middle classes, and this had met with greater success. The House of Peers, under the name of *cour des pairs*, had also the function of judging attempts and plots against the security of the state, and it had frequently to exercise this function both under the Restoration and the July Monarchy.

This was a period of parliamentary government; that is, of government by a cabinet, resting on the responsibility of the ministers to the Chamber of Deputies. The only interruption was that caused by the resistance of Charles X. at the end of his reign, which led to the revolution of July. Parliamentary government was practised regularly and in an enlightened spirit under the Restoration, although the Chamber had not then all the powers which it has since acquired. It is noteworthy that during this period the right of the House of Peers to force a ministry to resign by a hostile vote was not recognized. By the creation of a certain number of new peers, a *fournée de pairs*, as it was then called, the majority in this House could be changed when necessary. But the government of the Restoration had to deal with two extreme parties of a very opposite nature: the *Ultras*, who wished to restore as far as possible the *ancien régime*, to whom were due the acts of the *chambre introuvable* of 1816, and later the laws of the ministry of Villèle, especially the law of sacrilege and that voting compensation to the dispossessed nobles, known as the *milliard des émigrés*; and on the other hand the *Liberals*, including the Bonapartists and Republicans, who were attached to the principles of the Revolution. In order to prevent either of these parties from predominating in the chamber, the government made a free use of its power of dissolution. It further employed two means to check the progress of the Liberals; firstly, there were various alterations successively made in the electoral law, and the press laws, frequently restrictive in their effect, which introduced the censorship and a preliminary authorization in the case of periodical publications, and gave the correctional tribunals jurisdiction in cases of press offences. The best electoral law was that of 1817, and the best press laws were those of 1819; but these were not of long duration. Under the July Monarchy parliamentary government, although its machinery was further perfected, was not so brilliant. The majorities in the Chamber of Deputies were often uncertain, so much so, that more than once the right of dissolution was exercised in order to try by new elections to arrive at an undivided and certain majority. King Louis Philippe, though sober-minded, wished to exercise a personal influence on the policy of the cabinet, so that there were then two schools, represented respectively by Thiers and Guizot, one of which held the theory that "the king reigns but does not govern"; while the other maintained that he might exercise a personal influence, provided that he could rely on a ministry supported by a majority of the Chamber of Deputies. But the weak point in the July Monarchy was above all the question of the franchise. A powerful movement of opinion set in towards demanding an extension, some wishing for universal suffrage, but the majority proposing what was called the *adjonction des capacités*, that is to say, that to the number of qualified electors should be added those citizens who, by virtue of their professions, capacity or acquirements, were inscribed after them on the general list for juries. But the government obstinately refused all electoral reform, and held to the law of 1831. It also refused parliamentary reform, by which was meant a rule which would have made most public offices incompatible with the position of deputy, the Chamber of

Deputies being at that time full of officials. The press, thanks to the Charter, was perfectly free, without either censorship or preliminary authorization, and press offences were judged by a jury.

In another respect also the Restoration and the July Monarchy were at one, the second continuing the spirit of the first, viz. in maintaining in principle the civil, legal and administrative institutions of the Empire. The preface to the charter of 1814 sanctioned and guaranteed most of the legal rights won by the Revolution; even the alienation of national property was confirmed. It was said, it is true, that the old nobility regained their titles, and that the nobility of the Empire kept those which Napoleon had given them; but these were merely titles and nothing more; there was no privileged nobility, and the equality of citizens before the law was maintained. Judicial and administrative organization, the system of taxation, military organization, the relations of church and state, remained the same, and the university also continued to exist. The government did, it is true, negotiate a new Concordat with the papacy in 1817, but did not dare even to submit it to the chambers. The most important reform was that of the law concerning recruiting for the army. The charter of 1814 had promised the abolition of conscription, in the form in which it had been created by the law of the year VI. The law of the 10th of March 1818 actually established a new system. The contingent voted by the chambers for annual incorporation into the standing army was divided up among all the cantons; and, in order to furnish it, lots were drawn among all the men of a certain class, that is to say, among the young Frenchmen who arrived at their majority that year. Those who were not chosen by lot were definitely set free from military service. The sending of substitutes, a custom which had been permitted by Napoleon, was recognized. This was the type of all the laws on recruiting in France, of which there were a good number in succession up to 1867. On other points they vary, in particular as to the duration of service, which was six years, and later eight years, under the Restoration; but the system remained the same.

The Restoration produced a code, the *Code forestier* of 1827, for the regulation of forests (*eaux et forêts*). In 1816 a law had abolished divorce, making marriage indissoluble, as it had been in the old law. But the best laws of this period were those on finance. Now, for the first time, was introduced the practice of drawing up regular budgets, voted before the year to which they applied, and divided since 1819 into the budget of expenditure and budget of receipts.

Together with other institutions of the Empire, the Restoration had preserved the exaggerated system of administrative centralization established in the year VIII.; and proposals for its relaxation submitted to the chambers had come to nothing. It was only under the July Monarchy that it was relaxed. The municipal law of the 21st of March 1831 made the municipal councils elective, and extended widely the right of voting in the elections for them; the *maires* and their assistants continued to be appointed by the government, but had to be chosen from among the members of the municipal councils. The law of the 22nd of June 1833 made the general councils of the departments also elective, and brought the *adjonction des capacités* into effect for their election. The powers of these bodies were enlarged in 1838, and they gained the right of electing their president. In 1833 was granted another liberty, that of primary education; but in spite of violent protestations, coming especially from the Catholics, secondary and higher education continued to be a monopoly of the state. Many organic laws were promulgated, one concerning the National Guard, which was reorganized in order to adapt it to the system of citizen qualifications; one in 1832 on the recruiting of the army, fixing the period of service at seven years; and another in 1834 securing the status of officers. A law of the 11th of June 1842 established the great railway lines. In 1832 the *Code Pénal* and *Code d'Instruction Criminelle* were revised, with the object of lightening penalties; the system of extenuating circumstances, as recognized by a jury, was

The system of the Empire retained.

extended to the judgment of all crimes. There was also a revision of Book III. of the *Code de Commerce*, treating of bankruptcy. Finally, from this period date the laws of the 3rd of May 1841, on expropriation for purposes of public utility, and of the 30th of June 1838, on the treatment of the insane, which is still in force. Judicial organization remained as it was, but the amount of the sum up to which civil tribunals of the first instance could judge without appeal was raised from 1000 francs to 1500, and the competency of the *juges de paix* was widened.

The Second Republic and the Second Empire.—From the point of view of constitutional law, the Second Republic and the Second Empire were each in a certain sense a return to the past. The former revived the tradition of the Assemblies of the Revolution; the latter was obviously and avowedly an imitation of the Consulate and the First Empire.

The provisional government set up by the revolution of the 24th of February 1848 proclaimed universal suffrage, and by this means was elected a Constituent Assembly, which sat till May 1849, and, after first organizing various forms of another provisional government, passed the Republican constitution of the 4th of November 1848.

This constitution, which was preceded by a preface recalling the Declarations of Rights of the Revolution, gave the legislative power to a single permanent assembly, elected by direct universal suffrage, and entirely renewed every three years. The executive authority, with very extensive powers, was given to a president of the Republic, also elected by the universal and direct suffrage of the French citizens. The constitution was not very clear upon the point of whether it adopted parliamentary government in the strict sense, or whether the president, who was declared responsible, was free to choose his ministers and to retain or dismiss them at his own pleasure. This gave rise to an almost permanent dispute between the president, who claimed to have his own political opinions and to direct the government, and the Assembly, which wished to carry on the traditions of cabinet government and to make the ministers fully responsible to itself. Consequently, in January 1851, a solemn debate was held, which ended in the affirmation of the responsibility of ministers to the Assembly. On the other hand, the president, though very properly given great power by the constitution, was not immediately eligible for re-election on giving up his office. Now Louis Napoleon, who was elected president on the 10th of December 1848 by a huge majority, wished to be re-elected. Various propositions were submitted to the Assembly in July 1851 with a view to modifying the constitution; but they could not succeed, as the number of votes demanded by the constitution for the convocation of a Constituent Assembly was not reached. Moreover, the Legislative Assembly elected in May 1849 was very different from the Constituent Assembly of 1848. The latter was animated by that spirit of harmony and, in the main, of adhesion to the Republic which had followed on the February Revolution. The new assembly, on the contrary, was composed for the most part of representatives of the old parties, and had monarchist aspirations. By the unfortunate law of the 31st of May 1850 it even tried by a subterfuge to restrict the universal suffrage guaranteed by the constitution. It suspended the right of holding meetings, but, on the whole, respected the liberty of the press. It was especially impelled to these measures by the growing fear of socialism. The result was the *coup d'état* of the 2nd of December 1851. A detail of some constitutional importance is to be noticed in this period. The *conseil d'état*, which had remained under the Restoration and the July Monarchy an administrative council and the supreme arbiter in administrative trials, acquired new importance under the Second Republic. The ordinary *conseillers d'état (en service ordinaire)* were elected by the Legislative Assembly, and consultation with the *conseil d'état* was often insisted on by the constitution or by law. This was the means of obtaining a certain modifying power as a substitute for the second chamber, which had not met with popular approval. During its short existence the Second Republic produced many important laws. It abolished the penalty of death for political crimes, and suppressed negro slavery in the

colonies. The election of *conseillers généraux* was thrown open to universal suffrage, and the municipal councils were allowed to elect the *maires* and their colleagues. The law of the 15th of March 1850 established the liberty of secondary education, but it conferred certain privileges on the Catholic clergy, a clear sign of the spirit of social conservatism which was the leading motive for its enactment. Certain humanitarian laws were passed, applying to the working classes.

With the *coup d'état* of the 2nd of December 1851 began a new era of constitutional plebiscites and disguised absolutism. The proclamations of Napoleon on the 2nd of December contained a criticism of parliamentary government, and formulated the wish to restore to France the constitutional institutions of the Consulate and the Empire, just as she had preserved their civil, administrative and military institutions. Napoleon asked the people for the powers necessary to draw up a constitution on these principles; the plebiscite issued in a vast majority of votes in his favour, and the constitution of the 14th of January 1852 was the result. It bore a strong resemblance to the constitution of the First Empire after 1807. The executive power was conferred on Louis Napoleon for ten years, with the title of president of the Republic and very extended powers. Two assemblies were created. The conservative Senate, composed of *ex officio* members (cardinals, marshals of France and admirals) and life members appointed by the head of the state, was charged with the task of seeing that the laws were constitutional, of opposing the promulgation of unconstitutional laws, and of receiving the petitions of citizens; it had also the duty of providing everything not already provided but necessary for the proper working of the constitution. The second assembly was the *Corps Législatif*, elected by direct universal suffrage for six years, which passed the laws, the government having the initiative in legislation. This body was not altogether a *corps des muets*, as in the year VIII., but its powers were very limited; thus the general session assured to it by the constitution was only for three months, and it could only discuss and put to the vote amendments approved by the *conseil d'état*; the ministers did not in any way come into contact with it and could not be members of it, being responsible only to the head of the state, and only the Senate having the right of accusing them before a high court of justice. The *conseil d'état* was composed in the same way and had the same authority as it had possessed from the year VIII. to 1814; and it was the members of it who supported projected laws before the *Corps Législatif*. To this was added a Draconian press legislation; not only were press offences, many of which were mere expressions of opinion, judged not by a jury but by the correctional tribunals; but further, political papers could not be founded without an authorization, and were subject to a regular administrative discipline; they could be warned, suspended or suppressed without a trial, by a simple act of the administration. The constitution of January 1852 was still Republican in name, though less so than that of the year VIII. The period corresponding with the Consulate was also shorter in the case of Louis Napoleon. The year 1852 had not come to an end before a *senatus consulte*, that of the 10th of November, ratified by a plebiscite, re-established the imperial rank in favour of Napoleon III.; it also conferred on him certain new powers, especially with reference to the budget and foreign treaties; thus various cracks, which experience had revealed in the original structure of the Empire, were filled up. This period was called that of the *empire autoritaire*. Further features of it were the free appointment of the *maires* by the emperor, the oath of fidelity to him imposed on all officials, and the legal organization of official candidatures for the elections. Two measures marked the highest point reached by this system: the *loi de sûreté générale* of the 27th of February 1858, which allowed the government to intern in France or Algeria, or to exile certain French citizens, without a trial. The other was the *senatus consulte* of the 17th of February 1858, which made the validity of candidatures for the *Corps Législatif* subject

Constitution of Jan. 14, 1852.

Restoration of the Empire.

to a preliminary oath of fidelity on the part of the candidate. But for various causes, which cannot be examined here, a series of measures was soon to be initiated which were gradually to lead back again to political liberty, and definitively to found what has been called the *empire libéral*. One by one the different rules and proceedings of parliamentary government as it had existed in France regained their force. The first step was the decree of the 24th of November 1860, which re-established for each ordinary session the address voted by the chambers in response to the speech from the throne. In 1867 this movement took a more decisive form. It led to a new constitution, that of the 21st of May 1870, which was again ratified by popular suffrage. While maintaining the Empire and the imperial dynasty, it organized parliamentary government practically in the form in which it had operated under the July Monarchy, with two legislative chambers, the Senate and the Corps Législatif, the consent of both of which was necessary for legislation, and which, together with the emperor, had the initiative in this matter. The laws of the 11th of May 1868 and the 6th of June 1868 restored to a certain extent the liberty of the press and of holding meetings, though without abolishing offences of opinion, or again bringing press offences under the jurisdiction of a jury. Laws of the 22nd and 23rd of July 1870 gave the *conseils généraux*, whose powers had been somewhat widened, the right of electing their presidents, and provided that the *maires* and their colleagues should be chosen from among the members of the municipal councils.

The legislation of the Second Empire led to a considerable number of reforms. Its chief aim was the development of commerce, industry and agriculture, and generally the material prosperity of the country. The Empire, though restricting liberty in political matters, increased it in economic matters. Such were the decrees and laws of 1852 and 1853 relating to land-banks (*établissements de crédit foncier*) and that of 1857 on trade-marks,

those of 1863 and 1867 on commercial companies, that of 1858 on general stores (*magasins généraux*) and warrants, that of 1856 on drainage, that of 1865 on the *associations syndicales de propriétaires*, that of 1866 on the mercantile marine. The law of the 14th of June 1865 introduced into France the institution, borrowed from England, of cheques. But of still greater importance for economic development than all these laws were the treaties concluded by the emperor with foreign powers, in order to introduce, as far as possible, free exchange of commodities; the chief of these, which was the model of all the others, was that concluded with Great Britain on the 23rd of January 1860. Moreover, the law of the 25th of May 1864 admitted for the first time the right of strikes and lock-outs among workmen or employers, annulling articles 414 and following of the *Code Pénal*, which had so far made them a penal offence, even when not accompanied by fraudulent practices, threats or violence, tending to hinder the liberty of labour. The superannuation fund (*caisse des retraites pour la vieillesse*), supported by voluntary payments from those participating in it, which had been created by the law of the 18th of June 1850, was reorganized and perfected, and a law of the 11th of July 1868 established, with the guarantee of the state, two funds for voluntary insurance, one in case of death, the other against accidents occurring in industrial or agricultural employment. A decree of 1863 established in principle the freedom of bakeries, and another in 1864 that of theatrical management.

Criminal law was the subject of important legislation. Two codes were promulgated on special points, the codes of military justice for the land forces (1857) and for the naval forces (1858). But the common law was also largely remodelled. A law of the 10th of June 1858, it is true, created certain new crimes, with a view to protecting the members of the imperial family, and that of the 17th of July 1856 increased the powers and independence of the *juges d'instruction*; but, on the other hand, useful improvements were introduced by laws of 1856 and 1865, and notably with regard to precautionary detention and provisional release with or

without bail. A law of the 20th of May 1863 organized a simple and rapid procedure, copied from that followed in England before the police courts, for summary jurisdiction. A law of 1868 permitted the revision of criminal trials after the death of the condemned person. But the most far-reaching reforms took place in 1854, namely, the abolition of the total loss of civil rights which formerly accompanied condemnation to imprisonment for life, and the law of the 30th of May on penal servitude (*travaux forcés*) which substituted transportation to the colonies for the system of continental convict prisons. Finally, in 1863, there was a revision of the *Code Pénal*, which, in the process of lightening penalties, made a certain number of crimes into misdemeanours, and in consequence transferred the judgment of them from the assize courts to the correctional tribunals. In civil legislation may be noted the law of the 23rd of March 1855 on hypothecs (see CODE NAPOLÉON); that of the 22nd of July 1857, which abolished seizure of the person (*contrainte par corps*) for civil and commercial debts; and finally, the law of the 14th of July 1866, on literary copyright. The system of taxation was hardly modified at all, except for the establishment of a tax on the income arising from investments (shares and bonds of companies) in 1857, and the tax on carriages (1862). On the 1st of February 1868 was promulgated an important military law, which, however, passed the Corps Législatif with some difficulty. It asserted the principle of universal compulsory military service, at least, in time of war. It preserved, however, the system of drawing lots to determine the annual contingent to be incorporated into the standing army; the term of service was fixed at five years, and it was still permissible to send a substitute. But able-bodied men who were not included in the annual contingent formed a reserve force called the *garde nationale mobile*, each department organizing its own section. These *gardes mobiles*, though they were not effectively organized or exercised under the Empire, took part in the war of 1870-71.

The Third Republic.—The Third Republic had at first a provisional government, unanimously acclaimed by the people of Paris. It was accepted by France, exercised full powers, and sustained by no means ingloriously a desperate struggle against the enemy; a certain number of its *décrets-lois* are still in force. After the capitulation of Paris, a National Assembly was elected to treat with Germany. It was elected in accordance with the electoral law of 1849, which had been revived with a few modifications, and it met at Bordeaux to the number of 753 members on the 13th of February 1871. It was a sovereign assembly, since France had no longer a constitution, and for this very reason it claimed from the outset constituent powers; the Republican party at the time, however, contested this claim, the majority in the assembly being frankly monarchist, though divided as to the choice of a monarch. But for some time the National Assembly either could not or would not exercise this power, and up to 1875 affairs remained in a provisional state, legalized and regulated this time by the Assembly. This was an application, though unconscious, of a form of government which M. Grévy had proposed to the Constituent Assembly in 1848. There was a single assembly, with one man elected by it as head of the executive power (the first to be elected was M. Thiers, who received the title of president of the Republic in August 1871), who was responsible to the Assembly and governed with the help of ministers chosen by himself, who were also responsible to it. Thiers fell on the 24th of May 1873. His place was taken by Marshal MacMahon, on whom the Assembly later conferred, in November 1873, the position of president of the Republic for seven years, when the refusal of the comte de Chambord to accept the tricolour in place of the white flag of the Bourbons had made any attempt to restore the monarchy impossible. Henceforth the definitive adoption of the Republican form of government became inevitable, and the opinion of the country began to turn in this direction, as was shown by the elections of deputies which took place to fill up the gaps occurring in the Assembly. The Assembly, however, shrank from the inevitable

*The
empire
libéral.*

*Civil
legislation.*

*Taxation
and
army.*

*Economic
and social
reforms
under the
Second
Empire.*

*Com-
mercial
treaties.*

*Reforms
in the
criminal
law.*

solution, and when a discussion was begun in January 1875 on the projected constitutional laws prepared by the *commission des trente*, the only proposals made by the latter were for a more complete organization of the powers of one man, Marshal MacMahon. But on the 30th of January 1875 was adopted, by 353 votes to 352, an amendment by M. Wallon which provided for the election of an indefinite succession of presidents of the Republic; this amounted to a definitive recognition of the Republic. In this connexion it has often been said that the Republic was established by a majority of one. This is not an accurate statement, for it was only the case on the first reading of the law; the majority on the second and third readings increased until it became considerable. There was a strong movement in the direction of a reconciliation between the parties; and there had been a *rapprochement* between the Republicans and the Right Centre. At the end of February were passed and promulgated two constitutional laws, that of the 25th of February 1875, on the organization of the public powers, and that of the 24th of February 1875, on the organization of the senate. In the middle of the year they were supplemented by a third, that of the 16th of July 1875, on the relations between the public powers.

Thus was built up the actual constitution of France. It differs fundamentally, both in form and contents, from previous constitutions. As to its form, instead of a single methodical text divided into an uninterrupted series of articles, it consisted of three distinct laws. As to matter, it is obviously a work of an essentially practical nature, the result of compromise and reciprocal concessions. It does not lay down any theoretical principles, and its provisions, which were arrived at with difficulty, confine themselves strictly to what is necessary to ensure the proper operation of the governmental machinery. The result is a compromise between Republican principles and the rules of constitutional and parliamentary monarchy. On this account it has been accused, though unjustly, of being too monarchical. Its duration, by far the longest of any French constitution since 1791, is a sign of its value and vitality. It is in fact a product of history, and not of imagination. Its composition is as follows. The legislative power was given to two elective chambers, having equal powers, the vote of both of which is necessary for legislation, and both having the right of initiating and amending laws. The constitution assures them an ordinary session of five months, which opens by right on the second Tuesday in January. One house, the Chamber of Deputies, is elected by direct universal suffrage and is entirely renewed every four years; the other, the Senate, consists of 300 members, divided by the law of the 27th of February 1875 into two categories; 75 of the senators were elected for life and irremovable, and the first of them were elected by the National Assembly, but afterwards it was the Senate itself which held elections to fill up vacancies. The 225 remaining senators were elected by the departments and by certain colonies, among which they were apportioned in proportion to the population; they are elected for nine years, a third of the house being renewed every three years. The electoral college in each department which nominated them included the deputies, the members of the general council of the department and of the councils of the *arrondissements*, and one delegate elected by each municipal council, whatever the importance of the commune. This was practically a system of election in two and, partly, three degrees, but with this distinguishing feature, that the electors of the second degree had not been chosen purely with a view to this election, but chiefly for the exercise of other functions. The most important elements in this electoral college were the delegates from the municipal councils, and by giving one delegate to each, to Paris just as to the smallest commune in France, the National Assembly intended to counterbalance the power of numbers, which governed the elections for the Chamber of Deputies, and, at the same time, to give a preponderance to the country districts. The 75 irremovable senators were another precaution against the danger from violent waves of public opinion. The executive power was entrusted to a president,

elected for seven years (as Marshal MacMahon had been in 1873), by the Chamber and the Senate, combined into a single body under the name of National Assembly. He is always eligible for re-election, and is irresponsible except in case of high treason. His powers are of the widest, including the initiative in legislation jointly with the two chambers, the appointment to all civil and military offices, the disposition, and, if he wish it, the leadership of the armed forces, the right of pardon, the right of negotiating treaties with foreign powers, and, in principle, of ratifying them on his own authority, the consent of the two chambers being required only in certain cases defined by the constitution. The nomination of *conseillers d'état* for ordinary service, whom the National Assembly had made elective, as in 1848, and elected itself, was restored to the president of the Republic, together with the right of dismissing them. But these powers he can only exercise through the medium of a ministry, politically and jointly responsible to the chambers, and forming a council, over which the president usually presides.

The French Republic is essentially a parliamentary republic. The right of dissolving the Chamber of Deputies before the expiration of its term of office belongs to the president, but in order to do so he must have, besides a ministry which will take the responsibility for it, the preliminary sanction of the Senate. The Senate is at the same time a high court of justice, which can judge the president of the Republic and ministers accused of crimes committed by them in the exercise of their functions; in these two cases the prosecution is instituted by the Chamber of Deputies. The Senate can also be called upon to judge any person accused of an attempt upon the safety of the state, who is then seized by a decree of the president of the Republic, drawn up in the council of ministers. Possible revision of the constitution is provided for very simply: it has to be proposed as a law, and for its acceptance a resolution passed by each chamber separately, by an absolute majority, is necessary. The revision is then carried out by the Senate and the Chamber of Deputies to form a National Assembly. There have been two revisions since 1875. The first time, in 1879, it was simply a question of transferring the seat of the government and of the chambers back to Paris from Versailles, where it had been fixed by one of the constitutional laws. The second time, in 1884, more fundamental modifications were required. The most important point was to change the composition and election of the Senate. With a view to this, the new constitutional law of the 14th of August 1884 abolished the constitutional character of a certain number of articles of the law of the 24th of February 1875, thus making it possible to modify them by an ordinary law. This took place in the same year; the 75 senators for life were suppressed for the future by a process of extinction, and their seats divided among the most populous departments. Further, in the electoral college which elects the senators, there was allotted to the municipal councils a number of delegates proportionate to the number of members of the councils, which depends on the importance of the commune. The law of the 14th of August 1884 also modified the constitution in another important respect. The law of the 25th of February 1875 had admitted the possibility not only of a partial, but even of a total revision, which could affect and even change the form of the state. The law of the 14th of August 1884, however, declared that no proposition for a revision could be accepted which aimed at changing the republican form of government. The composition of the Chamber of Deputies was not fixed by the constitution, and consequently admitted more easily of variation. Since 1871 the mode of election has oscillated between the *scrutin de liste* for the departments and the *scrutin uninominal* for the *arrondissements*. The organic law of the 30th of November 1875 had established the latter system; in 1885 the *scrutin de liste* was established by law, but in 1889 the *scrutin d'arrondissement* was restored; and in this same year, on account of the ambitions of General Boulanger and the suggestion which was made for a sort of plebiscite in his favour, was passed the law on plural candidatures, which forbids anyone to become a candidate for the Chamber of Deputies in more than one district at a time.

The system established by the constitution of 1875 has worked excellently in some of its departments; for instance, the mode of electing the president of the Republic. Between 1875 and 1906 there were seven elections, sometimes under tragic or very difficult conditions; the election has always taken place without delay or obstruction, and the choice has been of the best. The high court of justice, which has twice been called into requisition, in 1889 and in 1899-1900, has acted as an efficient check, in spite of the difficulties confronting such a tribunal when feeling runs high. Parliamentary government in the form set up by the constitution, besides the criticism to which this system is open in all countries where it is established, even in England, met with special difficulties in France. In the first place, the useful but rather secondary rôle assigned to the president of the Republic has by no means satisfied all those who have occupied this high office. Two presidents have resigned on the ground that their powers were insufficient. Another, even after re-election, had to withdraw in face of the opposition of the two chambers, being no longer able to obtain a parliamentary ministry. It is difficult, however, to accept the theory of an eminent American political writer, Mr John W. Burgess,¹ that in order to attain to a position of stable equilibrium, the French Republic ought to adopt the presidential system of the United States. In France this sharp division between the two powers has never been observed except in those periods when the representative assemblies were powerless, under the First and Second Empires. It is true that the apparent multiplicity of parties and their lack of discipline, together with the French procedure of *interpellations* and the orders of the day by which they are concluded, make the formation of homogeneous and lasting cabinets difficult; but since the end of the 19th century there has been great progress in this respect. Another difficulty arose in 1896. The Senate, appealing to the letter of the constitution and relying on its elective character, claimed the right of forcing a ministry to resign by its vote, in the same way as the Chamber of Deputies. The Senate was victorious in the struggle, and forced the ministry presided over by M. Léon Bourgeois to resign; but the precedent is not decisive, for in order to gain its ends the Senate had recourse to the means of refusing to sanction the taxes, declining to consider the proposals for the supplies necessary for the Madagascar expedition so long as the ministry which it was attacking was in existence. The weakest point in the French parliamentary organism is perhaps the right of dissolution. It is difficult of application, for the reason that the president must obtain the preliminary consent of the Senate before exercising it; moreover, this valuable right has been discredited by its abuse by Marshal MacMahon in the campaign of the 16th of May 1877, on which occasion he exercised his right of dissolution against a chamber, the moderate but decidedly republican majority in which was re-elected by the country.

The legislative reforms carried out under the Third Republic are very numerous. As to public law, it is only possible to mention here those of a really organic character, chief among which are those which safeguard and regulate the exercise of the liberties of the individual. The law of the 30th of June 1881, modified in 1901, established the right of holding meetings. Public meetings, whether for ordinary or electoral purposes, may be held without preliminary authorization; the law of 1881 prescribed a declaration made by a certain number of citizens enjoying full civil and political rights, which is now remitted. The only really restrictive provision is that which does not allow them to be held in the public highway, but only in an enclosed space. But this is made necessary by the customs of France. The law of the 21st of July 1881 on the press is one of the most liberal in the world. By it all offences committed by any kind of publication are submitted to a jury; the punishment for the mere expression of obnoxious opinions is abolished, the only punishment being for slander, libel, defamation, inciting to crime, and in certain

cases the publication of false news. The law of the 1st of July 1901 established in France the right of forming associations. It recognizes the legality of all associations strictly so called, the objects of which are not contrary to law or to public order or morality. On condition of a simple declaration to the administrative authority, it grants them a civil status in a wide sense of the term. Religious congregations, on the contrary, which are not authorized by a law, are forbidden by this law. This was not a new principle, but the traditional rule in France both before and after the Revolution, except that under certain governments authorization by decree had sufficed. As a matter of fact the unauthorized congregations had been tolerated for a long time, although on various occasions, and especially in 1881, their partial dissolution had been proclaimed by decrees. The law of 1901 dissolved them all, and made it an offence to belong to such a congregation. The members of unauthorized congregations, and later, in 1904, even those of the authorized congregations, were disqualified from teaching in any kind of establishment. The liberty of primary education was confirmed and reorganized by the law of the 30th of October 1886, which simply deprived the clergy of the privileges granted them by the law of 1850, though the latter remains in force with regard to the liberty of secondary education. A law passed by the National Assembly (July 12, 1875) established the liberty of higher education. It even went beyond this, for it granted to students in private *facultés* who aspired to state degrees the right of being examined before a board composed partly of private and partly of state professors. The law of the 18th of March 1880 abolished this privilege. Another law, that of the 22nd of March 1882, made primary education obligatory, though allowing parents to send their children either to private schools or to those of the state; the law of the 16th of June 1881 established secular (*laïque*) education in the case of the latter. The Third Republic also organized secondary education for girls in lycées or special colleges (*collèges de fille*). Finally, a law of the 19th of July 1896 dealing with higher education and the faculties of the state reorganized the universities, which form distinct bodies, enjoying a fairly wide autonomy. A law of the 19th of December 1905, abrogating that of the 18th Germinal in the year X., which had sanctioned the Concordat, proclaimed the separation of the church from the state. It is based on the principle of the secular state (*état laïque*) which recognizes no form of religion, though respecting the right of every citizen to worship according to his beliefs, and it aimed at organizing associations of citizens, the object of which was to collect the funds and acquire the property necessary for the maintenance of worship, under the form of *associations culturelles*, differing in certain respects from the associations sanctioned by the law of the 1st of July 1901, but having a wider scope. It also handed over to these regularly formed associations the property of the ecclesiastical establishments formerly in existence, while taking precautions to ensure their proper application, and allowed the associations the free use of the churches and places of worship belonging to the state, the departments or the communes. If no *association culturelle* was founded in a parish, the property of the former *fabrique* should devolve to the commune. But this law was condemned by the papacy, as contrary to the church hierarchy; and almost nowhere were *associations culturelles* formed, except by Protestants and Jews, who complied with the law. After many incidents, but no church having been closed, a new law of the 2nd of January 1907 was enacted. It permits the public exercise of any cult, by means of ordinary associations regulated by the law of the 1st of July 1901, and even of public meetings summoned by individuals. Failing all associations, either *culturelles* or others, churches, with their ornaments and furniture, are left to the disposition of the faithful and ministers, for the purpose of exercising the cult; and, on certain conditions, the long use of them can be granted as a free gift to ministers of the cult.

Among the organic laws concerning administrative affairs there are two of primary importance; that of the 10th of

¹ *Political Science and Comparative Constitutional Law* (Boston, 1896).

August 1871, on the *conseils généraux*, considerably increased the powers and independence of these elective bodies, which have become important deliberative assemblies, their sessions being held in public. The law of 1871 created a new administrative organ for the departments, the *commission départementale*, elected by the council-general of the department from among its own members and associated with the administration of the prefect. The other law is the municipal law of the 5th of April 1884, which effected a widespread decentralization; the *maires* and their *adjoints* are elected by the municipal council.

The war of 1870-71 necessarily led to a modification of the military organization. The law of the 25th of July 1872 established the principle of compulsory service for all, first in the standing army, the period of service in which was fixed at five years, then in the reserve, and finally in the territorial army. But the application of this principle was by no means absolute, only holding good in time of war. Each annual class was divided into two parts, by means of drawing lots, and in time of peace one of these parts had only a year of service with the active army. The previous exemptions, based either on the position of supporter of the family (as in the case of the son of a widow or aged father, &c.) or on equivalent services rendered to the state (as in the case of young ecclesiastics or members of the teaching profession), were preserved, but only held good for service in the active army in times of peace. Finally, the system of conditional engagement for a year allowed young men, for the purposes of study or apprenticeship to their profession, only to serve a year with the active army in time of peace. By this means it was sought to combine the advantages of an army of veterans with those of a numerous and truly national army. But the conditional volunteering (*volontariat conditionnel*) for a year was open to too great a number of people, and so brought the system into discredit. As those who profited by it had to be clothed and maintained at their own expense, and the sum which they had to furnish for this purpose was generally fixed at 1500 francs, it came to be considered the privilege of those who could pay this sum. A new law of the 15th of July 1889 lessened the difference between the two terms which it attempted to reconcile. It reduced the term of service in the active army to three years, and the exemptions, which were still preserved, merely reduced the period to a year in times of peace. The same reduction was also granted to those who were really pursuing important scientific, technical or professional studies; the system was so strict on this point that the number of those who profited by those exemptions did not amount to 2000 in a year. This was a compromise between two opposing principles; the democratic principle of equality, being the stronger, was bound to triumph. The law of the 21st of March 1905 reduced the term of service in the active army to two years, but made it equal for all, admitting of no exemption, but only certain facilities as to the age at which it had to be accomplished.

In 1883 the judicial *personnel* was reorganized and reduced in number. With the exception of a few modifications the main lines of judicial organization remained the same. In 1879 the conseil d'état was also reorganized. The whole fabric of administrative jurisdiction was carefully organized, and almost entirely separated from the active administration.

The system of taxation has remained essentially unaltered; we may notice, however, the laws of 1897, 1898 and 1900, which abolished or lessened the duties on so called *hygienic* drinks (wine, beer, cider), and the financial law of 1901, which rearranged and increased the transfer fees, and established a system of progressive taxation in the case of succession dues.

The labour laws, which generally partook of the nature both of public and of private law, are a sign of our times. Under the Third Republic they have been numerous, the most notable being: the law of the 21st of March 1884 on professional syndicates, which introduced the liberty of association in matters of this kind before it became part of the common law (see TRADE UNIONS);

the law of the 9th of April 1898 on the liability for accidents incurred during work, and those which have completed it; that of the 22nd of December 1892 on conciliation and arbitration in the case of collective disputes between employers and workmen; that of the 29th of June 1893 on the hygiene and safeguarding of workers in industrial establishments, and the laws which regulate the work of children and women in factories; finally, that of the 15th of July 1893 on free medical attendance (see LABOUR LEGISLATION).

As to criminal law, there have been more than fifty enactments, mostly involving important modifications, due to more scientific ideas of punishment, so that we may say that it has been almost entirely recast since the establishment of the Third Republic. The separate system applied in cases of preventive detention and imprisonment for short periods; liberation before the expiry of the term of sentence, subject to the condition that no fresh offence shall be committed within a given time; transportation to the colonies of habitual offenders; the remission of the penalty in the case of first offenders, and the lapsing of the penalty when a certain time has gone by without a fresh condemnation; greater facilities for the rehabilitation of condemned persons, which now became simply a matter for the courts, and occurred as a matter of course at the end of a certain time; such were the chief results of this legislation. Finally, the law of the 8th of December 1897 completely altered the form of the preliminary examination before the *juge d'instruction*, which had been the weakest point in the French criminal procedure, though it was still held in private; the new law made this examination really a hearing of both sides, and made the appearance of counsel for the defence practically compulsory.

As to private law, both civil and commercial, we could enumerate between 1871 and 1906 more than a hundred laws which have modified it, sometimes profoundly, and have for the most part done very useful work without attracting much attention. They are generally examined and drawn up by commissions of competent men, and pass both chambers almost without discussion. There have, however, been a few which aroused public interest and even deep feeling. Firstly, there was the law of the 27th of July 1884, and those which completed it; this law re-established divorce, which had been abolished since 1816, but only permitted it for certain definite causes determined by law. On the other hand, the law of the 6th of February 1893 increased the liberty and independence of a woman who was simply judicially separated, in order to encourage separation, as opposed to divorce, when the conditions allowed it. The law of the 25th of March 1896 on the succession of illegitimate children, who were recognized by the parents, treated them not in the same way as legitimate children, but gave them the title of heirs in the succession of their father and mother, together with much greater rights than they had possessed under the *Code Civil*. The law of the 24th of July 1899, on the protection of children who are ill-treated or morally neglected, also modified some of the provisions of the law as applied to the family, with a view to greater justice and humanity. Finally, on the occasion of the centenary of the *Code Civil* (see CODE NAPOLÉON), a commission, composed of members of the chambers, magistrates, professors of law, lawyers, political writers, and even novelists and dramatic authors, was given the task of revising the whole structure of the code.

See generally Adhémair Esmein, *Cours élémentaire d'histoire du droit français* (6th ed., 1906); J. Brissand, *Cours d'histoire générale du droit français public et privé* (1904); Ernest Glasson, *Histoire du droit et des institutions en France* (1887-1904); Paul Viollet, *Histoire des institutions politiques et administratives de la France* (3rd ed., 1903); Fustel de Coulanges, *Histoire des institutions politiques de l'ancienne France*; Jacques Flach, *Les Origines de l'ancienne France* (1875-1889); Achille Luchaire, *Histoire des institutions monarchiques de la France sous les premiers Capétiens* (2nd ed., 1900); Hippolyte Taine, *Les Origines de la France contemporaine* (1878-1894); Adhémair Esmein, *Éléments de droit constitutionnel français et comparé* (4th ed., 1906); Léon Duguit et Henry Monnier, *Les Constitutions et les principales lois politiques de la France depuis 1789* (1898). (J. P. E.)

FRANCESCHI, JEAN BAPTISTE, BARON (1766–1813), French general, was born at Bastia on the 5th of December 1766 and entered the French service in 1793. He took part in the operations in Corsica in the following year, and received a wound at the siege of San Fiorenzo. After this he left the island and was appointed a field officer in the French Army of Italy, with which he served from 1795 to 1799. He served as a general officer in the campaign of Marengo, in the Naples campaign of 1805–1806, and in the Peninsular War from 1807 to 1809. He was created a baron by Napoleon. He commanded a Neapolitan brigade in the Russian War of 1812, and after the retreat from Moscow took refuge, with the remnant of his command, in Danzig, where in the course of the siege of 1813 he died on the 19th of March.

Two other generals of brigade in Napoleon's wars bore the name of Franceschi, and the three have often been mistaken for each other. The first was born at Lyons, **JEAN BAPTISTE MARIE FRANCESCHI-DELONNE** (1767–1810), who served throughout the Revolutionary campaign on the Rhine, took part in the campaign of Zürich in 1799, and distinguished himself very greatly by his escape from, and subsequent return to, Genoa, when in 1800 Masséna was closely besieged in that city. He became a cavalry colonel in 1803, was promoted general of brigade on the field of Austerlitz, and served in southern Italy and in Spain on the staff of King Joseph Bonaparte. During the Peninsular War he won great distinction as a cavalry general, and in 1810 Napoleon made him a baron. At this time he was a prisoner in the hands of the Spaniards, into whose hands he had fallen while bearing important despatches during the campaign of Talavera. He was harshly treated by his captors, and died at Carthage on the 23rd of October 1810. The second was **FRANÇOIS FRANCESCHI-LOSIO** (1770–1810), born at Milan, who entered the French Revolutionary army in 1795. He served through the Italian campaign of 1796–97, and subsequently, like Franceschi-Delonne, with Masséna at Zürich and at Genoa, and at the headquarters of King Joseph in Italy and Spain. He was killed in a duel by the Neapolitan colonel Filangieri in 1810.

FRANCESCHI, PIERO (or **PIETRO**) **DE'** (c. 1416–1492), Italian painter of the Umbrian school. This master is generally named Piero della Francesca (Peter, son of Frances), the tradition being that his father, a woollen-draper named Benedetto, had died before his birth. This is not correct, for the mother's name was Romana, and the father continued living during many years of Piero's career. The painter is also named Piero Borghese, from his birthplace, Borgo San Sepolcro, in Umbria. The true family name was, as above stated, Franceschi, and the family still exists under the name of Martini-Franceschi.

Piero first received a scientific education, and became an adept in mathematics and geometry. This early bent of mind and course of study influenced to a large extent his development as a painter. He had more science than either Paolo Uccello or Mantegna, both of them his contemporaries, the former older and the latter younger. Skillful in linear perspective, he fixed rectangular planes in perfect order and measured them, and thus got his figures in true proportional height. He preceded and excelled Domenico Ghirlandajo in projecting shadows, and rendered with considerable truth atmosphere, the harmony of colours, and the relief of objects. He was naturally therefore excellent in architectural painting, and, in point of technique, he advanced the practice of oil-colouring in Italy.

The earliest trace that we find of Piero as a painter is in 1439, when he was an apprentice of Domenico Veneziano, and assisted him in painting the chapel of S. Egidio, in S. Maria Novella of Florence. Towards 1450 he is said to have been with the same artist in Loreto; nothing of his, however, can now be identified in that locality. In 1451 he was by himself, painting in Rimini, where a fresco still remains. Prior to this he had executed some extensive frescoes in the Vatican; but these were destroyed when Raphael undertook on the same walls the "Liberation of St Peter" and other paintings. His most extensive extant series of frescoes is in the choir of S. Francesco in Arezzo,—the

"History of the Cross," beginning with legendary subjects of the death and burial of Adam, and going on to the entry of Heraclius into Jerusalem after the overthrow of Chosroes. This series is, in relation to its period, remarkable for effect, movement, and mastery of the nude. The subject of the "Vision of Constantine" is particularly vigorous in chiaroscuro; and a preparatory design of the same composition was so highly effective that it used to be ascribed to Giorgione, and might even (according to one authority) have passed for the handiwork of Correggio or of Rembrandt. A noted fresco in Borgo San Sepolcro, the "Resurrection," may be later than this series; it is preserved in the Palazzo de' Conservatori. An important painting of the "Flagellation of Christ," in the cathedral of Urbino, is later still, probably towards 1470. Piero appears to have been much in his native town of Borgo San Sepolcro from about 1445, and more especially after 1454, when he finished the series in Arezzo. He grew rich there, and there he died, and in October 1492 was buried.

Two statements made by Vasari regarding "Piero della Francesca" are open to much controversy. He says that Piero became blind at the age of sixty, which cannot be true, as he continued painting some years later; but scepticism need perhaps hardly go to the extent of inferring that he was never blind at all. Vasari also says that Fra Luca Pacioli, a disciple of Piero in scientific matters, defrauded his memory by appropriating his researches without acknowledgment. This is hard upon the friar, who constantly shows a great reverence for his master in the sciences. One of Pacioli's books was published in 1509, and speaks of Piero as still living. Hence it has been propounded that Piero lived to the patriarchal age of ninety-four or upwards; but, as it is now stated that he was buried in 1492, we must infer that there is some mistake in relation to Pacioli's remark—perhaps the date of writing was several years earlier than that of publication. Piero was known to have left a manuscript of his own on perspective; this remained undiscovered for a long time, but eventually was found by E. Harzen in the Ambrosian library of Milan, ascribed to some supposititious "Pietro, Pittore di Bruges." The treatise shows a knowledge of perspective as dependent on the point of distance.

In the National Gallery, London, are three paintings attributed to Piero de' Franceschi. Another work, a profile of Isotta da Rimini, may safely be rejected. The "Baptism of Christ," which used to be the altar-piece of the Priory of the Baptist in Borgo San Sepolcro, is an important example; and still more so the "Nativity," with the Virgin kneeling, and five angels singing to musical instruments. This is a very interesting and characteristic specimen, and has indeed been praised somewhat beyond its deservings on aesthetic grounds.

Piero's earlier style was energetic but unrefined, and to the last he lacked selectness of form and feature. The types of his visages are peculiar, and the costumes (as especially in the Arezzo series) singular. He used to work assiduously from clay models swathed in real drapery. Luca Signorelli was his pupil, and probably to some extent Perugino; and his own influence, furthered by that of Signorelli, was potent over all Italy. Belonging as he does to the Umbrian school, he united with that style something of the Siennese and more of the Florentine mode.

Besides Vasari and Crowe & Cavalcaselle, the work by W. G. Waters, *Piero della Francesca* (1899) should be consulted.

(W. M. R.)

FRANCESCHINI, BALDASSARE (1611–1689), Italian painter of the Tuscan school, named, from Volterra the place of his birth, Il Volterrano, or (to distinguish him from Ricciarelli) Il Volterrano Giuniore, was the son of a sculptor in alabaster. At a very early age he learned from Cosimo Daddi some of the elements of art, and he started as an assistant to his father. This employment being evidently below the level of his talents, the marquises Inghirami placed him, at the age of sixteen, under the Florentine painter Matteo Rosselli. In the ensuing year he had advanced sufficiently to execute in Volterra some frescoes, skilful in foreshortening, followed by other frescoes for the Medici family in the Valle della Petraia. In 1652 the marchese Filippo Niccolini, being minded to employ Franceschini upon the frescoes for the cupola and back-wall of his chapel in S. Croce, Florence, despatched him to various parts of Italy to perfect his style. The painter, in a tour which lasted some months, took more especially to the qualities distinctive of the schools of Parma and Bologna, and in a measure to those of Pietro da Cortona, whose acquaintance he made in Rome. He then undertook the paintings commissioned by Niccolini, which

constitute his most noted performance, the design being good, and the method masterly. Franceschini ranks higher in fresco than in oil painting. His works in the latter mode were not unfrequently left unfinished, although numerous specimens remain, the cabinet pictures being marked by much sprightliness of invention. Among his best oil paintings of large scale is the "St John the Evangelist" in the church of S. Chiara at Volterra. One of his latest works was the fresco of the cupola of the Annunziata, Florence, which occupied him for two years towards 1683, a production of much labour and energy. Franceschini died of apoplexy at Volterra on the 6th of January 1689. He is reckoned among those painters of the decline of art to whom the general name of "machinist" is applied.

He is not to be confounded with another Franceschini of the same class, and of rather later date, also of no small eminence in his time—the Cavaliere Marcantonio Franceschini (1648–1729), who was a Bolognese.

FRANCHE-COMTÉ, a province of France from 1674 to the Revolution. It was bounded on the E. by Switzerland, on the S. by Bresse and Bugey, on the N. by Lorraine, and on the W. by the duchy of Burgundy and by Bassigny, embracing to the E. of the Jura the valley of the Saône and most of that of the Doubs. Under the Romans it corresponded to *Maxima Sequanorum*, and after having formed part of the kingdom of Burgundy was in the early part of the middle ages split up into the four countships of Portois, Varais, Amons and Escuens. In the 10th century these four countships were united to form a whole, which came to be called the countship of Burgundy, and belonged at that time to the family of the counts of Mâcon.

The limits of the countship were definitely settled under Otto William, son of Albert or Adalbert, king of Italy (†1027), who on the death of his father-in-law, Henry (1002), tried to seize the duchy of Burgundy, but without success. The countship, which formed a fief dependent on the kingdom of Burgundy, passed to Renaud I., the second son of Otto William. When the kingdom of Burgundy was joined to the Germanic empire, he refused to pay homage to the emperor Henry III., whose suzerainty over him never existed except in theory. William I., surnamed the Great or Headstrong (1059–1087), still further added to the power of his house by marrying Etiennette, heiress of the count of Vienne, and by acquiring from his cousin Guy, when the latter became a monk at Cluny, the countship of Mâcon. One of his sons, Guy, became pope, under the name of Calixtus II. His grandson, Renaud III. (1097–1148), in his turn refused to pay homage to the emperor Lothair, who retaliated by confiscating his dominions and giving them to Conrad of Zähringen. Renaud, however, succeeded in maintaining until his death his possession of the countships of Burgundy, Vienne and Mâcon. He left as sole heiress a daughter, Beatrix, whom his brother William III. imprisoned, in order to make an attempt on her inheritance; she was set free, however, by the emperor Frederick Barbarossa, who married her in 1156.

On the death of Beatrix (1185) the countship of Burgundy passed to Otto I. (1190–1200), the youngest but one of her sons, who had to dispute its possession with Stephen, count of Auxonne, the grandson of William III. Beatrix, the daughter and heiress of Otto I. (1200–1231), married Otto, duke of Meran (†1234), under whose government the inhabitants of Besançon, which had been since the time of Frederick Barbarossa an imperial city, formed themselves definitely into a *commune*. Alix, daughter of Beatrix and of Otto of Meran, and heiress to the countship of Burgundy, married Hugh of Chalon, son of John the Ancient or the Wise (d. 1248), and a descendant of William III. and consequently of William the Headstrong, thus bringing the countship back into the family of its former lords. His son Otto IV. (1279–1303) engaged in war against the bishop of Basel, and the German king Rudolph I., who supported the latter, entered Franche-Comté and besieged Besançon, but without success (1289). Otto, in fulfilment of the treaties of Ervennes and Vincennes (1291–1295) gave Jeanne, his daughter by Mahaut of Artois, in marriage to Philip, count of Poitiers, son of Philip the Fair. The latter took over the administration

of the countship in spite of strong opposition from the nobles of the country, but their leader, John of Chalon-Arlay, was compelled to make his submission. Another of Otto's daughters married Charles IV., the Handsome, and both princesses, together with their sister-in-law Margaret of Burgundy, were concerned in the celebrated trial of the Tour de Nesle. Jeanne, however, continued to govern her countship when Philip her husband became king of France (Philip V., "the Long"). Jeanne, their daughter and heiress, married Odo IV., duke of Burgundy (1330–1347), and her sister Margaret became the wife of Louis II., count of Flanders. The countship returned to Margaret at the death of Odo IV., who was succeeded in his duchy by his grandson Philip of Rouvre.

The marriage of Philip the Bold with Margaret, daughter of Louis of Mâle, caused Franche-Comté to pass to the princes of the ducal house of Burgundy, who kept it up till the death of Charles the Bold (1477). On his death Louis XI. laid claim to the government of the countship as well as of the duchy, as trustee for the property of the princess Mary, who was closely related to him and destined to marry the dauphin (later Charles VIII.). French garrisons occupied the principal towns, and the lord of Craon was appointed governor of the country. In consequence of his severity there was a general rising, and at the same time Mary married Maximilian, archduke of Austria, to whom her father had formerly betrothed her (Aug. 1477). The French were expelled from the fortified towns and Craon beaten by the people of Dôle. Charles of Amboise, who took his place, reconquered the province, and even Besançon submitted to the authority of the king of France, who promised to respect its privileges.

On the death of Louis XI. (1483), the estates of Franche-Comté recognized as sovereign his son Charles, who was betrothed to the little Margaret of Burgundy, daughter of Maximilian and Mary (d. 1482), but when Charles VIII. refused Margaret's hand in order to marry Anne of Brittany there was a fresh rising, and the French were again driven out. The treaty of Senlis (23rd May 1483) put an end to the struggle: Charles abandoned all his pretensions, and Maximilian was thus left in possession of Franche-Comté, the sovereignty of which he handed on to his son Philip and ultimately to the crown of Spain. He had, however, constituted his daughter Margaret sovereign-governess of Franche-Comté for life, and under the administration of this princess (who died in 1530), as under the rule of Charles V., the country enjoyed comparative independence, paying a "*don gratuit*" of 200,000 livres every three years, and being actually governed by the parliament of Dôle, and by governors chosen from the nobility of the country. It was Franche-Comté which furnished Philip II. of Spain with one of his best counsellors, Cardinal Perrenot de Granvelle.

In the 16th century the country was disturbed by the preaching of Protestant doctrines, which gained adherents especially in the district of Montbéliard, and later by the wars between France and Spain. In 1595 the armies of Henry IV. levied contributions on Besançon and other towns; but the people of Franche-Comté succeeded in obtaining special terms of neutrality in order to shelter themselves from injury from either of the parties in the war, and enjoyed a period of calm under the government of the infanta Isabella Clara Eugénie and the archduke Albert (1599–1621). But the country suffered greatly from the ravages of the Thirty Years' War, from the presence of the army of the Condés, which besieged Dôle, from the devastation of the troops of Gallas, and later of those of Bernard of Saxe-Weimar. The peace of Westphalia (1648) confirmed Spain in the possession of Franche-Comté. In 1668 the French again entered it, and the conquest, of which the foundations had been laid by the intrigues of the abbot of Watteville and the French party constituted by him, was easily accomplished by Condé and Luxemburg, Louis XIV. directing the army in Franche-Comté for some time in person. None the less, the country was restored to Spain at the peace of Aix-la-Chapelle (1668), but in 1674 Louis headed another expedition there. Besançon capitulated after a siege of twenty-seven days, and Dôle and Salins also fell into the hands of the invaders.

In 1678 the treaty of Nijmegen gave Franche-Comté to France (the principality of Montbéliard remaining in the possession of the house of Württemberg, which had acquired it by marriage), and it was in celebration of this conquest that the Arc de Triomphe of the Portes Saint Denis and Saint Martin at Paris was erected. Franche-Comté became a military government (*gouvernement*). The estates ceased to meet, and the old "*don gratuit*" was replaced by a tax which became increasingly heavy. Louis made Besançon, which Vauban fortified, into the capital of the province, and transferred to it the parliament and the university, the seat of which had hitherto been Dôle. For purposes of administration, the county was divided among the four great *bailliages* of Besançon, Dôle, Amont (chief town Vesoul) and Aval (chief town Salins). At the Revolution were formed from it the departments of Jura, Doubs and Haute-Saône.

See Dunod, *Histoire des Sequanois; Hist. du comté de Bourgogne* (Dijon, 1735-1740); E. Clerc, *Essai sur l'histoire de la Franche-Comté* (2nd ed., Besançon, 1870). (R. Po.)

FRANCHISE (from O. Fr. *franchise*, freedom, *franc*, free), in English law, a royal privilege or branch of the crown's prerogative subsisting in the hands of a subject. A franchise is an incorporeal hereditament, and arises either from royal grants or from prescription which presupposes a grant. Such franchises are bodies corporate, the right to hold a fair, market, ferry, free fishery, &c. The term is also applied to the right of voting at elections and the qualifications upon which that right is based (see REGISTRATION; REPRESENTATION; VOTE). In the United States the term is especially applied to the right or powers of partial appropriation of public property by exclusive use, or to a privilege of a public nature conferred on a corporation created for the purpose.

FRANCIA (c. 1450-1517), a Bolognese painter, whose real name was Francesco Raibolini, his father being Marco di Giacomo Raibolini, a carpenter, descended from an old and creditable family, was born at Bologna about 1450. He was apprenticed to a goldsmith currently named Francia, and from him probably he got the nickname whereby he is generally known; he moreover studied design under Marco Zoppo. The youth was thus originally a goldsmith, and also an engraver of dies and niellos, and in these arts he became extremely eminent. He was particularly famed for his dies for medals; he rose to be mint-master at Bologna, and retained that office till the end of his life. A famous medal of Pope Julius II. as liberator of Bologna is ascribed to his hand, but not with certainty. As a type-founder he made for Aldus Manutius the first italic type.

At a mature age—having first, it appears, become acquainted with Mantegna—he turned his attention to painting. His earliest known picture is dated 1494 (not 1490, as ordinarily stated). It shows so much mastery that one is compelled to believe that Raibolini must before then have practised painting for some few years. This work is now in the Bologna gallery,—the "Virgin enthroned, with Augustine and five other saints." It is an oil picture, and was originally painted for the church of S. Maria della Misericordia, at the desire of the Bentivoglio family, the rulers of Bologna. The same patrons employed him upon frescoes in their own palace; one of "Judith and Holofernes" is especially noted, its style recalling that of Mantegna. Francia probably studied likewise the works of Perugino; and he became a friend and ardent admirer of Raphael, to whom he addressed an enthusiastic sonnet. Raphael cordially responded to the Bolognese master's admiration, and said, in a letter dated in 1508, that few painters or none had produced Madonnas more beautiful, more devout, or better portrayed than those of Francia. If we may trust Vasari—but it is difficult to suppose that he was entirely correct—the exceeding value which Francia set on Raphael's art brought him to his grave. Raphael had consigned to Francia his famous picture of "St Cecilia," destined for the church of S. Giovanni in Monte, Bologna; and Francia, on inspecting it, took so much to heart his own inferiority, at the advanced age of about sixty-six, to the youthful Umbrian, that he sickened and shortly expired on the 6th of January 1517.

A contemporary record, after attesting his pre-eminence as a goldsmith, jeweller and painter, states that he was "most handsome in person and highly eloquent."

Distanced though he may have been by Raphael, Francia is rightly regarded as the greatest painter of the earlier Bolognese school, and hardly to be surpassed as representing the art termed "antico-moderno," or of the "quattrocento." It has been well observed that his style is a medium between that of Perugino and that of Giovanni Bellini; he has somewhat more of spontaneous naturalism than the former, and of abstract dignity in feature and form than the latter. The magnificent portrait in the Louvre of a young man in black, of brooding thoughtfulness and saddened profundity of mood, would alone suffice to place Francia among the very great masters, if it could with confidence be attributed to his hand, but in all probability its real author was Franciabigio; it had erewhile passed under the name of Raphael, of Giorgione, or of Sebastian del Piombo. The National Gallery, London, contains two remarkably fine specimens of Francia, once combined together as principal picture and lunette,—the "Virgin" and "Child and St Anna" enthroned, surrounded by saints, and (in the lunette) the "Pietà," or lamentation of angels over the dead Saviour. They come from the Buonvisi chapel in the church of S. Frediano, Lucca, and were among the master's latest paintings. Other leading works are—in Munich, the "Virgin" sinking on her knees in adoration of the Divine Infant, who is lying in a garden within a rose trellis; in the Borghese gallery, Rome, a Peter Martyr; in Bologna, the frescoes in the church of St Cecilia, illustrating the life of the saint, all of them from the design of Raibolini, but not all executed by himself. His landscape backgrounds are of uncommon excellence. Francia had more than 200 scholars. Marcantonio Raimondi, the famous engraver, is the most renowned of them; next to him Amico Aspertini, and Francia's own son Giacomo, and his cousin Julio. Lorenzo Costa was much associated with Francia in pictorial work.

Among the authorities as to the life and work of Francia may be mentioned J. A. Calvi, *Memorie della vita di Francesco Raibolini* (1812), and especially G. C. Williamson, *Francia* (1900). (W. M. R.)

FRANCIA, JOSÉ GASPAR RODRIGUEZ (c. 1757-1840), dictator of Paraguay, was born probably about 1757. According to one account he was of French descent; but the truth seems to be that his father, Garcia Rodriguez Francia, was a native of S. Paulo in Brazil, and came to Paraguay to take charge of a plantation of black tobacco for the government. He studied theology at the college of Cordova de Tucuman, and is said to have been for some time a professor in that faculty; but he afterwards turned his attention to the law, and practised in Asuncion. Having attained a high reputation at once for ability and integrity, he was selected for various important offices. On the declaration of Paraguayan independence in 1811, he was appointed secretary to the national junta, and exercised an influence on affairs greatly out of proportion to his nominal position. When the congress or junta of 1813 changed the constitution and established a duumvirate, Dr Francia and the Gaucho general Yegres were elected to the office. In 1814 he secured his own election as dictator for three years, and at the end of that period he obtained the dictatorship for life. In the accounts which have been published of his administration we find a strange mixture of capacity and caprice, of far-sighted wisdom and reckless infatuation, strenuous endeavours after a high ideal and flagrant violations of the simplest principles of justice. He put a stop to the foreign commerce of the country, but carefully fostered its internal industries; was disposed to be hospitable to strangers from other lands, and kept them prisoners for years; lived a life of republican simplicity, and punished with Dionysian severity the slightest want of respect. As time went on he appears to have grown more arbitrary and despotic. Deeply imbued with the principles of the French Revolution, he was a stern antagonist of the church. He abolished the Inquisition, suppressed the college of theology, did away with the tithes, and inflicted endless indignities on the priests. He discouraged marriage

both by precept and example, and left behind him several illegitimate children. For the extravagances of his later years the plea of insanity has been put forward. On the 20th of September 1840 he was seized with a fit and died.

The first and fullest account of Dr Francia was given to the world by two Swiss surgeons, Rengger and Longchamp, whom he had detained from 1819 to 1825—*Essai historique sur la révolution de Paraguay et la gouvernement dictatorial du docteur Francia* (Paris, 1827). Their work was almost immediately translated into English under the title of *The Reign of Doctor Joseph G. R. De Francia in Paraguay* (1827). About eleven years after there appeared at London *Letters on Paraguay*, by J. P. and W. P. Robertson, two young Scotsmen whose hopes of commercial success had been rudely destroyed by the dictator's interference. The account which they gave of his character and government was of the most unfavourable description, and they rehearsed and emphasized their accusations in *Francia's Reign of Terror* (1839) and *Letters on South America* (3 vols., 1843). From the very pages of his detractors Thomas Carlyle succeeded in extracting materials for a brilliant defence of the dictator "as a man or sovereign of iron energy and industry, of great and severe labour." It appeared in the *Foreign Quarterly Review* for 1843, and is reprinted in his *Critical and Miscellaneous Essays*. Sir Richard F. Burton gives a graphic sketch of Francia's life and a favourable notice of his character in his *Letters from the Battlegrounds of Paraguay* (1870), while C. A. Washburn takes up a hostile position in his *History of Paraguay* (1871).

FRANCIABIGIO (1482-1525), Florentine painter. The name of this artist is generally given as Mercantonio Franciabigio; it appears, however, that his only real ascertained name was Francesco di Cristofano; and that he was currently termed Francia Bigio, the two appellatives being distinct. He was born in Florence, and studied under Albertinelli for some months. In 1505 he formed the acquaintance of Andrea del Sarto; and after a while the two painters set up a shop in common in the Piazza del Grano. Franciabigio paid much attention to anatomy and perspective, and to the proportions of his figures, though these are often too squat and puffy in form. He had a large stock of artistic knowledge, and was at first noted for diligence. As years went on, and he received frequent commissions for all sorts of public painting for festive occasions, his diligence merged in something which may rather be called workmanly offhandedness. He was particularly proficient in fresco, and Vasari even says that he surpassed all his contemporaries in this method—a judgment which modern connoisseurship does not accept. In the court of the Servites (or cloister of the Annunziata) in Florence he painted in 1513 the "Marriage of the Virgin," as a portion of a series wherein Andrea del Sarto was chiefly concerned. The friars having uncovered this work before it was quite finished, Franciabigio was so incensed that, seizing a mason's hammer, he struck at the head of the Virgin, and some other heads; and the fresco, which would otherwise be his masterpiece in that method, remains thus mutilated. At the Scalzo, in another series of frescoes on which Andrea was likewise employed, he executed in 1518-1519 the "Departure of John the Baptist for the Desert," and the "Meeting of the Baptist with Jesus"; and, at the Medici palace at Poggio a Caiano, in 1521, the "Triumph of Cicero." Various works which have been ascribed to Raphael are now known or reasonably deemed to be by Franciabigio. Such are the "Madonna del Pozzo," in the Uffizi Gallery; the half figure of a "Young Man," in the Louvre (see also FRANCIA); and the famous picture in the Fuller-Maitland collection, a "Young Man with a Letter." These two works show a close analogy in style to another in the Pitti gallery, avowedly by Franciabigio, a "Youth at a Window," and to some others which bear this painter's recognized monogram. The series of portraits, taken collectively, placed beyond dispute the eminent and idiosyncratic genius of the master. Two other works of his, of some celebrity, are the "Calumny of Apelles," in the Pitti, and the "Bath of Bathsheba" (painted in 1523), in the Dresden gallery.

FRANCIS (Lat. *Franciscus*, Ital. *Francesco*, Span. *Francisco*, Fr. *François*, Ger. *Franz*), a masculine proper name meaning "Frenchman." As a Christian name it originated with St Francis of Assisi, whose baptismal name was Giovanni, but who was called Francesco by his father on returning from a journey

in France. The saint's fame made the name exceedingly popular from his day onwards.

FRANCIS I. (1708-1765), Roman emperor and grand duke of Tuscany, second son of Leopold Joseph, duke of Lorraine, and his wife Elizabeth Charlotte, daughter of Philip, duke of Orleans, was born on the 8th of December 1708. He was connected with the Habsburgs through his grandmother Eleanore, daughter of the emperor Ferdinand III., and wife of Charles Leopold of Lorraine. The emperor Charles VI. favoured the family, who, besides being his cousins, had served the house of Austria with distinction. He had designed to marry his daughter Maria Theresa to Clement, the elder brother of Francis. On the death of Clement he adopted the younger brother as her husband. Francis was brought up at Vienna with Maria Theresa on the understanding that they were to be married, and a real affection arose between them. At the age of fifteen, when he was brought to Vienna, he was established in the Silesian duchy of Teschen, which had been mediatized and granted to his father by the emperor in 1722. He succeeded his father as duke of Lorraine in 1729, but the emperor, at the end of the Polish War of Succession, desiring to compensate his candidate Stanislaus Leszczyński for the loss of his crown in 1735, persuaded Francis to exchange Lorraine for the reversion of the grand duchy of Tuscany. On the 12th of February 1736 he was married to Maria Theresa, and they went for a short time to Florence, when he succeeded to the grand duchy in 1737 on the death of John Gaston, the last of the ruling house of Medici. His wife secured his election to the Empire on the 13th of September 1745, in succession to Charles VII., and she made him co-regent of her hereditary dominions. Francis was well content to leave the reality of power to his able wife. He had a natural fund of good sense and some business capacity, and was a useful assistant to Maria Theresa in the laborious task of governing the complicated Austrian dominions, but his functions appear to have been of a purely secretarial character. He died suddenly in his carriage while returning from the opera at Innsbruck on the 18th of August 1765.

See A. von Arneth, *Geschichte Maria Theresias* (Vienna, 1863-1879).

FRANCIS II. (1768-1835), the last Roman emperor, and, as Francis I., first emperor of Austria, was the son of Leopold II., grand-duke of Tuscany, afterwards emperor, and of his wife Maria Louisa, daughter of Charles III. of Spain. He was born at Florence on the 12th of February 1768. In 1784 he was brought to Vienna to complete his education under the eye of his uncle the emperor Joseph II., who was childless. Joseph was repelled by the frigid and retiring character of his nephew, and is said to have treated him with an impatient contempt which confirmed his natural timidity; but after the marriage of Francis to Elizabeth of Württemberg (1788) their relations improved. At the close of his uncle's reign he saw some service in the ill-conducted war with Turkey, and kept a careful diary of his experiences. The death of his wife in childbirth on the 18th of February 1790 was followed by the death of his uncle on the 20th; and Francis acted as regent with Prince Kaunitz until his father came from Florence. On the 19th of September he married his first cousin Maria Theresa, daughter of Ferdinand, king of Naples, by whom he was the father of his successor Ferdinand I., of Maria Louisa, wife of Napoleon, and of the archduke Francis, father of the emperor Francis Joseph. After her death (1807) he married Maria Ludovica Beatrix of Este (1808), and when she died he made a fourth marriage with Carolina Augusta of Bavaria (1816).

He succeeded to the Austrian dominions and the empire on the death of his father on the 1st of March 1792. The position was a trying one for a young prince twenty-four years of age. The dominions of the house of Austria, widely scattered in the Low Countries, Germany and Italy, were exposed to the attacks of the French revolutionary governments and of Napoleon. He was dragged into all the coalitions against France, and in the early days of his reign he had to guard against the ambition of Prussia, and the aggressions of Russia in Poland and Turkey.

For long he had no adviser save such diplomatists as Prince Kaunitz and Thugut, who had been trained in the old Austrian diplomacy. His own best quality was an invincible patience supported by reliance on the loyalty of his subjects, and a sense of his duty to the state. (For the general events of this reign till 1815 see EUROPE, AUSTRIA, NAPOLEON, FRENCH REVOLUTIONARY WARS, &c.) The emperor's firmness averted what would have been an irreparable loss of position. Seeing that the Empire was in the last stage of dissolution, and that, even were it to survive, it would pass from the house of Habsburg to that of Bonaparte, he in 1804 assumed the title of hereditary emperor of Austria. The object of this prudent measure was double. In the first place, he guarded against the danger that his house should sink to a lower rank than the Russian or the French. In the second place, he gave some semblance of unity to his complex dominions in Germany, Bohemia, Hungary and Italy, by providing a common title for the supreme ruler. His action was justified when, in 1806, the establishment of the Confederation of the Rhine forced him to abdicate the empty title of Holy Roman emperor.

In 1805 he made an important change in the working of his administration. He had hitherto been assisted by a cabinet minister who was in direct relation with all the "chanceries" and boards which formed the executive government, and who acted as the channel of communication between them and the emperor, and was in fact a prime minister. In 1805 Napoleon insisted on the removal of Count Colloredo, who held the post. From that time forward the emperor Francis acted as his own prime minister, superintending every detail of his administration. In foreign affairs after 1809 he reposed full confidence in Prince Metternich. But Metternich himself declared at the close of his life that he had sometimes held Europe in the palm of his hand, but never Austria. Francis was sole master, and is entitled to whatever praise is due to his government. It follows that he must bear the blame for its errors. The history of the Austrian empire under his rule and since his death bears testimony to both his merits and his limitations. His indomitable patience and loyalty to his inherited task enabled him to triumph over Napoleon. By consenting to the marriage of his daughter, Marie Louise, to Napoleon in 1810, he gained a respite which he turned to good account. By following the guidance of Metternich in foreign affairs he was able to intervene with decisive effect in 1813. The settlement of Europe in 1815 left Austria stronger and more compact than she had been in 1792, and that this was the case was largely due to the emperor.

During the twenty years which preceded his death in 1835, Francis continued to oppose the revolutionary spirit. He had none of the mystical tendencies of the tsar Alexander I., and only adhered to the half fantastic Holy Alliance of 1815 out of pure politeness. But he was wholly in sympathy with the policy of "repression" which came, in popular view, to be identified with the Holy Alliance; and though Metternich was primarily responsible for the part played by Austria in the "policing" of Europe, Francis cannot but be held personally responsible for the cruel and impolitic severities, associated especially with the sinister name of the fortress prison of the Spielberg, which made so many martyrs to freedom. It is not surprising that Francis was denounced by Liberals throughout Europe as a tyrant and an obscurantist. But though at home, as abroad, he met all suggestions of innovation by a steady refusal to depart from old ways, he was always popular among the mass of his subjects, who called him "our good Kaiser Franz." In truth, if in the spirit of the traditional *Landesvater* he chastised his disobedient children mercilessly, he was essentially a well-meaning ruler who forwarded the material and moral good of his subjects according to his lights. But he held that, by the will of God, the whole sovereign authority resided in his person, and could not be shared with others without a dereliction of duty on his part and disastrous consequences; and his capital error as a ruler of Austria was that he persisted in maintaining a system of administration which depended upon the indefatigable industry of a single man, and was entirely outgrown by the modern develop-

ment of his subjects. Before his death, government in Austria was almost choked, and it broke down under a successor who had not his capacity for work. Like his ancestor Philip II. of Spain, Francis carried caution, and a disposition to sleep upon every possible proposal, to a great length. He died on the 2nd of March 1835.

See Baron J. A. Helfert, *Kaiser Franz und die österreichischen Befreiungs-Kriege* (Vienna, 1867). Ample bibliographies will be found in Krones von Marchland's *Grundriss der österreichischen Geschichte* (Berlin, 1882).

FRANCIS I. (1494-1547), king of France, son of Charles of Valois, count of Angoulême, and Louise of Savoy, was born at Cognac on the 12th of September 1494. The count of Angoulême, who was the great-grandson of King Charles V., died in 1496, and Louise watched over her son with passionate tenderness. On the accession of Louis XII. in 1498, Francis became heir-presumptive. Louis invested him with the duchy of Valois, and gave him as tutor Marshal de Gié, and, after Gié's disgrace in 1503, the sieur de Boisy, Artus Gouffier. François de Rochefort, abbot of St Mesmin, instructed Francis and his sister Marguerite in Latin and history; Louise herself taught them Italian and Spanish; and the library of the château at Amboise was well stocked with romances of the Round Table, which exalted the lad's imagination. Francis showed an even greater love for violent exercises, such as hunting, which was his ruling passion, and tennis, and for tournaments, masquerades and amusements of all kinds. His earliest gallantries are described by his sister in the 25th and 42nd stories of the *Heptameron*. In 1507 Francis was betrothed to Claude, the daughter of Louis XII., and in 1508 he came to court. In 1512 he gained his first military experience in Guienne, and in the following year he commanded the army of Picardy. He married Claude on the 18th of May 1514, and succeeded Louis XII. on the 1st of January 1515. Of noble bearing, and, in spite of a very long and large nose, extremely handsome, he was a sturdy and valiant knight, affable, courteous, a brilliant talker and a facile poet. He had a sprightly wit, some delicacy of feeling, and some generous impulses which made him amiable. These brilliant qualities, however, were all on the surface. At bottom the man was frivolous, profoundly selfish, unstable, and utterly incapable of consistency or application. The ambassadors remarked his negligence, and his ministers complained of it. Hunting, tennis, jewelry and his gallantry were the chief preoccupations of his life.

His character was at once authoritative and weak. He was determined to be master and to decide everything himself, but he allowed himself to be dominated and easily persuaded. Favourites, too, without governing entirely for him, played an important part in his reign. His capricious humour elevated and deposed them with the same disconcerting suddenness. In the early years of his reign the conduct of affairs was chiefly in the hands of Louise of Savoy, Chancellor Antoine Duprat, Secretary Florimond Robertet, and the two Gouffiers, Boisy and Bonnivet. The royal favour then elevated Anne de Montmorency and Philippe de Chahot, and in the last years of the reign Marshal d'Annebaud and Cardinal de Tournon. Women too had always a great influence over Francis—his sister, Marguerite d'Angoulême, and his mistresses. Whatever the number of these, he had only two titular mistresses—at the beginning of the reign Françoise de Châteaubriant, and from about 1526 to his death Anne de Pisseleu, whom he created duchesse d'Étampes and who entirely dominated him. It has not been proved that he was the lover of Diane de Poitiers, nor does the story of "La belle Ferronnière" appear to rest on any historical foundation.¹

Circumstances alone gave a homogeneous character to the foreign policy of Francis. The struggle against the emperor Charles V. filled the greater part of the reign. In reality, the policy of Francis, save for some flashes of sagacity, was irresolute and vacillating. Attracted at first by Italy, dreaming of fair feats of prowess, he led the triumphal Marignano expedition, which gained him reputation as a knightly king and as the most powerful prince in Europe. In 1519, in spite of wise counsels,

¹ On this point see Paulin Paris, *Études sur le règne de François I^{er}*.

he stood candidate for the imperial crown. The election of Charles V. caused an inevitable rivalry between the two monarchs which accentuated still further the light and chivalrous temper of the king and the cold and politic character of the emperor. Francis's personal intervention in this struggle was seldom happy. He did not succeed in gaining the support of Henry VIII. of England at the interview of the Field of the Cloth of Gold in 1520; his want of tact goaded the Constable de Bourbon to extreme measures in 1522-1523; and in the Italian campaign of 1525 he proved himself a mediocre, vacillating and foolhardy leader, and by his blundering led the army to the disaster of Pavia (the 25th of February 1525), where, however, he fought with great bravery. "Of all things," he wrote to his mother after the defeat, "nothing remains to me but honour and life, which is safe"—the authentic version of the legendary phrase "All is lost save honour." He strove to play the part of royal captive heroically, but the prison life galled him. He fell ill at Madrid and was on the point of death. For a moment he thought of abdicating rather than of ceding Burgundy. But this was too great a demand upon his fortitude, and he finally yielded and signed the treaty of Madrid, after having drawn up a secret protest. After Madrid he wavered unceasingly between two courses, either that of continuing hostilities, or the policy favoured by Montmorency of peace and understanding with the emperor. At times he had the sagacity to recognize the utility of alliances, as was shown by those he concluded with the Porte and with the Protestant princes of Germany. But he could never pledge himself frankly in one sense or the other, and this vacillation prevented him from attaining any decisive results. At his death, however, France was in possession of Savoy and Piedmont.

In his religious policy Francis showed the same instability. Drawn between various influences, that of Marguerite d'Angoulême, the du Bellays, and the duchesse d'Etampes, who was in favour of the Reformation or at least of toleration, and the contrary influence of the uncompromising Catholics, Duprat, and then Montmorency and de Tournon, he gave pledges successively to both parties. In the first years of the reign, following the counsels of Marguerite, he protected Jacques Lefèvre of Etaples and Louis de Berquin, and showed some favour to the new doctrines. But the violence of the Reformers threw him into the arms of the opposite party. The affair of the Placards in 1534 irritated him beyond measure, and determined him to adopt a policy of severity. From that time, in spite of occasional indulgences shown to the Reformers, due to his desire to conciliate the Protestant powers, Francis gave a free hand to the party of repression, of which the most active and most pitiless member was Cardinal de Tournon; and the end of the reign was sullied by the massacre of the Waldenses (1545).

Francis introduced new methods into government. In his reign the monarchical authority became more imperious and more absolute. His was the government "*du bon plaisir*." By the unusual development he gave to the court he converted the nobility into a brilliant household of dependants. The Concordat brought the clergy into subjection, and enabled him to distribute benefices at his pleasure among the most docile of his courtiers. He governed in the midst of a group of favourites, who formed the *conseil des affaires*. The states-general did not meet, and the remonstrances of the parlement were scarcely tolerated. By centralizing the financial administration by the creation of the *Trésor de l'Épargne*, and by developing the military establishments, Francis still further strengthened the royal power. His government had the vices of his foreign policy. It was uncertain, irregular and disorderly. The finances were squandered in gratifying the king's unbridled prodigality, and the treasury was drained by his luxurious habits, by the innumerable gifts and pensions he distributed among his mistresses and courtiers, by his war expenses and by his magnificent buildings. His government, too, weighed heavily upon the people, and the king was less popular than is sometimes imagined.

Francis owes the greater measure of his glory to the artists and men of letters who vied in celebrating his praises. He was pre-eminently the king of the Renaissance. Of a quick and

cultivated intelligence, he had a sincere love of letters and art. He holds a high place in the history of humanism by the foundation of the Collège de France; he did not found an actual college, but after much hesitation instituted in 1530, at the instance of Guillaume Budé (Budaëus), *Lecteurs royaux*, who in spite of the opposition of the Sorbonne were granted full liberty to teach Hebrew, Greek, Latin, mathematics, &c. The humanists Budé, Jacques Colin and Pierre Duchâtel were the king's intimates, and Clément Marot was his favourite poet. Francis sent to Italy for artists and for works of art, but he protected his own countrymen also. Here, too, he showed his customary indecision, wavering between the two schools. At his court he installed Benvenuto Cellini, Francesco Primaticcio and Rosso del Rosso, but in the buildings at Chambord, St Germain, Villers-Cotterets and Fontainebleau the French tradition triumphed over the Italian.

Francis died on the 31st of March 1547, of a disease of the urinary ducts according to some accounts, of syphilis according to others. By his first wife Claude (d. 1524) he had three sons and four daughters: Louise, who died in infancy; Charlotte, who died at the age of eight; Francis (d. 1536); Henry, who came to the throne as Henry II.; Madeleine, who became queen of Scotland; Charles (d. 1545); and Margaret, duchess of Savoy. In 1530 he married Eleanor, the sister of the emperor Charles V.

AUTHORITIES.—For the official acts of the reign, the *Catalogue des actes de François I^{er}*, published by the Académie des Sciences morales et politiques (Paris, 1887-1907), is a valuable guide. The *Bibliothèque Nationale*, the *National Archives*, &c., contain a mass of unpublished documents. Of the published documents, see N. Camuzat, *Meslanges historiques* . . . (Troyes, 1619); G. Ribier, *Lettres et mémoires d'état* (Paris, 1666); *Lettres de Marguerite d'Angoulême*, ed. by F. Genin (Paris, 1841 and 1842); the *Correspondence of Castillon and Marillac* (ed. by Kaulek, Paris, 1885), of *Odet de Selve* (ed. by Lefèvre-Pontalis, Paris, 1888), and of *Guillaume Pellicier* (ed. by Tausserat-Radel, Paris, 1900); *Captivité du roi François I^{er}*, and *Poésies de François I^{er}* (both ed. by Champollion-Figeac, Paris, 1847, of doubtful authenticity); *Relations des ambassadeurs vénitiens*, &c. Of the memoirs and chronicles, see the journal of Louise of Savoy in S. Guichenon's *Histoire de la maison de Savoie*, vol. iv. (ed. of 1778-1780); *Journal de Jean Barillon*, ed. by de Vaissière (Paris, 1897-1899); *Journal d'un bourgeois de Paris*, ed. by Lalanne (Paris, 1854); *Cronique du roi François I^{er}*, ed. by Guiffrey (Paris, 1868); and the memoirs of Fleuranges, Montluc, Tavannes, Vieilleville, Brantôme and especially Martin du Bellay (coll. Michaud and Poujoulat). Of the innumerable secondary authorities, see especially Paulin Paris, *Études sur le règne de François I^{er}* (Paris, 1885), in which the apologetic tendency is excessive; and H. Lemonnier in vol. v. (Paris, 1903-1904) of E. Lavisse's *Histoire de France*, which gives a list of the principal secondary authorities. There is a more complete bibliographical study by V. L. Bourrilly in the *Revue d'histoire moderne et contemporaine*, vol. iv. (1902-1903). The printed sources have been catalogued by H. Hauser, *Les Sources de l'histoire de France, XVI^e siècle*, tome ii. (Paris, 1907).

FRANCIS II. (1544-1560), king of France, eldest son of Henry II. and of Catherine de' Medici, was born at Fontainebleau on the 10th of January 1544. He married the famous Mary Stuart, daughter of James V. of Scotland, on the 25th of April 1558, and ascended the French throne on the 10th of July 1559. During his short reign the young king, a sickly youth and of feeble understanding, was the mere tool of his uncles Francis, duke of Guise, and Charles, cardinal of Lorraine, into whose hands he virtually delivered the reins of government. The exclusiveness with which they were favoured, and their high-handed proceedings, awakened the resentment of the princes of the blood, Anthony king of Navarre and Louis prince of Condé, who gave their countenance to a conspiracy (conspiracy of Amboise) with the Protestants against the house of Guise. It was, however, discovered shortly before the time fixed for its execution in March 1560, and an ambush having been prepared, most of the conspirators were either killed or taken prisoners. Its leadership and organization had been entrusted to Godfrey de Barri, lord of la Renaudie (d. 1560); and the prince of Condé, who was not present, disavowed all connexion with the plot. The duke of Guise was now named lieutenant-general of the kingdom, but his Catholic leanings were somewhat held in check by the

chancellor Michel de l'Hôpital, through whose mediation the edict of Romorantin, providing that all cases of heresy should be decided by the bishops, was passed in May 1560, in opposition to a proposal to introduce the Inquisition. At a meeting of the states-general held at Orleans in the December following, the prince of Condé, after being arrested, was condemned to death, and extreme measures were being enacted against the Huguenots; but the deliberations of the Assembly were broken off, and the prince was saved from execution, by the king's somewhat sudden death, on the 5th of the month, from an abscess in the ear.

PRINCIPAL AUTHORITIES.—"Lettres de Catherine de Médicis," edited by Hector de la Ferrière (1880 seq.), and "Négociations . . . relatives au règne de François II," edited by Louis Paris (1841), both in the *Collection de documents inédits sur l'histoire de France*; notice of Francis, duke of Guise, in the *Nouvelle Collection des mémoires pour servir à l'histoire de France*, edited by J. F. Michaud and J. J. F. Poujoulat, series i. vol. vi. (1836 seq.); *Mémoires de Condé servant d'éclaircissement . . . à l'histoire de M. de Thou*, vols. i and ii. (1743); Pierre de la Place, *Commentaires de l'estat de la religion et de la république sous les rois Henri II, François II, Charles IX* (1565); and Louis Régnier de la Planche, *Histoire de l'estat de France . . . sous . . . François II* (*Panthéon littéraire*, new edition, 1884). See also Ernest Lavisse, *Histoire de France* (vol. vi. by J. H. Mariéjol, 1904), which contains a bibliography.

FRANCIS I. (1777-1830), king of the Two Sicilies, was the son of Ferdinand IV. (I.) and Maria Carolina of Austria. He married Clementina, daughter of the emperor Leopold II. of Austria, in 1796, and at her death Isabella, daughter of Charles IV. of Spain. After the Bourbon family fled from Naples to Sicily in 1806, and Lord William Bentinck, the British resident, had established a constitution and deprived Ferdinand IV. of all power, Francis was appointed regent (1812). On the fall of Napoleon his father returned to Naples and suppressed the Sicilian constitution and autonomy, incorporating his two kingdoms into that of the Two Sicilies (1816); Francis then assumed the revived title of duke of Calabria. While still heir-apparent he professed liberal ideas, and on the outbreak of the revolution of 1820 he accepted the regency apparently in a friendly spirit towards the new constitution. But he was playing a double game and proved to be the accomplice of his father's treachery. On succeeding to the throne in 1825 he cast aside the mask of liberalism and showed himself as reactionary as his father. He took little part in the government, which he left in the hands of favourites and police officials, and lived with his mistresses, surrounded by soldiers, ever in dread of assassination. During his reign the only revolutionary movement was the outbreak on the Cilento (1828), savagely repressed by the marquis Delcarretto, an ex-Liberal turned reactionary.

See Nisco, *Il Reame di Napoli sotto Francesco I* (Naples, 1893).

FRANCIS II. (1836-1894), king of the Two Sicilies, son of Ferdinand II. and Maria Cristina of Savoy, was the last of the Bourbon kings of Naples. His education had been much neglected and he proved a man of weak character, greatly influenced by his stepmother Maria Theresa of Austria, by the priests, and by the *Camarilla*, or reactionary court set. He ascended the throne on the death of his father (22nd of May 1859). As prime minister he at once appointed Carlo Filangieri, who, realizing the importance of the Franco-Piedmontese victories in Lombardy, advised Francis to accept the alliance with Piedmont proposed by Cavour. On the 7th of June a part of the Swiss Guard mutinied, and while the king mollified them by promising to redress their grievances, General Nunziante collected other troops, who surrounded the mutineers and shot them down. The incident resulted in the disbanding of the whole Swiss Guard, the strongest bulwark of the dynasty. Cavour again proposed an alliance to divide the papal states between Piedmont and Naples, the province of Rome excepted, but Francis rejected an idea which to him savoured of sacrilege. Filangieri strongly advocated a constitution as the only measure which might save the dynasty, and on the king's refusal he resigned. Meanwhile the revolutionary parties were conspiring for the overthrow of the Bourbons in Calabria and Sicily, and Garibaldi was preparing for a raid in the south. A conspiracy in Sicily was discovered and the plotters punished with brutal

severity, but Rosalino Pilo and Francesco Crispi had organized the movement, and when Garibaldi landed at Marsala (May 1860) he conquered the island with astonishing ease. These events at last frightened Francis into granting a constitution, but its promulgation was followed by disorders in Naples and the resignation of ministers, and Liborio Romano became head of the government. The disintegration of the army and navy proceeded apace, and Cavour sent a Piedmontese squadron carrying troops on board to watch events. Garibaldi, who had crossed the straits of Messina, was advancing northwards and was everywhere received by the people as a liberator. Francis, after long hesitations and even an appeal to Garibaldi himself, left Naples (6th of September) with his wife Maria Sophia, the court, the diplomatic corps (the French and English ministers excepted), and went by sea to Gaeta, where a large part of the army was concentrated. The next day Garibaldi entered Naples, was enthusiastically welcomed, and formed a provisional government. King Victor Emmanuel had decided on the invasion of the papal states, and after occupying Romagna and the Marche entered the Neapolitan kingdom. Garibaldi's troops defeated the Neapolitan royalists on the Volturno (1st and 2nd of October), while the Piedmontese captured Capua. Only Gaeta, Messina, and Civitella del Tronto still held out, and the siege of the former by the Piedmontese began on the 6th of November 1860. Both Francis and Maria Sophia behaved with great coolness and courage, and even when the French fleet, whose presence had hitherto prevented an attack by sea, was withdrawn, they still resisted; it was not until the 12th of February 1861 that the fortress capitulated. Thus the kingdom of Naples was incorporated in that of Italy, and the royal pair from that time forth led a wandering life in Austria, France and Bavaria. Francis died on the 27th of December 1894 at Arco in Tirol. His widow survived him.

Francis II. was weak-minded, stupid and vacillating, but, although his short reign was stained with some cruel massacres and persecutions, he was less of a tyrant than his father. The courage and dignity he displayed during his reverses inspired pity and respect. But the fact that he protected brigandage in his former dominions and countenanced the most abominable crimes in the name of legitimism greatly diminished the sympathy which was felt for the fallen monarch.

BIBLIOGRAPHY.—R. de Cesare, *La Fine d'un regno*, vol. ii. (Città di Castello, 1900) gives a detailed account of the reign of Francis II., while H. R. Whitehouse's *Collapse of the Kingdom of Naples* (New York, 1899) may be recommended to English readers; Nisco's *Francesco II* (Naples, 1887) should also be consulted. See under NAPLES; GARIBALDI; BIXIO; CAVOUR; ITALY; FILANGIERI; &c. (L. V.*)

FRANCIS IV. (1779-1846) duke of Modena, was the son of the archduke Ferdinand, Austrian governor of Lombardy, who acquired the duchy of Modena through his wife Marie Beatrice, heiress of the house of Este as well as of many fiefs of the Malaspina, Pio da Carpi, Pico della Mirandola, Cibò, and other families. At the time of the French invasion (1796) Francis was sent to Vienna to be educated, and in 1809 was appointed governor of Galicia. Later he went to Sardinia, where the exiled King Victor Emmanuel I. and his wife Maria Theresa were living in retirement. The latter arranged a marriage between her daughter Marie Beatrice and Francis, and a secret family compact was made whereby if the king and his two brothers died without male issue, the Salic law would be changed so that Francis should succeed to the kingdom instead of Charles Albert of Carignano (N. Bianchi, *Storia della diplomazia europea in Italia*, i. 42-43). On the fall of Napoleon in 1814 Francis received the duchy of Modena, including Massa-Carrara and Lunigiana; his mother's advice was "to be above the law . . . never to forgive the Republicans of 1796, nor to listen to the complaints of his subjects, whom nothing satisfies; the poorer they are the quieter they are" (Silingardi, "Ciro Menotti," in *Rivista europea*, Florence, 1880).

The duke was well received at Modena; inordinately ambitious, strong-willed, immensely rich, avaricious but not unintelligent, he soon proved one of the most reactionary despots in Italy.

He still hoped to acquire either Piedmont or some other part of northern Italy, and he was in touch with the Sanfedisti and the Concistoro, reactionary Catholic associations opposed to the Carbonari, but not always friendly to Austria. Against the Carbonari and other Liberals he issued the severest edicts, and although there was no revolt at Modena in 1821 as in Piedmont and Naples, he immediately instituted judicial proceedings against the supposed conspirators. Some 350 persons were arrested and tortured, 56 being condemned to death (only a few of them were executed) and 237 to imprisonment; a large number, however, escaped, including Antonio Panizzi (afterwards director of the British Museum). The ferocious police official Besini who conducted the trials was afterwards murdered. The duke actually proposed to Prince Metternich, the Austrian chancellor, an agreement whereby the various Italian rulers were to arrest every Liberal in the country on a certain day, but the project fell through owing to opposition from the courts of Florence and Rome. At the congress of Verona Metternich made another attempt to secure the Piedmontese succession for Francis, but without success. The duke became ever more despotic; Modena swarmed with spies and informers, education was hampered, feudalism strengthened; for the duke hoped to consolidate his power by means of the nobility, and the least expression of liberalism, or even failure to denounce a Carbonaro, involved arrest and imprisonment. But strange to say, in 1830 we find Francis actually coquetting with revolution. Having lost all hope of acquiring the Piedmontese throne, he entered into negotiations with the French Orleanist party with a view to obtaining its support in his plans for extending his dominions. He was thus brought into touch with Ciro Menotti (1798-1831) and the Modenese Liberals; what the nature of the connexion was is still obscure, but it was certainly short-lived and merely served to betray the Carbonari. As soon as Francis learned that a conspiracy was on foot to gain possession of the town, he had Menotti and several other conspirators arrested on the night of the 3rd of February 1831, and sent the famous message to the governor of Reggio: "The conspirators are in my hands; send me the hangman" (there is some doubt as to the authenticity of the actual words). But the revolt broke out in other parts of the duchy and in Romagna, and Francis retired to Mantua with Menotti. A provisional government was formed at Modena which proclaimed that "Italy is one," but the duke returned a few weeks later with Austrian troops, and resistance was easily quelled. Then the political trials began; Menotti and two others were executed, and hundreds condemned to imprisonment. The population was now officially divided into four classes, viz. "very loyal, loyal, less loyal, and disloyal," and the reaction became worse than ever, the duke interfering in the minutest details of administration, such as hospitals, schools, and roads. New methods of procedure were introduced to deal with political trials, but the ministerial cabal by which the country was administered intrigued and squabbled to such an extent that it had to be dismissed.

On the 20th of February 1846 Francis died. Although he had many domestic virtues and charming manners, was charitable in times of famine, and was certainly the ablest of the Italian despots, Liberalism was in his eyes the most heinous of crimes, and his reign is one long record of barbarous persecution. (L. V. *)

FRANCIS V. (1810-1875), duke of Modena, son of Francis IV., succeeded his father in 1846. Although less cruel and also less intelligent than his father, he had an equally high opinion of his own authority. His reign began with disturbances at Fivizzano and Pontremoli, which Tuscany surrendered to him according to treaty but against the wishes of the inhabitants (1847), and at Massa and Carrara, where the troops shot down the people. Feeling his position insecure, the duke asked for and obtained an Austrian garrison, but on the outbreak of revolution throughout Italy and at Vienna in 1848, further disorders occurred in the duchy, and on the 20th of March he fled with his family to Mantua. A provisional government was formed, and volunteers were raised who fought with the Piedmontese against Austria. But after the Piedmontese defeat Francis returned to

Modena, with Austrian assistance, in August and conferred many appointments on Austrian officers. Like his father, he interfered in the minutest details of administration, and instituted proceedings against all who were suspected of Liberalism. Not content with the severity of his judges, he overrode their sentences in favour of harsher punishments. The disturbances at Carrara were ruthlessly suppressed, and the prisons filled with politicals. In 1859 numbers of young Modenese fled across the frontier to join the Piedmontese army, as war with Austria seemed imminent; and after the Austrian defeat at Magenta the duke left Modena to lead his army in person against the Piedmontese, taking with him the contents of the state treasury and many valuable books, pictures, coins, tapestries and furniture from the palace. The events of 1859-1860 made his return impossible; and after a short spell of provisional government the duchy was united to Italy. He retired to Austria, and died at Munich in November 1875.

BIBLIOGRAPHY.—N. Bianchi, *I Ducati Estensi* (Turin, 1852); Galvani, *Memorie di S.A.R. Francesco IV* (Modena, 1847); *Documenti riguardanti il governo degli Austro-Estensi in Modena* (Modena, 1860); C. Tivaroni, *L'Italia durante il dominio austriaco*, i. 606-653 (Turin, 1892), and *L'Italia degli Italiani*, i. 114-125 (Turin, 1895); Silingardi, "Ciro Menotti," in the *Rivista europea* (Florence, 1880); F. A. Gualterio, *Gli ultimi rivolgimenti italiani* (Florence, 1850); Bayard de Volo, *Vita di Francesco V* (4 vols., Modena, 1878-1885). (L. V. *)

FRANCIS OF ASSISI, ST. (1181 or 1182-1226), founder of the Franciscans (*q.v.*), was born in 1181 or 1182 at Assisi, one of the independent municipal towns of Umbria. He came from the upper middle class, his father, named Pietro Bernardone, being one of the larger merchants of the city. Bernardone's commercial enterprises made him travel abroad, and it was from the fact that the father was in France at the time of his son's birth that the latter was called Francesco. His education appears to have been of the slightest, even for those days. It is difficult to decide whether words of the early biographers imply that his youth was not free from irregularities; in any case, he was the recognized leader of the young men of the town in their revels; he was, however, always conspicuous for his charity to the poor. When he was twenty (1201) the neighbouring and rival city of Perugia attempted to restore by force of arms the nobles who had been expelled from Assisi by the burghers and the populace, and Francis took part in the battle fought in the plain that lies between the two cities; the men of Assisi were defeated and Francis was among the prisoners. He spent a year in prison at Perugia, and when peace was made at the end of 1202 he returned to Assisi and recommenced his old life.

Soon a serious and prolonged illness fell upon him, during which he entered into himself and became dissatisfied with his way of life. On his recovery he set out on a military expedition, but at the end of the first day's march he fell ill, and had to stay at Spoleto and return to Assisi. This disappointment brought on again the spiritual crisis he had experienced in his illness, and for a considerable time the conflict went on within him. One day he gave a banquet to his friends, and after it they sallied forth with torches, singing through the streets, Francis being crowned with garlands as the king of the revellers; after a time they missed him, and on retracing their steps they found him in a trance or reverie, a permanently altered man. He devoted himself to solitude, prayer and the service of the poor, and before long went on a pilgrimage to Rome. Finding the usual crowd of beggars before St Peter's, he exchanged his clothes with one of them, and experienced an overpowering joy in spending the day begging among the rest. The determining episode of his life followed soon after his return to Assisi; as he was riding he met a leper who begged an alms; Francis had always had a special horror of lepers, and turning his face he rode on; but immediately an heroic act of self-conquest was wrought in him; returning he alighted, gave the leper all the money he had about him, and kissed his hand. From that day he gave himself up to the service of the lepers and the hospitals. To the confusion of his father and brothers he went about dressed in rags, so that his old companions pelted him with mud.

Things soon came to a climax with his father: in consequence of his profuse alms to the poor and to the restoration of the ruined church of St Damian, his father feared his property would be dissipated, so he took Francis before the bishop of Assisi to have him legally disinherited; but without waiting for the documents to be drawn up, Francis cast off his clothes and gave them back to his father, declaring that now he had better reason to say "Our Father which art in heaven," and having received a cloak from the bishop, he went off into the woods of Mount Subasio singing a French song; some brigands accosted him and he told them he was the herald of the great king (1206).

The next three years he spent in the neighbourhood of Assisi in abject poverty and want, ministering to the lepers and the outcasts of society. It was now that he began to frequent the ruined little chapel of St Mary of the Angels, known as the Portiuncula, where much of his time was passed in prayer. One day while Mass was being said therein, the words of the Gospel came to Francis as a call: "Everywhere on your road preach and say—The kingdom of God is at hand. Cure the sick, raise the dead, cleanse the lepers, drive out devils. Freely have you received, freely give. Carry neither gold nor silver nor money in your girdles, nor bag, nor two coats, nor sandals, nor staff, for the workman is worthy of his hire" (Matt. x. 7-10). He at once felt that this was his vocation, and the next day, layman as he was, he went up to Assisi and began to preach to the poor (1209). Disciples joined him, and when they were twelve in number Francis said: "Let us go to our Mother, the holy Roman Church, and tell the pope what the Lord has begun to do through us, and carry it out with his sanction." They obtained the sanction of Innocent III., and returning to Assisi they gave themselves up to their life of apostolic preaching and work among the poor.

The character and development of the order are traced in the article FRANCISCANS; here the story of Francis's own life and the portrayal of his personality will be attempted. To delineate in a few words the character of the Poverello of Assisi is indeed a difficult task. There is such a many-sided richness, such a tenderness, such a poetry, such an originality, such a distinction revealed by the innumerable anecdotes in the memoirs of his disciples, that his personality is brought home to us as one of the most lovable and one of the strongest of men. It is probably true to say that no one has ever set himself so seriously to imitate the life of Christ and to carry out so literally Christ's work in Christ's own way. This was the secret of his love of poverty as manifested in the following beautiful prayer which he addressed to our Lord: "Poverty was in the crib and like a faithful squire she kept herself armed in the great combat Thou didst wage for our redemption. During Thy passion she alone did not forsake Thee. Mary Thy Mother stopped at the foot of the Cross, but poverty mounted it with Thee and clasped Thee in her embrace unto the end; and when Thou wast dying of thirst, as a watchful spouse she prepared for Thee the gall. Thou didst expire in the ardour of her embraces, nor did she leave Thee when dead, O Lord Jesus, for she allowed not Thy body to rest elsewhere than in a borrowed grave. O poorest Jesus, the grace I beg of Thee is to bestow on me the treasure of the highest poverty. Grant that the distinctive mark of our Order may be never to possess anything as its own under the sun for the glory of Thy name, and to have no other patrimony than begging" (in the *Legenda 3 Soc.*). This enthusiastic love of poverty is certainly the keynote of St Francis's spirit; and so one of his disciples in an allegorical poem (translated into English as *The Lady of Poverty* by Montgomery Carmichael, 1901), and Giotto in one of the frescoes at Assisi, celebrated the "holy nuptials of Francis with Lady Poverty."

Another striking feature of Francis's character was his constant joyousness; it was a precept in his rule, and one that he enforced strictly, that his friars should be always rejoicing in the Lord. He retained through life his early love of song, and during his last illness he passed much of his time in singing. His love of nature, animate and inanimate, was very keen and manifested itself in ways that appear somewhat naïve. His preaching to

the birds is a favourite representation of St Francis in art. All creatures he called his "brothers" or "sisters"—the chief example is the poem of the "Praises of the Creatures," wherein "brother Sun," "sister Moon," "brother Wind," and "sister Water" are called on to praise God. In his last illness he was cauterized, and on seeing the burning iron he addressed "brother Fire," reminding him how he had always loved him and asking him to deal kindly with him. It would be an anachronism to think of Francis as a philanthropist or a "social worker" or a revivalist preacher, though he fulfilled the best functions of all these. Before everything he was an ascetic and a mystic—an ascetic who, though gentle to others, wore out his body by self-denial, so much so that when he came to die he begged pardon of "brother Ass the body" for having unduly ill treated it: a mystic irradiated with the love of God, endowed in an extraordinary degree with the spirit of prayer, and pouring forth his heart by the hour in the tenderest affections to God and our Lord. St Francis was a deacon but not a priest.

From the return of Francis and his eleven companions from Rome to Assisi in 1209 or 1210, their work prospered in a wonderful manner. The effect of their preaching, and their example and their work among the poor, made itself felt throughout Umbria and brought about a great religious revival. Great numbers came to join the new order which responded so admirably to the needs of the time. In 1212 Francis invested St Clara (*q.v.*) with the Franciscan habit, and so instituted the "Second Order," that of the nuns. As the friars became more and more numerous their missionary labours extended wider and wider, spreading first over Italy, and then to other countries. Francis himself set out, probably in 1212, for the Holy Land to preach the Gospel to the Saracens, but he was shipwrecked and had to return. A year or two later he went into Spain to preach to the Moors, but had again to return without accomplishing his object (1215 probably). After another period of preaching in Italy and watching over the development of the order, Francis once again set out for the East (1219). This time he was successful; he made his way to Egypt, where the crusaders were besieging Damietta, got himself taken prisoner and was led before the sultan, to whom he openly preached the Gospel. The sultan sent him back to the Christian camp, and he passed on to the Holy Land. Here he remained until September 1220. During his absence were manifested the beginnings of the troubles in the order that were to attain to such magnitude after his death. The circumstances under which, at an extraordinary general chapter convoked by him shortly after his return, he resigned the office of minister-general (September 1220) are explained in the article FRANCISCANS; here, as illustrating the spirit of the man, it is in place to cite the words in which his abdication was couched: "Lord, I give Thee back this family which Thou didst entrust to me. Thou knowest, most sweet Jesus, that I have no more the power and the qualities to continue to take care of it. I entrust it, therefore, to the ministers. Let them be responsible before Thee at the Day of Judgment, if any brother by their negligence, or their bad example, or by a too severe punishment, shall go astray." These words seem to contain the mere truth: Francis's peculiar religious genius was probably not adapted for the government of an enormous society spread over the world, as the Friars Minor had now become.

The chief works of the next years were the revision and final redaction of the Rule and the formation or organization of the "Third Order" or "Brothers and Sisters of Penance," a vast confraternity of lay men and women who tried to carry out, without withdrawing from the world, the fundamental principles of Franciscan life (see TERTIARIES).

If for no other reason than the prominent place they hold in art, it would not be right to pass by the Stigmata without a special mention. The story is well known; two years before his death Francis went up Mount Alverno in the Apennines with some of his disciples, and after forty days of fasting and prayer and contemplation, on the morning of the 14th of September 1224 (to use Sabatier's words), "he had a vision: in the warm rays of the rising sun he discerned suddenly a strange

figure. A seraph with wings extended flew towards him from the horizon and inundated him with pleasure unutterable. At the centre of the vision appeared a cross, and the seraph was nailed to it. When the vision disappeared Francis felt sharp pains mingling with the delights of the first moment. Disturbed to the centre of his being he anxiously sought the meaning of it all, and then he saw on his body the Stigmata of the Crucified." The early authorities represent the Stigmata not as bleeding wounds, the holes as it were of the nails, but as fleshy excrescences resembling in form and colour the nails, the head on the palm of the hand, and on the back as it were a nail hammered down. In the first edition of the *Vie*, Sabatier rejected the Stigmata; but he changed his mind, and in the later editions he accepts their objective reality as an historically established fact; in an appendix he collects the evidence: there exists what is according to all probability an autograph of Br. Leo, the saint's favourite disciple and companion on Mount Alverno at the time, which describes the circumstances of the stigmatization; Elias of Cortona (*q.v.*), the acting superior, wrote on the day after his death a circular letter wherein he uses language clearly implying that he had himself seen the Stigmata, and there is a considerable amount of contemporary authentic second hand evidence. On the strength of this body of evidence Sabatier rejects all theories of fraud or hallucination, whatever may be the explanation of the phenomena.

Francis was so exhausted by the sojourn on Mount Alverno that he had to be carried back to Assisi. The remaining months of his life were passed in great bodily weakness and suffering, and he became almost blind. However, he worked on with his wonted cheerfulness and joyousness. At last, on the 3rd of October 1226, he died in the Portiuncula at the age of forty-five. Two years later he was canonized by Gregory IX., whom, as Cardinal Hugolino of Ostia, he had chosen to be the protector of his order.

The works of St Francis consist of the Rule (in two redactions), the Testament, spiritual admonitions, canticles and a few letters. They were first edited by Wadding in 1623. Two critical editions were published in 1904, one by the Franciscans of Quaracchi near Florence, the other (in a longer and a shorter form) by Professor H. Boehmer of Bonn. Sabatier and Goetz (see below) have investigated the authenticity of the several works; and the four lists, while exhibiting slight variations, are in substantial accord. Besides the works, properly so called, there is a considerable amount of traditional matter— anecdotes, sayings, sermons—preserved in the biographies and in the *Fiorelli*;¹ a great deal of this matter is no doubt substantially authentic, but it is not possible to subject it to any critical sifting.

Note on Sources.—The sources for the life of St Francis and early Franciscan history are very numerous, and an immense literature has grown up around them. Any attempt to indicate even a selection of this literature would here be impossible and also futile; for the discovery of new documents has by no means ceased, and the criticism of the materials is still in full progress, nor can it be said that final results have yet emerged from the discussion. Students will find the chief materials in the following collections: *Archiv für Literatur und Kirchengeschichte des Mittelalters* (ed. by Ehrle and Denifle, 1885, &c.); publications of the Franciscans of Quaracchi (list to be obtained from Herder, Freiburg im Breisgau); and the two series edited by Paul Sabatier, *Collection d'études et de documents sur l'histoire religieuse et littéraire du moyen âge* (5 vols. published up to 1906) and *Opusculs de critique historique* (12 fascicules): the easiest and most consecutive way of following the controversy is by the aid of the "Bulletin Hagiographique" in *Analecta Bollandiana*. Relatively popular accounts of the most important sources are supplied in the introductory chapters of Sabatier's *Vie de S. François* and *Speculum perfectionis*, and Lemp's *Frère Elie de Cortone*.

Concerning the life of St Francis and the beginnings of the order, the chief documents that come under discussion are: the two *Lives* by Thomas of Celano (1228 and 1248 respectively; Eng. trans. with introduction by A. G. Ferrers Howell, 1908), of which the only critical edition is that of Friar Ed. d'Alençon (1906); the so-called *Legenda trium sociorum*; the *Speculum perfectionis*, discovered by Paul Sabatier and edited in 1898 (Eng. trans. by Sebastian Evans,

Mirror of Perfection, 1899). Sabatier's theory as to the nature of these documents was, in brief, that the *Speculum perfectionis* was the first of all the Lives of the saint, written in 1227 by Br. Leo, his favourite and most intimate disciple, and that the *Legenda 3 Soc.* is what it claims to be—the handiwork of Leo and the two other most intimate companions of Francis, compiled in 1246; these are the most authentic and the only true accounts, Thomas of Celano's Lives being written precisely in opposition to them, in the interests of the majority of the order that favoured mitigations of the Rule especially in regard to poverty. For ten years the domain of Franciscan origins was explored and discussed by a number of scholars; and then the whole ground was reviewed by Professor W. Goetz of Munich in a study entitled *Die Quellen zur Geschichte des hl. Franz von Assisi* (1904). His conclusions are substantially the same as those of Père van Ortroy, the Bollandist, and Friar Lemmens, an Observant Franciscan, and are the direct contrary of Sabatier's: the *Legenda 3 Soc.* is a forgery; the *Speculum perfectionis* is a compilation made in the 14th century, also in large measure a forgery, but containing an element (not to be precisely determined) derived from Br. Leo; on the other hand, Thomas of Celano's two Lives are free from the "tendencies" ascribed to them by Sabatier, and that of 1248 was written with the collaboration of Leo and the other companions; thus the best sources of information are those portions of the *Speculum* that can with certainty be carried back to Br. Leo, and the Lives by Thomas of Celano, especially the second *Life*. Goetz's criticism of the documents is characterized by exceeding carefulness and sobriety. Of course he does not suppose that his conclusions are in all respects final; but his investigations show that the time has not yet come when a biography of St Francis could be produced answering to the demands of modern historical criticism. The official life of St Francis is St Bonaventura's *Legenda*, published in a convenient form by the Franciscans of Quaracchi (1898); Goetz's estimate of it (*op. cit.*) is much more favourable than Sabatier's.

Paul Sabatier's fascinating and in many ways sympathetic *Vie de S. François* (1894; 33rd ed., 1906; Eng. trans. by L. S. Houghton, 1901) will probably for a long time to come be accepted by the ordinary reader as a substantially correct portrait of St Francis; and yet Goetz declares that the most competent and independent critics have without any exception pronounced that Sabatier has depicted St Francis a great deal too much from the standpoint of modern religiosity, and has exaggerated his attitude in face of the church (*op. cit.* p. 5). In articles in the *Hist. Vierteljahrsschrift* (1902, 1903) Goetz has shown that Sabatier's presentation of St Francis's relations with the ecclesiastical authority in general, and with Cardinal Hugolino (Gregory IX.) in particular, is largely based on misconception; that the development of the order was not forced on Francis against his will; and that the differences in the order did not during Francis's lifetime attain to such a magnitude as to cause him during his last years the suffering depicted by Sabatier. This from a Protestant historian like Goetz is most valuable criticism. In truth Sabatier's St Francis is an anachronism—a man at heart, a modern pietistic French Protestant of the most liberal type, with a veneer of 13th century Catholicism.

Of lives of St Francis in English may be mentioned those by Mrs Oliphant (2nd ed., 1871) and by Canon Knox Little (1897). For general information and references to the literature of the subject, see Otto Zöckler, *Askese und Mönchtum* (1897), ii. 470-493, and his article in Herzog's *Realencyklopädie* (ed. 3), "Franz von Assisi" (1899); also Max Heimbucher, *Orden und Kongregationen* (1896), i. § 38. The chapter on St Francis in Emile Gebhart's *Italie mystique* (ed. 3, 1899) is very remarkable; indeed, though this writer is as little ecclesiastically-minded as Sabatier himself, his general picture of the state of religion in Italy at the time is far truer; here also Sabatier has given way to the usual temptation of biographers to exalt their hero by depreciating everybody else. (E. C. B.)

FRANCIS OF MAYRONE [FRANCISCUS DE MAYRONIS] (d. 1325), scholastic philosopher, was born at Mayrone in Provence. He entered the Franciscan order and subsequently went to Paris, where he was a pupil of Duns Scotus. At the Sorbonne he acquired a great reputation for ability in discussion, and was known as the *Doctor Illuminatus* and *Magister Acutus*. He became a professor of philosophy, and took part in the discussions on the nature of Universals. Following Duns Scotus, he adopted the Platonic theory of ideas, and denied that Aristotle had made any contribution to metaphysical speculation. It is a curious commentary on the theories of Duns Scotus that one pupil, Francis, should have taken this course, while another pupil, Occam, should have used his arguments in a diametrically opposite direction and ended in extreme Nominalism.

His works were collected and published at Venice in 1520 under the title *Praeclarissima ac multum subtilia scripta Illuminati Doctoris Francisci de Mayronis, &c.*

FRANCIS OF PAOLA (or PAULA), ST, founder of the Minims, a religious order in the Catholic Church, was born of humble

¹ *The Little Flowers of St Francis.*

parentage at Paola in Calabria in 1416, or according to the Bollandists 1438. As a boy he entered a Franciscan friary, but left it and went to live as a hermit in a cave on the seashore near Paola. Soon disciples joined him, and with the bishop's approval he built a church and monastery. At first they called themselves "Hermits of St Francis"; but the object they proposed to themselves was to go beyond even the strict Franciscans in fasts and bodily austerities of all kinds, in poverty and in humility; and therefore, as the Franciscans were the Minors (*minores*, less), the new order took the name of Minims (*minimi*, least). By 1474 a number of houses had been established in southern Italy and Sicily, and the order was recognized and approved by the pope. In 1482 Louis XI. of France, being on his deathbed and hearing the reports of the holiness of Francis, sent to ask him to come and attend him, and at the pope's command he travelled to Paris. On this occasion Philip de Comines in his *Memoirs* says: "I never saw any man living so holly, nor out of whose mouth the Holy Ghost did more manifestly speak." He remained with Louis till his death, and Louis' successor, Charles VIII., held him in such high esteem that he kept him in Paris, and enabled him to found various houses of his order in France; in Spain and Germany, too, houses were founded during Francis's lifetime. He never left France, and died in 1507 in the monastery of his order at Plessis-Tours.

The Rule was so strict that the popes long hesitated to confirm it in its entirety; not until 1506 was it finally sanctioned. The most special feature is an additional vow to keep a perpetual Lent of the strictest kind, not only flesh meat but fish and all animal products—eggs, milk, butter, cheese, dripping—being forbidden, so that the diet was confined to bread, vegetables, fruit and oil, and water was the only drink. Thus in matter of diet the Minims surpassed in austerity all orders in the West, and probably all permanently organized orders in the East. The strongly ascetical spirit of the Minims manifested itself in the title borne by the superiors of the houses—not abbot (father), or prior, or guardian, or minister, or rector, but corrector; and the general superior is the corrector general. Notwithstanding its extreme severity the order prospered. At the death of the founder it had five provinces—Italy, France, Tours, Germany, Spain. Later there were as many as 450 monasteries, and some missions in India. There never was a Minim house in England or Ireland. It ranks as one of the Mendicant orders. In 1909 there were some twenty monasteries, mostly in Sicily, but one in Rome (S. Andrea delle Fratte), and one in Naples, in Marseilles and in Cracow. There have been Minim nuns (only one convent has survived, till recently at Marseilles) and Minim Tertiaries, in imitation of the Franciscan Tertiaries. The habit of the Minims is black.

See Helyot, *Hist. des ordres religieux* (1714), vii. c. 56; Max Heimbucher, *Orden und Kongregationen* (1896), i. § 52; the article "Franz von Paula" in Wetzer and Welte, *Kirchenlexicon* (ed. 2), and in Herzog, *Realencyklopädie* (ed. 3); *Catholic Dictionary*, art. "Minims." (E. C. B.)

FRANCIS (FRANÇOIS) OF SALES, ST (1567–1622), bishop of Geneva and doctor of the Church (1877), was born at the castle of Sales, near Annecy, Savoy. His father, also François, comte de Sales, but better known as M. de Boisy, a nobleman and soldier, had been employed in various affairs of state, but in 1560, at the age of thirty-eight, settled down on his ancestral estates and married Françoise de Sionnay, a Savoyard like himself, and an heiress. St Francis, the first child of this union, was born in August 1567 when his mother was in her fifteenth year. M. de Boisy was renowned for his experience and sound judgment, and both parents were distinguished by piety, love of peace, charity to the poor, qualities which early showed themselves in their eldest son.

He received his education first at La Roche, in the Arve valley, then at the college of Annecy, founded by Eustace Chappius, ambassador in England of Charles V., in 1549. At the age of thirteen or fourteen he went to the Jesuit College of Clermont at Paris, where he stayed till the summer of 1588, and where he

laid the foundations of his profound knowledge, while perfecting himself in the exercises of a young nobleman and practising a life of exemplary virtue. At this time also he developed an ardent love of France, a country which was politically in antagonism with his own, though so closely linked to it geographically, socially and by language. At the end of 1588 he went to Padua, to take his degree in canon and civil law, a necessary prelude in Savoy at that time to distinction in a civil career. His heart, however, especially from the date of his receiving the tonsure (1578), was already turned towards the Church, and he gave his attention even more to theology, under the great masters Antonio Possevino, S.J., and Gesualdo, afterwards general of the Friars Minor, than to his legal course. "At Padua," he said to a friend, "I studied law to please my father, and theology to please myself." In that licentious university Francis found the greatest difficulty in resisting attacks on his virtue, and once at least had to draw his sword to defend his personal safety against a band of ruffians. The gentleness for which he was already renowned was not that of a weak, but of a strong character. He returned to Savoy in 1592, and, while seeking the occasion to overcome his father's resistance to his resolution of embracing the ecclesiastical profession, took the diploma of advocate to the senate. Meantime, without his knowledge, his friends procured for him the post of provost of the chapter of Geneva, an honour which reconciled M. de Boisy to the sacrifice of more ambitious hopes. After a year of zealous work as preacher and director he was sent by the bishop, Claude de Granier, to try and win back the province of Chablais, which had embraced Calvinism when usurped by Bern in 1535, and had retained it even after its restitution to Savoy in 1564. At first the people refused to listen to him, for he was represented to them as an instrument of Satan, and all who had dealings with him were threatened with the vengeance of the consistory. He therefore wrote out his message on sheets which were passed from hand to hand, and these, with the spectacle of his virtues and disinterestedness, soon produced a strong effect. The sheets just spoken of still exist in the Chigi library at Rome, and were published, though with many alterations, in 1672, under the title of *Les Controverses*. This must be considered the first work of St Francis.

The re-erection of a wayside cross in Annemasse, at the gates of Geneva, amid an enormous concourse of converts, an event which closed the three years of his apostolate, led to the composition of the *Défense . . . de la Croix*, published in 1600. An illness brought on by toil and privation forced him to leave his work to others for nearly a year, but in August 1598 he returned to his field of labour, and in October of that year practically the whole country was Catholic again. Up to that time preaching and conference had been the only weapons employed. The stories of the use of soldiers to produce simulated conversions are incorrect.¹ Possibly the lamentable events of the campaigns of 1589 in Gex and Chablais have been applied to the

¹ This, at least, is the account given by Catholic authorities. Less favourable is the view taken by non-Catholic historians, which seems in some measure to be confirmed by St Francis himself. According to this, Duke Charles Emmanuel of Savoy, who succeeded his more tolerant father in 1580, was determined to reduce the Chablais to the Catholic religion, by peaceful means if possible, by force if necessary. After two years of preaching Francis wrote to the duke (*Œuvres compl.* ii. p. 551): "During 27 months I have scattered the seed of the Word of God in this miserable land; shall I say among thorns or on stony ground? Certainly, save for the conversion of the seigneur d'Avully and the advocate Poncet, I have little to boast of." In the winter of 1596–1597 Francis was at Turin, and at his suggestion the duke decided on a regular plan for the coercion of the refractory Protestants. This plan anticipated that employed later by Louis XIV. against the Huguenots in France. The Calvinist ministers were expelled; Protestant books were confiscated and destroyed; the acts of Protestant lawyers and officials were declared invalid. The country was flooded with Jesuits and friars, whose arguments were reinforced by quartering troops, veterans of the Indian wars in Mexico, on the refractory inhabitants. Those whose stubborn persistence in error survived all these inducements to repent were sent into exile. See the article "Franz von Sales" by J. Ehn in Herzog-Hauck, *Realencyklopädie* (3rd ed., Leipzig, 1899). (W. A. P.)

period 1594-1598. In October of this last year, however, the duke of Savoy, who came then to assist in person at the great religious feasts which celebrated the return of the country to unity of faith, expatriated such of the leading men as obstinately refused even to listen to the Catholic arguments. He also forbade Calvinist ministers to reside in the Chablais, and substituted Catholic for Huguenot officials. St Francis concurred in these measures, and, three years later, even requested that those who, as he said, "follow their heresy, rather as a party than a religion," should be ordered either to conform or to leave their country, with leave to sell their goods. His conduct, judged not by a modern standard, but by the ideas of his age, will be found compatible with the highest Christian charity, as that of the duke with sound political prudence. At this time he was nominated to the pope as coadjutor of Geneva,¹ and after a visit to Rome he assisted Bishop de Granier in the administration of the newly converted countries and of the diocese at large.

In 1602 he made his second visit to the French capital, when his transcendent qualities brought him into the closest relations with the court of Henry IV., and made him the spiritual father of that circle of select souls who centred round Madame Acarie. Among the celebrated personages who became his life friends from this time were Pierre de Bérulle, founder of the French Oratorians, Guillaume Duval, the scholar, and the duc de Bellegarde, the latter a special favourite of the king, who begged to be allowed to share the Saint's friendship. At this time also his gift as a preacher became fully recognized, and de Sanzéa, afterwards bishop of Bethlehem, records that Duval exhorted all his students of the Sorbonne to listen to him and to imitate this, "the true and excellent method of preaching." His principles are expressed in the admirable letter to André Frémyot of October 1604.

De Granier died in September 1602, and the new bishop entered on the administration of his vast diocese, which, as a contemporary says, "he found brick and left marble." His first efforts were directed to securing a virtuous and well-instructed clergy, with its consequence of a people worthy of their pastors. All his time was spent in preaching, confessing, visiting the sick, relieving the poor. His zeal was not confined to his diocese. In concert with Jeanne Françoise Frémyot (1572-1641), widow of the baron de Chantal, whose acquaintance he made while preaching through Lent at Dijon in 1604, he founded the order of the Visitation, in favour of "strong souls with weak bodies," as he said, deterred from entering the orders already existing, by their inability to undertake severe corporal austerities. The institution rapidly spread, counting twenty houses before his death and eighty before that of St Jeanne. The care of his diocese and of his new foundation were not enough for his ardent charity, and in 1609 he published his famous *Introduction to a Devout Life*, a work which was at once translated into the chief European languages and of which he himself published five editions. In 1616 appeared his *Treatise on the Love of God*, which teaches that perfection of the spiritual life to which the former work is meant to be the "Introduction."

The important Lents of 1617 and 1618 at Grenoble were a prelude to a still more important apostolate in Paris, "the theatre of the world," as St Vincent de Paul calls it. This third visit to the great city lasted from the autumn of 1618 to that of 1619; the direct object of it was to assist in negotiating the marriage of the prince of Piedmont with Chrétienne of France, but nearly all his time was spent in preaching and works of mercy, spiritual or corporal. He was regarded as a living saint. St Vincent scarcely left him, and has given the most extraordinary testimonies (as yet unpublished) of his heroic virtues. Mère Angélique Arnaud, who at this time put herself under his direction and wished to join the Order of the Visitation, attracted by its humility and sweetness, may be named as the most interesting of his innumerable penitents of this period. He returned to Savoy, and after three years more of unwearying labour died at Lyons on the 28th of December 1622. A universal outburst of veneration followed; indeed his cult had already begun, and after

¹ With the title of Nicopolis *in partibus*.—Ed.

an episcopal inquiry the pontifical commission in view of his beatification was instituted by decree of the 21st of July 1626, a celerity unique in the annals of the Congregation of Rites. The depositions of witnesses were returned to Rome in 1632, but meantime the forms of the Roman chancery had been changed by Urban VIII., and the advocates could not at once continue their work. Eventually a new commission was issued in 1656, and on its report, into which were inserted nineteen of the former depositions, the "servant of God" was beatified in 1661. The canonization took place in 1665.

Besides the works which we have named, there were published posthumously his *Entretiens*, i.e. a selection of the lectures given to the Visitation, reported by the sisters who heard them, some of his sermons, a large number of his letters, various short treatises of devotion. The first edition of his united or so-called "Complete" works was published at Toulouse in 1637. Others followed in 1641, 1647, 1652, 1663, 1669, 1685. The *Lettres* and *Opuscules* were re-published in 1768.

The only modern editions of the complete works which it is worth while to name are those of Blaise (1821), Virès (1856-1858), Migne (1861), and the critical edition published by the Visitation of Annecy, of which the 14th volume appeared in 1905.

The biography of St Francis de Sales was written immediately after his death by the celebrated P. de La Rivière and Dom John de St François (Goulu), as well as by two other authors of less importance. The saint's nephew and successor, Charles Auguste de Sales, brought out a more extended life, Latin and French, in 1635. The lives of Giarda (1650), Maupas du Tour (1657) and Cotelendi (1687) add little to Charles Auguste. Marsollier's longer life, in two volumes (1700), is quite untrustworthy; still more so that by Loyau d'Amboise (1833), which is rather a romance than a biography. The lives by Hamon (1856) and Pérennès (1860), without adding much to preceding biographies, are serious and edifying. A complete life, founded on the lately discovered process of 1626 and the new letters, was being prepared by the author of the present article at the time of his death. With the Lives must be mentioned the *Esprit du B. F. de Sales* by Camus, bishop of Belley, who, amid innumerable errors, gives various interesting traits and sayings of his saintly friend. Among the very numerous modern studies may be named an essay by Leigh Hunt entitled "The Gentleman Saint" (*The Seer*, pt. ii. No. 41); a remarkable *causerie* by Sainte-Beuve (*Lundis*, 3rd Jan. 1853); *Le Réveil du sentiment religieux en France au XVII^e siècle*, by Strowski (Paris, 1898); *Four Essays on S. F. de S. and Three Essays on S. F. de S. as Preacher*, by Canon H. B. Mackey. (H. B. M.)

FRANCIS, SIR PHILIP (1740-1818), English politician and pamphleteer, the supposed author of the *Letters of Junius*, and the chief antagonist of Warren Hastings, was born in Dublin on the 22nd of October 1740. He was the only son of Dr Philip Francis (c. 1708-1773), a man of some literary celebrity in his time, known by his translations of Horace, Aeschines and Demosthenes. He received the rudiments of an excellent education at a free school in Dublin, and afterwards spent a year or two (1751-1752) under his father's roof at Skeyton rectory, Norfolk, and elsewhere, and for a short time he had Gibbon as a fellow-pupil. In March 1753 he entered St Paul's school, London, where he remained for three years and a half, becoming a proficient classical scholar. In 1756, immediately on his leaving school, he was appointed to a junior clerkship in the secretary of state's office by Henry Fox (afterwards Lord Holland), with whose family Dr Francis was at that time on intimate terms; and this post he retained under the succeeding administration. In 1758 he was employed as secretary to General Bligh in the expedition against Cherbourg; and in the same capacity he accompanied the earl of Kinnoull on his special embassy to the court of Portugal in 1760.

In 1761 he became personally known to Pitt, who, recognizing his ability and discretion, once and again made use of his services as private amanuensis. In 1762 he was appointed to a principal clerkship in the war office, where he formed an intimate friendship with Christopher D'Oyly, the secretary of state's deputy, whose dismissal from office in 1772 was hotly resented by "Junius"; and in the same year he married Miss Macrabie, the daughter of a retired London merchant. His official duties brought him into direct relations with many who were well versed in the politics of the time. In 1763 the great constitutional questions arising out of the arrest of Wilkes began to be sharply canvassed. It was natural that Francis, who from a very early age had been in the habit of writing occasionally to the newspapers,

should be eager to take an active part in the discussion, though his position as a government official made it necessary that his intervention should be carefully disguised. He is known to have written to the *Public Ledger* and *Public Advertiser*, as an advocate of the popular cause, on many occasions about and after the year 1763; he frequently attended debates in both Houses of Parliament, especially when American questions were being discussed; and between 1769 and 1771 he is also known to have been favourable to the scheme for the overthrow of the Grafton government and afterwards of that of Lord North, and for persuading or forcing Lord Chatham into power. In January 1769 the first of the *Letters of Junius* appeared, and the series was continued till January 21, 1772. They had been preceded by others under various signatures such as "Candor," "Father of Candor," "Anti-Sejanus," "Lucius," "Nemesis," which have all been attributed, some of them certainly in error, to one and the same hand. The authorship of the *Letters of Junius* has been assigned to Francis on a variety of grounds (see JUNIUS).

In March 1772 Francis finally left the war office, and in July of the same year he left England for a tour through France, Germany and Italy, which lasted until the following December. On his return he was contemplating emigration to New England, when in June 1773 Lord North, on the recommendation of Lord Barrington, appointed him a member of the newly constituted supreme council of Bengal at a salary of £10,000 per annum. Along with his colleagues Monson and Clavering he reached Calcutta in October 1774, and a long struggle with Warren Hastings, the governor-general, immediately began. These three, actuated probably by petty personal motives, combined to form a majority of the council in harassing opposition to the governor-general's policy; and they even accused him of corruption, mainly on the evidence of Nuncomar. The death of Monson in 1776, and of Clavering in the following year, made Hastings again supreme in the council. But a dispute with Francis, more than usually embittered, led in August 1780 to a minute being delivered to the council board by Hastings, in which he stated that "he judged of the public conduct of Mr Francis by his experience of his private, which he had found to be void of truth and honour." A duel was the consequence, in which Francis received a dangerous wound (see HASTINGS, WARREN). Though his recovery was rapid and complete, he did not choose to prolong his stay abroad. He arrived in England in October 1781, and was received with little favour.

Little is known of the nature of his occupations during the next two years, except that he was untiring in his efforts to procure first the recall, and afterwards the impeachment of his hitherto triumphant adversary. In 1783 Fox produced his India Bill, which led to the overthrow of the coalition government. In 1784 Francis was returned by the borough of Yarmouth, Isle of Wight; and although he took an opportunity to disclaim every feeling of personal animosity towards Hastings, this did not prevent him, on the return of the latter in 1785, from doing all in his power to bring forward and support the charges which ultimately led to the impeachment resolutions of 1787. Although excluded by a majority of the House from the list of the managers of that impeachment, Francis was none the less its most energetic promoter, supplying his friends Burke and Sheridan with all the materials for their eloquent orations and burning invectives. At the general election of 1790 he was returned member for Bletchingley. He sympathized warmly and actively with the French revolutionary doctrines, expostulating with Burke on his vehement denunciation of the same. In 1793 he supported Grey's motion for a return to the old constitutional system of representation, and so earned the title to be regarded as one of the earliest promoters of the cause of parliamentary reform; and he was one of the founders of the "Society of the Friends of the People." The acquittal of Hastings in April 1795 disappointed Francis of the governor-generalship, and in 1798 he had to submit to the additional mortification of a defeat in the general election. He was once more successful, however, in 1802, when he sat for Appleby, and it seemed as if the great

ambitions of his life were about to be realized when the Whig party came into power in 1806. His disappointment was great when the governor-generalship was, owing to party exigencies, conferred on Sir Gilbert Elliot (Lord Minto); he declined, it is said, soon afterwards the government of the Cape, but accepted a K.C.B. Though re-elected for Appleby in 1806, he failed to secure a seat in the following year; and the remainder of his life was spent in comparative privacy.

Among the later productions of his pen were, besides the *Plan of a Reform in the Election of the House of Commons*, pamphlets entitled *Proceedings in the House of Commons on the Slave Trade* (1796), *Reflections on the Abundance of Paper in Circulation and the Scarcity of Specie* (1810), *Historical Questions Exhibited* (1818), and a *Letter to Earl Grey on the Policy of Great Britain and the Allies towards Norway* (1814). His first wife, by whom he had six children, died in 1806, and in 1814 he married his second wife, Emma Watkins, who long survived him, and who left voluminous manuscripts relating to his biography. Francis died on the 23rd of December 1818. In his domestic relations he was exemplary, and he lived on terms of mutual affection with a wide circle of friends. He was, however, full of vindictiveness, dissimulation and treachery, and there can be little doubt that in his historic conflict with Warren Hastings unworthy personal motives played a leading part.

BIBLIOGRAPHY.—For the evidence identifying Francis with Junius see the article JUNIUS, and the authorities there cited. See also *Memoirs of Sir Philip Francis, with Correspondence and Journals*, by Joseph Parkes and Herman Merivale (2 vols., London, 1867); *The Francis Letters*, edited by Beata Francis and Eliza Keary (2 vols., London, 1901); Sir J. F. Stephen, *The Story of Nuncomar and the Impeachment of Sir E. Impey* (2 vols., London, 1885); Lord Macaulay's *Essay on "Warren Hastings"*; G. B. Malleon, *Life of Warren Hastings* (London, 1894); G. W. Forrest, *The Administration of Warren Hastings, 1772-1785* (Calcutta, 1892); Sir Leslie Stephen's article on Francis in *Dict. of Nat. Biog.* vol. xx.

FRANCIS JOSEPH I. (1830—), emperor of Austria, king of Bohemia, and apostolic king of Hungary, was the eldest son of the archduke Francis Charles, second son of the reigning emperor Francis I., being born on the 18th of August 1830. His mother, the archduchess Sophia, was daughter of Maximilian I., king of Bavaria. She was a woman of great ability and strong character, and during the years which followed the death of the emperor Francis was probably the most influential personage at the Austrian court; for the emperor Ferdinand, who succeeded in 1835, was physically and mentally incapable of performing the duties of his office; as he was childless, Francis Joseph was in the direct line of succession. During the disturbances of 1848, Francis Joseph spent some time in Italy, where, under Radetzky, at the battle of St Lucia, he had his first experience of warfare. At the end of that year, after the rising of Vienna and capture of the city by Windischgrätz, it was clearly desirable that there should be a more vigorous ruler at the head of the empire, and Ferdinand, now that the young archduke was of age, was able to carry out the abdication which he and his wife had long desired. All the preparations were made with the utmost secrecy; on the 2nd of December 1848, in the archiepiscopal palace at Olmütz, whither the court had fled from Vienna, the emperor abdicated. His brother resigned his rights of succession to his son, and Francis Joseph was proclaimed emperor. Ferdinand retired to Prague, where he died in 1875.

The history of the Dual Monarchy during his reign is told under the heading of AUSTRIA-HUNGARY, and here it is only necessary to deal with its personal aspects. The young emperor was during the first years of his reign completely in the hands of Prince Felix Schwarzenberg, to whom, with Windischgrätz and Radetzky, he owed it that Austria had emerged from the revolution apparently stronger than it had been before. The first task was to reduce Hungary to obedience, for the Magyars refused to acknowledge the validity of the abdication in so far as it concerned Hungary, on the ground that such an act would only be valid with the consent of the Hungarian parliament. A further motive for their attitude was that Francis Joseph, unlike his predecessor, had not taken the oath to observe the Hungarian constitution, which it was the avowed object of Schwarzenberg

to overthrow. In the war which followed the emperor himself took part, but it was not brought to a successful conclusion till the help of the Russians had been called in. Hungary, deprived of her ancient constitution, became an integral part of the Austrian empire. The new reign began, therefore, under sinister omens, with the suppression of liberty in Italy, Hungary and Germany. In 1853 a Hungarian named Lehenyi attempted to assassinate the emperor, and succeeded in inflicting a serious wound with a knife. With the death of Schwarzenberg in 1852 the personal government of the emperor really began, and with it that long series of experiments of which Austria has been the subject. Generally it may be said that throughout his long reign Francis Joseph remained the real ruler of his dominions; he not only kept in his hands the appointment and dismissal of his ministers, but himself directed their policy, and owing to the great knowledge of affairs, the unremitting diligence and clearness of apprehension, to which all who transacted business with him have borne testimony, he was able to keep a very real control even of the details of government.

The recognition of the separate status of Hungary, and the restoration of the Magyar constitution in 1866, necessarily made some change in his position, and so far as concerns Hungary he fully accepted the doctrine that ministers are responsible to parliament. In the other half of the monarchy (the so-called Cisleithan) this was not possible, and the authority and influence of the emperor were even increased by the contrast with the weaknesses and failures of the parliamentary system. The most noticeable features in his reign were the repeated and sudden changes of policy, which, while they arose from the extreme difficulty of finding any system by which the Habsburg monarchy could be governed, were due also to the personal idiosyncrasies of the emperor. First we have the attempt at the autocratic centralization of the whole monarchy under Bach; the personal influence of the emperor is seen in the conclusion of the Concordat with Rome, by which in 1855 the work of Joseph II. was undone and the power of the papacy for a while restored. The foreign policy of this period brought about the complete isolation of Austria, and the "ingratitude" towards Russia, as shown during the period of the Crimean War, which has become proverbial, caused a permanent estrangement between the two great Eastern empires and the imperial families. The system led inevitably to bankruptcy and ruin; the war of 1859, by bringing it to an end, saved the monarchy. After the first defeat Francis Joseph hastened to Italy; he commanded in person at Solferino, and by a meeting with Napoleon arranged the terms of the peace of Villafranca. The next six years, both in home and foreign policy, were marked by great vacillation. In order to meet the universal discontent and the financial difficulties constitutional government was introduced; a parliament was established in which all races of the empire were represented, and in place of centralized despotism was established Liberal centralization under Schmerling and the German Liberals. But the Magyars refused to send representatives to the central parliament; the Slavs, resenting the Germanizing policy of the government, withdrew; and the emperor had really withdrawn his confidence from Schmerling long before the constitution was suspended in 1865 as a first step to a reconciliation with Hungary. In the complicated German affairs the emperor in vain sought for a minister on whose knowledge and advice he could depend. He was guided in turn by the inconsistent advice of Schmerling, Rechberg, Mensdorff, not to mention more obscure counsellors, and it is not surprising that Austria was repeatedly outmatched and outwitted by Prussia. In 1863, at the *Fürstentag* in Frankfort, the emperor made an attempt by his personal influence to solve the German question. He invited all the German sovereigns to meet him in conference, and laid before them a plan for the reconstruction of the confederation. The momentary effect was immense; for some of the halo of the Holy Empire still clung round the head of the house of Habsburg, and Francis Joseph was welcomed to the ancient free city with enthusiasm. In spite of this, however, and of the skill with which he presided over the debates, the

conference came to nothing owing to the refusal of the king of Prussia to attend.

The German question was settled definitively by the battle of Königgrätz in 1866; and the emperor Francis Joseph, with characteristic Habsburg opportunism, was quick to accommodate himself to the new circumstances. Above all, he recognized the necessity for reconciling the Magyars to the monarchy; for it was their discontent that had mainly contributed to the collapse of the Austrian power. He had already, in 1859, as the result of a visit to Budapest, made certain modifications in the Bach system by way of concession to Magyar sentiment, and in 1861 he had had an interview with Deák, during which, though unconvinced by that statesman's arguments, he had at least assured himself of his loyalty. He now made Beust, Bismarck's Saxon antagonist, the head of his government, as the result of whose negotiations with Deák the Austro-Hungarian Compromise of 1867 was agreed upon. A law was passed by the Hungarian diet regularizing the abdication of Ferdinand; at the beginning of June Francis Joseph signed the inaugural diploma and took the oath in Magyar to observe the constitution; on the 8th he was solemnly crowned king of Hungary. The traditional coronation gift of 100,000 florins he assigned to the widows and orphans of those who had fallen in the war against Austria in 1849.

Once having accepted the principle of constitutional government, the emperor-king adhered to it loyally, in spite of the discouragement caused by party struggles embittered by racial antagonisms. If in the Cisleithan half of the monarchy parliamentary government broke down, this was through no fault of the emperor, who worked hard to find a *modus vivendi* between the factions, and did not shrink from introducing manhood suffrage in the attempt to establish a stable parliamentary system. This expedient, indeed, probably also conveyed a veiled threat to the Magyar chauvinists, who, discontented with the restrictions placed upon Hungarian independence under the Compromise, were agitating for the complete separation of Austria and Hungary under a personal union only; for universal suffrage in Hungary would mean the subordination of the Magyar minority to the hitherto subject races. For nearly forty years after the acceptance of the Compromise the attitude of the emperor-king towards the Magyar constitution had been scrupulously correct. The agitation for the completely separate organization of the Hungarian army, and for the substitution of Magyar for German in words of command in Hungarian regiments, broke down the patience of the emperor, tenacious of his prerogative as supreme "war lord" of the common army. A Hungarian deputation which came to Vienna in September 1905 to urge the Magyar claims was received ungraciously by the emperor, who did not offer his hand to the members, addressed them in German, and referred them brusquely to the chancellor, Count Goluchowski. This incident caused a considerable sensation, and was the prelude to a long crisis in Hungarian affairs, during which the emperor-king, while quick to repair the unfortunate impression produced by his momentary pique, held inflexibly to his resolve in the matter of the common army.

In his relations with the Slavs the emperor displayed the same conciliatory disposition as in the case of the Magyars; but though he more than once held out hopes that he would be crowned at Prague as king of Bohemia, the project was always abandoned. In this, indeed, as in other cases, it may be said that the emperor was guided less by any abstract principles than by a common-sense appreciation of the needs and possibilities of the moment. Whatever his natural prejudices or natural resentments, he never allowed these to influence his policy. The German empire and the Italian kingdom had been built up out of the ruins of immemorial Habsburg ambitions; yet he refused to be drawn into an alliance with France in 1869 and 1870, and became the mainstay of the Triple Alliance of Austria-Hungary, Germany and Italy. His reputation as a consistent moderating influence in European policy and one of the chief guarantors of European peace was indeed rudely shaken in October 1908, the year in which he celebrated his

sixty years' jubilee as emperor, by the issue of the imperial rescript annexing Bosnia and Herzegovina to the Habsburg dominions, in violation of the terms of the treaty of Berlin. But his opportunism was again justified by the result. Europe lost an ideal; but Austria gained two provinces.

In his private life the emperor was the victim of terrible catastrophes—his wife, his brother and his only son having been destroyed by sudden and violent deaths. He married in 1854 Elizabeth, daughter of Maximilian Joseph, duke of Bavaria, who belonged to the younger and non-royal branch of the house of Wittelsbach. The empress, who shared the remarkable beauty common to all her family, took little part in the public life of Austria. After the first years of married life she was seldom seen in Vienna, and spent much of her time in travelling. She built a castle of great beauty and magnificence, called the Achilleion, in the island of Corfu, where she often resided. In 1867 she accompanied the emperor to Budapest, and took much interest in the reconciliation with the Magyars. She became a good Hungarian scholar, and spent much time in Hungary. An admirable horsewoman, in later years she repeatedly visited England and Ireland for the hunting season. In 1897 she was assassinated at Geneva by an Italian anarchist; previous attempts had been made on her and on her husband during a visit to Trieste.

There was one son of the marriage, the crown prince Rudolph (1857-1889). A man of much ability and promise, he was a good linguist, and showed great interest in natural history. He published two works, *Fifteen Days on the Danube* and *A Journey in the East*, and also promoted the publication of an important illustrated work giving a full description of the whole Austro-Hungarian monarchy; he personally shared the labours of the editorial work. In 1881 he married Stéphanie, daughter of the king of the Belgians. On 30th January 1889 he committed suicide at Mayerling, a country house near Vienna. He left one daughter, Elizabeth, who was betrothed to Count Alfred Windischgrätz in 1901. In 1900 his widow, the crown princess Stéphanie, married Count Lonyay; by this she sacrificed her rank and position within the Austrian monarchy. Besides the crown prince the empress gave birth to three daughters, of whom two survive: Gisela (born 1857), who married a son of the prince regent of Bavaria; and Marie Valerie (born 1868), who married the archduke Franz Salvator of Tuscany.

See J. Emmer, *Kaiser Franz Joseph* (2 vols., Vienna, 1898); J. Schnitzer, *Franz Joseph I. und seine Zeit* (2 vols., *ib.*, 1899); *Viribus unitis. Das Buch vom Kaiser*, with introduction by J. A. v. Halfert, ed. M. Herzig (*ib.*, 1898); R. Rostok, *Die Regierungszeit des K. u. K. Franz Joseph I.* (3rd ed. *ib.*, 1903).

END OF TENTH VOLUME

HILL
REFERENCE
LIBRARY
ST. PAUL

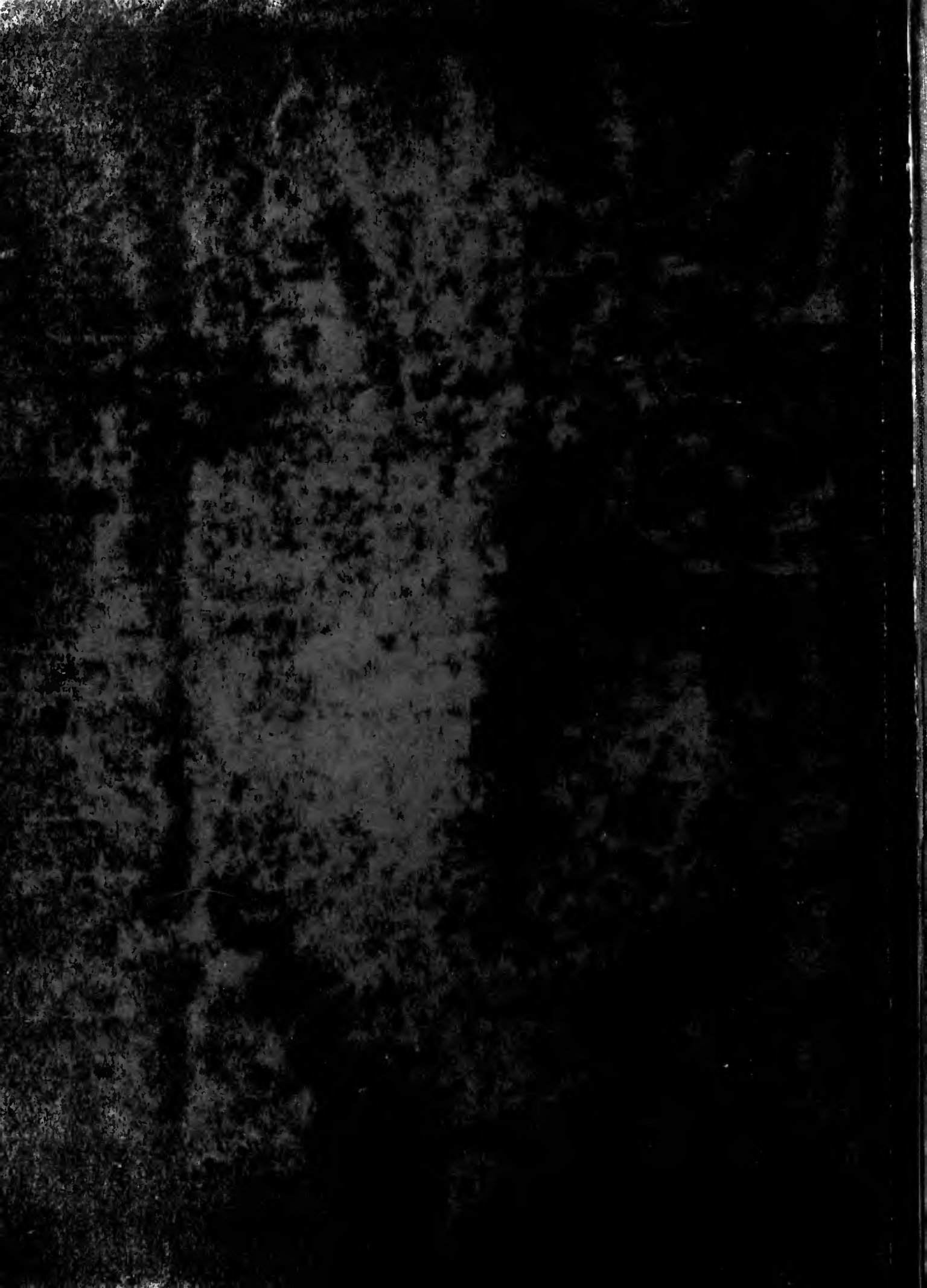

THE
ENCYCLOPEDIA
BRITANNICA

ELEVENTH
EDITION

VOL. X.
EVA. TO FRA